

# THE ENCYCLOPÆDIA BRITANNICA

## ELEVENTH EDITION

FIRST	edition, published in three	volumes,	1768—1771.
SECOND	„ „ ten	„	1777—1784.
THIRD	„ „ eighteen	„	1788—1797.
FOURTH	„ „ twenty	„	1801—1810.
FIFTH	„ „ twenty	„	1815—1817.
SIXTH	„ „ twenty	„	1823—1824.
SEVENTH	„ „ twenty-one	„	1830—1842.
EIGHTH	„ „ twenty-two	„	1853—1860.
NINTH	„ „ twenty-five	„	1875—1889.
TENTH	„ ninth edition and eleven supplementary volumes,		1902—1903.
ELEVENTH	„ published in twenty-nine volumes,		1910—1911.

THE HECK MEMORIAL LIBRARY

Department of Education

University of Virginia



*This volume is the gift of*

*Albert Henry Tuttle*

FROM THE PRIVATE LIBRARY OF

WILLIAM HARRY HECK

Curry Memorial Professor of Education

1905-1919

*Miller Professor of Biology and Agriculture  
(Retired)*





PRESE. RETURN TO STACKS



RETURN TO STACKS  
PRESERVATION CENTER

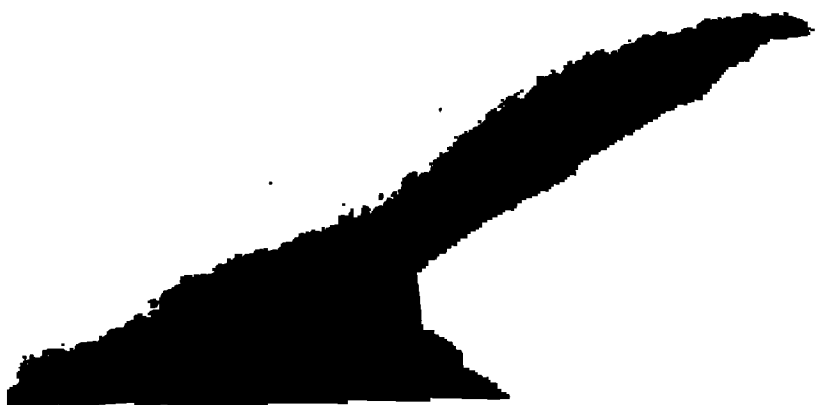





**COPYRIGHT**  
in all countries subscribing to the  
Bern Convention  
by  
**THE CHANCELLOR, MASTERS AND SCHOLARS**  
of the  
**UNIVERSITY OF CAMBRIDGE**

*All rights reserved*



THE  
ENCYCLOPÆDIA BRITANNICA

A  
DICTIONARY  
OF  
ARTS, SCIENCES, LITERATURE AND GENERAL  
INFORMATION

ELEVENTH EDITION

VOLUME VII  
CONSTANTINE PAVLOVICH to DEMIDOV

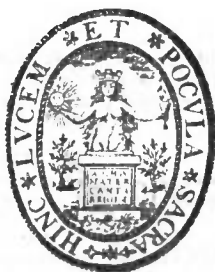

Cambridge, England:  
at the University Press  
New York, 35 West 32nd Street  
1910

AE  
5  
.E36  
1910b  
**099897**  
v.7  
Copy 2

Copyright, in the United States of America, 1910,  
by  
The Encyclopædia Britannica Company.

INITIALS USED IN VOLUME VII. TO IDENTIFY INDIVIDUAL  
CONTRIBUTORS,<sup>1</sup> WITH THE HEADINGS OF THE  
ARTICLES IN THIS VOLUME SO SIGNED.

A. B. F. Y.	ALEXANDER BELL FILSON YOUNG. Formerly Editor of the <i>Outlook</i> . Author of <i>Christopher Columbus</i> ; <i>Master-singers</i> ; <i>The Complete Motorist</i> ; <i>Wagner Stories</i> ; &c.	{ Dance ( <i>in part</i> ).
A. Bo.*	AUGUSTE BOUDINHON, D.D., D.C.L. Professor of Canon Law in the Catholic University of Paris. Honorary Canon of Paris. Editor of the <i>Canoniste contemporain</i> .	{ Curia Romana; Decretals.
A. Ca.	ARTHUR CAYLEY, LL.D., F.R.S. See the biographical article: CAYLEY, ARTHUR.	{ Curve ( <i>in part</i> ).
A. E. B.	REV. ANDREW EWBank BURN, M.A., D.D. Vicar of Halifax and Prebendary of Lichfield. Author of <i>An Introduction to the Creeds and the Te Deum</i> ; <i>Niceta of Remesiana</i> ; &c.	{ Creeds.
A. E. J.	ARTHUR ERNEST JOLLIFFE, M.A. Fellow of, and Tutor and Mathematical Lecturer at, Corpus Christi College, Oxford. Senior Mathematical Scholar, 1892.	{ Continued Fractions.
A. F. P.	ALBERT FREDERICK POLLARD, M.A., F.R.HIST.SOC. Fellow of All Souls' College, Oxford. Professor of English History in the University of London. Assistant Editor of the <i>Dictionary of National Biography</i> , 1893-1901. Author of <i>England under the Protector Somerset</i> ; <i>Life of Thomas Cranmer</i> ; &c.	{ Coverdale; Cox, Richard; Craig, John; Cranmer; Cromwell, Thomas; Crowley.
A. G.	MAJOR ARTHUR GEORGE FREDERICK GRIFFITHS (d. 1908). H.M. Inspector of Prisons, 1878-1896. Author of <i>The Chronicles of Newgate</i> ; <i>Secrets of the Prison House</i> ; &c.	{ Crime; Criminology.
A. Go.*	REV. ALEXANDER GORDON, M.A. Lecturer on Church History in the University of Manchester.	{ Coornhert.
A. H. J. G.	ABEL HENDY JONES GREENIDGE, M.A., D.LITT. (Oxon.) (d. 1905). Formerly Fellow and Lecturer of Hertford College, Oxford, and of St John's College, Oxford. Author of <i>Infamia in Roman Law</i> ; <i>Handbook of Greek Constitutional History</i> ; <i>Roman Public Life</i> ; <i>History of Rome</i> . Joint-author of <i>Sources of Roman History, 133-70 B.C.</i>	{ Consul: Roman.
A. H. P.	REV. ARNOLD HILL PAYNE, M.A. Chaplain, Oxford Diocesan Mission to the Deaf and Dumb. Late Normal Fellow, National Deaf Mute College, Washington, U.S.A. Author of <i>The Mental Develop- ment of the Orally and Manually taught Deaf</i> ; <i>The Pure Oral Method of necessity a Comparative Failure</i> ; &c.	{ Deaf and Dumb.
A. J. B.	ALFRED JOSHUA BUTLER, M.A., D.LITT. Fellow and Bursar of Brasenose College, Oxford. Fellow of Eton College. Author of <i>The Ancient Coptic Churches of Egypt</i> ; <i>The Arab Conquest of Egypt</i> ; &c.	{ Copts: <i>The Coptic Church</i> .
A. J. B.*	ARTHUR JOHN BUTLER, M.A. (1844-1910). Formerly Fellow of Trinity College, Cambridge, and Professor of Italian Language and Literature, University College, London. Author of a prose translation of Dante's <i>Divine Comedy</i> ; <i>Dante and his Times</i> ; &c.	{ Dante.
A. J. E.	ARTHUR JOHN EVANS, M.A., D.LITT., LL.D., F.R.S., F.S.A. Fellow of Brasenose College, Oxford. Keeper of Ashmolean Museum, Oxford, 1884- 1908. Hon. Keeper since 1908. Made archaeological discoveries in Crete, 1893; excavated the Palace of Knossos. Author of <i>Through Bosnia on Foot</i> ; <i>Cretan Pictographs and Præ-Phoenician Script</i> ; and other works on archaeology.	{ Crete: <i>Archæology and Ancient History</i> .
A. L.	ANDREW LANG. See the biographical article: LANG, ANDREW.	{ Crystal-Gazing.
A. Mw.	ALLEN MAWER, M.A. Professor of English Language and Literature, Armstrong College, Newcastle-on- Tyne. Fellow of Gonville and Caius College, Cambridge. Formerly Lecturer in English at the University of Sheffield.	{ Danelagh.

<sup>1</sup> A complete list, showing all individual contributors, appears in the final volume.

RETURN TO STACKS  
PRESERVATION

## INITIALS AND HEADINGS OF ARTICLES

vii

- D. H.** DAVID HANNAY.  
Formerly British Vice-Consul at Barcelona. Author of *Short History of Royal Navy, 1217-1688*; *Life of Emilio Castelar*; &c.
- D. Mn.** REV. DUGALD MACFADYEN, M.A.  
Minister of South Grove Congregational Church, Highgate. Director of the London Missionary Society.
- E. Br.** ERNEST BARKER, M.A.  
Fellow of, and Lecturer in Modern History at, St John's College, Oxford. Formerly Fellow and Tutor of Merton College. Craven Scholar, 1895.
- E. B. El.** EDWIN BAILEY ELLIOTT, M.A., F.R.S., F.R.A.S.  
Waynflete Professor of Pure Mathematics and Fellow of Magdalen College, Oxford. Formerly Fellow of Queen's College, Oxford. President of London Mathematical Society, 1896-1898. Author of *Algebra of Quantics*; &c.
- E. B. P.** EDWARD BAGNALL POULTON, M.A., D.Sc., F.R.S., LL.D.  
Hope Professor of Zoology in the University of Oxford. Fellow of Jesus College, Oxford. Author of *The Colours of Animals*; *Essays on Evolution*; *Darwin and the Original Species*; &c.
- E. C. Q.** EDMUND CROSBY QUIGGIN, M.A.  
Fellow of Gonville and Caius College, Cambridge; Lecturer in Modern Languages, and Monro Lecturer in Celtic.
- E. F. S.** EDWARD FAIRBROTHER STRANGE.  
Assistant Keeper, Victoria and Albert Museum, South Kensington. Member of Council, Japan Society. Author of numerous works on art subjects. Joint-editor of Bell's "Cathedral" Series.
- E. G.** EDMUND GOSSE, LL.D.  
See the biographical article: GOSSE, EDMUND.
- E. Gn.** ERNEST ARTHUR GARDNER, M.A.  
See the biographical article: GARDNER, PERCY.
- E. Ma.** EDWARD MANSON.  
Barrister-at-Law. Joint-editor of *Journal of Comparative Legislation*. Author of *Debentures and Debenture Stock*; &c.
- Ed. M.** EDUARD MEYER, D.LITT. (Oxon.), LL.D., PH.D.  
Professor of Ancient History in the University of Berlin. Author of *Geschichte des Alterthums*; *Forschungen zur alten Geschichte*; *Geschichte des alten Aegyptens*; *Die Israeliten und ihre Nachbarstämme*; &c.
- E. M. W.** REV. EDWARD MEWBURN WALKER, M.A.  
Fellow, Senior Tutor and Librarian of Queen's College, Oxford.
- E. Pr.** EDGAR PRESTAGE.  
Special Lecturer in Portuguese Literature in the University of Manchester. Comendador, Portuguese Order of S. Thiago. Corresponding Member of Lisbon Royal Academy of Sciences and Lisbon Geographical Society, &c.
- E. R. B.** EDWYN ROBERT BEVAN, M.A.  
Formerly Scholar of New College, Oxford. Author of *House of Seleucus*; *Jerusalem under the High Priests*.
- E. Tn.** REV. ETHELRED LEONARD TAUNTON (d.1907).  
Author of *The English Black Monks of St Benedict*; *History of the Jesuits in England*.
- E. V.** REV. EDMUND VENABLES, M.A., D.D. (1819-1805).  
Canon and Precentor of Lincoln. Author of *Episcopal Palaces of England*.
- F. E. W.** REV. FREDERICK EDWARD WARREN, M.A., B.D., F.S.A.  
Rector of Bardwell, Bury St Edmunds. Fellow of St John's College, Oxford, 1865-1882. Author of *The Old Catholic Ritual done into English and compared with the Corresponding Offices in the Roman and Old German Manuals*; *The Liturgy and Ritual of the Celtic Church*; &c.
- F. G. M. B.** FREDERICK GEORGE MEESON BECK, M.A.  
Fellow and Lecturer in Classics, Clare College, Cambridge.
- F. Lu.** FRIEDRICH LUCKWALDT, PH.D.  
Professor of History at the Royal Technical High School, Danzig. Author of *Oesterreich und die Anfänge des Befreiungskriege von 1813*; &c.
- F. Ll. G.** FRANCIS LLEWELLYN GRIFFITH, M.A., PH.D., F.S.A.  
Reader in Egyptology, Oxford University. Formerly Scholar of Queen's College, Oxford. Editor of the *Archaeological Survey and Archaeological Reports of the Egypt Exploration Fund*. Fellow of Imperial German Archaeological Institute.
- F. Po.** SIR FREDERICK POLLOCK, BART., LL.D., D.C.L.  
See the biographical article: POLLOCK: Family.
- F. S. P.** FRANCIS SAMUEL PHILBRICK, A.M., B.Sc.  
Formerly Scholar and Resident Fellow of Harvard University. Member of American Historical Association.
- Convoy (*in part*);  
Copenhagen, Battle of;  
Cordoba, Gonzalo Fernandez de;  
Dahlgren, John Adolf.
- Cruden, Alexander.
- Crusades.
- Curve (*in part*).
- Darwin.
- Cuchullinn.
- Della Quercia.
- Conte; Couplet; Cowley;  
Crashaw; Criticism;  
Daniel, Samuel;  
Davenant, Sir William;  
Dekker, Edward Douwes.
- Corfu (*in part*);  
Corinth: *Isthmus of*;  
Cos (*in part*); Crisa; Daphne;  
Delos; Delphi.
- Debentures and Debenture Stock.
- Ctesiphon; Cyaxares;  
Cyrus; Darius; Deloces;  
Demetrius of Bactria.
- Constitution of Athens.
- Corte-Real, Jeronymo;  
Cruz e Silva.
- Demetrius of Macedonia.
- Cullen, Paul; Curel.
- Crypt.
- Dedication.
- Deira.
- Dahlmann.
- Copts (*in part*).
- Contract.
- Cuba.



## INITIALS AND HEADINGS OF ARTICLES

ix

- L. A.** ISRAEL ABRAHAMS, M.A.  
Reader in Talmudic and Rabbinic Literature, University of Cambridge. President, Jewish Historical Society of England. Author of *A Short History of Jewish Literature*; *Jewish Life in the Middle Ages*. { **Crescas;**  
**Delmedigo.**
- J. An.** JOSEPH ANDERSON, LL.D.  
Keeper of the National Museum of Antiquities, Edinburgh. Assistant Secretary to the Society of Antiquaries of Scotland, and Rhind Lecturer, 1879-1882 and 1892. Editor of Drummond's *Ancient Scottish Weapons*; &c. { **Crannog.**
- J. A. C.** SIR JOSEPH ARCHER CROWE, K.C.M.G.  
See the biographical article: CROWE, SIR J. A. { **Cranaeh;**  
**Cuyp.**
- J. A. H.** JOHN ALLEN HOWE, B.Sc.  
Curator and Librarian of the Museum of Practical Geology, London. { **Corallian;**  
**Cornbrash; Culm.**
- J. C. S.-H.** JOHN CASTLEMAN SWINBURNE-HANHAM, J.P.  
Barrister-at-Law, Middle Temple. Hon. Secretary of Cremation Society of England. { **Cremation: Statistics.**
- J. D. B.** JAMES DAVID BOURCHIER, M.A., F.R.G.S.  
King's College, Cambridge. Correspondent of *The Times* in South-Eastern Europe. Commander of the Orders of Prince Danilo of Montenegro and of the Saviour of Greece, and Officer of the Order of St Alexander of Bulgaria. { **Crete: Geography and Statistics;**  
**and Modern History.**
- J. D. Pr.** JOHN DYNELEY PRINCE, PH.D.  
Professor of Semitic Languages at Columbia University, New York. { **Daniel (in part).**
- J. E. B.** JOHN EGLINTON BAILEY.  
Author of *John Dee and the Steganographia of Trithemius*; *Life of Thomas Fuller*. { **Cryptography.**
- J. Go.\*** JOSEPH GREGO.  
Art Critic. Author of *A History of Parliamentary Elections*; *A History of Dancing*; *Thomas Rowlandson*; *James Gillray*; &c. { **Cruikshank.**
- J. G. K.** JOHN GRAHAM KERR, M.A., F.R.S.  
Regius Professor of Zoology in the University of Glasgow. Formerly Demonstrator in Animal Morphology in the University of Cambridge. Fellow of Christ's College, Cambridge, 1898-1904. Walsingham Medallist, 1898. Neill Prizeman, Royal Society of Edinburgh, 1904. { **Cyclostomata.**
- J. H. F.** JOHN HENRY FREESE, M.A.  
Formerly Fellow of St John's College, Cambridge. { **Demeter.**
- J. H. M.** JOHN HENRY MIDDLETON, M.A., F.S.A., LITT.D., D.C.L. (1846-1896).  
Formerly Slade Professor of Fine Art in the University of Cambridge, and Art Director of the South Kensington Museum. Author of *The Engraved Gems of Classical Times*; *Illuminated Manuscripts in Classical and Medieval Times*. { **Della Robbia (in part).**
- J. H. R.** JOHN HORACE ROUND, M.A., LL.D. (Edin.).  
Author of *Feudal England*; *Studies in Peerage and Family History*; *Peerage and Pedigree*; &c. { **Court Baron.**
- J. Hl. R.** JOHN HOLLAND ROSE, M.A., LITT.D.  
Lecturer on Modern History to the Cambridge University Local Lectures Syndicate. Author of *Life of Napoleon I.*; *Napoleonic Studies*; *The Development of the European Nations*; *The Life of Pitt*; &c. { **Daru, Count;**  
**Decaen.**
- J. H. Rs.** REV. JAMES HARDY ROPES, D.D.  
Bussey Professor of New Testament Criticism and Interpretation, and Dexter Lecturer on Bible Literature, Harvard University. Author of *The Apostolic Age in the Light of Modern Criticism*; &c. { **Corinthians: Epistles to the.**
- J. L. M.** JOHN LINTON MYRES, M.A., F.S.A.  
Wykeham Professor of Ancient History in the University of Oxford. Formerly Gladstone Professor of Greek, and Lecturer in Ancient Geography, University of Liverpool; and Lecturer on Classical Archaeology in University of Oxford. { **Cyprus (in part).**
- J. Mo.** VISCOUNT MORLEY OF BLACKBURN.  
See the biographical article: MORLEY, VISCOUNT. { **Danton.**
- J. McF.** JOHN MACFARLANE.  
Formerly Librarian of the Imperial Library, Calcutta. Author of *Library Administration*; &c. { **Damien, Father.**
- J. M. M.** JOHN MALCOLM MITCHELL.  
Sometime Scholar of Queen's College, Oxford. Lecturer in Classics, East London College (University of London). Joint-editor of Grote's *History of Greece*. { **Dellian League.**
- J. P. Pe.** REV. JOHN PUNNETT PETERS, PH.D., D.D.  
Canon Residentiary, Cathedral of New York. Formerly Professor of Hebrew in the University of Pennsylvania. Director of the University Expedition to Babylonia, 1888-1895. Author of *Nippur, or Explorations and Adventures on the Euphrates*. { **Deir.**
- J. S. F.** JOHN SMITH FLETT, D.Sc., F.G.S.  
Petrographer to the Geological Survey. Formerly Lecturer on Petrology in Edinburgh University. Neill Medallist of the Royal Society of Edinburgh. Bigsby Medallist of the Geological Society of London. { **Crystallite;**  
**Dacite.**
- J. T. Be.** JOHN T. BEALBY.  
Joint-author of Stanford's *Europe*. Formerly Editor of the *Scottish Geographical Magazine*. Translator of Sven Hedin's *Through Asia, Central Asia and Tibet*; &c. { **Crimea (in part);**  
**Daghestan (in part).**
- J. T. G.** JOSEPH THOMAS CUNNINGHAM, M.A., F.Z.S.  
Lecturer on Zoology at the South-Western Polytechnic, London. Formerly Fellow of University College, Oxford. Assistant Professor of Natural History in the University of Edinburgh. Naturalist to the Marine Biological Association. { **Cuttle-fish.**

## INITIALS AND HEADINGS OF ARTICLES

<b>J. V.</b>	JOHN VEITCH, LL.D. See the biographical article: VEITCH, JOHN.	{ Cousin, V. ( <i>in part</i> ).
<b>K. G. J.</b>	KINGSLEY GARLAND JAYNE. Sometime Scholar of Wadham College, Oxford. Matthew Arnold Prizeman, 1903. Author of <i>Vasco da Gama and his Successors</i> .	{ Croatia-Slavonia; Dalmatia.
<b>K. S.</b>	KATHLEEN SCHLESINGER. Author of <i>The Instruments of the Orchestra</i> ; &c.	{ Contrafagotto; Cor Anglais; Cornet ( <i>in part</i> ); Cromorne ( <i>in part</i> ); Crowd; Cymbals.
<b>L.</b>	COUNT LÜTZOW, LITT.D. (Oxon.), D.PH. (Prague), F.R.G.S. Chamberlain of H.M. the Emperor of Austria, King of Bohemia. Hon. Member of the Royal Society of Literature. Member of the Bohemian Academy, &c. Author of <i>Bohemia, a Historical Sketch</i> ; <i>The Historians of Bohemia</i> (Ilchester Lecture, Oxford, 1904); <i>The Life and Times of John Hus</i> ; &c.	{ Czech.
<b>L. D.*</b>	LOUIS DUCHESNE. See the biographical article: DUCHESNE, L.M.O.	{ Damasus.
<b>L. J. S.</b>	LEONARD JAMES SPENCER, M.A. Assistant in Department of Mineralogy, British Museum. Formerly Scholar of Sidney Sussex College, Cambridge, and Harkness Scholar. Editor of the <i>Mineralogical Magazine</i> .	{ Copper-glance; Copper Pyrites; Covellite; Crocoite; Crystallography; Cuprite; Cyanite; Datolite.
<b>L. V.*</b>	LUIGI VILLARI. Italian Foreign Office (Emigration Department). Formerly Newspaper Correspondent in East of Europe. Italian Vice-Consul in New Orleans, 1906; Philadelphia, 1907; and Boston, U.S.A., 1907-1910. Author of <i>Italian Life in Town and Country</i> ; <i>Fire and Sword in the Caucasus</i> ; &c.	{ Contarini; Cornaro; Correnti; Corsini; Dandolo; Della Gherardesca.
<b>M. A. C.</b>	MAURICE A. CANNEY, M.A. Assistant Lecturer in Semitic Languages in the University of Manchester. Formerly Exhibitioner of St John's College, Oxford. Pusey and Ellerton Hebrew Scholar, Oxford, 1892; Kennicott Hebrew Scholar, 1895; Houghton Syriac Prize, 1896.	{ Daub, Karl.
<b>M. Ha.</b>	MARCUS HARTOG, M.A., D.Sc., F.L.S. Professor of Zoology, University College, Cork. Author of "Protozoa" in <i>Cambridge Natural History</i> , and papers for various scientific journals.	{ Cystoflagellata.
<b>M. N. T.</b>	MARCUS NIEBUHR TOD, M.A. Fellow and Tutor of Oriel College, Oxford. University Lecturer in Epigraphy. Joint-author of <i>Catalogue of the Sparta Museum</i> .	{ Demaratus.
<b>M. O. B. C.</b>	MAXIMILIAN OTTO BISMARCK CASPARI, M.A. Reader in Ancient History at London University. Lecturer in Greek at Birmingham University, 1905-1908.	{ Corfu ( <i>in part</i> ); Corinth ( <i>in part</i> ); Cos ( <i>in part</i> ).
<b>N. D. M.</b>	NEWTON DENNISON MERENESS, A.M., Ph.D. Author of <i>Maryland as a Proprietary Province</i> .	{ Davis, Jefferson ( <i>in part</i> ).
<b>N. W. T.</b>	NORTHCOTE WHITBRIDGE THOMAS, M.A. Government Anthropologist to Southern Nigeria. Corresponding Member of the Société d'Anthropologie de Paris. Author of <i>Thought Transference</i> ; <i>Kinship and Marriage in Australia</i> ; &c.	{ Death-warning.
<b>O. Ba.</b>	OSWALD BARRON, F.S.A. Editor of the <i>Ancestor</i> , 1902-1905. Hon. Genealogist to Standing Council of the Honourable Society of the Baronetage.	{ Costume: <i>Medieval and Modern European</i> ; Courtenay: <i>Family</i> .
<b>O. J. R. H.</b>	OSBERT JOHN RADCLIFFE HOWARTH, M.A. Christ Church, Oxford. Geographical Scholar, 1901. Assistant Secretary of the British Association.	{ Copenhagen.
<b>P. A. K.</b>	PRINCE PETER ALEXEIVITCH KROPOTKIN. See the biographical article: KROPOTKIN, P. A.	{ Cossacks; Crimea ( <i>in part</i> ); Daghestan ( <i>in part</i> ).
<b>P. C. Y.</b>	PHILIP CHESNEY YORKE, M.A. Magdalen College, Oxford.	{ Cottington, F. C.. Baron; Coventry, Sir William; Craven, Earl of; Cromwell, Oliver ( <i>in part</i> ); Cromwell, Richard.
<b>P. G.</b>	PERCY GARDNER, LITT.D., D.C.L., F.S.A. See the biographical article: GARDNER, PERCY.	{ Daedalus; Demetrius (Sculptor).
<b>P. GL.</b>	PETER GILES, M.A., LL.D., LITT.D. Fellow and Classical Lecturer of Emmanuel College, Cambridge, and University Reader in Comparative Philology. Late Secretary of the Cambridge Philological Society. Author of <i>Manual of Comparative Philology</i> ; &c.	{ D.
<b>P. G. K.</b>	PAUL G. KONODY. Art Critic of the <i>Observer</i> and the <i>Daily Mail</i> . Formerly Editor of <i>The Artist</i> . Author of <i>The Art of Walter Crane</i> ; <i>Velasquez, Life and Work</i> ; &c.	{ David, Gerard.
<b>R. A.*</b>	ROBERT ANCHEL. Archivist to the Département de l'Eure.	{ Convention, The National; Cordeliers, Club of the.



# INITIALS AND HEADINGS OF ARTICLES

xi

R. A. S. M.	ROBERT ALEXANDER STEWART MACALISTER, M.A., F.S.A. St John's College, Cambridge. Director of Excavations for the Palestine Exploration Fund.	Damascus; Dead Sea; Decapolis.
R. B. McK.	RONALD BRUNLEES MCKERROW. Trinity College, Cambridge.	Dekker, Thomas ( <i>in part</i> ).
R. B. R.	RUFUS BYAM RICHARDSON, PH.D., B.D. Formerly Director of American School of Classical Studies, Athens. Member of American Geological Society, British Society of Promotion of Hellenic Studies, Greek Archaeological Society, &c. Author of <i>History of Greek Sculpture</i> ; <i>Vacation Days in Greece</i> ; <i>Greece through the Stereoscope</i> ; &c.	Corinth ( <i>in part</i> ).
R. H. C.	REV. ROBERT HENRY CHARLES, M.A., D.D., D.LITT. Grinfield Lecturer and Lecturer in Biblical Studies, Oxford. Fellow of the British Academy. Formerly Professor of Biblical Greek, Trinity College, Dublin. Author of <i>Critical History of the Doctrine of a Future Life</i> ; <i>Book of Jubilees</i> ; &c.	Daniel ( <i>in part</i> ).
R. H. L.	ROBIN HUMPHREY LEGGE. Principal Musical Critic for <i>Daily Telegraph</i> . Author of <i>Annals of the Norwich Festivals</i> ; &c.	Debussy.
R. J. M.	RONALD JOHN MCNEILL, M.A. Christ Church, Oxford. Barrister-at-Law. Formerly Editor of the <i>St James's Gazette</i> , London.	Conway, Henry Seymour; Cowper, William C., 1st Earl; Cromwell, Oliver ( <i>in part</i> ).
R. L.*	RICHARD LYDEKKER, F.R.S., F.G.S., F.Z.S. Member of the Staff of the Geological Survey of India, 1874-1882. Author of <i>Catalogues of Fossil Mammals, Reptiles and Birds in British Museum</i> ; <i>The Deer of all Lands</i> , &c.	Coyote; Creodonta; Deer.
R. N. B.	ROBERT NISBET BAIN (d. 1909). Formerly Assistant Librarian, British Museum. Author of <i>Scandinavia: the Political History of Denmark, Norway and Sweden, 1513-1900</i> ; <i>The First Romanovs, 1613 to 1725</i> ; <i>Slavonic Europe: the Political History of Poland and Russia from 1469 to 1796</i> ; &c.	Corvinus; Czartoryski; Damjanich; Deak; De Geer; De la Gardie; Demetrius Donskol; Demetrius, Pseudo.
R. P. S.	R. PHENÉ SPIERS, F.S.A., F.R.I.B.A. Formerly Master of the Architectural School, Royal Academy, London. Past President of Architectural Association. Associate and Fellow of King's College, London. Corresponding Member of the Institute of France. Editor of Fergusson's <i>History of Architecture</i> . Author of <i>Architecture: East and West</i> ; &c.	Decorated Period.
R. So.	ROBERT SOMERS (1822-1891). Editor of <i>North British Daily Mail</i> , 1849-1859. Author of <i>Letters from the Highlands</i> ; <i>The Southern States since the War</i> .	Corn Laws ( <i>in part</i> ).
R. S. C.	ROBERT SEYMOUR CONWAY, M.A., D.LITT. (Cantab.). Professor of Latin in the University of Manchester. Formerly Professor of Latin of University College, Cardiff, and Fellow of Gonville and Caius College, Cambridge.	Cumae ( <i>in part</i> ).
R. W. R.	ROBERT WILLIAM ROGERS, D.D., LITT.D., LL.D., PH.D. Professor of Hebrew and Old Testament Exegesis, Drew Theological Seminary, Madison, New Jersey. Author of <i>Inscriptions of Sennacherib</i> ; <i>History of Babylonia and Assyria</i> ; &c.	Cuneiform.
S. A. C.	STANLEY ARTHUR COOK, M.A. Editor for Palestine Exploration Fund. Lecturer in Hebrew and Syriac, and formerly Fellow Gonville and Caius College, Cambridge. Examiner in Hebrew and Aramaic, London University, 1904-1908. Author of <i>Glossary of Aramaic Inscriptions</i> ; <i>The Laws of Moses and the Code of Hammurabi</i> ; <i>Critical Notes on Old Testament History</i> ; <i>Religion of Ancient Palestine</i> ; &c.	Costume: Ancient, Oriental; Cush; Dan; David ( <i>in part</i> ); Deborah; Decalogue ( <i>in part</i> ).
S. E. B.	HON. SIMEON EBEN BALDWIN, M.A., LL.D. Professor of Constitutional and Private International Law in Yale University. Director of the Bureau of Comparative Law of the American Bar Association. Formerly Chief Justice of Connecticut. Author of <i>Modern Political Institutions</i> ; <i>American Railroad Law</i> ; &c.	Conveyancing ( <i>United States</i> ).
S. J. C.	SYDNEY JOHN CHAPMAN, M.A. Professor of Political Economy and Dean of the Faculty of Commerce in the University of Manchester. Author of <i>The Lancashire Cotton Industry</i> ; <i>The Cotton Industry and Trade</i> ; &c.	Cotton: Marketing and Supply. Cotton Manufacture.
S. Wa.	SAMUEL WADSWORTH, M.A. Barrister-at-Law of the Inner Temple and of Lincoln's Inn. Joint-editor of the 17th edition of Davidson's <i>Concise Precedents in Conveyancing</i> .	Conveyancing ( <i>in part</i> ).
T. As.	THOMAS ASHBY, M.A., D.LITT. (Oxon.). Director of British School of Archaeology at Rome. Formerly Scholar of Christ Church, Oxford. Craven Fellow, 1897. Conington Prizeman, 1906. Member of the Imperial German Archaeological Institute.	Corfinium; Cori; Cortona; Cosa; Coseuza; Cremona; Crotona; Cumae ( <i>in part</i> ); Cures.
T. A. I.	THOMAS ALLAN INGRAM, M.A., LL.D. Trinity College, Dublin.	Convocation ( <i>in part</i> ); Corn Laws ( <i>in part</i> ); Coroner; Cruelty; Day.
T. A. J.	THOMAS ATHOL JOYCE, M.A. Assistant in Department of Ethnography, British Museum. Hon. Sec., Royal Anthropological Institute.	Costume ( <i>in part</i> ).
T. Ba.	SIR THOMAS BARCLAY, M.P. Member of the Institute of International Law. Member of the Supreme Council of the Congo Free State. Officer of the Legion of Honour. Author of <i>Problems of International Practice and Diplomacy</i> ; &c. M.P. for Blackburn, 1910.	Contraband; Convoy ( <i>in part</i> ); Declaration of Paris.

## INITIALS AND HEADINGS OF ARTICLES

- T. F. C.** THEODORE FREYLINGHUYSEN COLLIER, PH.D.  
Assistant Professor of History, Williams College, Williamstown, Mass., U.S.A. { Constantinople, Councils of.
- T. K. C.** THOMAS KELLY CHEYNE, D.D.  
See the biographical article: CHEYNE, T. K. { Cosmogony;  
Deluge, The.
- T. M. F.** THOMAS MACALL FALLOW, M.A., F.S.A.  
Editor of the *Antiquary*, 1895-1899. Author of *Memorials of Old Yorkshire*; *The Cathedral Churches of Ireland*. { Coronation;  
Cross and Crucifixion;  
Crown and Coronet.
- T. Se.** THOMAS SECCOMBE.  
Lecturer in History, East London and Birkbeck Colleges, University of London. Stanhope Prizeman, Oxford, 1887. Assistant Editor of *Dictionary of National Biography*, 1891-1901. Author of *The Age of Johnson*; &c. { Constantine Pavlovich.
- T. T.** SIR TRAVERS TWISS, K.C., D.C.L., F.R.S.  
See the biographical article: TWISS, SIR TRAVERS. { Consulate of the Sea;  
Convocation (*in part*).
- T. W. F.** THOMAS WILLIAM FOX, M.Sc.TECH.  
Professor of Textiles, Manchester University. Author of *Mechanism of Weaving*. { Cotton-spinning Machinery.
- V. M.** VICTOR CHARLES MAHILLON.  
Principal of the Conservatoire Royal de Musique at Brussels. Chevalier of the Legion of Honour. { Cornet (*in part*);  
Cromorne (*in part*).
- W. A. B. C.** REV. WILLIAM AUGUSTUS BREVOORT COOLIDGE, M.A., F.R.G.S., PH.D. (Bern.).  
Fellow of Magdalen College, Oxford. Professor of English History, St David's College, Lampeter, 1880-1881. Author of *Guide du Haut Dauphiné*; *The Range of the Tôdi*; *Guide to Grindelwald*; *Guide to Switzerland*; *The Alps in Nature and in History*; &c. Editor of the *Alpine Journal*, 1880-1889; &c. { Crousaz, Jean Pierre de;  
Dauphiné;  
Davos.
- W. A. P.** WALTER ALISON PHILLIPS, M.A.  
Formerly Exhibitioner of Merton College and Senior Scholar of St John's College, Oxford. Author of *Modern Europe*; &c. { Cope; Crete (*in part*);  
Costume: National, Class and Official;  
Dalmatic.
- W. B.\*** WILLIAM BURTON, M.A., F.C.S.  
Chairman, Joint Committee of Pottery Manufacturers of Great Britain. Author of *English Stoneware and Earthenware*; &c. { Della Robbia (*in part*).
- W. B. Sc.** WILLIAM BELL SCOTT.  
See the biographical article: SCOTT, WILLIAM BELL. { Cox, David;  
Delaroche.
- W. C. S.** WILLIAM CHARLES SMITH, K.C., M.A., LL.D., F.R.S. (Edin.).  
Formerly Sheriff of Ross, Cromarty and Sutherland. Editor of *Judicial Review*, 1889-1900. { Dance (*in part*).
- W. C. T.** W. CAVE THOMAS.  
Author of *Symmetrical Education*; *Mural or Monumental Decoration*; *Revised Theory of Light*. { Cornelius, Peter von.
- W. E. Co.** RT. REV. WILLIAM EDWARD COLLINS, D.D.  
Bishop of Gibraltar. Formerly Professor of Ecclesiastical History, King's College, London. Lecturer at Selwyn and St John's Colleges, Cambridge. Author of *The Study of Ecclesiastical History*; *Beginnings of English Christianity*; &c. { Cyprus: Church of.
- W. E. H.** WILLIAM ERNEST HENLEY.  
See the biographical article: HENLEY, W. E. { Cooper, James Fenimore.
- W. Fr.** WILLIAM FREAM, LL.D. (d. 1907).  
Formerly Lecturer on Agricultural Entomology, University of Edinburgh, and Agricultural Correspondent of *The Times*. { Dairy and Dairy-farming.
- W. F. C.** WILLIAM FEILDEN CRAIES, M.A.  
Barrister-at-Law, Inner Temple. Lecturer on Criminal Law, King's College, London. Editor of Archbold's *Criminal Pleading* (23rd edition). { Contempt of Court;  
Conversion;  
Costs; Criminal Law;  
Damages.
- W. G. F.** WILLIAM GEORGE FREEMAN, B.Sc. (London), A.R.C.S.  
Joint-author of *Nature Teaching*; *The World's Commercial Products*. Joint-editor of *Science Progress in the Twentieth Century*. { Cotton (*in part*).
- W. L. H. D.** WYNFRID LAWRENCE HENRY DUCKWORTH, M.A., M.D., D.Sc.  
Lecturer in Physical Anthropology, and Senior Demonstrator of Human Anatomy in the University of Cambridge. Fellow of Jesus College. Author of *Morphology and Anthropology*; &c. { Craniometry.
- W. L.-W.** SIR WILLIAM LEE-WARNER, M.A., K.C.S.I.  
Member of Council of India. Formerly Secretary in the Political and Secret Department of the India Office. Author of *Life of the Marquis of Dalhousie*; *Memoirs of Field-Marshal Sir Henry Wylie Norman*; &c. { Dalhousie, 1st Marquis.
- W. M.** WILLIAM MINTO, M.A.  
See the biographical article: MINTO, WILLIAM. { Dekker, Thomas (*in part*).
- W. M. R.** WILLIAM MICHAEL ROSSETTI.  
See the biographical article: ROSSETTI, DANTE G. { Correggio;  
Crivelli, Carlo.
- W. P.\*** WALTER PITT, M.INST.C.E., M.I.M.E.  
Member of the Committee of International Maritime Conference, London, &c. { Cranes.

## INITIALS AND HEADINGS OF ARTICLES

xiii

<b>W. R. E. H.</b>	<b>WILLIAM RICHARD EATON HODGKINSON, PH.D., F.R.S.</b> Professor of Chemistry and Physics, Ordnance College, Woolwich. Formerly Professor of Chemistry and Physics, R.M.A., Woolwich. Part-author of Valentin-Hodgkinson's <i>Practical Chemistry</i> ; &c.	{ <b>Cordite.</b>
<b>W. R. S.</b>	<b>WILLIAM ROBERTSON SMITH, LL.D.</b> See the biographical article: SMITH, W. R.	{ <b>David (in part);</b> <b>Decalogue (in part).</b>
<b>W. T. Ca.</b>	<b>WILLIAM THOMAS CALMAN, D.Sc., F.Z.S.</b> Assistant in charge of Crustacea, Natural History Museum, South Kensington. Author of "Crustacea" in <i>A Treatise on Zoology</i> , edited by Sir E. Ray Lankester.	{ <b>Crab;</b> <b>Crayfish;</b> <b>Crustacea.</b>
<b>W. Wr.</b>	<b>WILLISTON WALKER, PH.D., D.D.</b> Professor of Church History, Yale University. Author of <i>History of the Congregational Churches in the United States</i> ; <i>The Reformation</i> ; <i>John Calvin</i> ; &c.	{ <b>Cotton, John.</b>
<b>W. W. H.*</b>	<b>HON. WILLIAM WIRT HENRY, M.A. (d. 1900).</b> Formerly President of the American Historical Association and of the Virginia Historical Society. Author and Editor of the <i>Life, Correspondence and Speeches of Patrick Henry</i> .	{ <b>Davis, Jefferson (in part).</b>
<b>W. W. R.*</b>	<b>WILLIAM WALKER ROCKWELL, PH.D.</b> Assistant Professor of Church History, Union Theological Seminary, New York.	{ <b>Council.</b>

---

### PRINCIPAL UNSIGNED ARTICLES

Constitution and Constitutional Law. Consul. Cookery. Coorg. Copper. Coprolites. Copyhold. Copyright. Coral. Cork. Cornell University. Cornwall.	Corporation. Corrupt Practices. Corsica. Corvée. Costa Rica. Count. Court. Couvade. Covenanters. Crawford, Earls of. Crécy. Cretaceous System. Cribbage.	Cricket. Crocus. Croquet. Cruciferae. Culdees. Cumberland. Curling. Currant. Cursor Mundi. Cutlery. Cycling. Cycloid. Cynics.	Cyrenaics. Dacia. Dahomey. Damask. Darfur. Deacon. Dean. Death. Debt. Deccan. Delism. Delaware. Delirium.
---	--	---	---



# ENCYCLOPÆDIA BRITANNICA

## ELEVENTH EDITION

### VOLUME VII

**CONSTANTINE PAVLOVICH** (1779-1831), grand-duke and cesarevich of Russia, was born at Tsarskoye Selo on the 27th of April 1779. Of the sons born to the unfortunate tsar Paul Petrovich and his wife Maria Feodorovna, *née* princess of Würtemberg, none more closely resembled his father in bodily and mental characteristics than did the second, Constantine Pavlovich. The direction of the boy's upbringing was entirely in the hands of his grandmother, the empress Catherine II. As in the case of her eldest grandson (afterwards the emperor Alexander I.), she regulated every detail of his physical and mental education; but in accordance with her usual custom she left the carrying out of her views to the men who were in her confidence. Count Nicolai Ivanovich Soltikov was supposed to be the actual tutor, but he too in his turn transferred the burden to another, only interfering personally on quite exceptional occasions, and exercised neither a positive nor a negative influence upon the character of the exceedingly passionate, restless and headstrong boy. The only person who really took him in hand was César La Harpe, who was tutor-in-chief from 1783 to May 1795 and educated both the empress's grandsons.

Like Alexander, Constantine was married by Catherine when not yet seventeen years of age, a raw and immature boy, and he made his wife, Juliana of Coburg, intensely miserable. After a first separation in the year 1799, she went back permanently to her German home in 1801, the victim of a frivolous intrigue, in the guilt of which she was herself involved. An attempt made by Constantine in 1814 to win her back to his hearth and home broke down on her firm opposition. During the time of this tragic marriage Constantine's first campaign took place under the leadership of the great Suvorov. The battle of Bassignano was lost by Constantine's fault, but at Novi he distinguished himself by such personal bravery that the emperor Paul bestowed on him the title of cesarevich, which according to the fundamental law of the constitution belonged only to the heir to the throne. Though it cannot be proved that this action of the tsar denoted any far-reaching plan, it yet shows that Paul already distrusted the grand-duke Alexander. However that may be, it is certain that Constantine never tried to secure the throne. After his father's death he led a wild and disorderly bachelor life. He abstained from politics, but remained faithful to his military inclinations, though, indeed, without manifesting anything more than a preference for the externalities of the service.

In command of the Guards during the campaign of 1805

Constantine had a share of the responsibility for the unfortunate turn which events took at the battle of Austerlitz; while in 1807 neither his skill nor his fortune in war showed any improvement. However, after the peace of Tilsit he became an ardent admirer of the great Corsican and an upholder of the Russo-French alliance. It was on this account that in political questions he did not enjoy the confidence of his imperial brother. To the latter the French alliance had always been merely a means to an end, and after he had satisfied himself at Erfurt, and later during the Franco-Austrian War of 1809, that Napoleon likewise regarded his relation to Russia only from the point of view of political advantage, he became convinced that the alliance must transform itself into a battle of life and death. Such insight was never attained by Constantine; even in 1812, after the fall of Moscow, he pressed for a speedy conclusion of peace with Napoleon, and, like field-marshal Kutusov, he too opposed the policy which carried the war across the Russian frontier to a victorious conclusion upon French soil. During the campaign he was a boon companion of every commanding-officer. Barclay de Tolly was twice obliged to send him away from the army. His share in the battles in Germany and France was insignificant. At Dresden, on the 26th of August, his military knowledge failed him at the decisive moment, but at La Fère-Champenoise he distinguished himself by personal bravery. On the whole he cut no great figure. In Paris the grand-duke excited public ridicule by the manifestation of his petty military fads. His first visit was to the stables, and it was said that he had marching and drilling even in his private rooms.

In the great political decisions of those days Constantine took not the smallest part. His importance in political history dates only from the moment when the emperor Alexander entrusted him in Poland with a task which enabled him to concentrate all the one-sidedness of his talents and all the doggedness of his nature on a definite object: that of the militarization and outward discipline of Poland. With this begins the part played by the grand-duke in history. In the Congress-Poland created by Alexander he received the post of commander-in-chief of the forces of the kingdom; to which was added later (1810) the command of the Lithuanian troops and of those of the Russian provinces that had formerly belonged to the kingdom of Poland. In effect he was the actual ruler of the country, and soon became the most zealous advocate of the separate position of Poland created by the constitution granted by Alexander. He organized their army for the Poles, and felt himself more a Pole than a

Russian, especially after his marriage, on the 27th of May 1820, with a Polish lady, Johanna Grudzinska. Connected with this was his renunciation of any claim to the Russian succession, which was formally completed in 1822. It is well known how, in spite of this, when Alexander I. died on the 1st of December 1825 the grand-duke Nicholas had him proclaimed emperor in St Petersburg, in connexion with which occurred the famous revolt of the Russian Liberals, known as the rising of the Dekabrists. In this crisis Constantine's attitude had been very correct, far more so than that of his brother, which was vacillating and uncertain. Under the emperor Nicholas also Constantine maintained his position in Poland. But differences soon arose between him and his brother in consequence of the share taken by the Poles in the Dekabrist conspiracy. Constantine hindered the unravelling of the organized plotting for independence which had been going on in Poland for many years, and held obstinately to the belief that the army and the bureaucracy were loyally devoted to the Russian empire. The eastern policy of the tsar and the Turkish War of 1828 and 1829 caused a fresh breach between them. It was owing to the opposition of Constantine that the Polish army took no part in this war, so that there was in consequence no Russo-Polish comradeship in arms, such as might perhaps have led to a reconciliation between the two nations.

The insurrection at Warsaw in November 1830 took Constantine completely by surprise. It was owing to his utter failure to grasp the situation that the Polish regiments passed over to the revolutionaries; and during the continuance of the revolution he showed himself as incompetent as he was lacking in judgment. Every defeat of the Russians appeared to him almost in the light of a personal gratification: his soldiers were victorious. The suppression of the revolution he did not live to see. He died of cholera at Vitebsk on the 27th of June 1831. He was an impossible man in an impossible situation. On the Russian imperial throne he would in all probability have been a tyrant like his father.

See also Karnovich's *The Csesarevich Constantine Pavlovich* (2 vols., St Petersburg, 1899), (Russian); T. Schiemann's *Geschichte Russlands unter Kaiser Nicolaus I.* vol. i. (Berlin, 1904); Pasyrevski's *The Russo-Polish War of 1831* (2nd ed., St Petersburg, 1890) (Russian). (T. Sc.)

**CONSTANTINE**, a city of Algeria, capital of the department of the same name, 54 m. by railway S. by W. of the port of Philippeville, in 36°22' N., 6°36' E. Constantine is the residence of a general commanding a division, of a prefect and other high officials, is the seat of a bishop, and had a population in 1906 of 46,806, of whom 25,312 were Europeans. The population of the commune, which includes the suburbs of Constantine, was 58,435. The city occupies a romantic position on a rocky plateau, cut off on all sides save the west from the surrounding country by a beautiful ravine, through which the river Rummel flows. The plateau is 2130 ft. above sea-level, and from 500 to nearly 1000 ft. above the river bed. The ravine, formed by the Rummel, through erosion of the limestone, varies greatly in width—at its narrowest part the cliffs are only 15 ft. apart, at its broadest the valley is 400 yds. wide. At the N.E. angle of the city the gorge is spanned by an iron bridge (El-Kantara) built in 1863, giving access to the railway station, situated on Mansura hill. A stone bridge built by the Romans, and restored at various times, suddenly gave way in 1857 and is now in ruins; it was built on a natural arch, which, 184 ft. above the level of the river, spans the valley. Along the north-eastern side of the city the Rummel is spanned in all four times by these natural stone arches or tunnels. To the north the city is commanded by the Jebel Mecid, a hill which the French (following the example of the Romans) have fortified.

Constantine is walled, the extant medieval wall having been largely constructed out of Roman material. Through the centre from north to south runs a street (the rue de France) roughly dividing Constantine into two parts. The place du Palais, in which are the palace of the governor and the cathedral, and the kasbah (citadel) are west of the rue de France, as is likewise

the place Négrier, containing the law courts. The native town lies chiefly in the south-east part of the city. A striking contrast exists between the Moorish quarter, with its tortuous lanes and Oriental architecture, and the modern quarter, with its rectangular streets and wide open squares, frequently bordered with trees and adorned with fountains. Of the squares the place de Nemours is the centre of the commercial and social life of the city. Of the public buildings those dating from before the French occupation possess chief interest. The palace, built by Ahmed Pasha, the last bey of Constantine, between 1830 and 1836, is one of the finest specimens of Moorish architecture of the 19th century. The kasbah, which occupies the northern corner of the city, dates from Roman times, and preserves in its more modern portions numerous remains of other Roman edifices. It is now turned into barracks and a hospital. The fine mosque of Sidi-el-Kattani (or Salah Bey) dates from the close of the 18th century; that of Suk-er-Rezel, now transformed into a cathedral, and called *Notre-Dame des Sept Douleurs*, was built about a century earlier. The Great Mosque, or Jamaa-el-Kebir, occupies the site of what was probably an ancient pantheon. The mosque Sidi-el-Akhdar has a beautiful minaret nearly 80 ft. high. The museum, housed in the hôtel de ville, contains a fine collection of antiquities, including a famous bronze statuette of the winged figure of Victory, 23 in. high, discovered in the kasbah in 1858.

A religious seminary, or medressa, is maintained in connexion with the Sidi-el-Kattani; and the French support a college and various minor educational establishments for both Arabic and European culture. The native industry of Constantine is chiefly confined to leather goods and woollen fabrics. Some 100,000 burnouses are made annually, the finest partly of wool and partly of silk. There is also an active trade in embossing or engraving copper and brass utensils. A considerable trade is carried on over a large area by means of railway connexion with Algiers, Bona, Tunis and Biskra, as well as with Philippeville. The railways, however, have taken away from the city its monopoly of the traffic in wheat, though its share in that trade still amounts to from £400,000 to £480,000 a year.

Constantine, or, as it was originally called, Cirta or Kirtha, from the Phoenician word for a city, was in ancient times one of the most important towns of Numidia, and the residence of the kings of the Massyli. Under Micipsa (2nd century B.C.) it reached the height of its prosperity, and was able to furnish an army of 10,000 cavalry and 20,000 infantry. Though it afterwards declined, it still continued an important military post, and is frequently mentioned during successive wars. Caesar having bestowed a part of its territory on his supporter Sittius, the latter introduced a Roman settlement, and the town for a time was known as Colonia Sittianorum. In the war of Maxentius against Alexander, the Numidian usurper, it was laid in ruins; and on its restoration in A.D. 313 by Constantine it received the name which it still retains. It was not captured during the Vandal invasion of Africa, but on the conquest by the Arabians (7th century) it shared the same fate as the surrounding country. Successive Arab dynasties looted it, and many monuments of antiquity suffered (to be finally swept away by "municipal improvements" under the French régime). During the 12th century it was still a place of considerable prosperity; and its commerce was extensive enough to attract the merchants of Pisa, Genoa and Venice. Frequently taken and retaken by the Turks, Constantine finally became under their dominion the seat of a bey, subordinate to the dey of Algiers. To Salah Bey, who ruled from 1770 to 1792, we owe most of the existing Moslem buildings. In 1826 Constantine asserted its independence of the dey of Algiers, and was governed by Haji Ahmed, the choice of the Kabyles. In 1836 the French under Marshal Clausel made an unsuccessful attempt to storm the city, which they attacked by night by way of El-Kantara. The French suffered heavy loss. In 1837 Marshal Valée approached the town by the connecting western isthmus, and succeeded in taking it by assault, though again the French lost heavily. Ahmed, however, escaped and maintained his

independence in the Aures mountains. He submitted to the French in 1848 and died in 1850.

**CONSTANTINOPLE**, the capital of the Turkish empire, situated in  $41^{\circ} 0' 16''$  N. and  $28^{\circ} 58' 14''$  E. The city stands at the southern extremity of the Bosphorus, upon a hilly promontory that runs out from the European or western side of the straits towards the opposite Asiatic bank, as though to stem the rush of waters from the Black Sea into the Sea of Marmora. Thus the promontory has the latter sea on the south, and the bay of the Bosphorus, forming the magnificent harbour known as the Golden Horn, some 4 m. long, on the north. Two streams, the Cydaris and Barbysus of ancient days, the Ali-Bey-Su and Kiahat-Hané-Su of modern times, enter the bay at its north-western end. A small winter stream, named the Lycus, that flows through the promontory from west to south-east into the Sea of Marmora, breaks the hilly ground into two great masses,—a long ridge, divided by cross-valleys into six eminences, overhanging the Golden Horn, and a large isolated hill constituting the south-western portion of the territory. Hence the claim of Constantinople to be enthroned, like Rome, upon seven hills. The 1st hill is distinguished by the Seraglio, St Sophia and the Hippodrome; the 2nd by the column of Constantine and the mosque Nuri-Osmanieh; the 3rd by the war office, the Seraskereate Tower and the mosque of Sultan Suleiman; the 4th by the mosque of Sultan Mahommed II., the Conqueror; the 5th by the mosque of Sultan Selim; the 6th by Tekfouh Serai and the quarter of Egri Kapu; the 7th by Avret Tash and the quarter of Psamatia. In Byzantine times the two last hills were named respectively the hill of Blachernae and the Xerolophos or dry hill.

*History, Architecture and Antiquities.*—Constantinople is famous in history, first as the capital of the Roman empire in the East for more than eleven centuries (330–1453), and secondly as the capital of the Ottoman empire since 1453. In respect of influence over the course of human affairs, its only rivals are Athens, Rome and Jerusalem. Yet even the gifts of these rivals to the cause of civilization often bear the image and superscription of Constantinople upon them. Roman law, Greek literature, the theology of the Christian church, for example, are intimately associated with the history of the city beside the Bosphorus.

The city was founded by Constantine the Great, through the enlargement of the old town of Byzantium, in A.D. 328, and was inaugurated as a new seat of government on the 11th of May, A.D. 330. To indicate its political dignity, it was named New Rome, while to perpetuate the fame of its founder it was styled Constantinople. The chief patriarch of the Greek church still signs himself "archbishop of Constantinople, New Rome." The old name of the place, Byzantium, however, continued in use.

The creation of a new capital by Constantine was not an act of personal caprice or individual judgment. It was the result of causes long in operation, and had been foreshadowed, forty years before, in the policy of Diocletian. After the senate and people of Rome had ceased to be the sovereigns of the Roman world, and their authority had been vested in the sole person of the emperor, the eternal city could no longer claim to be the rightful throne of the state. That honour could henceforth be conferred upon any place in the Roman world which might suit the convenience of the emperor, or serve more efficiently the interests he had to guard. Furthermore, the empire was now upon its defence. Dreams of conquests and extension had long been abandoned, and the pressing question of the time was how to repel the persistent assaults of Persia and the barbarians upon the frontiers of the realm, and so retain the dominion inherited from the valour of the past. The size of the empire made it difficult, if not impossible, to attend to these assaults, or to control the ambition of successful generals, from one centre. Then the East had grown in political importance, both as the scene of the most active life in the state and as the portion of the empire most exposed to attack. Hence the famous scheme of Diocletian to divide the burden of government between four colleagues, in

order to secure a better administration of civil and of military affairs. It was a scheme, however, that lowered the prestige of Rome, for it involved four distinct seats of government, among which, as the event proved, no place was found for the ancient capital of the Roman world. It also declared the high position of the East, by the selection of Nicomedia in Asia Minor as the residence of Diocletian himself. When Constantine, therefore, established a new seat of government at Byzantium, he adopted a policy inaugurated before his day as essential to the preservation of the Roman dominion. He can claim originality only in his choice of the particular point at which that seat was placed, and in his recognition of the fact that his alliance with the Christian church could be best maintained in a new atmosphere.

But whatever view may be taken of the policy which divided the government of the empire, there can be no dispute as to the wisdom displayed in the selection of the site for a new imperial throne. "Of all the events of Constantine's life," says Dean Stanley, "this choice is the most convincing and enduring proof of his real genius." Situated where Europe and Asia are parted by a channel never more than 5 m. across, and sometimes less than half a mile wide, placed at a point commanding the great waterway between the Mediterranean and the Black Sea, the position affords immense scope for commercial enterprise and political action in rich and varied regions of the world. The least a city in that situation can claim as its appropriate sphere of influence is the vast domain extending from the Adriatic to the Persian Gulf, and from the Danube to the eastern Mediterranean. Moreover, the site constituted a natural citadel, difficult to approach or to invest, and an almost impregnable refuge in the hour of defeat, within which broken forces might rally to retrieve disaster. To surround it, an enemy required to be strong upon both land and sea. Foes advancing through Asia Minor would have their march arrested, and their blows kept beyond striking distance, by the moat which the waters of the Bosphorus, the Sea of Marmora and the Dardanelles combine to form. The narrow straits in which the waterway connecting the Mediterranean with the Black Sea contracts, both to the north and to the south of the city, could be rendered impassable to hostile fleets approaching from either direction, while on the landward side the line of defence was so short that it could be strongly fortified, and held against large numbers by a comparatively small force. Nature, indeed, cannot relieve men of their duty to be wise and brave, but, in the marvellous configuration of land and sea about Constantinople, nature has done her utmost to enable human skill and courage to establish there the splendid and stable throne of a great empire.

Byzantium, out of which Constantinople sprang, was a small, well-fortified town, occupying most of the territory comprised in the two hills nearest the head of the promontory, and in the level ground at their base. The landward wall started from a point near the present Stamboul custom-house, and reached the ridge of the 2nd hill, a little to the east of the point marked by Chemberli Tash (the column of Constantine). There the principal gate of the town opened upon the Egnatian road. From that gate the wall descended towards the Sea of Marmora, touching the water in the neighbourhood of the Seraglio lighthouse. The Acropolis, enclosing venerated temples, crowned the summit of the first hill, where the Seraglio stands. Immediately to the south of the fortress was the principal market-place of the town, surrounded by porticoes on its four sides, and hence named the Tetrastoon. On the southern side of the square stood the baths of Zeuxippus, and beyond them, still farther south, lay the Hippodrome, which Septimius Severus had undertaken to build but failed to complete. Two theatres, on the eastern slope of the Acropolis, faced the bright waters of the Marmora, and a stadium was found on the level tract on the other side of the hill, close to the Golden Horn. The Strategion, devoted to the military exercises of the brave little town, stood close to Sirkedji Iskelessi, and two artificial harbours, the Portus Prosforianus and the Neorion, indented the shore of the Golden Horn, respectively in front of the ground now occupied by the station of the Chemins de Fer Orientaux and the Stamboul custom-house.



## CONSTANTINOPLE

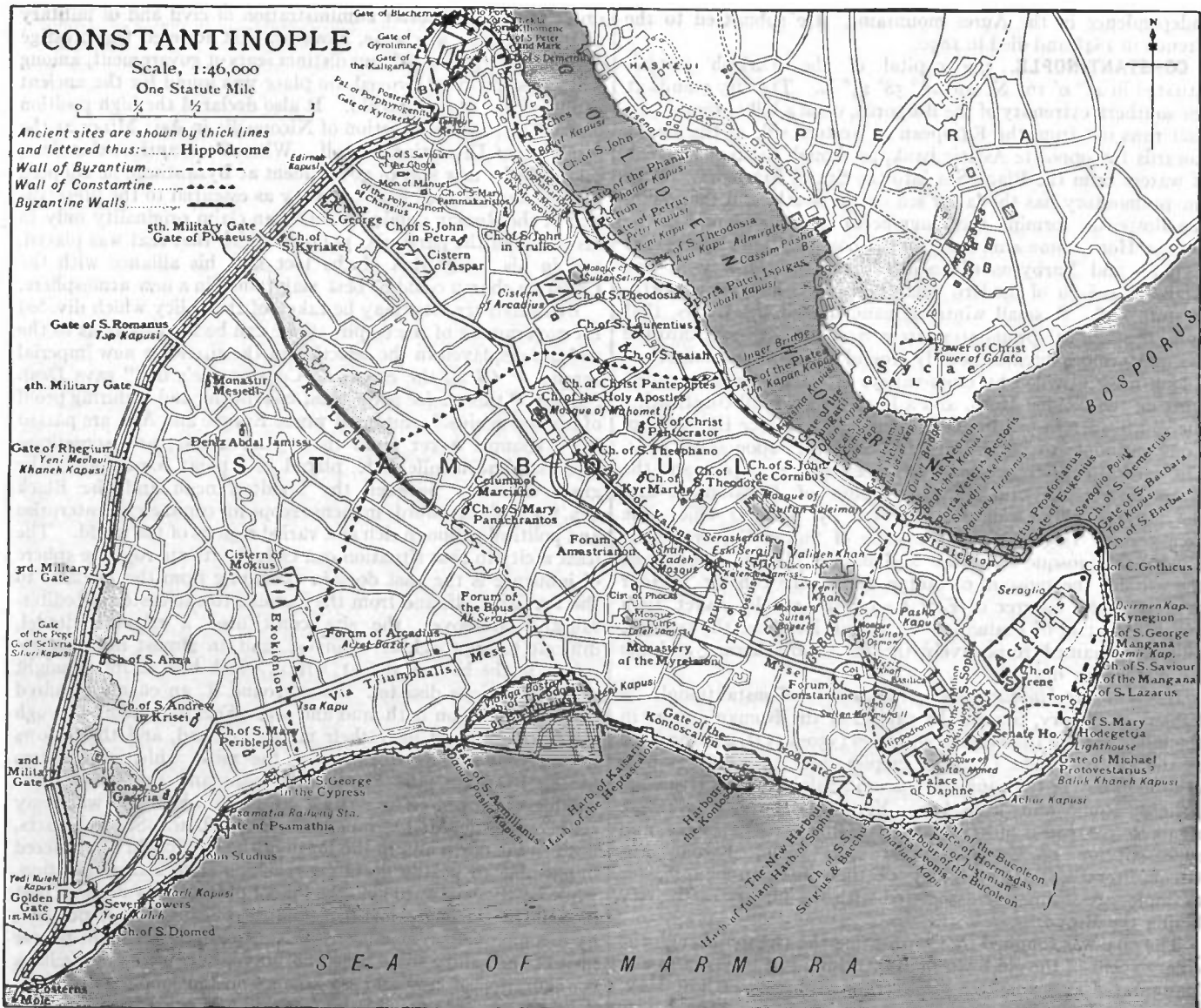

A graceful granite column, still erect on the slope above the head of the promontory, commemorated the victory of Claudius Gothicus over the Goths at Nissa, A.D. 269. All this furniture of Byzantium was appropriated for the use of the new capital.

According to Zosimus, the line of the landward walls erected by Constantine to defend New Rome was drawn at a distance of nearly 2 m. (15 stadia) to the west of the limits of the old town. It therefore ran across the promontory from the vicinity of Un Kapan Kapusi (Porta Platea), at the Stamboul head of the Inner Bridge, to the neighbourhood of Daud Pasha Kapusi (Porta S. Aemiliani), on the Marmora, and thus added the 3rd and 4th hills and portions of the 5th and 7th hills to the territory of Byzantium. We have two indications of the course of these walls on the 7th hill. One is found in the name Isa Kapusi (the Gate of Jesus) attached to a mosque, formerly a Christian church, situated above the quarter of Psamatia. It perpetuates the memory of the beautiful gateway which formed the triumphal entrance into the city of Constantine, and which survived the original bounds of the new capital as late as 1508, when it was overthrown by an earthquake. The other indication is the name Alti Mermer (the six columns) given to a quarter in the same neighbourhood. The name is an ignorant translation of Exokionion, the corrupt form of the designation Exokionion, which belonged in Byzantine days to that quarter because marked by a column outside the city limits. Hence the Arians, upon their expulsion from the city by Theodosius I., were allowed to hold

their religious services in the Exokionion, seeing that it was an extra-mural district. This explains the fact that Arians are sometimes styled Exokionitae by ecclesiastical historians. The Constantinian line of fortifications, therefore, ran a little to the east of the quarter of Alti Mermer. In addition to the territory enclosed within the limits just described, the suburb of Sycae or Galata, on the opposite side of the Golden Horn, and the suburb of Blachernae, on the 6th hill, were regarded as parts of the city, but stood within their own fortifications. It was to the ramparts of Constantine that the city owed its deliverance when attacked by the Goths, after the terrible defeat of Valens at Adrianople, A.D. 378.

In the opinion of his courtiers, the bounds assigned to New Rome by Constantine seemed, it is said, too wide, but after some eighty years they proved too narrow for the population that had gathered within the city. The barbarians had meantime also grown more formidable, and this made it necessary to have stronger fortifications for the capital. Accordingly, in 413, in the reign of Theodosius II., Anthemius, then praetorian prefect of the East and regent, enlarged and reformed the city by the erection of the wall which forms the innermost line of defence in the bulwarks whose picturesque ruins now stretch from the Sea of Marmora, on the south of Yedi Kuléh (the seven towers), northwards to the old Byzantine palace of the Porphyrogenitus (Tekfour Serai), above the quarter of Egri Kapu. There the new works joined the walls of the suburb of Blachernae, and thus



protected the city on the west down to the Golden Horn. Somewhat later, in 439, the walls along the Marmora and the Golden Horn were brought, by the prefect Cyrus, up to the extremities of the new landward walls, and thus invested the capital in complete armour. Then also Constantinople attained its final size. For any subsequent extension of the city limits was insignificant, and was due to strategic considerations. In 447 the wall of Anthemius was seriously injured by one of those earthquakes to which the city is liable. The disaster was all the more grave, as the Huns under Attila were carrying everything before them in the Balkan lands. The desperateness of the situation, however, roused the government of Theodosius II., who was still upon the throne, to put forth the most energetic efforts to meet the emergency. If we may trust two contemporary inscriptions, one Latin, the other Greek, still found on the gate Yeni Mevlevi Khanéh Kapusi (Porta Rhegium), the capital was again fully armed, and rendered more secure than ever, by the prefect Constantine, in less than two months. Not only was the wall of Anthemius restored, but, at the distance of 20 yds., another wall was built in front of it, and at the same distance from this second wall a broad moat was constructed with a breastwork along its inner edge. Each wall was flanked by ninety-six towers. According to some authorities, the moat was flooded during a siege by opening the aqueducts, which crossed the moat at intervals and conveyed water into the city in time of peace. This opinion is extremely doubtful. But in any case, here was a barricade 190-207 ft. thick, and 100 ft. high, with its several parts rising tier above tier to permit concerted action, and alive with large bodies of troops ready to pour, from every coign of vantage, missiles of death—arrows, stones, Greek fire—upon a foe. It is not strange that these fortifications defied the assaults of barbarism upon the civilized life of the world for more than a thousand years. As might be expected, the walls demanded frequent restoration from time to time in the course of their long history. Inscriptions upon them record repairs, for example, under Justin II., Leo the Isaurian, Basil II., John Palaeologus, and others. Still, the ramparts extending now from the Marmora to Tekfour Serai are to all intents and purposes the ruins of the Theodosian walls of the 5th century.

This is not the case in regard to the other parts of the fortifications of the city. The walls along the Marmora and the Golden Horn represent the great restoration of the seaward defences of the capital carried out by the emperor Theophilus in the 9th century; while the walls between Tekfour Serai and the Golden Horn were built long after the reign of Theodosius II., superseding the defences of that quarter of the city in his day, and relegating them, as traces of their course to the rear of the later works indicate, to the secondary office of protecting the palace of Blachernae. In 627 Heraclius built the wall along the west of the quarter of Aivan Serai, in order to bring the level tract at the foot of the 6th hill within the city bounds, and shield the church of Blachernae, which had been exposed to great danger during the siege of the city by the Avars in that year. In 813 Leo V. the Armenian built the wall which stands in front of the wall of Heraclius to strengthen that point in view of an expected attack by the Bulgarians.

The splendid wall, flanked by nine towers, that descends from the court of Tekfour Serai to the level tract below Egri Kapu, was built by Manuel Comnenus (1143-1180) for the greater security of the part of the city in which stood the palace of Blachernae, then the favourite imperial residence. Lastly, the portion of the fortifications between the wall of Manuel and the wall of Heraclius presents too many problems to be discussed here. Enough to say, that in it we find work belonging to the times of the Comneni, Isaac Angelus and the Palaeologi.

If we leave out of account the attacks upon the city in the course of the civil wars between rival parties in the empire, the fortifications of Constantinople were assailed by the Avars in 627; by the Saracens in 673-677, and again in 718; by the Bulgarians in 813 and 913; by the forces of the Fourth Crusade in 1203-1204; by the Turks in 1422 and 1453. The city was

taken in 1204, and became the seat of a Latin empire until 1261, when it was recovered by the Greeks. On the 29th of May 1453 Constantinople ceased to be the capital of the Roman empire in the East, and became the capital of the Ottoman dominion.

The most noteworthy points in the circuit of the walls of the city are the following. (1) The Golden gate, now included in the Turkish fortress of Yedi Kuléh. It is a triumphal archway, consisting of three arches, erected in honour of the victory of Theodosius I. over Maximus in 388, and subsequently incorporated in the walls of Theodosius II., as the state entrance of the capital. (2) The gate of Selivria, or of the Pegé, through which Alexius Strategopoulos made his way into the city in 1261, and brought the Latin empire of Constantinople to an end. (3) The gate of St Romanus (Top Kapusi), by which, in 1453, Sultan Mahommed entered Constantinople after the fall of the city into Turkish hands. (4) The great breach made in the ramparts crossing the valley of the Lycus, the scene of the severest fighting in the siege of 1453, where the Turks stormed the city, and the last Byzantine emperor met his heroic death. (5) The palace of the Porphyrogenitus, long erroneously identified with the palace of the Hebdomon, which really stood at Makrikeui. It is the finest specimen of Byzantine civil architecture left in the city. (6) The tower of Isaac Angelus and the tower of Anemas, with the chambers in the body of the wall to the north of them. (7) The wall of Leo, against which the troops of the Fourth Crusade came, in 1203, from their camp on the hill opposite the wall, and delivered their chief attack. (8) The walls protecting the quarter of Phanar, which the army and fleet of the Fourth Crusade under the Venetian doge Henrico Dandolo carried in 1204. (9) Yali Kiosk Kapusi, beside which the southern end of the chain drawn across the mouth of the harbour during a siege was attached. (10) The ruins of the palace of Hormisdas, near Chatladi Kapu, once the residence of Justinian the Great and Theodora. It was known in later times as the palace of the Bucoleon, and was the scene of the assassination of Nicephorus Phocas. (11) The sites of the old harbours between Chatladi Kapu and Daud Pasha Kapusi. (12) The fine marble tower near the junction of the walls along the Marmora with the landward walls.

The interior arrangements of the city were largely determined by the configuration of its site, which falls into three great divisions,—the level ground and slopes looking towards the Sea of Marmora, the range of hills forming the midland portion of the promontory, and the slopes and level ground facing the Golden Horn. In each division a great street ran through the city from east to west, generally lined with arcades on one side, but with arcades on both sides when traversing the finer and busier quarters. The street along the ridge formed the principal thoroughfare, and was named the Mesé (Μέση), because it ran through the middle of the city. On reaching the west of the 3rd hill, it divided into two branches, one leading across the 7th hill to the Golden gate, the other conducting to the church of the Holy Apostles, and the gate of Charisius (Edirnéh Kapusi). The Mesé linked together the great fora of the city,—the Augustaion on the south of St Sophia, the forum of Constantine on the summit of the 2nd hill, the forum of Theodosius I. or of Taurus on the summit of the 3rd hill, the forum of Amastrianon where the mosque of Shah Zadéh is situated, the forum of the Bous at Ak Serai, and the forum of Arcadius or Theodosius II. on the summit of the 7th hill. This was the route followed on the occasion of triumphal processions.

Of the edifices and monuments which adorned the fora, only a slight sketch can be given here. On the north side of the Augustaion rose the church of St Sophia, the most glorious cathedral of Eastern Christendom; opposite, on the southern side of the square, was the Chalcé, the great gate of the imperial palace; on the east was the senate house, with a porch of six noble columns; to the west, across the Mesé, were the law courts. In the area of the square stood the Milion, whence distances from Constantinople were measured, and a lofty column which bore the equestrian statue of Justinian the Great. There also was the statue of the empress Eudoxia, famous in the history of Chrysostom, the pedestal of which is preserved near the church

of St Irené. The Augustaion was the heart of the city's ecclesiastical and political life. The forum of Constantine was a great business centre. Its most remarkable monument was the column of Constantine, built of twelve drums of porphyry and bearing aloft his statue. Shorn of much of its beauty, the column still stands to proclaim the enduring influence of the foundation of the city.

In the forum of Theodosius I. rose a column in his honour, constructed on the model of the hollow columns of Trajan and Marcus Aurelius at Rome. There also was the Anemodoulion, a beautiful pyramidal structure, surmounted by a vane to indicate the direction of the wind. Close to the forum, if not in it, was the capitol, in which the university of Constantinople was established. The most conspicuous object in the forum of the Bous was the figure of an ox, in bronze, beside which the bodies of criminals were sometimes burnt. Another hollow column, the pedestal of which is now known as Avret Tash, adorned the forum of Arcadius. A column in honour of the emperor Marcian still stands in the valley of the Lycus, below the mosque of Sultan Mahommed the Conqueror. Many beautiful statues, belonging to good periods of Greek and Roman art, decorated the fora, streets and public buildings of the city, but conflagrations and the vandalism of the Latin and Ottoman conquerors of Constantinople have robbed the world of those treasures.

The imperial palace, founded by Constantine and extended by his successors, occupied the territory which lies to the east of St Sophia and the Hippodrome down to the water's edge. It consisted of a large number of detached buildings, in grounds made beautiful with gardens and trees, and commanding magnificent views over the Sea of Marmora, across to the hills and mountains of the Asiatic coast. The buildings were mainly grouped in three divisions—the Chalcé, the Daphné and the "sacred palace." Labarte and Paspates have attempted to reconstruct the palace, taking as their guide the descriptions given of it by Byzantine writers. The work of Labarte is specially valuable, but without proper excavations of the site all attempts to restore the plan of the palace with much accuracy lack a solid foundation. With the accession of Alexius Comnenus, the palace of Blachernae, at the north-western corner of the city, became the principal residence of the Byzantine court, and was in consequence extended and embellished. It stood in a more retired position, and was conveniently situated for excursions into the country and hunting expeditions. Of the palaces outside the walls, the most frequented were the palace at the Hebdomon, now Makrikeui, in the early days of the Empire, and the palace of the Pegé, now Balukli, a short distance beyond the gate of Selivria, in later times. For municipal purposes, the city was divided, like Rome, into fourteen Regions.

As the seat of the chief prelate of Eastern Christendom, Constantinople was characterized by a strong theological and ecclesiastical temperament. It was full of churches and monasteries, enriched with the reputed relics of saints, prophets and martyrs, which consecrated it a holy city and attracted pilgrims from every quarter to its shrines. It was the meeting-place of numerous ecclesiastical councils, some of them ecumenical (see below, CONSTANTINOPLE, COUNCILS OF). It was likewise distinguished for its numerous charitable institutions. Only some twenty of the old churches of the city are left. Most of them have been converted into mosques, but they are valuable monuments of the art which flourished in New Rome. Among the most interesting are the following. St John of the Studium (Emir-Achor Jamissi) is a basilica of the middle of the 5th century, and the oldest ecclesiastical fabric in the city; it is now, unfortunately, almost a complete ruin. SS. Sergius and Bacchus (Kutchuk Aya Sofia) and St Sophia are erections of Justinian the Great. The former is an example of a dome placed on an octagonal structure, and in its general plan is similar to the contemporary church of S. Vitale at Ravenna. St Sophia (*i.e.* Ἁγία Σοφία, Holy Wisdom) is the glory of Byzantine art, and one of the most beautiful buildings in the world. St Mary Diaconissa (Kalender Jamissi) is a fine specimen of the work of the closing years of the 6th century. St Irené, founded by

Constantine, and repaired by Justinian, is in its present form mainly a restoration by Leo the Isaurian, in the middle of the 8th century. St Mary Panachrantos (Fenari Isa Mesjidi) belongs to the reign of Leo the Wise (886-912). The Myrelaion (Bodrum Jami) dates from the 10th century. The Pantepoptes (Eski Imaret Jamissi), the Pantocrator (Zeirek Kilissé Jamissi), and the body of the church of the Chora (Kahriyeh Jamissi) represent the age of the Comneni. The Pammacaristos (Fetiyyeh Jamissi), St Andrew in Krisei (Khoja Mustapha Jamissi), the narthexes and side chapel of the Chora were, at least in their present form, erected in the times of the Palaeologi. It is difficult to assign precise dates to SS. Peter and Mark (Khoda Mustapha Jamissi at Aivan Serai), St Theodosia (Gul Jamissi), St Theodore Tyrone (Kilissé Jamissi). The beautiful façade of the last is later than the other portions of the church, which have been assigned to the 9th or 10th century.

For the thorough study of the church of St Sophia, the reader must consult the works of Fossati, Salzenburg, Lethaby and Swainson, and Antoniadi. The present edifice was built by Justinian the Great, under the direction of Anthemius of Tralles and his nephew Isidorus of Miletus. It was founded in 532 and dedicated on Christmas Day 538. It replaced two earlier churches of that name, the first of which was built by Constantius and burnt down in 404, on the occasion of the exile of Chrysostom, while the second was erected by Theodosius II. in 415, and destroyed by fire in the Nika riot of 532. Naturally the church has undergone repair from time to time. The original dome fell in 558, as the result of an earthquake, and among the improvements introduced in the course of restoration, the dome was raised 25 ft. higher than before. Repairs are recorded under Basil I., Basil II., Andronicus III. and Cantacuzene. Since the Turkish conquest a minaret has been erected at each of the four exterior angles of the building, and the interior has been adapted to the requirements of Moslem worship, mainly by the destruction or concealment of most of the mosaics which adorned the walls. In 1847-1848, during the reign of Abd-ul-Mejid, the building was put into a state of thorough repair by the Italian architect Fossati. Happily the sultan allowed the mosaic figures, then exposed to view, to be covered with matting before being plastered over. They may reappear in the changes which the future will bring.

The exterior appearance of the church is certainly disappointing, but within it is, beyond all question, one of the most beautiful creations of human art. On a large scale, and in magnificent style, it combines the attractive features of a basilica, with all the glory of an edifice crowned by a dome. We have here a stately hall, 235 ft. N. and S., by 250 ft. E. and W., divided by two piers and eight columns on either hand into nave and aisles, with an apse at the eastern end and galleries on the three other sides. Over the central portion of the nave, a square area at the angles of which stand the four piers, and at a height of 179 ft. above the floor, spreads a dome, 107 ft. in diameter, and 46 ft. deep, its base pierced by forty arched windows. From the cornice of the dome stretches eastwards and westwards a semi-dome, which in its turn rests upon three small semi-domes. The nave is thus covered completely by a domical canopy, which, in its ascent, swells larger and larger, mounts higher and higher, as though a miniature heaven rose overhead. For lightness, for grace, for proportion, the effect is unrivalled. The walls of the building are reveted with marbles of various hues and patterns, arranged to form beautiful designs, and traces of the mosaics which joined the marbles in the rich and soft coloration of the whole interior surface of the building appear at many points. There are forty columns on the ground floor and sixty in the galleries, often crowned with beautiful capitals, in which the monograms of the emperor Justinian and the empress Theodora are inscribed. The eight porphyry columns, placed in pairs in the four bays at the corners of the nave, belonged originally to the temple of the sun at Baalbek. They were subsequently carried to Rome by Aurelian, and at length presented to Justinian by a lady named Marcia, to be erected in this church "for the salvation of her soul." The columns of verde antique on either

side of the nave are commonly said to have come from the temple of Diana at Ephesus, but recent authorities regard them as specially cut for use in the church. The inner narthex of the church formed a magnificent vestibule 205 ft. long by 26 ft. wide, reveted with marble slabs and glowing with mosaics.

The citizens of Constantinople found their principal recreation in the chariot-races held in the Hippodrome, now the At Meidan, to the west of the mosque of Sultan Ahmed. So much did the race-course (begun by Severus but completed by Constantine) enter into the life of the people that it has been styled "the axis of the Byzantine world." It was not only the scene of amusement, but on account of its ample accommodation it was also the arena of much of the political life of the city. The factions, which usually contended there in sport, often gathered there in party strife. There emperors were acclaimed or insulted; there military triumphs were celebrated; there criminals were executed, and there martyrs were burned at the stake. Three monuments remain to mark the line of the Spina, around which the chariots whirled; an Egyptian obelisk of Thothmes III., on a pedestal covered with bas-reliefs representing Theodosius I., the empress Galla, and his sons Arcadius and Honorius, presiding at scenes in the Hippodrome; the triple serpent column, which stood originally at Delphi, to commemorate the victory of Plataea 479 B.C.; a lofty pile of masonry, built in the form of an obelisk, and once covered with plates of gilded bronze. Under the Turkish buildings along the western side of the arena, some arches against which seats for the spectators were built are still visible.

The city was supplied with water mainly from two sources; from the streams immediately to the west, and from the springs and rain impounded in reservoirs in the forest of Belgrade, to the north-west, very much on the system followed by the Turks. The water was conveyed by aqueducts, concealed below the surface, except when crossing a valley. Within the city the water was stored in covered cisterns, or in large open reservoirs. The aqueduct of Justinian, the Crooked aqueduct, in the open country, and the aqueduct of Valens that spans the valley between the 4th and 3rd hills of the city, still carry on their beneficent work, and afford evidence of the attention given to the water-supply of the capital during the Byzantine period. The cistern of Arcadius, to the rear of the mosque of Sultan Selim (having, it has been estimated, a capacity of 6,571,720 cubic ft. of water), the cistern of Aspar, a short distance to the east of the gate of Adrianople, and the cistern of Mokiüs, on the 7th hill, are specimens of the open reservoirs within the city walls. The cistern of Bin Bir Derek (cistern of Illus) with its 224 columns, each built up with three shafts, and the cistern Yeri Batan Serai (Cisterna Basilica) with its 420 columns show what covered cisterns were, on a grand scale. The latter is still in use.<sup>1</sup>

Byzantine Constantinople was a great commercial centre. To equip it more fully for that purpose, several artificial harbours were constructed along the southern shore of the city, where no natural haven existed to accommodate ships coming up the Sea of Marmora. For the convenience of the imperial court, there was a small harbour in the bend of the shore to the east of Chatladi Kapu, known as the harbour of the Bucoleon. To the west of that gate, on the site of Kadriga Limani (the Port of the Galley), was the harbour of Julian, or, as it was named later, the harbour of Sophia (the empress of Justin II.). Traces of the harbour styled the Kontoscalion are found at Kum Kapu. To the east of Yeni Kapu stood the harbour of Kaisarius or the Heptascalion, while to the west of that gate was the harbour which bore the names of Eleutherius and of Theodosius I. A harbour named after the Golden gate stood on the shore to the south-west of the triumphal gate of the city.

*The Modern City.*—As the capital of the Ottoman empire, the aspect of the city changed in many ways. The works of

art which adorned New Rome gradually disappeared. The streets, never very wide, became narrower, and the porticoes along their sides were almost everywhere removed. A multitude of churches were destroyed, and most of those which survived were converted into mosques. In race and garb and speech the population grew largely oriental. One striking alteration in the appearance of the city was the conversion of the territory extending from the head of the promontory to within a short distance of St Sophia into a great park, within which the buildings constituting the seraglio of the sultans, like those forming the palace of the Byzantine emperors, were ranged around three courts, distinguished by their respective gates—Bab-i-Humayum, leading into the court of the Janissaries; Orta Kapu, the middle gate, giving access to the court in which the sultan held state receptions; and Bah-i-Saadet, the gate of Felicity, leading to the more private apartments of the palace. From the reign of Abd-ul-Mejid, the seraglio has been practically abandoned, first for the palace of Dolmabahché on the shore near Beshiktash, and now for Yildiz Kiosk, on the heights above that suburb. It is, however, visited annually by the sultan, to do homage to the relics of the prophet which are kept there. The older apartments of the palace, such as the throne-room, the Bagdad Kiosk, and many of the objects in the imperial treasury are of extreme interest to all lovers of oriental art. To visit the seraglio, an imperial iradé is necessary. Another great change in the general aspect of the city has been produced by the erection of stately mosques in the most commanding situations, where dome and minarets and huge rectangular buildings present a combination of mass and slenderness, of rounded lines and soaring pinnacles, which gives to Constantinople an air of unique dignity and grace, and at the same time invests it with the glamour of the oriental world. The most remarkable mosques are the following:—The mosque of Sultan Mahommed the Conqueror, built on the site of the church of the Holy Apostles, in 1459, but rebuilt in 1768 owing to injuries due to an earthquake; the mosques of Sultan Selim, of the Shah Zadeh, of Sultan Suleiman and of Rustem Pasha—all works of the 16th century, the best period of Turkish architecture; the mosque of Sultan Bayezid II. (1497–1505); the mosque of Sultan Ahmed I. (1610); Yeni-Validé-Jamissi (1615–1665); Nuri-Osmanieh (1748–1755); Laleli-Jamissi (1765). The Turbehs containing the tombs of the sultans and members of their families are often beautiful specimens of Turkish art.

In their architecture, the mosques present a striking instance of the influence of the Byzantine style, especially as it appears in St Sophia. The architects of the mosques have made a skilful use of the semi-dome in the support of the main dome of the building, and in the consequent extension of the arched canopy that spreads over the worshipper. In some cases the main dome rests upon four semi-domes. At the same time, when viewed from the exterior, the main dome rises large, bold and commanding, with nothing of the squat appearance that mars the dome of St Sophia, with nothing of the petty prettiness of the little domes perched on the drums of the later Byzantine churches. The great mosques express the spirit of the days when the Ottoman empire was still mighty and ambitious. Occasionally, as in the case of Laleli Jamissi, where the dome rests upon an octagon inscribed in a square, the influence of SS. Sergius and Bacchus is perceptible.

For all intents and purposes, Constantinople is now the collection of towns and villages situated on both sides of the Golden Horn and along the shores of the Bosphorus, including Scutari and Kadikeui. But the principal parts of this great agglomeration are Stamboul (from Gr. εἰς τὴν πόλιν, "into the city"), the name specially applied to the portion of the city upon the promontory, Galata and Pera. Galata has a long history, which becomes of general interest after 1265, when it was assigned to the Genoese merchants in the city by Michael Palaeologus, in return for the friendly services of Genoa in the overthrow of the Latin empire of Constantinople. In the course of time, notwithstanding stipulations to the contrary, the town was strongly fortified and proved a troublesome neighbour

<sup>1</sup> For full information on the subject of the ancient water-supply see Count A. F. Andréossy, *Constantinople et le Bosphore*; Tchikatchev, *Le Bosphore et Constantinople* (2nd ed., Paris, 1865); Forchheimer and Strzygowski, *Die byzantinischen Wasserbehälter*; also article AQUEDUCT.

During the siege of 1453 the inhabitants maintained on the whole a neutral attitude, but on the fall of the capital they surrendered to the Turkish conqueror, who granted them liberal terms. The walls have for the most part been removed. The noble tower, however, which formed the citadel of the colony, still remains, and is a striking feature in the scenery of Constantinople. There are also churches and houses dating from Genoese days. Galata is the chief business centre of the city, the seat of banks, post-offices, steamship offices, &c. Pera is the principal residential quarter of the European communities settled in Constantinople, where the foreign embassies congregate, and the fashionable shops and hotels are found.

Since the middle of the 19th century the city has yielded more and more to western influences, and is fast losing its oriental character. The sultan's palaces, and the residences of all classes of the community, adopt with more or less success a European style of building. The streets have been widened and named. They are in many instances better paved, and are lighted at night. The houses are numbered. Cabs and tramways have been introduced. Public gardens have been opened. For some distance outside the Galata bridge, both shores of the Golden Horn have been provided with a quay at which large steamers can moor to discharge or embark their passengers and cargo. The Galata quay, completed in 1889, is 756 metres long and 20 metres wide; the Stamboul quay, completed in 1900, is 378 metres in length. The harbour, quays and facilities for handling merchandise, which have been established at the head of the Anatolian railway, at Haidar Pasha, under German auspices, would be a credit to any city. It is true that most of these improvements are due to foreign enterprise and serve largely foreign interests; still they have also benefited the city, and added much to the convenience and comfort of local life. There has been likewise progress in other than material respects. The growth of the imperial museum of antiquities, under the direction of Hamdy Bey, within the grounds of the Seraglio, has been remarkable; and while the collection of the sarcophagi discovered at Sidon constitutes the chief treasure of the museum, the institution has become a rich storehouse of many other valuable relics of the past. The existence of a school of art, where painting and architecture are taught, is also a sign of new times. A school of handicrafts flourishes on the Sphendoné of the Hippodrome. The fine medical school between Scutari and Haidar Pasha, the Hamidieh hospital for children, and the asylum for the poor, tell of the advance of science and humanity in the place.

Considerable attention is now given to the subject of education throughout the empire, a result due in great measure to the influence of the American and French schools and colleges established in the provinces and at the capital. More than thirty foreign educational institutions flourish in Constantinople itself, and they are largely attended by the youth belonging to the native communities of the country. The Greek population is provided with excellent schools and gymnasia, and the Armenians also maintain schools of a high grade. The Turkish government itself became, moreover, impressed with the importance of education, and as a consequence the whole system of public instruction for the Moslem portion of the population was, during the reign of Sultan Abd-ul-Hamid II., more widely extended and improved. Beside the schools of the old type attached to the mosques, schools of a better class were established under the direct control of the minister of education, which, although open to improvement, certainly aimed at a higher standard than that reached in former days. The progress of education became noticeable even among Moslem girls. The social and political influence of this intellectual improvement among the various communities of the empire soon made itself felt, and had much to do with the startling success of the constitutional revolution carried out, under the direction of the Committee of Union and Progress, in the autumn of 1908.

*Climate.*—The climate of the city is healthy, but relaxing. It is damp and liable to sudden and great changes of temperature. The winds from the north and those from the south are at

constant feud, and blow cold or hot in the most capricious manner, often in the course of the same day. "There are two climates at Constantinople, that of the north and that of the south wind." The winters may be severe, but when mild they are wet and not invigorating. In summer the heat is tempered by the prevalence of a north-east wind that blows down the channel of the Bosphorus. Observations at Constantinople and at Scutari give the following results, for a period of twenty years.

	Constantinople.	Scutari.
Mean temperature . . . . .	57° 7'	58° 1'
Maximum . . . . .	99° 1'	103° 6'
Minimum . . . . .	17° 2'	13° 0'
Rain . . . . .	28.3 in.	29.29 in.
Number of rainy days . . . . .	112	128.6

The sanitation of the city has been improved, although much remains to be done in that respect. No great epidemic has visited the city since the outbreak of cholera in 1866. Typhoid and pulmonary diseases are common.

*Population.*—The number of the population of the city is an uncertain figure, as no accurate statistics can be obtained. It is generally estimated between 800,000 and 1,000,000. The inhabitants present a remarkable conglomeration of different races, various nationalities, divers languages, distinctive costumes and conflicting faiths, giving, it is true, a singular interest to what may be termed the human scenery of the city, but rendering impossible any close social cohesion, or the development of a common civic life. Constantinople has well been described as "a city not of one nation but of many, and hardly more of one than of another." The following figures are given as an approximate estimate of the size of the communities which compose the population.

Moslems . . . . .	384,910
Greeks . . . . .	152,741
Greek Latins . . . . .	1,082
Armenians . . . . .	149,590
Roman Catholics (native) . . . . .	6,442
Protestants (native) . . . . .	819
Bulgarians . . . . .	4,377
Jews . . . . .	44,361
Foreigners . . . . .	129,243

873,565

*Water-Supply.*—Under the rule of the sultans, the water-supply of the city has been greatly extended. The reservoirs in the forest of Belgrade have been enlarged and increased in number, and new aqueducts have been added to those erected by the Byzantine emperors. The use of the old cisterns within the walls has been almost entirely abandoned, and the water is led to basins in vaulted chambers (*Taxim*), from which it is distributed by underground conduits to the fountains situated in the different quarters of the city. From these fountains the water is taken to a house by water-carriers, or, in the case of the humbler classes, by members of the household itself.

For the supply of Pera, Galata and Beshiktash, Sultan Mahmud I. constructed, in 1732, four bends in the forest of Belgrade, N.N.W. and N.E. of the village of Bagchekeui, and the fine aqueduct which spans the head of the valley of Buyukderé. Since 1885, a French company, La Compagnie des Eaux, has rendered a great service by bringing water to Stamboul, Pera, and the villages on the European side of the Bosphorus, from Lake Dercos, which lies close to the shore of the Black Sea some 29 m. distant from the city. The Dercos water is laid on in many houses. Since 1893 a German company has supplied Scutari and Kadikeui with water from the valley of the Sweet Waters of Asia.

*Trade.*—The trade of the city has been unfavourably affected by the political events which have converted former provinces of the Turkish empire into autonomous states, by the development of business at other ports of the empire, owing to the opening up of the interior country through the construction of railroads, and by the difficulties which the government, with the view of preventing political agitation, has put in the way of

easy intercourse by natives between the capital and the provinces. Most of the commerce of the city is in hands of foreigners and of Armenian and Greek merchants. Turks have little if anything to do with trade on a large scale. "The capital," says a writer in the *Konstantinopler Handelsblatt* of November 1904, "produces very little for export, and its hinterland is small, extending on the European side only a few kilometres—the outlet for the fertile Eastern Rumelia is Dedeagach—and on the Asiatic side embracing the Sea of Marmora and the Anatolian railway district. Even part of this will be lost to Constantinople when the Anatolian railway is connected with the port of Mersina and with the Kassaba-Smyrna railway. Some 750 tons of the sweetmeat known as 'Turkish delight' are annually exported to the United Kingdom, America and Rumelia; embroideries, &c., are sold in fair quantities to tourists. Otherwise the chief articles of Constantinople's export trade consist of refuse and waste materials, sheep's wool (called *Kassab basht*) and skins from the slaughter-houses (in 1903 about 3,000,000 skins were exported, mostly to America), horns, hoofs, goat and horse hair, guts, bones, rags, bran, old iron, &c., and finally dogs' excrements, called in trade 'pure,' a Constantinople speciality, which is used in preparing leather for ladies' gloves. From the hinterland comes mostly raw produce such as grain, drugs, wool, silk, ores and also carpets. The chief article is grain."

The average value of the goods passing through the port of Constantinople at the opening of the 20th century was estimated at about £T 11,000,000. From the imperfect statistics available, the following tables of the class of goods imported and exported, and their respective values, were drawn up in 1901 by the late Mr Whittaker, *The Times* correspondent.

<i>Imports.</i>	
Manufactured goods (cotton, woollen, silk, &c.)	£ T <sup>1</sup> 3,500,000
Haberdashery, ironmongery	90,000
Sugar	500,000
Petroleum	400,000
Flour	400,000
Coffee	300,000
Rice	250,000
Cattle	100,000
Various	850,000
Total	£ T 7,000,000
<i>Exports.</i>	
Cereals	£ T 1,000,000
Mohair	800,000
Carpets	700,000
Silk and cocoons	500,000
Opium	400,000
Gum tragacanth	150,000
Wool	100,000
Hides	100,000
Various	250,000
Total	£ T 4,100,000

About 40% of the import trade of Constantinople is British. According to the trade report of the British consulate, the share of the United Kingdom in the value of £7,142,000 on the total imports to Constantinople during the year 1900-1901 was £1,811,000; while the share of the United Kingdom in the value of £2,669,000 on the total exports during the same year was £998,000. But it is worthy of note that while British commerce still led the way in Turkey, the trade of some other countries with Turkey, especially that of Germany, was increasing more rapidly. Comparing the average of the period 1896-1900 with the total for 1904, British trade showed an increase of 33%, Austro-Hungarian of nearly 60%, Germany of 130%, Italian of 98%, French of 8%, and Belgian of nearly 33%. The shipping visiting the port of Constantinople during the year 1905, excluding sailing and small coasting vessels, was 9796, representing a total of 14,785,080 tons. The percentage of steamers under the British flag was 37.1; of tonnage, 45.9.

*Administration.*—For the preservation of order and security, the city is divided into four divisions (Belad-i-Selassi), viz.

<sup>1</sup> A Turkish lira = 18 shillings (English).

Stamboul, Pera-Galata, Beshiktash and Scutari. The minister of police is at the head of the administration of the affairs of these divisions, and is *ex-officio* governor of Stamboul. The governors of the other divisions are subordinate to him, but are appointed by the sultan. Each governor has a special staff of police and gendarmery and his own police-court. In each division is a military commander, having a part of the garrison of the city under his orders, but subordinate to the commander-in-chief of the troops guarding the capital.

The municipal government of the four divisions of the city is in the hands of a prefect, appointed by the sultan, and subordinate to the minister of the interior. He is officially styled the prefect of Stamboul, and is assisted by a council of twenty-four members, appointed by the sultan or the minister of the interior. All matters concerning the streets, the markets, the bazaars, the street-porters (*hamals*), public weighers, baths and hospitals come under his jurisdiction. He is charged also with the collection of the city dues, and the taxes on property. The city is furthermore divided into ten municipal circles as follows. In Stamboul: (1) Sultan Bayezid, (2) Sultan Mehemet, (3) Djerah Pasha (Psmatia); on the European side of the Bosphorus and the northern side of the Golden Horn: (4) Beshiktash, (5) Yenikeui, (6) Pera, (7) Buyukderé; on the Asiatic side of the Bosphorus: (8) Anadol Hissar, (9) Scutari, (10) Kadikeui. Each circle is subdivided into several wards (*mahalleh*). "The outlying parts of the city are divided into six districts (*Casas*), namely, Princes' Islands, Guebzeh, Beicos, Kartal, Kuchuk-Chekmedjé and Shilé, each having its governor (*kaimakam*), who is usually chosen by the palace. These districts are dependencies of the ministry of the interior, and their municipal affairs are directed by agents of the prefecture."

In virtue of old treaties, known as the Capitulations (*q.v.*), foreigners enjoy to a large extent the rights of extraterritoriality. In disputes with one another, they are judged before their own courts of justice. In litigation between a foreigner and a native, the case is taken to a native court, but a representative of the foreigner's consulate attends the proceedings. Foreigners have a right to establish their own schools and hospitals, to hold their special religious services, and even to maintain their respective national post-offices. No Turkish policeman may enter the premises of a foreigner without the sanction of the consular authorities to whose jurisdiction the latter belongs. A certain measure of self-government is likewise granted to the native Christian communities under their ecclesiastical chiefs.

*BIBLIOGRAPHY.*—On Constantinople generally, besides the regular guide-books and works already mentioned, see P. Gyllius, *De topographia Constantinopoleos, De Bosphoro Thracio* (1632); Du Cange, *Constantinopolis Christiana* (1680); J. von Hammer, *Constantinopolis und der Bosphoros* (1822); Mordtmann, *Esquisse topographique de Constantinople* (1892); E. A. Grosvenor, *Constantinople* (1895); van Millingen, *Byzantine Constantinople* (1899); Paspates, *Boşarıval Mederaı* (1877); Scarlatos Byzantios, *Ἡ Κωνσταντινού πόλις* (1851); E. Pears, *Fall of Constantinople* (1885), *The Destruction of the Greek Empire* (1903); Gibbon, *The Decline and Fall of the Roman Empire*; Salzenberg, *Altchristliche Baudenkmale von Konstantinopel*; Lethaby and Swainson, *The Church of Sancta Sophia*; Pulgher, *Les Anciennes Églises byzantines de Constantinople*; Labarte, *Le Palais impérial de Constantinople et ses abords.* (A. van M.)

**CONSTANTINOPLE, COUNCILS OF.** Of the numerous ecclesiastical councils held at Constantinople the most important are the following:

1. The second ecumenical council, 381, which was in reality only a synod of bishops from Thrace, Asia and Syria, convened by Theodosius with a view to uniting the church upon the basis of the Orthodox faith. No Western bishop was present, nor any Roman legate; from Egypt came only a few bishops, and these tardily. The first president was Meletius of Antioch, whom Rome regarded as schismatic. Yet, despite its sectional character, the council came in time to be regarded as ecumenical alike in the West and in the East.

The council reaffirmed the Nicene faith and denounced all opposing doctrines. The so-called "Niceno-Constantinopolitan Creed," which has almost universally been ascribed to this council, is certainly not the Nicene creed nor even a recension



of it, but most likely a Jerusalem baptismal formula revised by the interpolation of a few Nicene test-words. More recently its claim to be called "Constantinopolitan" has been challenged. It is not found in the earliest records of the acts of the council, nor was it referred to by the council of Ephesus (431), nor by the "Robber Synod" (449), although these both confirmed the Nicene faith. It also lacks the definiteness one would expect in a creed composed by an anti-Arian, anti-Pneumatomachian council. Harnack (*Herzog-Hauck, Realencyklopädie*, 3rd ed., s.v. "Konstantinopolit. Symbol.") conjectures that it was ascribed to the council of Constantinople just before the council of Chalcedon in order to prove the orthodoxy of the Fathers of the second ecumenical council. At all events, it became the creed of the universal church, and has been retained without change, save for the addition of *filioque*.

Of the seven reputed canons of the council only the first four are unquestionably genuine. The fifth and the sixth probably belong to a synod of 382, and the seventh is properly not a canon. The most important enactments of the council were the granting of metropolitan rights to the bishops of Alexandria, Antioch, Thrace, Pontus and Ephesus; and according to Constantinople the place of honour after Rome, against which Rome protested. Not until 150 years later, and then only under compulsion of the emperor Justinian, did Rome acknowledge the ecumenicity of the council, and that merely as regarded its doctrinal decrees.

See Mansi iii. pp. 521-599; Hardouin i. pp. 807-826; Hefele, 2nd ed., ii. pp. 1 sqq. (English translation, ii. pp. 340 sqq.); Hort, *Two Dissertations* (Cambridge, 1876); and the article CREEDS.

2. The council of 553, the fifth ecumenical, grew out of the controversy of the "Three Chapters," an adequate account of which, up to the time of the council, may be found in the articles JUSTINIAN and VIGILIUS. The council convened, in response to the imperial summons, on the 4th of May 553. Of the 165 bishops who subscribed the acts all but the five or six from Egypt were Oriental; the pope, Vigilius, refused to attend (he had made his escape from Constantinople, and from his retreat in Chalcedon sent forth a vain protest against the council). The synod was utterly subservient to the emperor. The "Three Chapters" were condemned, and their authors, long dead, anathematized, without, however, derogating from the authority of the council of Chalcedon, which had given them a clean bill of orthodoxy. Vigilius was excommunicated, and his name erased from the diptychs. The Orthodox faith was set forth in fourteen anathemas. Opinion is divided as to whether Origen was condemned. His name occurs in the eleventh anathema, but some consider it an interpolation; Hefele defends the genuineness of the text, but finds no evidence for a special session against Origen, as some have conjectured.

The council was confirmed by the emperor, and was generally received in the East. Vigilius was soon coerced into submission, but the West repudiated his pusillanimous surrender, and rejected the council. A schism ensued which lasted half a century and was not fully healed until the synod of Aquileia, about 700. But the ecumenicity of the council was generally acknowledged by 680.

See Mansi ix. pp. 24-106, 149-658, 712-730; Hardouin iii. pp. 1-328, 331, 414, 524; Hefele, 2nd ed., ii. pp. 798-924 (English translation, iv. pp. 229-365).

3. The sixth ecumenical council, 680-681, which was convened by the emperor Constantine Pogonatus to terminate the Monothelitic controversy (see MONOTHELITES). All the patriarchates were represented, Constantinople and Antioch by their bishops in person, the others by legates. The number of bishops present varied from 150 to 300. The council approved the first five ecumenical councils and reaffirmed the Nicene and "Niceno-Constantinopolitan" creeds. Monothelism was unequivocally condemned; Christ was declared to have had "two natural wills and two natural operations, without division, conversion, separation or confusion." Prominent Monothelites, living or dead, were anathematized, in particular Sergius and his successors in the see of Constantinople, the former pope, Honorius, and Macarius, the patriarch of Antioch. An imperial decree confirmed the council, and commanded the acceptance of its

doctrines under pain of severe punishment. The Monothelites took fright and fled to Syria, where they gradually formed the sect of the Maronites (*q.v.*).

The anathematizing of Honorius as heterodox has occasioned no slight embarrassment to the supporters of the doctrine of papal infallibility. It is not within the scope of this article to pass judgment upon the various proposed solutions of the difficulty, e.g. that Honorius was not really a Monothelite; that in acknowledging one will he was not speaking *ex cathedra*; that, at the time of condemning him, the council was no longer ecumenical; &c. One thing is certain, however, he was anathematized; and the notion of interpolation in the acts of the council (Baronius) may be dismissed as groundless.

See Mansi xi. pp. 190-922; Hardouin iii. pp. 1043-1644; Hefele, 2nd ed. iii. pp. 121-313.

4. The "Quinisext Synod" (692), so-called because it was regarded by the Greeks as supplementing the fifth and sixth ecumenical councils, was held in the dome of the Imperial Palace ("In Trullo," whence the synod is called also "Trullan"). Its work was purely legislative and its decisions were set forth in 102 canons. The sole authoritative standards of discipline were declared to be the "eighty-five apostolic canons," the canons of the first four ecumenical councils and of the synods of Ancyra, Neo-Caesarea, Antioch, Chagra, Laodicea, Sardica and Carthage, and the canonical writings of some twelve Fathers, —all canons, synods and Fathers, Eastern with one exception, viz. Cyprian and the synod of Carthage; the bishops of Rome and the occidental synods were utterly ignored.

The canons of the second and fourth ecumenical councils respecting the rank of Constantinople were confirmed; the rank of a see was declared to follow the civil rank of its city; unenthroned bishops were guaranteed against diminution of their rights; metropolitans were forbidden to alienate the property of vacant suffragan sees.

The provisions respecting clerical marriage were avowedly more lenient than the Roman practice. Ordination was denied to any one who after baptism had contracted a second marriage, kept a concubine, or married a widow or a woman of ill-repute. Lectors and cantors might marry after ordination; presbyters, deacons and sub-deacons, if already married, should retain their wives; a bishop, however, while not dissolving his marriage, should keep his wife at a distance, making suitable provision for her. An illegally married cleric could not perform sacerdotal functions. Monks and nuns were to be carefully separated, and were not to leave their houses without permission.

It was forbidden to celebrate baptism or the eucharist in private oratories; neither might laymen give the elements to themselves, nor approach the altar, nor teach. Offerings for the dead were authorized, and the mixed chalice made obligatory. Contrary to the occidental custom, fasting on Saturday was forbidden. The mutilation of the Scriptures and the desecration of sacred places were severely condemned; likewise the use of the lamb as the symbol for Christ (a favourite symbol in the West).

The synod legislated also concerning marriage, bigamy, adultery, rape, abortion, seductive arts and obscenity. The theatre, the circus and gambling were unsparingly denounced, and soothsayers and jugglers, pagan festivals and customs, and pagan oaths were placed under the ban.

The council was confirmed by the emperor and accepted in the East; but the pope protested against various canons, chiefly those respecting the rank of Constantinople, clerical marriage, the Saturday fast, and the use of the symbol of lamb; and refused, despite express imperial command and threat, to accept the "Pseudo-Sexta." So that while the synod adopted a body of legislation that has continued to be authoritative for the Eastern Church, it did so at the cost of aggravating the irritation of the West, and by so much hastening the inevitable rupture of the church.

See Mansi xi. pp. 921-1024; Hardouin iii. pp. 1645-1716; Hefele, 2nd ed., iii. pp. 328-348.

5. The iconoclastic synods of 754 and 815, both of which

promulgated harsh decrees against images and neither of which is recognized by the Latin Church, and the synod of 842, which repudiated the synod of 815, approved the second council of Nicaea, and restored the images, are all adequately treated in the article **ICONOCLASTS**.

See Mansi xii. pp. 575 sqq., xiii. pp. 210 sqq., xiv. pp. 111 sqq., 787 sqq.; Hardouin iv. pp. 330 sqq., 1045 sqq., 1457 sqq.; Hefele, 2nd ed. iv. pp. 1 sqq., 104 sqq.

6. The synods of 869 and 879, of which the former, regarded by the Latin Church as the eighth ecumenical council, condemned Photius as an usurper and restored Ignatius to the see of Constantinople; the latter, which the Greeks consider to have been the true eighth ecumenical council, held after the death of Ignatius and the reconciliation of Photius with the emperor, repudiated the synod of 869, restored Photius, and condemned all who would not recognize him. (For further details of these two synods see **PHOTIUS**.)

See Mansi xv. pp. 143-476 *et passim*, xvi. pp. 1-550, xvii. pp. 66-186, 365-530; Hardouin v. pp. 119-390, 749-1210, *et passim*, vi. pp. 19-87, 209-334; Hefele, 2nd ed., iv. pp. 228 sqq., 333 sqq., 435 sqq.; Hergenröther, *Photius* (Regensburg, 1867-1869). (T. F. C.)

**CONSTANTINUS**, pope from 708 to 715, was a Syrian by birth and was consecrated pope in March 708. He was eager to assert the supremacy of the papal see; at the command of the emperor Justinian II. he visited Constantinople; and he died on the 9th of April 715.

**CONSTANTIUS, FLAVIUS VALERIUS**, commonly called **CHLORUS** (the Pale), an epithet due to the Byzantine historians, Roman emperor and father of Constantine the Great, was born about A.D. 250. He was of Illyrian origin; a fictitious connexion with the family of Claudius Gothicus was attributed to him by Constantine. Having distinguished himself by his military ability and his able and gentle rule of Dalmatia, he was, on the 1st of March 293, adopted and appointed Caesar by Maximian, whose step-daughter, Flavia Maximiana Theodora, he had married in 289 after renouncing his wife Helena (the mother of Constantine). In the distribution of the provinces Gaul and Britain were allotted to Constantius. In Britain Carausius and subsequently Allectus had declared themselves independent, and it was not till 296 that, by the defeat of Allectus, it was re-united with the empire. In 298 Constantius overthrew the Alamanni in the territory of the Lingones (Langres) and strengthened the Rhine frontier. During the persecution of the Christians in 303 he behaved with great humanity. He obtained the title of Augustus on the 1st of May 305, and died the following year shortly before the 25th of July at Eboracum (York) during an expedition against the Picts and Scots.

See Aurelius Victor, *De Caesaribus*, 39; Eutropius ix. 14-23; Zosimus ii. 7.

**CONSTANTZA** (*Constanta*), formerly known as Kustendji or Kustendje, a seaport on the Black Sea, and capital of the department of Constantza, Rumania; 140 m. E. by S. from Bucharest by rail. Pop. (1900) 12,725. When the Dobrudja was ceded to Rumania in 1878, Constantza was partly rebuilt. In its clean and broad streets there are many synagogues, mosques and churches, for half the inhabitants are Roman Catholics, Moslems, Armenians or Jews; the remainder being Orthodox Rumanians and Greeks. In the vicinity there are mineral springs, and the sea-bathing also attracts many visitors in summer. The chief local industries are tanning and the manufacture of petroleum drums. The opening, in 1895, of the railway to Bucharest, which crosses the Danube by a bridge at Cerna Voda, brought Constantza a considerable transit trade in grain and petroleum, which are largely exported; coal and coke head the list of imports, followed by machinery, iron goods, and cotton and woollen fabrics. The harbour, protected by breakwaters, with a lighthouse at the entrance, is well defended from the north winds, but those from the south, south-east, and south-west prove sometimes highly dangerous. In 1902 it afforded 10 alongside berths for shipping. It had a depth of 22 ft. in the old or inner basin, and of 26 ft. in the new or outer basin, beside the quays. The railway runs along the quays. A weekly service between Constantza and Constantinople is conducted by state-owned

steamers, including the fast mail and passenger boats in connexion with the Ostend and Orient expresses. In 1902, 576 vessels entered at Constantza, with a net registered tonnage of 641,737. The Black Sea squadron of the Rumanian fleet is stationed here.

Constantza is the Constantiana which was founded in honour of Constantia, sister of Constantine the Great (A.D. 274-337). It lies at the seaward end of the Great Wall of Trajan, and has evidently been surrounded by fortifications of its own. In spite of damage done by railway contractors (see Henry C. Barkley, *Between the Danube and the Black Sea*, 1876) there are considerable remains of ancient masonry—walls, pillars, &c. A number of inscriptions found in the town and its vicinity show that close by was Tomi, where the Roman poet Ovid (43 B.C.—A.D. 17) spent his last eight years in exile. A statue of Ovid stands in the main square of Constantza.

In regard to the Constantza inscriptions in general, see Allard, *La Bulgarie orientale* (Paris, 1866); Desjardins in *Ann. dell' istit. di corr. arch.* (1868); and a paper on Weickum's collection in *Sitzungsbericht* of the Munich Academy (1875).

**CONSTELLATION** (from the Lat. *constellatus*, studded with stars; *con*, with, and *stella*, a star), in astronomy, the name given to certain groupings of stars. The partition of the stellar expanse into areas characterized by specified stars can be traced back to a very remote antiquity. It is believed that the ultimate origin of the constellation figures and names is to be found in the corresponding systems in vogue among the primitive civilizations of the Euphrates valley—the Sumerians, Accadians and Babylonians; that these were carried westward into ancient Greece by the Phoenicians, and to the lands of Asia Minor by the Hittites, and that Hellenic culture in its turn introduced them into Arabia, Persia and India. From the earliest times the star-groups known as constellations, the smaller groups (parts of constellations) known as asterisms, and also individual stars, have received names connoting some meteorological phenomena, or symbolizing religious or mythological beliefs. At one time it was held that the constellation names and myths were of Greek origin; this view has now been disproved, and an examination of the Hellenic myths associated with the stars and star-groups in the light of the records revealed by the decipherment of Euphratean cuneiforms leads to the conclusion that in many, if not all, cases the Greek myth has a Euphratean parallel, and so renders it probable that the Greek constellation system and the cognate legends are primarily of Semitic or even pre-Semitic origin.

The origin and development of the grouping of the stars into constellations is more a matter of archaeological than of astronomical interest. It demands a careful study of the myths and religious thought of primitive peoples; and the tracing of the names from one language to another belongs to comparative philology.

The Sumerians and Accadians, the non-Semitic inhabitants of the Euphrates valley prior to the Babylonians, described the stars collectively as a "heavenly flock"; the sun was the "old sheep"; the seven planets were the "old-sheep stars"; the whole of the stars had certain "shepherds," and *Sibzianna* (which, according to Sayce and Bosanquet, is the modern Arcturus, the brightest star in the northern sky) was the "star of the shepherds of the heavenly herds." The Accadians bequeathed their system to the Babylonians, and cuneiform tablets and cylinders, boundary stones, and Euphratean art generally, point to the existence of a well-defined system of star names in their early history. From a detailed study of such records, in their nature of rather speculative value, R. Brown, junr. (*Primitive Constellations*, 1899) has compiled a Euphratean planisphere, which he regards as the mother of all others. The tablets examined range in date from 3000-500 B.C., and hence the system must be anterior to the earlier date. Of great importance is the *Creation Legend*, a cuneiform compiled from older records during the reign of Assur-bani-pal, c. 650 B.C., in which there occurs a passage interpretable as pointing to the acceptance of 36 constellations: 12 northern, 12 zodiacal and 12 southern. These constellations were arranged in three

concentric annuli, the northern ones in an inner annulus subdivided into 60 degrees, the zodiacal ones into a medial annulus of 120 degrees, and the southern ones into an outer annulus of 240 degrees. Brown has suggested a correlation of the Euphratean names with those of the Greeks and moderns. His results may be exhibited in the following form:—the central line gives the modern equivalents of the names in the Euphratean zodiac; the upper line the modern equivalents of the northern paranatellons; and the lower line those of the southern paranatellons. The zodiacal constellations have an interest peculiarly their own; placed in or about the plane of the ecliptic, their rising and setting with the sun was observed with relation to weather changes and the more general subject of chronology, the twelve subdivisions of the year being correlated with the twelve divisions of the ecliptic (see ZODIAC).

lution to weather changes. The earliest Greek work which purported to treat the constellations *qua* constellations, of which we have certain knowledge, is the *Φαινόμενα* of Eudoxus of Cnidus (c. 403–350 B.C.). The original is lost, but a versification by Aratus (c. 270 B.C.), a poet at the court of Antigonos Gonatas, king of Macedonia, and an *Ἐξηγησις* or commentary by Hipparchus, are extant. In the *Φαινόμενα* of Aratus 44 constellations are enumerated, viz. 19 northern:—Ursa major, Ursa minor, Boötes, Draco, Cepheus, Cassiopeia, Andromeda, Perseus, Triangulum, Pegasus, Delphinus, Auriga, Hercules, Lyra, Cygnus, Aquila, Sagitta, Corona and Serpentarius; 13 central or zodiacal:—Aries, Taurus, Gemini, Cancer, Leo, Virgo, Libra, Scorpio, Sagittarius, Capricornus, Aquarius, Pisces and the Pleiades; and 12 southern:—Orion, Canis, Lepus, Argo, Cetus, Eridanus, Piscis australis, Ara, Centaurus, Hydra, Crater and

Northern . .	Cassiopeia	Auriga	Cepheus	Ursa minor	Ursa major	Boötes	Serpentarius	Hercules	Lyra	Aquila	Pegasus	Andromeda
Zodiacal . .	Aries	Taurus	Gemini	Cancer	Leo	Virgo	Libra	Scorpio	Sagittarius	Capricornus	Aquarius	Pisces
Southern . .	Eridanus	Orion	Canis major	Argo	Hydra Crater	Corvus	Centaurus	Lupus	Ara	?	Piscis australis	Cetus

The Phoenicians—a race dominated by the spirit of commercial enterprise—appear to have studied the stars more especially with respect to their service to navigators; according to Homer “the stars were sent by Zeus as portents for mariners.” But all their truly astronomical writings are lost, and only by a somewhat speculative piecing together of scattered evidences can an estimate of their knowledge be formed. The inter-relations of the Phoenicians with the early Hellenes were frequent and far-reaching, and in the Greek presentation of the legends concerning constellations a distinct Phoenician, and in turn Euphratean, element appears. One of the earliest examples of Greek literature extant, the *Theogonia* of Hesiod (c. 800 B.C.), appears to be a curious blending of Hellenic and Phoenician thought. Although not an astronomical work, several constellation subjects are introduced. In the same author's *Works and Days*, a treatise which is a sort of shepherd's calendar, there are distinct references to the Pleiades, Hyades, Orion, Sirius and Arcturus. It cannot be argued, however, that these were the only stars and constellations named in his time; the omission proves nothing. The same is true of the Homeric epics wherein the Pleiades, Hyades, Ursa major, Orion and Boötes are mentioned, and also of the stars and constellations mentioned in Job. Further support is given to the view that, in the main, the constellations were transmitted to the Greeks by the Phoenicians from Euphratean sources in the fact that Thales, the earliest Greek astronomer of any note, was of Phoenician descent. According to Callimachus he taught the Greeks to steer by Ursa minor instead of Ursa major; and other astronomical observations are assigned to him. But his writings are lost, as is also the case with those of Phocys the Samian, and the history of astronomy by Eudemos, the pupil of Aristotle; hence the paucity of our knowledge of Thales's astronomical learning.

From the 6th century B.C. onwards, legends concerning the constellation subjects were frequently treated by the historians and poets. Aglaosthenes or Agaosthenes, an early writer, knew Ursa minor as *Κυνόσουρα*, Cynosura, and recorded the translation of Aquila; Epimenides the Cretan (c. 600 B.C.) recorded the translation of Capricornus and the star Capella; Pherecydes of Athens (c. 500–450 B.C.) recorded the legend of Orion, and stated the astronomical fact that when Orion sets Scorpio rises; Aeschylus (525–456 B.C.) and Hellanicus of Mytilene (c. 496–411 B.C.) narrate the legend of the seven Pleiades—the daughters of Atlas; and the latter states that the Hyades are named either from their orientation, which resembles  $\nu$  (upsilon), “or because at their rising or setting Zeus rains”; and Hecataeus of Miletus (c. 470 B.C.) treated the legend of the Hydra.

In the 5th century B.C. the Athenian astronomer Euctemon, according to Geminus of Rhodes, compiled a weather calendar in which Aquarius, Aquila, Canis major, Corona, Cygnus, Delphinus, Lyra, Orion, Pegasus, Sagitta and the asterisms Hyades and Pleiades are mentioned, always, however, in re-

Corvus. In this enumeration Serpens is included in Serpentarius and Lupus in Centaurus; these two constellations were separated by Hipparchus and, later, by Ptolemy. On the other hand, Aratus kept the Pleiades distinct from Taurus, but Hipparchus reduced these stars to an asterism. Aratus was no astronomer, while Hipparchus was; and from the fact that the latter adopted, with but trifling exceptions, the constellation system portrayed by Aratus, it may be concluded that the system was already familiar in Greek thought. And three hundred years after Hipparchus, the Alexandrian astronomer Ptolemy adopted a very similar scheme in his *uranometria*, which appears in the seventh and eighth books of his *Almagest*, the catalogue being styled the “*Ἐκθεσις κανονική*” or “accepted version.”

The *Almagest* has a dual interest: first, being the work of one primarily a commentator, it presents a crystallized epitome of all earlier knowledge; and secondly, it has served as a basis of subsequent star-catalogues.<sup>1</sup> The Ptolemaic catalogue embraces only those stars which were visible at Rhodes in the time of Hipparchus (c. 150 B.C.), the results being corrected for precession “by increasing the longitudes by  $2^{\circ} 40'$ , and leaving the latitudes undisturbed” (Francis Baily, *Mem. R.A.S.*, 1843). The names and orientation of the constellations therein adopted are, with but few exceptions, identical with those used at the present day; and as it cannot be doubted that Ptolemy made only very few modifications in the system of Hipparchus, the names were adopted at least three centuries before the *Almagest* was compiled. The names in which Ptolemy differs from modern usage are:—Hercules (*ἐν γόνασιν*), Cygnus (*ὄρνις*), Eridanus (*Πόταμος*), Lupus (*θηρίον*), Pegasus (*ἵππος*), Equuleus (*ἵππου προσημή*), Canis minor (*Προκύων*), and Libra (*Χηλαί*, although *ζυγός* is used for the same constellation in other parts of the *Almagest*). The following table gives the names of the constellations as they occur in (1) modern catalogues; (2) Ptolemy (A.D. 150); (3) Ulugh Beg (1437); (4) Tycho Brahe (1628); the last column gives the English equivalent of the modern name.

The reverence and authority which was accorded the famous compilation of the Alexandrian astronomer is well evidenced by the catalogue of the Tatar Ulugh Beg, the Arabian names there adopted being equivalent to the Ptolemaic names in nearly every case; this is also shown in the Latin translations given below. Tycho Brahe, when compiling his catalogue of stars, was unable to observe Lupus, Ara, Corona australis and Piscis australis, on account of the latitude of Uranienburg; and hence these constellations are omitted from his catalogue. He diverged from Ptolemy when he placed the asterisms Coma Berenices and Antinous upon the level of formal constellations, Ptolemy having

<sup>1</sup> The historical development of star-catalogues in general, regarded as statistics of the co-ordinates, &c., of stars, is given in the historical section of the article *ASTRONOMY*. See also E. B. Knobel, “Chronology of Star Catalogues.” *Mem. R.A.S.* (1877).



# CONSTELLATION

PLATE I.

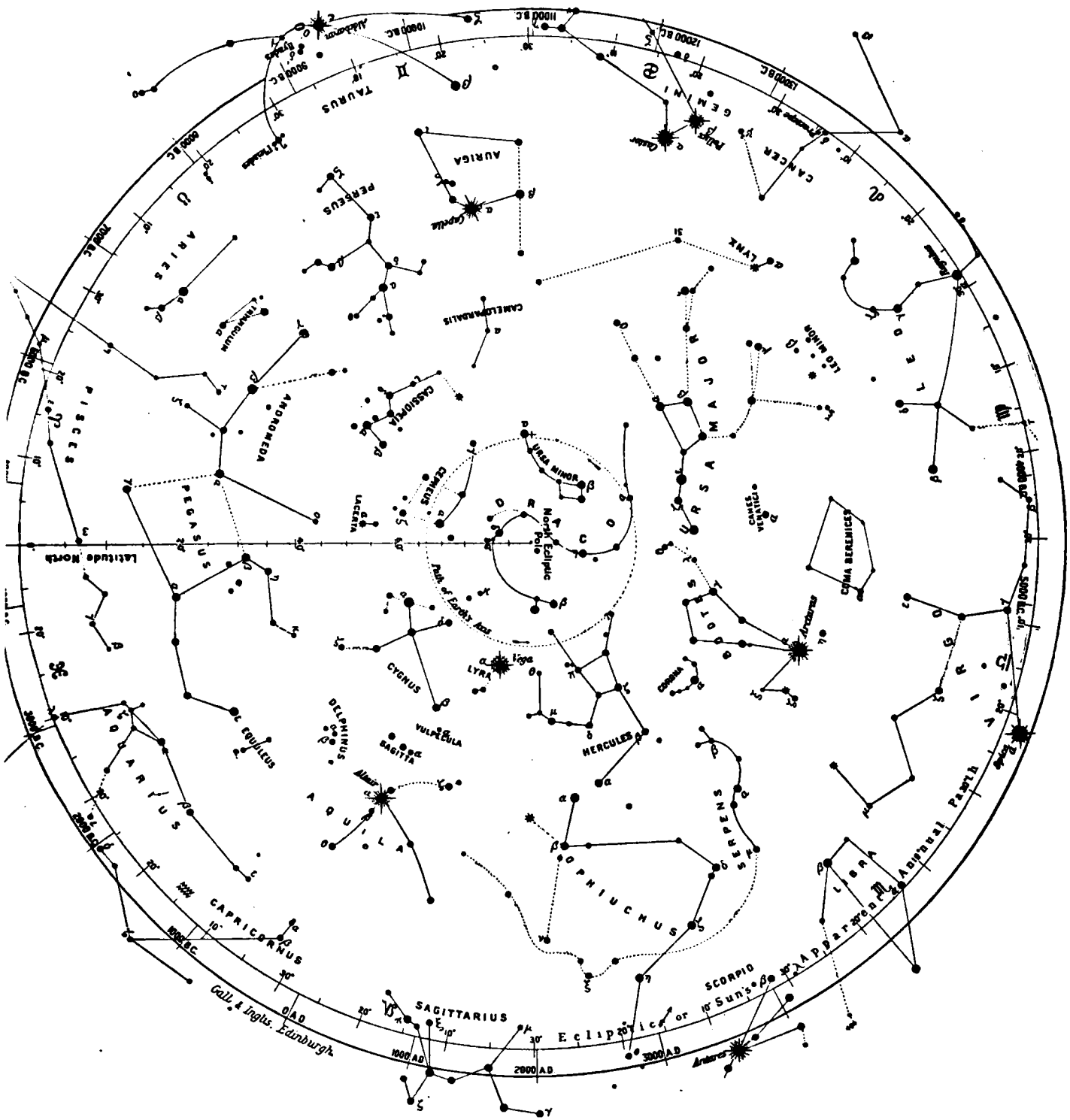

CONSTELLATIONS OF THE NORTHERN HEMISPHERE.

CONSTELLATION

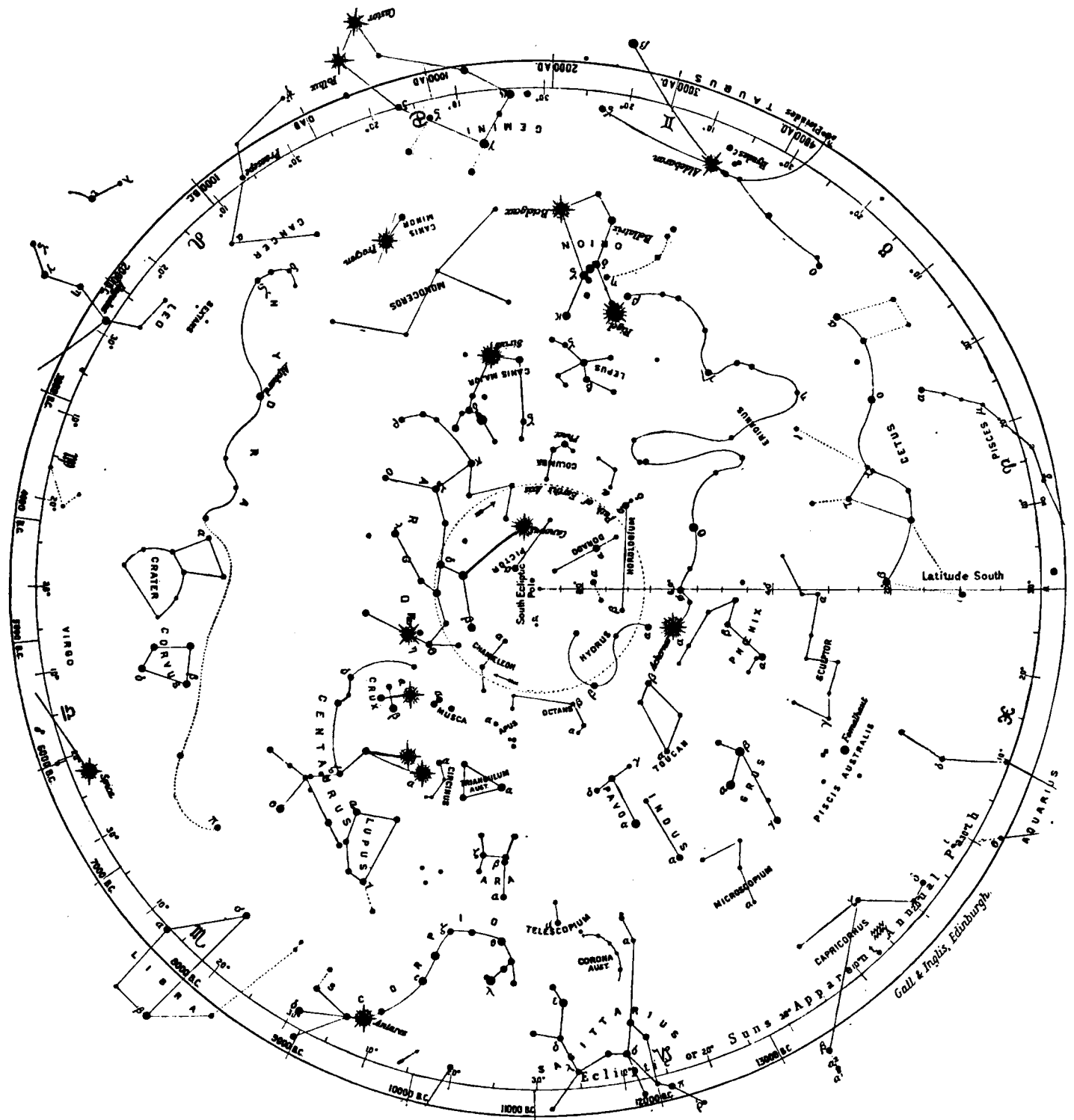

CONSTELLATIONS OF THE SOUTHERN HEMISPHERE.

	Modern.	Ptolemy.	Ulugh Beg.	Tycho Brahe.	Meaning.
Northern constellations (21).	Ursa minor	*Ἀρκτου μικρᾶς ἄστερισμός	Stellae Ursi minoris	Ursa minor, Cynosura	Little Bear
	Ursa major	*Ἀρκτου μεγάλης	Ursi majoris	Ursa major, Helice	Great Bear
	Draco	Δράκοντος	Draconis	Draco	Dragon
	Cepheus	Κηφέως	Cephei	Cepheus	Cepheus
	Boötes	Βούτου	Vociferatoris	Boötes, Arctophylax	Ploughman
	Corona borealis	Στεφάνου βορείου	Coronae or Phecca	Corona borea	Northern Crown
	Hercules	Τοῦ ἐν γόνασιν	Incumbentis genubus	Engonasi, Hercules	Man kneeling
	Lyra	Λύρας	τοῦ Shelyäk or Testudo	Lyra, Vultur cadens	Lyre
	Cygnus	*Ὀρνίθου	Gallinae	Olor, Cygnus	Bird, Swan
	Cassiopeia	Κασσιόπειας	Inthronatae	Cassiopeia	Cassiopeia
	Perseus	Περσέως	Bershaush or Portans Caput Larvae	Perseus	Perseus
	Auriga	*Ἡνώχου	Tenentis habenas	Auriga, Heniochus, Erichthionius	Charioteer
	Serpentarius	*Ὀφιοῦχου	Serpentarii	Ophiuchus, Serpentarius	Serpent-holder
	Serpens	*Ὀρεως ὀφιοῦχου	Serpentis	Serpens ophiuchi	Serpent
	Sagitta	*Ὀιστοῦ	Sagittae	Sagitta or Telum	Arrow
	Aquila	*Ἀετοῦ	Aquilae	Aquila or Vultur volans	Eagle
	Delphinus	Δελφίνου	Delphini	Delphinus	Dolphin
	Equuleus	*Ἴππου προτομῆς	Sectionis equi	Equuleus, Equi sectio	Colt
	Pegasus	*Ἴππου	Equi majoris	Pegasus, Equus alatus	Pegasus, Horse
	Andromeda	*Ἀνδρομέδας	Mulieris catenatae	Andromeda	Andromeda
	Triangulum	Τριγώνου	Trianguli	Triangulus, Deltoton	Triangle
Zodiacal constellations (12).	Aries	Κριοῦ	Arietis	Aries	Ram
	Taurus	Ταύρου	Tauri	Taurus	Bull
	Gemini	Διδύμων	Gemellorum	Gemini	Twins
	Cancer	Καρκίνου	Cancris	Cancer	Crab
	Leo	Λέοντος	Leonis	Leo	Lion
	Virgo	Παρθένου	Virginis, Sumbela	Virgo	Virgin
	Libra	Χηλῶν	Librae	Libra	Balance
	Scorpio	Σκορπίου	Scorpionis	Scorpius	Scorpion
	Sagittarius	Τοξότης	Sagittarii, Arcum	Sagittarius	Archer
	Capricornus	Αἰγόκερωτος	Capricorni	Capricornus	Goat
	Aquarius	*Ἰεροχόρου	Effusoris aquae, Situla	Aquarius	Water-pourer
	Pisces	*Ἰχθύων	Piscis	Pisces	Fishes
Southern constellations (15).	Cetus	Κήτους	Ceti	Cete	Sea-monster, Whale
	Orion	*Ὀρίωνος	Gigantis	Orion	Orion
	Eridanus	Ποταμοῦ	Fluminis	Eridanus fluvius	River
	Lepus	Δαγφῶδ	Leporis	Lepus	Hare
	Canis major	Κυνὸς	Canis majoris	Canis major	Great Dog
	Canis minor	Προκυνὸς	Canis minoris	Canis minor, Procyon	Little Dog
	Argo	*Ἀργοῦς	Navis	Argo navis	Ship
	Hydra	*Ἰδρού	Hydri	Hydra	Sea-serpent
	Crater	Κρατήρος	Craterae	Crater	Bowl
	Corvus	Κόραυος	Corvi	Corvus	Crow
	Centaurus	Κενταύρου	Centauri	Centaurus, Chiron	Centaur
	Lupus	Θηρίου	Ferae		Wild beast
	Ara	Θυμιατηρίου	Thuribuli		Censer, Altar
	Corona australis	Στεφάνου νοτίου	Coronae australis		Southern Crown
	Piscis australis	*Ἰχθύος νοτίου	Piscis australis		Fish

regarded these asterisms as unformed stars (ἀμόρφωτοι). The next innovator of moment was Johann Bayer, a German astronomer, who published a *Uranometria* in 1603, in which twelve constellations, all in the southern hemisphere, were added to Ptolemy's forty-eight, viz. Apis (or Musca) (Bee), Avis Indica (Bird of Paradise), Chameleon, Dorado (Sword-fish), Grus (Crane), Hydrus (Water-snake), Indus (Indian), Pavo (Peacock), Phoenix, Piscis volans (Flying fish), Toucan, Triangulum australe. According to W. Lynn (*Observatory*, 1886, p. 255), Bayer adapted this part of his catalogue from the observations of the Dutch navigator Petrus Theodori (or Pieter Dirchsz Keyser), who died in 1596 off Java. The *Coelum stellatum Christianum* of Julius Schiller (1627) is noteworthy for the attempt made to replace the names connoting mythological and pagan ideas by the names of apostles, saints, popes, bishops, and other dignitaries of the church, &c. Aries became St Peter; Taurus, St Andrew; Andromeda, the Holy Sepulchre; Lyra, the Manger; Canis major, David; and so on. This innovation (with which the introduction of the twelve apostles into the solar zodiac by the Venerable Bede may be compared) was short-lived. According to Charles Hutton [*Math. Dict.* i. 328 (1795)] the editions published in 1654 and 1661 had reverted to the Greek names; on the other hand, Camille Flammarion (*Popular Astronomy*, p. 375) quotes an illuminated folio of 1661, which represents "the sky delivered from pagans and peopled with Christians." A similar confusion was attempted by E. Weigelius, who sought to introduce a *Coelum heraldicum*, in which the

constellations were figured as the arms or insignia of European dynasties, and by symbols of commerce.

In Edmund Halley's southern catalogue (*Catalogus stellarum australium*), published in 1679 and incorporated in Flamsteed's *Historia coelestis* (1725), the following constellations are named:—Piscis australis, Columba Noachi, Argo navis, Robur Caroli, Ara, Corona australis, Grus, Phoenix, Pavo, Apus or Avis Indica, Musca apis, Chameleon, Triangulum australe, Piscis volans, Dorado or Xiphias, Toucan or Anser Americanus, and Hydrus. Flamsteed's maps also contained Mons Menelai. This list contains nothing new except Robur Caroli, since Columba Noachi (Noah's dove) had been raised to the skies by Bartschius in 1624. The constellation Robur Caroli and also the star Cor Caroli (a Canum Venaticorum) were named by Halley in honour of Charles II. of England.

In 1690 two posthumous works of Johann Hevelius (1611-1687), the *Firmamentum sobiescianum* and *Prodromus astronomiae*, added several new constellations to the list, viz. Canes venatici (the Greyhounds), Lacerta (the Lizard), Leo minor (Little Lion), Lynx, Sextans Uraniae, Scutum or Clypeus Sobieskii (the shield of Sobieski), Vulpecula et Anser (Fox and Goose), Cerberus, Camelopardus (Giraffe), and Monoceros (Unicorn); the last two were originally due to Jacobus Bartschius. In 1679 Augustine Royer introduced the most interesting of the constellations of the southern hemisphere, the Crux australis or Southern Cross. He also suggested Nubes major, Nubes minor, and Liliun, and re-named Canes venatici the river

Jordan, and Vulpecula et Anser the river Tigris, but these innovations met with no approval. The Magellanic clouds, a collection of nebulae, stars and star-clusters in the neighbourhood of the south pole, were so named by Hevelius in honour of the navigator Ferdinand Magellan.

Many other star-groupings have been proposed from time to time; in some cases a separate name has been given to a part of an authoritatively accepted constellation, e.g. Ensis Orionis, the sword of Orion, or an ancient constellation may be subdivided, e.g. Argo (ship) into Argo, Malus (mast), Vela (sails), Puppis (stern), Carina (keel); and whereas some of the rearrangements, which have been mostly confined to the southern hemisphere, have been accepted, many, reflecting nothing but idiosyncrasies of the proposers, have deservedly dropped into oblivion. Nicolas Louis de Lacaille, who made extended observations of the southern stars in 1751 and in the following years, and whose results were embodied in his posthumous *Coelum australe stelliferum* (1763), introduced the following new constellations:—Apparatus sculptoris (Sculptor's workshop), Fornax chemica (Chemical furnace), Horologium (Clock), Reticulus rhomboidalis (Rhomboidal net), Caela sculptoris (Sculptor's chisels), Equuleus pictoris (Painter's easel), Pyxis nautica (Mariner's compass), Antlia pneumatica (Air pump), Octans (Octant), Circinus (Compasses), Norma *alias* Quadra Euclidis (Square), Telescopium (Telescope), Microscopium (Microscope) and Mons Mensae (Table Mountain). Pierre Charles Lemonnier in 1776 introduced Tarandus (Reindeer), and Solitarius; J. J. L. de Lalande introduced Le Messier (after the astronomer Charles Messier) (1776), Quadrans muralis (Mural quadrant) (1795), Globus aerostaticus (Air balloon) (1798), and Felis (the Cat) (1799). Martin Poczobut introduced in 1777 Taurus Poniatovskii; Bode introduced the Honores Frederici (Honours of Frederick) (1786), Telescopium Herschelii (Telescope of Herschel) (1787), Machina electrica (Electrical machine) (1790), Officina typographica (Printing press) (1799), and Lochium funis (Log line); and M. Hell formed the Psalterium Georgianum (George's lute).

The following list gives the names of the constellations now usually employed: they are divided into three groups:—north of the zodiac, in the zodiac, south of the zodiac. Those marked with an asterisk have separate articles.

<i>Northern (28).</i>			
*Andromeda	*Cepheus	*Hercules	Pegasus
*Aquila	*Coma Berenices	Lacerta	*Perseus
*Auriga	*Corona borealis	*Leo minor	*Sagitta
*Boötes	*Cygnus	Lynx	Serpens
Camelopardus	*Delphinus	*Lyra	Triangulum
*Canes venatici	Draco	{ Ophiuchus	*Ursa major
*Cassiopeia	Equuleus	{ *Serpentarius	*Ursa minor
			*Vulpecula et Anser
<i>Zodiacal (12).</i>			
*Aquarius	*Capricornus	*Libra	*Scorpio
*Aries	*Gemini	*Pisces	*Taurus
*Cancer	*Leo	*Sagittarius	*Virgo.
<i>Southern (49).</i>			
Antlia (pneumatica)	Corona australis	Lepus	Pictor (Equuleus pictoris)
Apus	Corvus	Lupus	Piscis australis
*Ara	Crater	Malus	Puppis
Argo	Cruce	Mons Mensae	Recticulum
Caela sculptoris (Caelum)			
*Canis major	Dorado	Microscopium	Sculptor (Apparatus sculptoris)
Canis minor	*Eridanus	Monoceros	Scutum Sobieskii
Carina	Fornax chemica	Musca australis	Sextans
*Centaurus	Grus	Norma	Telescopium
*Cetus	Horologium	Octans	Toucan
Chameleon	*Hydra	*Orion	Triangulum australe
Circinus	Hydrus	Pavo	Vela
Columba Noachi	Indus	Phoenix	Volans (Piscis volans)

**CONSTIPATION** (from Lat. *constipare*, to press closely together, whence also the adjective "costive"), the condition of body when the faeces are unduly retained, or there is difficulty in evacuation, tightness of the bowels (see DIGESTIVE ORGANS; and THERAPEUTICS). It may be due to constitutional peculiarities, sedentary or irregular habits, improper diet, &c. The treatment

varies with individual cases, according to the cause at work, laxatives, dieting, massage, &c., being prescribed.

**CONSTITUENCY** (from "constituent," that which forms a necessary part of a thing; Lat. *constituere*, to create), a political term for the body of electors who choose a representative for parliament or for any other public assembly, for the place or district possessing the right to elect a representative, and for the residents generally, apart from their voting powers, in such a locality. The term is also applied, in a transferred sense, to the readers of a particular newspaper, the customers of a business and the like.

**CONSTITUTION AND CONSTITUTIONAL LAW.** The word constitution (*constitutio*) in the time of the Roman empire signified a collection of laws or ordinances made by the emperor. We find the word used in the same sense in the early history of English law, e.g. the Constitutions of Clarendon. In its modern use constitution has been restricted to those rules which concern the political structure of society. If we take the accepted definition of a law as a command imposed by a sovereign on the subject, the constitution would consist of the rules which point out where the sovereign is to be found, the form in which his powers are exercised, and the relations of the different members of the sovereign body to each other where it consists of more persons than one. In every independent political society, it is assumed by these definitions, there will be found somewhere or other a sovereign, whether that sovereign be a single person, or a body of persons, or several bodies of persons. The commands imposed by the sovereign person or body on the rest of the society are positive laws, properly so called. The sovereign body not only makes laws, but has two other leading functions, viz. those of judicature and administration. Legislation is for the most part performed directly by the sovereign body itself; judicature and administration, for the most part, by delegates. The constitution of a society, accordingly, would show how the sovereign body is composed, and what are the relations of its members *inter se*, and how the sovereign functions of legislation, judicature and administration are exercised. Constitutional law consists of the rules relating to these subjects, and these rules may either be laws properly so called, or they may not—i.e. they may or may not be commands imposed by the sovereign body itself. The English constitutional rule, for example, that the king and parliament are the sovereign, cannot be called a law; for a law presupposes the fact which it asserts. And other rules, which are constantly observed in practice, but have never been enacted by the sovereign power, are in the same way constitutional laws which are not laws. It is an undoubted rule of the English constitution that the king shall not refuse his assent to a bill which has passed both Houses of Parliament, but it is certainly not a law. Should the king veto such a bill his action would be unconstitutional, but not illegal. On the other hand the rules relating to the election of members to the House of Commons are nearly all positive laws strictly so called. Constitutional law, as the phrase is commonly used,

would include all the laws dealing with the sovereign body in the exercise of its various functions, and all the rules, not being laws properly so called, relating to the same subject.

The above is an attempt to indicate the meaning of the phrases in their stricter or more technical uses. Some wider meanings may be noticed. In the phrase constitutional

government, a form of government based on certain principles which may roughly be called popular is the leading idea. Great Britain, Switzerland, the United States, are all constitutional governments in this sense of the word. A country where a large portion of the people has some considerable share in the supreme power would be a constitutional country. On the other hand, constitutional, as applied to governments, may mean stable as opposed to unstable and anarchic societies. Again, as a term of party politics, constitutional has come to mean, in England, not obedience to constitutional rules as above described, but adherence to the existing type of the constitution or to some conspicuous portions thereof,—in other words, conservative.

The ideas associated with constitution and constitutionalism are thus, it will be seen, mainly of modern and European origin. They are wholly inapplicable to the primitive and simple societies of the present or of the former times. The discussion of forms of government occupies a large space in the writings of the Greek philosophers,—a fact which is to be explained by the existence among the Greeks of many independent political communities, variously organized, and more or less democratic in character. Between the political problems of the smaller societies and those of the great European nations there is no useful parallel to be drawn, although the predominance of classical learning made it the fashion for a long time to apply Greek speculations on the nature of monarchy, aristocracy, and democracy to public questions in modern Europe. Representation (*q.v.*), the characteristic principle of European constitutions, has, of course, no place in societies which were not too large to admit of every free citizen participating personally in the business of government. Nor is there much in the politics or the political literature of the Romans to compare with the constitutions of modern states. Their political system, almost from the beginning of empire, was ruled absolutely by a small assembly or by one man.

The impetus to constitutional government in modern times has to a large extent come from England, and it is from English politics that the phrase and its associations have been borrowed. England has offered to the world the one conspicuous example of a long, continuous, and orderly development of political institutions. The early date at which the principle of self-government was established in England, the steady growth of the principle, the absence of civil dissension, and the preservation in the midst of change of so much of the old organization, have given its constitution a great influence over the ideas of politicians in other countries. This fact is expressed in the proverbial phrase—"England is the mother of parliaments." It would not be difficult to show that the leading features of the constitutions now established in other nations have been based on, or defended by, considerations arising from the political history of England.

In one important respect England differs conspicuously from most other countries. Her constitution is to a large extent *unwritten*, using the word in much the same sense as when we speak of unwritten law. Its rules can be found in no written document, but depend, as so much of English law does, on precedent modified by a constant process of interpretation. Many rules of the constitution have in fact a purely legal history, that is to say, they have been developed by the law courts, as part of the general body of the common law. Others have in a similar way been developed by the practice of parliament. Both Houses, in fact, have exhibited the same spirit of adherence to precedent, coupled with a power of modifying precedent to suit circumstances, which distinguishes the judicial tribunals. In a constitutional crisis the House of Commons appoints a committee to "search its journals for precedents," just as the court of king's bench would examine the records of its own decisions. And just as the law, while professing to remain the same, is in process of constant change, so, too, the unwritten constitution is, without any acknowledgment of the fact, constantly taking up new ground.

In contrast with the mobility of an unwritten constitution is the fixity of a constitution written out, like that of the United States or Switzerland, in one authoritative code. The constitu-

tion of the United States, drawn up at Philadelphia in 1787, is contained in a code of articles. It was ratified separately by each state, and thenceforward became the positive and exclusive statement of the constitution. The legislative powers of the legislature are not to extend to certain kinds of bills, *e.g. ex post facto* bills; the president has a veto which can only be overcome by a majority of two-thirds in both Houses; the constitution itself can only be changed in any particular by the consent of the legislatures or conventions of three-fourths of the several states; and finally the judges of the Supreme Court are to decide in all disputed cases whether an act of the legislature is permitted by the constitution or not.

The constitution of the United States is the supreme law of the land as to the matters which it embraces. The constitution of each state is the supreme law of the state, except so far as it may be controlled by the constitution of the United States. Every statute in conflict with the constitution to which it is subordinate is void so far as this conflict extends. If it concerns only a distinct and separable part of the statute, that part only is void. Every court before which a statutory right or defence is asserted has the power to inquire whether the statute in question is or is not in conflict with the paramount constitution. This power belongs even to a justice of the peace in trying a cause. He sits to administer the law, and it is for him to determine what is the law. Inferior courts commonly decline to hold a statute unconstitutional, even if there may appear to be substantial grounds for such a decision. The presumption is always in favour of the validity of the law, and they generally prefer to leave the responsibility of declaring it void to the higher courts.

The judges of the state courts are bound by their oath of office to support the constitution of the United States. They have an equal right with those of the United States to determine whether or how far it affects any matter brought in question in any action. So, vice versa, the judges of the United States courts, if the point comes up on a trial before them, have the right to determine whether or how far the constitution of a state invalidates a statute of the state. They, however, are ordinarily bound to follow the views of the state courts on such a question. They are not bound by any decision of a state court as to the effect of the constitution of the United States on a state statute or any other matter. This judicial power of declaring a statute void because unconstitutional has been not infrequently exercised, from the time when the first state constitutions were adopted.

Juries in criminal causes are sometimes made by American statutes or recognized by American practice as judges of the law as well as the fact. The better opinion is that this does not make them judges of whether a law on which the prosecution rests violates the paramount constitution and is therefore void (*United States v. Callender*, Wharton's *State Trials*, 688; *State v. Main*, 69 Connecticut Reports, 123, 128).

If a state court decides a point of constitutional law, set up under the constitution of the United States, against the party relying upon it, and this decision is affirmed by the state court of last resort, he may sue out a writ of error, and so bring his case before the Supreme Court of the United States. If the state decision be in his favour, the other side cannot resort to like proceedings.

A decree of the Supreme Court of the United States on a point of construction arising under the constitution of the United States settles it for all courts, state and national.

The salient characteristic of the United States constitution is, perhaps, its formidable apparatus of provisions against change; and, in fact, only 15 constitutional amendments had been adopted from 1789 up to 1909, the last being in 1870. In the same period the unwritten constitution of England has made a most marked advance, chiefly in the direction of democratizing the monarchy, and diminishing the powers of the House of Lords. The House of Commons has continuously asserted its legislative predominance, and has reduced the other House to the position of a revising chamber, which in the last resort, however, can produce a legislative deadlock, subject to the results of a new general

election (see PARLIAMENT). And the cabinet, which depends on the support of the House of Commons, has become more and more the executive council of the realm. One conspicuous feature of the English constitution, by which it is broadly distinguished from written or artificial constitutions, is the presence throughout its entire extent of legal fictions. The influence of the lawyers on the progress of the constitution has already been noticed, and is nowhere more clearly shown than in this peculiarity of its structure. As in the common law, so in the constitution, change has been effected in substance without any corresponding change in terminology. There is hardly one of the phrases used to describe the position of the crown which can be understood in its literal sense, and many of them are currently accepted in more senses than one. The American constitution of 1789 reproduced, however, in essentials, and with necessary modifications, the contemporary British model, and, where it did so, has preserved the old conception of what was then the British system of government. The position and powers of the president were a fair counterpart of the royal prerogative of that day; the two houses of Congress corresponded sufficiently well to the House of Lords and the House of Commons, allowing for the absence of the elements of hereditary rank and territorial influence. While the English constitution has changed much, the American constitution has changed very little in these respects. Allowing for the more democratic character of the constituencies, the organization of the supreme power in the United States is nearer the English type of the 18th century—is, in fact, less elastic than in the United Kingdom.

On the other hand, it is not uncommon to misinterpret the rigidity of the United States constitution, from a regard rather to the theory which its text suggests than to the practical working of the machine. For the letter of the constitution has to some extent been modified, if not technically amended, in various respects by judicial interpretation, and by use and wont (e.g. as regards the election of the president). This side of the matter may be studied in C. G. Tiedeman's work cited below. Moreover, even in respect of the 18th-century British character attaching to the constitution, as drawn up in 1787, it has to be remembered that this was not taken direct from England. As several American constitutional historians have elaborately shown (e.g. A. C. McLaughlin, in *The Confederation and the Constitution*, 1905), the English idea had already been developed in various directions during the preceding colonial period, and the constitution really represented the English constitutional usage as known in America, into which the Philadelphia convention introduced new features corresponding to the prevailing civil conditions or suggested by English analogy. It is important to emphasize this point, since the resemblance of the American constitution of 1789 to the contemporary English constitution has sometimes been exaggerated; but the fact remains that the written constitution has been less susceptible of development than the unwritten.

Between England and some other constitutional countries a difference of much constitutional importance is to be found in the terms on which the component parts of the country were brought together. All great societies have been produced by the aggregation of small societies into larger and larger groups. In England the process of consolidation was completed before the constitution settled down into its present form. In the United States, on the other hand, in Switzerland, and in Germany the constitution is in form an alliance among a number of separate states, each of which may have a constitution and laws of its own for local purposes. In federal governments it remains a question how far the independence of individual states has been sacrificed by submission to a constitution. In the United States constitutional progress is hampered by the necessity thus created of having every amendment ratified by the separate vote of three-fourths of the states.

See also GOVERNMENT; SOVEREIGNTY; CABINET; PREROGATIVE, &c., and the section on Government or Constitution in the articles on the various countries. The standard work on the English constitution is Sir William Anson's *Law and Custom of the Constitution* (1st ed. 1886; 3rd ed. 1909); see also A. L. Lowell, *The Government*

of England (1908); W. Bagehot, *The English Constitution*; S. Low, *The Governance of England* (1904); A. V. Dicey, *The Law of the Constitution* (7th ed. 1909); W. Stubbs, *Constitutional History of England* (1878); R. Gneist, *History of the English Constitution* (Engl. trans. 1886); J. Macy, *The English Constitution* (New York, 1897); E. W. Ridges, *Constitutional Law of England* (1905); F. W. Maitland, *Constitutional History of England* (1908); G. B. Adams and H. M. Stephens, *Select Documents of English Constitutional History* (New York, 1901). For America, see C. E. Stevens, *Sources of the Constitution of the United States* (London and New York, 1894); G. T. Curtis, *Constitutional History of the United States* (2 vols., New York, 1889-1896); T. M. C. Cooley, *General Principles of Constitutional Law in the United States* (Boston, 1880; 3rd ed. 1898); S. G. Fisher, *Evolution of the Constitution of the United States* (Philadelphia, 1897); J. I. C. Hare, *American Constitutional Law* (2 vols., Boston, 1889); J. F. Jameson (ed.), *Essays on the Constitutional History of the United States in the Formative Period, 1775-1789* (Boston, 1889); W. M. Meigs, *Growth of the Constitution in the Federal Convention of 1787* (Philadelphia, 1900); and C. G. Tiedeman, *Unwritten Constitution of the United States* (New York, 1890). Also A. L. Lowell, *Government and Parties in Continental Europe* (2 vols., 1896); W. F. Dodd, *Modern Constitutions* (2 vols., Chicago, 1909), a collection of the fundamental laws of twenty-two of the most important countries.

"CONSTITUTION OF ATHENS" (*Ἀθηναίων πολιτεία*), a work attributed to the philosopher Aristotle (384-322 B.C.), forming one of a series of *Constitutions* (*πολιτείας*), 158 in number, which treated of the institutions of the various states in the Greek world. It was extant until the 7th century of our era, or to an even later date, but was subsequently lost. A copy of this treatise, written in four different hands upon four rolls of papyrus, and dating from the end of the 1st century A.D., was discovered in Egypt, and acquired by the trustees of the British Museum, for whom it was edited by F. G. Kenyon, assistant in the manuscript department, and published in January 1891. Some very imperfect fragments of another copy had been acquired by the Egyptian Museum at Berlin, and were published in 1880.

*Authorship.*—It may be regarded as now established that the treatise discovered in Egypt is identical with the work upon the constitution of Athens that passed in antiquity under the name of Aristotle. The evidence derived from a comparison of the British Museum papyrus with the quotations from the lost work of Aristotle's which are found in scholiasts and grammarians is conclusive. Of fifty-eight quotations from Aristotle's work, fifty-five occur in the papyrus. Of thirty-three quotations from Aristotle, which relate to matters connected with the constitution, or the constitutional history of Athens, although they are not expressly referred to the *Ἀθηναίων πολιτεία*, twenty-three are found in the papyrus. Of those not found in the papyrus, the majority appear to have come either from the beginning of the treatise, which is wanting in the papyrus, or from the latter portion of it, which is mutilated. The coincidence, therefore, is as nearly as possible complete. It may also be regarded as established by internal evidence that the treatise was composed during the interval between Aristotle's return to Athens in 335 B.C. and his death in 322. There are two passages which give us the latter year as the *terminus ad quem*, viz. c. 42. 1 and c. 62. 2. In the former passage the democracy which is about to be described is spoken of as the "present constitution" (*ἡ νῦν κατάσταση τῆς πολιτείας*). The democratic constitution was abolished, and a timocracy established, on the surrender of Athens to Antipater, at the end of the Lamian War, in the autumn of 322. At the same time Samos was lost; it is still reckoned, however, among the Athenian possessions in the latter passage. On the other hand, the foreign possessions of Athens are limited to Lemnos, Imbros, Scyros, Delos and Samos. This could only apply to the period after Chaeronea (338 B.C.). In c. 61. 1, again, mention is made of a special Strategus *ἐπὶ τὰς συμμορίας*; but it can be proved from inscriptions that down to the year 334 the generals were collectively concerned with the symmories. Finally, in c. 54. 7 an event is dated by the archonship of Cephisophon (329). We thus get the years 329 and 322 as fixing the limits of the period to which the composition of the work must be assigned. It follows that, whether it is by Aristotle or not, its date is later than that of the *Politics*, in which there is no reference to any event subsequent to the death of Philip in 336.

The only question as to authorship that can fairly be raised is the question whether it is by Aristotle or by a pupil; *i.e.* as to the sense in which it is “Aristotelian.” The argument on the two sides may be summarized as follows:—

*Against.*—(i.) The occurrence of non-Aristotelian words and phrases and the absence of turns of expression characteristic of the undisputed writings of Aristotle. (ii.) The occurrence of statements contradictory of views found in the *Politics*; *e.g.* c. 4 (Constitution of Draco) compared with *Pol.* 1274 b 15 (Δράκωντος νόμοι μὲν εἰσι, πολιτεία δ’ ὑπαρχούση τοῖς νόμοις ἔθηκεν); c. 8. 1 (the archons appointed by lot out of selected candidates) compared with *Pol.* 1274 a 17, and 1281 b 31 (the archons elected by the *demoi*); c. 17. 1 (total length of Peisistratus’ reign, 19 years) compared with *Pol.* 1315 b 32 (total length, 17 years); c. 21. 6 (Cleisthenes left the clan and phratries unaltered) compared with *Pol.* 1319 b.20 (Cleisthenes increased the number of the phratries); c. 21. 2 and 4 compared with *Pol.* 1275 b 37 (different views as to the class admitted to citizenship by Cleisthenes). It will be observed that the instances quoted relate to the most famous names in the early history of Athens, *viz.* Draco, Solon, Peisistratus and Cleisthenes. (iii.) Arguments drawn from the style, composition and general character of the work, which are alleged to be unworthy of the author of the undoubtedly genuine writings. There is no sense of proportion (contrast the space devoted to Peisistratus and his sons, or to the Four Hundred and the Thirty, with the inadequate treatment of the period between the Persian and Peloponnesian Wars); there is a lack of historical insight and an uncritical acceptance of erroneous views; and the anecdotic element is unduly prominent. These considerations led several of the earlier critics to deny the Aristotelian authorship, *e.g.* the editors of the Dutch edition of the text, van Herwerden and van Leeuwen; Rühl, Cauer and Schvarcz in Germany; H. Richards and others in England.

*For.*—(i.) The consensus of antiquity. Every ancient writer who mentions the *Constitution* attributes it to Aristotle, while no writer is known to have questioned its genuineness. (ii.) The coincidence of the date assigned to its composition on internal grounds with the date of Aristotle’s second residence in Athens. (iii.) Parallelisms of thought or expression with passages in the *Politics*; *e.g.* c. 16. 2 and 3 compared with *Pol.* 1318 b 14 and 1319 a 30; the general view of Solon’s legislation compared with *Pol.* 1296 b 1; c. 27. 3 compared with *Pol.* 1274 a 9. To argument (i.) against the authorship, it is replied that the *Constitution* is an historical work, intended for popular use; differences in style and terminology from those of a philosophical treatise, such as the *Politics*, are to be expected. To argument (ii.) it is replied that, as the *Constitution* is a later work than the *Politics*, a change of view upon particular points is not surprising. These considerations have led the great majority of writers upon the subject to attribute the work to Aristotle himself. On this side are found Kenyon and Sandys among English scholars, and in Germany, Wilamowitz, Blass, Gilbert, Bauer, Bruno Keil, Busolt, E. Meyer, and many others. On the whole, it can hardly be doubted that the view which is supported by so great a weight of authority is the correct one. The arguments advanced on the other side are not to be lightly set aside, but they can scarcely outweigh the combination of external and internal evidence in favour of the attribution to Aristotle. An attentive study of the parallel passages in the *Politics* will go a long way towards carrying conviction. It is true that a series such as the *Constitutions* might well be entrusted to pupils working under the direction of their master. It is also true, however, that the *Constitution of Athens* must have been incomparably the most important of the series and the one that would be most naturally reserved for the master’s hand. There are no traces in the treatise either of variety of authorship or of incompleteness, though there are evidences of interpolation.

*Contents.*—The treatise consists of two parts, one historical, and the other descriptive. The first forty-one chapters compose the former part, the remainder of the work the latter. The first part comprised an account of the original constitution of Athens,

and of the eleven changes through which it successively passed (*see c. 41*). The papyrus, however, is imperfect at the beginning (the manuscript from which it was copied appears to have been similarly defective), the text commencing in the middle of a sentence which relates to the trial and banishment of the Alcmeonidae for their part in the affair of Cylon. The missing chapters must have contained a sketch of the original constitution, and of the changes introduced in the time of Ion and Theseus.

The following is an abstract of Part I. in its present form. Chapters 2, 3, description of the constitution before the time of Draco. 4, Draco’s constitution. 5-12, reforms of Solon. 13, party feuds after the legislation of Solon. 14-19, the rule of Peisistratus and his sons. 20, 21, the reforms of Cleisthenes. 22, changes introduced between Cleisthenes and the invasion of Xerxes. 23, 24, the supremacy of the Areopagus, 479-461 B.C. 25, its overthrow by Ephialtes. 26, 27, changes introduced in the time of Pericles. 28, the rise of the demagogues. 29-33, the revolution of the Four Hundred. 34-40, the government of the Thirty. 41, list of the successive changes in the constitution. It may be noted that the reforms of Solon, the tyranny of Peisistratus and his sons, and the revolutions of the Four Hundred and the Thirty, together occupy considerably more than two-thirds of Part I.

Part II. describes the constitution as it existed at the period of the composition of the treatise (329-322 B.C.). It begins with an account of the conditions of citizenship and of the training of the *ephebi* (citizens between the ages of 18 and 20). In chapters 43-49 the functions of the Council (*βουλή*) and of the officials who act in concert with it are described. 50-60 deal with the officials who are appointed by lot, of whom the most important are the nine Archons, to whose functions five chapters (55-59) are devoted. The military officers, who come under the head of elective officials, form the subject of c. 61. With c. 63 begins the section on the Law-courts, which occupied the remainder of the *Constitution*. This portion, with the exception of c. 63, is fragmentary in character, owing to the mutilated condition of the fourth roll of the papyrus on which it was written. It will thus be seen that the subjects which receive fullest treatment in Part II. are the Council, the Archons and the Law-courts. The Ecclesia, on the other hand, is dealt with very briefly, in connexion with the *prytaneis* and *proedri* (cc. 43, 44).

*Sources.*—The labours of several workers in this field, notably Bruno Keil and Wilamowitz, have rendered it comparatively easy to form a general estimate of Aristotle’s indebtedness to previous writers, although problems of great difficulty are encountered as soon as it is attempted to determine the precise sources from which the historical part of the work is derived. Among these sources are unquestionably Herodotus (for the tyranny of Peisistratus, and for the struggle between Cleisthenes and Isagoras), Thucydides (for the episode of Harmodius and Aristogeiton, and for the Four Hundred), Xenophon (for the Thirty), and the poems of Solon. There is now among critics a general consensus in favour of the view that the most important of his sources was the *Atthis* of Androtion, a work published in all probability only a few years earlier than the *Constitution*; in any case, after the year 346. From it are derived not only the passages which are annalistic in character and read like excerpts from a chronicle (*e.g.* c. 13. 1, 2; c. 22; c. 26. 2, 3), but also most of the matter common to the *Constitution* and to Plutarch’s *Solon*. The coincidences with Plutarch, which are often verbal, and extend to about 50 lines out of 170 in cc. 5-11 of the *Constitution*, can best be explained on the hypothesis that Hermippus, the writer followed by Plutarch, used the same source as Aristotle, *viz.* the *Atthis* of Androtion. Androtion is probably closely followed in the account of the pre-Draconian constitution, and to him appear to be due the explanation of local names (*e.g.* χωρίον ἀρελές), or proverbial expressions (*e.g.* τὸ μὴ φουλακρινεῖν), as well as the account of “Strategems” such as that of Themistocles against the Areopagus (c. 25) or that employed by Peisistratus in order to disarm the people (c. 15. 4). Whether the anecdotes, which are a conspicuous feature in the *Constitution*, should be referred to the same source is more open to doubt. It is also generally agreed that among the sources was a work, written towards the end of the 5th century B.C., by an author of oligarchical sympathies, with the object of defaming the character and policy of the heroes of the democracy. This source can be traced in passages such as c. 6. 2 (Solon turning the Seisachtheia to the profit of himself and his friends), 9. 2 (obscurity of Solon’s laws intentional, cf. c. 35. 2),



27. 4 (Pericles' motive for the introduction of the dicasts' pay). But while the object (*οἱ βουδόμενοι βλασφημείν*, c. 6) and the date of this oligarchical pamphlet (for the date cf. Plutarch's *Solon*, c. 15 *ὁ περὶ Κόνωνα καὶ Κλειτίαν καὶ Ἰππύωνος*, which points to a time when Conon, Alcibiades and Callias were prominent in public life) are fairly certain, the authorship is quite uncertain, as is also its relationship to another source of importance, viz. that from which are derived the accounts of the Four Hundred and the Thirty. The view taken of the character and course of these revolutions betrays a strong bias in favour of Theramenes, whose ideal is alleged to have been the *πάτριος πολιτεία*. It has been maintained, on the one hand, that this last source (the authority followed in the accounts of the Four Hundred and the Thirty) is identical with the oligarchical pamphlet, and, on the other, that it is none other than the *Atthis* of Androtion. The former hypothesis is improbable. In favour of the latter two arguments may be adduced. In the first place, Androtion's father, Andron, was one of the Four Hundred, and took Theramenes' side. Secondly, the precise marks of time, which are characteristic of the *Atthis*, are conspicuous in these chapters. In view, however, of the fact that Androtion in his political career showed himself not only a democrat, but a democrat of the extreme school, the hypothesis must be pronounced untenable.

*Value*.—It is by no means easy to convey a just impression of the value of Aristotle's work as an authority for the constitutional history of Athens. In all that relates to the practice of his own day Aristotle's authority is final. There can be no question, therefore, as to the importance, or the trustworthy character, of the Second Part. But even here a caution is necessary. It must be remembered that its authority is final for the 4th century only, and that we are not justified in arguing from the practice of the 4th century to that of the 5th, unless corroborative evidence is available. In the First Part, however, where he is treating of the institutions and practice of a past age, Aristotle's authority is very far from being final. An analysis of this part of the work discloses his dependence, in a remarkable degree, upon his sources. Occasionally he compares, criticizes or combines; as a rule he adheres closely to the writer whom he is using. There is no evidence, either of independent inquiry, or of the utilization of other sources than literary ones. Where "original documents" are quoted, or referred to, as e.g. in the history of the Four Hundred, or of the Thirty, it is probable that he derived them from a previous writer. For the authority of Aristotle we must substitute, therefore, the authority of his sources; i.e. the value of any particular statement will vary with the character of the source from which it comes. For the history of the 5th century the passages which come from Androtion's *Atthis* carry with them a high degree of authority. It by no means follows, however, that a statement relating to earlier times is to be accepted simply because it is derived from the same source. And in passages which are derived from other sources than the *Atthis* a much lower degree of authority can be claimed, even for statements relating to the 5th century. The supremacy of the Areopagus after the Persian Wars, the policy attributed to Aristides (c. 24), and the association of Themistocles with Ephialtes, are cases in point. Nor must the reader expect to find in the *Constitution* a great work, in any sense of the term. The style, it is true, is simple and clear, and the writer's criticisms are sensible. But the reader will look in vain for evidence of the philosophic insight which makes the *Politics*, even at the present day, the best text-book of political philosophy. It is perhaps hardly too much to say that there is not a single great idea in the whole work. He will look in vain, too, for any consistent view of the history of the constitution as a whole, or for any adequate account of its development. He will find occasional misunderstandings of measures, and confusions of thought. There are appreciations which it is difficult to accept, and inaccuracies which it is difficult to pardon. There are contradictions which the author has overlooked, and there are omissions which are unaccountable. Yet, in spite of such defects,

the importance of the *Constitution* can hardly be exaggerated. Its recovery has rendered obsolete any history of the Athenian constitution that was written before the year 1891. Before this date our knowledge was largely derived from the statements of scholiasts and lexicographers which had not seldom been misunderstood. The recovery of the *Constitution* puts us for the first time in possession of the evidence. To appreciate the difference that has been made by its recovery, it is only necessary to compare what we now know of the reforms of Cleisthenes with what we formerly knew. It is much of it evidence that needs a careful process of weighing and sifting before it can be safely used; but it is, as a rule, the best, or the only evidence. The First Part may be less trustworthy than the Second; it is not less indispensable to the student of constitutional history.

**BIBLIOGRAPHY**.—A conspectus of the literature of the *Constitution* complete down to the end of 1892 is given in Sandys p. lxxvii., and, though less complete, down to the beginning of 1895 in Busolt, *Griechische Geschichte*, 2nd ed. vol. ii. p. 15. In the present article only the most important editions, works or articles are mentioned. Editions of the text: *Ediitio princeps*, ed. by F. G. Kenyon, 30th January 1891, with commentary. Autotype facsimile of the papyrus (1891). *Aristotelis πολιτεία Ἀθηνῶν*, ed. G. Kaibel et U. von Wilamowitz-Moellendorff (Berlin, Weidmann, 1891). *Aristotelis qui fertur Ἀθηνῶν πολιτεία* recensuerunt H. van Herwerden et J. van Leeuwen (Leiden, 1891). Teubner text, ed. by F. Blass (Leipzig, 1892). Edition of the text without commentary by Kenyon.

Most of these have passed through several editions. The fullest commentary is that contained in the edition of the text by J. E. Sandys (London, 1893). The best translations are those of Kenyon, in English, and of Kaibel and Kiessling, in German.

Works dealing with the subject: Bruno Keil, *Die Solonische Verfassung nach Aristoteles* (Berlin, 1892); G. Gilbert, *Constitutional Antiquities of Sparta and Athens* (Eng. trans., 1895); U. von Wilamowitz-Moellendorff, *Aristoteles und Athen* (2 vols., Berlin, 1893), a work of great importance, in spite of many unsound conclusions; E. Meyer, *Forschungen*, vol. ii. pp. 406 ff. (the section dealing with the Four Hundred is especially valuable). Articles: R. W. Macan, *Journal of Hellenic Studies* (April 1891); R. Nissen, *Rheinisches Museum* (1892), p. 161; G. Busolt, *Hermes* (1898), pp. 71 ff.; O. Seeck, "Quellenstudien zu des Aristoteles' Verfassungsgeschichte Athens," in Lehmann's *Beiträge zur alten Geschichte*, vol. iv. pp. 164 and 270. (E. M. W.)

**CONSUE TUDINARY** (Med. Lat. *consuetudinarius*, from *consuetudo*, custom), customary, a term used especially of law based on custom as opposed to statutory or written law. As a noun "consuetudinary" (Lat. *consuetudinarius*, sc. *liber*) is the name given to a ritual book containing the forms and ceremonies used in the services of a particular monastery, cathedral or religious order.

**CONSUL** (in Gr. generally *ὑπατος*, a shortened form of *στρατηγὸς ὑπατος*, i.e. *praetor maximus*), the title borne by the two highest of the ordinary magistrates of the whole Roman community during the republic. In the imperial period these magistrates had ceased practically to be the heads of the state, but their technical position remained unaltered. (For the modern commercial office of consul see the separate article below.)

The consulship arose with the fall of the ancient monarchy (see further **ROME: History**, II. "The Republic"). The Roman reverence for the abstract conception of the magistracy, as expressed in the imperium and the auspicia, led to the preservation of the regal power weakened only by external limitations. The two new officials who replaced the king bore the titles of leaders (*praetores*) and of judges (*judices*; cf. Cicero, *De legibus*, iii. 3. 8, "regio imperio duo sunt ique a praeceundo iudicando . . . praetores iudices . . . appellamini"). But the new fact of collegueship caused a third title to prevail, that of *consules* or "partners," a word probably derived from *consalio* or the analogy of *praesul* and *exul* (Mommson, *Staatsrecht*, ii. p. 77, n. 3). This first example of the collegiate principle assumed the form that soon became familiar in the Roman commonwealth. Each of the pair of magistrates could act up to the full powers of the imperium; but the dissent of his colleague rendered his decision or his action null and void. At the same time the principle of a merely annual tenure of office was insisted on. The two magistrates at the close of their year of office were bound to transmit their power to successors; and these successors whom they nominated were obliged to seek the suffrages of the



people. The only body known to us as electing the consuls during the republican period was the *comitia centuriata* (see COMITIA). The consulate was originally confined to patricians. During the struggle for higher office that was waged between the orders the office was suspended on fifty-one occasions between the years 444 and 367 B.C. and replaced by the military tribunate with consular power, to which plebeians were eligible. The struggle was brought to an end by the Licinio-Sextian laws of 367 B.C., which enacted that one consul must be a plebeian (see PATRICIANS).

Most of the internal history of Rome down to the beginning of the third century B.C. consists in a series of attacks, whether intentional or accidental, on the power of the executive. As the consuls are the sole representatives of higher executive authority in early times, this history is one of a progressive decline in the originally wide and arbitrary powers of the office. Their right of summary criminal jurisdiction was weakened by the successive laws of appeal (*provocatio*); their capacity for interpreting the civil law at their pleasure by the publication of the Twelve Tables and the Forms of Action. The growth of the tribunate of the plebs hampered their activity both as legislators and as judges. They surrendered the duties of registration to the censors in 443 B.C., and the rights of civil jurisdiction and control over the market and police to the praetor and the curule aediles in 367 B.C.

The result of these limitations and of this specialization of functions in the community was to leave the consuls with less specific duties at home than any magistrates in the state. But the absence of specific functions may be of itself a sign of a general duty of supervision. The consuls were in a very real sense the heads of the state. Polybius describes them as controlling the whole administration (Polyb. vi. 12 *πασῶν ἐστὶ κύριοι τῶν δημοσίων πράξεων*). This control they exercised in concert with the senate, whose chief servants they were. It was they who were the most regular consultants of this council, who formulated its decrees as edicts, and who brought before the people legislative measures which the senate had approved. It was they also who represented the state to the outer world and introduced foreign envoys to the senate. The symbols of their presidency were manifold. It was marked by the twelve lictors (*q.v.*), a number permitted to no other ordinary magistrate, by the fact that the first act of newly-admitted consuls was to take the auspices, their second to summon the senate, and by the use of their names for dating the year. The consulate was, indeed, as Cicero expresses it, the culminating point in an official career ("Honorum populi finis est consulatus," Cic. *Pro Plancio*, 25. 60).

In the domestic sphere the consuls retained certain powers of jurisdiction. This jurisdiction was either (i.) administrative or (ii.) criminal. (i.) Their administrative jurisdiction was sometimes concerned with financial matters such as pecuniary claims made by the state and individuals against one another. They acted in these matters in the periods during which the censors were not in office. We also find them adjudicating in disputes about property between the cities of Italy. (ii.) Their criminal jurisdiction was of three kinds. In the first place it was their duty, before the development of the standing commissions which originated in the middle of the 2nd century B.C., to set in motion the criminal law against offenders for the cognizance of ordinary, as opposed to political, crimes. The reference of such cases to the assembly of the people was effected through their quaestors (see QUAESTOR). Secondly, when the people and senate, or the senate alone, appointed a special commission (see SENATE), the commissioner named was often a consul. Thirdly, we find the consul conducting a criminal inquiry raised by a point of international law. It is possible that in this case his advising body (*consilium*) was composed of the *fetiales* (see HERALD, *ad fin.*). (Cicero, *De republica*, iii. 18. 28; Mommsen, *Staatsrecht*, ii. p. 112, n. 3).

During the greater part of the republic the consuls were recognized as the heads of the administration abroad as well as at home. It thus became necessary that departments of administration (*provinciae*) should be determined and assigned. The

method of assignment varied. The least usual device was for one consul to take the field at the head of an army, while the other remained at home to transact the civil business of state. More often foreign wars demanded the attention of both consuls. In this case the regular army of four legions was usually divided between them. When it was necessary that both armies should co-operate, the principle of rotation was adopted, each consul having the command for a single day—a practice which may be illustrated by the events preceding the battle of Cannae (Polybius iii. 110; Livy xxii. 41). During the great period of conquest from 264 to 146 B.C. Italy was generally one of the consular "provinces," some foreign country the other; and when at the close of this period Italy was at peace, this distinction approximated to one between civil and military command. The consuls settled their departments amongst themselves by agreement or by lot (*comparatio, sortitio*), the power of declaring what should be the consular *provinciae* was usurped by the senate (see SENATE), and a *lex Sempronia* passed by C. Gracchus, probably in 122 B.C., ordained that the two consular provinces should be declared before the election of the consuls. At this time the consuls entered office on the 1st of January (a practice which commenced in 153 B.C.), and their military command began on the 1st of March. They could hold this military command until they were superseded in the following March, and thus their tenure of power was practically raised to fourteen months. But meanwhile the home officials invested with the imperium had proved insufficient for the military needs of the empire, and the system of prolonging the command (*prorogatio imperii*) had been growing up (see PROVINCE). The consul whose command had been prolonged now served abroad as proconsul. It is probable that Sulla in his legislation of 81 B.C. did something to stereotype this system. Certainly the government by pro-magistrates becomes the rule after this period (cf. Cicero, *De natura deorum*, ii. 3. 9; *De divinatione*, ii. 36. 76, 77), although there are several instances of consuls assuming the active command of provinces between the years 74 and 55 B.C. (Mommsen, *Rechtsfrage*, p. 30), and Cicero declares that the consul has a right to approach every province ("consules, quibus more majorum concessum est vel omnes adire provincias," Cicero, *Ad Atticum*, viii. 15. 3). Certainly in theory the provinces were still regarded as "consular," not "proconsular," and were technically, although not practically, held from the 1st of March of the consul's tenure of office at Rome (cf. Cicero, *De provinciis consularibus*, 15. 37; Mommsen, *Rechtsfrage*, *passim*). It was not until the *lex Pompeia* of 52 B.C. (Dio Cassius xl. 56) had established a five years' interval between home and foreign command that the theory of the *prorogatio imperii* vanished and the proconsulate became a separate office.

Since the theory of the persistence of the republican constitution was of the essence of the Principate, the consuls necessarily lost little of their outward position and dignity under the rule of the Caesars. The consulship was the only office in which a citizen, other than a member of the imperial house, might have the princeps as a colleague, and in the interval between the death or deposition of one princeps and the appointment of another the consuls resumed their normal position as the heads of the state (cf. Herodian ii. 12). As the presidents of the senate, who after A.D. 14 elected them to their office, they were the chief personal representatives of those elements of sovereignty that were supposed to attach to that body, and they directed that high criminal jurisdiction which the senate of this period assumed (see SENATE). A restored power of jurisdiction is indeed one of the features of their position during this time, and it is probable that the civil appeals which came to the senate were delegated to the consuls. They also acted for a time as delegates to the princeps in matters of Chancery jurisdiction such as trusts and guardianship (Mommsen, *Staatsrecht*, ii. p. 103). The consulship was also a preparation for certain high commands, such as the government of certain public and imperial provinces (see PROVINCE) and the praefecture of the city. It was probably due to the fact that the consulship was such a prize, and perhaps also to the expense imposed on the office by its association with the

celebration of games (Dio Cassius lvi. 46, lix. 20) that the tenure was progressively shortened. In the early principate the consuls hold office for six months, later for four to two months (Mommsen, *Staatsrecht*, ii. pp. 84-87). The consuls appointed for the 1st of January were called *ordinarii*, the others *suffecti*; and the whole year was dated by the names of the former.

This distinction continued in the Empire that was founded by Diocletian and Constantine. The *ordinarii* were nominated by the emperor, the *suffecti* were nominated by the senate, and their appointment was ratified by the emperor. The consulship was still the greatest dignity which the Empire had to bestow; and the pomp and ceremony of the office increased in proportion to the decline in its actual power. The entry of the consuls on office was celebrated by a great procession, by games given to the people, by a distribution of gifts, such as the ivory diptychs, a long series of which has been preserved. But the senate, over which they presided until the time of Justinian, was little more than the municipal council of the city of Rome; and the justice which they meted out had dwindled down to the formal and uncontested acts of manumission and the granting of guardians. Sometimes there was a consul of the West at Rome and a consul of the East at Constantinople; at other times both consuls might be found in either capital. The last consul born in a private station was Basilius in the East in A.D. 541. But the emperors continued to bear the title for some time longer.

**AUTHORITIES.**—Mommsen, *Römisches Staatsrecht*, ii. pp. 74-140 (3rd ed., Leipzig, 1887); Herzog, *Geschichte und System der römischen Staatsverfassung*, i. p. 688 foll., 827 foll. (Leipzig, 1884, &c.); Lange, *Römische Altertümer*, i. p. 524 foll. (Berlin, 1856, &c.); Schiller, *Staats- und Rechtsaltertümer*, p. 53 foll. (Munich, 1893, *Handbuch der klassischen Altertums-Wissenschaft*, von Dr Iwan von Müller); Daremberg-Saglio, *Dictionnaire des antiquités grecques et romaines*, i. 1455 foll. (1875, &c.); De Ruggiero, *Dizionario epigrafico di antichità Romane*, ii. 679 foll., 868 foll. (Rome, 1886, &c.); Pauly-Wissowa, *Realencyclopädie*, iv. 1112 foll. (new edition, Stuttgart, 1893, &c.).

For the consular diptychs, cf. besides Daremberg-Saglio, *l.c.*, Gori, *Thesaurus veterum diptychorum* (Florence, 1759), and Labarte, *Histoire des arts industriels au moyen âge*, i. p. 10 foll., 190 foll. (1st ed., Paris, 1864). (A. H. J. G.)

**CONSUL**, a public officer authorized by the state whose commission he bears to manage the commercial affairs of its subjects in a foreign country, and formally permitted by the government of the country wherein he resides to perform the duties which are specified in his commission, or *lettre de provision*. (For the ancient magisterial office of consul see separate article above.)

A consul, as such, is not invested with any diplomatic character, and he cannot enter on his official duties until a rescript, termed an *exequatur* (sometimes a mere countersign endorsed on the commission), has been delivered to him by the authorities of the state to which his nomination has been communicated by his own government. This *exequatur*, called in Turkey a *berat*, may be revoked at any time at the discretion of the government where he resides. The status of consuls commissioned by the Christian powers to reside in Mahomedan countries, China, Korea, Siam, and, until 1899, in Japan, and to exercise judicial functions in civil and criminal matters between their own countrymen and strangers, is exceptional to the common law, and is founded on special conventions or capitulations (*q.v.*).

The title of consul, in the sense in which it is used in international law, is derived from that of certain magistrates, in the cities of medieval Italy, Provence and Languedoc, charged with the settlement of trade disputes whether by sea or land (*consules mercatorum, consules artis maris, &c.*)<sup>1</sup> With the growth of trade it early became convenient to appoint agents with similar powers in foreign parts, and these often, though not invariably, were styled consuls (*consules in partibus ultramarinis*).<sup>2</sup> The

<sup>1</sup> The title of consul was borne by the chief municipal officers of several cities of the south of France during the middle ages and up to the Revolution. The name was not due to their being the successors of the chiefs of the Roman *municipia*. They were members of the governing body known as the *consulat*, and in Latin documents are sometimes styled *consiliarii*, i.e. councillors. The *consulat* itself is not traceable beyond the 12th century.

<sup>2</sup> Particular quarters of mercantile cities were assigned to foreign traders and were placed under the jurisdiction of their own magistrates, variously styled syndics, provosts (*praepositi*), échevins

earliest foreign consuls were those established by Genoa, Pisa, Venice and Florence, between 1098 and 1196, in the Levant, at Constantinople, in Palestine, Syria and Egypt. Of these the Pisan agent at Constantinople bore the title of consul, the Venetian that of *baylo* (*q.v.*). In 1251 Louis IX. of France arranged a treaty with the sultan of Egypt under which French consuls were established at Tripoli and Alexandria, and Du Cange cites a charter of James of Aragon, dated 1268, granting to the city of Barcelona the right to elect consuls *in partibus ultramarinis*, &c. The free growth of the system was, however, hampered by commercial and dynastic rivalries. The system of French foreign consulships, for instance, all but died out after the crushing of the independent life of the south and the incorporation of Provence and Languedoc under the French crown; while, with the establishment of Venetian supremacy in the Levant, the *baylo* developed into a diplomatic agent of the first class at the expense of the consuls of rival states. The modern system of consulships actually dates only from the 16th century. Early in this century both England and Scotland had their "conservators" with "jurisdiction to do justice between merchant and merchant beyond the seas"; but France led the way. The alliance between Francis I. and Suleiman the Magnificent gave her special advantages in the Levant, of which she was not slow to take advantage. Her success culminated in the capitulations signed in 1604, under the terms of which her consuls were given precedence over all others and were endowed with diplomatic immunities (e.g. freedom from arrest and from domiciliary visits), while the traders of all other nations were put under the protection of the French flag. It was not till 1675 that, under the first capitulations signed with Turkey, English consuls were established in the Ottoman empire. Ten years earlier, under the commercial treaty between England and Spain, they had been established in Spain.

The frequent wars of the succeeding century hindered the development of the consular system. Thus, though the system of consuls was regularly established in France by the ordinance of 1661, in 1760 France had consuls only in the Levant, Barbary, Italy, Spain and Portugal, while she discouraged the establishment of foreign consuls in her own ports as tending to infringe her own jurisdiction. It was not till the 19th century that the system developed universally. Hitherto consuls had, for the most part, been business men with no special qualification as regards training; but the French system, under which the consular service had been long established as part of the general civil service of the country, a system that had survived the Revolution unchanged, was gradually adopted by other nations; though, as in France, consuls not belonging to the regular service, and having an inferior status, continued to be appointed. In Great Britain the consular service was organized in 1825 (see below); in France the series of ordinances and laws by which its modern constitution was fixed began in 1833. In Germany progress was hindered by the political conditions of the country under the old Confederation; for the Hanse cities, which practically monopolized the oversea trade, lacked the means to establish a consular system on the French model. The present magnificently organized consular system of Germany is, then, one of the most remarkable outcomes of the establishment of the united empire. It was initiated by an act of the parliament of the North German Confederation (Nov. 8, 1867), subsequently incorporated in the statutes of the Empire, which laid down the principle that the German consulates were to be under the immediate jurisdiction of the president of the Confederation (later the emperor). The functions, duties and privileges of French and German consuls do not differ materially from those of British consuls; but there is a great difference in the organization and *personnel* of the consular service. In France, apart from the *consuls élus* or *consuls marchands*, who are mere consular agents, selected by the government from among the traders of a (*scabini*), &c., who had power to fine or to expel from the quarter. The Hanseatic League (*q.v.*), particularly, had numerous settlements of this kind, the earliest being the Steelyard at London, established in the 13th century.

town where it desires to be represented, and unsalaried, the consular body proper was, by the decrees of July 10, 1880, and April 27, 1883, practically constituted a branch of the diplomatic service. It is recruited from the same sources, and its members are free to exchange into the *corps diplomatique*, or vice versa. Candidates for the diplomatic and consular services have to undergo the same training and pass the same examinations, *i.e.* in the constitutional, administrative and judicial organization of the various powers, in international law, commercial law and maritime law, in the history of treaties and in commercial and political geography, in political economy, and in the German and English languages. They have to serve three years abroad or attached to some ministerial department before they can enter for the examination which entitles them to an appointment as attaché or as *consul suppléant*. This assimilation of the consular to the diplomatic service remains peculiar to France.<sup>1</sup>

In Germany it was enacted by the law of February 28, 1873, that German consuls must be either trained jurists, or must have passed special examinations. The result of this system has been the establishment throughout the world of an elaborate network of trained commercial experts, directly responsible to the central government, and charged as one of their principal duties with the task of keeping the government informed of all that may be of interest to German traders. These annual consular reports were from the first regularly and promptly published in the *Deutsche Handelsarchiv*, and have contributed much to the wonderful expansion of German trade. The right to establish consuls is now universally recognized by Christian civilized states. Jurists at one time contended that according to international law a right of "ex-territoriality" attached to consuls, their persons and dwellings being sacred, and themselves amenable to local authority only in cases of strong suspicion on political grounds. It is now admitted that, apart from treaty, custom has established very few consular privileges; that perhaps consuls may be arrested and incarcerated, not merely on criminal charges, but for civil debt; and that, if they engage in trade or become the owners of immovable property, their persons certainly lose protection. This question of arrest has been frequently raised in Europe:—in the case of Barbut, a tallow-chandler, who from 1717 to 1735 acted as Prussian consul in London, and to whom the exemption conferred by statute on ambassadors was held not to apply; in the case of Cretico, the Turkish consul in London in 1808; in the case of Begley, the United States consul at Genoa, arrested in Paris in 1840; and in the case of De la Fuente Hermosa, Uruguayan consul, whom the *Cour Royale* of Paris in 1842 held liable to arrest for debt. In the same way consuls are often exempt from all kinds of rates and taxes, and always from personal taxes. They are exempt from billeting and military service, but are not entitled (except in the Levant, where also freedom from arrest and trial is the rule) to have private chapels in their houses. The right of consuls to exhibit their national arms and flag over the door of the bureau is not disputed.

Until the year 1825 British consuls were usually merchants engaged in trade in the foreign countries in which they acted as consuls, and their remuneration consisted entirely of fees. An act of that year, however, organized the consular service as a branch of the civil service, with payment by a fixed salary instead of by fees; consuls were forbidden also to engage in trade, and the management of the service was put under the control of a separate department of the foreign office, created for the purpose. In 1832 the restriction as to engaging in trade was withdrawn, except as regards salaried members of the British consular service.

<sup>1</sup> *i.e.* as regards the organization of the system. Consuls, or consuls-general, of other countries have sometimes a diplomatic or quasi-diplomatic status. Consuls-general *chargés d'affaires*, *e.g.*, rank as diplomatic agents. Of these the most notable is the British agent and consul-general in Egypt, whose position is unique. The diplomatic agent of Belgium at Buenos Aires, *e.g.*, is minister-resident and consul-general, and the minister of Ecuador in London is consul-general *chargé d'affaires*.

The duty of consuls, under the "General Instructions to British Consuls," is to advise His Majesty's trading subjects, to quiet their differences, and to conciliate as much as possible the subjects of the two countries. Treaty rights he is to support in a mild and moderate spirit; and he is to check as far as possible evasions by British traders of the local revenue laws. Besides assisting British subjects who are tried for offences in the local courts, and ascertaining the humanity of their treatment after sentence, he has to consider whether home or foreign law is more appropriate to the case, having regard to the convenience of witnesses and the time required for decision; and, where local courts have wrongfully interfered, he puts the home government in motion through the consul-general or ambassador. He sends in reports on the labour, manufacture, trade, commercial legislation and finance, technical education, exhibitions and conferences of the country or district in which he resides, and, generally, furnishes information on any subject which may be desired of him. He acts as a notary public; he draws up marine and commercial protests, attests documents brought to him, and, if necessary, draws up wills, powers of attorney, or conveyances. He celebrates marriages in accordance with the provisions of the Foreign Marriage Act 1892, and, where the ministrations of a clergyman cannot be obtained, reads the burial service. At a seaport he has certain duties to perform in connexion with the navy. In the absence of any of His Majesty's ships he is senior naval officer; he looks after men left behind as stragglers, or in hospital or prison, and sends them on in due course to the nearest ship. He is also empowered by statute to advance for the erection or maintenance of Anglican churches, hospitals, and places of interment sums equal to the amount subscribed for the purpose by the resident British subjects.

As the powers and duties of consuls vary with the particular commercial interests they have to protect, and the civilization of the state in whose territory they reside, instead of abstract definition, we summarize the provisions on this subject of the British Merchant Shipping Acts.<sup>2</sup> Consuls are bound to send to the Board of Trade such reports or returns on any matter relating to British merchant shipping or seamen as they may think necessary. Where a consul suspects that the shipping or navigation laws are being evaded, he may require the owner or master to produce the log-book or other ship documents (such as the agreement with the seamen, the account of the crew, the certificate of registration); he may muster the crew, and order explanations with regard to the documents. Where an offence has been committed on the high seas, or aboard ashore, by British seamen or apprentices, the consul makes inquiry on oath, and may send home the offender and witnesses by a British ship, particulars for the Board of Trade being endorsed on the agreement for conveyance. He is also empowered to detain a foreign ship the master or seamen of which appear to him through their misconduct or want of skill to have caused injury to a British vessel, until the necessary application for satisfaction or security be made to the local authorities. Every British mercantile ship, not carrying passengers, on entering a port gives into the custody of the consul to be endorsed by him the seamen's agreement, the certificate of registry, and the official log-book; a failure to do this is reported to the registrar-general of seamen. The following five provisions are also made for the protection of seamen. If a British master engage seamen at a foreign port, the engagement is sanctioned by the consul, acting as a superintendent of Mercantile Marine Offices. The consul collects the property (including arrears of wages) of British seamen or apprentices dying abroad, and remits to H.M. paymaster-general. He also provides for the subsistence of seamen who are shipwrecked, discharged, or left behind, even if their service was with foreign merchants; they are generally sent home in the first British ship that happens to be in want of a complement, and the expenses thus incurred form a charge on the parliamentary fund for the relief of distressed seamen, the consul receiving a

<sup>2</sup> See also instructions to consuls prepared by the Board of Trade and approved by the secretary of state for foreign affairs.

commission of 2½ % on the amount disbursed. Complaints by crews as to the quality and quantity of the provisions on board are investigated by the consul, who enters a statement in the log-book and reports to the Board of Trade. Money disbursed by consuls on account of the illness or injury of seamen is generally recoverable from the owner. With regard to passenger vessels, the master is bound to give the consul facilities for inspection and for communication with passengers, and to exhibit his "master's list," or list of passengers, so that the consul may transmit to the registrar-general, for insertion in the Marine Register Book, a report of the passengers dying and children born during the voyage. The consul may even defray the expenses of maintaining, and forwarding to their destination, passengers taken off or picked up from wrecked or injured vessels, if the master does not undertake to proceed in six weeks; these expenses becoming, in terms of the Passenger Acts 1855 and 1863, a debt due to His Majesty from the owner or charterer, where a salvor is justified in detaining a British vessel, the master may obtain leave to depart by going with the salvor before the consul, who, after hearing evidence as to the service rendered and the proportion of ship's value and freight claimed, fixes the amount for which the master is to give bond and security. In the case of a foreign wreck the consul is held to be the agent of the foreign owner. Much of the notarial business which is imposed on consuls, partly by statute and partly by the request of private parties, consists in taking the declarations as to registry, transfers, &c., under the Mercantile Shipping Acts. Consuls in the Ottoman empire, China, Siam and Korea have extensive judicial and executive powers.

Since the incorporation of the British consular service in the civil service there have been several proposals to "reform" the system with the view of increasing its usefulness, more particularly from the point of view of providing assistance to British trade abroad (see *Reports of Special Committees of the House of Commons on the Consular Service*, 1858, 1872, 1903). It has been frequently urged that British consuls in their commercial knowledge and intercourse with foreign merchants compare unfavourably, for example, with the consuls of the United States. It must be remembered, however, that there are points of striking dissimilarity between the duties of the consuls of these two countries. The American consul is necessarily brought much into touch with the trade and commerce of the country to which he is assigned through the system of consular invoices (see *AD VALOREM*); in his ordinary reports he is not confined to one stereotyped form, and when preparing special reports (a valuable feature of the United States consular service) he is liberally treated as regards any expense to which he has been put in obtaining information. He is practically free from the multifarious duties which the English consul has to discharge in connexion with the mercantile marine, nor has he to perform marriage ceremonies; and financially he is much better off, being allowed to retain as personal all fees obtained from his notarial duties. The Committee of 1903 was appointed to inquire, *inter alia*, whether the limits of age—25 to 50—for candidates should be altered, and whether service as a vice-consul for a certain period should be required to qualify for promotion to the rank of consul; whether means could not be adopted to give consular officers opportunities of increasing their practical knowledge of commercial matters and to bring them more into personal contact with the commercial community. The suggestions of the committee as the result of its inquiries were adopted in principle by the Foreign Office. The consular service is now grouped into three main divisions: (1) the general service; (2) Levant and Persia; and (3) China, Japan, Korea and Siam. The general consular service is graded into three divisions: first grade, consuls-general, salary £1000 with local allowances; second grade, consuls-general and consuls, salary £800 and local allowances; third grade, consuls, salary £600, with local allowances. Vice-consuls have an annual salary of £350, rising by annual increments of £15 to £450. In the general consular service appointments are sometimes made to the higher offices

from the ranks, but more usually from a select list of nominees, who must pass a qualifying examination. A proportion of the vacancies are reserved for competition amongst candidates who have had actual commercial experience. Divisions 2 and 3 are recruited by open competition. There were at one time a small number of commercial agents whose business consisted in watching and reporting on the commerce, industries and products of special districts, and in answering inquiries on commercial subjects. Their duties were subsequently transferred to the consular staff, and a new class of officers, consular attachés, created. The consular attachés divide their time between special investigations abroad, and visits to manufacturing districts in the United Kingdom. The headquarters of the commercial attachés in Europe, except those at Paris and Constantinople, were transferred to London, without defined districts, in 1907 (see *Report on the System of British Commercial Attachés and Agents*, 1908, Cd. 3610). "Pro-consuls" are frequently appointed for the purpose of administering oaths, taking affidavits or affirmations, and performing notarial acts under the Commissioners for Oaths Acts 1889.

The position of the United States consuls is minutely described in the Regulations, Washington, 1896. Under various treaties and conventions they enjoy large privileges and jurisdiction. By the treaty of 1816 with Sweden the United States government agreed that the consuls of the two states respectively should be sole judges in disputes between captains and crews of vessels. (Up to 1906 there were eighteen treaties containing this clause.) By convention with France in 1853 they likewise agreed that the consuls of both countries should be permitted to hold real estate, and to have the "police interne des navires à commerce." In Borneo, China, Korea, Morocco, Persia, Siam, Tripoli and Turkey an extensive jurisdiction, civil and criminal, is exercised by treaty stipulation in cases where United States subjects are interested. Exemption from liability to appear as a witness is often stipulated. The question was raised in France in 1843 by the case of the Spanish consul Soller at Aix, and in America in 1854 by the case of Dillon, the French consul at San Francisco, who, on being arrested by Judge Hoffmann for declining to give evidence in a criminal suit, pulled down his consular flag. So, also, inviolability of national archives is often stipulated. To the consuls of other nations the United States government have always accorded the privileges of arresting deserters, and of being themselves amenable only to the Federal and not to the States courts. They also recognize foreign consuls as representative suitors for absent foreigners.

The United States commercial agents are appointed by the president, and usually receive an *exequatur*. They form a class by themselves, and are distinct from the consular agents, who are simply deputy consuls in districts where there is no principal consul.

By a law of April 1906 the U.S. consular service was reorganized and graded, the office of consul-general being divided into seven classes, and that of consul into nine classes; and on June 27 an executive order was issued by President Roosevelt governing appointments and promotions.

See A. de Miltitz, *Manuel des consuls* (London and Berlin, 1837-1843); Baron Ferdinand de Cussy, *Dictionnaire du diplomate et du consul* (Leipzig, 1846), and *Règlements consulaires des principaux états maritimes de l'Europe et de l'Amérique* (*ib.*, 1851); Tuson, *British Consul's Manual* (London, 1856); De Clercq, *Guide pratique des consulats* (1st ed., 1858, 5th ed. by de Vallat, Paris, 1898); C. J. Tarring, *British Consular Jurisdiction in the East* (London, 1887); Lippmann, *Die Konsularjurisdiktion im Orient* (Berlin, 1898); Zorn, *Die Konsulargesetzgebung des deutschen Reichs* (2nd ed., Berlin, 1901); v. König, *Handbuch des deutschen Konsularwesens* (6th ed., Berlin, 1902); Martens, *Das deutsche Konsular- und Kolonialrecht* (Leipzig, 1904); Malfatti di Monte Tretto, *Handbuch des österreichisch-ungarischen Konsularwesens* (2 vols., 2nd ed., Vienna, 1904). See also the *Parliamentary Reports* referred to in the text. For British consuls much detailed information, including, e.g., minute directions for the uniforms of the various grades, will be found in the official *Foreign Office List* published annually. As regards American consuls, see C. L. Jones, *The Consular Service of the U. S. A.* (Philadelphia, 1906); *Publications of Univ. of Pennsylvania*, "Series in Pol. Econ. and Public Law," No. 18; and Fred. Van Dyne, *Our Foreign Service* (Rochester, N.Y., 1909).

"CONSULATE OF THE SEA," a celebrated collection of maritime customs and ordinances (see also SEA LAWS) in the Catalan language, published at Barcelona in the latter part of the 15th century. Its proper title is *The Book of the Consulate*, or in Catalan, *Lo Libre de Consolat*, the name being derived from the fact that it embodied the rules of law followed in the maritime cities of the Mediterranean coast by the commercial judges known generally as consuls (*q.v.*). The earliest extant edition of the work, which was printed at Barcelona in 1494, is without a title-page or frontispiece, but it is described by the above-mentioned title in the epistle dedicatory prefixed to the table of contents. The only known copy of this edition is preserved in the National Library in Paris. The epistle dedicatory states that the work is an amended version of the *Book of the Consulate*, compiled by Francis Celedes with the assistance of numerous shipmasters and merchants well versed in maritime affairs. According to a statement made by Capmany in his *Código de los costumbres marítimas de Barcelona*, published at Madrid in 1791, there was extant to his knowledge in the last century a more ancient edition of the *Book of the Consulate*, printed in semi-Gothic characters, which he believed to be of a date prior to 1484. This is the earliest period to which any historical record of the *Book of the Consulate* being in print can be traced back. There are, however, two Catalan MSS. preserved in the National Library in Paris, the earliest of which, being MS. Espagnol 124, contains the two first treatises which are printed in the *Book of the Consulate* of 1494, and which are the most ancient portion of its contents, written in a hand of the 14th century, on paper of that century. The subsequent parts of this MS. are on paper of the 15th century, but there is no document of a date more recent than 1436. The later of the two MSS., being MS. Espagnol 56, is written throughout on paper of the 15th century, and in a hand of that century, and it purports, from a certificate on the face of the last leaf, to have been executed under the superintendence of Peter Thomas, a notary public, and the scribe of the Consulate of the Sea at Barcelona.

The edition of 1494, which is justly regarded as the *editio princeps* of the *Book of the Consulate*, contains, in the first place, a code of procedure issued by the kings of Aragon for the guidance of the courts of the consuls of the sea, in the second place, a collection of ancient customs of the sea, and thirdly, a body of ordinances for the government of cruisers of war. A colophon at the end of these ordinances informs the readers that "the book commonly called the *Book of the Consulate* ends here"; after which there follows a document known by the title of *The Acceptions*, which purports to record that the previous chapters and ordinances had been approved by the Roman people in the 11th century, and by various princes and peoples in the 12th and 13th centuries. Capmany was the first person to question the authenticity of this document in his *Memorias historicas sobre la marina, &c., de Barcelona*, published at Madrid in 1779-1792. Pardessus and other writers on maritime law followed up the inquiry in the 19th century, and have conclusively shown that the document, whatever may have been its origin, has no proper reference to the *Book of the Consulate*, and is, in fact, of no historical value whatsoever. The paging of the edition of 1494 ceases with this document, at the end of which is the printer's colophon, reciting that "the work was completed on the 14th of July 1494, at Barcelona, by Père Posa, priest and printer." The remainder of the volume consists of what may be regarded as an appendix to the original *Book of the Consulate*. This appendix contains various maritime ordinances of the kings of Aragon and of the councillors of the city of Barcelona, ranging over a period from 1340 to 1484. It is printed apparently in the same type with the preceding part of the volume. The original *Book of the Consulate*, coupled with this appendix, constitutes the work which has obtained general circulation in Europe under the title of *The Consulate of the Sea*, and which in the course of the 16th century was translated into the Castilian, the Italian, and the French languages. The Italian translation, printed at Venice in 1549 by Jean Baptista Pedrezano, was the version which obtained the largest circulation in the north of Europe, and led many

jurists to suppose the work to have been of Italian origin. In the next following century the work was translated into Dutch by Westerven, and into German by Engelbrecht, and it is also said to have been translated into Latin.

An excellent translation into French of "The Customs of the Sea," which are the most valuable portion of the *Book of the Consulate*, was published by Pardessus in the second volume of his *Collection des lois maritimes* (Paris, 1834), under the title of "La Compilation connue sous le nom de consulat de la mer." See introduction, by Sir Travers Twiss, to the *Black Book of the Admiralty* (London, 1874), which in the appendix to vol. iii. contains his translation of "The Customs of the Sea," with the Catalan text. (T. T.)

**CONSUMPTION** (Lat. *consumere*), literally, the act of consuming or destroying. Thus the word is popularly applied to phthisis, a "wasting away" of the lungs due to tuberculosis (*q.v.*). In economics the word has a special significance as a technical term. It has been defined as the destruction of utilities, and thus opposed to "production," which is the creation of utilities, a utility in this connexion being anything which satisfies a desire or serves a purpose. Consumption may be either productive or unproductive; productive where it is a means directly or indirectly to the satisfaction of any economic want, unproductive when it is devoted to pleasures or luxuries. Its place in the science of economics, and its close relation with production, are treated of in every text-book, but special reference may be made to W. Roscher, *Nationalökonomie*, 1883, and G. Schönberg, *Handbuch d. polit. Ökonomie*, 1890-1891.

**CONSUS**, an ancient Italian deity, originally a god of agriculture. The time at which his festival was held (after harvest and seed-sowing), the nature of its ceremonies and amusements, his altar at the end of the Circus Maximus always covered with earth except on such occasions, all point to his connexion with the earth. In accordance with this, the name has been derived from *condere* (= *Condius*, as the "keeper" of grain or the "hidden" god, whose life-producing influence works in the depths of the earth). Another etymology is from *conserere* ("sow," cf. *Ops Consiva* and her festival *Opiconsivia*). Amongst the ancients (Livy i. 9; Dion. Halic. ii. 31) Consus was most commonly identified with *Ποσειδῶν Ἴππιος* (Neptunus Equester), and in later Latin poets Consus is used for Neptunus, but this idea was due to the horse and chariot races which took place at his festival; otherwise, the two deities have nothing in common. According to another view, he was the god of good counsel, who was said to have "advised" Romulus to carry off the Sabine women (Ovid, *Fasti*, iii. 199) when they visited Rome for the first celebration of his festival (*Consualia*). In later times, with the introduction of Greek gods into the Roman theological system, Consus, who had never been the object of special reverence, sank to the level of a secondary deity, whose character was rather abstract and intellectual.

His festival was celebrated on the 21st of August and the 15th of December. On the former date, the flamen Quirinalis, assisted by the vestals, offered sacrifice, and the pontifices presided at horse and chariot races in the circus. It was a day of public rejoicing; all kinds of rustic amusements took place, amongst them running on ox-hides rubbed with oil (like the Gr. *ἀσκολιασμός*). Horses and mules, crowned with garlands, were given rest from work. A special feature of the games in the circus was chariot racing, in which mules, as the oldest draught beasts, took the place of horses. The origin of these games was generally attributed to Romulus; but by some they were considered an imitation of the Arcadian *ἱπποκράτεια* introduced by Evander. There was a sanctuary of Consus on the Aventine, dedicated by L. Papirius Cursor in 272, in early times wrongly identified with the altar in the circus.

See W. W. Fowler, *The Roman Festivals* (1899); G. Wissowa, *Religion und Kultus der Römer* (1902); Preller-Jordan, *Römische Mythologie* (1881).

**CONTANGO**, a Stock Exchange term for the rate of interest paid by a "bull" who has bought stock for the rise and does not intend to pay for it when the Settlement arrives. He arranges to carry over or continue his bargain, and does so by entering into a fresh bargain with his seller, or some other party,



by which he sells the stock for the Settlement and buys it again for the next, the price at which the bargain is entered being called the making-up price. The rate that he pays for this accommodation, which amounts to borrowing the money involved until the next Settlement, is called the contango.

**CONTARINI**, the name of a distinguished Venetian family, who gave to the republic eight doges and many other eminent citizens. The story of their descent from the Roman family of Cotta, appointed prefects of the Reno valley (whence Cotta Reni or Conti del Reno), is probably a legend. One Mario Contarini was among the twelve electors of the doge Paulo Lucio Anafesto in 697. Domenico Contarini, elected doge in 1043, subjugated rebellious Dalmatia and recaptured Grado from the patriarch of Aquileia. He died in 1070. Jacopo was doge from 1275 to 1280. Andrea was elected doge in 1367, and during his reign the war of Chioggia took place (1380); he was the first to melt down his plate and mortgage his property for the benefit of the state. Other Contarini doges were: Francesco (1623-1624), Niccolò (1630-1631), who built the church of the Salute, Carlo (1655-1656), during whose reign the Venetians gained the naval victory of the Dardanelles, Domenico (1659-1675) and Alvise (1676-1684). There were at one time no less than eighteen branches of the family; one of the most important was that of Contarini dallo Zaffo or di Giaffa, who had been invested with the countship of Jaffa in Syria for their services to Caterina Cornaro, queen of Cyprus; another was that of Contarini degli Scrigni (of the coffers), so called on account of their great wealth. Many members of the family distinguished themselves in the service of the republic, in the wars against the Turks, and no less than seven Contarini fought at Lepanto. One Andrea Contarini was beheaded in 1430 for having wounded the doge Francesco Foscari (*q.v.*) on the nose. Other members of the house were famous as merchants, prelates and men of letters; among these we may mention Cardinal Gasparo Contarini (1483-1542), and Marco Contarini (1631-1689), who was celebrated as a patron of music and collected at his villa of Piazzola a large number of valuable musical MSS., now in the Marciana library at Venice. The family owned many palaces in various parts of Venice, and several streets still bear its name.

See J. Fontana, "Sulla patrizia famiglia Contarini," in *Il Gondoliere* (1843). (L. V.)\*

**CONTAT, LOUISE FRANÇOISE** (1760-1813), French actress, made her *début* at the Comédie Française in 1766 as Atalide in *Bajazet*. It was in comedy, however, that she made her first success, as Suzanne in Beaumarchais's *Mariage de Figaro*; and in several minor character parts, which she raised to the first importance, and as the soubrette in the plays of Molière and Marivaux, she found opportunities exactly fitted to her talents. She retired in 1809 and married de Parny, nephew of the poet. Her sister Marie Émilie Contat (1769-1846), an admirable soubrette, especially as the pert servant drawn by Molière and de Regnard, made her *début* in 1784, and retired in 1815.

**CONTE**, literally a "story," derived from the Fr. *conter*, to narrate, through low Lat. and Provençal forms *contare* and *comtar*. This word, although not recognized by the *New English Dictionary* as an English term, is yet so frequently used in English literary criticisms that some definition of it seems to be demanded. A *conte*, in French, differs from a  *récit*  or a  *rapport*  in the element of style; it may be described as an anecdote told with deliberate art, and in this introduction of art lies its peculiar literary value. According to Littré, there is no fundamental difference between a *conte* and a *roman*, and all that can be said is that the *conte* is the generic term, covering long stories and short alike, whereas the *roman* (or novel) must extend to a certain length. But if this is the primitive and correct signification of the word, it is certain that modern criticism thinks of a *conte* essentially as a short story, and as a short story exclusively occupied in illustrating one set of ideas or one disposition of character. As early as the 13th century, the word is used in French literature to describe an anecdote thus briefly and artistically told, in prose or verse. The fairy-tales of Perrault and the apologues of La Fontaine were alike spoken of as *contes*,

and stories of peculiar extravagance were known as *contes bleus*, because they were issued to the common public in coarse blue paper covers. The most famous *contes* in the 18th century were those of Voltaire, who has been described as having invented the *conte philosophique*. But those brilliant stories, *Candide*, *Zadig*, *L'Ingénu*, *La Princesse de Babylone* and *Le Taureau blanc*, are not, in the modern sense, *contes* at all. The longer of these are *romans*, the shorter *nouvelles*; not one has the anecdotal unity required by a *conte*. The same may be said of those of Marmontel, and of the insipid imitations of Oriental fancy which were so popular at the close of the 18th century. The most perfect recent writer of *contes* is certainly Guy de Maupassant, and his celebrated anecdote called "Boule de suif" may be taken as an absolutely perfect example of this class of literature, the precise limitations of which it is difficult to define. (E. G.)

**CONTÉ, NICOLAS JACQUES** (1755-1805), French mechanical genius, chemist and painter, was born at Aunou-sur-Orne, near Sées, on the 4th of August 1755, of a family of poor farm labourers. At the age of fourteen he displayed precocious artistic talent in a series of religious panels, remarkably fine in colour and composition, for the principal hospital of Sées, where he was employed to help the gardener. With the advice of Greuze he took up portrait painting, quickly became the fashion, and laid by in a few years a fair competency. From that time he gave free rein to his passion for the mechanical arts and scientific studies. He attended the lectures of J. A. C. Charles, L. N. Vaquelin and J. B. Leroy, and exhibited before the Academy of Science an hydraulic machine of his own invention of which the model was the subject of a flattering report, and was placed in Charles's collection. The events of the Revolution soon gave him an opportunity for a further display of his inventive faculty. The war with England deprived France of plumbago; he substituted for it an artificial substance obtained from a mixture of graphite and clay, and took out a patent in 1795 for the form of pencil which still bears his name. At this time he was associated with Monge and Berthollet in experiments in connexion with the inflation of military balloons, was conducting the school for that department of the engineer corps at Meudon, was perfecting the methods of producing hydrogen in quantity, and was appointed (1796) by the Directory to the command of all the aerostatic establishments. He was at the head of the newly created Conservatoire des arts et métiers, and occupied himself with experiments in new compositions of permanent colours, and in 1798 constructed a metal-covered barometer for measuring comparative heights, by observing the weight of mercury issuing from the tube. Summoned by Bonaparte to take part as chief of the aerostatic corps in the expedition to Egypt, he considerably extended his field of activity, and for three years and a half was, to quote Berthollet, "the soul of the colony." The disaster of Aboukir and the revolt of Cairo had caused the loss of the greater part of the instruments and munitions taken out by the French. Conté, who, as Monge says, "had every science in his head and every art in his hands," and whom the First Consul described as "good at everything," seemed to be everywhere at once and triumphed over apparently insurmountable difficulties. He made, in an almost uncivilized country, utensils, tools and machinery of every sort from simple windmills to stamps for minting coin. Thanks to his activity and genius, the expedition was provided with bread, cloth, arms and munitions of war; the engineers with the exact tools of their trade; the surgeons with operating instruments. He made the designs, built the models, organized and supervised the manufacture, and seemed to be able to invent immediately anything required. On his return to France in 1802 he was commissioned by the minister of the interior, Chaptal, to superintend the publication of the great work of the commission on Egypt, and an engraving machine of his construction materially shortened this task, which, however, he did not live to see finished. He died at Paris on the 6th of December 1805. Napoleon had included him in his first promotions to the Legion of Honour. A bronze statue was erected to his memory in 1852 at Sées, by public subscription.

**CONTEMPT OF COURT**, in English law, any disobedience or disrespect to the authority or privileges of a legislative body, or interference with the administration of a court of justice.

1. *The High Court of Parliament.* Each of the two houses of Parliament has by the law and custom of parliament power to protect its freedom, dignity and authority against insult, disregard or violence by resort to its own process and not to ordinary courts of law and without having its process interfered with by those courts. The nature and limits of this authority to punish for contempt have been the subject of not infrequent conflict with the courts of law, from the time when Lord Chief Justice Holt threatened to commit the speaker for attempting to stop the trial of *Ashby v. White* (1701), as a breach of privilege, to the cases of *Burdett v. Abbott* (1810), *Stockdale v. Hansard* and *Howard v. Gosset* (1842, 1843), and *Bradlaugh v. Gosset* (1834). It is now the accepted view that the power of either House to punish contempt is exceptional and derived from ancient usage, and does not flow from their being courts of record. Orders for committal by the Commons are effectual only while the House sits; orders by the Lords may be for a time specified, in which event prorogation does not operate as a discharge of the offender. It was at one time considered that the privilege of committing for contempt was inherent in every deliberative body invested with authority by the constitution, and consequently that colonial legislative bodies had by the nature of their functions the power to commit for contempt. But in *Kielley v. Carson* (1843; 4 Moore, P.C. 63) it was held that the power belonged to parliament by ancient usage only and not on the theory above stated, and in each colony it is necessary to inquire how far the colonial legislature has acquired, by order in council or charter or from the imperial legislature, power to punish breach of privilege by imprisonment or committal for contempt. This power has in some cases been given directly, in others by authority to make laws and regulations under sanctions like those enforced by the Houses of the imperial parliament. In the case of Nova Scotia the provincial assembly has power to give itself by statute authority to commit for contempt (*Fielding v. Thomas*, 1896; L.R.A.C. 600). In *Barton v. Taylor* (1886; 11 A.C. 197) the competence of the legislative assembly of New South Wales to make standing orders punishing contempt was recognized to exist under the colonial constitution, but the particular standing orders under consideration are held not to cover the acts which had been punished. (See May, *Parl. Pr.*, 10th ed., 1896; Anson, *Law and Custom of the Constitution*, 3rd ed., 1897.)

2. *Courts of Justice.* The term contempt of court, when used with reference to the courts or persons to whom the exercise of the judicial functions of the crown has been delegated, means insult offered to such court or person by deliberate defiance of its authority, disobedience to its orders, interruption of its proceedings or interference with the due course of justice, or any conduct calculated or tending to bring the authority or administration of the law into disrespect or disregard, or to interfere with or prejudice parties or witnesses during the litigation. The ingenuity of the judges and of those who are concerned to defeat or defy justice have rendered contempt almost Protean in its character. But for practical purposes most, if not all, contempts fall within the classification which follows:—

(a) Disobedience to the judgment or order of a court commanding the doing or abstaining from a particular act, e.g. an order to execute a conveyance of property or an order on a person in a fiduciary capacity to pay into court trust moneys as to which he is an accounting party. This includes disobedience by the members of a local authority to a *mandamus* to do some act which they are by law bound to do; and proceedings for contempt have been taken in the case of guardians of the poor who have refused to enforce the Vaccination Acts, e.g. at Keighley and Leicester, and of town councillors who have refused to comply with an order to take specified measures to drain their borough (e.g. Worcester). This process for compelling obedience is in substance a process of civil execution for the

benefit of the injured party rather than a criminal process for punishing the disobedience; and for purposes of appeal orders dealing with these forms of contempt have hitherto been treated as civil proceedings.

(b) Disobedience by inferior judges or magistrates to the lawful order of a superior court. Such disobedience, if amounting to wilful misconduct, would usually give ground for a motion or removal from office, or for prosecution or indictment or information for misconduct (Archbold, *Criminal Pleading*, 147, 23rd ed.).

(c) Disobedience or misconduct by executive officers of the law, e.g. sheriffs and their bailiffs or gaolers. The contempt consists in not complying with the terms of writs or warrants sent for execution. For instance, a judge of assize having ordered the court to be cleared on account of some disturbance, the high sheriff issued a placard protesting against "this unlawful proceeding," and "prohibiting his officer from aiding and abetting any attempt to bar out the public from free access to the court." The lord chief justice of England, sitting in the other court, summoned the sheriff before him and fined him £500 for the contempt, and £500 more for persisting in addressing the grand jury in court, after he had been ordered to desist. A sheriff who fails to attend the assizes is liable to severe fine as being in contempt (Oswald, 51). And in Harvey's case (1884, 26 Ch. D. 644) steps were taken to attach a sheriff who had failed to execute a writ of attachment for contempt of court in the mistaken belief that he was not entitled to break open doors to take the person in contempt. The Sheriffs Act 1887 enumerates many instances in which misconduct is punishable under that act, but reserves to superior courts of record power to deal with such misconduct as a contempt (s. 29).

(d) Misconduct or neglect of duty by subordinate officials of courts of justice, including solicitors. In these cases it is more usual for the superior authorities to remove the offender from office, or for disciplinary proceedings to be instituted by the Law Society. But in the case of an unqualified person assuming to act as a solicitor or in the case of breach of an undertaking given by a solicitor to the court, proceedings for contempt are still taken.

(e) Misconduct by parties, jurors or witnesses. Jurors who fail to attend in obedience to a jury summons and witnesses who fail to attend on subpoena are liable to punishment for contempt, and parties, counsel or solicitors who practise a fraud on the court are similarly liable.

(f) Contempt *in facie curiae*. "Some contempts," says Blackstone, "may arise in the face of the court, as by rude and contumelious behaviour, by obstinacy, perverseness or prevarication, by breach of the peace, or any wilful disturbance whatever"; in other words, direct insult to or interference with a sitting court is treated as contempt of the court. It is immaterial whether the offender is juror, party, witness, counsel, solicitor or a stranger to the case at hearing, and occasionally it is found necessary to punish for contempt persons under trial for felony or misdemeanour if by violent language or conduct they interrupt the proceedings at their trial. Judges have even treated as contempt the continuance outside the court-house after warning of a noise sufficient to disturb the proceedings of the court; and in Victoria Chief Justice Higginbotham committed for contempt a builder who persisted after warning in building operations close to the central criminal court in Melbourne, which interfered with the due conduct of the business of the sittings.

(g) Attempts to prevent or interfere with the due course of justice, whether made by a person interested in a particular case or by an outsider. This branch of contempt takes many forms, such as frauds on the court by justices, solicitors or counsel (e.g. by fraudulently circularizing shareholders of a company against which a winding-up petition had been filed), tampering with witnesses by inducing them through threats or persuasion not to attend or to withhold evidence or to commit perjury, threatening judge or jury or attempting to bribe them and the like; and also by "scandalizing the court itself" by abusing

the parties concerned in a pending case, or by creating prejudice against such persons before their cause is heard.

The *locus classicus* on the subject of contempt by attacks on judges is a judgment prepared by Sir Eardley-Wilmot in the case of an application for an attachment against

*Invectives against judges.* J. Almon in 1765, for publishing a pamphlet libelling the court of king's bench. The judgment was not actually delivered as the case was settled, but has long been accepted as correctly stating the law. Sir Eardley-Wilmot said that the offence of libelling judges in their judicial capacity is the most proper case for an attachment, for the "arraignment of the justice of the judges is arraignment of the king's justice; it is an impeachment of his wisdom and goodness in the choice of his judges; and excites in the minds of the people a general dissatisfaction with all judicial determinations, and indisposes their minds to obey them. To be impartial, and to be universally thought so, are both absolutely necessary for the giving justice that free, open and uninterrupted current which it has for many ages found all over this kingdom, and which so eminently distinguishes and exalts it above all nations upon the earth." Again, "the constitution has provided very apt and proper remedies for correcting and rectifying the involuntary mistakes of judges, and for punishing and removing them for any perversion of justice. But if their authority is to be trampled on by pamphleteers and news-writers, and the people are to be told that the power given to the judges for their protection is prostituted to their destruction, the court may retain its power some little time, but I am sure it will eventually lose all its authority."

The object of the discipline enforced by the court by proceedings for contempt of court is not now, if it ever was, to vindicate the personal dignity of the judges or to protect them from insult as individuals, but to vindicate the dignity and authority of the court itself and to prevent acts tending to obstruct the due course of justice. The question whether a personal invective against judges should be dealt with *brevi manu* by the court attacked, or by proceedings at the instance of the attorney-general by information or indictment for a libel on the administration of justice or on the judge attacked, or should be dealt with by a civil action for damages, depends on the nature and occasion of the attack on the judge.

There has at times been a disposition by judges in colonial courts to use the process of the court to punish criticisms on their acts by counsel or parties or even outsiders, which the privy council has been prone to discourage. For instance in a Nova Scotia case a barrister was suspended from practice for writing to the chief justice of the province a letter relating to a case in which the barrister was suitor. The privy council while considering the letter technically a contempt, held the punishment inappropriate. In *MacLeod v. St Aubyn* (1899, A.C. 549) it was said that proceedings for scandalizing the court itself were obsolete in England. But in 1900 the king's bench division, following the Almon case, summarily punished a scurrilous personal attack on a judge of assize with reference to his remarks in a concluded case, published immediately after the conclusion of the case (*R. v. Gray*, 1900, 2 Q.B. 36). The same measure may be meted out to those who publish invectives against judges or juries with the object of creating suspicion or contempt as to the administration of justice. But the existence of this power does not militate against the right of the press to publish full reports of trials and judgments or to make with fairness, good faith, candour and decency, comments and criticisms on what passed at the trial and on the correctness of the verdict or the judgment. To impute corruption is said to go beyond the limits of fair criticism. Shortt (*Law relating to Works of Literature*) states the law to be that the temperate and respectful discussion of judicial determination is not prohibited, but mere invective and abuse, and still more the imputation of false, corrupt and dishonest motives is punishable. In an information granted in 1788 against the corporation of Yarmouth for having entered upon their books an order "stating that the assembly were sensible that Mr W. (against whom an action had been brought for malicious prosecution, and a verdict for £3000

returned, which the court refused to disturb) was actuated by motives of public justice, of preserving the rights of the corporation to their admiralty jurisdiction, and of supporting the honour and credit of the chief magistrate," Mr Justice Buller said, "The judge and jury who tried the case, confirmed by the court of common pleas, have said that instead of his having been actuated by motives of public justice, or by any motives which should influence the actions of an honest man, he had been actuated by malice. These opinions are not reconcilable; if the one be right the other must be wrong. It is therefore a direct insinuation that the court had judged wrong in all they have done in this case, and is therefore clearly a libel on the administration of justice."

The exact limits of the power to punish for contempt of court in respect of statements or comments on the action of judges and juries, or with reference to *pending* proceedings, have been the subject of some controversy, owing to the difficulty of reconciling the claims of the press to liberty and of the public to free discussion of the proceedings of courts of justice with the claims of the judges to due respect and of the parties to litigation that their causes should not be prejudiced before trial by outside interference. As the law now stands it is permissible to publish contemporaneous reports of the proceedings in cases pending in any court (Law of Libel Amendment Act 1888, s. 3), unless the proceedings have taken place in private (*in camera*), or the court has in the interests of justice prohibited any report until the case is concluded, a course now rarely, if ever, adopted. But it is not permissible to make any comments on a pending case calculated to interfere with the due course of justice in the case, nor to publish statements about the cause or the parties calculated to have that effect. This rule applies even when the case has been tried and the jury has disagreed if a second trial is in prospect. Applications are frequently made to commit proprietors and editors who comment too freely or who undertake the task of trying in their newspapers a pending case. The courts are now slow to move unless satisfied that the statements or comments may seriously affect the course of justice, e.g. by reaching the jurors who have to try the case.

The difference between pending and decided cases has been frequently recognized by the courts. What would be a fair comment in a decided case may tend to influence the mind of the judge or the jury in a case waiting to be heard, and will accordingly be punished as a contempt. In *Tichborne v. Mostyn* the publisher of a newspaper was held to have committed a contempt by printing in his paper extracts from affidavits in a pending suit, with comments upon them. In the case of *R. v. Castro* it was held that after a true bill has been found, and the indictment removed into the court of queen's bench, and a day fixed for trial, the case was pending; and it was a contempt of court to address public meetings, alleging that the defendant was not guilty, that there was a conspiracy against the defendant, and that he could not have a fair trial; and the court ordered the parties to answer for their contempt. In the case of the Moat Farm murder (1903) the high court punished as contempt a series of articles published in a newspaper while the preliminary inquiry was proceeding and before the case went to a jury (*R. v. Parker*, 1903, 2 K.B. 432). The like course was followed in 1905 in the case of statements made in a Welsh newspaper about a woman awaiting trial for attempted murder (*R. v. Davies*, 1906, 1 K.B. 32); and in the case of the *Weekly Dispatch* in 1902 (*R. v. Tibbits and Windust*, 1 K.B. 77), two journalists were tried on indictment, and held to have been rightly convicted, for conspiring to prevent the course of justice by publishing matter calculated to interfere with the fair trial of persons who were under accusation.

"In the superior courts the power of committing for contempt is inherent in their constitution, has been coeval with their original institution and has been always exercised" (*Oswald, On Contempt*, 3). The high court in which these courts are merged is the only court which has a general jurisdiction to deal summarily with all forms of contempt. Each division of that court deals with

*Courts having jurisdiction.*



the particular contempts arising with reference to proceedings before the division; but the king's bench division, in the exercise of the supervisory authority inherited from the old court of king's bench as *custos morum*, also from time to time deals with acts constituting interference with justice in other inferior courts whether of record or not. The nature and limits of this jurisdiction after much discussion have been defined by decisions in 1903 and 1905 in attempts to try by newspapers cases under inquiry by justices or awaiting trial at assizes or quarter sessions. The exercise of this authority in the king's bench division, being in a criminal cause or matter, is not the subject of appeal to any higher court.

Inferior courts of record have, as a general rule, power to punish only those contempts which are committed *in facie curiae* or consist in disobedience to the lawful orders or judgments of the court. For instance, a county court may summarily punish persons who insult the judge or any officer of the court or any juror or witness, or wilfully interrupt the proceedings, or misbehave in the court-house (County Court Act 1888, s. 162), and may also attack persons who having means refuse to comply with an order to pay money, or refuse to comply with an order to deliver up a specific chattel or disobey an injunction. A court of quarter sessions has at common law a like power as to contempts *in facie curiae* and is said to have power to punish its officials for contempt in non-attendance or neglect of duty.

Contempt of court is a misdemeanour and is punishable by fine and imprisonment or either at discretion. The offence may be tried summarily, or may be prosecuted on information or on indictment as was done in the case of the *Weekly Dispatch* already mentioned. The prerogative of pardon extends to all contempts of court which are dealt with by a sentence of clearly punitive character; but it is doubtful whether it extends to committals for disobedience to orders made in aid of the execution of a civil judgment.

Contempt is usually dealt with summarily by the court contemned in the case of contempt *in facie curiae*. The offender may be instantly apprehended and without further proof or examination fined or sent to prison. In the case of other contempts the High Court not only can deal with contempts affecting itself, but can also intervene summarily to protect inferior courts from contempts. This jurisdiction was asserted and exercised in the Moat Farm case (1903) and the *South Wales Post* case (1905) already mentioned.

Except in cases of contempt *in facie curiae* evidence on oath as to the alleged contempt must be laid before the court, and application made for the "committal" or "attachment" of the offender. The differences between the two modes are technical rather than substantial.

The procedure for dealing with contempt of court varies somewhat according as the contempt consists in disobeying an order of the High Court made in a civil cause, or consists in interference with the course of justice by persons not present in court nor parties to the cause. In the first class of cases the court proceeds by order of committal or giving leave to issue writ of attachment. In either case the person said to be in contempt must have full notice of the proposed motion and of the grounds on which he is said to be in contempt; and the rules regulating such proceedings must be strictly complied with (*R. v. Tuck*, 1906, 2 Ch. 692). In proceedings on the crown side of the king's bench division it is still usual to apply in the first place for a rule *nisi* for leave to attach the alleged offender who is given an opportunity of explaining, excusing or justifying the incriminated acts. It is essential that before punishment the alleged offender should have had full notice as to the specific offence charged and opportunity of answering to it. The king's bench procedure is that generally used for interference with the due course of criminal justice or disobedience to prerogative writs such as *mandamus*.

An order of committal is an order in execution specifying the nature of the detention to be suffered, or the penalty to be paid. The process of attachment merely brings the accused into court; he is then required to answer on oath interrogatories administered

to him, so that the court may be better informed of the circumstances of the contempt. If he can clear himself on oath he is discharged; if he confesses the court will punish him by fine or imprisonment, or both, at its discretion. But in very many cases on proper apology and submission, and undertaking not to repeat the contempt, and payment of costs, the court allows the proceedings to drop without proceeding to fine or imprison.

From time to time proposals have been made to deprive the superior courts of the power to deal summarily with contempts not committed *in facie curiae*, and to require proceedings on other charges for contempt to go before a jury. This distinction has already been made in some British colonies, e.g. British Guiana, by an ordinance of 1900 (No. 31). Recent decisions in England have so fully defined the limits of the offence and declared the practice of the courts that it would probably only result in undue licence of the press if the power now carefully and judicially exercised of dealing summarily with journalistic interference with the ordinary course of justice were taken away and the delay involved in submitting the case to a jury were made inevitable. The courts now only act in clear cases, and in cases of doubt can always send the question to a jury. The experience of other countries makes it undesirable to part with the summary remedy so long as it is in the hands of a trusted judicature.

*Scotland*.—In Scotland the courts of session and justiciary have, at common law, and exercise the power of punishing contempt committed during a judicial proceeding by censure, fine or imprisonment *proprio motu* without formal proceedings or a summary complaint. The nature of the offence is there in substance the same as in England (see Petrie, 1889: 7 *Rettie Justiciary* 3; Smith, 1892: 20 *Rettie Justiciary* 52).

*Ireland*.—In Ireland the law of contempt is on the same lines as in England, but conflicts have arisen between the bench and popular opinion, due to political and religious differences, which have led to proposals for making juries and not judges arbiters in cases of contempt.

*British Dominions beyond Seas*.—The courts of most British possessions have acquired and freely exercise the power of the court of king's bench to deal summarily with contempt of court; and, as already stated, it is not infrequently the duty of the privy council to restrain too exuberant a vindication of the offended dignity of a colonial court. (W. F. C.)

**CONTI, PRINCES OF.** The title of prince of Conti, assumed by a younger branch of the house of Condé, was taken from Conti-sur-Selles, a small town about 20 m. S.W. of Amiens, which came into the Condé family by the marriage of Louis of Bourbon, first prince of Condé, with Eleanor de Roye in 1551.

FRANÇOIS (1558–1614), the third son of this marriage, was given the title of marquis de Conti, and between 1581 and 1597 was elevated to the rank of a prince. Conti, who belonged to the older faith, appears to have taken no part in the wars of religion until 1587, when his distrust of Henry, third duke of Guise, caused him to declare against the League, and to support Henry of Navarre, afterwards King Henry IV. of France. In 1589 after the murder of Henry III., king of France, he was one of the two princes of the blood who signed the declaration recognizing Henry IV. as king, and he continued to support Henry, although on the death of Charles cardinal de Bourbon in 1590 he himself was mentioned as a candidate for the throne. In 1605 Conti, whose first wife Jeanne de Cœme, heiress of Bonnetable, had died in 1601, married the beautiful and witty Louise Marguerite (1574–1631), daughter of Henry duke of Guise and Catherine of Cleves, whom, but for the influence of his mistress Gabrielle d'Estrées, Henry IV. would have made his queen. Conti died in 1614. His only child Marie having predeceased him in 1610, the title lapsed. His widow followed the fortunes of Marie de' Medici, from whom she received many marks of favour, and was secretly married to François de Bassompierre (*q.v.*), who joined her in conspiring against Cardinal Richelieu. Upon the exposure of the plot the cardinal exiled her to her estate at Eu, near Amiens, where she died. The princess wrote *Aventures de la cour de Perse*, in which, under the veil of fictitious scenes and names, she tells the history of her own time.

In 1629 the title of prince de Conti was revived in favour of ARMAND DE BOURBON (1629–1666), second son of Henry II. of

Bourbon, prince of Condé, and brother of Louis, the great Condé. He was destined for the church and studied theology at the university of Bourges, but although he received several benefices he did not take orders. He played a conspicuous part in the intrigues and fighting of the Fronde, became in 1648 commander-in-chief of the rebel army, and in 1650 was with his brother Condé imprisoned at Vincennes. Released when Mazarin went into exile, he wished to marry Mademoiselle de Chevreuse (1627-1652), daughter of the famous confidante of Anne of Austria, but was prevented by his brother, who was now supreme in the state. He was concerned in the Fronde of 1651, but soon afterwards became reconciled with Mazarin, and in 1654 married the cardinal's niece, Anne Marie Martinozzi (1639-1672), and secured the government of Guienne. He took command of the army which in 1654 invaded Catalonia, where he captured three towns from the Spaniards. He afterwards led the French forces in Italy, but after his defeat before Alessandria in 1657 retired to Languedoc, where he devoted himself to study and mysticism until his death. At Clermont Conti had been a fellow student of Molière's for whom he secured an introduction to the court of Louis XIV., but afterwards, when writing a treatise against the stage entitled *Traité de la comédie et des spectacles selon les traditions de l'Église* (Paris, 1667), he charged the dramatist with keeping a school of atheism. Conti also wrote *Lettres sur la grâce*, and *Du devoir des grands et des devoirs des gouverneurs de province*.

LOUIS ARMAND DE BOURBON, prince de Conti (1661-1685), eldest son of the preceding, succeeded his father in 1666, and in 1680 married Marie Anne, a daughter of Louis XIV. and Louise de la Vallière. He served with distinction in Flanders in 1683, and against the wish of the king went to Hungary, where he assisted the Imperialists to defeat the Turks at Gran in 1683. After a dissolute life he died at Fontainebleau from smallpox.

FRANÇOIS LOUIS DE BOURBON, prince de Conti (1664-1709), younger brother of the preceding, was known until 1685 as prince de la Roche-sur-Yon. Naturally of great ability, he received an excellent education and was distinguished both for the independence of his mind and the popularity of his manners. On this account he was not received with favour by Louis XIV.; so in 1683 he assisted the Imperialists in Hungary, and while there he wrote some letters in which he referred to Louis as *le roi du théâtre*, for which on his return to France he was temporarily banished to Chantilly. Conti was a favourite of his uncle the great Condé, whose grand-daughter Marie Thérèse de Bourbon (1666-1732) he married in 1688. In 1689 he accompanied his intimate friend Marshal Luxembourg to the Netherlands, and shared in the French victories at Fleurus, Steinkirk and Neerwinden. On the death of his cousin, Jean Louis Charles, duc de Longueville (1646-1694), Conti in accordance with his cousin's will, claimed the principality of Neuchâtel against Marie, duchesse de Nemours (1625-1707), a sister of the duke. He failed to obtain military assistance from the Swiss, and by the king's command yielded the disputed territory to Marie, although the courts of law had decided in his favour. In 1697 Louis XIV. offered him the Polish crown, and by means of bribes the abbé de Polignac secured his election. Conti started rather unwillingly for his new kingdom, probably, as St Simon remarks, owing to his affection for Françoise, wife of Philip II., duke of Orleans, and daughter of Louis XIV. and Madame de Montespan. When he reached Danzig and found his rival Augustus II., elector of Saxony, already in possession of the Polish crown, he returned to France, where he was graciously received by Louis, although St Simon says the king was vexed to see him again. But the misfortunes of the French armies during the earlier years of the war of the Spanish Succession compelled Louis to appoint Conti, whose military renown stood very high, to command the troops in Italy. He fell ill before he could take the field, and died on the 9th of February 1709, his death calling forth exceptional signs of mourning from all classes.

LOUIS ARMAND DE BOURBON, prince de Conti (1606-1727), eldest son of the preceding, was treated with great liberality

by Louis XIV., and also by the regent, Philip duke of Orleans. He served under Marshal Villars in the War of the Spanish Succession, but he lacked the soldierly qualities of his father. In 1713 he married Louise Elisabeth (1693-1775), daughter of Louis Henri de Bourbon, prince de Condé, and grand-daughter of Louis XIV. He was a prominent supporter of the financial schemes of John Law, by which he made large sums of money.

LOUIS FRANÇOIS DE BOURBON, prince de Conti (1717-1776), only son of the preceding, adopted a military career, and when the war of the Austrian Succession broke out in 1741 accompanied Charles Louis, duc de Belle-Isle, to Bohemia. His services there led to his appointment to command the army in Italy, where he distinguished himself by forcing the pass of Villafranca and winning the battle of Coni in 1744. In 1745 he was sent to check the Imperialists in Germany, and in 1746 was transferred to the Netherlands, where some jealousy between Marshal Saxe and himself led to his retirement in 1747. In this year a faction among the Polish nobles offered Conti the crown of that country, where owing to the feeble health of King Augustus III. a vacancy was expected. He won the personal support of Louis XV. for his candidature, although the policy of the French ministers was to establish the house of Saxony in Poland, as the dauphiness was a daughter of Augustus. Louis therefore began secret personal relations with his ambassadors in eastern Europe, who were thus receiving contradictory instructions; a policy known later as the *secret du roi*. Although Conti did not secure the Polish throne he remained in the confidence of Louis until 1755, when his influence was destroyed by the intrigues of Madame de Pompadour; so that when the Seven Years' War broke out in 1756 he was refused the command of the army of the Rhine, and began the opposition to the administration which caused Louis to refer to him as "my cousin the advocate." In 1771 he was prominent in opposition to the chancellor Maupeou. He supported the parlements against the ministry, was especially active in his hostility to Turgot, and was suspected of aiding a rising which took place at Dijon in 1775. Conti, who died on the 2nd of August 1776, inherited literary tastes from his father, was a brave and skilful general, and a diligent student of military history. His house, over which the comtesse de Boufflers presided, was the resort of many men of letters, and he was a patron of Jean Jacques Rousseau.

LOUIS FRANÇOIS JOSEPH, prince de Conti (1734-1814), son of the preceding, possessed considerable talent as a soldier, and distinguished himself during the Seven Years' War. He took the side of Maupeou in the struggle between the chancellor and the parlements, and in 1788 declared that the integrity of the constitution must be maintained. He emigrated owing to the weakness of Louis XVI., but refused to share in the plans for the invasion of France, and returned to his native country in 1790. Arrested by order of the National Convention in 1793, he was acquitted, but was reduced to poverty by the confiscation of his possessions. He afterwards received a pension, but the Directory banished him from France, and as he refused to share in the plots of the royalists he lived at Barcelona till his death in 1814, when the house of Conti became extinct.

See F. de Bassompierre, *Mémoires* (Paris, 1877); G. Tallemant des Reaux, *Historiettes* (Paris, 1854-1860); L. de R. duc de Saint Simon, *Mémoires* (Paris, 1873); C. E. duchesse d'Orleans, *Mémoires* (Paris, 1880); R. L. Marquis d'Argenson, *Journal et mémoires* (Paris, 1859-1865); F. J. de P. cardinal de Bernis, *Mémoires et lettres* (Paris, 1878); J. V. A. duc de Broglie, *Le Secret du roi* (Paris, 1878); P. A. Cheruel, *Histoire de la minorité de Louis XIV et du ministère de Mazarin* (Paris, 1879); E. Boutaric, *Correspondance secrète de Louis XV sur la politique étrangère* (Paris, 1866); P. Foncin, *Essai sur le ministère de Turgot* (Paris, 1877); E. Bourgeois *Neuchâtel et la politique prussienne en Franche-Comté* (Paris, 1877).

CONTI, NICOLÒ DE' (fl. 1419-1444), Venetian explorer and writer, was a merchant of noble family, who left Venice about 1419, on what proved an absence of 25 years. We next find him in Damascus, whence he made his way over the north Arabian desert, the Euphrates, and southern Mesopotamia, to Bagdad. Here he took ship and sailed down the Tigris to Basra and the head of the Persian Gulf; he next descended the gulf to Ormuz, coasted along the Indian Ocean shore of

Persia (at one port of which he remained some time, and entered into a business partnership with some Persian merchants), and so reached the gulf and city of Cambay, where he began his Indian life and observations. He next dropped down the west coast of India to Ely, and struck inland to Vijayanagar, the capital of the principal Hindu state of the Deccan, destroyed in 1555. Of this city Conti gives an elaborate description, one of the most interesting portions of his narrative. From Vijayanagar and the Tungabudhra he travelled to Maliapur near Madras, the traditional resting-place of the body of St Thomas, and the holiest shrine of the native Nestorian Christians, then "scattered over all India," the Venetian declares, "as the Jews are among us." The narrative next refers to Ceylon, and gives a very accurate account of the Cingalese cinnamon tree; but, if Conti visited the island at all, it was probably on the return journey. His outward route now took him to Sumatra, where he stayed a year, and of whose cruel, brutal, cannibal natives he gained a pretty full knowledge, as of the camphor, pepper and gold of this "Taprobana." From Sumatra a stormy voyage of sixteen days brought him to Tenasserim, near the head of the Malay Peninsula. We then find him at the mouth of the Ganges, and trace him ascending and descending that river (a journey of several months), visiting Burdwan and Aracan, penetrating into Burma, and navigating the Irawadi to Ava. He appears to have spent some time in Pegu, from which he again plunged into the Malay Archipelago, and visited Java, his farthest point. Here he remained nine months, and then began his return by way of *Ciampa* (usually Cochin-China in later medieval European literature, but here perhaps some more westerly portion of Indo-China); a month's voyage from Ciampa brought him to *Coloen*, doubtless Kulam or Quilon, in the extreme south-west of India. Thence he continued his homeward route, touching at Cochin, Calicut and Cambay, to Sokotra, which he describes as still mainly inhabited by Nestorian Christians; to the "rich city" of Aden, "remarkable for its buildings"; to *Gidda* or Jidda, the port of Mecca; over the desert to *Carras* or Cairo; and so to Venice, where he arrived in 1444.

As a penance for his (compulsory) renunciation of the Christian faith during his wanderings, Eugenius IV. ordered him to relate his history to Poggio Bracciolini, the papal secretary. The narrative closes with Conti's elaborate replies to Poggio's question on Indian life, social classes, religion, fashions, manners, customs and peculiarities of various kinds. Following a prevalent fashion, the Venetian divides his Indies into three parts, the first extending from Persia to the Indus; the second from the Indus to the Ganges; the third including all beyond the Ganges; this last he considered to excel the others in wealth, culture and magnificence, and to be abreast of Italy in civilization. We may note, moreover, Conti's account of the bamboo in the Ganges valley; of the catching, taming and rearing of elephants in Burma and other regions; of Indian tattooing and the use of leaves for writing; of various Indian fruits, especially the jack and mango; of the polyandry of Malabar; of the cock-fighting of Java; of what is apparently the bird of Paradise; of Indian funeral ceremonies, and especially *suttee*; of the self-mutilation and immolation of Indian fanatics; and of Indian magic, navigation ("they are not acquainted with the compass"), justice, &c. Several venerable legends are reproduced; and Conti's name-forms, partly through Poggio's vicious classicism, are often absolutely unrecognizable; but on the whole this is the best account of southern Asia by any European of the 15th century; while the traveller's visit to Sokotra is an almost though not quite unique performance for a Latin Christian of the middle ages.

The original Latin is in Poggio's *De varietate Fortunae*, book iv.; see the edition of the Abbé Oliva (Paris, 1723). The Italian version, printed in Ramusio's *Navigazioni et viaggi*, vol. i., is only from a Portuguese translation made in Lisbon. An English translation with short notes was made by J. Winter Jones for the Hakluyt Society in the vol. entitled *India in the Fifteenth Century* (London, 1857); an introductory account of the traveller and his work by R. H. Major precedes. (C. R. B.)

**CONTINENT** (from Lat. *continere*, "to hold together"; hence "connected," "continuous"), a word used in physical geography of the larger continuous masses of land in contrast to the great oceans, and as distinct from the submerged tracts where only the higher parts appear above the sea, and from islands generally.

On looking at a map of the world, continents appear generally as wedge-shaped tracts pointing southward, while the oceans have a polygonal shape. Eurasia is in some sense an exception, but all the southern terminations of the continents advance into the sea in the form of a wedge—South America, South Africa, Arabia, India, Malaysia and Australia connected by a submarine platform with Tasmania. It is difficult not to believe that these remarkable characters have some relation to the structure of the great globe-mass, and according to T. C. Chamberlin and R. D. Salisbury, in their *Geology* (1906), "the true conception is perhaps that the ocean basins and continental platforms are but the surface forms of great segments of the lithosphere, all of which crowd towards the centre, the stronger and heavier—the ocean basins—taking precedence and squeezing the weaker and lighter ones—the continents—between them." "The area of the most depressed, or master segments, is almost exactly twice that of the protruding or squeezed ones. This estimate includes in the latter about 10,000,000 sq. m. now covered with shallow water. The volume of the hydrosphere is a little too great for the true basins, and it runs over, covering the borders of the continents" (see CONTINENTAL SHELF). Several theories have been advanced to account for the roughly triangular shape of the continents, but that presenting the least difficulty is the one expressed above, "since in a spherical surface divided into larger and smaller segments the major part should be polygonal, while the minor residual segments are more likely to be triangular."

As bearing on this geological idea, it is interesting to notice in this connexion that the areas of volcanic activity are mostly where continent and ocean meet; and that around the continents there is an almost continuous "deep" from 100 to 300 m. broad, of which the Challenger Deep (11,400 ft.) and the great Tuscarora Deep are fragments. If on a map of the world a broad inked brush be swept seawards round Africa, passing into the Mediterranean, round North and South America, round India, then continuously south of Java and round Australia south of Tasmania and northward to the tropic, this broad band will represent the encircling ribbon-like "deep," which gives strength to the suggestion that the continents in their main features are permanent forms and that their structural connexion with the oceans is not temporary and accidental. The great protruding or "squeezed" segments are the Eurasian (with an area roughly of twenty-four, reckoning in millions of square miles), strongly ridged on the south and east, and relatively flat on the north-west; the African (twelve), rather strongly ridged on the east, less abruptly on the west and north; the North American (ten), strongly ridged on the west, more gently on the east, and relatively flat on the north and in the interior; the South American (nine), strongly ridged on the west and somewhat on the north-east and south-east, leaving ten for the smaller blocks. The sum of these will represent one-third of the earth's surface, while the remaining two-thirds is covered by the ocean.

The foundation structure of the continents is everywhere similar. Their resulting rocks and soils are due to differential minor movements in the past, by which deposits of varying character were produced. These movements, taking place periodically and followed by long periods of rest, produce continued stability for the development and migration of forms of life, the grading of rivers, the development of varied characteristic land forms, the migration and settlement of human beings, the facility or difficulty of intelligent intercourse between races and communities, with finally the commercial interchange of those commodities produced by varying climatic conditions upon different parts of the continental surface; in short, for those geographical factors which form the chief product of past and present human history. (See GEOGRAPHY.)

**CONTINENTAL SHELF**, the term in physical geography for the submerged platform upon which a continent or island stands in relief. If a coin or medal be partly sunk under water the image and superscription will stand above water and represent a continent with adjacent islands; the sunken part just submerged will represent the continental shelf and the edge of the coin the boundary between it and the surrounding deep, called by Professor H. K. H. Wagner the continental slope. If the lithosphere surface be divided into three parts, namely, the continent heights, the ocean depths, and the transitional area separating them, it will be found that this transitional area is almost bisected by the coast-line, that nearly one-half of it (10,000,000 sq. m.) lies under water less than 100 fathoms deep, and the remainder 12,000,000 sq. m. is under 600 ft. in elevation. There are thus two continuous plain systems, one above water and one under water, and the second of these is called the continental shelf. It represents the area which would be added to the land surface if the sea fell 600 ft. This shelf varies in width. Round Africa—except to the south—and off the western coasts of America it scarcely exists. It is wide under the British Islands and extends as a continuous platform under the North Sea, down the English Channel to the south of France; it unites Australia to New Guinea on the north and to Tasmania on the south, connects the Malay Archipelago along the broad shelf east of China with Japan, unites north-western America with Asia, sweeps in a symmetrical curve outwards from north-eastern America towards Greenland, curving downwards outside Newfoundland and holding Hudson Bay in the centre of a shallow dish. In many places it represents the land planed down by wave action to a plain of marine denudation, where the waves have battered down the cliffs and dragged the material under water. If there were no compensating action in the differential movement of land and sea in the transitional area, the whole of the land would be gradually planed down to a submarine platform, and all the globe would be covered with water. There are, however, periodical warpings of this transitional area by which fresh areas of land are raised above sea-level, and fresh continental coast-lines produced, while the sea tends to sink more deeply into the great ocean basins, so that the continents slowly increase in size. "In many cases it is possible that the continental shelf is the end of a low plain submerged by subsidence; in others a low plain may be an upheaved continental shelf, and probably wave action is only one of the factors at work" (H. R. Mill, *Realm of Nature*, 1897).

**CONTINUED FRACTIONS.** In mathematics, an expression of the form

$$a_1 \pm \frac{b_2}{a_2 \pm \frac{b_3}{a_3 \pm \frac{b_4}{a_4 \pm \dots}}}$$

where  $a_1, a_2, a_3, \dots$  and  $b_2, b_3, b_4, \dots$  are any quantities whatever, positive or negative, is called a "continued fraction." The quantities  $a_1, \dots, b_2, \dots$  may follow any law whatsoever. If the continued fraction terminates, it is said to be a *terminating* continued fraction; if the number of the quantities  $a_1, \dots, b_2, \dots$  is infinite it is said to be a *non-terminating* or *infinite* continued fraction. If  $b_2/a_2, b_3/a_3, \dots$ , the *component fractions*, as they are called, recur, either from the commencement or from some fixed term, the continued fraction is said to be *recurring* or *periodic*. It is obvious that every terminating continued fraction reduces to a commensurable number.

The notation employed by English writers for the general continued fraction is

$$a_1 \pm \frac{b_2}{a_2 \pm \frac{b_3}{a_3 \pm \frac{b_4}{a_4 \pm \dots}}}$$

Continental writers frequently use the notation

$$a_1 \pm \frac{b_2}{a_2} \pm \frac{b_3}{a_3} \pm \frac{b_4}{a_4} \pm \dots, \text{ or } a_1 \pm \frac{b_2}{a_2} \pm \frac{b_3}{a_3} \pm \frac{b_4}{a_4} \pm \dots$$

The terminating continued fractions

$$a_1, \quad a_1 + \frac{b_2}{a_2}, \quad a_1 + \frac{b_2}{a_2} + \frac{b_3}{a_3}, \quad a_1 + \frac{b_2}{a_2} + \frac{b_3}{a_3} + \frac{b_4}{a_4}, \dots$$

reduced to the forms

$$\frac{a_1}{1}, \quad \frac{a_1 a_2 + b_2}{a_2}, \quad \frac{a_1 a_2 a_3 + b_2 a_3 + b_3 a_1}{a_2 a_3 + b_3}, \dots$$

$$\frac{a_1 a_2 a_3 a_4 + b_2 a_3 a_4 + b_3 a_1 a_4 + b_4 a_1 a_2 + b_5 a_1}{a_2 a_3 a_4 + a_4 b_3 + a_2 b_4}, \dots$$

are called the successive *convergents* to the general continued fraction.

Their numerators are denoted by  $p_1, p_2, p_3, p_4, \dots$ ; their denominators by  $q_1, q_2, q_3, q_4, \dots$ . We have the relations

$$p_n = a_n p_{n-1} + b_n p_{n-2}, \quad q_n = a_n q_{n-1} + b_n q_{n-2}.$$

In the case of the fraction  $a_1 - \frac{b_2}{a_2 - \frac{b_3}{a_3 - \frac{b_4}{a_4 - \dots}}}$ , we have the relations  $p_n = a_n p_{n-1} - b_n p_{n-2}$ ,  $q_n = a_n q_{n-1} - b_n q_{n-2}$ .

Taking the quantities  $a_1, \dots, b_2, \dots$  to be all positive, a continued fraction of the form  $a_1 + \frac{b_2}{a_2 + \frac{b_3}{a_3 + \dots}}$  is called a *continued fraction of the first class*; a continued fraction of the form  $\frac{b_2}{a_2 - \frac{b_3}{a_3 - \frac{b_4}{a_4 - \dots}}}$  is called a *continued fraction of the second class*.

A continued fraction of the form  $a_1 + \frac{1}{a_2 + \frac{1}{a_3 + \frac{1}{a_4 + \dots}}}$ , where  $a_1, a_2, a_3, a_4, \dots$  are all positive integers, is called a *simple continued fraction*. In the case of this fraction  $a_1, a_2, a_3, a_4, \dots$  are called the successive *partial quotients*. It is evident that, in this case,

$$p_1, p_2, p_3, \dots, \quad q_1, q_2, q_3, \dots,$$

are two series of positive integers increasing without limit if the fraction does not terminate.

The general continued fraction  $a_1 + \frac{b_2}{a_2 + \frac{b_3}{a_3 + \frac{b_4}{a_4 + \dots}}}$  is evidently equal, convergent by convergent, to the continued fraction

$$a_1 + \frac{\lambda_2 b_2}{\lambda_2 a_2 + \frac{\lambda_3 \lambda_2 b_3}{\lambda_3 a_3 + \frac{\lambda_4 \lambda_2 \lambda_3 b_4}{\lambda_4 a_4 + \dots}}}$$

where  $\lambda_2, \lambda_3, \lambda_4, \dots$  are any quantities whatever, so that by choosing  $\lambda_2 b_2 = 1, \lambda_3 \lambda_2 b_3 = 1, \&c.$ , it can be reduced to any equivalent continued fraction of the form  $a_1 + \frac{1}{a_2 + \frac{1}{a_3 + \frac{1}{a_4 + \dots}}}$ .

*Simple Continued Fractions.*

1. The simple continued fraction is both the most interesting and important kind of continued fraction.

Any quantity, commensurable or incommensurable, can be expressed uniquely as a simple continued fraction, terminating in the case of a commensurable quantity, non-terminating in the case of an incommensurable quantity. A non-terminating simple continued fraction must be incommensurable.

In the case of a terminating simple continued fraction the number of partial quotients may be odd or even as we please by writing the last partial quotient,  $a_n$  as  $a_n - 1 + \frac{1}{1}$ .

The numerators and denominators of the successive convergents obey the law  $p_n q_{n-1} - p_{n-1} q_n = (-1)^n$ , from which it follows at once that every convergent is in its lowest terms. The other principal properties of the convergents are:—

The odd convergents form an increasing series of rational fractions continually approaching to the value of the whole continued fraction; the even convergents form a decreasing series having the same property.

Every even convergent is greater than every odd convergent; every odd convergent is less than, and every even convergent greater than, any following convergent.

Every convergent is nearer to the value of the whole fraction than any preceding convergent.

Every convergent is a nearer approximation to the value of the whole fraction than any fraction whose denominator is less than that of the convergent.

The difference between the continued fraction and the  $n^{\text{th}}$  convergent is less than  $\frac{1}{q_n q_{n+1}}$ , and greater than  $\frac{a_{n+2}}{q_n q_{n+2}}$ . These limits may be replaced by the following, which, though not so close, are simpler, viz.  $\frac{1}{q_n^2}$  and  $\frac{1}{q_n(q_n + q_{n+1})}$ .

Every simple continued fraction must converge to a definite limit; for its value lies between that of the first and second convergents and, since

$$\frac{p_n}{q_n} - \frac{p_{n-1}}{q_{n-1}} = \frac{1}{q_n q_{n-1}}, \quad \text{Lt. } \frac{p_n}{q_n} = \text{Lt. } \frac{p_{n-1}}{q_{n-1}},$$

so that its value cannot oscillate.

The chief practical use of the simple continued fraction is that by means of it we can obtain rational fractions which approximate to any quantity, and we can also estimate the error of our

approximation. Thus a continued fraction equivalent to  $\pi$  (the ratio of the circumference to the diameter of a circle) is

$$3 + \frac{1}{7 + \frac{1}{15 + \frac{1}{1 + \frac{1}{292 + \frac{1}{1 + \frac{1}{1 + \dots}}}}}}$$

of which the successive convergents are

$$\frac{3}{1}, \frac{22}{7}, \frac{333}{106}, \frac{355}{113}, \frac{103993}{33102}, \&c.,$$

the fourth of which is accurate to the sixth decimal place, since the error lies between  $1/q_4q_5$  or  $\cdot 0000002673$  and  $a_5/q_4q_5$  or  $\cdot 0000002665$ .

Similarly the continued fraction given by Euler as equivalent to  $\frac{1}{2}(e-1)$  ( $e$  being the base of Napierian logarithms), viz.

$$\frac{1}{1 + \frac{1}{6 + \frac{1}{10 + \frac{1}{14 + \frac{1}{18 + \dots}}}}}$$

may be used to approximate very rapidly to the value of  $e$ .

For the application of continued fractions to the problem "To find the fraction, whose denominator does not exceed a given integer  $D$ , which shall most closely approximate (by excess or defect, as may be assigned) to a given number commensurable or incommensurable," the reader is referred to G. Chrystal's *Algebra*, where also may be found details of the application of continued fractions to such interesting and important problems as the recurrence of eclipses and the rectification of the calendar (*q.v.*).

Lagrange used simple continued fractions to approximate to the solutions of numerical equations; thus, if an equation has a root between two integers  $a$  and  $a+1$ , put  $x = a + 1/y$  and form the equation in  $y$ ; if the equation in  $y$  has a root between  $b$  and  $b+1$ , put  $y = b + 1/z$ , and so on. Such a method is, however, too tedious, compared with such a method as Horner's, to be of any practical value.

The solution in integers of the indeterminate equation  $ax + by = c$  may be effected by means of continued fractions. If we suppose  $a/b$  to be converted into a continued fraction and  $p/q$  to be the penultimate convergent, we have  $aq - bp = +1$  or  $-1$ , according as the number of convergents is even or odd, which we can take them to be as we please. If we take  $aq - bp = +1$  we have a general solution in integers of  $ax + by = c$ , viz.  $x = cq - bt$ ,  $y = at - cp$ ; if we take  $aq - bp = -1$ , we have  $x = bt - cq$ ,  $y = cp - at$ .

An interesting application of continued fractions to establish a unique correspondence between the elements of an aggregate of  $m$  dimensions and an aggregate of  $n$  dimensions is given by G. Cantor in vol. 2 of the *Acta Mathematica*.

Applications of simple continued fractions to the theory of numbers, as, for example, to prove the theorem that a divisor of the sum of two squares is itself the sum of two squares, may be found in J. A. Serret's *Cours d'Algebre Supérieure*.

2. *Recurring Simple Continued Fractions*.—The infinite continued fraction

$$a_1 + \frac{1}{a_2 + \frac{1}{a_3 + \dots + \frac{1}{a_n + \frac{1}{b_1 + \frac{1}{b_2 + \dots + \frac{1}{b_n + \frac{1}{b_1 + \dots}}}}}}}$$

where, after the  $n^{\text{th}}$  partial quotient, the cycle of partial quotients  $b_1, b_2, \dots, b_n$  recur in the same order, is the type of a recurring simple continued fraction.

The value of such a fraction is the positive root of a quadratic equation whose coefficients are real and of which one root is negative. Since the fraction is infinite it cannot be commensurable and therefore its value is a quadratic surd number. Conversely every positive quadratic surd number, when expressed as a simple continued fraction, will give rise to a recurring fraction. Thus

$$2 - \sqrt{3} = \frac{1}{3 + \frac{1}{1 + \frac{1}{2 + \frac{1}{1 + \frac{1}{2 + \dots}}}}}$$

$$\sqrt{28} = 5 + \frac{1}{3 + \frac{1}{2 + \frac{1}{3 + \frac{1}{10 + \frac{1}{3 + \frac{1}{2 + \frac{1}{3 + \frac{1}{10 + \dots}}}}}}}}$$

The second case illustrates a feature of the recurring continued fraction which represents a complete quadratic surd. There is only one non-recurring partial quotient  $a_1$ . If  $b_1, b_2, \dots, b_n$  is the cycle of recurring quotients, then  $b_n = 2a_1$ ,  $b_1 = b_{n-1}$ ,  $b_2 = b_{n-2}$ ,  $b_3 = b_{n-3}$ , &c.

In the case of a recurring continued fraction which represents  $\sqrt{N}$ , where  $N$  is an integer, if  $n$  is the number of partial quotients in the recurring cycle, and  $p_{nr}/q_{nr}$  the  $nr^{\text{th}}$  convergent, then  $p_{nr}^2 - Nq_{nr}^2 = (-1)^{nr}$ , whence, if  $n$  is odd, integral solutions of the indeterminate equation  $x^2 - Ny^2 = \pm 1$  (the so-called Pellian equation) can be found. If  $n$  is even, solutions of the equation  $x^2 - Ny^2 = +1$  can be found.

The theory and development of the simple recurring continued fraction is due to Lagrange. For proofs of the theorems here stated and for applications to the more general indeterminate equation  $x^2 - Ny^2 = H$  the reader may consult Chrystal's *Algebra* or Serret's *Cours d'Algebre Supérieure*; he may also profitably consult a tract by T. Muir, *The Expression of a Quadratic Surd as a Continued Fraction* (Glasgow, 1874).

*The General Continued Fraction.*

1. *The Evaluation of Continued Fractions*.—The numerators and denominators of the convergents to the general continued fraction both satisfy the difference equation  $u_n = a_n u_{n-1} + b_n u_{n-2}$ . When we

can solve this equation we have an expression for the  $n^{\text{th}}$  convergent to the fraction, generally in the form of the quotient of two series, each of  $n$  terms. As an example, take the fraction (known as Brouncker's fraction, after Lord Brouncker)

$$\frac{1}{1 + \frac{1^2}{2 + \frac{2^2}{2 + \frac{3^2}{2 + \frac{4^2}{2 + \dots}}}}}$$

Here we have

$$u_{n+1} = 2u_n + (2n-1)^2 u_{n-1},$$

whence

$$u_{n+1} - (2n+1)u_n = -(2n-1)(u_n - (2n-1)u_{n-1}),$$

and we readily find that

$$\frac{p_n}{q_n} = 1 - \frac{1}{3} + \frac{1}{5} - \frac{1}{7} + \dots = \frac{1}{2n+1},$$

whence the value of the fraction taken to infinity is  $\frac{1}{2}$ .

It is always possible to find the value of the  $n^{\text{th}}$  convergent to a recurring continued fraction. If  $r$  be the number of quotients in the recurring cycle, we can by writing down the relations connecting the successive  $p$ 's and  $q$ 's obtain a linear relation connecting

$$p_{nr+m}, p_{(n-1)r+m}, p_{(n-2)r+m},$$

in which the coefficients are all constants. Or we may proceed as follows. (We need not consider a fraction with a non-recurring part). Let the fraction be

$$\frac{a_1}{b_1 + \frac{a_2}{b_2 + \dots + \frac{a_r}{b_r + \frac{a_1}{b_1 + \dots}}}}$$

Let  $u_n = \frac{p_{nr+m}}{q_{nr+m}}$ ; then  $u_n = \frac{a_1}{b_1 + \frac{a_2}{b_2 + \dots + \frac{a_r}{b_r + u_{n-1}}}}$ , leading to an equation of the form  $Au_n u_{n-1} + Bu_n + Cu_{n-1} + D = 0$ , where  $A, B, C, D$  are independent of  $n$ , which is readily solved.

2. *The Convergence of Infinite Continued Fractions*.—We have seen that the simple infinite continued fraction converges. The infinite general continued fraction of the first class cannot diverge for its value lies between that of its first two convergents. It may, however, oscillate. We have the relation  $p_n q_{n-1} - p_{n-1} q_n = (-1)^n b_2 b_3 \dots b_n$ , from which  $\frac{p_n}{q_n} - \frac{p_{n-1}}{q_{n-1}} = (-1)^n \frac{b_2 b_3 \dots b_n}{q_n q_{n-1}}$ , and the limit of the right-hand side is not necessarily zero.

The tests for convergency are as follows:

Let the continued fraction of the first class be reduced to the form

$$d_1 + \frac{1}{d_2 + \frac{1}{d_3 + \frac{1}{d_4 + \dots}}}$$

then it is convergent if at least one of the series  $d_2 + d_3 + d_4 + \dots$ ,  $d_2 + d_4 + d_6 + \dots$  diverges, and oscillates if both these series converge.

For the convergence of the continued fraction of the second class there is no complete criterion. The following theorem covers a large number of important cases.

"If in the infinite continued fraction of the second class  $a_n \geq b_n + 1$  for all values of  $n$ , it converges to a finite limit not greater than unity."

3. *The Incommensurability of Infinite Continued Fractions*.—There is no general test for the incommensurability of the general infinite continued fraction.

Two cases have been given by Legendre as follows:—

If  $a_2, a_3, \dots, a_n, b_2, b_3, \dots, b_n$  are all positive integers, then

I. The infinite continued fraction  $\frac{b_2}{a_2 + a_3 + \dots + a_n} + \frac{b_n}{a_n + \dots}$  converges to an incommensurable limit if after some finite value of  $n$  the condition  $a_n < b_n$  is always satisfied.

II. The infinite continued fraction  $\frac{b_2}{a_2 - a_3 - \dots - a_n} - \frac{b_n}{a_n - \dots}$  converges to an incommensurable limit if after some finite value of  $n$  the condition  $a_n \geq b_n + 1$  is always satisfied, where the sign  $>$  need not always occur but must occur *infinitely often*.

*Continuants.*

The functions  $p_n$  and  $q_n$ , regarded as functions of  $a_1, \dots, a_n, b_2, \dots, b_n$  determined by the relations

$$p_n = a_n p_{n-1} + b_n p_{n-2},$$

$$q_n = a_n q_{n-1} + b_n q_{n-2},$$

with the conditions  $p_1 = a_1, p_0 = 1; q_2 = a_2, q_1 = 1, q_0 = 0$ , have been studied under the name of *continuants*. The notation adopted is

$$p_n = K \left( \begin{matrix} b_2, \dots, b_n \\ a_1, a_2, \dots, a_n \end{matrix} \right),$$

and it is evident that we have

$$q_n = K \left( \begin{matrix} b_2, \dots, b_n \\ a_2, a_3, \dots, a_n \end{matrix} \right).$$

The theory of continuants is due in the first place to Euler. The reader will find the theory completely treated in Chrystal's *Algebra*, where will be found the exhibition of a prime number of the form  $4p+1$  as the actual sum of two squares by means of continuants, a result given by H. J. S. Smith.

The continuant  $K\left(\begin{smallmatrix} b_1, b_2, \dots, b_n \\ a_1, a_2, a_3, \dots, a_n \end{smallmatrix}\right)$  is also equal to the determinant

$$\begin{vmatrix} a_1 & b_1 & 0 & 0 & \dots & 0 \\ -1 & a_2 & b_2 & 0 & \dots & 0 \\ 0 & -1 & a_3 & b_3 & \dots & 0 \\ 0 & 0 & -1 & a_4 & b_4 & \dots \\ \dots & \dots & \dots & \dots & \dots & \dots \\ 0 & 0 & - & - & 0 & -1 & a_{n-1} & b_n \\ 0 & 0 & - & - & 0 & 0 & -1 & a_n \end{vmatrix}$$

from which point of view continuants have been treated by W. Spottiswoode, J. J. Sylvester and T. Muir. Most of the theorems concerning continued fractions can be thus proved simply from the properties of determinants (see T. Muir's *Theory of Determinants*, chap. iii.).

Perhaps the earliest appearance in analysis of a continuant in its determinant form occurs in Lagrange's investigation of the vibrations of a stretched string (see Lord Rayleigh, *Theory of Sound*, vol. i. chap. iv.).

*The Conversion of Series and Products into Continued Fractions.*

1. A continued fraction may always be found whose  $n^{\text{th}}$  convergent shall be equal to the sum to  $n$  terms of a given series or the product to  $n$  factors of a given continued product. In fact, a continued fraction  $\frac{b_1}{a_1 + \frac{b_2}{a_2 + \dots + \frac{b_n}{a_n}}}$  can be constructed having for the numerators of its successive convergents any assigned quantities  $p_1, p_2, p_3, \dots, p_n$ , and for their denominators any assigned quantities  $q_1, q_2, q_3, \dots, q_n$ .

The partial fraction  $b_n/a_n$  corresponding to the  $n^{\text{th}}$  convergent can be found from the relations

$$p_n = a_n p_{n-1} + b_n p_{n-2}, \quad q_n = a_n q_{n-1} + b_n q_{n-2};$$

and the first two partial quotients are given by

$$b_1 = p_1, \quad a_1 = q_1, \quad b_1 a_2 = p_2, \quad a_1 a_2 + b_2 = q_2.$$

If we form then the continued fraction in which  $p_1, p_2, p_3, \dots, p_n$  are  $u_1, u_1 + u_2, u_1 + u_2 + u_3, \dots, u_1 + u_2 + \dots + u_n$ , and  $q_1, q_2, q_3, \dots, q_n$  are all unity, we find the series  $u_1 + u_2 + \dots + u_n$  equivalent to the continued fraction

$$\frac{u_1}{1 - \frac{u_2}{1 + \frac{u_3}{1 - \frac{u_4}{\dots - 1 + \frac{u_n}{u_{n-1}}}}}}$$

which we can transform into

$$\frac{u_1}{1 - \frac{u_2}{u_1 + u_2} - \frac{u_1 u_3}{u_2 + u_3} - \frac{u_2 u_4}{u_3 + u_4} - \dots - \frac{u_{n-2} u_n}{u_{n-1} + u_n}}$$

a result given by Euler.

2. In this case the sum to  $n$  terms of the series is equal to the  $n^{\text{th}}$  convergent of the fraction. There is, however, a different way in which a series may be represented by a continued fraction. We may require to represent the infinite convergent power series  $a_0 + a_1 x + a_2 x^2 + \dots$  by an infinite continued fraction of the form

$$\frac{\beta_0}{1 - \frac{\beta_1 x}{1 - \frac{\beta_2 x}{1 - \frac{\beta_3 x}{\dots}}}}$$

Here the fraction converges to the sum to infinity of the series. Its  $n^{\text{th}}$  convergent is not equal to the sum to  $n$  terms of the series. Expressions for  $\beta_0, \beta_1, \beta_2, \dots$  by means of determinants have been given by T. Muir (*Edinburgh Transactions*, vol. xxvii.).

A method was given by J. H. Lambert for expressing as a continued fraction of the preceding type the quotient of two convergent power series. It is practically identical with that of finding the greatest common measure of two polynomials. As an instance leading to results of some importance consider the series

$$F(n, x) = 1 + \frac{x}{(\gamma+n)1!} + \frac{x^2}{(\gamma+n)(\gamma+n+1)2!} + \dots$$

We have

$$F(n+1, x) - F(n, x) = -\frac{x}{(\gamma+n)(\gamma+n+1)} F(n+2, x),$$

whence we obtain

$$\frac{F(1, x)}{F(0, x)} = \frac{1}{1 + \frac{x/\gamma(\gamma+1)}{1 + \frac{x/(\gamma+1)(\gamma+2)}{1 + \dots}}}$$

which may also be written

$$\frac{\gamma}{\gamma + \frac{x}{\gamma + 1 + \frac{x}{\gamma + 2 + \dots}}}$$

By putting  $x = x^2/4$  for  $x$  in  $F(0, x)$  and  $F(1, x)$ , and putting at the same time  $\gamma = 1/2$ , we obtain

$$\tanh x = \frac{x}{1 - \frac{x^2}{3} - \frac{x^2}{5} - \frac{x^2}{7} - \dots} \quad \tanh x = \frac{x}{1 + \frac{x^2}{3} + \frac{x^2}{5} + \frac{x^2}{7} + \dots}$$

These results were given by Lambert, and used by him to prove that  $\pi$  and  $\pi^2$  are incommensurable, and also any commensurable power of  $e$ .

Gauss in his famous memoir on the hypergeometric series

$$F(a, \beta, \gamma, x) = 1 + \frac{a\beta}{1 \cdot \gamma} x + \frac{a(a+1)\beta(\beta+1)}{1 \cdot 2 \cdot \gamma \cdot (\gamma+1)} x^2 + \dots$$

gave the expression for  $F(a, \beta+1, \gamma+1, x) + F(a, \beta, \gamma, x)$  as a continued fraction, from which if we put  $\beta=0$  and write  $\gamma-1$  for  $\gamma$ , we get the transformation

$$1 + \frac{a}{\gamma} x + \frac{a(a+1)}{\gamma(\gamma+1)} x^2 + \frac{a(a+1)(a+2)}{\gamma(\gamma+1)(\gamma+2)} x^3 + \dots = \frac{1}{1 - \frac{\beta_1 x}{1 - \frac{\beta_2 x}{\dots}}}$$

$$\beta_1 = \frac{a}{\gamma}, \beta_2 = \frac{(a+1)\gamma}{(\gamma+1)(\gamma+2)}, \dots, \beta_{2n-1} = \frac{(a+n-1)(\gamma+n-2)}{(\gamma+2n-3)(\gamma+2n-2)},$$

$$\beta_2 = \frac{\gamma-a}{\gamma(\gamma+1)}, \beta_4 = \frac{2(\gamma+1-a)}{(\gamma+2)(\gamma+3)}, \dots, \beta_{2n} = \frac{n(\gamma+n-1-a)}{(\gamma+2n-2)(\gamma+2n-1)}.$$

From this we may express several of the elementary series as continued fractions; thus taking  $a=1, \gamma=2$ , and putting  $x$  for  $-x$ , we have  $\log(1+x) = \frac{x}{1} - \frac{1^2 x}{2} + \frac{1^2 x}{3} - \frac{2^2 x}{4} + \frac{2^2 x}{5} - \frac{3^2 x}{6} + \frac{3^2 x}{7} - \dots$

Taking  $\gamma=1$ , writing  $x/a$  for  $x$  and increasing  $a$  indefinitely, we have  $e^x = \frac{1}{1} - \frac{x}{1} + \frac{x}{2} - \frac{x}{3} + \frac{x}{4} - \frac{x}{5} + \dots$

For some recent developments in this direction the reader may consult a paper by L. J. Rogers in the *Proceedings of the London Mathematical Society* (series 2, vol. 4).

*Ascending Continued Fractions.*

There is another type of continued fraction called the ascending continued fraction, the type so far discussed being called the descending continued fraction. It is of no interest or importance, though both Lambert and Lagrange devoted some attention to it. The notation for this type of fraction is

$$a_1 + \frac{b_1 + \frac{b_2 + \frac{b_3 + \frac{b_4 + \dots}{a_5}}{a_4}}{a_3}}{a_2}$$

It is obviously equal to the series

$$a_1 + \frac{b_1}{a_2} + \frac{b_2}{a_2 a_3} + \frac{b_3}{a_2 a_3 a_4} + \frac{b_4}{a_2 a_3 a_4 a_5} + \dots$$

*Historical Note.*

The invention of continued fractions is ascribed generally to Pietro Antonia Cataldi, an Italian mathematician who died in 1626. He used them to represent square roots, but only for particular numerical examples, and appears to have had no theory on the subject. A previous writer, Rafaello Bombelli, had used them in his treatise on Algebra (about 1579), and it is quite possible that Cataldi may have got his ideas from him. His chief advance on Bombelli was in his notation. They next appear to have been used by Daniel Schwenter (1585-1636) in a *Geometrica Practica* published in 1618. He uses them for approximations. The theory, however, starts with the publication in 1655 by Lord Brouncker of the continued fraction  $\frac{1}{1} + \frac{1^2}{2} + \frac{3^2}{2} + \frac{5^2}{2} + \dots$  as an equivalent of  $\pi/4$ . This he is supposed to have deduced, no one knows how, from Wallis' formula for  $4/\pi$ , viz.  $\frac{3 \cdot 3 \cdot 5 \cdot 5 \cdot 7 \cdot 7 \dots}{2 \cdot 4 \cdot 4 \cdot 6 \cdot 6 \cdot 8 \dots}$

John Wallis, discussing this fraction in his *Arithmetica Infinitorum* (1656), gives many of the elementary properties of the convergents to the general continued fraction, including the rule for their formation. Huygens (*Descriptio automati planetarii*, 1703) uses the simple continued fraction for the purpose of approximation when designing the toothed wheels of his *Planetarium*. Nicol Saunderson (1682-1739), Euler and Lambert helped in developing the theory, and much was done by Lagrange in his additions to the French edition of Euler's *Algebra* (1795). Moritz A. Stern wrote at length on the subject in *Crelle's Journal* (x., 1833; xi., 1834; xviii., 1838). The theory of the convergence of continued fractions is due to Oscar Schlömilch, P. F. Arndt, P. L. Seidel and Stern. O. Stolz, A. Pringsheim and E. B. van Vleck have written on the convergence of infinite continued fractions with complex elements.

REFERENCES.—For the further history of continued fractions we may refer the reader to two papers by Gunther and A. N. Favaro, *Bulletins di bibliographia e di storia delle scienze matematiche e fisiche*, t. vii., and to M. Cantor, *Geschichte der Mathematik*, 2nd Bd. For text-books treating the subject in great detail there are those of G. Chrystal in English; Serret's *Cours d'algèbre supérieure* in French; and in German those of Stern, Schlömilch, Hatterdorff and Stolz. For the application of continued fractions to the theory of



irrational numbers there is P. Bachmann's *Vorlesungen über die Natur der Irrationalzahlen* (1892). For the application of continued fractions to the theory of lenses, see R. S. Heath's *Geometrical Optics*, chaps. iv. and v. For an exhaustive summary of all that has been written on the subject the reader may consult Bd. I of the *Encyclopædie der mathematischen Wissenschaften* (Leipzig). (A. E. J.)

**CONTOUR, CONTOUR-LINE** (a French word meaning generally "outline," from the Med. Lat. *contornare*, to round off), in physical geography a line drawn upon a map through all the points upon the surface represented that are of equal height above sea-level. These points lie, therefore, upon a horizontal plane at a given elevation passing through the land shown on the map, and the contour-line is the intersection of that horizontal plane with the surface of the ground. The contour-line of 0, or *datum level*, is the coastal boundary of any land form. If the sea be imagined as rising 100 ft., a new coast-line, with bays and estuaries indented in the valleys, would appear at the new sea-level. If the sea sank once more to its former level, the 100-ft. contour-line with all its irregularities would be represented by the beach mark made by the sea when 100 ft. higher. If instead of receding the sea rose continuously at the rate of 100 ft. per day, a series of levels 100 ft. above one another would be marked daily upon the land until at last the highest mountain peaks appeared as islands less than 100 ft. high. A record of this series of advances marked upon a flat map of the original country would give a series of concentric contour-lines narrowing towards the mountaintops, which they would at last completely surround. Contour-lines of this character are marked upon most modern maps of small areas and upon all government survey and military maps at varying intervals according to the scale of the map.

**CONTRABAND** (Fr. *contrebande*, from *contra*, against, and *bannum*, Low Lat. for "proclamation"), a term given generally to illegal traffic; and particularly, as "contraband of war," to goods, &c., which subjects of neutral states are forbidden by international law to supply to a belligerent.

According to current practice contraband of war is of two kinds: (1) absolute or unconditional contraband, *i.e.* materials of direct application in naval or military armaments; and (2) conditional contraband, consisting of articles which are fit for, but not necessarily of direct application to, hostile uses. There is much difference of opinion among international jurists and states, however, as to the specific materials and articles which may rightfully be declared by belligerents to belong to either class. There is also disagreement as to the belligerent right where the immediate destination is a neutral but the ultimate an enemy port.

An attempt was made at the Second Hague Conference to come to an agreement on the chief points of difference. The British delegates were instructed even to abandon the principle of contraband of war altogether, subject only to the exclusion by blockade of neutral trade from enemy ports. In the alternative they were to do their utmost to restrict the definition of contraband within the narrowest possible limits, and to obtain exemption of food-stuffs destined for places other than beleaguered fortresses and of raw materials required for peaceful industry. Though the discussions at the conference did not result in any convention, except on the subject of mails, it was agreed among the leading maritime states that an early attempt should be made to codify the law of naval war generally, in connexion with the establishment of an international prize court (see PRIZE).

Meanwhile, on the subject of mails, important articles were adopted which figure in the "Convention on restrictions in the right of capture" (No. 11 of the series as set out in the General Act, see PEACE CONFERENCE). They are as follows:—

**ART. I.**—The postal correspondence of neutrals or belligerents, whatever its official or private character may be, found on the high seas on board a neutral or enemy ship is inviolable. If the ship is detained, the correspondence is forwarded by the captor with the least possible delay.

The provisions of the preceding paragraph do not apply, in case of violation of blockade, to correspondence destined for, or proceeding from, a blockaded port.

**ART. II.**—The inviolability of postal correspondence does not exempt a neutral mail ship from the laws and customs of maritime war as to neutral merchant ships in general. The ship, however, may not be searched except when absolutely necessary, and then only with as much consideration and expedition as possible.

As regards food-stuffs Great Britain has long and consistently held that provisions and liquors fit for the consumption of the enemy's naval or military forces are contraband. Her Prize Act, however, provides a palliative, in the case of "naval or victualling stores," for the penalty attaching to absolute contraband, the lords of the admiralty being entitled to exercise a right of pre-emption over such stores, *i.e.* to purchase them without condemnation in a prize court. In practice, purchases are made at the market value of the goods, with an additional 10% for loss of profit.

On the continent of Europe no such palliative has yet been adopted; but moved by the same desire to distinguish unmistakable from, so to speak, constructive contraband, and to protect trade against the vexation of uncertainty, many continental jurists have come to argue conditional contraband away altogether. This change of opinion has especially manifested itself in the discussions on the subject in the Institute of International Law, a body composed exclusively of recognized international jurists. The rules this body adopted in 1896, though they do not represent the unanimous feeling of its members, may be taken as the view of a large proportion of them. The majority comprised German, Danish, Italian, Dutch and French specialists. The rules adopted contain a clause, which, after declaring conditional contraband abolished, states that: "Nevertheless the belligerent has, at his option and on condition of paying an equitable indemnity, a right of sequestration or pre-emption as to articles (*objets*) which, on their way to a port of the enemy, may serve equally in war or in peace." This rule, it is seen, is of wider application than the above-mentioned provision of the British Prize Act. To become binding in its existing form, either an alteration of the text of the Declaration of Paris or a modification in the wording of the clause would be necessary, seeing that under the Declaration of Paris "the neutral flag covers enemy goods, except contraband of war." It may be said that, in so far as the continent is concerned, expert opinion is, on the whole, favourable to the recognition of conditional contraband in the form of a right of sequestration or pre-emption and within the limits Great Britain has shown a disposition to set to it as against herself.

As regards coal there is no essential difference between the position of coal to feed ships and that of provisions to feed men. Neither is *per se* contraband. At the West African Conference in 1884 the Russian representative protested against its inclusion among contraband articles, but the Russian government included it in their declaration as to contraband on the outbreak of the Russo-Japanese War. In 1898 the British foreign office replied to an inquiry of the Newport Chamber of Commerce on the position of coal that: "Whether in any particular case coal is or is not contraband of war, is a matter *prima facie* for the determination of the Prize Court of the captor's nationality, and so long as such decision, when given, does not conflict with well-established principles of international law, H.M.'s government will not be prepared to take exception thereto." The practical applications of the law and usage of contraband in the Russo-Japanese War of 1904-5, however, brought out vividly the need of reform in these "well-established principles."

The Japanese regulations gave rise to no serious difficulties. Those issued by Russia, on the other hand, led to much controversy between the British government and that of Russia, in connexion with the latter's pretension to class coal, rice, provisions, forage, horses and cotton with arms, ammunition, explosives, &c., as absolute contraband. On June 1, 1904, Lord Lansdowne expressed the surprise with which the British government learnt that rice and provisions were to be treated as unconditionally contraband—"a step which they regarded as inconsistent with

the law and practice of nations." They furthermore "felt themselves bound to reserve their rights by also protesting against the doctrine that it is for the belligerent to decide what articles are as a matter of course, and without reference to other considerations, to be dealt with as contraband of war, regardless of the well-established rights of neutrals"; nor would the British government consider itself bound to recognize as valid the decision of any prize court which violated those rights. It did not dispute the right of a belligerent to take adequate precautions for the purpose of preventing contraband of war, in the hitherto accepted sense of the words, from reaching the enemy; but it objected to the introduction of a new doctrine under which "the well-understood distinction between conditional and unconditional contraband was altogether ignored, and under which, moreover, on the discovery of articles alleged to be contraband, the ship carrying them was, without trial and in spite of her neutrality, subjected to penalties which are reluctantly enforced even against an enemy's ship." (See section 40 of Russian Instructions on Procedure in Stopping, Examining and Seizing Merchant Vessels, published in *London Gazette* of March 18, 1904.) In particular circumstances provisions might acquire a contraband character, as, for instance, if they should be consigned direct to the army or fleet of a belligerent, or to a port where such fleet might be lying, and if facts should exist raising the presumption that they were about to be employed in victualling the fleet of the enemy. In such cases it was not denied that the other belligerent would be entitled to seize the provisions as contraband of war, on the ground that they would afford material assistance towards the carrying on of warlike operations. But it could not be admitted that if such provisions were consigned to the port of a belligerent (even though it should be a port of naval equipment) they should therefore be necessarily regarded as contraband of war. The test was whether there were circumstances relating to any particular cargo to show that it was destined for military or naval use.

The Russian government replied that they could not admit that articles of dual use when addressed to private individuals in the enemy's country should be necessarily free from seizure and condemnation, since provisions and such articles of dual use, though intended for the military or naval forces of the enemy, would obviously, under such circumstances, be addressed to private individuals, possibly agents or contractors for the naval or military authorities.

Lord Lansdowne in answer stated that while H.M. government did not contend that the mere fact that the consignee was a private person should necessarily give immunity from capture, they held that to take vessels for adjudication merely because their destination was the enemy's country would be vexatious, and constitute an unwarrantable interference with neutral commerce. To render a vessel liable to such treatment there should be circumstances giving rise to a reasonable suspicion that the provisions were destined for the enemy's forces, and it was in such a case for the captor "to establish the fact of destination for the enemy's forces before attempting to procure their condemnation" (September 30, 1904).

The protests of Great Britain led to the reference of the subject by the Russian government to a departmental committee, with the result that on October 22, 1904, a rectifying notice was issued declaring that articles capable of serving for a warlike object, including rice and food-stuffs, should be considered as contraband of war, if they are destined for the government of the belligerent power or its administration or its army or its navy or its fortresses or its naval ports; or for the purveyors thereof; and that in cases where they were addressed to private individuals these articles should not be considered as contraband of war; but that in all cases horses and beasts of burden were to be considered as contraband. As regards cotton, explanations were given by the Russian government (May 11, 1904) that the prohibition of cotton applied only to raw cotton suitable for the manufacture of explosives, and not to yarn or tissues.

The carriage of belligerent despatches connected with the con-

duct of a war or of persons in the service of a belligerent state falls within the prohibition of contraband traffic, but to distinguish such traffic from that of contraband, properly so called, the term applied to it in international law is "analogues of contraband." The penalty attaching to such carriage necessarily varies according to the degree of the analogy.

*Analogues of contraband.*

Trade between neutrals has a prima facie right to go on, in spite of war, without molestation. But if the ultimate destination of goods, though shipped first to a neutral port, is enemy's territory, then, according to the doctrine of "continuous voyages," the goods may be treated as if they had been shipped to the enemy's territory direct. The doctrine is entirely Anglo-Saxon in its origin<sup>1</sup> and development. Only in one case does it seem ever to have been actually put in force by a foreign prize court, namely, in the case of the "Doelwijk," a Dutch vessel which was adjudged good prize by an Italian court on the ground that, although bound for Djibouti, a French port, it was laden with a provision of arms of a model which had gone out of use in Europe, and could only be destined for the Abyssinians, with whom Italy was at war.

The Institute of International Law in 1896 adopted the following rule on the subject:—

"Destination to the enemy is presumed, where the shipment is to one of the enemy ports, or to a neutral port, if it is unquestionably proved by the facts that the neutral port was only a state (*éclape*) towards the enemy as the final destination of a single commercial operation."

During the South African War (1899-1902) Great Britain was involved in controversy with Germany, who at first declined to recognize the existence of any rule which could interfere with trade between neutrals, the German vessels in question having been stopped on their way to a neutral port.

As stated above, the Second Hague Conference failed to come to any understanding on contraband, but the subject was exhaustively dealt with by the Conference of London (1908-1909) on the laws and customs of naval war, in the following articles:—

ART. 22.—The following articles may, without notice, be treated as contraband of war, under the name of absolute contraband: (1) Arms of all kinds, including arms for sporting purposes, and their distinctive component parts; (2) projectiles, charges and cartridges of all kinds, and their distinctive component parts; (3) powder and explosives specially prepared for use in war; (4) gun-mountings, limber boxes, limbers, military wagons, field forges and their distinctive component parts; (5) clothing and equipment of a distinctively military character; (6) all kinds of harness of a distinctively military character; (7) saddle, draught and pack animals suitable for use in war; (8) articles of camp equipment and their distinctive component parts; (9) armour plates; (10) warships, including boats, and their distinctive component parts of such a nature that they can only be used on a vessel of war; (11) implements and apparatus designed exclusively for the manufacture of munitions of war, for the manufacture or repair of arms, or war material for use on land or sea.

ART. 23.—Articles exclusively used for war may be added to the list of absolute contraband by a declaration, which must be notified. Such notification must be addressed to the governments of other powers, or to their representatives accredited to the power making the declaration. A notification made after the outbreak of hostilities is addressed only to neutral powers.

ART. 24.—The following articles, susceptible of use in war as well as for purposes of peace, may, without notice, be treated as contraband of war, under the name of conditional contraband: (1) Food-stuffs; (2) forage and grain, suitable for feeding animals; (3) clothing, fabrics for clothing, and boots and shoes, suitable for use in war; (4) gold and silver in coin or bullion; paper money; (5) vehicles of all kinds available for use in war, and their component parts; (6) vessels, craft and boats of all kinds; floating docks, parts of docks and their component parts; (7) railway material, both fixed and rolling-stock, and material for telegraphs, wireless telegraphs and telephones; (8) balloons and flying machines and their distinctive component parts, together with accessories and articles recognizable as intended for use in connexion with balloons and flying machines; (9) fuel; lubricants; (10) powder and explosives not specially prepared for use in war; (11) barbed wire and implements for fixing and cutting the same; (12) horseshoes and shoeing materials; (13) harness and saddlery; (14) field glasses, telescopes, chronometers and all kinds of nautical instruments.

<sup>1</sup> See *Springbok* case, 1866, 5 Wallace I.; on *Doelwijk* case see Brusa, *Rev. gén. de droit international public* (1897); Fauchille, *id.* (1897), p. 291, also *The Times*, April 15, May 25, June 1, 1897.



ART. 25.—Articles susceptible of use in war as well as for purposes of peace, other than those enumerated in Articles 22 and 24, may be added to the list of conditional contraband by a declaration, which must be notified in the manner provided for in the second paragraph of Article 23.

ART. 26.—If a power waives, so far as it is concerned, the right to treat as contraband of war an article comprised in any of the classes enumerated in Articles 22 and 24, such intention shall be announced by a declaration, which must be notified in the manner provided for in the second paragraph of Article 23.

ART. 27.—Articles which are not susceptible of use in war may not be declared contraband of war.

ART. 28.—The following may not be declared contraband of war: (1) Raw cotton, wool, silk, jute, flax, hemp and other raw materials of the textile industries, and yarns of the same; (2) oil seeds and nuts; copra; (3) rubber, resins, gums and lacs; hops; (4) raw hides and horns, bones and ivory; (5) natural and artificial manures, including nitrates and phosphates for agricultural purposes; (6) metallic ores; (7) earths, clays, lime, chalk, stone, including marble, bricks, slates and tiles; (8) Chinaware and glass; (9) paper and paper-making materials; (10) soap, paint and colours, including articles exclusively used in their manufacture, and varnish; (11) bleaching powder, soda ash, caustic soda, salt cake, ammonia, sulphate of ammonia and sulphate of copper; (12) agricultural, mining, textile and printing machinery; (13) precious and semi-precious stones, pearls, mother-of-pearl and coral; (14) clocks and watches, other than chronometers; (15) fashion and fancy goods; (16) feathers of all kinds, hairs and bristles; (17) articles of household furniture and decoration; office furniture and requisites.

ART. 29.—Likewise the following may not be treated as contraband of war: (1) Articles serving exclusively to aid the sick and wounded. They can, however, in case of urgent military necessity and subject to the payment of compensation, be requisitioned, if their destination is that specified in Article 30; (2) articles intended for the use of the vessel in which they are found, as well as those intended for the use of her crew and passengers during the voyage.

ART. 30.—Absolute contraband is liable to capture if it is shown to be destined to territory belonging to or occupied by the enemy, or to the armed forces of the enemy. It is immaterial whether the carriage of the goods is direct or entails transshipment or a subsequent transport by land.

ART. 31.—Proof of the destination specified in Article 30 is complete in the following cases: (1) When the goods are documented for discharge in an enemy port, or for delivery to the armed forces of the enemy; (2) when the vessel is to call at enemy ports only, or when she is to touch at an enemy port or meet the armed forces of the enemy before reaching the neutral port for which the goods in question are documented.

ART. 32.—Where a vessel is carrying absolute contraband, her papers are conclusive proof as to the voyage on which she is engaged, unless she is found clearly out of the course indicated by her papers and unable to give adequate reasons to justify such deviation.

ART. 33.—Conditional contraband is liable to capture if it is shown to be destined for the use of the armed forces or of a government department of the enemy state, unless in this latter case the circumstances show that the goods cannot in fact be used for the purposes of the war in progress. This latter exception does not apply to a consignment coming under Article 24 (4).

ART. 34.—The destination referred to in Article 33 is presumed to exist if the goods are consigned to enemy authorities, or to a contractor established in the enemy country who, as a matter of common knowledge, supplies articles of this kind to the enemy. A similar presumption arises if the goods are consigned to a fortified place belonging to the enemy, or other place serving as a base for the armed forces of the enemy. No such presumption, however, arises in the case of a merchant vessel bound for one of these places if it is sought to prove that she herself is contraband. In cases where the above presumptions do not arise, the destination is presumed to be innocent. The presumptions set up by this article may be rebutted.

ART. 35.—Conditional contraband is not liable to capture, except when found on board a vessel bound for territory belonging to or occupied by the enemy, or for the armed forces of the enemy, and when it is not to be discharged in an intervening neutral port. The ship's papers are conclusive proof both as to the voyage on which the vessel is engaged and as to the port of discharge of the goods, unless she is found clearly out of the course indicated by her papers, and unable to give adequate reasons to justify such deviation.

ART. 36.—Notwithstanding the provisions of Article 35, conditional contraband, if shown to have the destination referred to in Article 33, is liable to capture in cases where the enemy country has no seaboard.

ART. 37.—A vessel carrying goods liable to capture as absolute or conditional contraband may be captured on the high seas or in the territorial waters of the belligerents throughout the whole of her voyage, even if she is to touch at a port of call before reaching the hostile destination.

ART. 38.—A vessel may not be captured on the ground that she has carried contraband on a previous occasion if such carriage is in point of fact at an end.

ART. 39.—Contraband goods are liable to condemnation.

ART. 40.—A vessel carrying contraband may be condemned if the contraband, reckoned either by value, weight, volume or freight, forms more than half the cargo.

ART. 41.—If a vessel carrying contraband is released, she may be condemned to pay the costs and expenses incurred by the captor in respect of the proceedings in the national prize court and the custody of the ship and cargo during the proceedings.

ART. 42.—Goods which belong to the owner of the contraband and are on board the same vessel are liable to condemnation.

ART. 43.—If a vessel is encountered at sea while unaware of the outbreak of hostilities or of the declaration of contraband which applies to her cargo, the contraband cannot be condemned except on payment of compensation; the vessel herself and the remainder of the cargo are not liable to condemnation or to the costs and expenses referred to in Article 41. The same rule applies if the master, after becoming aware of the outbreak of hostilities, or of the declaration of contraband, has had no opportunity of discharging the contraband. A vessel is deemed to be aware of the existence of a state of war, or of a declaration of contraband, if she left a neutral port subsequently to the notification to the power to which such port belongs of the outbreak of hostilities or of the declaration of contraband respectively, provided that such notification was made in sufficient time. A vessel is also deemed to be aware of the existence of a state of war if she left an enemy port after the outbreak of hostilities.

ART. 44.—A vessel which has been stopped on the ground that she is carrying contraband, and which is not liable to condemnation on account of the proportion of contraband on board, may, when the circumstances permit, be allowed to continue her voyage if the master is willing to hand over the contraband to the belligerent warship. The delivery of the contraband must be entered by the captor on the logbook of the vessel stopped, and the master must give the captor duly certified copies of all relevant papers. The captor is at liberty to destroy the contraband that has been handed over to him under these conditions.

See Hautefeuille, *Des droits et devoirs des nations neutres* (2nd ed., 1858); Perels, *Droit maritime international*, traduit par Arendt (Paris, 1884); Moore, *Digest of International Law* (1906); L. Oppenheim, *International Law* (1907); Barclay, *Problems of International Practice and Diplomacy* (1907). See also Hall, *International Law on Analogues of Contraband*; Smith and Sibley, *International Law as Interpreted during the Russo-Japanese War, 1905*, on "Malacca" and "Prinz Heinrich" cases (mails). (T. BA.)

**CONTRACT** (Lat. *contractus*, from *contrahere*, to draw together, to bind), the legal term for a bargain or agreement; some writers, following the Indian Contract Act, confine the term to agreements enforceable by law: this, though not yet universally adopted, seems an improvement. Enforcement of good faith in matters of bargain and promise is among the most important functions of legal justice. It might not be too much to say that, next after keeping the peace and securing property against violence and fraud so that business may be possible, it is the most important. Yet we shall find that the importance of contract is developed comparatively late in the history of law. The commonwealth needs elaborate rules about contracts only when it is advanced enough in civilization and trade to have an elaborate system of credit. The Roman law of the empire dealt with contract, indeed, in a fairly adequate manner, though it never had a complete or uniform theory; and the Roman law, as settled by Justinian, appears to have satisfied the Eastern empire long after the Western nations had begun to recast their institutions, and the traders of the Mediterranean had struck out a cosmopolitan body of rules and custom known as the Law Merchant, which claimed acceptance in the name neither of Justinian nor of the Church, but of universal reason. It was amply proved afterwards that the foundations of the Roman system were strong enough to carry the fabric of modern legislation. But the collapse of the Roman power in western Christendom threw society back into chaos, and reduced men's ideas of ordered justice and law to a condition compared with which the earliest Roman law known to us is modern.

In this condition of legal ideas, which it would be absurd to call jurisprudence, the general duty of keeping faith is not recognized except as a matter of religious or social observance. Those who desire to be assured of anything that lies in promise must exact an oath, or a pledge, or personal sureties; and even then the court of their people—in England the Hundred Court in the first instance—will do nothing for them in the first case, and not much in the two latter. Probably the settlement of a blood-feud, with provisions for the payment of the fine

by instalments, was the nearest approach to a continuing contract, as we now understand the term, which the experience of Germanic antiquity could furnish. It is also probable that the performance of such undertakings, as it concerned the general peace, was at an early time regarded as material to the commonweal; and that these covenants of peace, rather than the rudimentary selling and bartering of their day, first caused our Germanic ancestors to realize the importance of putting some promises at any rate under public sanction. We have not now to attempt any reconstruction of archaic judgment and justice, or the lack of either, at any period of the darkness and twilight which precede the history of the middle ages. But the history of the law, and even the present form of much law still common to almost all the English-speaking world, can be understood only when we bear in mind that our forefathers did not start from any general conception of the state's duty to enforce private agreements, but, on the contrary, the state's powers and functions in this regard were extended gradually, unsystematically, and by shifts and devices of ingenious suitors and counsel, aided by judges, rather than by any direct provisions of princes and rulers. Money debts, it is true, were recoverable from an early time. But this was not because the debtor had promised to repay the loan; it was because the money was deemed still to belong to the creditor, as if the identical coins were merely in the debtor's custody. The creditor sued to recover money, for centuries after the Norman Conquest, in exactly the same form which he would have used to demand possession of land; the action of debt closely resembled the "real actions," and, like them, might be finally determined by a judicial combat; and down to Blackstone's time the creditor was said to have a property in the debt—property which the debtor had "granted" him. Giving credit, in this way of thinking, is not reliance on the right to call hereafter for an act, the payment of so much current money or its equivalent, to be performed by the debtor, but merely suspension of the immediate right to possess one's own particular money, as the owner of a house let for a term suspends his right to occupy it. This was no road to the modern doctrine of contract, and the passage had to be made another way.

In fact the old action of debt covered part of the ground of contract only by accident. It was really an action to recover any property that was not land; for the remedy of a dispossessed owner of chattels, afterwards known as *detinue*, was only a slightly varying form of it.

If the property claimed was a certain sum of money, it might be due because the defendant had received money on loan, or because he had received goods of which the agreed price remained unpaid; or, in later times at any rate, because he had become liable in some way by judgment, statute or other authority of law, to pay a fine or fixed penalty to the plaintiff. Here the person recovering might be as considerable as the lord of a manor, or as mean as a "common informer"; the principle was the same. In every case outside this last class, that is to say, whenever there was a debt in the popular sense of the word, it had to be shown that the defendant had actually received the money or goods; this value received came to be called *quid pro quo*—a term unknown, to all appearance, out of England. Nevertheless the foundation of the plaintiff's right was not bargain or promise, but the unjust detention by the defendant of the plaintiff's money or goods.

We are not concerned here to trace the change from the ancient method of proof—oath backed by "good suit," i.e. the oaths of an adequate number of friends and neighbours—through the earlier form of jury trial, in which the jury were supposed to know the truth of their own knowledge, to the modern establishment of facts by testimony brought before a jury who are bound to give their verdict according to the evidence. But there was one mode of proof which, after the Norman Conquest, made a material addition to the substantive law. This was the proof by writing, which means writing authenticated by seal. Proof by writing was admitted under Roman influence, but, once admitted, it acquired the character of being conclusive which belonged to all

proof in early Germanic procedure. Oath, ordeal and battle were all final in their results. When the process was started there was no room for discussion. So the sealed writing was final too, and a man could not deny his own deed. We still say that he cannot, but with modern refinements. Thus the deed, being allowed as a solemn and probative document, furnished a means by which a man could bind himself, or rather effectually declare himself bound, to anything not positively forbidden by law. Whoever could afford parchment and the services of a clerk might have the benefit of a "formal contract" in the Roman sense of the term. At this day the form of deed called a bond or "obligation" is, as it stands settled after various experiments, extremely artificial; but it is essentially a solemn admission of liability, though its conclusive stringency has been relaxed by modern legislation and practice in the interest of substantial justice. By this means the performance of all sorts of undertakings, pecuniary and otherwise, could be and was legally secured. Bonds were well known in the 13th century, and from the 14th century onwards were freely used for commercial and other purposes; as for certain limited purposes they still are. The "covenant" of modern draftsmen is a direct promise made by deed; it occurs mainly as incident to conveyances of land. The medieval "covenant," *conventio*, was, when we first hear of it, practically equivalent to a lease, and never became a common instrument of miscellaneous contracting, though the old books recognize the possibility of turning it to various uses of which there are examples; nor had it any sensible influence on the later development of the law. On the whole, in the old common law one could do a great deal by deed, but very little without deed. The minor bargains of daily life, so far as they involved mutual credit, were left to the jurisdiction of inferior courts, of the Law Merchant, and—last, not least—of the Church.

Popular custom, in all European countries, recognized simpler ways of pledging faith than parchment and seal. A handshake was enough to bind a bargain. Whatever secular law might say, the Church said it was an open sin to break pledged faith; a matter, therefore, for spiritual correction, in other words, for compulsion exercised on the defaulter by the bishop's or the archdeacon's court, armed with the power of excommunication. In this way the ecclesiastical courts acquired much business which was, in fact, as secular as that of a modern county court, with the incident profits. Medieval courts lived by the suitors' fees. What were the king's judges to do? However high they put their claims in the course of the rivalry between Church and Crown, they could not effectually prohibit the bishop or his official from dealing with matters for which the king's court provided no remedy. Continental jurists had seen their way, starting from the Roman system as it was left by Justinian, to reduce its formalities to a vanishing quantity, and expand their jurisdiction to the full breadth of current usage. English judges could not do this in the 15th century, if they could ever have done so. Nor would simplification of the requisites of a deed, such as has now been introduced in many jurisdictions, have been of much use at a time when only a minority even of well-to-do laymen could write with any facility.

There was no principle and no form of action in English law which recognized any general duty of keeping promises. But could not breach of faith by which a party had suffered be treated as some kind of legal wrong? There was a known action of trespass and a known action of deceit, this last of a special kind, mostly for what would now be called abuse of the process of the court; but in the later middle ages it was an admitted remedy for giving a false warranty on a sale of goods. Also there was room for actions "on the case," on facts analogous to those covered by the old writs, though not precisely within their terms. If the king's judges were to capture this important branch of business from the clerical hands which threatened to engross it, the only way was to devise some new form of action on the case. There were signs, moreover, that the court of chancery would not neglect so promising a field if the common law judges left it open.

*Fidel  
Ineio.*

The mere fact of unfulfilled promise was not enough, in the eyes of medieval English lawyers, to give a handle to the law. But injury caused by reliance on another man's undertaking was different. The special undertaking or "assumpsit" creates a duty which is broken by fraudulent or incompetent miscarriage in the performance. I profess to be a skilled farrier, and lame your horse. It is no trespass, because you trusted the horse to me; but it is something like a trespass, and very like a deceit. I profess to be a competent builder; you employ me to build a house, and I scamp the work so that the house is not fit to live in. An action on the case was allowed without much difficulty for such defaults. The next step, and a long one, was to provide for total failure to perform. The builder, instead of doing bad work, does nothing at all within the time agreed upon for completing the house. Can it be said that he has done a wrong? At first the judges felt bound to hold that this was going too far; but suitors anxious to have the benefit of the king's justice persevered, and in the course of the 15th century the new form of action, called *assumpsit* from the statement of the defendant's undertaking on which it was founded, was allowed as a remedy for non-performance as well as for faulty performance. Being an action for damages, and not for a certain amount, it escaped the strict rules of proof which applied to the old action of debt; being in form for a kind of trespass, and thus a privileged appeal to the king to do right for a breach of his peace, it escaped likewise the risk of the defendant clearing himself by oath according to the ancient popular procedure. Hence, as time went on, suitors were emboldened to use "assumpsit" as an alternative for debt, though it had been introduced only for cases where there was no other remedy. By the end of the 16th century they got their way; and it became a settled doctrine that the existence of a debt was enough for the court to presume an undertaking to pay it. The new form of action was made to cover the whole ground of informal contracts, and, by extremely ingenious devices of pleading, developed from the presumption or fiction that a man had promised to pay what he ought, it was extended in time to a great variety of cases where there was in fact no contract at all.

The new system gave no new force to gratuitous promises. For it was assumed, as the foundation of the jurisdiction, that the plaintiff had been induced by the defendant's undertaking, and with the defendant's consent, to alter his position for the worse in some way. He had paid or bound himself to pay money, he had parted with goods, he had spent time in labour, or he had foregone some profit or legal right. If he had not committed himself to anything on the strength of the defendant's promise, he had suffered no damage and had no cause of action. Disappointment of expectations is unpleasant, but it is not of itself *damnum* in a legal sense. To sum up the effect of this in modern language, the plaintiff must have given value of some kind, more or less, for the defendant's undertaking. This something given by the promisee and accepted by the promisor in return for his undertaking is what we now call the *consideration* for the promise. In cases where debt would also lie, it coincides with the old requirement of value received (*quid pro quo*) as a condition of the action of debt being available. But the conception is far wider, for the consideration for a promise need not be anything capable of delivery or possession. It may be money or goods; but it may also be an act or series of acts; further (and this is of the first importance for our modern law), it may itself be a promise to pay money or deliver goods, or to do work, or otherwise to act or not to act in some specified way. Again, it need not be anything which is obviously for the promisor's benefit. His acceptance shows that he set some value on it; but in truth the promisee's burden, and not the promisor's benefit, is material. The last refinement of holding that, when mutual promises are exchanged between parties, each promise is a consideration for the other and makes it binding, was conclusively accepted only in the 17th century. The result was that promises of mere bounty could no more be enforced than before, but any kind of lawful bargain could;

and there is no reason to doubt that this was in substance what most men wanted. Ancient popular usage and feeling show little more encouragement than ancient law itself to merely gratuitous alienation or obligations. Also (subject, till quite modern times, to the general rule of common-law procedure that parties could not be their own witnesses, and subject to various modern statutory requirements in various classes of cases) no particular kind of proof was necessary. The necessity of consideration for the validity of simple contracts was unfortunately confused by commentators, almost from the beginning of its history, with the perfectly different rules of the Roman law about *nudum pactum*, which very few English lawyers took the pains to understand. Hasty comparison of misunderstood Roman law, sometimes in its civil and sometimes in its ecclesiastical form, is answerable for a large proportion of the worst faults in old-fashioned text-books. Doubtless many canonists, probably some common lawyers, and possibly some of the judges of the Renaissance time, supposed that *ex nudo pacto non oritur actio* was in some way a proposition of universal reason; but it is a long way from this to concluding that the Roman law had any substantial influence on the English.

The doctrine of consideration is in fact peculiar to those jurisdictions where the common law of England is in force, or is the foundation of the received law, or, as in South Africa, has made large encroachments upon it in practice. Substantially similar results are obtained in other modern systems by professing to enforce all deliberate promises, but imposing stricter conditions of proof where the promise is gratuitous.

As obligations embodied in the solemn form of a deed were thereby made enforceable before the doctrine of consideration was known, so they still remain. When a man has by deed declared himself bound, there is no need to look for any bargain, or even to ask whether the other party has assented. This rugged fragment of ancient law remains embedded in our elaborate modern structure. Nevertheless gratuitous promises, even by deed, get only their strict and bare rights. There may be an action upon them, but the powerful remedy of specific performance—often the only one worth having—is denied them. For this is derived from the extraordinary jurisdiction of the chancellor, and the equity administered by the chancellor was not for plaintiffs who could not show substantial merit as well as legal claims. The singular position of promises made by deed is best left out of account in considering the general doctrine of the formation of contracts; and as to interpretation there is no difference. In what follows, therefore, it will be needless, as a rule, to distinguish between "parol" or "simple" contracts, that is, contracts not made by deed, and obligations undertaken by deed.

From the conception of a promise being valid only when given in return for something accepted in consideration of the promise, it follows that the giving of the promise and of the consideration must be simultaneous. Words of promise uttered before there is a consideration for them can be no more than an offer; and, on the other hand, the obligation declared in words, or inferred from acts and conduct, on the acceptance of a consideration, is fixed at that time, and cannot be varied by subsequent declaration, though such declarations may be material as admissions. It was a long while, however, before this consequence was clearly perceived. In the 18th century it was attempted, and for a time with considerable success, to extend the range of enforceable promises without regard to what the principles of the law would bear, in order to satisfy a sense of natural justice. This movement was checked only within living memory, and traces of it remain in certain apparently anomalous rules which are indeed of little practical importance, but which private writers, at any rate, cannot safely treat as obsolete. However, the question of "past consideration" is too minute and technical to be pursued here. The general result is that a binding contract is regularly constituted by the acceptance of an offer, and at the moment when it is accepted; and, however complicated the transaction may be, there must always, in the theory of English law, be such a

moment in every case where a contract is formed. It also follows that an offer before acceptance creates no duty of any kind ("A revocable promise is unknown to our law"—Anson); which is by no means necessarily the case in systems where the English rule of consideration is unknown. The question what amounts to final acceptance of an offer is, on the other hand, a question ultimately depending on common sense, and must be treated on similar lines in all civilized countries where the business of life is carried on in a generally similar way. The rules that an offer is understood to be made only for a reasonable time, according to the nature of the case, and lapses if not accepted in due time; that an expressed revocation of an offer can take effect only if communicated to the other party before he has accepted; that acceptance of an offer must be according to its terms, and a conditional or qualified acceptance is only a new proposal, and the like, may be regarded as standing on general convenience as much as on any technical ground.

Great difficulties have arisen, and in other systems as well as in the English, as to the completion of contracts between persons at a distance. There must be some rule, and yet any rule that can be framed must seem arbitrary in some cases. On the whole the modern doctrine is to some such effect as the following:—

The proposer of a contract can prescribe or authorize any mode, or at least any reasonable mode, of acceptance, and if he specifies none he is deemed to authorize the use of any reasonable mode in common use, and especially the post. Acceptance in words is not always required; an offer may be well accepted by an act clearly referable to the proposed agreement, and constituting the whole or part of the performance asked for—say the despatch of goods in answer to an order by post, or the doing of work bespoke; and it seems that in such cases further communication—unless expressly requested—is not necessary as matter of law, however prudent and desirable it may be. Where a promise and not an act is sought (as where a tradesman writes a letter offering goods for sale on credit), it must be communicated; in the absence of special direction letter post or telegraph may be used; and, further, the acceptor having done his part when his answer is committed to the post, English courts now hold (after much discussion and doubt) that any delay or miscarriage in course of post is at the proposer's risk, so that a man may be bound by an acceptance he never received. It is generally thought—though there is no English decision—that, in conformity with this last rule, a revocation by telegraph of an acceptance already posted would be inoperative. Much more elaborate rules are laid down in some continental codes. It seems doubtful whether their complication achieves any gain of substantial justice worth the price. At first sight it looks easy to solve some of the difficulties by admitting an interval during which one party is bound and the other not. But, apart from the risk of starting fresh problems as hard as the old ones, English principles, as above said, require a contract to be concluded between the parties at one point of time, and any exception to this would have to be justified by very strong grounds of expediency. We have already assumed, but it should be specifically stated, that neither offers nor acceptances are confined to communications made in spoken or written words. Acts or signs may and constantly do signify proposal and assent. One does not in terms request a ferryman to put one across the river. Stepping into the boat is an offer to pay the usual fare for being ferried over, and the ferryman accepts it by putting off. This is a very simple case, but the principle is the same in all cases. Acts fitted to convey to a reasonable man the proposal of an agreement, or the acceptance of a proposal he has made, are as good in law as equivalent express words. The term "implied contract" is current in this connexion, but it is unfortunately ambiguous. It sometimes means a contract concluded by acts, not words, of one or both parties, but still a real agreement; sometimes an obligation imposed by law where there is not any agreement in fact, for which the name "quasi-contract" is more appropriate and now usual.

The obligation of contract is an obligation created and deter-

mined by the will of the parties. Herein is the characteristic difference of contract from all other branches of law.

The business of the law, therefore, is to give effect so far as possible to the intention of the parties, and all the rules for interpreting contracts go back to this fundamental principle and are controlled by it. Every one knows that its application is not always obvious. Parties often express themselves obscurely; still oftener they leave large parts of their intention unexpressed, or (which for the law is the same thing) have not formed any intention at all as to what is to be done in certain events. But even where the law has to fill up gaps by judicial conjecture, the guiding principle still is, or ought to be, the consideration of what either party has given the other reasonable cause to expect of him. The court aims not at imposing terms on the parties, but at fixing the terms left blank as the parties would or reasonably might have fixed them if all the possibilities had been clearly before their minds. For this purpose resort must be had to various tests: the court may look to the analogy of what the parties have expressly provided in case of other specified events, to the constant or general usage of persons engaged in like business, and, at need, ultimately to the court's own sense of what is just and expedient. All auxiliary rules of this kind are subject to the actual will of the parties, and are applied only for want of sufficient declaration of it by the parties themselves. A rule which can take effect against the judicially known will of the parties is not a rule of construction or interpretation, but a positive rule of law. However artificial some rules of construction may seem, this test will always hold. In modern times the courts have avoided laying down new rules of construction, preferring to keep a free hand and deal with each case on its merits as a whole. It should be observed that the fulfilment of a contract may create a relation between the parties which, once established, is governed by fixed rules of law not variable by the preceding agreement. Marriage is the most conspicuous example of this, and perhaps the only complete one in our modern law.

There are certain rules of evidence which to some extent guide or restrain interpretation. In particular, oral testimony is not allowed to vary the terms of an agreement reduced to writing. This is really in aid of the parties' deliberate intention, for the object of reducing terms to writing is to make them certain. There are apparent exceptions to the rule, of which the most conspicuous is the admission of evidence to show that words were used in a special meaning current in the place or trade in question. But they are reducible, it will be found, to applications (perhaps over-subtle in some cases) of the still more general principles that, before giving legal force to a document, we must know that it is really what it purports to be, and that when we do give effect to it according to its terms we must be sure of what its terms really say. The rules of evidence here spoken of are modern, and have nothing to do with the archaic rule already mentioned as to the effect of a deed.

Every contracting party is bound to perform his promise according to its terms, and in case of any doubt in the sense in which the other party would reasonably understand the promise. Where the performance on one or both sides extends over an appreciable time, continuously or by instalments, questions may arise as to the right of either party to refuse or suspend further performance on the ground of some default on the other side. Attempts to lay down hard and fast rules on such questions are now discouraged, the aim of the courts being to give effect to the true substance and intent of the contract in every case. Nor will the court hold one part of the terms deliberately agreed to more or less material than another in modern business dealings. "In the contracts of merchants time is of the essence," as the Supreme Court of the United States has said in our own day. Certain ancient rules restraining the apparent literal effect of common provisions in mortgages and other instruments were in truth controlling rules of policy. New rules of this kind can be made only by legislation. Whether the parties did or did not in fact intend the obligation of a contract to be subject to unexpressed

*Interpretation.*

*Correspondence.*

*Evidence.*

*Performance.*

conditions is, however, a possible and not uncommon question of interpretation. One class of cases giving rise to such questions is that in which performance becomes impossible by some external cause not due to the promisor's own fault; a similar but not identical one is that in which the agreement could be literally performed, and yet the performance would not give the promisor the substance of what he bargained for; as happened in the "coronation cases" arising out of the postponement of the king's coronation in 1902. As to promises obviously absurd or impossible from the first, they are unenforceable only on the ground that the parties cannot have seriously meant to create a liability. For precisely the same reason, supported by the general usage and understanding of mankind, common social engagements, though they often fulfil all other requisites of a contract, have never been treated as binding in law.

In all matters of contract, as we have said, the ascertained will of the parties prevails. But this means a will both lawful and free. Hence there are limits to the force of the *Illegality.* general rule, fixed partly by the law of the land, which is above individual will and interests, partly by the need of securing good faith and justice between the parties themselves against fraud or misadventure. Agreements cannot be enforced when their performance would involve an offence against the law. There may be legal offence, it must be remembered, not only in acts commonly recognized as criminal, disloyal or immoral, but in the breach or non-observance of positive regulations made by the legislature, or persons having statutory authority, for a great variety of purposes. It would be useless to give details on the subject here. Again, there are cases where an agreement may be made and performed without offending the law, but on grounds of "public policy" it is not thought right that the performance should be a matter of legal obligation, even if the ordinary conditions of an enforceable contract are satisfied. A man may bet, in private at any rate, if he likes, and pay or receive as the event may be; but for many years the winner has had no right of action against the loser. Unfortunate timidity on the part of the judges, who attempted to draw distinctions instead of saying boldly that they would not entertain actions on wagers of any kind, threw this topic into the domain of legislation; and the laudable desire of parliament to discourage gambling, so far as might be, without attempting impossible prohibitions, has brought the law to a state of ludicrous complexity in both civil and criminal jurisdiction. But what is really important under this doctrine of public policy is the confinement of "contracts in restraint of trade" within special limits. In the middle ages and down to modern times there was a strong feeling—not merely an artificial legal doctrine—against monopolies and everything tending to monopoly. Agreements to keep up prices or not to compete were regarded as criminal. Gradually it was found that some kind of limited security against competition must be allowed if such transactions as the sale of a going concern with its goodwill, or the retirement of partners from a continuing firm, or the employment of confidential servants in matters involving trade secrets, were to be carried on to the satisfaction of the parties. Attempts to lay down fixed rules in these matters were made from time to time, but they were finally discredited by the decision of the House of Lords in the Maxim-Nordenfelt Company's case in 1894. Contracts "in restraint of trade" will now be held valid, provided that they are made for valuable consideration (this even if they are made by deed), and do not go beyond what can be thought reasonable for the protection of the interests concerned, and are not injurious to the public. (The Indian Contract Act, passed in 1872, has unfortunately embodied views now obsolete, and remains unamended.) All that remains of the old rules in England is the necessity of valuable consideration, whatever be the form of the contract, and a strong presumption—but not an absolute rule of law—that an unqualified agreement not to carry on a particular business is not reasonable.

Where there is no reason in the nature of the contract for not

enforcing it, the consent of a contracting party may still not be binding on him because not given with due knowledge, or, if he is in a relation of dependence to the other party, with independent judgment. Inducing a man by deceit to enter into a contract may always be treated by the deceived party as a ground for avoiding his obligation, if he does so within a reasonable time after discovering the truth, and, in particular, before any innocent third person has acquired rights for value on the faith of the contract (see FRAUD). Coercion would be treated on principle in the same way as fraud, but such cases hardly occur in modern times. There is a kind of moral domination, however, which our courts watch with the utmost jealousy, and repress under the name of "undue influence" when it is used to obtain pecuniary advantage. Persons in a position of legal or practical authority—guardians, confidential advisers, spiritual directors, and the like—must not abuse their authority for selfish ends. They are not forbidden to take benefits from those who depend on them or put their trust in them; but if they do, and the givers repent of their bounty, the whole burden of proof is on the takers to show that the gift was in the first instance made freely and with understanding. Large voluntary gifts or beneficial contracts, outside the limits within which natural affection and common practice justify them, are indeed not encouraged in any system of civilized law. Professional money-lenders were formerly checked by the usury law: since those laws were repealed in 1854, courts and juries have shown a certain astuteness in applying the rules of law as to fraud and undue influence—the latter with certain special features—to transactions with needy "expectant heirs" and other improvident persons which seem on the whole unconscionable. The Money Lenders Act of 1900 has fixed and (as finally interpreted by the House of Lords) also sharpened these developments. In the case of both fraud and undue influence, the person entitled to avoid a contract may, if so advised, ratify it afterwards; and ratification, if made with full knowledge and free judgment, is irrevocable. A contract made with a person deprived by unsound mind or intoxication of the capacity to form a rational judgment is on the same footing as a contract obtained by fraud, if the want of capacity is apparent to the other party.

¶ There are many cases in which a statement made by one party to the other about a material fact will enable the other to avoid the contract if he has relied on it, and it was in fact untrue, though it may have been made at the time with honest belief in its truth. This is so wherever, according to the common course of business, it is one party's business to know the facts, and the other practically must, or reasonably may, take the facts from him. In some classes of cases even inadvertent omission to disclose any material fact is treated as a misrepresentation. Contracts of insurance are the most important; here the insurer very seldom has the means of making any effective inquiry of his own. Misdescription of real property on a sale, without fraud, may according to its importance be a matter for compensation or for setting aside the contract. Promoters of companies are under special duties as to good faith and disclosure which have been worked out at great length in the modern decisions. But company law has become so complex within the present generation that, so far from throwing much light on larger principles, it is hardly intelligible without some previous grasp of them. Sometimes it is said that misrepresentation (apart from fraud) of any material fact will serve to avoid any and every kind of contract. It is submitted that this is certainly not the law as to the sale of goods or as to the contract to marry, and therefore the alleged rule cannot be laid down as universal. But it must be remembered that parties can, if they please, and not necessarily by the express terms of the contract itself, make the validity of their contract conditional on the existence of any matter of fact whatever, including the correctness of any particular statement. If they have done this, and the fact is not so, the contract has no force; not because there has been a misrepresentation, but because the parties agreed to be bound if the fact was so and not otherwise. It is

*Fraud.*

*Misrepresentation.*



a question of interpretation whether in a given case there was any such condition.

Mistake is said to be a ground for avoiding contracts, and there are cases which it is practically convenient to group under this head. On principle they seem to be mostly reducible to failure of the acceptance to correspond with the offer, or absence of any real consideration for the promise. In such cases, whether there be fraud or not, no contract is ever formed, and therefore there is nothing which can be ratified—a distinction which may have important effects. Relief against mistake is given where parties who have really agreed, or rather their advisers, fail to express their intention correctly. Here, if the original true intention is fully proved—as to which the court is rightly cautious—the faulty document can be judicially rectified.

By the common law an infant (*i.e.* a person less than twenty-one years old) was bound by contracts made for "necessaries," *i.e.* such commodities as a jury holds, and the court thinks they may reasonably hold, suitable and required for the person's condition; also by contracts otherwise clearly for his benefit; all other contracts he might confirm or avoid after coming of age. An extremely ill-drawn act of 1874 absolutely deprived infants of the power of contracting loans, contracting for the supply of goods other than necessaries, and stating an account so as to bind themselves; it also disabled them from binding themselves by ratification. The liability for necessaries is now declared by legislative authority in the Sale of Goods Act 1893; the modern doctrine is that it is in no case a true liability on contract. There is an obligation imposed by law to pay, not the agreed price, but a reasonable price. Practically, people who give credit to an infant do so at their peril, except in cases of obvious urgency.

Married women were incapable by the common law of contracting in their own names. At this day they can hold separate property and bind themselves to the extent of that property—not personally—by contract. The law before the Married Women's Property Acts (1882 and 1893, and earlier acts now superseded and repealed) was a very peculiar creature of the court of chancery; the number of cases in which it is necessary to go back to it is of course decreasing year by year. But a married woman can still be restrained from anticipating the income of her separate property, and the restriction is still commonly inserted in marriage settlements.

There is a great deal of philosophical interest about the nature and capacities of corporations, but for modern practical purposes it may be said that the legal powers of British corporations are directly or indirectly determined by acts of parliament. For companies under the Companies Acts the controlling instrument or written constitution is the memorandum of association. Company draftsmen, taught by experience, nowadays frame this in the most comprehensive terms. Questions of either personal or corporate disability are less frequent than they were. In any case they stand apart from the general principles which characterize our law of contract.

The rights created by contract are personal rights against the promisors and their legal representatives, and therefore different in kind from the rights of ownership and the like which are available against all the world. Nevertheless they may be and very commonly are capable of pecuniary estimation and estimated as part of a man's assets. Book debts are the most obvious example. Such rights are property in the larger sense: they are in modern law transmissible and alienable, unless the contract is of a kind implying personal confidence, or a contrary intention is otherwise shown. The rights created by negotiable instruments are an important and unique species of property, being not only exchangeable but the very staple of commercial currency. Contract and conveyance, again, are distinct in their nature, and sharply distinguished in the classical Roman law. But in the common law property in goods is transferred by a complete contract of sale without any further act, and under the French civil code and systems which have followed it a like rule applies not only

to movables but to immovables. In English law procuring a man to break his contract is a civil wrong against the other contracting party, subject to exceptions which are still not clearly defined.

**AUTHORITIES.**—History: Ames, "The History of Assumpsit," *Harvard Law Rev.* ii. 1, 53 (Cambridge, Mass. 1889); Pollock and Maitland, *History of English Law*, 2nd ed., ii. 184-239 (Cambridge, 1898). Modern: Pollock, article "Contract" in *Encyclopaedia of the Laws of England* (2nd ed., London, 1907), a technical summary of the modern law; the same writer's edition of the Indian Contract Act (assisted by D. F. Mulla, London and Bombay, 1905) restates and discusses the principles of the common law besides commenting on the provisions of the Act in detail. Of the text-books, Anson, *English Law of Contract*, reached an eleventh edition in 1906; Harriman, *Law of Contracts* (second edition, 1901); Leake, *Principles of the Law of Contract* (fifth edition by Randall, 1906); Pollock, *Principles of Contract* (eighth edition, 1910, third American edition, Wald's completed by Williston, New York, 1906). O. W. Holmes's (justice of the Supreme Court of the United States) *The Common Law* (Boston, Mass. 1881) is illuminating on contract as on other legal topics, though the present writer cannot accept all the learned judge's historical conjectures. (F. Po.)

**CONTRACTILE VACUOLE**, in biology, a spherical space filled with liquid, which at intervals discharges into the medium; it is found in all fresh-water groups of Protozoa, and some marine forms, also in the naked aquatic reproductive cells of Algae and Fungi. It is absent in states with a distinct cell-wall to resist excessive turgescence, such as would lead to the rupture of a naked cell, and we conclude that its chief function is to prevent such turgescence in unprotected naked cells. It fulfils also respiratory and renal functions, and is comparable, physiologically, to the contractile vesicle or bladder of Rotifers and Turbellarians. In many species it is part of a complex of canals or spaces in the protoplasm.

See M. Hartog, *British Association Reports*, and Degen, *Botanische Zeitung*, vol. lxiii. Abt. 1 (1905) (see also PROTOZOA; PROTOPLASM).

**CONTRADICTION, PRINCIPLE OF** (*principium contradictionis*), in logic, the term applied to the second of the three primary "laws of thought." The oldest statement of the law is that contradictory statements cannot both at the same time be true, *e.g.* the two propositions "A is B" and "A is not B" are mutually exclusive. A may be B at one time, and not at another; A may be partly B and partly not B at the same time; but it is impossible to predicate of the same thing, at the same time, and in the same sense, the absence and the presence of the same quality. This is the statement of the law given by Aristotle (*τὸ γὰρ αὐτὸ ὑπάρχειν τε καὶ μὴ ὑπάρχειν ἀδύνατον τῷ αὐτῷ καὶ κατὰ τὸ αὐτὸ*, *Metaph.* Γ 3, 1005 b 10). It takes no account of the truth of either proposition; if one is true, the other is not; one of the two must be true.

Modern logicians, following Leibnitz and Kant, have generally adopted a different statement, by which the law assumes an essentially different meaning. Their formula is "A is not not-A"; in other words it is impossible to predicate of a thing a quality which is its contradictory. Unlike Aristotle's law this law deals with the necessary relation between subject and predicate in a single judgment. Whereas Aristotle states that *one or other* of two contradictory propositions must be false, the Kantian law states that a particular kind of proposition is *in itself* necessarily false. On the other hand there is a real connexion between the two laws. The denial of the statement "A is not-A" presupposes some knowledge of what A is, *i.e.* the statement A is A. In other words a judgment about A is implied. Kant's analytical propositions depend on presupposed concepts which are the same for all people. His statement, regarded as a logical principle purely and apart from material facts, does not therefore amount to more than that of Aristotle, which deals simply with the significance of negation.

See text-books of Logic, *e.g.* C. Sigwart's *Logic* (trans. Helen Dendy, London, 1895), vol. i. pp. 142 foll.; for the various expressions of the law see Ueberweg's *Logik*, § 77; also J. S. Mill, *Examination of Hamilton*, 471; Venn, *Empirical Logic*.

**CONTRAFAGOTTO**, DOUBLE BASSOON or CONTRABASSOON (Fr. *contrebasson*; Ger. *Kontrafagott*), a wood-wind instrument of the double reed family, which it completes as grand bass, the other members being the oboe, cor anglais, and bassoon.

The contrafagotto corresponds to the double bass in strings, to the contrabass tuba in the brass wind, and to the pedal clarinet in the single reed wood wind.

There are at the present day three distinct makes of contrafagotto. (1) The modern German (fig. 1) is founded on the

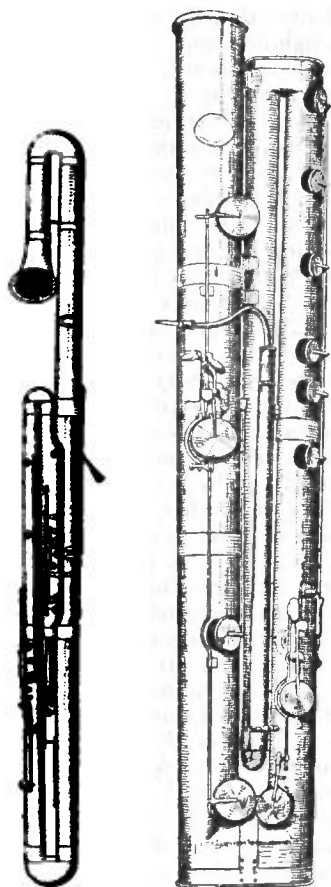



FIG. 1.—Contrafagotto, German model (Wilhelm Heckel).  
From Capt. C. R. Day's *Cat. of Mus. Instr.* by permission of Fyfe & Spottiswoode.

older models, resembling the bassoon, the best-known being Heckel's of Biebrich-am-Rhein, used at Bayreuth and in many German orchestras. In this model the characteristics of the bassoon are preserved, and the tone is of true fagotto quality extended in its lower register. The Heckel contrafagotto consists of a wooden tube 16 ft. 4 in. long with a conical bore, and doubled back four times upon itself to make it less unwieldy. It is thus about the same length as the bassoon and terminates in a bell 4 in. in diameter pointing downwards. The crook consists of a small brass tube about 2 ft. long, having a very narrow bore, to which is bound the double-reed mouthpiece.

(2) The modern English double bassoon is one designed by Dr W. H. Stone, and made under his superintendence by Haseneier of Coblenz. It is stated that instruments of this pattern are less fatiguing to blow than those resembling the bassoon. The bore is truly conical, starting with a

diameter of  $\frac{1}{4}$  in. at the reed and ending in a diameter of 4 in. at the open end of the tube which points upwards and has no defined bell, being merely finished with a rim. Alfred Morton, in England, has constructed double bassoons on Dr Stone's design (fig. 2). (3) The third model is of brass and consists of a conical tube of wide calibre some 15 or 16 ft. long, curved round four times upon itself and having a brass tuba or euphonium bell which points upwards. This brass model, usually known as the Belgian or French (fig. 3), was really of Austrian origin, having been first introduced by Schöllnast of Presburg about 1839. B. F. Czerveny of Königgrätz and Victor Mahillon of Brussels both appear to have followed up this idea independently; the former producing a metal contrafagotto in E $\flat$  in 1856 and one in B $\flat$  which he called sub-contrafagotto in 1867, while Mahillon's was ready in 1868. In the brass contrafagotto the lateral holes are pierced at theoretically correct intervals along the bore, and have a diameter almost equal to the section of the bore at the point where the hole is pierced. The octave harmonic only is obtainable on this instrument owing to the great length of the bore and its large calibre. There are therefore two octave keys

which give a chromatic compass 

The modern wooden contrafagotto has a pitch one octave below that of the bassoon and three below that of the oboe; its compass extending from 16 ft. C. to middle C. The harmonics of the octave in the middle register and of the 12th in the upper

register are obtained by skilful manipulation of the reed with the lips and increased pressure of the breath. The notes of both extremes are difficult to produce.

Although the double bassoon is not a transposing instrument the music for it is written an octave higher than the real sounds

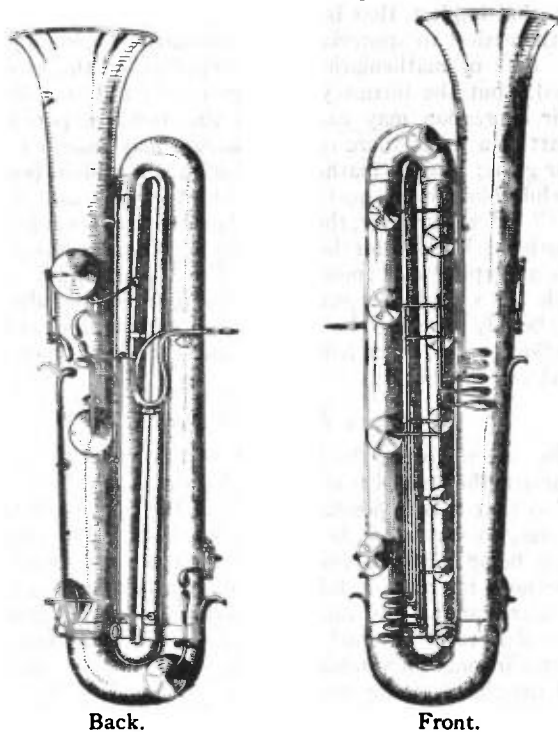
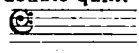

FIG. 3.—The French or Belgian Contrafagotto.  
Back. Front.

in order to avoid the ledger lines. The quality of tone is somewhat rough and rattling in the lowest register, the volume of sound not being quite adequate considering the depth of the pitch. In the middle and upper registers the tone of the wooden contrafagotto possesses all the characteristics of the bassoon. The contrafagotto has a complete chromatic compass, and it may therefore be played in any key. Quick passages are avoided since they would be neither easy nor effective, the instrument being essentially a slow-speaking one. The lowest notes are only possible to a good player, and cannot be obtained *piano*; nevertheless, the instrument forms a fine bass to the reed family, and supplies in the orchestra the notes missing in the double bass in order to reach 16 ft. C.

The origin of the contrafagotto, like that of the oboe (*q.v.*) must be sought in the highest antiquity (see AULOS). Its immediate forerunner was the double bombard or bombardino or the great double quint-

pommer whose compass extended downwards to E 

It is not known precisely when the change took place, though it was probably soon after the transformation of the bassoon, but Handel scored for the instrument and it was used in military bands before being adopted in the orchestra. The original instrument made for Handel by T. Stanesby, junior, and played by J. F. Lampe at the Marylebone Gardens in 1739, was exhibited at the Royal Military Exhibition, London, in 1890. Owing to its faulty construction and weak rattling tone the double bassoon fell into disuse, in spite of the fact that the great composers Haydn, Mozart and Beethoven scored for it abundantly; the last used it in the C minor and choral symphonies and wrote an *obbligato* for it in *Fidelio*. It was restored to favour in England by Dr W. H. Stone. (K. S.)

**CONTRALTO** (from Ital. *contra-alto*, *i.e.* next above the alto), the term for the lowest variety of the female voice, as distinguished from the soprano and mezzo-soprano. Originally it signified, in choral music, the part next higher than the alto, given to the falsetto counter-tenor.

**CONTRAPUNTAL FORMS**, in Music. The forms of music may be considered in two aspects, the texture of the music from moment to moment, and the shape of the musical design as a whole. Historically the texture of music became definitely

organized long before the shape could be determined by any but external or mechanical conceptions. The laws of musical texture were known as the laws of "counterpoint" (see COUNTERPOINT and HARMONY). The "contrapuntal" forms, then, are historically the earliest and aesthetically the simplest in music; the simplest, that is to say, in principle, but not necessarily the easiest to appreciate or to execute. Their simplicity is like that of mathematics, the simplicity of the elements involved; but the intricacy of their details and the subtlety of their expression may easily pass the limits of popularity, while art of a much more complex nature may masquerade in popular guise; just as mathematical science is seldom popularized, while biology masquerades in infant schools as "natural history." Here, however, the resemblance between counterpoint and mathematics ends, for the simplicity of genuine contrapuntal style is a simplicity of emotion as well as of principle; and if the style has a popular reputation of being severe and abstruse, this is largely because the popular conception of emotion is conventional and dependent upon an excessive amount of external nervous stimulus.

### 1. *Canonic Forms and Devices.*

In the *canonic* forms, the earliest known in music as an independent art, the laws of texture also determine the shape of the whole, so that it is impossible, except in the light of historical knowledge, to say which is prior to the other. The principle of canon being that one voice shall reproduce the material of another note for note, it follows that in a composition where all parts are canonic and where the material of the leading part consists of a pre-determined melody, such as a Gregorian chant or a popular song, there remains no room for further consideration of the shape of the work. Hence, quite apart from their expressive power and their value in teaching composers to attain harmonic fluency under difficulties, the canonic forms played the leading part in the music of the 15th and 16th centuries; nor indeed have they since fallen into neglect without grave injury to the art. But strict canon soon proved inadequate, and even dangerous, as the sole regulating principle in music; and its rival and cognate principle, the basing of polyphonic designs upon a given melody to which one part (generally the tenor) was confined, proved scarcely less so. Nor were these two principles, the canon and the *canto fermo*, likely, by combination in their strictest forms, to produce better artistic results than separately. Both were rigid and mechanical principles; and their development into real artistic devices was due, not to a mere increase in the facility of their use, but to the fact that, just as the researches of alchemists led to the foundations of chemistry, so did the early musical puzzles lead to the discovery of innumerable harmonic and melodic resources which have that variety and freedom of interaction which can be organized into true works of art and can give the ancient mechanical devices themselves a genuine artistic character attainable by no other means.

The earliest canonic form is the *rondel* or *rota* as practised in the 12th century. It is, however, canonic by accident rather than in its original intention. It consists of a combination of short melodies in several voices, each melody being sung by each voice in turn. Now it is obvious that if one voice began alone, instead of all together, and if when it went on to the second melody the second voice entered with the first, and so on, the result would be a canon in the unison. Thus the difference between the crude counterpoint of the *rondel* and a strict canon in the unison is a mere question of the point at which the composition begins, and a 12th century *rondel* is simply a canon at the unison begun at the point where all the voices have already entered. There is some reason to believe that one kind of *rondeau* practised by Adam de la Hale was intended to be sung in the true canonic manner of the modern round; and the wonderful English *rota*, "Sumer is icumen in," shows in the upper four parts the true canonic method, and in its two-part *pes* the method in which the parts began together. In these archaic works the canonic form gives the whole a consistency and stability

contrasting oddly with the dismal warfare between nascent harmonic principles and ancient anti-harmonic criteria which hopelessly wrecks them as regards euphony. As soon as harmony became established on a true artistic basis, the unaccompanied round took the position of a trivial hut refined art-form, with hardly more expressive possibilities than the triolet in poetry, a form to which its brevity and lightness renders it fairly comparable. Orlando di Lasso's *Célébrons sans cesse* is a beautiful example of the 16th century round, which was at that time little cultivated by serious musicians. In more modern times the possibilities of the round in its purest form have enormously increased; and with the aid of elaborate instrumental accompaniments it plays an important feature in such portions of classical operatic *ensemble* as can with dramatic propriety be devoted to expressions of feeling uninterrupted by dramatic action. In the modern round the first voice can execute a long and complete melody before the second voice joins in. Even if this melody be not instrumentally accompanied, it will imply a certain harmony, or at all events arouse curiosity as to what the harmony is to be. And the sequel may shed a new light upon the harmony, and thus by degrees the whole character of the melody may be transformed. The power of the modern round for humorous and subtle, or even profound, expression was first fully revealed by Mozart, whose astounding unaccompanied canons would be better known if he had not unfortunately set many of them to extemporized texts unfit for publication. The round or the *catch* (which is simply a specially jocose round) is a favourite English art-form, and the English specimens of it are probably more numerous and uniformly successful than those of any other nation. Still they cannot honestly be said to realize the full possibilities of the form. It is so easy to write a good piece of free and fairly contrapuntal harmony in three or more parts, and so arrange it that it remains correct when the parts are brought in one by one, that very few composers seem to have realized that any further artistic device was possible within such limits. Even Cherubini gives hardly more than a valuable hint that the round may be more than a *jeu d'esprit*; and, unless he be an adequate exception, the unaccompanied rounds of Mozart and Brahms stand alone as works that raise the round to the dignity of a serious art-form. With the addition of an orchestral accompaniment the round obviously becomes a larger thing; and when we consider such specimens as that in the finale of Mozart's *Così fan tutte*, the quartet in the last act of Cherubini's *Faniska*, the wonderfully subtle quartet "Mir ist so wunderbar" in Beethoven's *Fidelio*, and the very beautiful numbers in Schubert's masses where Schubert finds expression for his genuine contrapuntal feeling without incurring the risks resulting from his lack of training in fugue-form, we find that the length of the initial melody, the growing variety of the orchestral accompaniment and the finality and climax of the free coda, combine to give the whole a character closely analogous to that of a set of contrapuntal variations, such as the slow movement of Haydn's "Emperor" string quartet, or the opening of the finale of Beethoven's 9th Symphony. Berlioz is fond of beginning his largest movements like a kind of round; e.g. his *Dies Irae*, and *Scène aux Champs*.

A moment's reflection will show that three conditions are necessary to make a canon into a round. First, the voices must imitate each other in the unison; secondly, they must enter at equal intervals of time; and thirdly, the whole melodic material must be as many times longer than the interval of time as the number of voices; otherwise, when the last voice has finished the first phrase, the first voice will not be ready to return to the beginning. Strict canon is, however, possible under innumerable other conditions, and even a round is possible with some of the voices at the interval of an octave, as is of course inevitable in writing for unequal voices. And in a round for unequal voices there is obviously a new means of effect in the fact that, as the melody rotates, its different parts change their pitch in relation to each other. The art by which this is possible without incorrectness is that of double, triple and multiple counterpoint (see COUNTERPOINT). Its difficulty is



variable, and with an instrumental accompaniment there is none. In fugues, multiple counterpoint is one of the normal resources of music; and few devices are more self-explanatory to the ear than the process by which the subject and counter-subjects of a fugue change their positions, revealing fresh melodic and acoustic aspects of identical harmonic structure at every turn. This, however, is rendered possible and interesting by the fact that the passages in such counterpoint are separated by episodes and are free to appear in different keys. Many fugues of Bach are written throughout in multiple counterpoint; but the possibility of this, even to composers such as Bach and Mozart, to whom difficulties seem unknown, depends upon the freedom of the musical design which allows the composer to select the most effective permutations and combinations of his counterpoint, and also to put them into whatever key he chooses. An unaccompanied round for unequal voices would bring about the permutations and combinations in a mechanical order; and unless the melody were restricted to a compass common to soprano and alto each alternate revolution would carry it beyond the bounds of one or the other group of voices. The technical difficulties of such a problem are destructive to artistic invention. But they do not appear in the above-mentioned operatic rounds, though these are for unequal voices, because here the length of the initial melody is so great that the composition is quite long enough before the last voice has got farther than the first or second phrase, and, moreover, the free instrumental accompaniment is capable of furnishing a bass to a mass of harmony otherwise incomplete.

The resources of canon, when emancipated from the principles of the round, are considerable when the canonic form is strictly maintained, and are inexhaustible when it is treated freely. A canon need not be in the unison; and when it is in some other interval the imitating voice alters the expression of the melody by transferring it to another part of the scale. Again, the imitating voice may follow the leader at any distance of time; and thus we have obviously a definite means of expression in the difference of closeness with which various canonic parts may enter, as, for instance, in the *stretto* of a fugue. Again, if the answering part enters on an unaccented beat where the leader began on the accent, there will be artistic value in the resulting difference of rhythmic expression. This is the device known as *per arsin et thesin*. All these devices are, in skilful hands, quite definite in their effect upon the ear, and their expressive power is undoubtedly due to their special canonic nature. The beauty of the pleading, rising sequences in crossing parts that we find in the canon in the 2nd at the opening of the *Recordare* in Mozart's *Requiem* is attainable by no other technical means. The close canon in the 6th at the distance of one minim in reversed accent in Bach's eighteenth *Goldberg* variation owes all its smooth harmonic expression to the fact that the two canonic parts move in sixths which would be simultaneous but for the pause of the minim which reverses the accents of the upper part while it creates that chain of suspended discords which give harmonic variety to the whole.

Two other canonic devices have important artistic value, namely, *augmentation* and *diminution* (two different aspects of the same thing) and *inversion*. In augmentation the imitating part sings twice as slow as the leader, or sometimes still slower. This obviously should impart a new dignity to the melody, and in diminution the expression is generally that of an accession of liveliness.<sup>1</sup> Neither of these devices, however, continues to appeal to the ear if carried on for long. In augmentation the answering part lags so far behind the leader that the ear cannot long follow the connexion, while a diminished answer will obviously soon overtake the leader, and can proceed on the same plan only by itself becoming the leader of a canon in augmentation. Beethoven, in the fugues in his sonatas *op.* 106 and 110, adapted augmentation and diminution to modern varieties of thematic expression, by employing them in triple

<sup>1</sup> But see the E. major fugue in the second book of the *Wohltemperiertes Klavier*, where the entry of the diminished subject (in a new position of the scale) is very tender and solemn.

time, so that, by *doubling* the length of the original notes across this triple rhythm, they produce an entirely new rhythmic expression. This does not seem to have been applied by any earlier composer with the same consistency or intention.

The device of *inversion* consists in the imitating part reversing every interval of the leader, ascending where the leader descends and vice versa. Its expressive power depends upon such subtle matters of the harmonic expression of melody that its artistic use is one of the surest signs of the difference between classical and merely academic music. There are many melodies of which the inversion is as natural as the original form, and does not strikingly alter its character. Such are, for instance, the theme of Bach's *Kunst der Fuge*, most of Purcell's contrapuntal themes, the theme in the fugue of Beethoven's sonata, *op.* 110, and the eighth of Brahms's variations on a theme by Haydn. In such cases inversion sometimes produces harmonic variety as well as a sense of melodic identity in difference. But where a melody has marked features of rise and fall, such as long scale passages or bold skips, the inversion, if productive of good harmonic structure and expression, may be a powerful method of transformation. This is admirably shown in the twelfth of Bach's *Goldberg Variations*, in the fifteenth fugue of the first book of his *Forty-eight Preludes and Fugues*, in the finale of Beethoven's sonata, *op.* 106, and in the second subjects of the first and last movements of Brahms's clarinet trio.

The only remaining canonic device which figures in classical music is that known as *canonizans*, in which the imitating part reproduces the leader backwards. It is of extreme rarity in serious music; and, though it sometimes happens by accident that a melody or figure of uniform rhythm will produce something equally natural when read backwards, there is only one example of its use that appeals to the ear as well as the eye. This is to be found in the finale of Beethoven's sonata, *op.* 106, where it is applied to a theme with such sharply contrasted rhythmic and melodic features that with long familiarity a listener would probably feel not only the wayward humour of the passage in itself, but also its connexion with the main theme. Nevertheless, the prominence given to the device in technical treatises, and the fact that this is the one illustration which hardly any of them cite, show too clearly the way in which music is treated not only as a dead language but as if it had never been alive.

All these devices are also independent of the canonic idea, since they are so many methods of transforming themes in themselves and need not always be used in contrapuntal combination.

## 2. Fugue.

As the composers of the 16th century made progress in harmonic and contrapuntal expression through the discipline of strict canonic forms, it became increasingly evident that there was no necessity for the maintenance of strict canon throughout a composition. On the contrary, the very variety of canonic possibilities, apart from the artistic necessity of breaking up the uniform fulness of harmony, suggested the desirability of changing one kind of canon for another, and even of contrasting canonic texture with that of plain masses of non-polyphonic harmony. The result is best known in the polyphonic 16th-century motets. In these the essentials of canonic effect are embodied in the entry of one voice after another with a definite theme stated by each voice in that part of the scale which best suits its compass, thus producing a free canon for as many parts as there are voices, in alternate intervals of the 4th, 5th and octave, and at such distances of time as are conducive to clearness and variety of proportion. It is not necessary for the later voices to imitate more than the opening phrase of the earlier, or, if they do imitate its continuation, to keep to the same interval.

Such a texture differs in no way from that of the fugue of more modern times. But the form is not what is now understood as fugue, inasmuch as 16th-century composers did not normally think of writing long movements on one theme or of making a point of the return of a theme after episodes. With the appearance of new words in the text, the 16th-century composer

naturally took up a new theme without troubling to design it for contrapuntal combination with the opening; and the form resulting from this treatment of words was faithfully reproduced in the instrumental *ricercari* of the time. Occasionally, however, breadth of treatment and terseness of design combined to produce a short movement on one idea indistinguishable in form from a *fughetta* of Bach; as in the *Kyrie* of Palestrina's Mass, *Salve Regina*.

But in Bach's art the preservation of a main theme is more necessary the longer the composition; and Bach has an incalculable number of methods of giving his fugues a symmetry of form and balance of climax so subtle and perfect that we are apt to forget that the only technical rules of a fugue are those which refer to its texture. In the *Kunst der Fuge* Bach has shown with the utmost clearness how in his opinion the various types of fugue may be classified. That extraordinary work is a series of fugues, all on the same subject. The earlier fugues show how an artistic design may be made by simply passing the subject from one voice to another in orderly succession (in the first example without any change of key except from tonic to dominant). The next stage of organization is that in which the subject is combined with inversions, augmentations and diminutions of itself. Fugues of this kind can be conveniently called stretto-fugues.<sup>1</sup> The third and highest stage is that in which the fugue combines its subject with contrasted counter-subjects, and thus depends upon the resources of double, triple and quadruple counterpoint. But of the art by which the episodes are contrasted, connected climaxes attained, and keys and subtle rhythmic proportions so balanced as to give the true fugue-forms a beauty and stability second only to those of the true sonata forms, Bach's classification gives us no direct hint. A comparison of the fugues in the *Kunst der Fuge* with those elsewhere in his works reveals a necessary relation between the nature of the fugue-subject and the type of fugue. In the *Kunst der Fuge* Bach has obvious didactic reasons for taking the same subject throughout; and, as he wishes to show the extremes of technical possibility, that subject must necessarily be plastic rather than characteristic. Elsewhere Bach prefers very lively or highly characteristic themes as subjects for the simplest kind of instrumental fugue. On the other hand, there comes a point when the mechanical strictness of treatment crowds out the proper development of musical ideas; and the 7th fugue (which is one solid mass of stretto in augmentation, diminution and inversion) and the 12th and 13th (which are invertible bodily) are academic exercises outside the range of free artistic work. On the other hand, the less complicated stretto-fugues and the fugues in double and triple counterpoint are perfect works of art and as beautiful as any that Bach wrote without didactic purpose.

Fugue is still, as in the 16th century, a texture rather than a form; and the rules given in most technical treatises for its general shape are based, not on the practice of the great composers, but on the necessities of beginners, whom it would be as absurd to ask to write a fugue without giving them a form as to ask a schoolboy to write so many pages of Latin verses without a subject. But this standard form, whatever its merits may be in combining progressive technique with musical sense, has no connexion with the true classical types of fugue, though it played an interesting part in the renaissance of polyphony during the growth of the sonata style, and even gave rise to valuable works of art (e.g. the fugues in Haydn's quartets, *op.* 20). One of its rules was that every fugue should have a stretto. This rule, like most of the others, is absolutely without classical warrant; for in Bach the ideas of stretto and of counter-subject almost exclude one another except in the very largest fugues, such as the 22nd in the second book of the *Forty-eight*; while Handel's fugue-writing is a masterly method, adopted as occasion requires, and with a lordly disdain for recognized devices. But the pedagogic rule proved to be not without artistic point in more modern music; for fugue became, since the rise of the sonata-form, for some generations a contrast with the normal means of expression instead of being itself normal.

<sup>1</sup> For technical terms see articles COUNTERPOINT and FUGUE.

And while this was so, there was considerable point in using every possible means to enhance the rhetorical force of its peculiar devices, as is shown by the astonishing modern fugues in Beethoven's last works. Nowadays, however, polyphony is universally recognized as a permanent type of musical texture, and there is no longer any reason why if it crystallizes into the fugue-form at all it should not adopt the classical rather than the pedagogic type.

It is still an unsatisfied wish of accurate musicians that the term fugue should be used to imply rather a certain type of polyphonic texture than the whole form of a composition. At present one runs the risk of grotesque misconceptions when one quite rightly describes as "written in fugue" such passages as the first subjects in Mozart's *Zauberflöte* overture, the andantes of Beethoven's first symphony and C minor quartet, or the first and second subjects of the finale of Mozart's G major quartet, the second subject of the finale of his D major quintet, and the exposition of quintuple counterpoint in the coda of the finale of the *Jupiter Symphony*, and countless other passages in the developments and main subjects of classical and modern works in sonata form. The ordinary use of the term implies an adherence to a definite set of rules quite incompatible with the sonata style, and therefore inapplicable to these passages, and at the same time equally devoid of real connexion with the idea of fugue as understood by the great masters of the 16th century who matured it. In the musical articles in this Encyclopaedia we shall therefore speak of writing "in fugue" as we would speak of a poet writing in verse, rather than weaken our descriptions by the orthodox epithet of "loose fugato."

### 3. Counterpoint on a Canto Fermo.

The early practice of building polyphonic designs on a voice-part confined to a given plain-song or popular melody furnishes the origin for every contrapuntal principle that is not canonic, and soon develops into a canonic principle in-itself. When the *canto fermo* is in notes of equal length and is sung without intermission, it is of course as rigid a mechanical device as an acrostic. Yet it may have artistic value in furnishing a steady rhythm in contrast to suitable free motion in the other parts. When it is in the bass, as in Orlando di Lasso's six-part *Regina Coeli*, it is apt to cramp the harmony; but when it is in the tenor (its normal place in 16th-century music), or any other part, it determines little but the length of the composition. It may or may not appeal to the ear; if not, it at least does no harm, for its restricting influence on the harmony is small if its pace is slower than that of its surroundings. If, on the other hand, its melody is characteristic, or can be enforced by repetition, it may become a powerful means of effect, as in the splendid close of Fayrfax's Mass *Albanus* quoted by Professor Wooldridge on page 320 in the second volume of the *Oxford History of Music*. Here the tenor part ought to be sung by a body of voices that can be distinctly heard through the glowing superincumbent harmony; and then the effect of its five steps of sequence in a melodious figure of nine semibreves will reveal itself as the principle which gives the passage consistency of drift and finality of climax.

When the rhythm of the *canto fermo* is not uniform, or when pauses intervene between its phrases, whether these are different figures or repetitions of one figure in different parts of the scale, the device passes into the region of free art, and an early example of its simplest use is described in the article *MUSIC* as it appears in Josquin's wonderful *Miserere*. Orlando di Lasso's work is full of instances of it, one of the most dramatic of which is the motet *Fremuit spiritu Jesus* (*Magnum Opus* No. 553 [378]), in which, while the other voices sing the scripture narrative of the death and raising of Lazarus, the tenor is heard singing to an admirably appropriate theme the words, *Lazare, veni foras*. When the end of the narrative is reached, these words fall into their place and are of course taken up in a magnificent climax by the whole chorus.

The free use of phrases of *canto fermo* in contrapuntal texture, whether confined to one part or taken up in fugue by all,

constitutes the whole fabric of 16th-century music; except where polyphonic device is dispensed with altogether, as in Palestrina's two settings of the *Stabat Mater*, his *Litanies*, and all of his later *Lamentations* except the initials. A 16th-century mass, when it is not derived in this way from those secular melodies to which the council of Trent objected, is so closely connected with Gregorian tones, or at least with the themes of some motet appropriate to the holy day for which it was written, that in a Roman Catholic cathedral service the polyphonic music of the best period co-operates with the Gregorian intonations to produce a consistent musical whole with a thematic coherence almost suggestive of Wagnerian *Leitmotif*. In later times the Protestant music of Germany attained a similar consistency, under more complicated musical conditions, by the use of chorale-tunes; and in Bach's hands the fugal and other treatment of chorale-melody is one of the most varied and expressive of artistic resources. It seems to be less generally known that the chorale plays a considerable though not systematic part in Handel's English works. The passage "the kingdoms of the world" in the "Hallelujah Chorus" (down to "and He shall live for ever and ever") is a magnificent development of the second part of the chorale *Wachet auf* ("Christians wake, a voice is calling"); and it would be easy to trace a German or Roman origin for many of the solemn phrases in long notes which in Handel's choruses so often accompany quicker themes.

From the use of an old *canto fermo* to the invention of an original one is obviously a small step; and as there is no limit to the possibilities of varying the *canto fermo*, both in the part which most emphatically propounds it and in the imitating or contrasted parts, so there is no line of demarcation between the free development of counterpoint on a *canto fermo* and the general art of combining melodies which gives harmony its deepest expression and musical texture its liveliest action. Nor is there any such line to separate polyphonic from non-polyphonic methods of accompanying melody; and Bach's *Orgelbüchlein* and Brahms's posthumous organ-chorales show every conceivable gradation between plain harmony or arpeggio and the most complex canon.

In Wagnerian polyphony canonic devices are rare except in such simple moments of anticipation or of communion with nature as we have before the rise of the curtain in the *Rheingold* and at the daybreak in the second act of the *Götterdämmerung*. On the other hand, the art of combining contrasted themes crowds almost every other kind of musical texture (except tremolos and similar simple means of emotional expression) into the background, and is itself so transformed by new harmonic resources, many of which are Wagner's own discovery, that it may almost be said to constitute a new form of art. The influence of this upon instrumental music is as yet helpful only in those new forms which are breaking away from the limits of the sonata style; and it is impossible at present to sift the essential from the unessential in that marvellous compound of canonic device, Wagnerian harmony, original technique and total disregard of every known principle of musical grammar, which renders the work of Richard Strauss the most remarkable musical phenomenon of recent years. All that is certain is that the two elements in which the music of the future will finally place its main organizing principles are not those of instrumentation and external expression, on which popular interest and controversy are at present centred, but rhythmic flow and counterpoint. These have always been the elements which suffered from neglect or anarchy in earlier transition-periods, and they have always been the elements that gave rationality to the new art to which the transitions led. (D. F. T.)

**CONTREXÉVILLE**, a watering-place of north-eastern France, in the department of Vosges, on the Vair, 39 m. W. of Épinal by rail. Pop. (1906) 940. The mineral springs of Contrexéville have been in local repute since a remote period, but became generally known only towards the end of the 18th century; and the modern reputation of the place as a health resort dates from 1864, when it began to be developed by a company, the Société des Eaux de Contrexéville, and more particularly from about 1895. In the ten years after this latter date many improvements

were made for the accommodation of visitors, for whom the season is from May to September. The waters of the Source Pavillon, which are used chiefly for drinking, have a temperature of 53° F. and are characterized chiefly by the presence of calcium sulphate. They are particularly efficacious in the treatment of gravel and kindred disorders, by the elimination of uric acid.

See *Thirty-five years at Contrexéville* (1903), by Dr Debout d'Estrées.

**CONTROL** (Fr. *contrôle*, older form *contre rolle*, from Med. Lat. *contra-rotulus*, a counter roll or copy of a document used to check the original; there is no instance in English of the use of "control" in this, its literal, meaning), a substantive (whence the verb) for that which checks or regulates anything, and so especially command of body or mind by the will, and generally the power of regulation. In England the "Board of Control," abolished in 1858, was the body which supervised the East India Company in the administration of India. In the case of "controller," a general term for a public official who checks expenditure, the more usual form "comptroller" is a wrong spelling due to a false connexion with "accout" or "account." A "control" or "control-experiment," in science, is an experiment used, by an application of the method of difference, to check the inferences drawn from another experiment.

**CONTUMACY** (Lat. *contumacia*, obstinacy; derived from the root *tem-*, as in *temnere*, to despise, or possibly from the root *tum-*, as in *tumere*, to swell, with anger, &c.), a stubborn refusal to obey authority, obstinate resistance; particularly, in law, the wilful contempt of the order or summons of a court (see CONTEMPT OF COURT). In ecclesiastical law, the contempt of the authority of an ecclesiastical court is dealt with by the issue of a writ *de contumace capiendo* from the court of chancery at the instance of the judge of the ecclesiastical court; this writ took the place of that *de excommunicato capiendo* in 1813, by an act of George III. c. 127 (see EXCOMMUNICATION).

**CONUNDRUM** (a word of unknown origin, probably coined in burlesque imitation of scholastic Latin, as "hocus-pocus" or "panjandrum"), originally a term meaning whim, fancy or ridiculous idea; later applied to a pun or play upon words, and thus, in its usual sense, to a particular form of riddle in which the answer depends on a pun. In a transferred sense the word is also used of any puzzling question or difficulty.

**CONVENT** (Lat. *conventus*, from *convenire*, to come together), a term applied to an association of persons secluded from the world and devoted to a religious life, and hence to the building in which they live, a monastery or (more particularly) nunnery. The diminution "conventicle" (*conventiculum*), generally used in a contemptuous sense as implying sectarianism, secrecy or illegality, is applied to the meetings or meeting-places of religious or other dissenting bodies.

**CONVENTION** (Lat. *conventio*, an assembly or agreement, from *convenire*, to come together), a meeting or assembly; an agreement between parties; a general agreement on which is based some custom, institution, rule of behaviour or taste, or canon of art; hence extended to the abuse of such an agreement, whereby the rules based upon it become lifeless and artificial. The word is of some interest historically and politically. It is used of an assembly of the representatives of a nation, state or party, and is particularly contrasted with the formal meetings of a legislature. It is thus applied to those parliaments in English history which, owing to the abeyance of the crown, have assembled without the formal summons of the sovereign; in 1660 a convention parliament restored Charles II. to the throne, and in 1689 the Houses of Commons and Lords were summoned informally to a convention by William, prince of Orange, as were the Estates of Scotland, and declared the throne abdicated by James II. and settled the disposition of the realm. Similarly, the assembly which ruled France from September 1792 to October 1795 was known as the National Convention (see below); the statutory assembly of delegates which framed the constitution of the United States of America in 1787 was called the Constitutional Convention; and the various American state constitutions have been drafted and sometimes revised by constitutional

conventions. In the party system of the United States the nomination of party candidates for office or election is in the hands of delegates, chosen by the primaries, meeting in the convention of the party; the convention system is universal, from the national conventions of the Republican and Democratic parties, which nominate the candidates for the presidency and vice-presidency, down to a ward convention, which nominates the candidate for a town-councillorship. In diplomacy, "convention" is a general name given to international agreements other than treaties, but not necessarily differing either in form or subject-matter from a treaty, and sometimes used quite widely of all forms of such agreements. Many conventions have been made for the formation of international "unions" to regulate and protect various economic, industrial and other non-political interests, such as postal and telegraphic services, trade-marks, patents, copyright, quarantine, &c. Thus the Latin Monetary Union was created in 1865 by the Convention of Paris, and the abolition of bounties on the production and exportation of sugar by the Convention of Brussels in 1902 (see TREATIES).

**CONVENTION, THE NATIONAL**, in France, the constitutional and legislative assembly which sat from the 20th of September 1792 to the 26th of October 1795 (the 4th of Brumaire of the year IV.). On the 10th of August 1792, when the populace of Paris stormed the Tuileries and demanded the abolition of the monarchy, the Legislative Assembly decreed the provisional suspension of the king and the convocation of a national convention which should draw up a constitution. At the same time it was decided that the deputies to that convention should be elected by all Frenchmen 25 years old, domiciled for a year and living by the product of their labour. The National Convention was therefore the first French assembly elected by universal suffrage, without distinctions of class. The age limit of the electors was further lowered to 21, and that of eligibility was fixed at 25 years.

The first session was held on the 20th of September 1792. The next day royalty was abolished, and on the 22nd it was decided that all documents should be henceforth dated from the year I. of the French Republic. The Convention was destined to last for three years. The country was at war, and it seemed best to postpone the new constitution until peace should be concluded. At the same time as the Convention prolonged its powers it extended them considerably in order to meet the pressing dangers which menaced the Republic. Though a legislative assembly, it took over the executive power, entrusting it to its own members. This "confusion of powers," which was contrary to the philosophical theories—those of Montesquieu especially—which had inspired the Revolution at first, was one of the essential characteristics of the Convention. The series of exceptional measures by which that confusion of powers was created constitutes the "Revolutionary government" in the strict sense of the word, a government which was principally in vigour during the period called "the Terror." It is thus necessary to distinguish, in the work of the Convention, the temporary expedients from measures intended to be permanent.

The Convention held its first session in a hall of the Tuileries, then it sat in the hall of *Manège*, and finally from the 10th of May 1793 in that of the *Spectacles* (or *Machines*), an immense hall in which the deputies were but loosely scattered. This last hall had tribunes for the public, which often influenced the debate by interruptions or applause. The full number of deputies was 749, not counting 33 from the colonies, of whom only a section arrived in Paris. Besides these, however, the departments annexed from 1792 to 1795 were allowed to send deputations. Many of the original deputies died or were exiled during the Convention, but not all their places were filled by *suppléants*. Some of those proscribed during the Terror returned after the 9th of Thermidor. Finally, many members were sent away either to the departments or to the armies, on missions which lasted sometimes for a considerable length of time. For all these reasons it is difficult to find out the number of deputies present at any given date, for votes by roll-call were rare. In

the Terror the number of those voting averaged only 250. The members of the Convention were drawn from all classes of society, but the most numerous were lawyers. Seventy-five members had sat in the Constituent Assembly, 183 in the Legislative.

According to its own ruling, the Convention elected its president every fortnight. He was eligible for re-election after the lapse of a fortnight. Ordinarily the sessions were held in the morning, but evening sessions were also frequent, often extending late into the night. Sometimes in exceptional circumstances the Convention declared itself in permanent session and sat for several days without interruption. For both legislative and administrative purposes the Convention used committees, with powers more or less widely extended and regulated by successive laws. The most famous of these committees are those of Public Safety, of General Security, of Education (*Comité de salut public*, *Comité de sûreté générale*, *Comité de l'instruction*).

The work of the Convention was immense in all branches of public affairs. To appreciate it without prejudice, one should recall that this assembly saved France from a civil war and invasion, that it founded the system of public education (*Museum*, *École Polytechnique*, *École Normale Supérieure*, *École des Langues orientales*, *Conservatoire*), created institutions of capital importance, like that of the *Grand Livre de la Dette publique*, and definitely established the social and political gains of the Revolution.

See FRENCH REVOLUTION; GIRONDISTS; MOUNTAIN; DANTON; ROBESPIERRE; MARAT, &c.

**BIBLIOGRAPHY.**—The Convention published a *Procès-verbal* of its sessions, which, although lacking the value of those published by assemblies to-day, is an official document of capital importance. Copies of it are rare, however, and it has been too much neglected by historians. See F. A. Aulard, *Recueil des actes du comité de Salut Public avec la correspondance officielle des représentants en mission, et le registre du conseil exécutif provisoire* (Paris, 1889 et seq.); M. J. Guillaume, *Procès-verbaux du comité d'Instruction Publique de la Convention Nationale* (Paris, 1891–1904, 5 vols. 4to); F. A. Aulard, *Histoire politique de la Révolution française* (Paris, 1903); Mortimer-Ternaux, *Histoire de la Terreur* (1862–1881), a work based on and comprising documents, but written with strong royalist bias; Eugène Despois, *Le Vandalisme révolutionnaire* (1868), for the scientific work of the Convention. A detailed bibliography of the documents relating to the Convention is given in the *Répertoire général des sources manuscrites de l'histoire de Paris pendant la Révolution française*, vol. viii. &c. (1908), edited by A. Tueléy under the auspices of the municipality of Paris. For a more summary bibliography see M. Tourneux, *Bibliog. de l'histoire de Paris pendant la Révolution française*, i. 89–95 (Paris, 1890). (R. A.)

**CONVERSANO**, a town and episcopal see of Apulia, Italy, in the province of Bari, 17 m. S.E. by rail from the town of Bari. Pop. (1901) 13,685. It has a fine southern Romanesque cathedral of the end of the 11th century, with a modernized interior, and a castle which from 1456 belonged to the Acquaviva family, dukes of Atri and counts of Conversano. The convent of S. Benedetto is one of the earliest offshoots of Montecassino. (See S. Simone, *Il Duomo di Conversano*, Trani, 1896). Here, or in the vicinity, is the site of the unimportant ancient town of Norba.

**CONVERSION** (Lat. *conversio*, from *convertere*, to turn or change), a general term for the operation of converting, changing, or transposing; used technically in special senses in logic, theology and law.

1. In logic, conversion is one of three chief methods of immediate inference by which a conclusion is obtained directly from a single premise without the intervention of another premise or middle term. A proposition is said to be "converted" when the subject and the predicate change places; the original proposition is the "convertend," the new one the "converse." The chief rule governing conversion is that no term which was not *distributed*<sup>1</sup> in the convertend may be distributed in the converse; nor may the quality of the proposition (affirmative or negative) be changed. It follows that of the four possible forms

<sup>1</sup> A term is said to be "distributed" when it is taken universally: in the proposition "men are mortal" (meaning "all men") the term "men" is "distributed" while "mortal" is undistributed, because there are mortal beings which are not men.

of propositions A, E, I and O (see article A), E and I can be converted simply. If no A is B (E), it follows that no B is A; if some A is B, it follows that some B is A. This form of conversion is called Simple Conversion; E propositions convert into E, and I into I. On the other hand, A cannot be converted simply. If all men are mortal, the most that can follow by conversion is that some mortals are men. This is called Conversion by Limitation or *Per Accidens*. Only if it be known from external or non-logical sources that the predicate also is distributed can there be simple conversion of a universal affirmative. Neither of these forms of conversion can be applied to the particular negative proposition O, which has to be dealt with under a secondary system of conversion, as follows. The terminology by which these secondary processes are described is not altogether satisfactory, and logicians are not agreed as to the application of the terms. The following system is perhaps the most commonly used. We have seen that the converse of "all A is B" is "some B is A"; we can, in addition, derive from it another, though purely formal, proposition "no A is not-B"; i.e. an E proposition. This process is called Obversion, Permutation or Immediate Inference by Privative Conception; it is applicable to every proposition including O. A further process, known as Contraposition or Conversion by Negation, consists of conversion following on obversion. Thus from "all A is B," we get "no not-B is A." In the case of the O proposition we get (by obversion) "some A is not-B" and then (by conversion) "some not-B is A" (i.e. an I proposition). In the case of the I proposition the contrapositive is impossible, as infringing the main rule of conversion. Another term, Inversion, has been used by some logicians for a still more complicated process by the alternative use of conversion and obversion, which is applicable to A and E, and results in obtaining a proposition concerning the contradictory of the original subject; thus "all A is B" becomes "some not-A is not B."

Considerable discussion has centred on the problem as to whether the process of conversion can properly be regarded as inference. The essence of inference is that the conclusion should embody knowledge which is not in the premise or premises, and many logicians have contended that no fact is stated in the converse which was not in the convertend, or, in other words, that conversion is merely a transformation or verbal change of the same statement. Hence the term *Eductions* and *Equivalent Propositional Forms* have been given to converse propositions. It is clear, for instance, that if the universal affirmative is taken connotatively as a scientific law, and not historically, no real inference is achieved by stating as another scientific fact its converse, the particular affirmative. Moreover, even if the convertend is stated as an historic fact, though there is acquired a certain new significance, it may well be argued that the inference is not immediate but syllogistic.

For this controversy see J. S. Mill, *Logic*, II. i. 2; Bradley, *Logic*, III. pt. i. chap. ii. 30-37; H. W. B. Joseph, *Introduction to Logic* (1906), pp. 209 foll.; J. N. Keynes, *Formal Logic* (3rd ed., 1894).

2. In *theology*, conversion (the equivalent of the Gr. *στροφή*, *ἐπιστροφή*) is originally the acceptance of Christianity by heathens. It is also used generally for a change from one religion to another, or in a narrower sense for a complete change of attitude towards God, involving a deeper conviction of the ultimate religious and moral truths. Considerable difference of opinion has always existed, and still exists, within the Christian Church as to the true nature and the causes of conversion, especially in the sense last described. Some have held that man is merely the passive recipient of the Divine Grace, a view based largely on the rendering of the Authorized Version of Isaiah vi. 10 as quoted in Matt. xiii. 15, Mark iv. 12, and John xii. 40. Others again hold that baptism, as involving a second birth of the baptized person, makes subsequent conversion unnecessary or even meaningless, or conversely that conversion is this very second birth and renders baptism unnecessary. The reply generally made to such arguments is that baptism implies regeneration only, which is a change wrought from the outside by the Divine Spirit in general disposition or spiritual status,

while conversion is a positive or concrete demonstration of that change, not merely the negative beginning of a new life but the positive "returning" to God in faith and repentance. The precise connexion between conversion and repentance is again a vexed question. How far and in what sense does man take an active part in his own conversion? To this it is frequently answered that while the initial stage of conversion is and can be the work of the Holy Spirit alone, it lies with man to make it complete by accepting the proffered grace in repentance and faith (cf. Acts vii. 51, "Ye stiffnecked and uncircumcised in heart and ears, ye do always resist the Holy Ghost"). A man may of his own free will avoid those surroundings which predispose him to such "resistance." The view that man cannot convert himself is clearly stated in Article X. by the Church of England. "The condition of man after the fall of Adam is such that he cannot turn (*sese convertere*) and prepare himself by his own natural strength and good works, to faith, and calling upon God: wherefore we have no power to do good works pleasant and acceptable to God, without the grace of God by Christ preventing us that we may have a good will, and working with us, when we have that good will." Further problems are connected with the possibility of repeated conversions of the same man, the necessity of a single strongly marked conversion completed in a single process, the significance of sudden conversion of persons in a highly emotional state, such as has been common in revivalist meetings, especially in Wales and the United States of America. Conversions of the last kind have followed frequently on striking physical phenomena, perceived in many cases only by the convert himself, such as a sudden bright light or a noise like a clap of thunder.<sup>1</sup> In all cases of conversion, however, the criterion of its validity is generally taken to be the resultant change of a man's character as manifested in his mode of life and thought, in the abstinence from sin, and in devotion to good works. (X.)

3. In *English law*, conversion is the unauthorized exercise of dominion by one person over the property (other than money or chattels real) of another, in a manner inconsistent with his rights of possession, or the unauthorized assumption by another of the powers of the true owner of goods. The history and exact definition of this form of actionable wrong have occupied the attention of many learned writers, and the incidents of actions to assert the rights of the true owner form a considerable part of treatises on the rules and forms of civil pleading. There are many ways in which the wrong may be committed. In some cases the exercise of the dominion may amount to an act of trespass or to a crime, e.g. where the taking amounts to larceny, or fraudulent appropriation by a bailee or agent entrusted with the property of another (Larceny Acts of 1861 and 1901). But in such cases, except where money is taken, the civil remedy of the owner is by action for conversion or detention of the property, subject in the case of larceny to the rule that criminal prosecution should precede restitution by the taker. The remedy in use in these cases used to be by what was called an action on the case for trover and conversion, the plaintiff putting aside all suggestions of trespass and of crime, and resting his case on the fiction that the defendant had found and used goods not his own. The fictitious averment of loss was abolished in 1852, and under the present procedure, in which the old forms of action are not in use, the remedy is by a claim (still usually called conversion) for wrongfully depriving the true owner of personal property of its use by some specified act inconsistent with his dominion over it, usually by dealing with the property in a manner inconsistent with the owner's rights. Originally, the action of trover and conversion was limited to goods and chattels, but it is now accepted as applying to valuable securities, such as cheques and bills of exchange.

The gist of the action is in the unauthorized dealing, for however short a time and for however limited a purpose, with the personal property of another. Even refusal to deliver up to the owner is sufficient to prove conversion, though it is often

<sup>1</sup> Numerous instances, drawn from other religions besides Christianity, are given in Professor William James's *The Varieties of Religious Experience* (1902).



made the ground of an action for detinue, if the plaintiff desires to have the property returned in specie. The knowledge, motive or good faith of the person wrongfully dealing with the property of another is for civil purposes immaterial, and the action is often brought to try the title of two claimants to the same goods; e.g. where a person who has innocently bought or taken in pledge goods stolen or illegally procured resists the claim of the original owner for the return of the goods. A warehouseman may render himself liable to the owner of goods deposited with him, through delivering the goods to a third person on a forged authority or without authority, or by issuing a warehouse receipt representing the goods to be in his possession or control when they have ceased to be so.

The exact measure of compensation due to a plaintiff whose goods have been wrongfully converted may be merely nominal if the wrong is technical and the defendant can return the goods; it may be limited to the actual damage where the goods can be returned, but the wrong is substantial; but in ordinary cases it is the full value to the owner of the goods of which he has been deprived.

Fraudulent conversion by any person to his own use (or that of persons other than the owner) of property entrusted to him is a crime in the case of custodians of property, factors, trustees under express trusts in writing (Larceny Act, 1861, ss. 77-85; Larceny Act, 1901).

The law of Ireland, of most British possessions, and of the United States, follows that of England as to the civil or criminal remedies for conversion.

The term "conversion" is also used in English law with reference to the rule of courts of equity which, in certain cases (following the maxim of treating as done what ought to have been done), treats as converted into personalty land which has been directed so to be converted by a will, contract or settlement, or as converted into land personalty which has been by such instrument directed to be applied for purchase of realty. The rule is also applied where a vendor of land dies between the making of the contract of sale and its completion by conveyance of the land. The importance of the rule lies in the different destination of realty and personalty under the laws relating to inheritance and succession.

See Bullen and Leake, *Precedents of Pleading* (3rd ed., 1868, 6th ed. by Dodd and Chitty, 1905); F. Pollock, on *Torts* (7th ed., 1904); Clerk and Lindsell, on *Torts* (3rd ed., 1904); Lewin, on *Trusts* (11th ed., 1904); Jarman, on *Wills* (5th ed., 1893); Dart, *Vendors and Purchasers* (11th ed., p. 301). (W. F. C.)

**CONVEY** (Lat. *convexus*, carried round, rounded, from *con-*, with, and *vehere*, to carry), a term for the exterior side of a curved or rounded surface, as opposed to "concave" (Lat. *con-*, and *cavus*, hollow), the inner surface.

**CONVEYANCE**, primarily the act or process of conveying anything. The verb "to convey," now used in the senses of carrying, transporting, transmitting, communicating or handing over, originally had the same meaning as "convoy" (*q.v.*), i.e. to accompany, a meaning which still survived in the 18th century. Like "convoy" it is ultimately derived from the Late Lat. *conviare* (not from *convehere*), but through the old Norman French form *conveier*, which in central France passed into the form *convoier*, mod. Fr. *convoyer*, whence "convoy." Apart from the general sense given above the word conveyance is now used in three special senses: (1) a carriage or other means of transport, (2) in law, the transference of property by deed or writing between living persons, and (3) the written instrument by which such transference is effected. (See CONVEYANCING.)

**CONVEYANCING**, in English law, the art or science of conveying or effecting the transfer of property, or modifying interests in relation to property, by means of written documents.

In early legal systems the main element in the transfer of property was the change, generally accompanied by some public ceremony, in the actual physical possession: the function of documents, where used, being merely the preservation of evidence. Thus, in Great Britain in the feudal period, the common mode of conveying an immediate freehold was by *feoffment with livery of seisin*—a proceeding in which the

transferee was publicly invested with the feudal possession or *seisin*, usually through the medium of some symbolic act performed in the presence of witnesses upon the land itself. A deed or charter of feoffment was commonly executed at the same time by way of record, but formed no essential part of the conveyance. In the language of the old rule of the common law, the immediate freehold in corporeal hereditaments lay in livery, whereas reversions and remainders and all incorporeal hereditaments lay in grant, i.e. passed by the delivery of the deed of conveyance or grant without any further ceremony. The process by which this distinction was broken down and the present uniform system of private conveyancing by simple deed was established, constitutes a long chapter in English legal history.

The land of a feudal owner was subject to the risk of forfeiture for treason, and to military and other burdens. The common law did not allow him to dispose of it by will. By the law of mortmain religious houses were prohibited from acquiring it. The desire to escape from these burdens and limitations gave rise to the practice of making feoffments to the use of, or upon trust for, persons other than those to whom the seisin or legal possession was delivered. The common law recognized only the legal tenant; but the *cestui que use* or beneficial owner gradually secured for his wishes and directions concerning the profits of the land the strong protection of the chancellors as exercising the equitable jurisdiction of the king. The resulting loss to the crown and the great lords of the feudal dues and privileges, coupled with the public disadvantages arising from ownership of land which, in an increasing degree, was merely nominal, brought about the passing in the year 1535 of the famous Statute of Uses, the object of which was to destroy altogether the system of uses and equitable estates. It enacted, in substance, that whoever should have a use or trust in any hereditaments should be deemed to have the legal seisin, estate and possession for the same interest that he had in the use; in other words, that he should become in effect the feudal tenant without actual delivery of possession to him by the actual feoffee to uses or trustee. In its result the statute was a fiasco. It was solemnly decided that the act transferred the legal possession to the use once only, and that in the case of a conveyance to A to the use of B to the use of or upon trust for C, it gave the legal estate to B, and left C with an interest in the position of the use before the statute. Thus was completed the foundation of the modern system of trusts fastened upon legal estates and protected by the equitable doctrines and practice of the judicature.

But the statute not only failed to abolish uses: it also opened the way to the evasion of the public ceremony of livery of seisin, and the avoidance of all notoriety in conveyances. Other ways, besides an actual feoffment to uses, of creating a use had been in vogue before the statute. If A bargained with B, in writing or not, for the sale of land, and B paid the price, but A remained in legal possession, the court of chancery enforced the use or equitable interest in favour of B. The effect of a *bargain and sale* (as such a transaction was called) after the statute was to give B the legal interest without any livery of seisin. This fresh danger was met in the very year of the statute itself by an enactment that a bargain and sale of an estate of inheritance or freehold should be made by deed publicly enrolled. But the Statute of Enrolments was in terms limited to estates of freehold. It was allowed that a bargain and sale for a term, say, of one year, must transfer the seisin to the bargainee without enrolment. And since what remained in the bargainor was merely a reversion which "lay in grant," it was an easy matter to release this by deed the day after. By this ingenious device was the publicity of feoffment or enrolment avoided, and the *lease and release*, as the process was called, remained the usual mode of conveying a freehold in possession down to the 19th century.

It was not until 1845 that the modern system of transfer by a single deed was finally established. By the Real Property Act of that year it was enacted that all corporeal hereditaments should, as regards the immediate freehold, be deemed to lie in grant as well as in livery. Since this act the ancient modes of conveyance, though not abolished by it, have in practice become obsolete. Traces of the old learning connected with them remain, however, embedded in the modern conveyance. Many a purchase-deed recites that the vendor is *seised* in fee-simple of the property. It is the practice, moreover, to convey not only "to" but also "to the use of" a purchaser. For before the Statute of Uses, a conveyance made without any consideration or declaration of uses was deemed to be made to the use of the party conveying. In view of the operation of the statute upon the legal estate in such circumstances, it is usual in all conveyances, whether for value or not, to declare a use in favour of the party to whom the grant is made.

In its popular usage the word "conveyance" signifies the document employed to carry out a purchase of land. But the term "conveyancing" is of much wider import, and comprises the preparation and completion of all kinds of legal instruments. A well-known branch of the conveyancer's business is the investigation of title—an important function in the case of purchases or mortgages of real estate. With personal estate (other than leasehold) he has perhaps not so much concern. Chattels are usually transferred by delivery, and stocks or shares by means of printed instruments which can be bought at a law-stationer's. The common settlements and wills, however, deal wholly or mainly with personal property; and an interest in settled personalty is frequently the subject of a mortgage. Of late years, also, there has been an enormous increase in the volume of conveyancing business in connexion with limited joint-stock companies.

In the preparation of legal documents the practitioner is much assisted by the use of *precedents*. These are outlines or models of instruments of all kinds, exhibiting in accepted legal phraseology their usual form and contents with additions and variations adapted to particular circumstances. Collections of them have been in use from early times, certainly since printing became common. The modern precedent is, upon the whole, concise and businesslike. The prolixity which formerly characterized most legal documents has largely disappeared, mainly through the operation of statutes which enable many clauses previously inserted at great length to be, in some cases, *e.g.* covenants for title, incorporated by the use of a few prescribed words, and in others safely omitted altogether. The Solicitors' Remuneration Act 1881, has also assisted the process of curtailment, for there is now little or no connexion between the length of a deed and the cost of its preparation. So long as the draftsman adheres to recognized legal phraseology and to the well-settled methods of carrying out legal operations, there is no reason why modern instruments should not be made as terse and businesslike as possible.

It is not usual for land to be sold without a formal agreement in writing being entered into. This precaution is due, partly to the Statute of Frauds (§ 4), which renders a contract for the sale of land unenforceable by action "unless the agreement upon which such action shall be brought, or some memorandum or note thereof, shall be in writing and signed by the party to be charged therewith or some other person thereunto by him lawfully authorized," and partly to the fact that there are few titles which can with prudence be exposed to all the requisitions that a purchaser under an "open contract" is entitled by law to make. Such a purchaser may, for example, require a forty years' title (Vendor and Purchaser Act 1874). Under an open contract a vendor is presumed to be selling the fee-simple in possession, free from any incumbrance, or liability, or restriction as to user or otherwise; and if he cannot deduce a title of the statutory length, or procure an incumbrance or restriction to be removed, the purchaser may repudiate the contract. The preparation of an agreement for sale involves accordingly an examination of the vendor's title, and the exercise of skill and judgment in deciding how the vendor may be protected against trouble and expense without prejudice to the sale. Upon a sale by auction the agreement is made up of (1) the particulars, which describe the property; (2) the conditions of sale, which state the terms upon which it is offered; and (3) the memorandum or formal contract at the foot of the conditions, which incorporates by reference the particulars and conditions, names or sufficiently refers to the vendor, and is signed by the purchaser after the sale. The object of the agreement, whether the sale is by private contract or by auction, is to define accurately what is sold, to provide for the length of title and the evidence in support of or in connexion with the title which is to be required except so far as it is intended that the general law shall regulate the rights of the parties, and to fix the times at which the principal steps in the transaction are to be taken. It is also usual to provide for the payment of interest at a prescribed rate upon the purchase money if the completion

shall be delayed beyond the day fixed for any cause other than the vendor's wilful default, and also that the vendor shall be at liberty to rescind the contract without paying costs or compensation if the purchaser insists upon any requisition or objection which the vendor is unable or, upon the ground of expense or other reasonable ground, is unwilling to comply with or remove. Upon a sale by auction it is the rule to require a deposit to be paid by way of security to the vendor against default on the part of the purchaser.

The signature of the agreement is followed by the delivery to the purchaser or his solicitor of the abstract of title, which is an epitome of the various instruments and events under and in consequence of which the vendor derives his title. A purchaser is entitled to an abstract at the vendor's expense unless otherwise stipulated. It begins with the instrument fixed by the contract for the commencement of the title, or, if there has been no agreement upon the subject, with an instrument of such character and date as is prescribed by the law in the absence of stipulation between the parties. From its commencement as so determined the abstract, if properly prepared, shows the history of the title down to the sale; every instrument, marriage, birth, death, or other fact or event constituting a link in the chain of title, being sufficiently set forth in its proper order. The next step is the verification of the abstract on the purchaser's behalf by a comparison of it with the originals of the deeds, the probates of the wills, and office copies of the instruments of record through which the title is traced. The vendor is bound to produce the original documents, except such as are of record or have been lost or destroyed, but, unless otherwise stipulated, the expense of producing those which are not in his possession falls upon the purchaser (Conveyancing Act 1881). After being thus verified, the abstract is perused by the purchaser's advisers with the object of seeing whether a title to the property sold is deduced according to the contract, and what evidence, information or objection, in respect of matters appearing or arising upon the abstract, ought to be called for or taken. For this purpose it is necessary to consider the legal effect of the abstracted instruments, whether they have been properly completed, whether incumbrances, adverse interests, defects, liabilities in respect of duties, or any other burdens or restrictions disclosed by the abstract, have been already got rid of or satisfied, or remain to be dealt with before the completion of the sale. The result of the consideration of these matters is embodied in "requisitions upon title," which are delivered to the vendor's solicitors within a time usually fixed for the purpose by the contract. In making or insisting upon requisitions regard is had, among other things, to any special conditions in the contract dealing with points as to which evidence or objection might otherwise have been required or taken, and to a variety of provisions contained in the Vendor and Purchaser Act 1874, and the Conveyancing Act 1881, which apply, except so far as otherwise agreed, and of which the following are the most important: (1) Recitals, statements and descriptions of facts, matters and parties contained in instruments twenty years old at the date of the contract are, unless proved inaccurate, to be taken as sufficient evidence of the truth of such facts, matters and descriptions; (2) a purchaser cannot require the production of, or make any requisition or objection in respect of, any document dated before the commencement of the title; (3) the cost of obtaining evidence and information not in the vendor's possession must be borne by the purchaser. The possibility of the rescission clause now commonly found in contracts for the sale of real estate being exercised in order to avoid compliance with an onerous requisition, is also an important factor in the situation. The requisitions are in due course replied to, and further requisitions may arise out of the answers. A summary method of obtaining a judicial determination of questions connected with the contract, but not affecting its validity, is provided by the Vendor and Purchaser Act 1874. Before completion it is usual for the purchaser to cause searches to be made in various official registers for matters required to be entered therein, such as judgments, land charges, and pending

*Abstract of title.*

*Contracts for sale.*

*Requisitions.*

actions, which may affect the vendor's title to sell, or amount to an incumbrance upon the property.

When the title has been approved, or so soon as it appears reasonably certain that it will be accepted, the draft conveyance is prepared and submitted to the vendor. This is commonly done by and at the expense of the purchaser, who is entitled to determine the form of the conveyance, provided that the vendor is not thereby prejudiced, or put to additional expense. The common mode of conveying a freehold is now, as already mentioned, by ordinary deed, called in this case an *indenture*, from the old practice, where a deed was made between two or more parties, of writing copies upon the same parchment and then dividing it by an indented or toothed line. Indenting is, however, not necessary, and in modern practice is disused. A deed derives its efficacy from its being sealed and delivered. It is still a matter of doubt whether signing is essential. It is not necessary that its execution should be attested except in special circumstances, as, e.g. where made under a power requiring the instrument exercising it to be attested. But in practice conveyances are not only sealed, but also signed, and attested by one or two witnesses. The details of a conveyance in any particular case depend upon the subject-matter and terms of the sale, and the state of the title as appearing by the abstract. The framework, however, of an ordinary purchase-deed consists of (1) the date and parties, (2) the recitals, (3) the testatum or witnessing-part, containing the statement of the consideration for the sale, the words incorporating covenants for title and the operative words, (4) the parcels or description of the property, (5) the habendum, showing the estate or interest to be taken by the purchaser, and (6) any provisos or covenants that may be required. A few words will illustrate the object and effect of these component parts.

(1) The parties are the persons from whom the property, or some estate or interest in or in relation to it, is to pass to the purchaser, or whose concurrence is rendered necessary by the state of the title in order to give the purchaser the full benefit of his contract and to complete it according to law. It is often necessary that other persons besides the actual vendor should join in the conveyance, e.g. a mortgagee who is to be paid off and convey his estate, a trustee of an outstanding legal estate, a person entitled to some charge or restriction who is to release it, or trustees who are to receive the purchase-money where a limited owner is selling under a power (e.g. a tenant for life under the power given by the Settled Land Act 1882). Parties are described by their names, addresses and occupations or titles, each person with a separate interest, or filling a distinct character, being of a separate part. (2) The recitals explain the circumstances of the title, the interests of the parties in relation to the property, and the agreement or object intended to be carried into effect by the conveyance. Where the sale is by an absolute owner there is no need for recitals, and they are frequently dispensed with; but where there are several parties occupying different positions, recitals in chronological order of the instruments and facts giving rise to their connexion with the property are generally necessary in order to make the deed intelligible. (3) It is usual to mention the consideration. Where it consists of money the statement of its payment is followed by an acknowledgment, in a parenthesis, of its receipt, which, in deeds executed since the Conveyancing Act 1881, dispenses with any endorsed or further receipt. A vendor, who is the absolute beneficial owner, now conveys expressly "as beneficial owner," which words, by virtue of the Conveyancing Act 1881, imply covenants by him with the purchaser that he has a right to convey, for quiet enjoyment, freedom from incumbrances, and for further assurance—limited, however, to the acts and defaults of the covenantor and those through whom he derives his title otherwise than by purchase for value. A trustee or an incumbrancer joining in the deed conveys "as trustee" or "as mortgagee," by which words covenants are implied that the covenantor individually has not done or suffered anything to incumber the property, or prevent him from conveying as

expressed. As to the operative words, any expression showing an intention to pass the estate is effectual. Since the Conveyancing Act 1881, "convey" has become as common as "grant," which was formerly used. (4) The property may be described either in the body of the deed or in a schedule, or compendiously in the one and in detail in the other. In any case it is usual to annex a plan. Different kinds of property have their appropriate technical words of description. *Hereditaments* is the most comprehensive term, and is generally used either alone or in conjunction with other words more specifically descriptive of the property conveyed. (5) The habendum begins with the words "to hold," and the estate, on a sale in fee-simple, is limited, as already mentioned, not only to, but also to the use of, the purchaser. Before the Conveyancing Act 1881, it was necessary to add, after the name of the purchaser, the words "and his heirs," or "his heir and assigns," though the word "assigns" never had any conveying force. But since that Act it is sufficient to add "in fee-simple" without using the word "heirs." Unless, however, one or other of these additions is made, the purchaser will even now get only an estate for his life. If the property is to be held subject to a lease or incumbrance, or is released by the deed from an incumbrance previously existing, this is expressed after the words of limitation. (6) Where any special covenants or provisions have been stipulated for, or are required in the circumstances of the title, they are, as a rule, inserted at the end of the conveyance. In simple cases none are needed. Where, however, a vendor retains documents of title, which he is entitled to do where he sells a part only of the estate to which they relate, it is the practice for him by the conveyance to acknowledge the right of the purchaser to production and delivery of copies of such of them as are not instruments of record like wills or orders of court, and to undertake for their safe custody. This acknowledgment and undertaking supply the place of the lengthy covenants to the like effect which were usual before the Conveyancing Act 1881. A trustee or mortgagee joining gives an acknowledgment as to documents retained by him, but not an undertaking. The foregoing outline of a conveyance will be illustrated by the following specimen of a simple purchase-deed of part of an estate belonging to an absolute owner in fee:—

THIS INDENTURE made the \_\_\_\_\_ day of \_\_\_\_\_ between A. B. of, &c., of the one part and C. D. of, &c., of the other part WHEREAS the said A. B. is seised (among other hereditaments) of the messuage hereinafter described and hereby conveyed for an estate in fee simple in possession free from incumbrances and has agreed to sell the same to the said C. D. for £100 NOW THIS INDENTURE WITNESSETH that in pursuance of the said agreement and in consideration of the sum of £100 paid to the said A. B. by the said C. D. (the receipt whereof the said A. B. doth hereby acknowledge) the said A. B. as beneficial owner doth hereby convey unto the said C. D. ALL THAT messuage or tenement situate &c., and known as, &c. TO HOLD the premises unto and to the use of the said C. D. his heirs and assigns [or in fee simple] And the said A. B. doth hereby acknowledge the right of the said C. D. to production and delivery of copies of the following documents of title [mentioning them] and doth undertake for the safe custody thereof IN WITNESS, &c.

It will be observed that throughout the deed there are no stops, the commencement of the several parts being indicated by capital letters. The draft conveyance having been approved on behalf of the vendor, it is engrossed upon stout paper or parchment, and there remains only the completion of the sale, which usually takes place at the office of the vendor's solicitor. A purchaser is not entitled to require the vendor to attend personally and execute the conveyance in his presence or that of his solicitor. The practice is for the deed to be previously executed by the vendor and delivered to his solicitor, and for the solicitor to receive the purchase-money on his client's behalf, since a purchaser is, under the Conveyancing Act 1881, safe in paying the purchase-money to a solicitor producing a deed so executed, when it contains the usual acknowledgment by the vendor of the receipt of the money. Upon the completion, the documents of title are handed over except in the case above referred to, and any claims between the parties in respect of interest upon the purchase-money, apportioned outgoings, or otherwise, are



settled. The conveyance is, of course, delivered to the purchaser, upon whom rests the obligation of affixing the proper stamp— which he may do without penalty within thirty days after execution (Stamp Act 1891). It may be added that, subject to any special bargain, which is rarely made, the costs of the execution by the vendor and other parties whose concurrence is necessary, and of any act required to be done by the vendor to carry out his contract, are borne by the vendor.

Ordinary leases at rack-rents are not generally preceded by a formal agreement, such as is common on a sale of land, or by an investigation into the lessor's title. As a rule, the principal terms are arranged between the parties, and embodied with various ancillary provisions in a draft lease, which is prepared by the lessor's advisers and submitted to the lessee, the ultimate form and contents of the instrument being adjusted by negotiation. If an intending lessee desires to examine the title he must make an express bargain to that effect, for under a contract to grant a lease the intended lessee is not entitled, in the absence of such express stipulation, to call for the title to the freehold (Vendor and Purchaser Act 1874). By the Statute of Frauds all leases, except leases for a term not exceeding three years, and at not less than two-thirds of the rack-rent, were required to be in writing. And now by the Real Property Act 1845, leases required by law to be in writing are void *at law* unless made by deed. An instrument, void as a lease under the act, may, however, be valid as an agreement to take a lease; and since the Judicature Act 1873, under which equitable doctrines prevail in the High Court, a person holding under an agreement for a lease, of which specific performance would be granted, is treated in all branches of that court as if such a lease were already executed. Unless otherwise agreed, a lease is always prepared by a lessor's solicitor at the expense of the lessee; but the cost of the counterpart (*i.e.* the duplicate executed by the lessee) is usually borne by the lessor.

Upon the sale and conveyance of a leasehold property substantially the same procedure is observed as above indicated in the case of a freehold. A few additional points, however, may be specially mentioned. Under an open contract the vendor cannot be called upon to show the title to the freehold reversion (Vendor and Purchaser Act 1874; Conveyancing Act 1881). Accordingly, the abstract of title begins with the lease, however old; but the subsequent title need not be carried back for more than forty years before the sale. The purchaser, apart from stipulation, must assume, unless the contrary appears, that the lease was duly granted, and upon production of the receipt for the last payment due for rent before completion, that all the covenants and provisions of the lease have been duly performed and observed up to the date of actual completion. The appropriate word of conveyance is "assign," and a conveyance of leaseholds is generally called an assignment. The vendor's covenants for title implied by his assigning "as beneficial owner" include, in addition to the covenants implied by those words in a conveyance of freehold, a covenant limited in manner above mentioned, that the lease is valid, and that the rent and the provisions of the lease have been paid and observed up to the time of conveyance (Conveyancing Act 1881). Where the vendor, as is the common case, remains liable after the assignment for the rent and the performance of the covenants, the purchaser must covenant to pay the rent, and perform and observe the covenants and provisions of the lease, and keep the vendor indemnified in those respects.

A mortgage is prepared by the solicitor of the mortgagee, and the mortgagor bears the whole expenses of the transaction. It is seldom that there is any preliminary agreement, because (1) a contract to lend money is not specifically enforceable; and (2) inasmuch as the primary object of a mortgagee is to have his money well secured, he is not, generally, willing to submit to restrictions as to title or evidence of title which might give rise to difficulty or expense in the event of a sale of the mortgaged property. An intending mortgagor is accordingly required to show a title easily marketable, and to verify it at his own cost. A mortgage follows the same general

form as a conveyance on sale, the principal points of difference being that the conveyance of the property is preceded by a covenant for the payment of the mortgage money and interest, and followed by a proviso for reconveyance upon such payment, and by any special provisions necessary or proper in the circumstances, such as a covenant for insurance and repairs where the security comprises buildings. The covenants for title implied by a mortgagor conveying "as beneficial owner" are the same as in the case of a vendor, but they are absolute and not qualified in the manner above pointed out.

The beneficial operation of the Conveyancing Act 1881 in shortening conveyances is well illustrated by a modern mortgage. For, by virtue of the act, a mortgagee by deed executed after its commencement has, subject to any contrary provisions contained in the deed, the following powers to the like extent as if they had been conferred in terms: (1) a power of sale exercisable after the mortgage money has become due (a) if notice requiring payment has been served and not complied with for three months, (b) if any interest is in arrear for two months, or (c) there has been a breach of some obligation under the deed or the act other than the covenant for payment of the mortgage money or interest; (2) a power to insure subject to certain restrictions; (3) a power, when entitled to sell, to appoint a receiver; and (4) a power while in possession to cut and sell timber. The act contains ancillary provisions enabling a mortgagee upon a sale to convey the property for such estate or interest as is the subject of the mortgage, and to give a valid receipt for the purchase-money, and the purchaser is amply protected against any irregularities of which he had no notice. There are also large powers of leasing conferred by the act upon mortgagor and mortgagee while respectively in possession, and a power for the mortgagor, whilst entitled to redeem, to inspect and take copies of title-deeds in the mortgagee's possession. The elaborate provisions for all these purposes which were formerly inserted in mortgage deeds are now omitted; but sometimes the operation of the act is modified in certain respects. The procedure upon a sale by a mortgagee is the same as in the case of any other vendor. He conveys, however, "as mortgagee," these words implying only a covenant by him against incumbrances arising from his own acts.

The frame of a strict settlement of real estate, which is usually made either on marriage or by way of resettlement on a tenant in tail under an existing settlement attaining twenty-one, has been much simplified; but such settlements still remain the most technical and most complicated of legal instruments. By virtue of the Settled Land Acts 1882 to 1890, tenants for life and many other limited owners have extensive powers of sale, of leasing, and of doing numerous other acts required in a due course of management. These powers cannot be excluded or fettered by settlors. They are, as a rule, considered in practice to be sufficient, and the corresponding elaborate provisions formerly inserted in settlements are now omitted, the operation of the acts being merely supplemented, where desirable, by some extension of the statutory powers, in relation, *e.g.*, to the investment and application of capital money. To complete the statutory machinery it is desirable that persons should be nominated by the settlement trustees for the purposes of the acts. Since the Conveyancing Act 1881, provisions for the protection of jointresses or persons entitled under settlements to rent charges or annual sums issuing out of the land are no longer required, as all such persons have now powers of distress and entry, and of limiting terms to secure their respective interests. Terms for raising portions must still, however, be expressly created. The Conveyancing Act 1881 also confers large powers of management during the minorities of infants beneficially entitled upon persons either appointed for the purpose by the instrument or being such trustees such as are mentioned in § 42. An estate in tail may now be limited by the use of the words "in tail" without the words "heirs of the body" formerly necessary. And a settlor generally conveys "as settlor," by which only a covenant for further assurance is implied under the Conveyancing Act 1881. Personal settlements are most often made upon marriage. The settled property is vested in trustees, either by the settlement itself, or in the case of cash, mortgage debts, stocks or shares, by previous delivery or transfer, upon trusts declared by the instrument.

The normal trusts after the marriage are (1) for investment; (2) for payment of the income of the husband's property to him for life, and of the wife's property to her for life for her separate use without power of anticipation whilst under coverture; (3) for

Settlements.

Assignment of leaseholds.

Mortgages.

payment to the survivor for his or her life of the income of both properties; (4) after the death of the survivor, both as to capital and income, for the issue of the marriage as the husband and wife shall jointly by deed appoint, and in default of joint appointment as the survivor shall by deed or will appoint, and in default of such appointment for the children of the marriage who attain twenty-one, or being daughters marry, in equal shares, with the addition of a clause (called the hotchpot clause) precluding a child who or whose issue takes a part of the fund by appointment from sharing in the unappointed part without bringing the appointed share into account. Then follows a power for the trustees with the consent of the parents whilst respectively living to raise a part (usually a half) of the share of a child and apply it for his or her advancement or benefit. Power to apply income, after the death of the life tenants, for the maintenance and education of infants entitled in expectancy, is conferred upon trustees by the Conveyancing Act 1881. The ultimate trusts in the event of there being no children who attain vested interests are (1) of the husband's property for him absolutely; and (2) of the wife's property for such persons as she shall when discover by deed, or whether covert or discover by will, appoint, and in default of appointment, for her absolutely if she survive the husband, but if not, then for her next of kin under the Statute of Distributions, excluding the husband. For all ordinary purposes the trustees have now under various statutes sufficient powers and indemnities. They may, however, in some cases need special protection against liability. A power of appointing new trustees is supplied by the Trustee Act 1893. It is usually made exercisable by the husband and wife during their joint lives, and by the survivor during his or her life.

The form and contents of wills are extremely diverse. A will of, perhaps, the commonest type (a) appoints executors and trustees; (b) makes a specific disposition of a freehold or leasehold residence; (c) gives a few legacies or annuities; and (d) devises and bequeaths to the executors and trustees the residue of the real and personal estate upon trust to sell and convert, to invest the proceeds (after payment of debts and funeral and testamentary expenses) in a specified manner, to pay the income of the investments to the testator's widow for life or until another marriage, and subject to her interest, to hold the capital and income in trust for his children who attain twenty-one, or being daughters marry, in equal shares, with a power of advancement. Daughters' snares are frequently settled by testators upon them and their issue on the same lines and with the same statutory incidents as above mentioned in the observations upon settlements; and sometimes a will contains in like manner a strict settlement of real estate. It is a point often overlooked by testators desirous of benefiting remote descendants that future interests in property must, under what is known as the rule against perpetuities, be restricted within a life or lives in being and twenty-one years afterwards. In disposing of real estate "devise" is the appropriate word of conveyance, and of personal estate "bequeath." But neither word is at all necessary. "I leave all I have to A. B. and appoint him my executor" would make an effectual will for a testator who wished to give all his property, whether real or personal, after payment of his debts, to a single person. By virtue of the Land Transfer Act 1897, Part I., real estate of an owner dying after 1897 now vests for administrative purposes in his executors or administrators, notwithstanding any testamentary disposition.

It remains to mention that by the Land Transfer Act 1897 a system of compulsory registration of title, limited to the county of London, was established. (See LAND REGISTRATION.)

*Conveyancing counsel to the court* (i.e. to the chancery division of the High Court) are certain counsel, in actual practice as conveyancers, of not less than ten years' standing, who are appointed by the lord chancellor, to the number of six, under s. 40 of the Master in Chancery Abolition Act 1852. They are appointed for the purpose of assisting the court in the investigation of the title to any estate, and upon their opinion the court or any judge thereof may act. Any party who objects to the opinion given by any conveyancing counsel may have the point in dispute disposed of by the judge at chambers or in court. Business to be referred to conveyancing counsel is distributed among them in rotation, and their fees are regulated by the taxing officers.

*United States.*—American legislation favours the general policy of registering all documents in the contents of which the public have an interest, and its tendency has been steadily towards more and more full registration both of documents and statistics. From the early days of the colonial era it has been

customary to record wills and conveyances of real estate in full in public books, suitably indexed, to which free access was given. During the last decade of the 19th century, three states—Illinois, Massachusetts, and Ohio—adopted the main features of the Torrens or Prussian system for registering title to land rather than conveyances under which title may be claimed. These are the ascertainment by public officers of the state of the title to some or all of the parcels of real estate which are the subject of individual property within the state; the description of each parcel (giving its proper boundaries and characteristics) on a separate page of a public register, and of the manner in which the title is vested; the issue of a certificate to the owner that he is the owner; the official notation on this register of each change of title thereafter; and a warranty by the government of the title to which it may have certified. To make the system complete it is further requisite that every landowner should be compelled to make use of it, and that it should be impossible to transfer a title effectually without the issue of such a government certificate in favour of the purchaser.

Constitutional provisions have been found to prevent or embarrass legislation in these directions in some of the states, but it is believed that they are nowhere such as cannot be obeyed without any serious encroachment on the principles of the new system (*People v. Chase*, 165 Illinois Reports, 527; *State v. Gilbert*, 56 Ohio State Reports, 575; *People v. Simon*, 176 Illinois Reports, 165; *Tyler v. Judges*, 173 Massachusetts Reports; 55 North-Eastern Reporter, 812; *Hamilton v. Brown*, 161 United States Reports, 256).

Conveyances which have been duly recorded become of comparatively little importance in the United States. The party claiming immediately under them, if forced to sue to vindicate his title, must produce them or account for their loss; but any one deriving title from him can procure a certified copy of the original conveyance from the recording officer and rely on that. Equitable mortgages by a deposit of title-deeds are unknown.

The general prevalence of public registry systems has had an influence in the development of American jurisprudence in the direction of supporting provisions in wills and conveyances, which, unless generally known, might tend to mislead and deceive, such as spendthrift trusts (*Nichols v. Eaton*, 91 United States Reports, 716).

Conveyances of real estate are simple in form, and are often prepared by those who have had no professional training for the purpose. Printed blanks, sold at the law-stationers, are commonly employed. The lawyers in each state have devised forms for such blanks, sometimes peculiar in some points to the particular state, and sometimes copied verbatim from those in use elsewhere. Deeds intended to convey an absolute estate are generally either of the form known as *warranty deed* or of that known as *release deed*. The release deed is often used as a primary conveyance without warranty to one who has no prior interest in the land. Uniformity in deeds is rendered particularly desirable from the general prevalence of the system of recording all conveyances at length in a public office. Record books are printed for this purpose, containing printed pages corresponding to the printed blanks in use in the particular state, and the recording officer simply has to fill up each page as the deed of similar form was filled up. One set of books may thus be kept for recording warranty deeds, another for recording release deeds, another for recording mortgage deeds, another for leases, &c.

*AUTHORITIES.*—Davidson, *Precedents and Forms in Conveyancing* (London, 1877 and 1885); Key and Elphinstone, *Compendium of Precedents in Conveyancing* (London, 1904); Elphinstone, *Introduction to Conveyancing* (London, 1900); Prideaux, *Precedents in Conveyancing* (1904); Pollock, *The Land Laws* (London, 1896).

(S. WA.; S. E. B.)

**CONVEYORS.** "Conveyor" (for derivation see CONVEYANCE) is a term generally applied to mechanical devices designed for the purpose of moving material in a horizontal or slightly inclined direction; in this article, however, are included a variety of appliances for moving materials in horizontal, vertical and combined horizontal and vertical directions. The material so handled may be conveyed in a practically uninterrupted stream.

as in the case of worms, bands and pushplate conveyors, or elevators carrying grain or coal, &c.; or it may be conveyed from one point to another, intermittently, that is to say in a succession of separate loads, as happens with single bucket elevators, furnace hoists, rope and chain haulage, and also in the case of ropeways and aerial cableways. Some of these devices are of great antiquity, others are of quite modern origin. The principles of their construction are simple and easy of understanding, but by variations in the details of their construction the engineer has adapted these few appliances to the most varied work. At one end of the scale they may be used for such light duties as conveying the goods purchased by a customer to the packers and bringing them back made up into a parcel or for taking his money to the cashier and returning the change. At the other they are adopted for handling large quantities of heavy material at a minimum expenditure of human labour. Coal, for instance, a more or less friable substance, the value of which is seriously diminished by fracture, may be mechanically handled with a minimum risk of breakage. The difficult problem of handling the contents of gas retorts and coke ovens, and of simultaneously quenching and conveying the glowing material, has been solved. Perhaps an even more astonishing piece of work is the manipulation of the iron from the blast furnace; for instance, liquid metal is drawn from a furnace into pouring pots which in their turn discharge it to and distribute it over a pig-iron casting machine, which is practically a conveyor for liquid metal, consisting of a strand of moving moulds from which the solidified pigs, after cooling in water, are automatically removed after reaching the loading terminal over the railway trucks. Certain types of conveyors may be made to combine efficiently, with their primary work of transport, complex sorting, sifting, drying and weighing operations.

**Worm Conveyors.**—The worm conveyor, also known as the Archimedean screw, is doubtless the most ancient form of conveyor. It consists of a continuous or broken blade screw set on a spindle. This spindle is made to revolve in a suitable trough, and as it revolves any material put in is propelled by the screw from one end of the trough to the other. Such conveyors have been used in flour-mills for centuries. The writer has seen in an East Anglian mill which was over 250 years old disused screw conveyors, probably as old as the mill, consisting of spindles of octagonal shape, made of not too hard wood, around which a broken blade screw was formed by the insertion at regular intervals of small blades of hard wood (fig. 1). Modern worm conveyors usually consist of a spindle formed of a length of

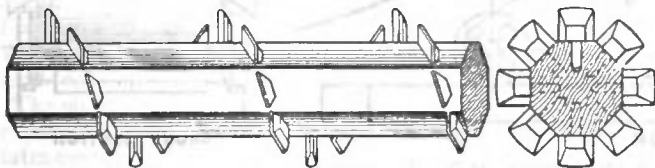

FIG. 1.—Early Flour Mill Conveyor.<sup>1</sup>

wrought iron piping, to which is fitted either a broken or continuous worm. In the former case (fig. 2) the worm is composed of a series of blades or paddles arranged like a spiral round the

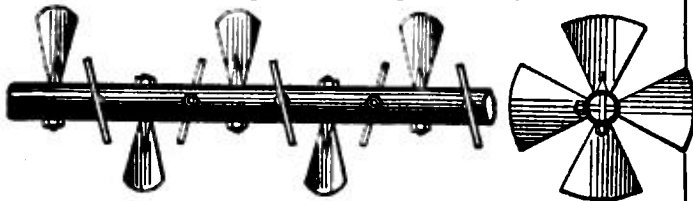

FIG. 2.—Paddle Worm Conveyor.

spindle; each blade is fixed, by means of its shank, in a transverse hole in the spindle, and the shank is held in position by being tapped and fitted with a nut. In this way is formed, out of separate blades, a practically complete screw, technically known

<sup>1</sup> The illustrations in this article are taken, by kind permission, from the *Proceedings of the Institution of Civil Engineers*.

as a "paddle worm." The lengths or sections of the worm run to about 8 ft., the various lengths being coupled by turned gudgeons, which also serve as journals for the bearings. In the so-called continuous worm conveyors the screw is formed of a continuous sheet-iron spiral (fig. 3). Sometimes a narrow groove

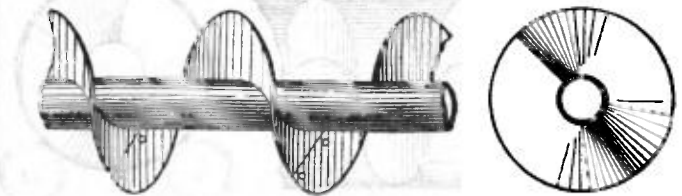

FIG. 3.—Continuous Worm Conveyor.

is cut in spiral form on the spindle, and in this groove the sheet-iron spiral is secured.

The *spiral or anti-friction conveyor* (fig. 4) was introduced about 1887. In this case a narrow spiral, which passes concentrically round the spindle, with a space between both, is fixed to it at set intervals by small blades, each of which is itself fixed by its shank and a nut to the spindle. The spiral may be made of

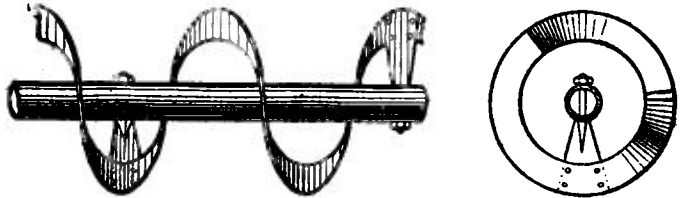

FIG. 4.—Spiral or Anti-Friction Conveyor.

almost any section, from a round bar about  $\frac{1}{2}$  in. in diameter to L or T section, but is preferably a flat bar. Worms are fitted into wooden or iron troughs leaving a clearance of  $\frac{1}{8}$  to  $\frac{1}{4}$  in. The spindle must be supported at suitable intervals by bearings, preferably of the bush type. A continuous worm, being more rigid than a paddle worm, needs fewer supports. The lid of the worm trough should be loose, not screwed on, because in case of an accumulation of feed through a choke in a delivery spout the paddles of a paddle worm would be broken, or a continuous worm stripped, unless the material could throw off the lid and relieve the worm. The ratios of the pitch of the worm to the diameter must be regulated by the nature of the material to be conveyed, and will vary from one-third to a pitch equal to, or even exceeding, the diameter. The greater the pitch the larger the capacity, but also the greater the driving power required, at the same speed. For handling materials of greater specific gravity, such as cement, &c., it is advisable to use a smaller pitch than for substances of lower specific gravity, such as grain. The capacity of a continuous worm exceeds that of either a paddle or spiral conveyor of the same diameter, pitch and speed. As regards the relative efficiency of paddle and spiral conveyors a series of careful tests made by the writer indicated that, run at a slow speed the paddle worm, but at a high speed the spiral worm, has the greater efficiency. There is of course a speed at which the efficiency of both types is about equal, and that is at 150 revolutions per minute for conveyors 4 to 6 in. in diameter.

The power necessary to drive worm conveyors under normal conditions is very considerable; a continuous worm of 18 to 20 in. diameter running at 60 revolutions per minute will convey 50 tons of grain per hour over a distance of a hundred feet at an expenditure of 18 $\frac{1}{2}$  to 19 H.P. A material like cement would require rather more power because of the greater friction of the cement against the blades and the trough. Delivery from a worm conveyor can be effected at any desired point, all that is necessary being to cut an outlet, which should preferably be as wide as the diameter of the worm, because the worm delivers only on its leading side, and is practically empty on the other side, so that a smaller outlet might only give exit to a portion of the feed, unless it was on the leading side.

A special form of worm conveyor is the *tubular* (fig. 5), which consists of an iron tube with a continuous spiral fitted to its inner

periphery, or of iron or wooden tubes of square sections fitted with fixed baffle plates inside. In working it revolves bodily on suitable rollers. This type is more costly than the ordinary worm conveyors, and also requires more power. Its efficiency is,

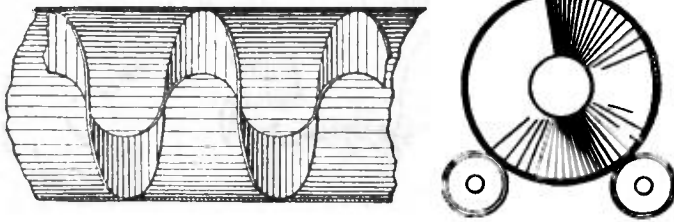

FIG. 5.—Tubular Worm Conveyor.

moreover, easily impaired if run at too high a speed, because the centrifugal force asserts itself and counteracts the propulsion, which in this case is effected by gravity. Some experiments made in 1868 by George Fosbery Lyster, engineer of the Liverpool docks, gave convincing results (see *Proc. Inst. Mech. Eng.*, August 1869). The tubular worm conveyor is suitable where a granular material has to be moved over a comparatively short distance, say from one building to another on the same level, and where no bridge is available for the installation of any other kind of conveyor. Conveyors of this type have, however, come into use for conveying hard and cutting substances over considerable lengths. Ordinary worm conveyors are practically debarred from use for such substances on account of the short life of the intermediate bearings, which are not necessary with externally supported tubular worms.

To sum up, worm conveyors are of the simplest construction and of small prime cost. The terminals again are much less expensive than those of most other kinds of conveyors. When the distance to be traversed by the material is short, the worm conveyor has this advantage, that it is cheaper than other kinds of conveyors. If it be desired not only to convey but also to mix two or more materials, such as cement and sand in a dry state, or poultry food, this appliance is thoroughly well adapted for the work. On the other hand, there is a grinding action exercised on any material conveyed, and when hard or cutting substances are handled the wear and tear on the conveyor blades, trough and bearings is very great, and the power absorbed by a worm conveyor is a sensible item.

**Band Conveyors.**—The inventor of band conveyors for the handling of grain and minerals was G. F. Lyster, who, as already mentioned, in 1868 carried out exhaustive experiments at the Liverpool docks, where he established the band conveyor as a grain-handler. For granaries the band conveyor is an ideal appliance. Its capacity is great, and it can be run at relatively high speeds with a moderate expenditure of power. The band conveyor of to-day is an endless belt of canvas or more often india-rubber with insertion, and when fitted with the usual receiving and delivery appliances can be used to handle grain from or into granaries and also to feed bins or sections of a warehouse. The endless bands run over terminal pulleys, and are also supported on their way by a series of guide rollers, which are in greater number on the loaded than on the empty strand. The band is usually run quite flat, except that at the point or points where the grain is fed on it is slightly hollowed for a few feet, by means of two curving rolls which are set obliquely so

to make it trough-shaped. The supporting or guide rollers are 4 in. to 6 in. in diameter, and are sometimes made of wood, but more often consist of steel tubes to which spindles with conical end gudgeons are secured. The gudgeons generally run in suitable bush-bearings, which should be well lubricated. Band conveyors should be driven on the delivery and not the receiving terminal, as the tight side of the band is the flattest. The guide rollers, for ordinary grain conveyors, are fitted to the upper or working side of the band at intervals of about 6 ft., and at distances of 12 ft. on the lower or return strand. In cases where both strands of the band are used for carrying grain, the lower strand must be supported by as many rollers as the upper. Under such conditions, terminal pulleys must be of larger diameter than usual, the object being to throw the two strands farther apart, so as to give sufficient space between the two strands to spout the feed in and out again at the other end. The two strands can be run any distance apart by the use of two additional pulleys for the terminals. This arrangement would be in place where it was desired, as it might be, to run one strand of the band along the top floor of the granary to distribute, while the other strand travelled along the ground-floor or basement to withdraw, the grain.

Band conveyors are kept tight, when the band is not very long, by a tightening gear, similar to that used on elevators, and consisting of two screws which push or better pull the two pedestals of one terminal pulley farther away from the other terminal. If the band is of such length that an adjustment of 4 to 5 ft. on the tightening gear is not sufficient, it is advisable to use in place of screws a tightening pulley, over which the belt passes, but which is itself held in tension by weights. The choice of the exact tightening gear will depend on various considerations, the length of the belt, the type of throw-off carriage used, and the quality of the belt all being factors to be considered. The throw-off carriage (fig. 6), which serves to withdraw material from the band at any desired point, is a simple but ingenious appliance consisting essentially of guide pulleys which by raising one part of the band and lowering the other have the effect of causing the grain to quit the surface of the band at the point where it is deflected upwards. The grain is thus cast

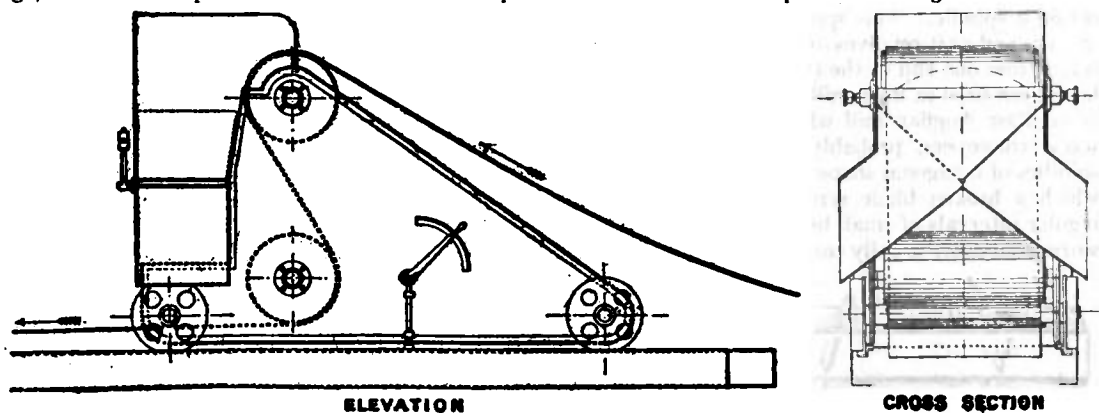

FIG. 6.—Throw-off Carriage for Band Conveyor.

clear of the band, and into the air, being caught as it falls in a hopper and spouted in any desired direction. Throw-off carriages differ in certain details, but the principle is the same. For feeding a band conveyor it is important to give the material a horizontal velocity, approaching that of the band. The grain should therefore be fed through a spout rather less in breadth than half of the width of the band, and set at an incline of  $42\frac{1}{2}^\circ$  to the horizontal. Band conveyors run at a speed of 400 to 600 ft. per minute, according to the nature of the material; oats, for instance, would be liable to be blown off the band at a speed in excess of 500, which would be suitable for wheat. Nuts, maize and the heavier seeds could be carried at 600. The power consumption by a grain-laden band compares favourably with any other form of conveyor. An 18-in. band 100 ft. in length running 500 ft. per minute would carry 50 tons per hour at an expenditure of only 4.5 H.P.

While the band conveyor is an ideal conveyor in warehouses and mills, it is also capable of rendering good service in handling such heavy materials as coal and minerals. Of course for such purposes the band and its fittings must be of much more substantial construction. The central portions of the band carrying the load, being subjected to great wear and tear, are often made

of solid india-rubber extending to nearly half the thickness of the band in the middle, and tapering off towards the edges, while the surface facing the guide rollers is of insertion coated with india-rubber. Bands properly prepared and stretched will bear a strain of 3 tons to the square inch. Balata bands may be used in place of india-rubber, but though less expensive are not so lasting. Bands that have to carry coal or minerals are usually

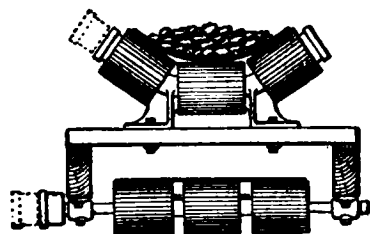

FIG. 7.

curved along the entire length of the upper or loaded strand into a trough shape by guide rollers (fig. 7). Bands of woven wire are sometimes used with coal-washing plants, but have the disadvantage of lack of durability. They are more liable to stretch and are high in price. They may be run as high as about 600 ft. per minute, but to ensure proper grip-driving terminals must either be faced with leather or made of wood.

The speed of band conveyors loaded with coal or minerals greatly depends on the size of the fragments; the proper speed for large pieces would be 150-200 ft. per minute, while smaller material could be carried at a maximum velocity of 700-750 ft. Band conveyors will carry in an upward direction, up to 24 degrees, without any loss of capacity. They can be used not only to carry light and heavy bodies, such as grain and coal, in a continuous stream, but also to convey relatively large bodies such as sacks of flour, or cement, &c., intermittently. Thus a band 26 in. wide and 350 ft. long is used at a flour-mill in York to load sacks of flour into railway trucks; by this means 12 wagons can be loaded by two men in 1 hour. Band conveyors are not necessarily fixed in one place. A portable model has rendered good service in tunnel-cutting, mining and quarrying. This band is mounted in a light steel frame, itself fitted with small wheels, so as to be readily put in any required position, and is entirely self-contained, being provided with tightening gear, a small motor, &c. If required, several lengths can be joined together, or one band can deliver upon another at a lower level. The same advantages that attend the use of the band-conveyor for handling grain may be claimed for this appliance when carrying coal and heavy bodies, namely the demand for relatively small power, smooth and noiseless work, and gentle handling of material. On the other hand the feed cannot be withdrawn at intermediate points except by means of a throw-off carriage. The numerous bearings of the guide rollers require careful lubrication, and the rubber bands should be protected as much as possible from changes of temperature.

The *metal band* or belt conveyor, a modification of the rubber or canvas band conveyors, is an endless belt composed of iron plates connected to endless chains, usually of malleable cast iron, running under the plates. Such appliances, being obviously more cumbersome than band conveyors, are only used in handling material of a hard and cutting nature. They usually deliver only at the end, but if intermediate delivery be desired a scraper may be so fixed across the band at a given point, at an angle of 45°, as to scrape the whole or part of the feed into a shoot, or a scraper may be mounted obliquely on a suitable carriage which can be moved to any points at which delivery may be required. In some bands of this type supporting rollers are attached to the links and travel with them, or are fixed to the framing so that the band runs over them, an arrangement which has the advantage of economizing driving power and of promoting smooth running. Metal band conveyors are tightened in the same way as textile or rubber bands, and may run at a speed of 60 to 120 ft. per minute. The driving gear must always be placed at the delivery terminal, so that the loaded strand is in tension. Such appliances are often used as sorting tables or picking bands, for instance, for coal, cement, minerals, &c.

In another modification of the metal band conveyor, the *travelling trough* conveyor, the sides of each plate are turned up

so as to form the conveying surface of the band into a continuous trough. With this arrangement intermediate delivery is impossible, as the sides of the trough will not allow the use of a scraper. As compared with push-plate conveyors (which consist of scrapers mounted on endless travelling chains that run usually in troughs), travelling trough conveyors are gentle handlers of material.

A conveyor which is capable of dealing with many different kinds of material is known as the *vibrating trough* conveyor. It is so far like the band and travelling trough conveyor that the material it conveys from one point to another is conveyed without the use of any stirring or pushing agent, such as belong to worm, push-plate and cable trough conveyors. For materials requiring gentle treatment, this type of conveyor is eminently suitable. There are different kinds of vibrating trough conveyors. In one type the trough is caused to make a reciprocating motion by means of a crank and connecting rod, the trough itself being supported on rollers. In another type the trough is actuated by a cam, or by cranks with some kind of quick return motion. In the appliance known as the Zimmer or swinging conveyor the trough is supported in its reciprocating motion by means of laminated spring legs set obliquely to the trough. These legs are securely bolted at one end to the floor or any other solid support, and at the other end to the trough itself; hence no lubrication is required, as would be the case with supporting rollers. Moreover the combined action of the reciprocating motion of the crank and the rocking of the spring legs has the effect of causing the material to travel faster in the trough with a given stroke of the crank than would be the case with any other support. The material to be conveyed is not carried along with its support as in the case of a band or travelling trough conveyor, but is caused to move in a series of hops, to use popular language.

The action will be sufficiently explained by the appended diagram (fig. 8), which, however, is exaggerated to give a clearer idea of the actual movements, which are on quite a small scale. The line AB represents the bottom of the trough, while CC are two of the spring legs; the full lines indicate the spring legs at the extreme backward position of the crank, while the dotted lines show the spring legs

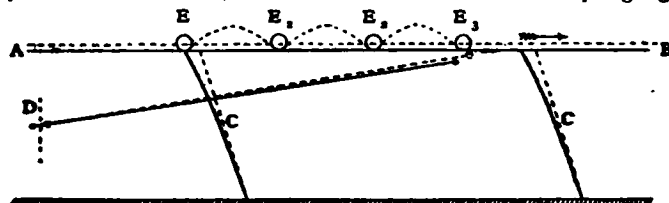

FIG. 8.—Swinging or Zimmer Conveyor.

and bottom of the trough at the extreme forward position of the crank D. The material to be conveyed, represented by E, is thrown forward by the forward movement of the crank, and describes a short parabolic curve; it is thrown at about a right angle to the inclined legs CC, but before it has time to complete its parabolic course, the trough has been moved by the crank into its original position. As soon as the material has dropped down, the trough makes another forward movement, whereupon the material is thrown forward another stage, and this process, which is continually repeated, as indicated by the letters E<sub>1</sub>, E<sub>2</sub>, E<sub>3</sub>, has the effect of carrying or conveying the material in the direction desired. It is important to note that the actual movement both of trough and material is within narrow bounds; the horizontal movement of the trough is only about 1 in., while the vertical or upward movement is about 1/4 in. The material is conveyed by this vibrating trough with a minimum of friction, as it is evident that the material is carried forward without any contact with the trough, while the very nature of the motion precludes injurious friction between the particles themselves. When the trough is full the material will move as it were in a solid mass.

An important improvement in this type of vibrating trough conveyor is the balanced conveyor, in which the trough is made in two sections, one being placed at a slightly lower level than the other, so that one-half may deliver into the other half. The two sections are driven by triple or quadruple cranks set at an angle of about 180° to one another. In this case one-half of the conveyor will move forward while the other moves backward, thus balancing each other (fig. 9). At the same time the material keeps moving in the same direction because all the spring legs are of the same inclination. It is usual to drive balanced conveyors at or near the centre of their length, but they may also be driven from one end;



in which case the balancing of the conveyor would be effected by a powerful volute spring which is compressed and released by a crank and connecting rod, in place of being connected to one-half of the conveyor. Two sections of a Zimmer conveyor can be made to run in opposite directions by merely reversing the inclination of the spring legs; in such a case the sections of a trough would be connected by a flexible coupling. Conveyors of this type have been used in lengths up to 500 ft., and in widths of over 6 ft. The feed can be received or discharged at any desired point in the length; for drawing off material at intermediate points it is only necessary to open a slide in the bottom of the trough. If a great increase be desired in the capacity of this conveyor the connecting rod may be attached, not to the trough at all, but to the spring legs at a point of about a third or half-way from the base, so that the free ends of the legs can swing the trough backward and forward; by this means the stroke is amplified and consequently the capacity is increased, while the driving power required is practically the same.

The power absorbed by the Zimmer conveyor is comparatively small; a length of 100 ft. conveying a load of 50 tons per hour takes 8.75 h.p. With a speed of 300-370 revolutions per minute of the

chain of buckets. But these buckets, unlike elevator buckets, which are bolted on to a band or chain, are free to move on the axis on which they are suspended above their centre of gravity. When the conveyor is at work the buckets will always be in an upright position, whether the motion be vertical or horizontal. Each bucket carries its load to the point at which delivery is required, where an adjustable tipping device is ready to catch and tilt the bucket, thus emptying it. This type of conveyor is chiefly used in connexion with coal stores and boiler houses, where it has undeniable advantages. For instance, in feeding overhead bunkers a well-designed gravity bucket conveyor may do the work of (1) a horizontal conveyor in bringing coal from the railway siding, (2) a vertical elevator in raising it to the bunkers, and (3) a horizontal conveyor in distributing it to the respective bunkers. In some cases the returning empty strand of buckets is used to clear the ashes from under the boilers.

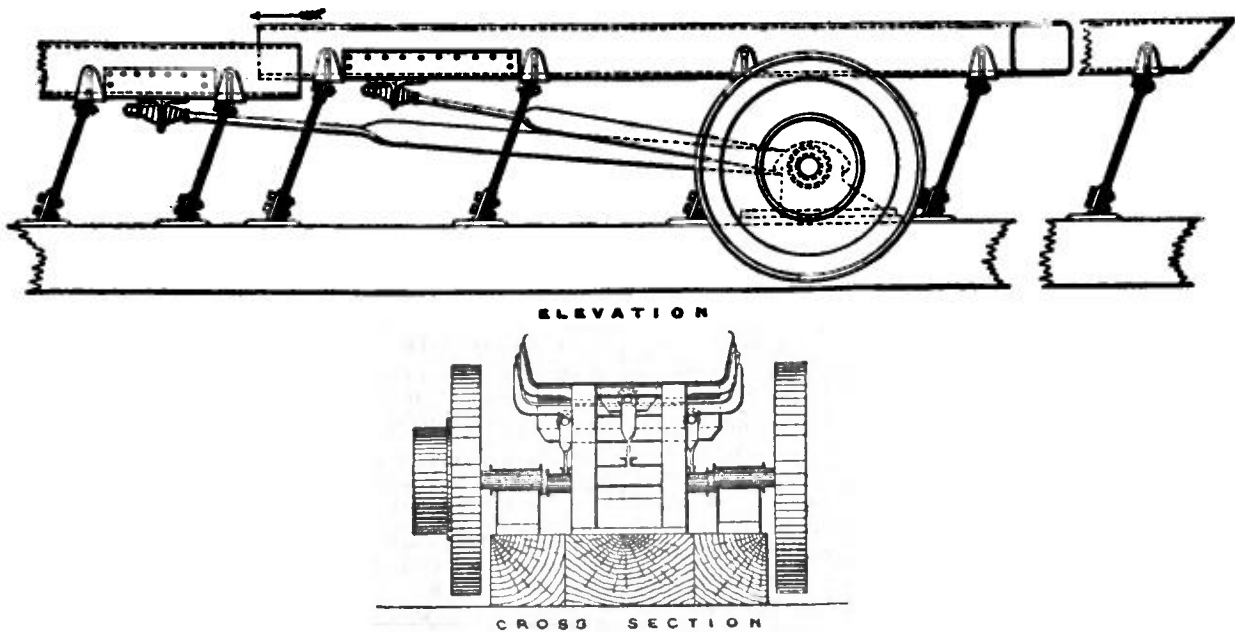

FIG. 9.

conveyor, the material will traverse 40-70 ft. per minute. The gentle action of this appliance has caused it to be largely used in dealing with friable materials, such as coal. The simplicity of the mechanism leaves little to get out of order, and the entire absence of travelling gear, such as supporting rollers, is a valuable feature. The capacity of the conveyor may be sensibly increased by running it on a downward gradient, while the capacity will be correspondingly diminished by working in an upward direction. Among many purposes for which this type of conveyor has been found suitable is that of a drainer in connexion with coal-washing plants. A perforated plate at the head will allow the water to escape, while the coal is carried to the other end. A slight upward slant permits the water left with the coal to run back and escape. In colliery work this conveyor makes a suitable picking table. The motion of the trough, while not so fast as to baffle the pickers, has the advantage of uniformly spreading the lumps of coal. This apparatus also lends itself to the grading of coal. All that is necessary is to fit the trough with a sieve which divides it into an upper and lower deck. The coarser material passes along the top of the sieve, while the finer coal, sifted out by the perforations, travels along the bottom of the trough till discharged. In spite of the gentle propelling action of this conveyor, it has a thorough sifting action; a perforated plate from 10 to 12 ft. long is usually sufficient to separate any desired grade, and at a certain Belgian colliery a conveyor of this type fitted with grading sieves feeds seven trucks standing in a row, but each on a different siding, and each taking coal of a different size. This conveyor has been found useful both as a drying and cooling appliance. Several substances of a sticky nature, such as moist sugar, which are difficult to deal with mechanically, can be efficiently handled by the swinging conveyor.

The gravity or tilting bucket conveyor can be used as a combined elevator and conveyor. It consists essentially of two endless chains or ropes held at fixed distances apart by suitable bars which are fitted with small rollers at each end. Every link, or second link, carries a bucket, and the whole forms an endless

Conveyors of this type run at a mean rate of 40 ft. per minute, and if it be desired to attain a given capacity the size of the buckets must be adapted to the increased load as an increase of speed for a higher capacity is impracticable. The power absorbed is not great, the heaviest demand on the motive force being made by the elevating operation. Such conveyors have the merit of handling the material gently, while feeding and discharging can take place at any point. There are many journals to be looked after, but in the most approved systems their lubrication is effected automatically. Whilst such a plant has the advantage of requiring only one driving gear, a breakdown at one point of the installation means the stoppage of the whole.

Among typical conveyors on this system is the Hunt conveyor (fig. 10), which consists of a double link carrying a series of pivoted buckets which are free to revolve on their axes at all points, except at that point at which they discharge. This operation is effected by a cam action, the buckets on their release righting themselves and becoming ready for refilling. The driving gear propels the chain by means of pawls which engage with the cross studs of the chain and have a central thrusting action. Another well-known appliance of this type is the pan bucket conveyor. This consists of a continuous trough built in sections and supported on axles and guide wheels running on suitable rails. There is one axle to each section, and in each section of the trough a bucket is pivoted to the sides. There are several other conveyors of this type, amongst which the "Tipit" should be mentioned. For the Bousse gravity conveyor it is claimed that it will go round any curve backwards or forwards in both planes, and is therefore adaptable for installations when the typical gravity bucket would be useless. The buckets of this conveyor are coupled together by a link in the middle, which obviously allows more latitude in negotiating curves than the double chain of most of the other types.

*Pneumatic Grain Elevators* have been employed with good effect in loading and unloading grain from ships. This method of conveying grain falls under three systems: (1) the blast system; (2) the suction system; and (3) the combined blast and suction system.

In the first system a barge, known as a machinery barge, is fitted with a steam boiler, a set of air compressing engines, and a length of flexible piping long enough to reach from any part of the barge to the farthest corner of the ship to be loaded. A small pipe, known as the nozzle, is inserted at the inlet end of the piping, where the grain is taken in, and communicates with the air compressor at the other end. Compressed air can be admitted to the nozzle or shut off by a valve. The inlet end of the flexible pipe is pushed into the grain in the barge, while the other end is led over the hatches of the vessel to be loaded. As the compressor is set to work and the valve of the compressed air supply pipe opened, the air naturally rushes up the pipe and

this through valves into a second receptacle, whence it is conveyed to any desired point by flexible pipes. This second tank is divided into two sections and provided with valves so that the two sections will alternately be under the influence of blast or suction. Alternatively the grain is discharged by an automatic valve from the vacuum tank into the second air-tight chamber which communicates with the compressed air chamber. From this section the grain is discharged by an outlet pipe by the agency of compressed air. A similar system was introduced by Messrs Haviland & Farmer, who have, however, since abandoned it on account of difficulties connected with the application of the blast, which was found to abrade the grain rather severely, especially at the bends in the pipes. An even greater objection was the delivery of dust with the grain, which made it impossible for trimmers to remain in the hold while the elevator was at work. Messrs Haviland and Farmer now work on the suction system, in which they claim to have introduced several improve-

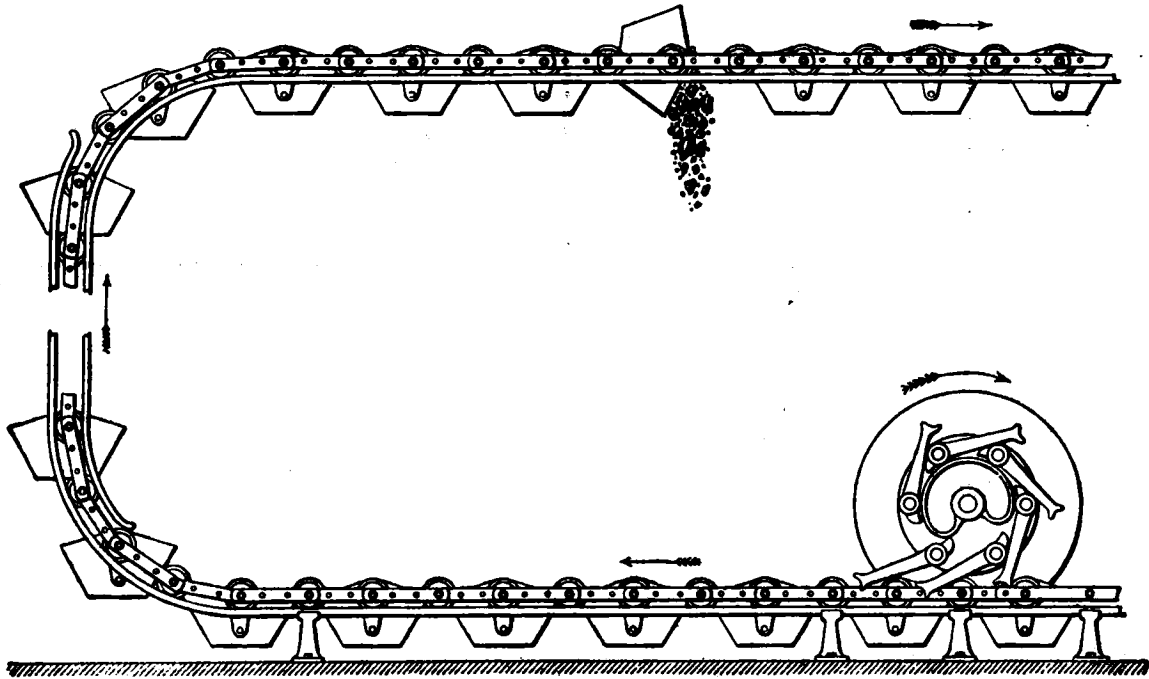

FIG. 10.—Travelling Bucket Elevator.

escapes at the other end which is lying over the ship's hatchway. If the inlet nozzle be immersed in the grain to the depth of 12 to 18 in. the induced atmospheric air will follow the lead of the compressed air, and drawing the grain around into the inlet nozzle will carry it up the pipe and deliver it into the hold of the vessel loading.

In the suction system, which is identified with the name of F. E. Duckham, the process is somewhat different. An air-tight tank or receiver, 8 to 10 ft. in diameter and 10 to 20 ft. high, is fitted with a hopper bottom, and is erected, if floating, on a barge, at a sufficient height to allow grain falling from the hopper bottom, and passing through an air lock, to be delivered by gravity through a shoot into the vessel being loaded. A pipe connects the vacuum tank with the exhaust pumps. Several flexible pipes of sufficient length to reach any corner of the ship to be unloaded, may be connected with the vacuum tank. As the air pumps are set working a partial vacuum is formed within the tank, and as the nozzle end of the pipe is immersed into the grain to the depth of a few inches, the air and grain are drawn in at the mouth of the nozzle and carried along the pipe to the vacuum tank. The natural expansion of the air then lets the grain drop to the hopper bottom, whence it issues from an air-lock valve, while the air is drawn away by a pipe communicating with the pumps and is thence discharged into the open.

In the third system, or blast and suction combined, the grain is sucked into a vacuum tank, as just described, and drops from

ments, notably in regard to the purification of the air between the vacuum chamber and the exhaustors, and in devising a new automatic air trap.

The first pneumatic suction elevator in Great Britain was erected at the Millwall docks (London) under the Duckham patents. At Sulina, on the Lower Danube, a pneumatic elevator erected on the Haviland-Farmer system, which has undergone one or two reconstructions, has been proved capable of elevating 160 tons of grain per hour with 375 i.h.p.

The only objection to pneumatic elevators appears to be that of expense. The cost of installation is relatively heavy, and the power required for working is large. But in dealing with vessels carrying heavy cargoes of grain the saving of labour and demurrage is sufficient to justify the large outlay of capital required in ports where there is sufficient grain traffic.

*Hot Coke Conveyors.*—Hot coke is admittedly one of the most difficult materials to handle by mechanical means, and though it might be too much to say that all difficulties have been surmounted by the engineer, it has, since the end of the 19th century, been more or less satisfactorily handled by machinery. Even in a dry state coke is a troublesome material to handle by machinery. It is of a gritty and rasping nature, and is at the same time very friable. Unless it is gently handled, breakage is bound to occur and to result in the making of a certain proportion of fine dust known as "breeze." Apart from the depreciation in the value of the coke, this breeze is a sharp, cutting material, calculated to do

## CONVEYORS

considerable injury to the working parts of the conveyor, such as chains, and to the bearings, if it can get inside. Of course the conveying of the coke in an incandescent condition is another serious difficulty, as this glowing material must be quenched by water, a sufficiently delicate operation in itself. The chief use for hot coke conveyors has been found in connexion with gas works, but attempts have also been made to provide efficient machinery for the service of coke ovens of great capacity.

The justification of any kind of machinery must rest on its relative efficiency and economy. As compared with some other materials the mechanical handling of hot coke does not realize such a striking economy; a hot coke conveyor is expensive to build—on account of the great wear and tear it must be very solidly constructed—and it is costly in upkeep. Still in large gas works the use of machinery for treating glowing coke is economic-

uptake to carry away the fumes and vapours. These trucks have been hauled, in lieu of human arms, by endless ropes or even small locomotives.

The earlier hot coke conveyors were of the *pushplate* type. The trough, some 27 in. wide, consisted of cast iron sections, while the pushplates, formed of malleable castings, were attached at a pitch of 24 in. to a central chain and were pulled along on a wrought iron bar, which could be renewed when necessary. These conveyors with a speed of 48 ft. per minute, had a capacity of some 20 tons per hour. A conveyor constructed on these lines was installed at the Gathorn works in 1903. The wear and tear was very great; moreover the chain, being central, suffered severely from the hot coke, to the action of which it was directly exposed.

The New Conveyor Company's conveyor consists of a water-tight trough through which pass closely-fitting tray plates, attached to a single chain. These plates are joggled down at one end to receive the flat front part of the succeeding plate, with the aim of excluding

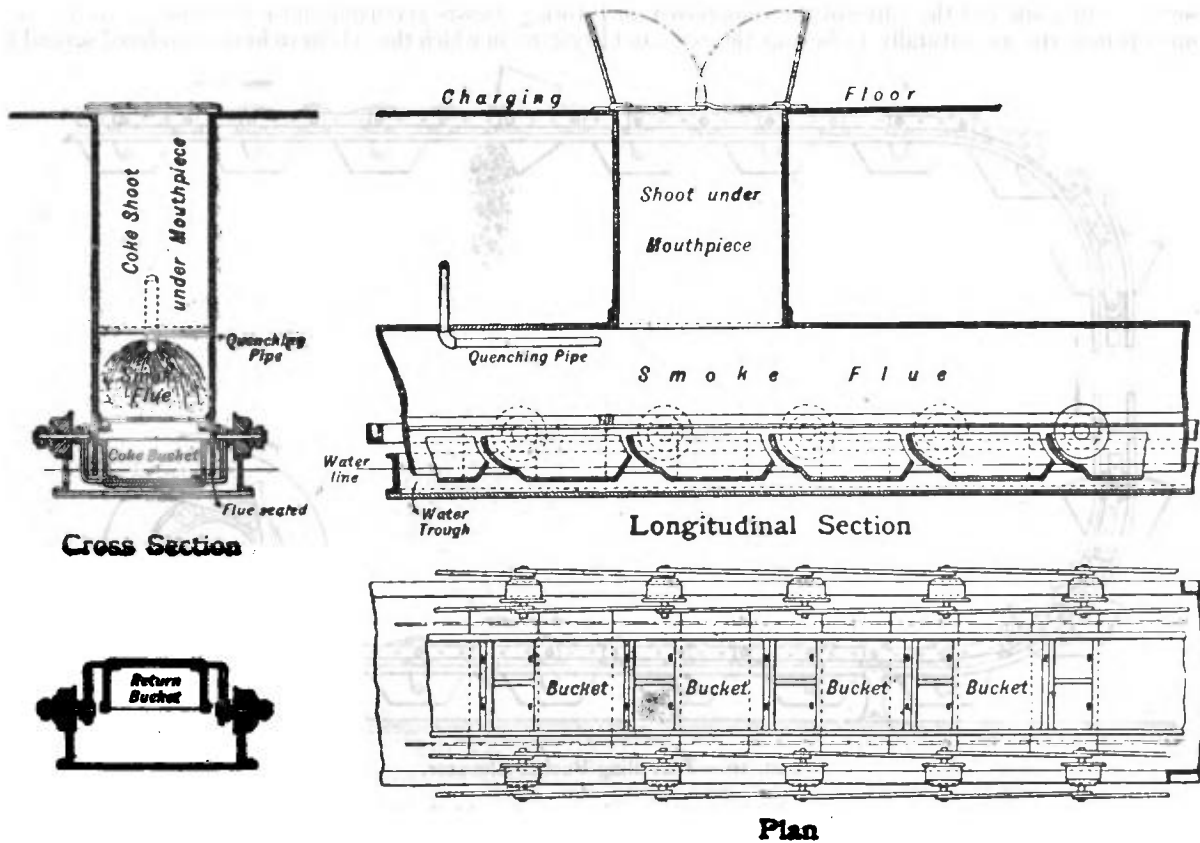

FIG. 11.—Bronder Hot Coke Conveyor.

ally advisable. Exact calculations are not very easy to make, because while the cost of hand labour in this department of a gas works is accurately known, the efficiency of different hot coke conveyors varies. G. E. Stephenson, of the Gathorn gas works, estimated that a saving of 4½d. per ton had been realized on each ton of coke conveyed to the yard from the retort house, as against the same material wheeled in barrows. This saving represented the difference between the cost of twelve men, who formerly handled the hot coke with shovels and barrows, and the cost of one conveyor with the wages of one man to look after it. In an ordinary way one man would rake out the coke from the retort mouthpiece into a barrow placed underneath, while a second man quenched the glowing coke with buckets of water, or better still with a hose. Then the barrow would be wheeled out into the yard. Obviously this is a slow and relatively expensive method, apart from the deleterious fumes arising from the quenching of the coke. Some improvement was effected by the substitution for the old hand-barrows of cage-like tipping trucks; these are run on narrow gauge rails out of the retort house and the red-hot coke they contain is quenched by a copious spray, the truck being placed the while over a grating through which the surplus water is drained away, under an inverted funnel with an

the breeze from the under part of the carrying plate. The chain is made entirely of steel with side rollers attached to every third plate. The plates, ¼ in. thick, are dished in the shape of a tray, which is less liable to distortion (from heat) than a flat plate. The speed of travel is about 45 ft. per minute, while the capacity when handling coke from 20 ft. retorts is some 30 tons per hour.

A conveyor made by Messrs Graham, Morton & Co., consists of a travelling tray, the sections of which are joined together by steel spindles provided with a roller at each end, the latter running on suitable rails. These sections consist of steel castings with a number of lateral slots; thus the tray has the appearance of a travelling grating. To receive the quenching water that escapes through the grating a trough is placed beneath, and a scraper is used to free the trough of the dust escaping through the grating.

An interesting conveyor is that of G. A. Bronder, of New York (fig. 11), which has some affinity with the gravity bucket conveyor. It runs in a water-tight trough which is filled up to a certain height, the water being slowly circulated by mechanism which resembles a water wheel. The chain of buckets runs in the trough, the sides forming the rails for the supporting rollers. The conveyor is covered in along its whole length, and forms a sort of flue which is connected at each bench with a number of shoots through which the coke drops into the conveyor buckets. A pipe of large diameter is connected with an exhaust fan, which draws away the fumes created by the quenching process, and sends them into a chimney discharging into the open. The chain and buckets, being carried on rollers which run on the outer edge of the trough, cannot come in contact



either with the hot coke or with gritty particles. The chain of buckets is connected by horseshoe-shaped brackets extending upwards beyond the sides of the buckets and connected with the links of the driving chains. When the conveyor is at work the covers of the mouth-pieces are opened and the coke is fed into the buckets; simultaneously the water valves are opened and the glowing coke is quenched. Any breeze which may have fallen between the buckets is collected by a scraper and delivered into a tank at one end, while the propeller wheel draws the water from this tank and drives it back to the other end of the trough. The top strand is the working strand and delivers its load at the terminal. One important differ-

The De Brouwer hot coke conveyor, which is much used in gas works both in Great Britain and on the continent of Europe, was invented by a Belgian engineer. Its construction has undergone many modifications which experience has shown to be desirable. It consists of a trough of cast or wrought iron, or mild steel, 20 to 36 in. wide and 3 to 6 in. deep. Double endless chains run in the corners of the trough, the two chains being connected together by round cross bars set 30 in. apart, so as to form a sort of ladder. The hot coke is carried or dragged along by these bars. One end of the trough is closed and the other is bent upwards with a view to retaining the quenching water. As the hot coke is dragged along it is subjected to the action of jets of water. The conveyor bars, which act as scrapers, sweep the water and the coke along the trough till the point is reached where the latter curves upwards. Then the water flows back like a small cascade on the half-quenched coke, which is thus thoroughly extinguished. Considerable inclines can be negotiated with this conveyor; in some installations on the continent of Europe angles of 30° to the horizontal have been surmounted. In a modification of the De Brouwer conveyor, installed at the Cassel gas works, the bars which form the rungs of the conveyor were replaced by cast iron rakes. In another modified form, the work of F. A. Marshall, to be found in the Copenhagen gas works, sluices are provided for withdrawing an excess of water at any point in the trough.

In Great Britain a hot coke conveyor has been designed on similar lines by Messrs R. Dempster & Sons, Ltd. (fig. 13). The chains are parallel from end to end, and are composed of identical and interchangeable malleable cast links. Instead of the chains carrying the rollers, as is often the case, the chains are themselves carried and guided by flanged rollers supported from the framework. This arrangement has the advantage of decreasing the weight of the chain, as neither the rollers nor the lubricators have to be conveyed, being stationary. The scrapers are of cast steel and have a rake-like shape with a view to minimize the breakage of coke.

The essential features in a hot coke conveyor are strength and simplicity, a minimum of wearing parts, interchangeability of wearing surfaces and of worn and broken parts, protection of wearing and working parts from contact with the hot coke, and facilities for keeping the temperature of the conveyor as even as possible, so as to avoid distortion of parts through sudden changes. To attain these latter conditions, it appears essential to construct conveyors of the pushplate type. In these the hot coke is kept continually moving, and thus the good effect is secured of heating the conveyor from end to end uniformly and gradually. This applies particularly to gas works conveyors.

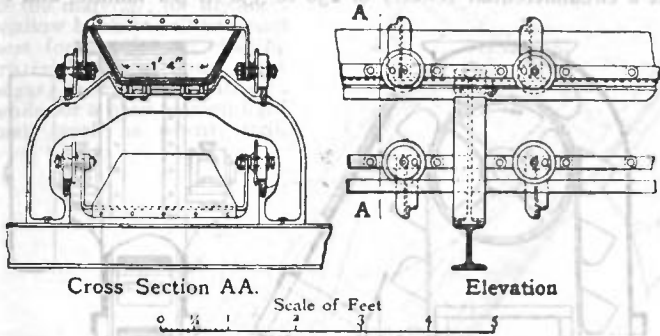
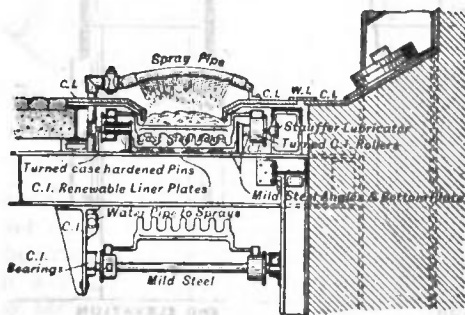

FIG. 12.—Wild Coke Conveyor.

ence between an ordinary gravity bucket conveyor and this apparatus is that the buckets are here rigidly connected to the supporting wheels.

The West hot coke conveyor consists of a strongly-built trough in which a single wide chain partly carries and partly drags the coke. In the trough is a false bottom, the plates of which are loosely fixed and kept in position by angle irons on which the chain drags. By two arm-like extensions the links of the chain are widened right across the trough. The pitch of the chain is 12 in., so that all the large pieces of coke are more carried than dragged. The speed of travel is about 40 ft. per minute.

The Wild conveyor (fig. 12) consists of a cast iron or steel trough 24 to 30 in. wide by 9 in. deep, supported by cast iron brackets to which the rails that support the strands of the chain are secured. Both chains run outside the trough, and are secured on either side to the pushplates, so that only the scraper comes in contact with the hot coke. Every second link of the 12 in. pitch chain carries a push or scraper-plate, as shown in illustration.



Cross Section

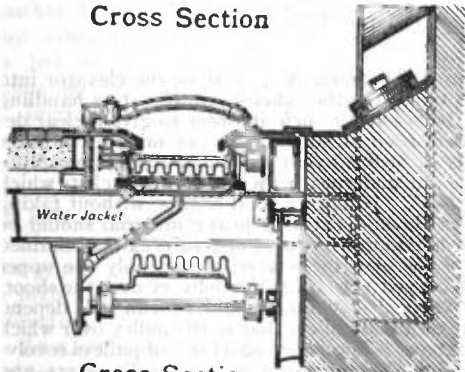

Cross Section, with Water Jacket.

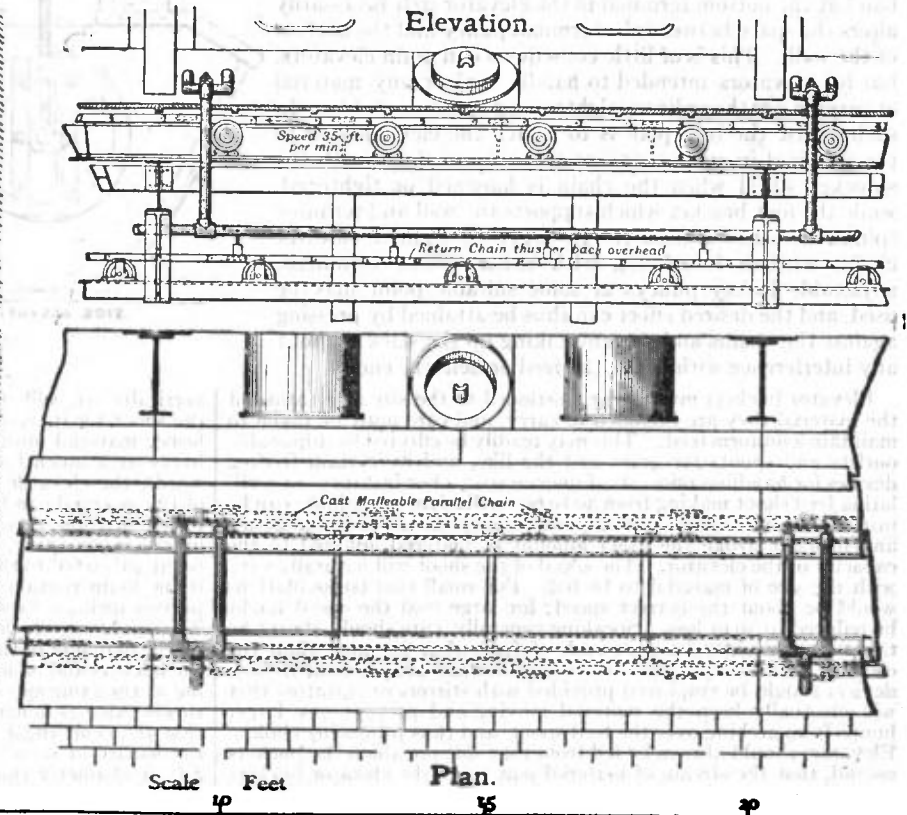

FIG. 13.—Dempster Coke Conveyor.

For the service of coke ovens the plate or tray conveyor might be suitable because more gentle. It must be remembered that coke oven conveyors must be of large capacity, and moreover in this case there is more scope for cooling the coke in front of the oven before it is removed to the conveyor, the work being all effected in the open.

**Elevators.**—This term is here confined to its proper meaning (in English engineering treatises) of a device for raising material in a vertical or slanting direction by means of buckets attached to endless belts or chains. Lifts for passengers are also sometimes termed elevators (*q.v.*), and in America the term is also currently applied to the granary or warehouse in which grain is stored (see GRANARIES).

In the bucket elevator, an endless belt or chain runs over terminal pulleys which are fixed at different levels, the distance from centre to centre of these pulleys being known as the length of the elevator. The design and construction of the elevator will be varied to suit its purpose. Grain elevators are invariably cased in wooden or iron trunks, and the head and foot are also of wood or iron, iron trunks being particularly used in so-called fire-proof buildings. The trunk of the grain elevator (fig. 14) is almost always vertical whilst the band to which the buckets are attached may consist of leather, cotton, hemp, webbing or other suitable substances. When an elevator is intended for lifting heavy materials, such as coal, coke or cement, it is usually set at a slant (figs. 15 and 16), and the endless belt is replaced by one or two strands of endless chain which support the buckets and run over the terminal sprocket wheels. The buckets are attached to the links of the chains, and to prevent these heavy buckets and chains from sagging in their inclined position, rollers or more often short skidder bars are fixed to each bucket, sliding on well-oiled angle bars on each side of the elevator frame.

Both grain and mineral elevators are usually fitted with tightening gears to keep the belt or chain taut; these are generally placed at the lower or well end so as not to interfere with the position of the upper terminal, which is almost invariably the driven one. The tightening of the band at the bottom terminal in the elevator well necessarily alters the space between the terminal pulley and the bottom of the well. This is of little consequence in grain elevators, but for elevators intended to handle coal or any material of varying size the ordinary tightening gear is unsuitable. In such a case the best plan is to attach the elevator-well to the terminal in such a way as to go up or down with the sprocket wheel when the chain is loosened or tightened, while the foot bracket which supports the well and terminal spindle remains a fixture. In order to tighten elevator chains without interfering with either of the terminals, adjustable jockey pulleys at some suitable point may be used, and the desired effect can thus be attained by pressing against the chains and thereby taking up the slack without any interference with either the feed or delivery end.

Elevator buckets must be proportioned to the size and nature of the material they are intended to carry, and care must be taken to maintain a uniform feed. This may readily be effected by adjustable outlets and spouts for grain and the like, and by certain feeding devices for handling minerals of uneven size. For instance, an oscillating feed shoot making from 30 to 60 oscillations per minute can be installed in such a case, and adjusted to deposit at each backward and forward stroke the exact amount of material adapted to the capacity of the elevator. The speed of the shoot will naturally vary with the size of material to be fed. For small coal 60 oscillations would be about the correct speed; for large coal the speed might be reduced to 30 or less. Speaking generally, care should always be taken to prevent an undue rush of feed, that is, more than the elevator can take up, and if tenacious materials are handled, feeding devices should be employed provided with stirrers or agitators that will effectually keep the material moving and prevent any larger lumps from arching over the feed spout, and thus producing chokes. Elevators should always be fed from that side on which the buckets ascend, that the stream of material may meet the elevator buckets on their upward journey. This will prevent the material from filling up the elevator well and spare the buckets from dredging through an accumulation of feed. Elevators erected at an incline

are best fed at a point several feet above the well into the chain of ascending buckets, as under such conditions little will miss the buckets and drop into the well.

The reason why grain elevators are set vertically, whereas elevators intended to carry heavy bodies such as coal and ore are generally inclined at an angle, is that the former can be run at a much greater velocity than the latter. Grain, for instance, would be uninjured by a velocity at the delivery end which would fracture coal and seriously reduce its value, to say nothing of the dust production and the damage which would be done to the receiving spouts and shoots. Elevators carrying a light material can be run at a circumferential velocity of 250 to 350 ft. per minute, and if

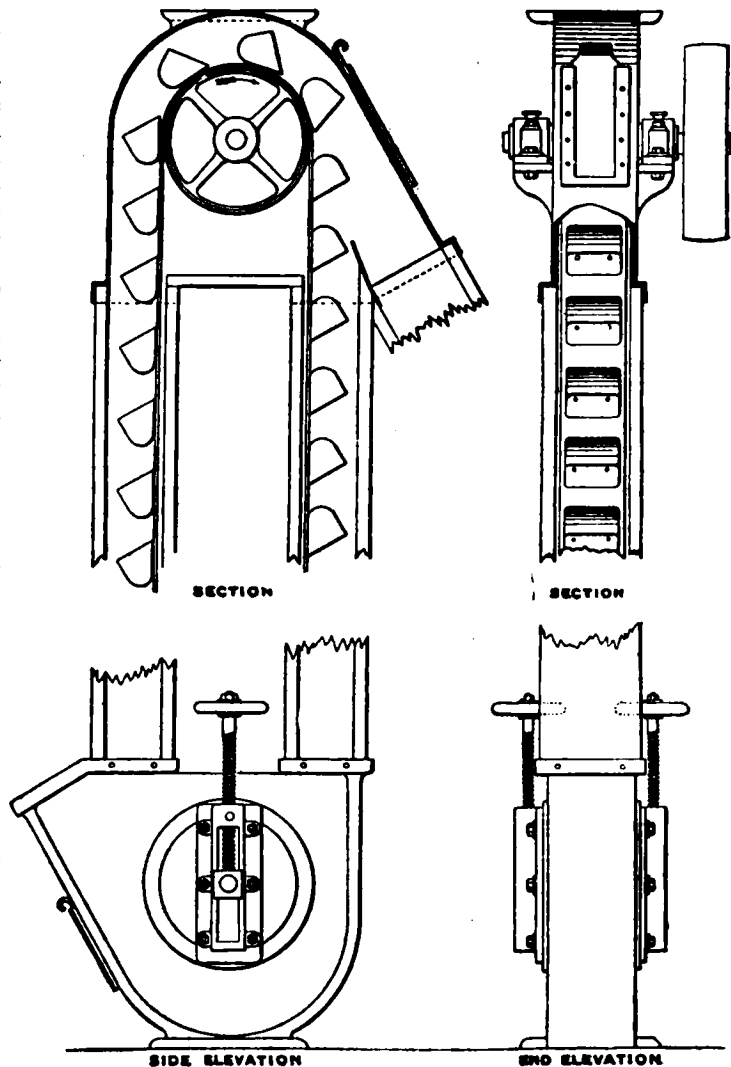

FIG. 14.—Grain Elevator.

vertically set, will throw the grain, &c., clear of the elevator into the shoot for its reception. On the other hand, elevators handling heavy material must be set at an angle in order to give a clear delivery at a much lower speed of 50 to 60 ft. per minute; in other words, the elevator is so inclined that the shoot for the reception of the material can be put underneath the delivering buckets which slowly disgorge their load. To obtain good results, without taking up too much space, an elevator carrying heavy material should be set at  $40^{\circ}$  to  $60^{\circ}$  to the horizontal. The same results can be obtained if the main portion of the elevator is vertical and only the upper portion inclined, or so curved as to bring the delivery over the shoot. The speed at which vertical elevators should be run will depend on the diameter of the terminal pulley, that is, the pulley over which the buckets and bands pass. The centrifugal force of pulleys revolving at the same speed is in direct proportion to their diameters, and this is twice as much in a 2 ft. as in a 1 ft. pulley. It may be taken that the centrifugal force of a pulley will increase in proportion to the square of its velocity; hence the centrifugal force of a pulley 2 ft. in diameter running at 50 revolutions per minute will be four times the centrifugal force of a pulley of the same diameter making only 25 revolutions per minute. It must not be forgotten that to effect a clean discharge of the buckets of a vertical elevator, the

centrifugal force must be sufficient to overcome the gravity of the material, because the material thrown off the delivery pulley in a horizontal direction will be more rapidly deflected into a parabolic curve the higher its specific gravity. It follows that for a specifically heavy material a greater centrifugal force will be required; that is to say, the elevator will have to be higher speeded than in dealing with a lighter material.

Elevator buckets must be varied according to the nature of the material; for instance, shallow buckets will be found best for a soft and clinging material such as flour, moist sugar, sand, small coal, &c., while for a hard or semi-hard body such as wheat, coal,

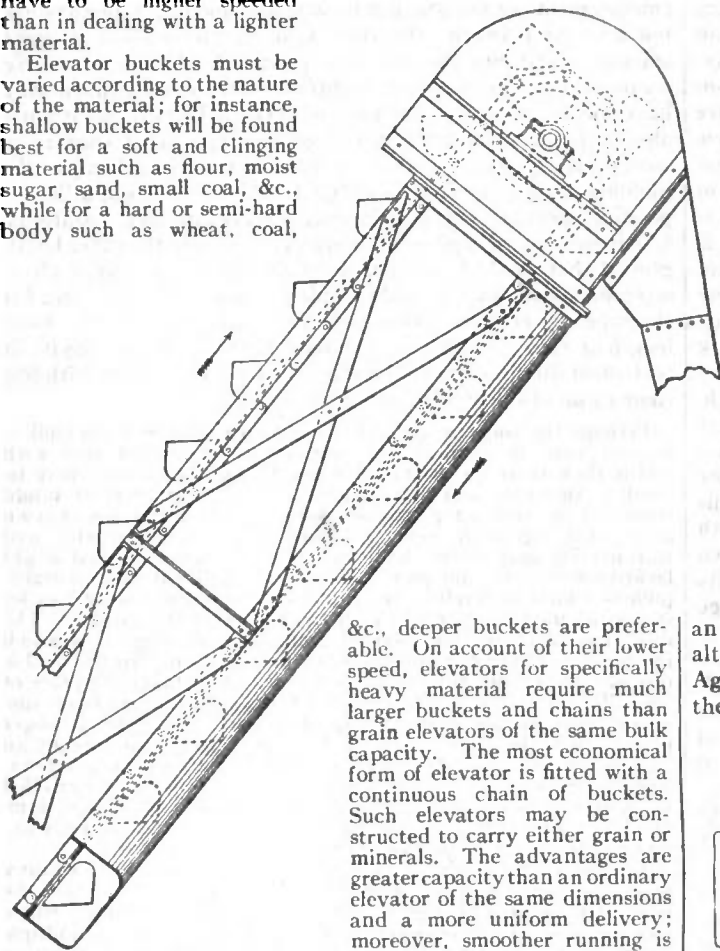

FIG. 15.—Mineral Elevator, upper terminal.

&c., deeper buckets are preferable. On account of their lower speed, elevators for specifically heavy material require much larger buckets and chains than grain elevators of the same bulk capacity. The most economical form of elevator is fitted with a continuous chain of buckets. Such elevators may be constructed to carry either grain or minerals. The advantages are greater capacity than an ordinary elevator of the same dimensions and a more uniform delivery; moreover, smoother running is secured, since the buckets being close together need not plunge intermittently through the contents of the elevator-well.

**Intermittent Conveyors.**—The elevators we have been considering, whether used for carrying and distributing coal or grain, have this in common, that they raise material from a lower to a higher level, so to speak, in a continuous stream, the continuity being broken only by the short spaces between the buckets. In the continuous bucket type indeed the stream of material is practically, if not absolutely, continuous. In all these cases the elevator is fed with the material in a continuous stream, and by some mechanical means; whether by band, worm or shoot, is immaterial. Elevators of a somewhat different and more substantial construction may be and are often used for handling filled sacks, barrels, carcasses of animals and other bulky objects, which cannot be delivered in a uniform stream, but may have to be conveyed by the elevator intermittently. The ordinary buckets used for grain or coal are replaced by other appliances for gripping and holding the object to be raised from a lower to a higher level, but in principle these appliances are essentially elevators.

Another kind of elevator, known as a *lift* or *hoist*, is used in mines and quarries and in serving blast furnaces. This is an elevator with one or two buckets. Essentially a heavy load lifter, it is intended for material of too large a bulk to be handled economically by ordinary elevators, and is employed for lifting in either a vertical or, more often, an inclined direction.

For elevating materials, such as large coal, iron ore, limestone, &c., which are too large to be fed into ordinary elevators, and

must therefore be handled intermittently, the single bucket elevator or hoist may be used with advantage. But as the essential use of mechanical appliances for handling material is to save human labour as far as possible, that hoist will prove the most economical the operation of which is as automatic as possible. The Americans seem to have been pioneers in the construction of *furnace hoists*, which form the principal elevators of this class, but some excellent examples of the modern furnace hoist are now to be found in Great Britain and elsewhere in Europe. Generally speaking, a furnace hoist consists of an inclined iron bridge girder set at an angle to the upright shaft of the furnace. On this incline are laid rails for the ascent and descent of the bucket, which in this case is known as a skip and is provided with suitable wheels, while the hoisting gear manipulating the skips by a steel rope is erected on or near the ground level. The rails when they approach the upper terminus are usually bent in a more or less horizontal position so as automatically to tilt and thereby unload the skip. To attain the same end, the rails supporting the back wheels of the skips may be bent at the terminus, or the back wheels may have additional wheels of a larger diameter on the other side of their flanges, so that during the ascent and descent the skip runs on its four normal wheels, while at the upper terminus the outer and larger back wheels engage with short lengths of extra rail and thus tilt and effect the automatic clearance of the skip. The dead weight of the skip may be balanced by a counter weight, or double tracks may be laid, so that the empty skip descends on one track whilst the loaded skip is being raised on the other. In this case the distributing hopper at the top of the furnace has

an elongated shape so as to take the charges alternately from buckets on either track. Again, the two tracks may be laid one above the other, so that one skip runs on the upper

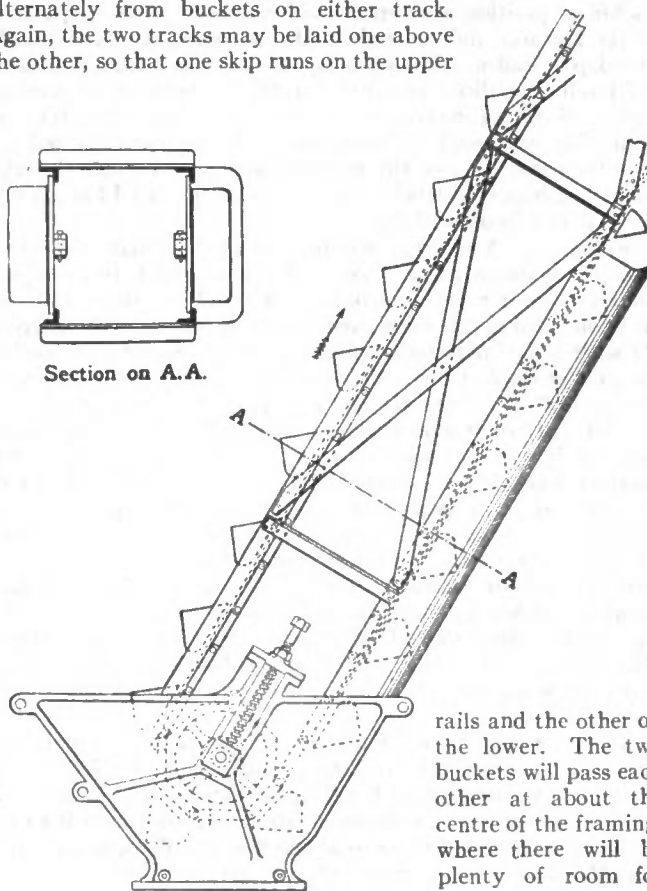

FIG. 16.—Mineral Elevator, lower terminal.

rails and the other on the lower. The two buckets will pass each other at about the centre of the framing, where there will be plenty of room for clearance.

The capacity of the skip will of course depend to some extent on the capacity of the furnace, but an average charge may be put down at 2 tons of ore and lime, or 1 ton of coke. To raise such a charge to a furnace 80 ft. high would require, assuming no counter weight were used, a motor of about 100 h.p. On account of the great speed at which

the hoist works, the time taken in raising the charged skip, discharging it, and returning it empty would be only 30 to 40 seconds. The hoist cable runs over guide pulleys placed at the top of the furnace, and the cable is often manipulated by an electrically driven winch in a cabin below. The descent of the empty skip in more modern installations is utilized to effect an even distribution of the feed from the hopper to the furnace by causing the hopper to revolve. To this end the latter is provided with an ingenious mechanism which only comes into operation as the car descends. After every charge shot into the hopper the latter is revolved a few degrees, and this has the effect of giving the delivery of the next load in another direction, so that the charges of the skip are in turn distributed over the whole area of the surface. This is deemed a most essential point in furnace-charging, and it is not one of the least recommendations of this mechanical system of furnace-charging that it can give an even feed without any hand labour whatever. A double hoist has been designed which has the advantage that if one elevator breaks down the work of the furnace is not interrupted. In this system two furnaces are connected at the top by a gantry or bridge, against which, between the furnaces, two inclined elevators are set, so that each can serve either furnace. The skips are on wheels and detachable from the elevator, and are loaded from the ore pockets at the lower terminal and drawn up on a cradle; as this reaches the top where the rails on the gantry correspond with the gauge of the skip or car, the latter is carried by its own weight down a slight incline to either furnace, discharging its contents as it passes over the conical mouth. Another advantage claimed for this system is that the rails of the cradle, when in its lowest position, correspond with the rails which lie parallel to the furnaces and run right under the store bins from which the skip is loaded. The economy to be realized from a furnace hoist will be in direct proportion to the use made of mechanical means of feed conveyance. For instance, the store bins in connexion with such elevators might be economically fed by suitable conveyors, or the material might be brought in self-unloading hoppers into conveniently placed bins, ready to be drawn into the skips.

*Ropeways.*—A ropeway has been defined as that method of handling material which consists of drawing buckets on ropes, and by means of ropes, such buckets being filled with the material to be handled and being automatically or otherwise discharged. At what period of history ropeways were first used it is impossible to say, but the fact that pulley blocks, and even wire ropes, were known to the ancients, renders a pedigree of 2000 years at least possible. In more modern days, an old engraving shows a single ropeway in working order in 1644 in the city of Danzig. This, the work of Adam Wybe, a Dutch engineer, was a single ropeway in its simplest form, consisting of an endless rope passing over pulleys suspended on posts; to the rope were attached a number of small buckets, which evidently carried earth from a hill outside the city to the rampart inside the moat. The rope was probably of hemp. Modern ropeways worked with wire ropes date from about 1860, when a ropeway was erected in the Harz Mountains. Since then several systems have been evolved, but in the main ropeways may be divided into the single and double rope class.

The ropeway is essentially an intermittent conveyor, the material being carried in buckets or skips, and practice has proved it an economical means of handling heavy material. The prime cost of a ropeway is usually moderate, though of course it varies with the ground and other local conditions. Working expenses should be low, because under the supervision of one competent engineer unskilled labour is quite sufficient. A ropeway may be carried over ground over which rails could only be laid at enormous cost. To a certain extent ropeways are independent of weather conditions, because their working need not be interrupted even by heavy snowfalls. Their construction is very simple, and there is little gear to get out of order. Sound workmanship and good material will ensure a relatively long life. As an instance, a certain rope in a Spanish ropeway tested new to a breaking

strain of 29½ tons was shown after carrying 160,000 tons (in two years' incessant work) still to possess a breaking strain of 27½ tons. The power absorbed by a ropeway is relatively moderate, and under special conditions may be nil. The only demand it makes on the superficial area of the ground traversed is the small emplacements of the standards, which in modern ropeways are few and far between. Wayleaves, or the permission to erect standards and run the line over private land, may of course mean an item in the capital outlay. This circumstance may have checked ropeway construction in Great Britain, but it must also be borne in mind that a large portion of that country is comparatively level and well provided with railways. In building a ropeway it is essential to take as straight a line as possible, because curves generally necessitate angle stations, which mean extra capital and working cost. On the other hand, ground that would be difficult for the railway engineer, such as steep hills, deep valleys and turbulent streams, has no terror for the ropeway erector. There is a case of a ropeway of a total length of 5400 ft. with a total difference in altitude of 2000 ft.; it is claimed this ground could not be covered by a railway with less than 15 m. of line graded at 1 in 40.

Perhaps the simplest type of a single rope system is an endless running rope from which the carriers are suspended, and with which they move by frictional contact. Or the carriers may be fixed to this rope and move with it. The ropeway itself would consist of an endless rope running between two drums, one, known as the driving drum, being provided with power receiving and transmitting gear, while the drum at the opposite terminal would be fitted with tightening gear. The endless rope is carried on suitable pulleys which themselves are supported on standards or trestles spaced at intervals varying with the nature of the ground. The rope runs at an average speed of 4 m. per hour, a speed at which the bucket or skip can automatically unload itself. In the double ropeway the carrier runs on a fixed rope, which takes the place of the rails of a railway. The carrier is fitted with running heads furnished with grooved steel wheels. The load is borne by a hanger pivoted from the carrier, and is conveyed along the rail rope by an endless hauling rope at an average speed of 4 to 6 m. per hour. The hauling is operated by driving gear at one end, and controlled by tightening gear at the other end just as in the single rope system. Double ropeways have been carried in one section over 18 to 20 m., and will transport single loads of 6 cwt. to a ton or more.

Broadly speaking, the single ropeway is not so suitable for heavy loads and long distances as the double, but in this connexion the work of Ropeways Limited should be noted, which favours a single rope system. Their engineer, J. Pearce Roe, introduced multiple sheaves for supporting the rope at each standard. Thus the rope may pass over one, two or four sheaves, which are provided with balance beams that have the advantage of adjusting themselves to the angle caused by the rope passing over the sheaves, thus equalizing the pressure over a number of sheaves. A ropeway erected on this system in Japan spans 4000 yds. of very broken ground; yet only 17 trestles are used, and as each support is placed as high as possible, no one is of great height. An altitude of 1130 ft. is reached in a distance of 1200 yds. The ropeway has a daily carrying capacity of 60 tons in one direction and of 30 tons in the other. Another installation on this system, which serves an iron mine in Spain, spans 6500 yds. of very rough country, so steep that in many places the sure-footed mule cannot keep on the track. This ropeway can deal with 85 tons per hour. The greatest distance covered by this system, on one section, is 7100 yds., or about 4 m., and the carrying capacity is 45 tons per hour.

The motive power required for a ropeway will vary with the conditions. In cases of descending loads the power generated is sometimes so considerable as to render it available for driving other machinery, or it may have to be absorbed by some special brake device. In a ropeway in Japan of 1800 yds., which runs mostly at an incline of 1 in 1½, the force generated is absorbed by a hydraulic brake the revolving fan of which drives the water against fixed vanes which repel and heat it. In this way, 50 h.p. is absorbed and the speed brought under the control of a hand brake.

*Aerial Cableways.*—The aerial cableway is a development of the ropeway, and is a conveyor capable of hoisting and dumping at any desired point. The load is carried along a trackway consisting of a single span of suspended cable, which covers a comparatively short distance. The trackway may either run in a more or less horizontal direction, *i.e.* the terminals may be on the same level, or it may be inclined at such an angle that the load will descend by gravity. The trackway or rail rope rests upon saddles of iron or hard wood on the tops of terminal supports, usually known as towers. These towers may be constructed



either of wood or iron, and if the exigencies of the work render it desirable, they may be mounted on trolleys and rails, in which case the cableway is rendered portable, and can be moved about, sometimes a great advantage in excavating work. The motive power may be either steam, gas, or electricity. The motor is situated in what is termed the head tower, which is sometimes a little higher than the other or tail tower. Sometimes, but not frequently, the latter is also fitted with a motor. The span between the two towers sometimes extends to 2000 ft., but this is exceptional. Very heavy loads are dealt with, sometimes as much as 8 tons in a single load. The load, which may be carried in a skip or a tray, is borne by an apparatus called the carrier, which is a modification of a running head, consisting of pulleys and blocks and running along the main cable or trackway. The carrier is also fitted with pulleys or guides for the dump line. The carrier is drawn along the main cable by an endless or hauling rope which passes from the carrier over the head tower and is wound several times round the drum of the winding engine to secure frictional hold, then back over the head tower, to the tail tower, returning to the rear end of the carrier. The hoisting rope passes from the engine to the fall block for raising the load. The dump line comes from the other side of the winding engine drum and passes to a smaller block attached to the rear end of the skip or tray. The whole weight of the skip is borne by the hoisting rope, while the dump line comes in slack, but at the same rate of speed. Whenever it is desired to dump the load, the dump line is shifted to a section of the drum having a slightly larger diameter, and being thus drawn in at a higher rate of speed the load is discharged. The engine is then reversed, and the carriage brought back for the next load.

This is in outline the mode of operating all cableways. This appliance has rendered great service as a labour saver in navvying, quarrying and mining work; in placer-mining, for instance, cableways have been found very useful when fitted with a self-filling drag bucket, which will take the place of a great number of hands. Cableways can be worked at a great speed, but a good mean speed would be 500 to 750 ft. for conveying and 200 to 300 ft. for hoisting. A cableway used in excavating work in Chicago was credited with a capacity of 400 to 600 cub. yds. per day at a total cost of 2d. per yard, including labour, coal, oil, waste, &c.

*Coaling Ships at Sea.*—In the coaling of ships at sea the cableway has rendered great service. The conditions under which this operation has to be carried out present many difficulties, especially in rough water. One of the chief obstacles is the maintenance of the necessary tension on the cable used in conveying the coal from the collier to the ship. The first test in coaling ships at sea, made by the British admiralty, took place in 1890 in the Atlantic at a point 500 m. south of the Azores in water 2000 fathoms deep. Ten ships of war were coaled, each vessel taking enough coal to enable it to steam back to Torbay, 1800 m. away. In this case the collier was lashed alongside the battleship it was feeding, thick fenders being interposed to prevent damage, but nevertheless as the colliers got light they pitched considerably, and one or two sustained dents in their sides. The ships did not roll, being kept bows-on to the swell, which became heavy before the coaling was completed. The coal was taken in by derricks at the main deck ports. It is clear that had the sea been really rough coaling in this fashion would have been impossible.

The most practicable method of coaling at sea yet devised is the marine cableway of Spencer Miller, which has been tried with some success in the American navy. It is intended for use between vessels 350 to 500 ft. apart. The ship being coaled takes the collier in tow, steaming at the rate of 4 to 8 knots; it has been found that a speed of five knots in moderately rough water will keep the cableway taut and maintain a sufficient distance between the crafts. The collier is fitted with an engine having double cylinders and double friction drums, which is placed just abaft the foremast. A steel rope  $\frac{3}{4}$  in. in diameter is led from one drum over a pulley at the mast head and thence to a pulley at the head of shear-poles on the vessel being coaled, and brought back to the other drum. The engine moves in the

same direction all the time and keeps on winding in both the strands of the conveying rope. Should the two vessels increase the distance between them during the operation of conveying the coal bags, of which two, weighing 420 lb each, may be fastened to the carrier, the extra rope called for is obtained by slipping the upper strand from the drum; this increases the speed of the upper cable. On the other hand should the distance between the vessels be reduced, this operation is reversed, the speed of the upper strand being reduced. To keep the carriage steady on its return empty, a rope, known as the sea-anchor line, is stretched above the two strands of the conveyor line, and under a pulley on the carriage. This cable is attached to the vessel, resting on a saddle on the shear head, whence it leads through the carriage over pulleys at the head of the foremast and mainmast of the collier, running on astern several hundred feet into the sea. A drag or sea-anchor, usually made of canvas and cone-shaped, is attached to the end of this rope. This anchor is used to support the empty carriage on its return to the collier. The diameter of the cone's base is graduated to the speed of the vessels. Thus in a smooth-water test, with a ship steaming at 6 knots, one 7 ft. in diameter was used, while the same anchor answered its purpose very well with a ship doing 5 knots in rough water.

The results given by this system of coaling at sea are relatively satisfactory. Tests made in the United States navy showed that 20 to 25 tons of coal per hour could be delivered by a collier to a war-vessel during a moderate gale. As the ship was under steam all the time and consumed 3 to 4 tons of coal per hour, the balance of the coal bunkered amounted to between 16 and 20 tons per hour, or say 384 tons in 24 hours. It has been suggested that under service conditions the speed of the towing vessel might be increased to 8 or 10 knots an hour; this would of course increase the coal consumption unless the collier proceeded under her own steam. But in such a case the space between the two crafts might be diminished, which would have the effect of causing the cable to sag and of stopping the work, since the conveyor cable to act properly must be kept taut. In Great Britain the Temperley Transporter Company have taken up this method of coaling at sea, working in collaboration with Spencer Miller, and have introduced several improvements in detail. Their system has been tried by the British admiralty.

The coaling of a large vessel by this appliance has the advantage of economizing hand labour. One man is required to work the hoist on the collier, while 20 men will be in the hold filling the bags and delivering them to the deck, where 15 or so will transfer the bags to the lift. One or two men suffice for the overhead work; their station is in the trestle trees. On board the receiving ship a few men will be stationed at the shear head to empty the bags into a canvas shoot, and then return them, while there will be the usual force of bunker trimmers. A ton of coal per minute has been transferred from the collier to the vessel, but for this capacity the ships must not be too far apart, else the rope would not remain taut under such loads. During the Russo-Japanese War, many of the Russian battleships were coaled by means of aerial cableways. The coaling of vessels in this manner seems a success, but it would be desirable to increase the carrying capacity of the cableway or to duplicate the installations.

*Telpherage.*—A telpher ropeway or cableway may be defined as a ropeway or cableway worked and controlled electrically, only a rail rope being required besides the live rail or wire from which the electric current is taken. Telpherage was devised by Professor Fleeming Jenkin in 1881, and developed by him in conjunction with Professors W. E. Ayrton and J. Perry. The telpher itself consists of a light two-wheeled truck, carrying the driving motors, which, to avoid gearing or other complicated mechanism, are usually coupled directly to the axles of the telpher. Thus the telpher is a self-propelled electric carrier running on a mono-rail, which, according to the conditions, may be a steel rail or a steel cable. From the telpher are suspended carriers which can be adapted to any kind of material. In many cases the whole load may be suspended from the telpher, or the load, especially if of some length, may be supported at one end

by a telpher, and at the other end by what is known as a trailer, or again, two telfers may be installed, one at each end of the load. The telpher carries a small trolley sheave or bow which serves to collect the current from a trolley wire stretched a little above the rail. Frequently the telpher is accompanied by an attendant who manipulates it, but by dividing the trolley wire into sections any system of telpherage may be constructed to work automatically, and by switching off the current from the section in which the telpher is required to stop it can be brought to a standstill at any required point. The speed of the telpher may be readily regulated by the introduction of a resistance between any section of the line and the supply of electricity. The speed may be high, as much as 1500 ft. per minute over the straight portions of the line, but slackened at curves and loading stations, or when approaching a terminus. The required power may be obtained from the mains of an ordinary electric supply with either direct or alternating current, but the former is preferable. The mean expenditure of power in a working day is said to average (including electrical hoisting) 1 H.P. per ton of average load.

The uses of telpherage are many and various. In factories and warehouses, where the buildings are scattered, it has been installed with excellent results. Being essentially an overhead system, there is a saving of floor space, the ground not being obstructed by trucks or trolleys. The same reasons which render ropeways an economical means of handling such material as coal, ore, stone, slate, &c., between the mine or quarry and the rail or barge, may be adduced in favour of telpherage. For the unloading of railway trucks in a crowded goods-yard it is undoubtedly applicable. Any kind of tipping or hoisting operations can be automatically effected by its aid, and any sort of grab may be used in dealing with such materials as sand, clay or gravel. Telpherage is clearly a labour-saving method of handling materials, but of course the exact conditions under which any system is to be used need careful study, while the economy to be effected by the installation of a telpher line must to a great extent depend upon the available supply of electrical energy.

(G. F. Z.)

**CONVOCAATION** (Lat. *convocatio*, a calling together), an assembly of persons met together in answer to a summons. The term is more usually applied in a restricted sense to assemblies of the clergy or of the graduates of certain universities.

In the American Protestant Episcopal Church a convocation is a voluntary deliberative conference of the clergy; it has no legislative function, and like the convocation of a university, assembles primarily to discuss matters of common interest.

In England the name "convocation" is specifically given to an assembly of the spirituality of the realm of England, which is summoned by the metropolitan archbishops of Canterbury and of York respectively, within their ecclesiastical provinces, pursuant to a royal writ, whenever the parliament of the realm is summoned, and which is also continued or discharged, as the case may be, whenever the parliament is prorogued or dissolved. These assemblies consist of two Houses, an upper and lower. In the upper house sit the archbishops and bishops, and in the lower the deans and archdeacons of every cathedral, the provost of Eton College, with one proctor elected by each cathedral chapter and two by the beneficed clergy in each diocese in the province of Canterbury (in the province of York two proctors are elected by each archdeacon), with a prolocutor at their head. When and how this convocation originated is not historically clear. This much is known from authentic records, that the present constitution of the convocation of the prelates and clergy of the province of Canterbury was recognized as early as in the eleventh year of the reign of Edward I. (1283) as its normal constitution; and that in extorting that recognition from the crown, which the clergy accomplished by refusing to attend unless summoned in lawful manner (*debito modo*) through their metropolitan, the clergy of the province of Canterbury taught the laity the possibility of maintaining the freedom of the nation against the encroachments of the royal power. It had been a provision of the Anglo-Saxon period, the origin of which is

generally referred to the council of Clovesho (747), that the possessions of the church should be exempt from taxation by the secular power, and that it should be left to the benevolence of the clergy to grant such subsidies to the crown from the endowments of their churches as they should agree to in their own assemblies. It may be inferred, however, from the language of the various writs issued by the crown for the collection of the "aids" voted by the *Commune Concilium* of the realm in the reign of Henry III., that the clergy were unable to maintain the exemption of church property from being taxed to those "aids" during that king's reign; and it was not until some years had elapsed of the reign of Edward I. that the spirituality succeeded in vindicating their constitutional privilege of voting in their own assemblies their free gifts or "benevolences," and in insisting on the crown observing the lawful form of convoking those assemblies through the metropolitan of each province.

The form of the royal writ, which it is customary to issue in the present day to the metropolitan of each province, is identical in its purport with the writ issued by the crown in 1283 to the metropolitan of the province of Canterbury, after the clergy of that province had refused to meet at Northampton in the previous year, because they had not been summoned in lawful manner; whilst the mandates issued by the metropolitans in pursuance of the royal writs, and the citations issued by the bishops in pursuance of the mandates of their respective metropolitans, are identical in their purport and form with those used in summoning the convocation of 1283, which met at the New Temple in the city of London, and voted a "benevolence" to the crown, as having been convoked in lawful manner. The existing constitution of the convocation of the province of Canterbury—and the same observation will apply to that of the province of York—in respect of its comprising representatives of the chapters and of the beneficed clergy, in addition to the bishops and other dignitaries of the church, would thus appear to be of even more ancient date than the existing constitution of the parliament of the realm.

From this period down to the eleventh year of the reign of Edward III. there were continual contests between the spirituality of the realm and the crown,—the spirituality contending for their constitutional right to vote their subsidies in their provincial convocations; the crown, on the other hand, insisting on the immediate attendance of the clergy in parliament. The resistance of the clergy to the innovation of the "praemunientes" clause had so far prevailed in the reign of Edward II. that the crown consented to summon the clergy to parliament through their metropolitans, and a special form of provincial writ was for that purpose framed; but the clergy protested against this writ, and the struggle was maintained between the spirituality and the crown until 1337 (11 Edward III.), when the crown reverted to the ancient practice of commanding the metropolitans to call together their clergy in their provincial assemblies, where their subsidies were voted in the manner as accustomed before the "praemunientes" clause was introduced. The "praemunientes" clause, however, was continued in the parliamentary writs issued to the several bishops of both provinces, whilst the bishops were permitted to neglect at their pleasure the execution of the writs.

The history of the convocation of the province of Canterbury, as at present constituted, is full of stirring incidents, and it resolves itself readily into five periods. The first period, by which is meant the first period which dates from an epoch of authentic history, is the period of its greatest freedom, but not of its greatest activity. It extends from the reign of Edward I. (1283) to that of Henry VIII. The second period is the period of its greatest activity and of its greatest usefulness, and it extends from the twenty-fifth year of the reign of Henry VIII. to the reign of Charles II. The third period extends from the fifteenth year of the reign of Charles II. (1664) to the reign of George I. This was a period of turbulent activity and little usefulness, and the anarchy of the lower house of convocation during this period created a strong prejudice against the revival of convocation in the mind of the laity. The

Contest  
between  
spirituality  
and  
crown.

Five  
characteristic  
periods.

fourth period extends from the third year of the reign of George I. (1716) to the fifteenth year of the reign of Queen Victoria. This was a period of torpid inactivity, during which it was customary for convocation to be summoned and to meet *pro forma*, and to be continued and prorogued indefinitely. The fifth period may be considered to have commenced in the fifteenth year of the reign of Queen Victoria (1852).

During the first of the five periods above mentioned, it would appear from the records preserved at Lambeth and at York that the metropolitans frequently convened congregations (so called) of their clergy without the authority of a royal writ, which were constituted precisely as the convocations were constituted, when the metropolitans were commanded to call their clergy together pursuant to a writ from the crown. As soon, however, as King Henry VIII. had obtained from the clergy their acknowledgment of the supremacy of the crown in all ecclesiastical causes, he constrained the spirituality to declare, by what has been termed the Act of Submission on behalf of the clergy, that the convocation "is, always has been, and ought to be summoned by authority of a royal writ"; and this declaration was embodied in a statute of the realm (25 Henry VIII. c. 19), which further enacted that the convocation "should thenceforth make no provincial canons, constitutions or ordinances without the royal assent and licence." The spirituality was thus more closely incorporated than heretofore in the body politic of the realm, seeing that no deliberations on its part can take place unless the crown has previously granted its licence for such deliberations. It had been already provided during this period by 8 Henry VI. c. 1, that the prelates and other clergy, with their servants and attendants, when called to the convocation pursuant to the king's writ, should enjoy the same liberty and defence in coming, tarrying and returning as the magnates and the commons of the realm enjoy when summoned to the king's parliament.

The second period, which dates from 1533 to 1664, has been distinguished by four important assemblies of the spirituality of the realm in pursuance of a royal writ—the first of which occurred in the reign of Edward VI., the third in the reign of Queen Elizabeth, and the fourth in the reign of Charles II. The two earliest of these convocations were summoned to complete the work of the reformation of the Church of England, which had been begun by Henry VIII.; the third was called together to reconstruct that work, which had been marred on the accession of Mary (the consort of Philip II. of Spain), whilst the fourth was summoned to re-establish the Church of England, the framework of which had been demolished during the great rebellion. On all of these occasions the convocations worked hand in hand with the parliament of the realm under a licence and with the assent of the crown. Meanwhile the convocation of 1603 had framed a body of canons for the governance of the clergy. Another convocation requires a passing notice, in which certain canons were drawn up in 1640, but by reason of an irregularity in the proceedings of this convocation (chiefly, on the ground that its sessions were continued for some time after the parliament of the realm had been dissolved), its canons are not held to have any binding obligation on the clergy. The convocations had up to this time maintained their liberty of voting the subsidies of the clergy in the form of "benevolences" separate and apart from the "aids" granted by the laity in parliament, and one of the objections taken to the proceedings of the convocation of 1640 was that it had continued to sit and to vote its subsidies to the crown after the parliament itself had been dissolved. It is not, therefore, surprising on the restoration of the monarchy in 1661 that the spirituality was not anxious to retain the liberty of taxing itself apart from the laity, seeing that its ancient liberty was likely to prove of questionable advantage to it. It voted, however, a benevolence to the crown on the occasion of its first assembling in 1661 after the restoration of King Charles II., and it continued so to do until 1664, when an arrangement was made between Archbishop Sheldon and Lord Chancellor Hyde, under which the spirituality silently waived its long-asserted

right of voting its own subsidies to the crown, and submitted itself thenceforth to be assessed to the "aids" directly granted to the crown by parliament. An act was accordingly passed by the parliament in the following year 1665, entitled "An act to grant a Royal Aid unto the King's Majesty, to which aid the clergy were assessed by the commissioners named in the statute without any objection being raised on their part or behalf,"<sup>1</sup> there being a proviso that in so contributing the clergy should be relieved of the liability to pay two subsidies out of four, which had been voted by them in the convocation of a previous year. In consequence of this practical renunciation of their separate *status*, as regards their liability to taxation, the clergy have assumed and enjoyed in common with the laity the right of voting at the election of members of the House of Commons, in virtue of their ecclesiastical freeholds.

The most important and the last work of the convocation during this second period of its activity was the revision of the Book of Common Prayer which was completed in the latter part of 1661.

The Revolution in 1688 is the most important epoch in the third period of the history of the synodical proceedings of the spirituality, when the convocation of Canterbury, having met in 1689 in pursuance of a royal writ, obtained a licence under the great seal, to prepare certain alterations in the liturgy and in the canons, and to deliberate on the reformation of the ecclesiastical courts. A feeling, however, of panic seems to have come over the Lower House, which took up a position of violent antagonism to the Upper House. This circumstance led to the prorogation of the convocation and to its subsequent discharge without any practical fruit resulting from the king's licence. Ten years elapsed during which the convocation was prorogued from time to time without any meeting of its members for business being allowed. The next convocation which was permitted to meet for business, in 1700, was marked by great turbulence and insubordination on the part of the members of the Lower House, who refused to recognize the authority of the archbishop to prorogue their sessions. This controversy was kept up until the discharge of the convocation took place concurrently with the dissolution of the parliament in the autumn of that year. The proceedings of the Lower House in this convocation were disfigured by excesses which were clearly violations of the constitutional order of the convocation. The Lower House refused to take notice of the archbishop's schedule of prorogation, and adjourned itself by its own authority, and upon the demise of the crown it disputed the fact of its sessions having expired, and as parliament was to continue for a short time, prayed that its sessions might be continued as a part of the parliament under the "praemunientes" clause. The next convocation was summoned in the first year of Queen Anne, when the Lower House, under the leadership of Dean Aldrich, its prolocutor, challenged the right of the archbishop to prorogue it, and presented a petition to the queen, praying her majesty to call the question into her own presence. The question was thereupon examined by the queen's council, when the right of the president to prorogue both houses of convocation by a schedule of prorogation was held to be proved, and further, that it could not be altered except by an act of parliament. During the remaining years of the reign of Queen Anne the two Houses of convocation were engaged either in internecine strife, or in censuring sermons or books, as teaching latitudinarian or heretical doctrines; and, when it had been assembled concurrently with parliament on the accession of King George I., a great breach was before long created between the two houses by the Bangorian controversy. Dr Hoadly, bishop of Bangor, having preached a sermon before the king, in the Royal Chapel at St James's Palace in 1717, against the principles and practice of the nonjurors, which had been printed

<sup>1</sup> It had always been the practice, when the clergy voted their subsidies in their convocation, for parliament to authorize the collection of each subsidy by the same commissioners who collected the parliamentary aid.



by the king's command, the Lower House, which was offended by the sermon and had also been offended by a treatise on the same subject published by Dr Hoadly in the previous year, lost no time in representing the sermon to the Upper House, and in calling for its condemnation. A controversy thereupon arose between the two houses

*Bangorian controversy.*

which was kept up with untiring energy by the Lower House, until the convocation was prorogued in 1717 in pursuance of a royal writ; from which time until 1861 no licence from the crown was granted to convocation to proceed to business. During this period, which may be regarded as the fourth distinguishing period in the history of the convocations of the Church of England,

*Fourth period.*

it was usual for a few members of the convocation to meet when first summoned with every new parliament. in pursuance of the royal writ, for the Lower House to elect a prolocutor, and for both houses to vote an address to the crown, after which the convocation was prorogued from time to time, pursuant to royal writs, and ultimately discharged when the parliament was dissolved. There were, however, several occasions between 1717 and 1741 when the convocation of the province of Canterbury transacted certain matters, by way of consultation, which did not require any licence from the crown, and there was a short period in its session of 1741 when there was a probability of its being allowed to resume its deliberative functions, as the Lower House had consented to obey the president's schedule of prorogation; but the Lower House having declined to receive a communication from the Upper House, the convocation was forthwith prorogued, from which time until the middle of the 19th century the convocation was not permitted by the crown to enjoy any opportunity even for consultation. The spirituality at last aroused itself from its long repose in 1852, and on this occasion the Upper House took the lead. The active spirit of the movement was Samuel Wilberforce, bishop of Oxford, but the master mind was Henry Phillpotts, bishop of Exeter. On the convocation assembling several petitions were presented to both houses, praying them to take steps to procure from the crown the necessary licence for their meeting for the despatch of business, and an address to the Upper House was brought up from the Lower House, calling the attention of the Upper House to the reasonableness of the prayer of the various petitions. After some discussion the Upper House, influenced mainly by the argument of Henry, bishop of Exeter, consented to receive the address of the Lower House, and the convocation was thereupon prorogued, shortly after which it was discharged concurrently with the dissolution of parliament. On the assembling of the next convocation of the province of Canterbury, no royal writ of exoneration having been sent by the crown to the metropolitan, the sessions of the convocation were continued for several days; and from this time forth convocation may be considered to have resumed its action as a consultative body, whilst it has also been permitted on more than one occasion to exercise its functions as a deliberative body. In 1865, under licence from the crown, the Convocations of Canterbury and York framed new canons in place of the 36th, 37th, 38th and 40th canons of 1603, and amended the 62nd and 102nd canons in 1888. In 1872 convocation was empowered by letters of business from the crown to frame resolutions on the subject of public worship, which resolutions were afterwards incorporated in the Act of Uniformity Amendment Act 1872.

*Fifth period.*

As a deliberative body, convocation has done much useful work, but it suffers considerably from its unrepresentative nature. The non-beneficed clergy still remain without the franchise, but the establishment of Houses of Laymen (see LAYMEN, HOUSES OF) for both provinces has, to a certain extent, secured the co-operation of the lay element. Several attempts have been made to promote legislation to enable the convocations to reform their constitutions and to enable them to unite for special purposes; in 1905 a bill was introduced into the House of Lords. It did not, however, get beyond a first reading. In 1896 a departure was made in holding joint sessions of both convocations, in conjunction with the two Houses of Laymen, for con-

sultative purposes. This body is now termed the Representative Church Council, and it adopted a Constitution in November 1905. All formal business is transacted in the separate convocations. It is usual for convocation to meet three times a year.

The order of convening the convocation of the province of Canterbury is as follows. A writ issues from the crown, addressed to the metropolitan archbishop of Canterbury, commanding him "by reason of certain difficult and urgent affairs concerning us, the security and defence of our Church of England, and the peace and tranquillity, public good and defence of our kingdom, and our subjects of the same, to call together with all convenient speed, and in lawful manner, the several bishops of the province of Canterbury, and deans of the cathedral churches, and also the archdeacons, chapters and colleges, and the whole clergy of every diocese of the said province, to appear before the said metropolitan in the cathedral church of St Paul, London, on a certain day, or elsewhere, as shall seem most expedient, to treat of, agree to and conclude upon the premises and other things, which to them shall then at the same place be more clearly explained on our behalf." In case the metropolitan see of Canterbury should be vacant, the writ of the crown is addressed to the dean and chapter of the metropolitan church of Canterbury in similar terms, as being the guardians of the spiritualities of the see during a vacancy. Thereupon the metropolitan, or, as the case may be, the dean and chapter of the metropolitan church, issue a mandate to the bishop of London, as dean of the province, and if the bishopric of London should be vacant, then to the bishop of Winchester as subdean, which embodies the royal writ, and directs the bishop to cause all the bishops of the province to be cited, and through them the deans of the cathedral and collegiate churches, and the archdeacons and other dignitaries of churches, and each chapter by one, and the clergy of each diocese by two sufficient proctors, to appear before the metropolitan or his commissary, or, as the case may be, before the dean and chapter of the metropolitan church or their commissary, in the chapter-house of the cathedral church of St Paul, London, if that place be named in the mandate, or elsewhere, with continuation and prorogation of days next following, if that should be necessary, to treat upon arduous and weighty affairs, which shall concern the state and welfare, public good and defence of this kingdom and the subjects thereof, to be then and there seriously laid before them, and to give their good counsel and assistance on the said affairs, and to consent to such things as shall happen to be wholesomely ordered and appointed by their common advisement, for the honour of God and the good of the church.

The provincial dean, or the subdean, as the case may be, thereupon issues a citation to the several bishops of the province, which embodies the mandate of the metropolitan or of the dean and chapter of the metropolitan church, as the case may be, and admonishes them to appear, and to cite and admonish their clergy, as specified in the metropolitan mandate, to appear at the time and place mentioned in the mandate. The bishops thereupon either summon directly the clergy of their respective dioceses to appear before them or their commissaries to elect two proctors, or they send a citation to their archdeacons, according to the custom of the diocese, directing them to summon the clergy of their respective archdeaconries to elect a proctor. The practice of each diocese in this matter is the law of the convocation, and the practice varies indefinitely as regards the election of proctors to represent the beneficed clergy. As regards the deans, the bishops send special writs to them to appear in person, and to cause their chapters to appear severally by one proctor. Writs also go to every archdeacon, and on the day named in the royal writ, which is always the day next following that named in the writ to summon the parliament, the convocation assembles in the place named in the archbishop's mandate. Thereupon, after the Litany has been sung or said, and a Latin sermon preached by a preacher appointed by the metropolitan, the clergy are praenotified or summoned by name to appear before the metropolitan or his commissary; after which the clergy of the Lower House are directed to withdraw and elect a prolocutor to be presented to the metropolitan for his approbation. The convocation thus constituted resolves itself at its next meeting into two houses, and it is in a fit state to proceed to business.

The constitution of the convocation of the province of York differs slightly from that of the convocation of the province of Canterbury, as each archdeaconry is represented by two proctors, precisely as in parliament formerly under the *Praemunientes* clause.

There are some anomalies in the diocesan returns of the two convocations, but in all such matters the *consuetudo* of the diocese is the governing rule.

BIBLIOGRAPHY.—Wilkins, *Concilia Magnae Britanniae et Hiberniae* (4 vols. folio, 1737); Gibson, *Codex Juris Ecclesiastici Anglicani* (2 vols. folio, 1713); Johnson, *A Collection of all the Ecclesiastical Laws, Canons and Constitutions of the English Church* (2 vols. 8vo, 1720); Gibson, *Synodus Anglicana* (8vo, 1702, re-edited by Dr Edward Cardwell, 8vo, 1854); Shower, *A Letter to a Convocation Man concerning the Rights, Powers and Privileges of that Body* (4to, 1697); Wake, *The Authority of Christian Princes over their Ecclesiastical Synods asserted, occasioned by a late Pamphlet intituled A Letter*

to a Convocation Man (8vo, 1697); Atterbury, *The Rights, Powers and Privileges of an English Convocation stated and vindicated in answer to a late book of Dr Wake's* (8vo, 1700); Burnet, *Reflections on a Book intituled The Rights, Powers and Privileges of an English Convocation stated and vindicated* (4to, 1700); Kennet, *Ecclesiastical Synods and Parliamentary Convocations of the Church of England historically stated and justly vindicated from the Misrepresentation of Mr Atterbury* (8vo, 1701); Atterbury, *The Power of the Lower House of Convocation to adjourn itself* (4to, 1701); Gibson, *The Right of the Archbishop to continue or prorogue the whole Convocation* (4to, 1701); Kennet, *The Case of the Praemunientes* (4to, 1701); Hooper, *The Narrative of the Lower House vindicated from the Exceptions of a Letter, intituled The Right of the Archbishop to continue or prorogue the Convocation* (4to, 1702); Atterbury, *The Case of the Schedule stated* (4to, 1702); Gibson, *The Schedule Reviewed, or the Right of the Archbishop to continue or prorogue the whole Convocation, cleared from the Exception of a late Vindication of the Narrative of the Lower House, and of a Book intituled The Case of the Schedule stated* (4to, 1702); Hody, *A History of the English Councils and Convocation, and of the Clergy's sitting in Parliament* (8vo, 1702); Wake, *The State of the Church and Clergy of England in their Councils, Synods, Convocations, Conventions, and other Public Assemblies, occasioned by a book intituled The Rights, Powers and Privileges of an English Convocation* (fol., 1703); Burnet, *History of His Own Time* (2 vols. folio, 1734), re-edited by Dr Martin J. Routh (6 vols. 8vo, 1833); Hallam, *Constitutional History of England* (3 vols. 8vo, 1832); Cardwell, *Documentary Annals of the Reformed Church of England* (2 vols., 1839); Cardwell, *A History of Conferences and other Proceedings connected with the revision of the Common Prayer* (8vo, 1841); Cardwell, *Synodalia, a Collection of Articles of Religion, Canon and Proceedings of Convocation in the Province of Canterbury* (2 vols. 8vo, 1842); Lathbury, *A History of the Convocation of the Church of England* (2nd ed., 8vo, 1853); Trevor, *The Convocation of the two Provinces* (8vo, 1852); Pearce, *The Law relating to Convocations of the Clergy* (8vo, 1848); *Synodalia*, a Journal of Convocation, commenced in 1852 (8vo); *The Chronicle of Convocation*, being a record of the proceedings of the Convocation of Canterbury, commenced in 1863 (8vo). (T. T.; T. A. I.)

**CONVOLVULACEAE**, a botanical natural order belonging to the series Tubiflorae of the sympetalous group of Dicotyledons. It contains about 40 genera with more than 1000 species, and is found in all parts of the world except the coldest, but is especially well developed in tropical Asia and tropical America. The most characteristic members of the order are twining plants with generally smooth heart-shaped leaves and large showy white or purple flowers, as, for instance, the greater bindweed of English hedges, *Calystegia sepium*, and many species of the genus *Ipomaea*, the largest of the order, including the "convolvulus major" of gardens, and morning glory. The creeping or trailing type is a common one, as in the English bindweed (*Convolvulus arvensis*), which has also a tendency to climb, and *Calystegia Soldanella*, the sea-bindweed, the long creeping stem of which forms a sand-binder on English seashores; a widespread and efficient tropical sand-binder is *Ipomaea Pes-Caprae*. One of the commonest tropical weeds, *Evolvulus alsinoides*, has slender, long-trailing stems with small leaves and flowers. In hot dry districts such as Arabia and north-east tropical Africa, genera have been developed with a low, much-branched, dense, shrubby habit, with small hairy leaves and very small flowers. An exceptional type in the order is represented by *Humbertia*, a native of Madagascar, which forms a large tree. The dodder (*q.v.*) is a genus (*Cuscuta*) of leafless parasites with slender thread-like twining stems. The flowers stand singly in the leaf-axils or form few or many flowered cymose inflorescences; the flowers are sometimes crowded into small heads. The bracts are usually scale-like, but sometimes foliaceous, as for instance in *Calystegia*, where they are large and envelop the calyx.

The parts of the flower are in fives in calyx, corolla and stamens, followed by two carpels which unite to form a superior ovary. The sepals, which are generally free, show much variation in size, shape and covering, and afford valuable characters for the distinction of genera or sub-genera. The corolla is generally funnel-shaped, more rarely bell-shaped or tubular; the outer face is often marked out in longitudinal areas, five well-defined areas tapering from base to apex, and marked with longitudinal striae corresponding to the middle of the petals, and alternating with five non-striated weaker triangular areas; in the bud the latter are folded inwards, the stronger areas being exposed and showing a twist to the right. The slender filaments of the stamens vary

widely, often in the same flower; the anthers are linear to ovate in shape, attached at the back to the filament, and open lengthwise. Some importance attaches to the form of the pollen grains; the two principal forms are ellipsoidal with longitudinal bands forming the *Convolvulus*-type, and a spherical form with a spiny surface known as the *Ipomaea*-type. The ovary is generally two-chambered, with two inverted ovules standing side by side at the inner angle of each chamber. The style is simple or branched, and the stigma is linear, capitate or globose in form; these variations afford means for distinguishing the different genera. The fruit is usually a capsule opening by valves; the seeds, where four are developed, are each shaped like the quadrant of a sphere; the seed-coat is smooth, or sometimes warty or hairy; the embryo is large with generally broad, folded, notched or bilobed cotyledons surrounded by a horny endosperm. *Cuscuta* has a thread-like, spirally twisted embryo with no trace of cotyledons.

The large showy flowers are visited by insects for the honey which is secreted by a ring-like disk below the ovary; large-

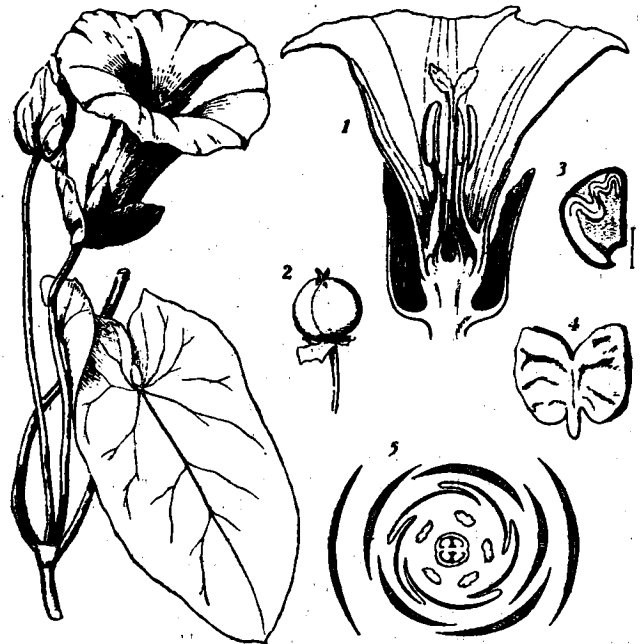

*Convolvulus sepium*, slightly reduced.

1. Flower cut vertically.
2. Fruit, slightly reduced.
3. Seed cut lengthwise showing embryo.
4. Embryo taken out of seed.
5. Horizontal plan of arrangement of flower.

flowered species of *Ipomaea* with narrow tubes are adapted for the visits of honey-seeking birds.

The largest genus, *Ipomaea*, has about 400 species distributed throughout the warmer parts of the earth. *Convolvulus* has about 150 to 200 species, mainly in temperate climates; the genus is principally developed in the Mediterranean area and western Asia. *Cuscuta* contains nearly 100 species in the warmer and temperate regions; two are native in Britain.

The tubers of *Ipomaea Batatas* are rich in starch and sugar, and, as the "sweet potato," form one of the most widely distributed foods in the warmer parts of the earth. Several members of the order are used medicinally for the strong purging properties of the milky juice (latex) which they contain; scammony is the dried latex from the underground stem of *Convolvulus Scammonia*, a native of the Levant, while jalap is the product of the tubercles of *Exogonium Purga*, a native of Mexico. Species of *Ipomaea* (morning glory), *Convolvulus* and *Calystegia* are cultivated as ornamental plants. *Convolvulus arvensis* (bindweed) is a pest in fields and gardens on account of its wide-spreading underground stem, and many of the dodders (*Cuscuta*) cause damage to crops.

**CONVOY** (through the Fr. from late Lat. *conviare*, to go along with, from Lat. *cum*, with, and *via*, way; "convey" has the same ultimate origin [see CONVEYANCE], neither word being

connected, as has sometimes been supposed, with Lat. *convohere*, to carry together), a verb and noun now almost exclusively used in military and naval parlance. As a verb it signifies in the first instance to accompany or to escort; and in the 17th century we even hear of cavalry "convoying" infantry, but its meaning was soon complicated by the growing use of the word "convoy" in the sense of "to carry," and as the usual task of an escort was that of accompanying and protecting vehicles containing supplies, the noun "convoy" (Fr. *convoy*) was introduced and has thenceforward in land warfare meant a train of vehicles containing stores for the use of troops and its guard or escort. Sometimes even the word is found in the meaning of the train of vehicles without implying that there is an escort, so far has the original meaning become obscured; but the idea of military protection is always present, whether this protection is given by a separate escort or provided by the weapons of the drivers themselves.

In naval warfare the term is used to describe a method adopted for defending merchant ships against capture. It was usually applied to the vessels to be protected—as for example "the Baltic convoy," or "Captain Montray's convoy." Until the 17th century the English term was "to waft" and the warship employed to guard the traders on their way was called "a wafter." The practice of sailing in convoy for mutual protection was common in the middle ages, when all ships were more or less armed and the war vessel was not entirely differentiated from the trader. Thus the ships of the great German confederation of cities known as the Hanseatic League were required to sail in convoy. So were the six trading squadrons which sailed yearly from Venice. The masters of all the vessels were required to obey the authority of an officer who had the general command. In the 16th century the Spanish trade with America was compelled by law to sail in convoys (*flotas*), in order to avoid the danger of capture by pirates to which single ships were exposed. In the 17th and 18th centuries the use of convoy was universal. Dutch, French or British ships were collected at a rendezvous, and were accompanied by warships till they reached the point at which they were compelled to separate in order to go to their various destinations. The main danger was near the enemy's ports. An example of the way the duty was discharged may be found in the Newfoundland convoy. They sailed from England under the direction of a naval officer and the protection of his ships, commonly a forty- or fifty-gun ship with a smaller vessel in attendance. The convoy sailed to the banks of Newfoundland. When they had filled up with stock fish, they were escorted across the Atlantic by the same officer. He accompanied those of them bound to the Mediterranean to the port of Leghorn, and, when they had unloaded and reloaded, saw them home. All cases were not so simple. The ships engaged in the East and West India trade, for instance, sailed together. In the Channel they were protected by the main strength of the fleet. When beyond the Scilly Islands they were left to the care of a smaller force, and continued together till in the neighbourhood of Madeira, when they separated. Convoys were subject to attack in two forms, by strong squadrons which overpowered the guard, and by privateers, corsairs and isolated cruisers. This latter peril was much increased in the case of British commerce by the reluctance of the merchant captains to obey the naval officers. They were very much inclined to separate from the convoy as they approached their destination in the hope of forestalling rivals. As a natural consequence they were frequently captured by hostile privateers. French naval officers had authority and large powers of punishment over merchant skippers. The British naval officers had not. In 1803-34, on the renewal of the war with France, the British government saw the necessity for regulating convoy more strictly than had hitherto been the case. It therefore passed "an act for the better protection of the trade of the United Kingdom during the present hostilities with France." By this act (the 43rd Geo. III. Cap. 57) all vessels not exempted by special licence were required to sail in convoy and to conform to strict regulations, under penalties of £1000 (or, when the goods included government stores, of £1500) and the loss of all claim to insurance in case of capture. (D. H.)

The object of convoying is to attach an official public character to the convoyed ships, *i.e.* a sort of assimilation of them to the escorting ship or ships of war. Thus European states and jurists hold that the declaration of the commander of the convoy, that there is no contraband of war on board the convoyed ships, pledges the national good faith, and must be assumed to be correct in the same way as it is assumed that the convoy itself is carrying no contraband of war. Great Britain has never taken this view. Down to 1907 she had maintained that it is materially impossible for any neutral state to exercise the necessary supervision to secure absolute accuracy of the ship's papers. Number 29, however, of the instructions given by the government to the British plenipotentiaries at the Hague Conference of 1907 stated that "H.M. government would . . . be glad to see the right of search limited in every practicable way, *e.g.* by the adoption of a system of consular certificates declaring the absence of contraband from the cargo. . . ." As the greater includes the smaller, we may assume that, if a consular certificate might suffice to exempt from the exercise of search, the state guarantee of a convoy would certainly suffice. The London Convention on the Laws and Customs of Naval War has laid down the rules as to convoys in the following terms:

Neutral vessels under national convoy are exempt from search. The commander of a convoy gives, in writing, at the request of the commander of a belligerent warship, all information as to the character of the vessels and their cargoes, which could be obtained by search.—Art. 61.

If the commander of the belligerent warship has reason to suspect that the confidence of the commander of the convoy has been abused, he communicates his suspicions to him. In such a case it is for the commander of the convoy alone to investigate the matter. He must record the result of such investigation in a report, of which a copy is handed to the officer of the warship. If, in the opinion of the commander of the convoy, the facts shown in the report justify the capture of one or more vessels, the protection of the convoy must be withdrawn from such vessels.—Art. 62. (T. B.A.)

**CONVULSIONS**, the pathological condition of body associated with abnormal, violent and spasmodic contractions and relaxations of the muscles, taking the form of a fit. Convulsions may be a symptom resulting from various diseases, but the term is commonly restricted to the infantile variety, occurring in association with teething, or other causes which upset the child's nervous system. The treatment (plunging into a hot bath, or administration of chloroform) must be prompt, as convulsions are responsible for a large part of infant mortality.

The name "Convulsionaries" (Fr. *Convulsionnaires*) was given to certain Jansenist fanatics in France in the 18th century, owing to the convulsions, regarded by them as proofs of divine inspiration, which were the result of their religious ecstasies (see **JANSENISM**). The term "Convulsionists" is sometimes applied to them, as also, more loosely, to other religious enthusiasts who exhibit the same symptoms.

**CONWAY, HENRY SEYMOUR** (1721-1795), English field marshal and statesman, was the second son of Francis Seymour, of Ragley, Warwickshire, who took the name of Conway on succeeding to the estates of the earl of Conway in 1699 and was created Baron Conway in 1703 (see **SEYMOUR** or **ST MAUR**). Henry Seymour Conway's elder brother, Francis, 2nd Baron Conway, was created marquess of Hertford in 1793; his mother was a sister of Sir Robert Walpole's wife, and he was therefore first cousin to Horace Walpole, with whom he was on terms of intimate friendship throughout his life. Having entered the army at an early age, Conway was elected to the Irish parliament in 1741 as member for Antrim, which he continued to represent for twenty years; in the same year he became a member of the English House of Commons, sitting for Higham Ferrers in Northamptonshire, and he remained in parliament, representing successively a number of different constituencies, almost without interruption for more than forty years. Meantime he saw much service in the army abroad, where he served with conspicuous bravery and not without distinction. In 1745 he became aide-de-camp to the duke of Cumberland in Germany, and was present at Fontenoy; in the following year he had command of a regiment at Culloden. In 1755 he went to Ireland as secretary

to the lord-lieutenant, a position which he held for one year only; and on his return to England he received a court appointment, having already been promoted major-general. In 1757 he was associated with Sir John Mordaunt in command of an abortive expedition against Rochfort, the complete failure of which brought Conway into discredit and involved him in a pamphlet controversy. In 1759 he became lieutenant-general, and served under Prince Ferdinand of Brunswick in the campaigns of 1761–1763. Returning to England he took part in the debates in parliament on the Wilkes case, in which he opposed the views of the court, speaking strongly against the legality of general warrants. His conduct in this matter highly incensed the king, who insisted on Conway being deprived of his military command as well as of his appointment in the royal household. His dismissal along with other officers was the occasion of another paper controversy in which Conway was defended by Horace Walpole, and gave rise to much constitutional dispute as to the right of the king to remove military officers for their conduct in parliament—a right that was tacitly abandoned by the Crown when the Rockingham ministry of 1765 reinstated the officers who had been removed.

In this ministry Conway took office as secretary of state, with the leadership of the House of Commons. In the dispute with the American colonies his sympathies were with the latter, and in 1766 he carried the repeal of the Stamp Act. When in July of that year Rockingham gave place to Chatham, Conway retained his office; and when Chatham became incapacitated by illness he tamely acquiesced in Townshend's reversal of the American policy which he himself had so actively furthered in the previous administration. In January 1768, offended by the growing influence of the Bedford faction which joined the government, Conway resigned the seals of office, though he was persuaded by the king to remain a member of the cabinet and "Minister of the House of Commons." When, however, Lord North became premier in 1770, Conway resigned from the cabinet and was appointed to the command of the royal regiment of horse guards; and in 1772 he became governor of Jersey, the island being twice invaded by the French during his tenure of command. In 1780 and 1781 he took an active part in opposition to Lord North's American policy, and it was largely as the result of his motion on the 22nd of February in the latter year, demanding the cessation of the war against the colonies, when the ministerial majority was reduced to one, that Lord North resigned office. In the Rockingham government that followed General Conway became commander-in-chief with a seat in the cabinet; and he retained office under Shelburne when Rockingham died a few months later. On Pitt's elevation to the premiership, Conway supported Fox in opposition; but after the dissolution of parliament in 1784 he retired from political life. He was made field marshal in 1793, and died at Henley-on-Thames on the 9th of July 1795. Conway married in 1747 Caroline, daughter of General Campbell (afterwards duke of Argyll), and widow of the earl of Aylesbury. He had one daughter, Anne, who married John Damer, son of Lord Milton, and who inherited a life interest in Strawberry Hill under the will of Horace Walpole.

Conway was personally one of the most popular men of his day. He was handsome, conciliatory and agreeable, and a man of refined taste and untarnished honour. As a soldier he was a dashing officer, but a poor general. He was weak, vacillating and ineffective as a politician, lacking in judgment and decision, and without any great parliamentary talent. In his later years he dabbled in literature and the drama, and interested himself in arboriculture in his retirement at Henley-on-Thames.

See Horace Walpole, *Letters*, edited by P. Cunningham (9 vols., London, 1857), many of the letters being addressed to Conway; *Memoirs of the Last Ten Years of the Reign of George II.* (2 vols., London, 1822); *Memoirs of the Reign of George III.*, edited by Sir D. le Marchant (4 vols., London, 1845); *Journal of the Reign of George III.*, 1771–1783 (2 vols., London, 1859). See also the duke of Buckingham and Chandos, *Memoirs of the Court and Cabinets of George III.* (4 vols., London, 1853). Much information about Conway will also be found in the biographies of his leading contemporaries, Rockingham, Shelburne, Chatham, Pitt and Fox.

(R. J. M.)

**CONWAY, HUGH**, the nom-de-plume of **FREDERICK JOHN FARGUS** (1847–1885), English novelist, who was born at Bristol on the 26th of December 1847, the son of an auctioneer. He was intended for his father's business, but at the age of thirteen joined the training-ship "Conway" in the Mersey. In deference to his father's wishes, however, he gave up the idea of becoming a sailor, and returned to Bristol, where he was articled to a firm of accountants till on his father's death in 1868 he took over the family business. While a clerk he had written the words for various songs, adopting the nom-de-plume Hugh Conway in memory of his days on the training-ship. Mr Arrowsmith, the Bristol printer and publisher, took an interest in his work, and Fargus's first short story appeared in *Arrowsmith's Miscellany*. In 1883 Fargus published through Arrowsmith his first long story, *Called Back*, of which over 350,000 copies were sold within four years. A dramatic version of this book was produced in London in 1884, and in this year Fargus published another story, *Dark Days*. Ordered to the Riviera for his health, he caught typhoid fever, and died at Monte Carlo on the 15th of May 1885. Several other books from his pen appeared posthumously, notably *A Family Affair*.

**CONWAY, MONCURE DANIEL** (1832–1907), American clergyman and author, was born of an old Virginia family in Stafford county, Virginia, on the 17th of March 1832. He graduated at Dickinson College in 1849, studied law for a year, and then became a Methodist minister in his native state. In 1852, owing largely to the influence of Ralph Waldo Emerson, his religious and political views underwent a radical change, and he entered the Harvard Divinity School, where he graduated in 1854. Here he fell under the influence of "transcendentalism," and became an outspoken abolitionist. On his return to Virginia this fact and his rumoured connexion with the attempt to rescue the fugitive slave, Anthony Burns, in Boston aroused the bitter hostility of his old neighbours and friends, and in consequence he left the state. In 1854–1856 he was pastor of a Unitarian church at Washington, D.C., but his anti-slavery views brought about his dismissal. From 1856 to 1861 he was a Unitarian minister in Cincinnati, Ohio, where, also, he edited a short-lived liberal periodical called *The Dial*. Subsequently he was an editor of the *Commonwealth* in Boston, Mass., and wrote *The Rejected Stone* (1861) and *The Golden Hour* (1862), both powerful pleas for emancipation. In 1862–1863, during the Civil War, he lectured in England in behalf of the North. From 1863 to 1884 he was the minister of the South Place chapel, Finsbury, London; and during this time wrote frequently for the London press. In 1884 he returned to the United States to devote himself to literary work. In addition to those above mentioned, his publications include *Tracts for To-day* (1858), *The Natural History of the Devil* (1859), *Testimonies Concerning Slavery* (1864), *The Earthward Pilgrimage* (1870), *Republican Superstitions* (1872), *Idols and Ideals* (1871), *Demonology and Devil Lore* (2 vols., 1878), *A Necklace of Stories* (1879), *Thomas Carlyle* (1881), *The Wandering Jew* (1881), *Emerson at Home and Abroad* (1882), *Pine and Palm* (2 vols., 1887), *Life and Papers of Edmund Randolph* (1888), *The Life of Thomas Paine* with an unpublished sketch of Paine by William Cobbett (2 vols., 1892), *Solomon and Solomonic Literature* (1899), his *Autobiography* (2 vols., 1900), and *My Pilgrimage to the Wise Men of the East* (1906). Conway died on the 15th of November 1907.

**CONWAY, SIR WILLIAM MARTIN** (1856– ), English art critic and mountaineer, son of the Rev. William Conway, afterwards canon of Westminster, was born at Rochester, and was educated at Repton and at Trinity College, Cambridge. He became interested in early printing and engraving, and in 1880 made a tour of the principal libraries of Europe in pursuit of his studies, the result appearing in 1884 as a *History of the Woodcutters of the Netherlands in the Fifteenth Century*. His later works on art included *Early Flemish Artists* (1887); *The Literary Remains of Albrecht Dürer* (1889); *The Dawn of Art in the Ancient World* (1891), dealing with Chaldaean, Assyrian and Egyptian art; *Early Tuscan Artists* (1902). From 1884 to 1887 he was professor of art at University College, Liverpool; and in

1901-1904 he was Slade professor of the fine arts at Cambridge. He was knighted in 1895. Sir Martin Conway early became a member of the Alpine Club, of which he was president from 1902 to 1904. In 1892 he beat the climbing record by ascending to a height of 23,000 ft. in the Himalayas in the course of an exploring and mountaineering expedition undertaken under the auspices of the Royal Society, the Royal Geographical Society and the British Association. In 1896-1897 he explored the interior of Spitsbergen, and in the next year he explored and surveyed the Bolivian Andes, climbing Sorata (21,500 ft.) and Illimani (21,200 ft.). He also ascended Aconcagua (23,080 ft.) and explored Tierra del Fuego. At the Paris exhibition of 1900 he received the gold medal for mountain surveys, and the founder's medal of the Royal Geographical Society in 1905. His expeditions are described in his *Climbing and Exploration in the Karakoram Himalayas* (1894), *The Alps from End to End* (1895), *The First Crossing of Spitsbergen* (1897), *The Bolivian Andes* (1901), &c.; *No Man's Land, a History of Spitsbergen from . . . 1596 . . .* was published in 1906.

**CONWAY** (*Conwy*, or *Aberconwy*), a municipal borough in the Arfon parliamentary division of Carnarvonshire, N. Wales, 14 m. by the London & North-Western railway from Bangor, and 225 m. N.W. from London. Pop. (1901) 4681. The town is enclosed by a high wall, roughly triangular, about 1 m. round, with twenty-one dilapidated round towers, pierced by three principal gateways with two strong towers. The castle in the south-east angle, built in 1284 by Edward I., was inhabited, in 1389, by Richard II., who here agreed to abdicate. Held for Charles I. by Archbishop Williams, it was taken by General Mytton in 1646. Dismantled by the new proprietor, Earl Conway, it remains a ruin. It is oblong, with eight massive towers, and has, within, a hall 130 ft. in length, known as Llewelyn's. The parliamentary borough of Conway, returning, with five other towns, one member, extends over to the right bank of the stream Conwy (Conway). In 1885 the mayor of Conway was made a constable. Llandudno with Great and Little Orme's Heads are at some 4 m. distance. Two bridges, a tubular for the railway (40 ft. shorter than that of the Menai) and a suspension, designed by Stephenson (1846-1848) and Telford (1822-1826) respectively, cross the stream. St Mary's church is Gothic; the Elizabethan Plas Mawr is the *locale* of the Royal Cambrian Academy of Art. There are still some fragments of the 1185 Cistercian Abbey. There are golf links here and at Llandudno. The Conwy stream, on which a steambot runs from Deganwy (2 m. below Conway town) to Trefriw, opposite Llanrwst, in summer, has some coasting trade in sulphur and slates. It is about 30 m. long, its valley (a haunt of artists) containing the towns last mentioned and Bettws y coed. Its pearls are mentioned in Drayton's *Polyolbion* and Spenser's *Faerie Queen*. Pearl fisheries existed at Conway for many centuries, dating back to the Roman occupation. Tacitus, *Agricola*, 12, says of Britain "gignit et Oceanus margarita, sed subfusca ac liventia," as are those found to-day. Diganhwy (Dyganwy, Deganwy) is mentioned in the *Mabinogion* (*Geraint and Ehid*), if the reading is sound; it is certainly mentioned in the *Annales Cambriae* (years 812-822) and in the *Black Book of Caerfyrddin* (Carmarthen), xxiii. 1. Caer-hyn, 4½ m. from Conway, is on the highroad from London to Holyhead, and is the *Conovium* of the Romans. The site of the camp can still be traced, consisting of a square, strengthened by four parallel walls, extending to a distance from the main work. The camp is on a height, with the Conwy in front and a wood on each flank. At the foot of the hill, near the stream, was a Roman bath, with walls, pavement and pillars. Camden's *Britannia* mentions tiles, with marks of the 10th or Antoninus's legion, as being found here, perhaps mistakenly. *Gleini nadroedd* (possibly amulets) and *vitrum* have been found here. In Bwlch y ddwy faen ("two rock ravine"), on the way to Aber, are the remains of a Roman road and antiquities.

**CONYBEARE, WILLIAM DANIEL** (1787-1857), dean of Llandaff, one of the most distinguished of English geologists, who was born in London on the 7th of June 1787, was a grandson of John Conybeare, bishop of Bristol (1692-1755), a notable preacher

and divine, and son of Dr William Conybeare, rector of Bishops-gate. Educated first at Westminster school, he went in 1805 to Christ Church, Oxford, where in 1808 he took his degree of B.A., with a first in classics and second in mathematics, and proceeded to M.A. three years later. Having entered holy orders he became in 1814 curate of Wardington, near Banbury, and he accepted also a lectureship at Brislington near Bristol. During this period he was one of the founders of the Bristol Philosophical Institution (1822). He was rector of Sully in Glamorganshire from 1823 to 1836, and vicar of Axminster from 1836 to 1844. He was appointed Bampton lecturer in 1839, and was instituted to the deanery of Llandaff in 1845. Attracted to the study of geology by the lectures of Dr John Kidd (*q.v.*) he pursued the subject with ardour. As soon as he had left college he made extended journeys in Britain and on the continent, and he became one of the early members of the Geological Society. Both Buckland and Sedgwick acknowledged their indebtedness to him for instruction received when they first began to devote attention to geology. To the *Transactions of the Geological Society* as well as to the *Annals of Philosophy* and *Philosophical Magazine* he contributed many geological memoirs. In 1821 he distinguished himself by the description of a skeleton of the *Plesiosaurus*, discovered by Mary Anning, and his account has been confirmed in all main points by subsequent researches. Among his most important memoirs is that on the south-western coal district of England, written in conjunction with Dr Buckland, and published in 1824. He wrote also on the valley of the Thames, on Elie de Beaumont's theory of mountain-chains, and on the great landslip which occurred near Lyme Regis in 1839 when he was vicar of Axminster. His principal work, however, is the *Outlines of the Geology of England and Wales* (1822), being a second edition of the small work issued by William Phillips (*q.v.*) and written in co-operation with that author. The original contributions of Conybeare formed the principal portion of this edition, of which only Part I., dealing with the Carboniferous and newer strata, was published. It affords evidence throughout of the extensive and accurate knowledge possessed by Conybeare; and it exercised a marked influence on the progress of geology in this country. He was a fellow of the Royal Society and a corresponding member of the Institute of France. In 1844 he was awarded the Wollaston medal by the Geological Society of London. The loss of his eldest son, W. J. Conybeare, preyed on his mind and hastened his end. He died at Itchenstoke, near Portsmouth, a few months after his son, on the 12th of August 1857. (Obituary in *Gent. Mag.* Sept. 1857, p. 335.)

His elder brother JOHN JOSIAS CONYBEARE (1779-1824), also educated at Christ Church, Oxford, and an accomplished scholar, became vicar of Batheaston, and was professor of Anglo-Saxon and afterwards of poetry at Oxford. He likewise was an ardent student of geology and communicated several important papers to the *Annals of Philosophy* and the *Transactions of the Geological Society* of London. (Obituary in *Ann. Phil.* vol. viii., Sept. 1824, p. 162.)

**CONYBEARE, WILLIAM JOHN** (1815-1857), English divine, son of Dean W. D. Conybeare, was born on the 1st of August 1815, and was educated at Westminster and at Trinity College, Cambridge, where he was elected fellow in 1837. From 1842 to 1848 he was principal of the Liverpool Collegiate Institution, which he left for the vicarage of Axminster. He published *Essays, Ecclesiastical and Social*, in 1856, and a novel, *Perversion, or the Causes and Consequences of Infidelity*, but is best known as the joint author (with J. S. Howson) of *The Life and Epistles of St Paul* (1851). He died at Weybridge in 1857.

**COODE, SIR JOHN** (1816-1892), English engineer, was born at Bodmin, Cornwall, on the 11th of November 1816, the son of a solicitor. After considerable experience as an engineer in the west of England he came to London, and from 1844-1847 had a consulting practice in Westminster. In the latter year he was appointed resident engineer in charge of the extensive national harbour works at Portland then in progress. In 1856 he was appointed engineer-in-chief of this undertaking, and this post he retained till the completion of the works in 1872. His



services at Portland were rewarded with a knighthood. He was now recognized as the leading authority on harbour construction, and his advice was sought by many of the colonial governments, especially by those of South Africa and Australia, and by the Indian government. After the Portland harbour his best-known work is the harbour of Colombo, Ceylon. He was made a K.C.M.G. in 1886. From 1884 till his death he was a member of the Suez Canal Commission, and from 1889-1891 president of the Institution of Civil Engineers. He died at Brighton on the 2nd of March 1892.

**COOK, ALBERT STANBURROUGH** (1853- ), American scholar, was born on the 6th of March 1853 in Montville, Morris county, New Jersey. He graduated at Rutgers College in 1872, and also studied at Yale, Göttingen and Leipzig (1877-1878), and, after spending the years 1879-1881 as associate in English at Johns Hopkins University, in London, and under Sievers at Jena, he became in 1882 professor of English in the University of California, and in 1889 professor of English language and literature in Yale University. He re-organized the teaching of English in the state of California, and edited many texts for reading in secondary schools; but he is best known for his work in Old English and in poetics. He translated, edited, and revised Sievers' *Old English Grammar* (1885), edited *Judith* (1888), *The Christ of Cynewulf* (1900), *Asser's Life of King Alfred* (1905), and *The Dream of the Rood* (1905), and prepared *A First Book in Old English Grammar* (1894). He also edited, with annotations, *Sidney's Defense of Poesie* (1890); *Shelley's Defense of Poetry* (1891); *Newman's Poetry* (1891); *Addison's Criticisms on Paradise Lost* (1892); *The Art of Poetry* (1892), being the essays of Horace, Vida and Boileau; and *Leigh Hunt's What is Poetry* (1893); and published *Higher Study of English* (1906).

**COOK, EDWARD DUTTON** (1829-1883), English dramatic critic and author, was born in London on the 30th of January 1829, the son of a solicitor. He was educated at King's College school, London, and, after four years in his father's office, obtained a situation in the London office of a railway company, at first utilizing only his spare time in literary work, but eventually devoting himself entirely to literature. He was dramatic critic of the *Pall Mall Gazette* from 1867 to 1875, and of the *World* from 1875 till his death. He also wrote freely on art topics, and was the author of several novels. He died in London on the 11th of September 1883.

**COOK, ELIZA** (1818-1889), English author, was born on the 24th of December 1818, in Southwark, being the daughter of a local tradesman. She was self-taught, and began when a girl to write poetry for the *Weekly Dispatch* and *New Monthly*. In 1838 she published *Melania and other Poems*, and from 1849 to 1854 conducted a paper for family reading called *Eliza Cook's Journal*. She also published *Jottings from my Journal* (1860), and *New Echoes* (1864); and in 1863 she was given a civil list pension of £100 a year. As the author of a single poem, "The Old Armchair," Eliza Cook's name was for a generation after 1838 a household word both in England and in America, her kindly domestic sentiment making her a great favourite with the working-class and middle-class public. She died at Wimbledon on the 23rd of September 1889.

**COOK, JAMES** (1728-1779), English naval captain and explorer, was born on the 28th of October 1728, at Marton village, Cleveland, Yorkshire, where his father was first an agricultural labourer and then a farm bailiff. At twelve years of age he was apprenticed to a haberdasher at Staithes, near Whitby, and afterwards to Messrs Walker, shipowners, of Whitby, whom he served for years in the Norway, Baltic and Newcastle trades.

In 1755, having risen to be a mate, Cook joined the royal navy, and after four years' service was, on the recommendation of Sir Hugh Palliser, his commander, appointed master successively of the sloop "Grampus," of the "Garland" and of the "Solebay," in the last of which he served in the St Lawrence. He was employed also in sounding and surveying the river, and he published a chart of the channel from Quebec to the sea. In 1762 he was present at the recapture of Newfoundland, and was

employed in surveying portions of this coast (especially Placentia Harbour); in 1763, on Palliser becoming governor of Newfoundland, Cook was appointed "marine surveyor of the coast of Newfoundland and Labrador"; this office he held till 1767; and the volumes of sailing directions he now brought out (1766-1768) showed remarkable abilities. At the same time he began to make his reputation as a mathematician and astronomer by his observation of the solar eclipse of the 5th of August 1766, at one of the Burgeo Islands, near Cape Ray, and by his account of the same in the *Philosophical Transactions* (vol. lvii. pp. 215-216).

In 1768 Cook was appointed to conduct an expedition, suggested by the revival of geographical interest now noticeable, and resolved on by the English admiralty at the instance of the Royal Society, for observing the impending transit of Venus, and prosecuting geographical researches in the South Pacific Ocean. For these purposes he received a commission as lieutenant (May 25th), and set sail in the "Endeavour," of 370 tons, accompanied by several men of science, including Sir Joseph Banks (August 25th). On the 13th of April 1769, he reached Tahiti, where he observed the transit on the 3rd of June. From Tahiti he sailed in quest of the great continent then supposed to exist in the South Pacific, explored the Society Islands, and thence struck to New Zealand, whose coasts he circumnavigated and examined with great care for six months, charting them for the first time with fair accuracy, and especially observing the channel ("Cook Strait") which divided the North and South Islands. His attempts to penetrate to the interior, however, were thwarted by native hostility. From New Zealand he proceeded to "New Holland" or Australia, and surveyed with the same minuteness and accuracy the whole east coast. New South Wales he named after a supposed resemblance to Glamorganshire; Botany Bay, sighted on the 28th of April 1770, was so called by the naturalists of the expedition. On account of the hostility of the natives his discoveries here also were confined to the coast, of which he took possession for Great Britain. From Australia Cook sailed to Batavia, satisfying himself upon the way that (as Torres had first shown in 1607) New Guinea was in no way an outlying part of the greater land mass to the south.

Arriving in England, by way of the Cape of Good Hope, on the 12th of June, Cook was made a commander, and soon after was appointed to command another expedition for examining and determining once for all the question of the supposed great southern continent. With the "Resolution" of 462 tons, the "Adventure" (Captain Furneaux) of 330 tons, and 193 men, he sailed from Plymouth on the 13th of July 1772; he touched at the Cape of Good Hope, and striking thence south-east (November 22nd) passed the Antarctic Circle (January 16th, 1773), repassed the same, and made his way to New Zealand (March 26th) without discovering land. From New Zealand he resumed his "search for a continent," working up and down across the South Pacific, and penetrating to 67° 31' and again to 71° 10' S., with imminent risk of destruction from floating ice, but with the satisfaction of disproving the possibility of the disputed continent in the seas south-eastward of New Zealand. He then made for Easter Island, whose exact position he determined, for the first time, with accuracy; noticing and describing the gigantic statues which Roggwein, the first discoverer of the island, had made known. In the same manner he accomplished a better determination and examination of the Marquesas, as well as of the Tonga or Friendly Islands, than had yet been made; and after a stay at Tahiti to rest and refit, crossed the central Pacific to the "New Hebrides," as he renamed Quiros's "Southern Land of the Holy Spirit" (a name preserved in the modern island of *Espiritu Santo*), called by Bougainville the "Great Cyclades" (*Grandes Cyclades*), whose position, extent, divisions and character were now verified as never before. Next followed the wholly new discoveries of New Caledonia, Norfolk Island, and the Isle of Pines. Another visit to New Zealand, and yet another examination of the far southern Pacific, which was crossed from west to east through the whole of its extent, from south Australia to Tierra del Fuego, were now undertaken by

Cook before he finally closed his work in refutation of the Antarctic continent, as previously understood, on this side of the world. The voyage closed with a rapid survey of the "Land of Fire," the rounding of Cape Horn, the rediscovery of the island now named Southern Georgia, the discovery of Sandwich Land, the crossing of the South Atlantic (here also exploding the great *Terra Australis* delusion), and visits to the Cape of Good Hope, St Helena, Ascension, Fernando Noronha and the Azores. The voyage (reckoning only from the Cape of Good Hope and back to the same) had covered considerably more than 20,000 leagues, nearly three times the equatorial circumference of the earth; it left the main outlines of the southern portions of the globe substantially as they are known to-day; and it showed a possibility of keeping a number of men for years at sea without a heavy toll of lives. Cook only lost one man out of 118 in more than 1000 days; he had conquered scurvy.

The discoverer reached Plymouth on the 25th of July 1775, and his achievements were promptly, if meanly, rewarded. He was immediately raised to the rank of post-captain, appointed a captain in Greenwich hospital, and soon afterwards unanimously elected a member of the Royal Society, from which he received the Copley gold medal for the best experimental paper which had appeared during the year.

Cook's third and last voyage was primarily to settle the question of the north-west passage, practically abandoned since before the middle of the 17th century, but now taken up again, as a matter of scientific interest, by the British government. The explorer, who had volunteered for this service, was instructed to sail first into the Pacific through the chain of the newly discovered islands which he had recently visited, and on reaching New Albion to proceed northward as far as latitude 65° and endeavour to find a passage to the Atlantic. Several ships were at the same time fitted out to attempt a passage on the other side from the Atlantic to the Pacific. Sailing from the Nore on the 25th of June 1776 (Plymouth, July 12), with the "Resolution" and "Discovery," and touching at the Cape of Good Hope, which he left on the 30th of November, Cook next made Tasmania and thence passed on to New Zealand and the Tonga and Society Islands, discovering on his way several of the larger members of the Hervey or Cook Archipelago, especially Mangaia and Aitutaki (March 30th-April 4th, 1777); some smaller isles of this group he had already sighted on his second voyage, September 23rd, 1773. From Tahiti, as he moved north towards the main object of his expedition, he made a far more important discovery, or rather rediscovery, that of the Hawaiian or Sandwich Islands, the greatest and most remarkable of the Polynesian archipelagos (early February 1778). These had perhaps first been seen by the Spanish navigator Gaetano in 1555; but their existence had been kept a close secret by Spain at the time, and had long been forgotten. Striking the west American coast in 44° 55' N. on the 7th of March following, he made an almost continuous survey of the same up to Bering Straits and beyond, as far as 70° 41', where he found the passage barred by a wall, or rather continent, of ice, rising 12 ft. above water, and stretching as far as the eye could reach. The farthest point visible on the American shore (in the extreme north-west of Alaska) he called Icy Cape. On his way towards Bering Straits he discovered and named King George's ("Nootka") and Prince William's Sound, as well as Cape Prince of Wales, the westernmost extremity of North America, never yet seen by English navigators, but well known to Russian explorers, who probably first sighted it in 1648; he also penetrated into the bay afterwards known as Cook's Inlet or River, which at first seemed to promise a passage to the Arctic Seas, to the south-east of the Alaska peninsula. Cook next visited the Asiatic shores of Bering Straits (the extreme north-east of Siberia); returning to America, he explored Norton Sound, north of the Yukon; touched at (Aleutian) Unalaska, where he met with some Russian-American settlers; and thence made his way back to the Hawaiian group, which he had christened after his friend and patron Lord Sandwich, then head of the British admiralty (January 17th, 1779). Here he visited Maui and Hawaii itself, whose size and importance he now

first realized, and in one of whose bays (Kealakekua) he met his death early in the morning of the 14th of February 1779. During the night of the 13th, one of the "Discovery's" boats was stolen by the natives; and Cook, in order to recover it, made trial of his favourite expedient of seizing the king's person until reparation should be made. Having landed on the following day with some marines, a scuffle ensued which compelled the party to retreat to their boats. Cook was the last to retire; and as he was nearing the shore he received a blow from behind which felled him to the ground. He rose immediately, and vigorously resisted the crowds that pressed upon him, but was soon overpowered.

Had Cook returned from his third voyage, there is ground for believing King George would have made him a baronet. Distinguished honours were paid to his memory, both at home and by foreign courts, and a pension was settled upon his widow. But in his life a very inadequate share of official reward was dealt out to the man who not only may be placed first among British maritime discoverers, but also gave his country her title, and so her colonies, in Australasia. As a commander, an observer and a practical physician, his merits were equally great. Reference has been made to his survey work and to his victory over scurvy; it must not be forgotten that along with a commanding personal presence, and with sagacity, decision and perseverance quite extraordinary, went other qualities not less useful to his work. He won the affection of those who served under him by sympathy, kindness and unselfish care of others as noteworthy as his gifts of intellect.

See the *Account of a Voyage round the World in 1769-1771*, by Lieut. James Cook, in vols. ii. and iii. of Hawkesworth's *Voyages* (1773); the *Voyage towards the South Pole and round the World . . . in . . . 1772-1775*, written by James Cook . . . (1777); a *Voyage to the Pacific Ocean . . . in 1776-1780*, vols. i. and ii. written by Cook (1784); also the *Narrative of the Voyages round the World performed by Captain James Cook*, by A. Kippis, D.D., F.R.S. (1788), long the standard life of the navigator, but now superseded by Arthur Kitson's *Captain James Cook, the Circumnavigator* (1907). (C. R. B.)

**COOK, THOMAS** (1808-1892), English travelling agent, was born at Melbourne in Derbyshire on the 22nd of November 1808. Beginning work at the age of ten, he was successively a gardener's help and a wood-turner at Melbourne, and a printer at Loughborough. At the age of twenty he became a Bible-reader and village missionary for the county of Rutland; but in 1832, on his marriage, combined his wood-turning business with that occupation. In 1836 he became a total abstainer, and subsequently became actively associated with the temperance movement, and printed at his own expense various publications in its interest, notably the *Children's Temperance Magazine* (1840), the first of its kind to appear in England. In June 1841 a large meeting was to be held at Loughborough in connexion with this movement, and Cook was struck with the idea of getting the Midland Counties Railway Company to run a special train from Leicester to the meeting. The company consented, and on the 5th of July there were carried 570 passengers from Leicester to Loughborough and back at a shilling a head. This is believed to be the first publicly-advertised excursion train ever run in England—private "specials," reserved for members of institutes and similar bodies, were already in use. The event caused great excitement, and Cook received so many applications to organize similar parties that he henceforward deserted wood-turning, while continuing his printing and publishing. The summers of the next three years were occupied with excursions like the first; but in 1845 Cook advertised a pleasure-trip on a more extensive scale, from Leicester to Liverpool and back, with opportunities for visiting the Isle of Man, Dublin and Welsh coast. A *Handbook of the Trip to Liverpool* was supplied for the use of travellers. In the previous year Cook had entered into a permanent arrangement with the Midland Railway Company to place trains at his disposal, for which he should provide the passengers. A trip to Scotland followed, and the excursionists were received in Glasgow with music and salute of guns.

The next great impetus to popular travel was given by the Great Exhibition of 1851, which Cook helped 165,000 visitors to attend. On the occasion of the Paris exhibition of 1855 there



was a Cook's excursion from Leicester to Calais and back for £1:10s. The following year saw the first grand circular tour in Europe. This part of Cook's activity largely increased after 1863, when the Scottish railway managers broke off their engagements with him, and left him free for more distant enterprise. Switzerland was opened up in 1863, and Italy in 1864. Up to this time "Cook's tourists" had been personally conducted, but now he began to be an agent for the sale of English and foreign tickets, the holders of which travelled independently. Switzerland was the first foreign country accessible under these conditions, and in 1865 nearly the whole of Europe was included in the scheme. Its extension to the United States followed in 1866. For the benefit of visitors to the Paris exhibition, Cook made a fresh departure and leased a hotel there. In the same year began his system of "hotel-coupons," providing accommodation at a fixed charge. The year 1869 was marked by an extension of Cook's tours to Palestine, followed by further developments of travel in the East, his son, John Mason Cook, (1834-1890), being appointed in 1870 agent of the khedivial government for passenger traffic on the Nile. The Franco-German War of 1870-1871 was expected to damage the tourist system, but, as a matter of fact, encouraged it, through the demand for combination, international tickets enabling travellers to reach the south of Europe without crossing the belligerent countries. At the termination of the war a party of American freemasons visited Paris under J. M. Cook's guidance, and became the precursors of the present vast American tourist traffic. At the beginning of 1872 J. M. Cook entered into formal partnership with his father, and the firm first took the name of Thomas Cook & Son. In 1882, on the outbreak of Arabi Pasha's rebellion, Thomas Cook & Son were commissioned to convey Sir Garnet Wolseley and his suite to Egypt, and to transport the wounded and sick up the Nile by water, for which they received the thanks of the war office. The firm was again employed in 1884 to convey General Gordon to the Sudan, and the whole of the men (18,000) and stores necessary for the expedition afterwards sent to relieve him. In 1889 Thomas Cook & Son acquired the exclusive right of carrying the mails, specie, soldiers and officials of the Egyptian government along the Nile. In 1891 the firm celebrated its jubilee, and on the 19th of July of the following year Thomas Cook died. He had been afflicted with blindness in his declining years. His son, J. M. Cook, died in 1899, leaving three sons, all actively engaged in the business.

**COOK or HERVEY ISLANDS**, an archipelago in the Pacific Ocean, lying mainly between 155° and 160° E., and about 20° S.; a dependency of the British colony of New Zealand. It comprises nine partly volcanic, partly coralline, islands, the more important of which are Rarotonga, hilly, fertile and well watered, with several cones 300 to 400 ft. high, above which towers the majestic Rarotonga volcano (2920 ft.), the culminating point of the archipelago; Mangaia (Mangia); Aitutaki, with luxuriant cocoa-nut palm groves; Atui (Vatui); Mitiero; Mauki; Fenuaiti; and the two Hervey Islets, which give an alternative name to the group. The total land area is 111 sq. m. Owing to its healthy, equable climate, the archipelago is well suited for European settlement; but the dangerous fringing coral reefs render it difficult of access, and it suffers also from the absence of good harbours. The natives, who are of Polynesian stock and speech, have legends of their emigration from Samoa. They say their ancestors found black people on the islands, and the strongly Melanesian type which is found, especially on Mangaia, supports the statement. The Cook Islanders were formerly man-hunters and cannibals, but they now are nearly all Protestants, wear European dress and live in stone houses. The total population is about 6200. Since 1890 the islands have enjoyed a general legislature and an executive council of which the *Ariki*s ("kings" and "queens") are members. But all enactments are subject to the approval of the British resident at Rarotonga, and a British protectorate, proclaimed in 1888, was followed by the annexation of the whole archipelago by the governor of New Zealand, by proclamation of June 10th, 1901. The archipelago was discovered by Captain Cook in 1777, and

in 1823 became the scene of the remarkable missionary labours of John Williams, of the London Missionary Society. The chief products of the group are cocoanuts, fruits, coffee and copra. Lime-juice and hats are made.

**COOKE, GEORGE FREDERICK** (1756-1811), English actor, was born in London, and made his first appearance on the stage in Brentford at the age of twenty as Dumont in *Jane Shore*. His first London appearance was at the Haymarket in 1778, but it was not until 1794 in Dublin, as Othello, that he attained high rank in his profession. In 1801 he appeared in London as Richard III., Iago, Shylock and Sir Giles Overreach, and became the rival of Kemble, with whom, however, and with Mrs Siddons, he acted from 1803. His intemperate habits unfortunately grew more and more notorious, and on at least one occasion the curtain had to be rung down owing to the audience hissing his drunken condition. He visited the United States in 1810, and died in New York on the 26th of September 1811. A monument to his memory was erected in St Paul's churchyard there by Edmund Kean.

**COOKE, JAY** (1821-1905), American financier, was born at Sandusky, Ohio, on the 10th of August 1821, the son of Eleutheros Cooke (1787-1864), a pioneer Ohio lawyer, and Whig member of Congress from that state in 1831-1833. Being destined for a commercial career, Jay Cooke received a preliminary training in a trading house in St Louis, and in the booking office of a transportation company in Philadelphia, and at the age of eighteen entered the Philadelphia house of E.W. Clark & Company, one of the largest private banking firms in the country. He showed such aptitude for business that three years later he was admitted to membership in the firm, and before he was thirty he was also a partner in the New York and St Louis branches of the Clarks. In 1858 he retired from the firm, and for the next three years he devoted himself to reorganizing some of the abandoned Pennsylvania railways and canals and placing them again in operation. On the 1st of January 1861 he opened in Philadelphia the private banking house of Jay Cooke & Company, and soon achieved signal success in floating at par a war loan of \$3,000,000 for the state of Pennsylvania, whose credit had become notoriously bad. In the early months of the Civil War Cooke co-operated with the secretary of the treasury, Salmon P. Chase, in securing loans from the leading bankers in the Northern cities, and his own firm was so successful in distributing treasury notes that Chase engaged him as special agent for the sale of the \$500,000,000 of so-called "five-twenty" bonds authorized by the act of the 25th of February 1862. To dispose of these bonds the treasury department had already tried every regular means at its command and had failed. Cooke secured the influence of the American press, appointed 2500 sub-agents, and before the machinery he set in motion could be stopped he had sold \$11,000,000 more of bonds than had been authorized, an excess which Congress immediately sanctioned. At the same time he used all his influence in favour of the establishment of national banks, and organized a national bank at Washington and another at Philadelphia almost as soon as such institutions were authorized by Congress. In the early months of 1865, when the needs of the government were pressing, and the sale of the new "seven-thirty" notes by the national banks had been very disappointing, Cooke's services were again secured. He sent agents into the remotest villages and hamlets, and even into the isolated mining camps of the West, and caused the rural newspapers to praise the loan. As a result, between February and July 1865 he had disposed of three series of the notes, reaching a total of \$830,000,000. Through these efforts the Union soldiers were well supplied and well paid while dealing the final blows of the war; and, later, with money in their pockets, they were disbanded without difficulty.

After the war Cooke became interested in the development of the North-west, and in 1870 his firm undertook to finance the construction of the Northern Pacific railway. In advancing the money for the work, the firm over-estimated the possibilities of its capital, and at the approach of the financial crisis of 1873 it was forced to suspend. By 1880 Cooke had discharged all his

obligations, and through an investment in a silver mine in Utah had again become wealthy. He died at Ogontz, Pennsylvania, on the 18th of February 1905. Cooke was noted for his piety, and gave regularly a tenth of his income for religious and charitable purposes. His handsome estate at Ogontz, which he had been compelled to give up during his bankruptcy, he later repurchased and converted into a school for girls.

See E. P. Oberholtzer, *Jay Cooke, Financier of the Civil War* (Philadelphia, 1907).

**COOKE, ROSE TERRY** (1827–1892), American writer, *née* Terry, was born at West Hartford, Connecticut, on the 17th of February 1827. She published in 1860 a volume of *Poems*, but after her marriage in 1873 to Rollin H. Cooke she was best known for her fresh and humorous stories, though in 1888 she published more verse in her *Complete Poems*. The chief volumes of fiction dealing mainly with New England country life, produced by Rose Terry Cooke, were *Happy Dodd* (1878), *Somebody's Neighbors* (1881), *Root-bound* (1885), *The Sphinx's Children* (1886), *Steadfast* (1889) and *Huckleberries* (1891). She died at Pittsfield, Massachusetts, on the 18th of July 1892.

**COOKERY** (Lat. *coquus*, a cook), the art of preparing and dressing food of all sorts for human consumption, of converting the raw materials, by the application of heat or otherwise, into a digestible and pleasing condition, and generally ministering to the satisfaction of the appetite and the delight of the palate. We may take it that some form of cookery has existed from the earliest times, and its progress has been from the simple to the elaborate, dominated partly by the foods accessible to man, partly by the stage of civilization he has attained, and partly by the appliances at his command for the purpose either of treating the food, or of consuming it when served.

The developed art of cookery is necessarily a late addition—if it may be considered to be included at all—to the list of "fine arts." Originally it is a purely industrial and useful art. Man, says a French writer, was born a roaster, and "*pour être cuisinier, il a besoin de le devenir.*" The ancients were great eaters, but strangers to the subtler refinements of the palate. The gods were supposed to love the smell of fried meat, while their nectar and ambrosia represented an ideal, which, though preserved as a phrase, would hardly satisfy a modern epicure. The ancients were poorly provided with pots and pans, except of a simple order, or with the appurtenances of a kitchen, and they were sadly to seek in the requisites of a modern table. So long as men ate with their hands no dainty confection was suitable; the viands were set forth in a straightforward style fit for their requirements. "Plain cooking," which, after all, can never become obsolete, was the only sort. Oddities, no doubt, were the luxuries; and we can see to-day in the ethnological accounts of contemporary savages and backward civilizations, a fair representation of the cookeries of the ancients. The luxuries of the Chinese are, in their way, a survival of long ages of a cookery which to western civilization is grotesque. Even if it is an historic impertinence, it is impossible for the countries of western civilization to regard the fine flower of their own evolution as other than the highest pitch of progress. *Autres temps, autres mœurs.* To the Chinaman French cooking may possibly be as grotesque as to an Englishman the Chinaman's hundred-year-old buried egg, black and tasteless. The history of comparative cookery is bound up with the physical possibilities of each country and its products; and if we attempt to mark out stages in the evolution of cookery as a fine art, it is necessarily as understood by the so-called civilized peoples of the West in their culmination at the present day.

It is obvious that opportunity has dominated its history, for the art of cookery is to some extent the product of an increased refinement of taste, consequent on culture and increase of wealth. To this extent it is a decadent art, ministering to the luxury of man, and to his progressive inclination to be pampered and have his appetite tickled. It is thus only remotely connected with the mere necessities of nutrition (*q.v.*), or the science of dietetics (*q.v.*). Mere hunger, though the best sauce, will not produce cookery, which is the art of sauces. For centuries its

elaboration consisted mainly of a progressive variety of foods, the richest and rarest being sought out; and their nature depended on what was most difficult to obtain. The Greeks learnt by contact with Asia to increase the sumptuous character of their banquets, but we know little enough of their ideas of gastronomy. Athens was the centre of luxury. According to our chief authority Athenaeus, Arcestratus of Gela, the friend of the son of Pericles, the guide of Epicurus, and author of the *Heduphagetica*, was a great traveller, and took pains to get information as to how the delicacies of the table were prepared in different parts. His lost work was versified by Ennius. Other connoisseurs seem to have been Numenius of Heraclea, Hegemon of Thasos, Philogenes of Leucas, Simonaclides of Chios, and Tyndarides of Sicyon. The Romans, emerging from their pristine simplicity, borrowed from the Greeks their achievements in gastronomic pleasure. We read of this or that Roman gourmet, such as Lucullus, his extravagances and his luxury. The name of the connoisseur Apicius, after whom a work of the time of Heliogabalus is called, comes down to us in association with a manual of cookery. And from Macrobius and Petronius we can gather very interesting glimpses of the Roman idea of a menu. In the later empire, tradition still centred round the Roman cookery favoured by the geographical position of Italy; while the customs and natural products of the remoter parts of Europe gradually begin to assert themselves as the middle ages progress.

It is, however, not till the Renaissance, and then too with Italy as the starting-point, that the history of modern cookery really begins. Meanwhile cookery may be studied rather in the architecture of kitchens, and the development of their appurtenances and personnel, than in any increase in the subtleties of the art; the ideal was inevitably gross; the end was feeding—inextricably associated in all ages with cooking, but as distinct from its *fine fleur* as gluttony from gastronomy.

Montaigne's references to the revival of cookery in France by Catherine de' Medici indicate that the new attention paid to the art was really novel. She brought Italian cooks to Paris and introduced there a cultured simplicity which was unknown in France before. It is to the Italians apparently that later developments are originally due. It is clearly established, for instance (says Abraham Hayward in his *Art of Dining*), that the Italians introduced ices into France. Fricandeaus were invented by the chef of Leo X. And Coryate in his *Crudities*, writing in the time of James I., says that he was called "furfifer" (evidently in contemptuous jest) by his friends, from his using those "Italian neatnesses called forks." The use of the fork and spoon marked an epoch in the progress of dining; and consequently of cookery.

Under Louis XIV. further advances were made. His *maitre d'hôtel*, Béchamel, is famous for his sauce; and Vatel, the great Condé's cook, was a celebrated artist, of whose suicide in despair at the tardy arrival of the fish which he had ordered, Madame de Sévigné relates a moving story. The prince de Soubise, immortalized by his onion sauce, also had a famous chef.

In England the names of certain cookery-books may be noted, such as Sir J. Elliott's (1539), Abraham Veale's (1575), and the *Widdowe's Treasure* (1625). The *Accomplisht Cook*, by Robert May, appeared in 1665, and from its preface we learn that the author (who speaks disparagingly of French cookery, but more gratefully of Italian and Spanish) was the son of a cook, and had studied abroad and under his father (*c.* 1610) at Lady Dormer's, and he speaks of that time as "the days wherein were produced the triumphs and trophies of cookery." From his description they consisted of most fantastic and elaborately built up dishes, intended to amuse and startle, no less than to satisfy the appetite and palate.

Louis XV. was a great gourmet; and his reign saw many developments in the culinary art. The mayonnaise (originally *mahonnaise*) is ascribed to the duc de Richelieu. Such dishes as "*potage à la Xavier*," "*cailles à la Mirepoix*," "*chartreuses à la Mauconseil*," "*poulets à la Villeroy*," "*potage à la Condé*," "*gigot à la Mailly*," owe their titles to celebrities of the day, and the Pompadour gave her name to various others. The

Jesuits Brunoy and Bougeant, who wrote a preface to a contemporary treatise on cookery (1739), described the modern art as "more simple, more appropriate, and more cunning, than that of old days," giving the ingredients the same union as painters give to colours, and harmonizing all the tastes. The very phrase "*cordon bleu*" (strictly applied only to a woman cook) arose from an enthusiastic recognition of female merit by the king himself. Madame du Barry, piqued at his opinion that only a man could cook to perfection, had a dinner prepared for him by a *cuisinière* with such success that the delighted monarch demanded that the artist should be named, in order that so precious a *cuisinier* might be engaged for the royal household. "*Allons donc, la France!*" retorted the ex-grisette, "have I caught you at last? It is no *cuisinier* at all, but a *cuisinière*, and I demand a recompense for her worthy both of her and of your majesty. Your royal bounty has made my negro, Zamore, governor of Luciennes, and I cannot accept less than a *cordon bleu*" (the Royal Order of the *Saint Esprit*) "for my *cuisinière*."

The French Revolution was temporarily a blow to Parisian cookery, as to everything else of the *ancien régime*. "Not a single turbot in the market," was the lament of Grimod de la Reynière, the great gourmet, and author of the *Manuel des amphitryons* (1808). But while it fell heavily on the class of noble amphitryons it had one remarkable effect on the art which was epoch-making. It is from that time that we notice the rise of the Parisian restaurants. To 1770 is ascribed the first of these, the *Champ d'Oiseau* in the rue des Poulies. In 1789 there were a hundred. In 1804 (when the *Almanach des gourmands*, the first sustained effort at investing gastronomy with the dignity of an art, was started) there were between 500 and 600. And in 1814, to such an extent had the restaurants attracted the culinary talent of Paris, that the allied monarchs, on arriving there, had to contract with the two brothers Véry for the supply of their table. Among the great gastronomic names of Napoleon's day was that of his chancellor Cambacérés, of whose dinners many stories are told. Robert (the eponym of the *sauce Robert*), Rechaud and Mérillon were at this period esteemed the Raphael, Michelangelo and Rubens of cookery; while A. Beauvilliers (author of *Art des cuisines*) and Carême (author of the *Maitre d'hôtel français*, and chef at different times to the Tsar Alexander I., Talleyrand, George IV. and Baron Rothschild) were no less celebrated.<sup>1</sup> Perhaps the greatest name of all in the history of the literature of cookery is that of Anthelme Brillat-Savarin (1755-1826), the French judge and author of the *Physiologie du goût* (1825), the classic of gastronomy.

In England Louis Eustache Ude, Charles Elmé Francatelli, and Alexis Soyer carried on the tradition, all being not only cooks but authors of treatises on the art. The *Original* (1835) of Thomas Walker, the Lambeth police magistrate, is another work which has inspired later pens. Like the *Physiologie du goût*, it is no mere cookery-book, but a compound of observation and philosophy. Among simple hand-books, Mrs Glasse's, Dr Kitchener's and Mrs Rundell's were standard English works in the 18th and early 19th centuries; and in France the *Cuisinière de la campagne* (1818) went through edition after edition. An interesting old English work is Dr Pegge's *Forme of Cury* (1780), which includes some historical reflections on the subject. "We have some good families in England," he says, "of the name of Cook or Coke. . . . Depend upon it, they all originally sprang from real professional cooks, and they need not be ashamed of their extraction any more than Porters, Butlers, &c." He points out that cooks in early days were of some importance; William the Conqueror bestowed land on his *coquorum praepositus* and *coquus regius*; and Domesday Book records the bestowal of a manor on Robert Argyllon, by the service of a dish called "de la Groute" on the king's coronation day.

At the present time, whatever the local varieties of cooking, and the difference of national custom, French cooking is admittedly the ideal of the culinary art, directly we leave the plain

<sup>1</sup> See Lady S. O. Morgan's *France, 1829-1830*, ii. 414, for an account of a dinner by Carême.

roast and boiled. And the spread of cosmopolitan hotels and restaurants over England, America and the European continent, has largely accustomed the whole civilized world to the Parisian type. The improvements in the appliances and appurtenances of the kitchen have made the whole world kin in the arts of dining, but the French chef remains the typical master of his craft. Schools of cookery have been added to the educational machine. The literature of the subject has passed beyond enumeration.

It is unnecessary here to pursue so vast a practical subject into detail; but the following notes on broiling, roasting, baking, boiling, stewing and frying may be useful.

**Broiling.**—The earliest method of cooking was probably burying seeds and flesh in hot ashes, a kind of broiling on all the surfaces at the same time, which when properly done is the most delicate kind of cooking. Broiling is now done over a clear fire extending at least 2 in. beyond the edges of the gridiron, which should slightly incline towards the cook. It is usual to rub the bars with a piece of suet for meat, and chalk for fish, to prevent the thing broiled from being marked with the bars of the gridiron. In this kind of cookery the object is to coagulate as quickly as possible all the albumen on the surface, and seal up the pores of the meat so as to keep in all the juices and flavour. It is, therefore, necessary thoroughly to warm the gridiron before putting on the meat, or the heat of the fire is conducted away while the juices and flavour of the meat run into the fire. Broiling is a simple kind of cookery, and one well suited to invalids and persons of delicate appetites. There is no other way in which small quantities of meat can be so well and so quickly cooked. Broiling cannot be well done in front of an open fire, because one side of the meat is exposed to a current of cold air. A pair of tongs should be used instead of a fork for turning all broiled meat and fish.

**Roasting.**—Two conditions are necessary for good roasting—a clear bright fire and frequent basting. Next to boiling or stewing it is the most economical method of cooking. The meat at first should be placed close to a brisk fire for five minutes to coagulate the albumen. It should then be drawn back a short distance and roasted slowly. If a meat screen be used, it should be placed before the fire to be moderately heated before the meat is put to roast. The centre of gravity of the fire should be a little above the centre of gravity of the joint. No kitchen can be complete without an open range, for it is almost impossible to have a properly roasted joint in closed kitcheners. The heat radiated from a good open fire quickly coagulates the albumen on the surface, and thus to a large extent prevents that which is fluid in the interior from solidifying. The connective tissue which unites the fibres is gradually converted into gelatin, and rendered easily soluble. The fibrin and albumen appear to undergo a higher oxidation and are more readily dissolved. The fat cells are gradually broken, and the liquid fat unites to a small extent with the chloride of sodium and the tribasic phosphate of sodium contained in the serum of the blood. It is easily seen that roasting by coagulating the external albumen keeps together the most valuable parts of the meat, till they have gradually and slowly undergone the desired change. This surface coagulation is not sufficient to prevent the free access of the oxygen of the surrounding air. The empyreumatic oils generated on the surface are neither wholesome nor agreeable, and these are perhaps better removed by roasting than any other method except broiling. The chief object is to retain as much as possible all the sapid juicy properties of the meat, so that at the first cut the gravy flows out of a rich reddish colour, and this can only be accomplished by a quick coagulation of the surface albumen. The time for roasting varies slightly with the kind of meat and the size of the joint. As a rule beef and mutton require a quarter of an hour to the pound; veal and pork about 17 minutes to the pound. To tell whether the joint is done, press the fleshy part with a spoon; if the meat yield easily it is done.

**Baking** meat is in many respects objectionable, and should never be done if any other method is available. The gradual disuse of open grates for roasting has led to a practice of first baking and then browning before the fire. This method completely reverses the true order of cooking by beginning with the lowest temperature and finishing with the highest. Baked meat has never the delicate flavour of roast meat, nor is it so digestible. The vapours given off by the charring of the surface cannot freely escape, and the meat is cooked in an atmosphere charged with empyreumatic oil. A brick or earthenware oven is preferable to iron, because the porous nature of the bricks absorbs a good deal of the vapour. When potatoes are baked with meat, they should always be first parboiled, because they take a longer time to bake, and the moisture rising from the potatoes retards the process of baking, and makes the meat sodden. A baked meat pie, though not always very digestible, is far less objectionable than plain baked meat. In the case of a meat pie the surfaces of the meat are protected by a bad conductor of heat from that charring of the surface which generates empyreumatic vapours, and the fat and gravy, gradually rising in temperature, assist the cooking, and such cooking more nearly resembles stewing than baking. The process may go on for a long time after the removal of the meat from the oven, if surrounded with flannel, or some

bad conductor of heat. The Cornish pasty is the best example of this kind of cooking. Meat, fish, game, parboiled vegetables, apples or anything that fancy suggests, are surrounded with a thick flour and water crust and slowly baked. When removed from the oven, and packed in layers of flannel, the pasty will keep hot for hours. When baked dishes contain eggs, it should be remembered that the albumen becomes harder and more insoluble, according to the time occupied in cooking. About the same time is required for baking as roasting.

**Boiling** is one of the easiest methods of cooking, but a successful result depends on a number of conditions which, though they appear trifling, are nevertheless necessary. The fire must be watched so as properly to regulate the heat. The saucepan should be scrupulously clean and have a closely-fitting lid, and be large enough to hold sufficient water to well cover and surround the meat, and all scum should be removed as it comes to the surface; the addition of small quantities of cold water will assist the rising of the scum. For all cooking purposes clean rain water is to be preferred. Among cooks a great difference of opinion exists as to whether meat should be put into cold water and gradually brought to the boiling point, or should be put into boiling water. This, like many other unsettled questions in cookery, is best decided by careful scientific experiment and observation. If a piece of meat be put into water at a temperature of 60°, and gradually raised to 212°, the meat is undergoing a gradual loss of its soluble and nutritious properties, which are dissolved in the water. From the surface to the interior the albumen is partially dissolved out of the meat, the fibres become hard and stringy, and the thinner the piece of meat the greater the loss of all those sapid constituents which make boiled meat savoury, juicy and palatable. To put meat into cold water is clearly the best method for making soups and broth; it is the French method of preparing the *pot au feu*; but the meat at the end of the operation has lost much of that juicy sapid property which makes boiled meat so acceptable. The practice of soaking fresh meat in cold water before cooking is for the same reasons highly objectionable; if necessary, wipe it with a clean cloth. But in the case of salted, smoked and dried meats soaking for several hours is indispensable, and the water should be occasionally changed. The other method of boiling meat has the authority of Baron Liebig, who recommends putting the meat into water when in a state of ebullition, and after five minutes the saucepan is to be drawn aside, and the contents kept at a temperature of 162° (50° below boiling). The effect of boiling water is to coagulate the albumen on the surface of the meat, which prevents, but not entirely, the juices from passing into the water, and meat thus boiled has more flavour and has lost much less in weight. To obtain well-flavoured boiled meat the idea of soups or broth must be a secondary consideration. It is, however, impossible to cook a piece of meat in water without extracting some of its juices and nutriment, and the liquor should in both cases be made into a soup.

**Stewing**.—When meat is slowly cooked in a close vessel it is said to be stewed; this method is generally adopted in the preparation of made dishes. Different kinds of meat may be used, or only one kind according to taste. The better the meat the better the stew; but by carefully stewing the coarsest and roughest parts will become soft, tender and digestible, which would not be possible by any other kind of cooking. Odd pieces of meat and trimmings and bones can often be purchased cheaply, and may be turned into good food by stewing. Bones, although containing little meat, contain from 39 to 49% of gelatin. The large bones should be broken into small pieces, and allowed to simmer till every piece is white and dry. Gelatin is largely used both in the form of jellies and soups. Lean meat, free from blood, is best for stewing, and, when cut into convenient pieces, it should be slightly browned in a little butter or dripping. Constant attention is necessary during this process, to prevent burning. The meat should be covered with soft water or, better, a little stock, and set aside to simmer for four or five hours, according to the nature of the material. When vegetables are used, these should also be slightly browned and added at intervals, so as not materially to lower the temperature. Stews may be thickened by the addition of pearl barley, sago, rice, potatoes, oatmeal, flour, &c., and flavoured with herbs and condiments according to taste. Although stewing is usually done in a stewpan or saucepan with a close-fitting cover, a good stone jar, with a well-fitting lid, is preferable in the homes of working people. This is better than a metal saucepan, and can be more easily kept clean; it retains the heat longer, and can be placed in the oven or covered with hot ashes. The common red jar is not suitable; it does not stand the heat so well as a grey jar; and the red glaze inside often gives way in the presence of salt. The lid of a vessel used for stewing should be removed as little as possible. An occasional shake will prevent the meat from sticking. At the end of the operation all the fat should be carefully removed.

**Frying**.—Lard, oil, butter, or dripping may be used for frying. There are two methods of frying—the dry method, as in frying a pancake, and the wet method, as when the thing fried is immersed in a bath of hot fat. In the former case a frying pan is used, in the other a frying kettle or stewpan. It is usual for most things to have a wire frying basket; the things to be fried are placed in the basket and immersed at the proper temperature in the hot fat. The fat should gradually rise in temperature over a slow fire till it attains

nearly 400° Fahr. Great care is required to fry properly. If the temperature is too low the things immersed in the fat are not fried, but soddened; if, on the other hand, the temperature is too high, they are charred. The temperature of the fat varies slightly with the nature of things to be fried. Fish, cutlets, croquets, rissoles and fritters are well fried at a temperature of 380° Fahr. Potatoes, chops and white bait are better fried at a temperature of 400° Fahr. Care must be taken not to lower the temperature too much by introducing too many things. The most successful frying is when the fat rises two or three degrees during the frying. Fried things should be of a golden brown colour, crisp and free from fat. When fat or oil has been used for fish it must be kept for fish. It is customary first to use fat for croquets, rissoles, fritters and other delicate things, and then to take it for fish. Everything fried in fat should be placed on bibulous paper to absorb any fat on the surfaces.

**COOKSTOWN**, a market town of Co. Tyrone, Ireland, in the east parliamentary division, 54 m. W. by N. of Belfast, on branches of the Great Northern and the Northern Counties (Midland) railways. Pop. of urban district (1901) 3531. It consists principally of a single street of great length, and lies in a pleasant, well-wooded district, near the Ballinderry river. It has important manufactures of linen, and some agricultural trade. It was founded in 1609, the landlord, Allan Cook, giving name to it. The mansion of Killymoon Castle, in the vicinity, is a notable example of the work of a celebrated architect, John Nash (c. 1800).

**COOKTOWN**, a seaport of Banks county, Queensland, Australia, at the mouth of the Endeavour river, about 1050 m. direct N.N.W. of Brisbane. It is visited by the ocean steamers of several lines, and is the centre of a very extensive *bêche-de-mer* and pearl fishery. Tin and gold are worked in the district, in which also good coffee and rice are grown. Cooktown is the port of the Palmer gold-fields, and a railway runs to Laura on the gold-fields, 67 m. W. by S. of Cooktown. It is the chief port of Queensland for the New Guinea trade; and is also the seat of a Roman Catholic vicariate apostolic whose bishop has jurisdiction over the whole of Queensland north of lat. 18° 50'. In 1770 Captain Cook here beached his ship the "Endeavour," to repair the damage caused by her striking a reef in the neighbourhood of the estuary, which he could only clear by throwing his guns overboard. Cooktown became a municipality in 1876. The population of the town and district in 1901 was 1936.

**COOKWORTHY, WILLIAM** (1705-1780), English potter, famous for his discovery of the existence of china-clay and china-stone in Cornwall, and as the first manufacturer of a porcelain similar in nature to the Chinese, from English materials, was born at Kingsbridge, Devon, of Quaker parents who were in humble circumstances. At the age of fourteen he was apprenticed to a London apothecary named Bevans, and he afterwards returned to the neighbourhood of his birthplace, and carried on business at Plymouth with the co-operation of his master, under the title of Bevans & Cookworthy. The manufacture of porcelain was at the time attracting great attention in England, and while the factories at Bow, Chelsea, Worcester and Derby were introducing the artificial glassy porcelain, Cookworthy, following the accounts of Père d'Entrecolles, spent many years in searching for English materials similar to those used by the Chinese. From 1745 onwards he seems to have travelled over the greater portion of Cornwall and Devon in search of these minerals, and he finally located them in the parish of St Stephen's near to St Austell. With a certain amount of financial assistance from Mr Thomas Pitt of Boconnoc (afterwards Lord Camelford) he established the Plymouth China Factory at least as early as 1768. The factory was removed to Bristol about 1770, and the business was afterwards sold to Richard Champion and others and became the well-known Bristol Porcelain Manufactory. Apart from its historic interest there is little to be said for the Plymouth porcelain. Technically it was often imperfect, and its artistic treatment was never of a high order. But Cookworthy deserves to be remembered for his discovery of those abundant supplies of English clay and rocks which form the foundation of English porcelain and fine earthenware (see CERAMICS).

**COOLGARDIE**, a municipal town in Western Australia, 310 m. by rail E. by N. of Perth, and 528 m. by rail N.E. of

Albany. Pop. (1901) 4249. Its gold-fields were discovered in 1891 and are among the richest in the colony. Lignite, copper, graphite and silver are also found. Toorak and Montana are small residential suburbs. A remarkable engineering work by which a full supply of water was brought to the town from Fremantle (a distance exceeding 330 m. direct) was completed in 1903.

**COOLIE**, or **COOLY** (from Koli or Kuli, an aboriginal race of western India; or perhaps from Tamil *kūli*, hire, *i.e.* one hired), a term generally applied to Asiatic labourers belonging to the unskilled class as opposed to the artisan, and employed in a special sense to designate those natives of India and China who leave their country under contracts of service to work as labourers abroad. After the abolition of slavery much difficulty was found in obtaining cheap labour for tropical plantations. The emancipated black was unwilling to engage in field labour, while the white man was physically incapable of so doing. Recourse was had to the overpeopled empires of China and India, as the most likely sources from which to obtain that supply of workers upon which the very existence of some colonies, notably in the West Indies, depended.

The first public recognition of the coolie traffic was in 1844, when the British colony of Guiana made provision for the encouragement of Chinese immigration. About the

*Chinese coolies.*

same time both Peru and Cuba began to look to China as likely to furnish an efficient substitute for the

negro bondsman. Agents armed with consular commissions from Peru appeared in Chinese ports, where they collected and sent away shiploads of coolies. Each one was bound to serve the Peruvian planter to whom he might be assigned for seven or eight years, at fixed wages, generally about 17s. a month, food, clothes and lodging being provided. From 1847 to 1854 coolie emigration went on briskly without attracting much notice, but it gradually came to light that circumstances of great cruelty attended the trade. The transport ships were badly equipped and overcrowded, and many coolies died before the end of the voyage. On arrival in Cuba or Peru the survivors were sold by auction in the open market to the highest bidders, who held them virtually as slaves for seven years instead of for life. Particularly terrible was the lot of those who, contrary to their agreements, had been sent to labour in the foul guano pits of the Chincha islands, where they were forced to toil in gangs, each under the charge of an overseer armed with a cowhide lash. In 1860 it was calculated that of the four thousand coolies who had been fraudulently consigned to the guano pits of Peru not one had survived. The greater number of them had committed suicide. In 1854 the British governor of Hong-Kong issued a proclamation forbidding British subjects or vessels to engage in the transport of coolies to the Chinchas. Technically this was *ultra vires* on his part, but his policy was confirmed by the Chinese Passengers' Act 1855, which put an end to the more abominable phase of the traffic. After that no British ship was allowed to sail on more than a week's voyage with more than twenty coolies on board, unless her master had complied with certain very stringent regulations.

The consequence of this was that the business of shipping coolies for Peru was transferred to the Portuguese settlement of Macao. There the Peruvian and Cuban "labour-agents" established depôts, which they unblushingly called "barracoons," the very term used in the West African slave trade. In these places coolies were "received," or in plain words, imprisoned and kept under close guard until a sufficient number were collected for export. Some of these were decoyed by fraudulent promises of profitable employment. Others were kidnapped by piratical junks hired to scour the neighbouring coasts. Many were bought from leaders of turbulent native factions, only too glad to sell the prisoners they captured whilst waging their internecine wars. The procurador or registrar-general of Macao went through the form of certifying the contracts; but his inspection was practically useless. After the war of 1856-1857 this masked slave trade pushed its agencies into Whampoa and Canton. In April 1859, however, the whole mercantile

community of the latter port rose up in indignation against it, and transmitted such strong representations to the British embassy in China, that steps were taken to mitigate the evil. New regulations were from time to time passed by the Portuguese authorities for the purpose of minimizing the horrors of the Macao trade. They seem, however, to have been systematically evaded, and to have been practically inoperative. At Canton and Hong-Kong the coolie trade was put under various regulations, which in the latter port worked well only when the profits of "head-money" were ruined. In March 1866 the representatives of the governments of France, England and China drew up a convention for the regulation of the Canton trade, which had an unfortunate effect. It left head-money, the source of most of the abuses, comparatively untouched. It enacted that every coolie must at the end of a five years' engagement have his return passage-money paid to him. The West Indian colonies at once objected to this. They wanted permanent not temporary settlers. They could not afford to burden the coolie's expensive contract with return passage-money, so they declined to accept emigrants on these terms. Thus a legalized coolie trade between the West Indies and China was extinguished. Thereafter the coolie supply for British colonies was drawn exclusively from India, until 1904, when an exception was made in the case of the Transvaal. Under a convention drawn up in that year between the United Kingdom and China over fifty thousand indentured Chinese labourers were engaged on three years' contracts to work in the Witwatersrand gold mines (see TRANSVAAL). To the Malay states and other parts of eastern Asia there is an extensive yearly migration of Chinese coolies. This migration, however, is not under contract. From Amoy alone some seventy-five thousand coolies yearly migrate to Singapore and the Straits Settlements, whence they are drafted for labour purposes in every direction.

It is scarcely possible to say when the Indian coolie trade began. Before the end of the 18th century Tamil labourers from southern India were wont to emigrate to the Straits Settlements, and they also flocked to Tenasserim from the other side of the Bay of Bengal after the conquest had produced a demand for labour. The first regularly recorded attempt at organizing coolie emigration from India took place in 1834, when forty coolies were exported to Mauritius; but it was not until 1836 that the Indian government decided to put the trade under official regulations. In 1837 an emigration law was passed for all the territories of the East India Company, providing that a permit must be obtained from government for every shipment of coolies, that all contracts should terminate in five years, that a return passage should be guaranteed, that the terms of his contract should be carefully explained to each coolie, and that the emigrant ship should only carry one coolie for every ton and a half of burden. Then as now the Indian government watched the deportation of labour from their dominions with jealous and anxious care, and when in 1838 it was found that upwards of twenty-five thousand natives had, up to that year, gone from all parts of India to Mauritius, the government became somewhat alarmed at the dimensions which the traffic was assuming. Brougham and the anti-slavery party denounced the trade as a revival of slavery, and the Bengal government suspended it in order to investigate its alleged abuses. The nature of these may be guessed when it is said that the inquiry condemned the fraudulent methods of recruiting then in vogue, and the brutal treatment which coolies often received from ship captains and masters. In 1842 steps were taken formally to reopen the coolie trade with Mauritius, and in 1844 emigration to the West Indies was sanctioned by the Indian government. In 1847 Ceylon was separated from India, and her labour supply was cut off; but this accident was soon remedied, the Ceylon government adopting protective regulations for the coolies.

*Indian coolies.*

Emigration of coolies under contract to labour outside India is now regulated by the Emigration Act of 1883 and the rules issued under its provisions, the only exceptions being in respect of emigrants to Ceylon and the Straits Settlements and



adjoining states, or those engaged by the British government for employment in east and central Africa. By section 8 of this act natives of India are permitted to emigrate under labour contracts only to such countries as have satisfied the government of India that sufficient provision is made for the protection of the emigrants. A country which is duly empowered under the act to receive emigrants may appoint an agent, residing in India, who is responsible for the due observance of the provisions of the law. These agents are under the general supervision of the protector of emigrants. As emigrants have to be recruited at great distances from the port of embarkation, recruiters are appointed by the agents and licensed by the protector. The conduct of these subordinates is minutely regulated. Every precaution is taken to let the emigrant know the exact terms on which he is hired, and to ensure good treatment in the interval between registration and embarkation. Coolies are shipped for the most part from Calcutta and Madras, but of recent years large numbers bound for Mombasa and the Seychelles left from Bombay and Karachi. Both the coolies themselves and the depot are medically inspected. Only those physically fit are allowed to embark. The vessels for their conveyance are licensed and inspected by the local government. The terms on which emigrants are recruited are settled beforehand by convention with the colonies concerned, and are embodied in ordinances passed by the local legislatures. They vary in detail, but their main provisions relate to the rights and obligations of the emigrants, including the grant of a return passage on the expiry of a specified period, usually ten years. The British colonies to which coolies were exported in the decade 1891-1901 were British Guiana, Trinidad, St Lucia, Jamaica, Mauritius, the Seychelles Islands, Fiji, East Africa and Natal; the only non-British country was Dutch Guiana. Emigration to the French colonies, including Réunion has been forbidden by the government of India since 1886, but there still remain in those colonies some of the former emigrants, and the questions of their treatment and repatriation have frequently formed the subject of representations to the French authorities.

The number of Indian coolies resident in the various British colonies in 1900 was 625,000, of which the largest numbers were 265,000 in Mauritius and 125,000 in British Guiana. There were still 13,800 in Réunion. The regulations governing coolie labour in British Guiana may be taken as typical for the British colonies generally. They are contained in the Labour Ordinance of 1873, which was amended by the ordinances of 1875, 1876, 1886 and 1887. Under these ordinances an immigration agent-general is appointed, to whom medical officers and recruiting agents are responsible, and the emigrants are allotted by him to the separate estates. They regulate the hours of work, the rate of wages, and the general treatment of the coolies, the nature of house and hospital accommodation, the terms of re-enlistment and the conditions of marriage amongst the coolies themselves. The coolies returning from the British colonies to India in 1901 possessed average savings of £19.

During the construction of the Uganda railway large numbers of coolies were recruited in the Punjab and exported from Karachi to Mombasa. During the decade 1891-1901 the number of these emigrants was 33,000; but on the completion of the line the emigration practically stopped, while in 1901-1902 there were over 6000 emigrants who returned to India. Some, however, settled in East Africa. Coolies are also exported for government employment in Nyasaland. In Natal the Indian population had by 1904 reached over 100,000 and slightly outnumbered the whites. Many of the coolies had become permanent residents in the colony (see NATAL).

According to the census of 1901 there were 775,844 foreigners in Assam, of whom no fewer than 645,000 or 83% were brought into the province as garden coolies. The recruiting of these coolies is regulated by Act VI. of 1901, which provides that a labour agreement may be entered into for four years, and includes

a penal clause, under which a coolie deserting or refusing to work may be punished with imprisonment. The coolies can also give an agreement under Act XIII. of 1859, by which they are only liable to civil action for breach of contract. The latter are called non-act coolies. This system of immigration has made tea-planting the most important industry in Assam, and has greatly increased the prosperity of the province. Migration to Ceylon and Burma takes place chiefly from the Madras ports, and is of a seasonal and temporary character. The tea estates and pearl fisheries of Ceylon, and the town work and harvesting in Burma attract large numbers of Tamil labourers. The respective numbers embarking in 1901 were 117,000 for Ceylon, 84,000 for Burma and 27,000 for the Straits Settlements. In Ceylon there is no system of recruitment like that for the Assam tea-gardens. The coolies come in gangs, each under its own headman, with whom the planter deals exclusively, leaving him to make his own arrangements with the individual coolies. The coolies are mostly carried in small sailing vessels from the ports of Madura and Tanjore, and the number who permanently settle in Ceylon is not very great.

See E. Jenkins, *The Coolie; his Rights and Wrongs* (1871); J. L. A. Hope, *In Quest of Coolies* (1872); and C. B. Grose, *The Labour Ordinances* (Georgetown, 1890). (C. L.)

**COOMA**, a town of Beresford county, New South Wales, Australia, 264 m. by rail S.S.W. of Sydney. Pop. (1901) 1938. The town is the centre of a pastoral district and has a large trade in furs, while at Bushy Hill, a mile from the town, is a small gold-field. Cooma, which is pleasantly situated at an elevation of 2657 ft., is the tourist centre for visitors to the Yarrangobilly Caves and Mount Kosciusko and its observatory. The caves are distant 65 m. from the town, situated in the side of a hill, overlooking the Yarrangobilly river; they are seven in number and of remarkable beauty and extent.

**COOPER, ABRAHAM** (1787-1868), English animal and battle painter, the son of a tobacconist, was born in London. At the age of thirteen he became an employé at Astley's amphitheatre, and was afterwards groom in the service of Sir Henry Meux. When he was twenty-two, wishing to possess a portrait of a favourite horse under his care, he bought a manual of painting, learned something of the use of oil-colours, and painted the picture on a canvas hung against the stable wall. His master bought it and encouraged him to continue in his efforts. He accordingly began to copy prints of horses, and was introduced to Benjamin Marshall, the animal painter, who took him into his studio, and seems to have introduced him to the *Sporting Magazine*, an illustrated periodical to which he was himself a contributor. In 1814 he exhibited his "Tam O'Shanter," and in 1816 he won a prize of £100 for his "Battle of Ligny." In 1817 he exhibited his "Battle of Marston Moor" and was made associate of the Academy, and in 1820 he was elected Academician. Cooper, although ill educated, was a clever and conscientious artist; his colouring was somewhat flat and dead, but he was a master of equine portraiture and anatomy, and had some antiquarian knowledge. He had a special fondness for Cavalier and Roundhead pictures.

**COOPER, ALEXANDER** (d. 1660), English miniature painter. His works are of great rarity, and the chief are a series representing the king and queen of Bohemia and their children, in the possession of the German emperor; some very remarkable portraits belonging to the queen of Holland, and others in the possession of the king of Sweden and in various Swedish galleries. He was the brother of Samuel Cooper, but whether senior or junior to him is not known, although, according to certain Swedish authorities, he is stated, upon very slight evidence, to have been born in 1605, four years before his more famous brother. He came to Sweden in 1646, and the Swedish documents declare that he was a Jew, and that his full name was Abraham Alexander Cooper. He had previously been residing in Holland, but on reaching Sweden entered the service of Queen Christina, and continued to be her miniature painter until 1654, when she resigned the crown. Two years later, Cooper was in Denmark, carrying out some commissions for Christian IV., but

**Modern  
regula-  
tions.**

**Assam,  
Ceylon  
and  
Burma.**

**The  
British  
colonies.**

**British  
East and  
South  
Africa.**

in 1657 was back again in Stockholm, where he died in the early part of 1660. The date of his birth is not known, but he is believed to have been born in London.

For full information regarding his career, and for various documents bearing his signature, see *The History of Portrait Miniatures*, by G. C. Williamson, chap. vi. page 78, and an article in the *Nineteenth Century* for October 1905. (G. C. W.)

**COOPER, SIR ASTLEY PASTON** (1768–1841), English surgeon, was born at the village of Brooke in Norfolk on the 23rd of August 1768. His father, Dr Samuel Cooper, was a clergyman of the Church of England; his mother was the author of several novels. At the age of sixteen he was sent to London and placed under Henry Cline (1750–1827), surgeon to St Thomas's hospital. From the first he devoted himself to the study of anatomy, and had the privilege of attending the lectures of John Hunter. In 1789 he was appointed demonstrator of anatomy at St Thomas's hospital, where in 1791 he became joint lecturer with Cline in anatomy and surgery, and in 1800 he was appointed surgeon to Guy's hospital, on the death of his uncle, William Cooper. In 1802 he received the Copley medal for two papers read before the Royal Society of London on the destruction of the *membrana tympani*; and in 1805 he was elected a fellow of that society. In the same year he took an active part in the formation of the Medico-Chirurgical Society, and published in the first volume of its *Transactions* an account of an attempt to tie the common carotid artery for aneurism. In 1804 he brought out the first, and in 1807 the second, part of his great work on hernia, which added so largely to his reputation that in 1813 his annual professional income rose to £21,000 sterling. In the same year he was appointed professor of comparative anatomy to the Royal College of Surgeons and was very popular as a lecturer. In 1817 he performed his famous operation of tying the abdominal aorta for aneurism; and in 1820 he removed a wen from the head of George IV., and about six months afterwards received a baronetcy, which, as he had no son, was to descend to his nephew and adopted son, Astley Cooper. He served as president of the Royal College of Surgeons in 1827 and again in 1836, and he was elected a vice-president of the Royal Society in 1830. He died on the 12th of February 1841 in London, and was interred, by his own desire, beneath the chapel of Guy's hospital. A statue by E. H. Baily was erected in St Paul's.

His chief works are *Anatomy and Surgical Treatment of Hernia* (1804–1807); *Dislocations and Fractures* (1822); *Lectures on Surgery* (1824–1827); *Illustrations of Diseases of the Breast* (1829); *Anatomy of the Thymus Gland* (1832); *Anatomy of the Breast* (1840).

See *Life of Sir A. Cooper*, by B. B. Cooper (1843).

**COOPER, CHARLES HENRY** (1808–1866), English antiquary, was born at Great Marlow, on the 20th of March 1808, being descended from a family formerly settled at Bray, Berkshire. He received his education at a private school in Reading. In 1826 he fixed his residence at Cambridge, and in 1836 was elected coroner of the borough. Four years later he was admitted a solicitor, and in course of time he acquired an extensive practice, but his taste and inclination ultimately led him to devote almost the whole of his time to literary research, and especially the elucidation of the history of the university of Cambridge. In 1849 he resigned the office of borough coroner on being elected to the town-clerkship, which he retained till his death on the 21st of March 1866. His earliest production, *A New Guide to the University and Town of Cambridge*, was published anonymously in 1831. *The Annals of Cambridge* followed (1842–1853) containing a chronological history of the university and town from the earliest period to 1853. His most important work, the *Athenae Cantabrigienses* (1858, 1861), a companion work to the famous *Athenae Oxonienses* of Anthony à Wood, contains biographical memoirs of the authors and other men of eminence who were educated at the university of Cambridge from 1500 to 1609. Cooper's other works are *The Memorials of Cambridge*, (1858–1866) and a *Memoir of Margaret, Countess of Richmond and Derby* (1874). He was a constant contributor to *Notes and Queries*, the *Gentleman's Magazine* and other antiquarian publications, and left an immense collection of MS. materials for a biographical history of Great Britain and Ireland.

**COOPER, JAMES FENIMORE** (1789–1851), American novelist, was born at Burlington, New Jersey, on the 15th of September 1789. Reared in the wild country round Otsego Lake, N. Y., on the yet unsettled estates of his father, a judge and member of Congress, he was sent to school at Albany and at New Haven, and entered Yale College in his fourteenth year, remaining for some time the youngest student on the rolls. Three years afterwards he joined the United States navy; but after making a voyage or two in a merchant vessel, to perfect himself in seamanship, and obtaining his lieutenantcy, he married and resigned his commission (1811). He settled in Westchester county, N. Y., the "Neutral Ground" of his earliest American romance, and produced anonymously (1820) his first book, *Precaution*, a novel of the fashionable school. This was followed (1821) by *The Spy*, which was very successful at the date of issue; *The Pioneers* (1823), the first of the "Leatherstocking" series; and *The Pilot* (1824), a bold and dashing sea-story. The next was *Lionel Lincoln* (1825), a feeble and unattractive work; and this was succeeded in 1826 by the famous *Last of the Mohicans*, a book that is often quoted as its author's masterpiece. Quitting America for Europe he published at Paris *The Prairie* (1826), the best of his books in nearly all respects, and *The Red Rover*, (1828), by no means his worst.

At this period the unequal and uncertain talent of Cooper would seem to have been at its best. These excellent novels were, however, succeeded by one very inferior, *The Wept of Wish-ton-Wish* (1829); by *The Notions of a Travelling Bachelor* (1828), an uninteresting book; and by *The Waterwitch* (1830), one of the poorest of his many sea-stories. In 1830 he entered the lists as a party writer, defending in a series of letters to the *National*, a Parisian journal, the United States against a string of charges brought against them by the *Revue Britannique*; and for the rest of his life he continued skirmishing in print, sometimes for the national interest, sometimes for that of the individual, and not infrequently for both at once. This opportunity of making a political confession of faith appears not only to have fortified him in his own convictions, but to have inspired him with the idea of imposing them on the public through the medium of his art. His next three novels, *The Bravo* (1831), *The Heidenmauer* (1832) and *The Headsman: or the Abbat of Vignerot* (1833), were designed to exalt the people at the expense of the aristocracy. Of these the first is by no means a bad story, but the others are among the dullest ever written; all were widely read on both sides of the Atlantic.

In 1833 Cooper returned to America, and immediately published *A Letter to my Countrymen*, in which he gave his own version of the controversy he had been engaged in, and passed some sharp censure on his compatriots for their share in it. This attack he followed up with *The Monikins* (1835) and *The American Democrat* (1835); with several sets of notes on his travels and experiences in Europe, among which may be remarked his *England* (1837), in three volumes, a burst of vanity and ill-temper; and with *Homeward Bound*, and *Home as Found* (1838), noticeable as containing a highly idealized portrait of himself. All these books tended to increase the ill-feeling between author and public; the Whig press was virulent and scandalous in its comments, and Cooper plunged into a series of actions for libel. Victorious in all of them, he returned to his old occupation with something of his old vigour and success. *A History of the Navy of the United States* (1839), supplemented (1846) by a set of *Lives of Distinguished American Naval Officers*, was succeeded by *The Pathfinder* (1840), a good "Leatherstocking" novel; by *Mercedes of Castile* (1840); *The Deerslayer* (1841); by *The Two Admirals* and by *Wing and Wing* (1842); by *Wyandotté*, *The History of a Pocket Handkerchief*, and *Ned Myers* (1843); and by *Afloat and Ashore, or the Adventures of Miles Wallingford* (1844). From pure fiction, however, he turned again to the combination of art and controversy in which he had achieved distinction, and in the two *Littlepage Manuscripts* (1845–1846) he fought with a great deal of vigour. His next novel was *The Crater, or Vulcan's Peak* (1847), in which he attempted to introduce supernatural machinery with indifferent success; and this



was succeeded by *Oak Openings* and *Jack Tier* (1848), the latter a curious *rifacimento* of *The Red Rover*; by *The Sea Lions* (1849); and finally by *The Ways of the Hour* (1850), another novel with a purpose, and his last book. He died of dropsy on the 14th of September 1851 at Cooperstown, New York. His daughter, Susan Fenimore Cooper (1813-1894), was known as an author and philanthropist.

Cooper was certainly one of the most popular authors that have ever written. His stories have been translated into nearly all the languages of Europe and into some of those of Asia. Balzac admired him greatly, but with discrimination; Victor Hugo pronounced him greater than the great master of modern romance, and this verdict was echoed by a multitude of inferior readers, who were satisfied with no title for their favourite less than that of "the American Scott." As a satirist and observer he is simply the "Cooper who's written six volumes to prove he's as good as a Lord" of Lowell's clever portrait; his enormous vanity and his irritability find vent in a sort of dull violence, which is exceedingly tiresome. It is only as a novelist that he deserves consideration. His qualities are not those of the great masters of fiction; but he had an inexhaustible imagination, some faculty for simple combination of incident, a homely tragic force which is very genuine and effective, and up to a certain point a fine narrative power. His literary training was inadequate; his vocabulary is limited and his style awkward and pretentious; and he had a fondness for moralizing tritely and obviously, which mars his best passages. In point of conception, each of his three-and-thirty novels is either absolutely good or is possessed of a certain amount of merit; but hitches occur in all, so that every one of them is remarkable rather in its episodes than as a whole. Nothing can be more vividly told than the escape of the Yankee man-of-war through the shoals and from the English cruisers in *The Pilot*, but there are few things flatter in the range of fiction than the other incidents of the novel. It is therefore with some show of reason that *The Last of the Mohicans*, which as a chain of brilliantly narrated episodes is certainly the least faulty in this matter of sustained excellence of execution, should be held to be the best of his works.

The personages of his drama are rather to be accounted as so much painted cloth and cardboard, than as anything approaching the nature of men and women. As a creator of aught but romantic incident, indeed, Cooper's claims to renown must rest on the fine figure of the Leatherstocking, and, in a less degree, on that of his friend and companion, the Big Serpent. The latter has many and obvious merits, not the least of which is the pathos shed about him in his last incarnation as the Indian John of *The Pioneers*. Natty Bumppo, however, is a creation of no common unity and consistency. There are lapses and flaws, and Natty is made to say things which only Cooper, in his most verbosely didactic vein, could have uttered. But on the whole the impression left is good and true. In the dignity and simplicity of the old backwoodsman there is something almost Hebraic. With his naïve vanity and strong reverent piety, his valiant wariness, his discriminating cruelty, his fine natural sense of right and wrong, his rough limpid honesty, his kindly humour, his picturesque dialect, and his rare skill in woodcraft, he has all the breadth and roundness of a type and all the eccentricities and peculiarities of a portrait.

See *James Fenimore Cooper* (Boston, 1883), by Thomas R. Lounsbury in the "American Men of Letters" series; Griswold, *Prose Writers of America* (Philadelphia, 1847); J. R. Lowell, *Fable for Critics*; M. A. de Wolfe Howe, *American Bookmen* (New York, 1898); and the introduction by Mowbray Morris to Macmillan's uniform edition of Cooper's novels (London, 1900). (W. E. H.)

**COOPER, PETER** (1791-1883), American manufacturer, inventor and philanthropist, was born in New York city on the 12th of February 1791. His grandfathers and his father served in the War of American Independence. He received practically no schooling, but worked with his father at hat-making in New York city, at brewing in Peekskill, at brick-making in Catskill, and again at brewing in Newburgh. At seventeen he was apprenticed to a coach-builder in New York city. On coming of age he got employment at Hempstead, Long Island, making

machines for shearing cloth; three years afterwards he set up in this business for himself, having bought the sole right to manufacture such machinery in the state of New York. Business prospered during the War of 1812, but fell off after the peace. He turned his shop into a furniture factory; soon sold this and for a short time was engaged in the grocery business on the site of the present Bible House, opposite Cooper Union; and then invested in a glue and isinglass factory, situated for twenty-one years in Manhattan (where the Park Avenue Hotel was built later) and then in Brooklyn. About 1828 he built the Canton Iron Works in Baltimore, Maryland, the foundation of his great fortune. The Baltimore & Ohio railway was to cross his property, and, after various inventions aiming to do away with the locomotive crank and thus save two-fifths of the steam, in 1830 he designed and constructed (largely after plans made two years before) the first steam locomotive built in America; though only a small model it proved the practicability of using steam power for working that line. The "Tom Thumb," as Cooper called the locomotive, was about the size of a modern hand-car; as the natural draft was far from sufficient, Cooper devised a blowing apparatus. Selling his Baltimore works, he built, in 1836, in partnership with his brother Thomas, a rolling mill in New York; in 1845 he removed it to Trenton, New Jersey, where iron structural beams were first made in 1854 and the Bessemer process first tried in America in 1856; and at Philippsburg, New Jersey, he built the largest blast furnace in the country at that time. He built other foundries at Ringwood, New Jersey, and at Durham, Pennsylvania; bought iron mines in northern New Jersey, and carried the ore thence by railways to his mills. Actively interested with Cyrus Field in the laying of the first Atlantic cable, he was president of the New York, Newfoundland & London Telegraph Company, and his frequent cash advances made the success of the company possible; he was president of the North American Telegraph Company also, which controlled more than one-half of the telegraph lines of the United States. For his work in advancing the iron trade he received the Bessemer gold medal from the Iron and Steel Institute of Great Britain in 1879. He took a prominent part in educational affairs, strongly opposed the Roman Catholic claims for public funds for parochial schools, and conducted the campaign of the Free School Society to its successful issue in 1842, when a state law was passed forbidding the support from public funds of any "religious sectarian doctrine." He is probably best known, however, as the founder of the Cooper Union (*q.v.*). Cooper was an early advocate of the emancipation and the enlistment in the Union army of Southern negroes, and he upheld the administration of Lincoln. Though he had been a hard-money Democrat, he joined the Greenback party after the Civil War, and in 1876 was its candidate for the presidency, but received only 81,740 out of the 8,412,833 votes cast. He died in New York city on the 4th of April 1883. He published *The Political and Financial Opinions of Peter Cooper, with an Autobiography of his Early Life* (1877), and *Ideas for a Science of Good Government, in Addresses, Letters and Articles on a Strictly National Currency, Tariff and Civil Service* (1883).

There is a brief biography by R. W. Raymond, *Peter Cooper* (Boston, 1900).

**COOPER, SAMUEL** (1609-1672), English miniature painter. This artist was undoubtedly the greatest painter of miniatures who ever lived. He is believed to have been born in London, and was a nephew of John Hoskins, the miniature painter, by whom he was educated. He lived in Henrietta St., Covent Garden, and frequented the Covent Garden Coffee-House. Pepys, who makes many references to him, tells us he was an excellent musician, playing well upon the lute, and also a good linguist, speaking French with ease. According to other contemporary writers, he was a short, stout man, of a ruddy countenance. He married one Christiana, whose portrait is at Welbeck Abbey, and he had one daughter. In 1668 he was instructed by Pepys to paint a portrait of Mrs Pepys, for which he charged £30. He is known to have painted also the portrait of John Aubrey, which was presented in 1691 to the Ashmolean Museum, as we

learn from his correspondence with John Ray, the naturalist. Evelyn refers to him in 1662, when, on the occasion of the visit that the diarist paid to the king, Cooper was drawing the royal face and head for the new coinage.

Magnificent examples of his work are to be found at Windsor Castle, Belvoir Castle, Montague House, Welbeck Abbey, Ham House, the Rijks Museum at Amsterdam and in the collection of Mr J. Pierpont Morgan. His largest miniature is in the possession of the duke of Richmond and Gordon at Goodwood. A piece of the artist's handwriting is to be seen at the back of one of his miniatures in the Welbeck Abbey collection, and one of his drawings in black chalk is in the University Gallery at Oxford. His own portrait of himself is in the collection of Mr J. Pierpont Morgan.

The date of his death has been handed down by a record in the diary of Mary Beale, the miniature painter; and in some letters from Mr Charles Manners, addressed to Lord Roos, dated 1672, now amongst the duke of Rutland's papers at Belvoir, the writer refers to Cooper's serious illness on the 4th of May, and to his doubt as to whether the artist would ever recover. Mary Beale's reference to his decease is in the following words: "Sunday, May 5, 1672—Mr Samuel Cooper, the most famous limner of the world for a face, dyed."

For a fuller account see the *History of Portrait Miniatures*, by G. C. Williamson, vol. i. p. 64. (G. C. W.)

**COOPER (or COUPER), THOMAS** (c. 1517–1594), English bishop and writer, was born in Oxford, where he was educated at Magdalen College. He became master of Magdalen College school, and afterwards practised as a physician in Oxford. His literary career began in 1548, when he compiled, or rather edited, a Latin dictionary *Bibliotheca Eliotae*, and in 1549 he published a continuation of Thomas Lanquet's *Chronicle of the World*. This work, known as *Cooper's Chronicle*, covers the period from A.D. 17 to the time of writing, and was reprinted in 1560 and 1565. In 1565 appeared the first edition of his greatest work, *Thesaurus Linguae Romanae et Britannicae*, and this was followed by three other editions. Queen Elizabeth was greatly pleased with the *Thesaurus*, generally known as *Cooper's Dictionary*; and its author, who had been ordained about 1559, was made dean of Christ Church, Oxford, in 1567. Two years later he became dean of Gloucester, in 1571 bishop of Lincoln and in 1584 bishop of Winchester. Cooper was a stout controversialist; he defended the practice and precept of the Church of England against the Roman Catholics on the one hand and against the Martin Marprelate writings and the Puritans on the other. He took some part, the exact extent of which is disputed, in the persecution of religious recusants in his diocese, and died at Winchester on the 29th of April 1594.

Cooper's *Admonition against Martin Marprelate* was reprinted in 1847, and his *Answer in Defence of the Truth against the Apology of Private Mass* in 1850.

**COOPER, THOMAS** (1759–1840), American educationalist and political philosopher, was born in London, England, on the 22nd of October 1759, and educated at Oxford. Threatened with prosecution at home because of his active sympathy with the French Revolution, he emigrated to America about 1793, and began the practice of law in Northumberland county, Pennsylvania. He was president-judge of the Fourth District of Pennsylvania in 1806–1811. Like his friend Joseph Priestley, who was then living in Northumberland, he sympathized with the Anti-Federalists, and took part in the agitation against the Sedition Act, and for a newspaper attack in 1799 on President John Adams, Cooper was convicted, fined and imprisoned for libel. Like Priestley, Cooper was very highly esteemed by Thomas Jefferson, who secured for him the appointment as first professor of natural science and law in the University of Virginia—a position which Cooper was forced to resign under the fierce attack made on him by the Virginia clergy. After filling the chair of chemistry in Dickinson College, Carlisle, Pa. (1811–1814), and in the University of Pennsylvania (1818–1819), he became professor of chemistry in South Carolina College, at Columbia, in 1819, and afterwards gave instruction in political

economy also. In 1820 he became acting president of this institution, and was president from 1821 until 1833, when he resigned owing to the opposition within the state to his liberal religious views. In December 1834, owing to continued opposition, he resigned his professorship. He had been formally tried for infidelity in 1832. He was a born agitator: John Adams described him as "a learned, ingenious, scientific and talented madcap." Before his college classes, in public lectures, and in numerous pamphlets, he constantly preached the doctrine of free trade, and tried to show that the protective system was especially burdensome to the South. His remedy was state action. Each state, he contended, was a sovereign power and was in duty bound to protest against the tyrannical acts of the Federal government. He exercised considerable influence in preparing the people of South Carolina for nullification and secession; in fact he preceded Calhoun in advocating a practical application of the state sovereignty principle. The last years of his life were spent in preparing an edition of the Statutes at Large of the state, which was completed by David James McCord (1797–1855) and published in ten volumes (1836–1841). Dr Cooper died in Columbia on the 11th of May 1840. As a philosopher he was a follower of Hartley, Erasmus Darwin, Priestley and Broussais; he was a physiological materialist, and a severe critic of Scotch metaphysics. Among his publications are *Political Essays* (1800); *An English Version of the Institutes of Justinian* (1812); *Lectures on the Elements of Political Economy* (1826); *A Treatise on the Law of Libel and the Liberty of the Press* (1830); and a translation of Broussais' *On Irritation and Insanity* (1831), with which were printed his own essays, "The Scripture Doctrine of Materialism," "View of the Metaphysical and Physiological Arguments in favour of Materialism," and "Outline of the Doctrine of the Association of Ideas."

See I. Woodbridge Riley, *American Philosophy: the Early Schools* (New York, 1907).

**COOPER, THOMAS** (1805–1892), English Chartist and writer, the son of a working dyer, was born at Leicester on the 20th of March 1805. After his father's death his mother began business as a dyer and fancy box-maker at Gainsborough. Young Cooper was apprenticed to a shoemaker. He had a passion for knowledge; studied Greek, Latin and Hebrew in his spare time; and in 1827 gave up cobbling to become a schoolmaster, and, later, a Methodist preacher. His affairs did not prosper, and after going to Lincoln, where he obtained work on a local newspaper, he came to London in 1839. Here he became assistant to a second-hand bookseller, but in 1840 he joined the staff of the *Leicestershire Mercury*. His support of the Chartist movement obliged him to resign his position, but he undertook to edit *The Midland Counties Illuminator*, a Chartist journal, in 1841. He became a leader of the extreme Chartist party, and for his action in urging on the strike of 1842 he was imprisoned in Stafford gaol for two years. Here he produced *The Purgatory of Suicides*, a political epic in ten books, embodying the radical ideas of the time. In his efforts to publish this work after his liberation he came under the notice of Benjamin Disraeli and Douglas Jerrold. Through Jerrold's help it appeared in 1845, and Cooper then turned his attention to lecturing upon historical and educational subjects. In 1856 he suddenly renounced the free-thinking doctrines which he had held for many years, and became a lecturer on Christian evidences. He died at Lincoln on the 15th of July 1892. Among his other works may be mentioned the *Bridge of History over the Gulf of Time* (1871) and the *Life of Thomas Cooper, written by Himself* (1872).

**COOPER, THOMAS SIDNEY** (1803–1902), English painter, was born at Canterbury on the 26th of September 1803. In very early childhood he showed in many ways the strength of his artistic inclinations, but as the circumstances of his family did not admit of his receiving any systematic training, he began before he was twelve years old to work in the shop of a coach painter. A little later he obtained employment as a scene painter; and he alternated between these two occupations for about eight years. But the desire to become an artist continued to influence him, and all his spare moments were given up to drawing and

painting from nature. At the age of twenty he went to London, drew for a while in the British Museum, and was admitted as a student of the Royal Academy. He then returned to Canterbury, where he was able to earn a living as a drawing-master and by the sale of sketches and drawings. In 1827 he settled in Brussels; but four years later he returned to London to live, and by showing his first picture at the Royal Academy (1833) began an unprecedentedly prolonged career as an exhibitor. Cooper's name is mainly associated with pictures of cattle or sheep, and the most notable of the many hundred he produced are: "A Summer's Noon" (1836), "A Drover's Halt on the Fells" (1838), "A Group in the Meadows" (1845), "The Half-past One o'Clock Charge at Waterloo" (1847), "The Shepherd's Sabbath" (1866), "The Monarch of the Meadows" (1873), "Separated but not Divorced" (1874), "Isaac's Substitute" (1880), "Pushing off for Tilbury Fort" (1884), "On a Farm in East Kent" (1889), "Return to the Farm, Milking Time" (1897). He was elected A.R.A. in 1845 and R.A. in 1867. He presented to his native place, in 1882, the Sidney Cooper Art Gallery, built on the site of the house in which he was born. He wrote his reminiscences, under the title of *My Life*, in 1890; and died on the 7th of February 1902.

**COOPERAGE**, or **COPERAGE** (Flemish and Dutch *koop*, a trader, dealer), a system of traffic in spirituous liquors, tobacco and other articles amongst the fishermen in the North Sea. The practice began in the middle of the 19th century, when Flemish and Dutch *koopers* frequented the fishing fleets for the purpose of barter. Trading first in tobacco, they extended their operations, and soon became practically floating grog-shops.

The demoralizing nature of the traffic was brought to the public notice in 1881, and a convention was held at the Hague in 1882 to consider means of remedying the abuses. In 1887 Great Britain, Germany, Belgium, Denmark, France and the Netherlands signed an agreement to prevent the sale or purchase of spirituous liquors among fishermen at sea. In Great Britain an act (the North Sea Fisheries Act 1888) was passed to carry into effect the terms of the convention. The act (now repealed and replaced by the North Sea Fisheries Act 1893, with which it is identical but for some slight verbal modifications) imposes a fine not exceeding £50 or a term of imprisonment not exceeding three months for supplying, exchanging or otherwise selling spirits. It imposes a like penalty for purchasing spirits by exchange or otherwise, and requires every British vessel dealing in provisions or other articles to have a licence and to carry a special mark. In 1882 Mr E. J. Mather started a mission to deep sea fishermen, which sends out mission ships and supplies the fishermen with good clothing, literature, tobacco, &c., at a fair price. This mission, now the Royal National Mission to Deep Sea Fishermen, is registered by the Board of Trade.

See E. J. Mather, *Nor'ard of the Dogger* (1888), and publications of the Mission to Deep Sea Fishermen.

**COOPERAGE** (from "cooper," a maker of casks, derived from such forms as Mid. Dutch *cuper*, Ger. *Küfer*, Lat. *cuparius*; the same root is seen in various Teut. words for a basket, such as Dutch *kuip* and Eng. "kipe" and "coop," but cooper is apparently not formed directly from "coop," which never means a "cask" but always a basket-cage for poultry, &c.), the art of making casks, barrels and other rounded vessels, the sides of which are composed of separate staves, held together by hoops surrounding them. The art is one of great antiquity; Pliny ascribes its invention to the inhabitants of the Alpine valleys. The trade is one in which there are numerous subdivisions, the chief of which are tight or wet and dry or slack cask manufacture. To these may be added white cooperage, a department which embraces the construction of wooden tubs, pails, churns and other even-staved vessels. Of all departments, the manufacture of tight casks or barrels for holding liquids is that which demands the greatest care and skill, since, in addition to being perfectly tight when filled with liquid, the vessels must bear the strain of transportation to great distances, and in many cases have to resist considerable internal pressure when they contain fermenting liquors. The staves are best made of well-seasoned oak.

Since a cask is a double conoid, usually having its greatest diameter (technically the bulge or belly) at the centre, each stave must be properly curved to form a segment of the whole, and must be so cut as to have a suitable bilge or increase of width from the ends to the middle; it must also have its edges bevelled to such an angle that it will form tight joints with its neighbours. The staves being prepared, the next operation is to set up or raise the barrel. For this purpose as many staves as are necessary are arranged upright in a circular frame, and round their lower halves are fitted truss hoops which serve to keep them together for the permanent hooping. The upper ends are then drawn together by means of a rope which is passed round them and tightened by a windlass, and other truss hoops are dropped over them, the wood being steamed or heated to enable it to bend freely to shape. The two ends of the cask are next finished to receive the heads by forming the chime, or bevel on the extremity of the staves, and the croze or groove into which the heads fit. Finally the heads and permanent hoops are put in place. The heads, when made of two or more pieces, are jointed by wooden dowel pins, and after being cut to size are chamfered or bevelled round the edge to fit into the croze grooves. The hoops are generally of iron. The manufacture of slack casks proceeds on the same general lines, but is simpler in various respects, both because less accurate workmanship is required, and because softer woods, largely fir, may be employed. Machinery of the most elaborate and specialized character has been devised to perform most of the operations in making both slack and tight casks, and though it involves considerable capital outlay it effects so great an economy of time that it has largely superseded hand labour. (For an account of such machinery see L. H. Ransome, "Cask-making Machinery," *Proc. Inst. Civ. Eng.* vol. 115; also an article in *Engineering*, 1908, 85, p. 845.) Barrels without separate staves are made by bending a sheet of wood, sawn from a log in a continuous strip, into the required circular shape, the bulge at the centre being obtained by cutting out V gores from the ends. Barrels are also sometimes made of steel, either of the ordinary bulging form or consisting of straight-sided drums provided near the middle with rings on which they may be rolled. Immense numbers of casks of different shapes and sizes are employed in various industries. Tight barrels are a necessity to the wine and cider maker, brewer and distiller, and are largely used for the transport of oils and liquid chemicals, while slack barrels are utilized by the million for packing cement, alkali, china, fruit, fish and numerous other products.

**CO-OPERATION**, a term used particularly both for a theory of life, and for a system of business, with the general sense of "working together" (*con*, with, and *opus*, work). In its narrowest usage it means a combination of individuals to economize by buying in common, or increase their profits by selling in common. In its widest usage it means the creed that life may best be ordered not by the competition of individuals, where each seeks the interest of himself and his family, but by mutual help; by each individual consciously striving for the good of the social body of which he forms part, and the social body in return caring for each individual: "each for all, and all for each" is its accepted motto. Thus it proposes to replace among rational and moral beings the struggle for existence by voluntary combination for life. More or less imperfectly embodying this theory, we have co-operation in the concrete, or "the co-operative movement," meaning those forms of voluntary association where individuals unite for mutual aid in the production of wealth, which they will devote to common purposes, or share among them upon principles of equity, reason and the common good, agreed upon beforehand. Not that a co-operative society can begin by saying absolutely what those principles in their purity would dictate. It begins with current prices, current rates of wages and interest, current hours of labour, and modifies them as soon as it can wherever they seem least conformable to equity, reason and the common good.

In the industrial world there is everywhere much working together for the production of wealth, but this is not included in co-operation if the shares of those concerned are determined by

competition, *i.e.* by a struggle and the relative ability of each to secure a large share. Nor do co-operators regard the association as truly voluntary, though it may depend on contract, if that contract be one of service only, without an opportunity for all concerned to share in the ultimate control. Co-operation in fact is essentially a democratic association. On the other hand, there is some working together for the production of wealth which without being competitive, or based on service, is not strictly voluntary: thus in primitive societies there is much customary help, combined with customary division of the produce; and in advanced societies we have state and municipal socialism. These are indeed sometimes included in co-operation, but at least they are not voluntary co-operation, since the individual has no choice but to take part in them; they depend on the power of the ruler to coerce the ruled, or of the majority to coerce the minority. In co-operation, meaning voluntary co-operation; there may also, it is true, be frequent overruling of the minority by the majority, but only so far as the minority have, when joining the association, voluntarily agreed to permit, and subject always to an effective ultimate right of secession.

Thus co-operation occupies the middle ground between competition and state or municipal socialism. In its technical sense, however, it does not cover the whole of this ground: it does not cover associations which are primarily for social, provident, or religious purposes, but only those closely connected with the production of wealth. We speak of co-operative societies for agriculture, for manufacturing, for retail, or wholesale distribution, for building or house-owning, for raising capital and so forth; while the great Friendly Societies (*q.v.*), though a part of co-operation as a theory of life, are not part of the co-operative movement. The line is somewhat hard to draw, and consequently is drawn somewhat arbitrarily. Thus while a society for building, or for the collective ownership of houses, is counted a co-operative society, a Building Society (as we ordinarily understand the term), though it be purely mutual in its basis, is not so counted in Great Britain, but is in the United States (see BUILDING SOCIETIES).

For the early history of the co-operative movement we have to look chiefly to Great Britain, and British co-operation acknowledges as its founder Robert Owen (*q.v.*). In every age and every country the origins of co-operation may no doubt be traced, where men have helped one another in the creation of wealth and agreed as brothers as to its division. In England long before the days of Owen there was much co-operation of miners and fishermen which, though scarcely obligatory on the individuals taking part in it, was largely regulated by custom. Coming to more purely voluntary associations, co-operative workshops are recorded, retail co-operation was practised in Scotland from the middle of the 18th century, while in England shops not unlike co-operative stores, but without the democratic element, were in one or two instances set up by benevolent individuals. It does not seem, however, that there was any theory of co-operation until Owen in England, and almost simultaneously Fourier (*q.v.*) in France, formulated their gospels, not identical, yet having much in common. Of these two Owen and his teaching are by far the more important.

The end of the 18th and the beginning of the 19th centuries were the culminating days of the industrial revolution, when the old organization of domestic industry had given way before the factory system, and the population of the factory districts was suffering a martyrdom, with ruin of body and degradation of character, from unbridled competition, long hours, women's and children's labour, pauper apprenticeship, great fluctuations of trade and employment, dearness and adulteration of provisions, the truck system and insanitary homes. Owen, having himself become a great employer of labour, after starting as a draper's assistant, saw that this was in every sense waste, and that as it paid the manufacturer to have the best machinery and not to overdrive it, but to tend it well and keep it in the best repair, so it would pay him, and abundantly pay the nation, to have the human machines well cared for, not overworked, and kept in the best condition. The popular individualistic

philosophy of that day taught that the good of society would be achieved by each individual seeking in his business relations the interest of himself and his family; but Owen maintained that the well-being of the social body could only be served if each individual made that his conscious aim. For this reason he and his disciples were called Socialists. He taught further that a man's character depended mainly upon the circumstances which influenced his life; he emphasized environment, and all but denied heredity. At New Lanark, from 1799, he carried out these ideas among the workers in the cotton mills of which he was managing partner.<sup>1</sup> "For twenty-nine years," he wrote, "we did without the necessity for magistrates or lawyers; without a single legal punishment; without any known poors' rate; without intemperance or religious animosities. We reduced the hours of labour, well educated all the children from infancy, greatly improved the condition of the adults, diminished their daily labour, paid interest on capital, and cleared upwards of £300,000 of profit." So wonderful were the results upon the population, that New Lanark became a show-place of world-wide renown, and was visited by many of the greatest and most exalted people of the period.

While thus using his own power Owen not only advocated legislation to limit the hours of factory labour, but appealed to the public authorities to establish industrial communities, where the poor might be set to work, and be managed paternally on the principles of New Lanark. So great was his repute, and so influential the royal and other personages who gave him their support, that this appeal might probably have been successful had not Owen, in reply to complaints as to his religious views—which were deistic—and that his system was not founded on religion, made a public attack upon all accepted religions.

Failing to get the required support from the Government and magistrates, he still sought it from wealthy believers in his teaching, and a number of "communities" (see COMMUNISM) were founded in England and Scotland, and in the United States. These were intended to be self-supporting, the land and other means of producing wealth being owned in common, and work and education being regulated on Owen's principles. Owen well knew that most of them lacked the large amount of capital necessary, but his hand was forced by enthusiastic followers, and even the most hopeful of the experiments, that of Queenwood in Hampshire (1839-1844), was made prematurely and failed.

His connexion with New Lanark also came to an end, not from any want of success, but through differences with some of his partners who objected to such matters as dancing, military drill for the children, and the wearing of kilts, but above all feared lest Owen's "infidelity" should undermine the people's faith.

Thus it might have seemed that Owen's life and fortune had been spent in vain, and resulted only in unsuccessful experiments; but this was far from being so. His teaching, and in particular his doctrines of circumstance, and of the conscious seeking after the social good, his belief in self-supporting communities, and his vision of a new moral and industrial world, had powerfully affected the working classes, indeed, all classes. Workmen in many parts of the country had formed groups with the ultimate object of founding self-supporting communities. If the government and the rich would not provide capital enough to start communities, the workers would start them themselves. Thus was the democratic basis given to co-operation. As a means they had been founding co-operative societies, which are sometimes called "union shops" to distinguish them from the later growth of societies of the Rochdale type. The members began by buying provisions wholesale and retailing them to themselves at current prices; the difference became capital, and as soon as possible one member was set to work to make boots and another clothes, and so forth, until ultimately the society should have capital enough to take land and form a community. Education also was prominent among their objects. These co-operative societies reached some 400 or 500 between 1828 and 1834, but the movement then collapsed. As the original enthusiasm died out, or members left the neighbourhood, or capital accumulated in

<sup>1</sup> Holyoake, *History of Co-operation* (1906 edition), i. 34.

the hands of the original shareholders, they almost all either failed or became private property. In those early days, moreover, the law gave no protection to the property of co-operative societies. This remained so until 1852, when the Christian Socialists (see SOCIALISM) among their many great services to the working classes secured such protection. In 1862 they secured also limited liability for the members.

Before 1844 a co-operative society had already been formed and failed at Rochdale in Lancashire, yet some ardent spirits planned to form another. Twenty-eight poor men, flannel weavers and such like, got together a capital of £28 by twopenny and threepenny subscriptions, and in December 1844 opened in Toad Lane, Rochdale, a little shop from which, speaking broadly, the whole of British co-operation, and very much of that of other lands, has grown. Their objects were those of other co-operative societies of the time, including the ultimate aim of a self-supporting community. In this last they never succeeded, nor indeed did they attempt it; but they did succeed in vastly improving the position of millions of the working classes by enabling them to obtain their provisions cheap and pure, to avoid the millstone of debt, to save money, to pass from retail to wholesale trade, and from distribution to manufacturing, building and house-owning, ship-owning and banking; above all to educate themselves, and to live with an ideal.

The Rochdale Equitable Pioneers began their trading in the smallest way, the members taking turns to serve in the shop; yet where so many other Union shops had failed Rochdale succeeded, and it has steadily grown to an institution with some 14,000 members, doing a trade of £300,000, owning shops and workshops, a library and reading-rooms, making large profits, and devoting a substantial part of them to education and to charitable purposes. What was the reason of this difference? Chiefly it would seem a different method of dealing with the profits. Earlier "Stores" had divided these according to the capital contributed by each member, or else equally among the members: the Rochdale Pioneers determined that, after paying 5% interest on the share capital, all profit should be allotted to the purchasing members in proportion to their purchases, and be capitalized in the name of the member entitled, until his shares amounted to £5. Thus each member found it his interest to purchase at the store and to introduce new purchasers. The ownership of the store remained always with the purchasers, and each came under the magic influence of a little capital saved.

Not only did Rochdale store grow amazingly, but its example spread far and near. New stores were founded on the "Rochdale plan" and old stores adopted it; soon they were numbered by hundreds. In spite of many failures there were in 1906 more than fourteen hundred such stores in the United Kingdom, with nearly two and a quarter million members, over £33,000,000 capital, and sales exceeding £63,000,000 in the year. The number of societies does not increase of late years, the tendency being rather for established societies to open branches, but all the other figures increase rapidly from year to year.

These workmen's Co-operative Stores, or Distributive Societies, flourish chiefly in the north and midlands of England and in Scotland, but are found more or less all over the country. They, and practically all other British co-operative societies, are registered under the Industrial and Provident Societies Act, which constitutes them corporate bodies, with limited liability, and fixes £200 as the maximum that any member may hold in the share capital. Their government is democratic, based on one vote each, for man or woman; and their members or shareholders, and their committee-men or directors, are almost exclusively the more provident of the working classes, or belong to the class just above. Store societies are of various sizes, from the small village shop to the greatest of them all, the Leeds Society, with nearly 50,000 members, sales exceeding a million and a half sterling, and an elaborate organization of branches and manufacturing departments. Their method, the "Rochdale system," is as follows, subject to occasional variations. Membership is open to all who pay a shilling entrance fee and sign for a

£1 share, which can be paid up-out of profit. For the most part members may at any time withdraw their shares in cash at par. A record of each member's purchases is kept by means of metal tokens or otherwise, and at the end of each quarter, after paying a limited interest (never more than 5%, and in very many societies less) on shares, and, in some societies, paying a proportion of profit to the employees, the surplus is divided to the members in proportion to their purchases: non-members also usually receiving half dividends on theirs. Thus the members in effect obtain their necessaries at cost price. The dividend on members' purchases averages about 2s. 6d. in the £. In many successful societies even more is paid, but the average is falling. Where dividend is high, prices are often fixed above those current in the neighbourhood, so that the members, in addition to saving the retailer's profit, use their Society as a sort of savings bank, where they put away a halfpenny or so for every shilling they spend. In addition to retailing, a store often manufactures bread, clothes, boots and millinery, sometimes farms land, or grinds corn; usually for its own members only, but occasionally for sale to other societies also. Their productions in this way exceed £5,000,000 a year. They also invest large and increasing sums in building cottages, to let or sell to their members; and they lend still more largely to their members, to enable them to buy cottages.

Outwardly these stores may look like mere shops, but they are really much more. First, they are managed with a view not to a proprietor's profit, but to cheap and good commodities. Secondly they have done an immense work for thrift and the material prosperity of the working classes, and as teachers of business and self-government. But further, they have a distinct social and economic aim, namely, to correct the present inequalities of wealth, and substitute for the competitive system an industry controlled by all in the common interest, and distributing on principles of equity and reason, mutually agreed on, the wealth produced. With this view they acknowledge the duties of fair pay and good conditions for their own employees, and of not buying goods made under bad conditions. The best societies further set aside a small proportion of their profits for educational purposes, including concerts, social gatherings, classes, lectures, reading-rooms and libraries, and often make grants to causes with which they sympathize. Their members are prominent in local government affairs; co-operative candidates are occasionally run for town councils, and often talked of for parliament. Though the societies are non-political, and have refused to join the labour representation movement, they are usually centres of "progressive" ideas. There are of course many defects, and of their two million members a large, and many fear an increasing, proportion, attracted by the prosperity of the societies, think chiefly of what they themselves gain; but the government of the movement has, hitherto at least, been largely in the hands of men of ideas, who believe that stores are but a step to co-operative production, and on to the "co-operative commonwealth."

It is indeed only when we come to federations of co-operative societies, and above all to production, with its large number of employees, that the educational side of the movement and its power to promote industrial reform are most seen. The Co-operative Union, Limited, for instance, is a propagandist federation of all the chief co-operative societies in Great Britain, and some in Ireland. Its income of £10,000 a year is contributed by the Co-operative Societies. It looks after their legal and parliamentary interests, carries on much educational work by means of literature, lectures, classes, scholarships, summer meetings at the universities, and so on; organizes numerous local conferences for discussion, and once a year a great national co-operative congress, and exhibition of productions, in some chief centre of population. The Co-operative Wholesale Society, Limited, is a trading federation of the great majority of the English stores. Founded in 1863 on a small scale, it now counts its employees by thousands, its capital by millions, and its yearly sales by tens of millions. Besides its merchant trade, it manufactures to the value of £4,500,000, owning factories, warehouses and land in many districts. It imports largely, and runs its own steamships. It is also the bank of the co-operative societies,



and the chief outlet for the always redundant capital of the well-established stores. The Scottish stores also have their Wholesale Society, not less important relatively. For many purposes these two are in partnership. In each of them the net profits are returned to the stores as a dividend on purchases, and thence to the whole body of members; but in the Scottish Wholesale a part is also paid to its employees as a dividend upon their wages. There are also a few local federations of stores, mostly for corn-milling and baking.

Strongly contrasting with this production by associations of consumers, or "consumers' production," is the co-partnership, or labour co-partnership, branch of co-operation. Its simplest form is an association of producers formed to carry on their own industry. Originally such societies were intended to consist solely of the workers employed; the ideal was the "self-governing workshop," introduced from France by the Christian Socialists of 1850; but membership is now open to the distributive societies, which are the chief customers, and usually, to all sympathizers. Shares are transferable, not withdrawable. Profits first pay the agreed "wages of capital," usually 5%, and of what remains the main part goes to the employees as a dividend on their wages, and to the customers as a dividend on their purchases. In well-established societies the dividend on wages averages about 1s. on the £. This is not usually paid in cash, but credited to the employees as share capital, whereby all may become members. Besides other producers' associations, more or less co-operative, there are over a hundred co-partnership societies at work in England, against a dozen or fifteen in 1883. They are engaged in boot-making, printing, building, weaving, clothing, wood-working, metal-working, and so on. Some of them are very small, while others have businesses of £50,000 a year or more, the average being about £10,000. The majority show fair, sometimes large profits. Each is governed by a committee, which is elected by the members and appoints the manager. A minority of them sell in the open, *i.e.* the non-co-operative, market, and a few sell largely for export.

We constantly hear that co-operative production is a failure. There have no doubt been failures, especially of big experiments attempted among men totally unprepared. But many of the failures counted were not truly co-operative. At the present day consumers' production is successful beyond all question, while the net growth of producers' associations in the last twenty years has been marked both in number and importance. These two forms of production best illustrate the two rival theories which divide British co-operation, and between whose partisans the conflict has at times been sharp. The consumers' theory maintains that all profit on price is abstracted from the consumer, and must be returned to him; while to him should also belong all capital and control, subject to such regulations as the state and the trade unions enforce. This theory is fully exemplified in the English Wholesale Society, and in some of the smaller federations for production, which employ workmen, whether co-operators or not, for wages only, and admit no individual, but only co-operative societies, to membership. It is also exemplified by the great majority of the stores, though in their case the employee may become a member in his capacity as a consumer. The co-partnership theory, on the other hand, maintains that the workers actually employed in any industry, whether distributive or productive, should be partners with those who find the capital, and those who buy the produce, and should share with them the profit, responsibilities and control. The consumers' party contend that societies of producers make a profit out of the consumers, and thus are never truly co-operative, while as they multiply they must compete against each other. The co-partnership party answer that labour at least helps to make the profit, and that competition, as yet almost insignificant between their societies, can be avoided by federating them (a process long ago begun) for buying and selling in common, and for other common purposes, while leaving each the control and responsibility of its own internal affairs. They further advocate the eventual federation of the productive wing

of co-operation with the distributive, for settling prices and all matters in which their interests might conflict. In this way they say the co-operative system may extend indefinitely without sacrificing either individual responsibility and freedom, or a general unity and control, so far as these are necessary to secure the common interest. On the other hand they hold that the opposing system tends more and more to centralization and bureaucracy, and divorces the individual workman from all personal interest in his work, and from any control over its conditions. They contend, moreover, and it is indeed admitted that, in spite of the great advantages which consumers' production has in its command of a market and of abundant capital, only a small part of industry can ever be carried on by associations of the persons who actually consume the produce. Outside this small part, therefore, voluntary co-operation is impossible except as some form of co-partnership.

On the working-out of these two principles depends the future of co-operation. The example of Scotland probably throws light on the problem. There co-operative production, amounting to some millions sterling, is nearly all carried on by federations of consumers' societies, including the Scottish Wholesale, which apply more or less successfully the co-partnership principle—*i.e.* their employees are admitted to share in profits, and may become members, whereby they are further admitted to share in capital and control. The type of organization hence resulting is very much the same as where a society of producers admits consumers' societies to membership, and sets aside a proportion of the profits to be returned to them as dividend upon their purchases. To this combined type, we have seen, English productive societies, started by producers, have come; and it would appear that those started by consumers must ultimately tend to it. However, in spite of honoured leaders of the early days, the consumers' party is at present greatly in the ascendant in English co-operation, and even in the Scottish federations it is almost strong enough to abolish co-partnership, and allow no one to share in capital, profit or control except in his capacity as a consumer.

An association of co-operative societies and individuals, called the Labour Co-partnership Association, exists to maintain the principle of co-partnership in co-operation, and also to promote its gradual adoption in ordinary businesses. Some progress in this latter direction is being made, there being a tendency to improve upon simple profit-sharing by capitalizing the workman's "bonus," whereby he becomes a shareholder, and the business is gradually modified in a co-operative direction. There are remarkable instances of such modification abroad, notably that of the great iron foundry and *Familisère* at Guise in France. The most noteworthy, among several, in England is that of the South Metropolitan Gas Company, where after eighteen years of the system 5000 odd employees had in 1907 more than £320,000 invested in the company; they also elect three of themselves directors of the company, this being one-third of the board. Unfortunately this example is, or at least was, marred by a feud with the trade unions, whereas there is friendship between trade unionism and co-partnership, as indeed between trade unionism and co-operation generally.

One of the most recent and promising developments of English co-operation is the tenants' co-partnership movement for the common ownership of groups of houses, which the society owning them lets out to its members. These societies are but few as yet, but they have sprung up rapidly and promise great usefulness and extension. Somewhat similar societies have long been a recognized branch of co-operation on the continent of Europe.

Such, then, are the history and present extent of co-operation in Great Britain. Turning abroad we find in almost all civilized countries, besides other forms of co-operation, important and growing movements roughly similar to those above described, but on the whole less identified with the working classes and less coloured by their social and economic ideals. In France, Germany, Switzerland, Italy and elsewhere, there are very important co-operative

**Co-partnership.**

**Rival theories.**

**Tenants' co-partnership societies.**

**The movement outside Britain.**



distributive movements looking to Rochdale as their prototype; and in the United States of America there are at least continual attempts to spread Rochdale co-operation. Of these foreign stores, however, many exhibit important modifications, such as unlimited liability, and selling at cost price, or between that and market prices. On the whole we may say that Rochdale Co-operation is the most extended and the most typical. It, and the workshop movement springing from Fourier, and the socialist co-operation of Belgium and elsewhere, are certainly the forms which have most of the ideal of democratic equality and social reconstruction. Other forms look more to the money benefits accruing to the members, seeking to supplement the present order of society, rather than to bring in a new order. Among these other forms—separate in origin, in methods, and largely in spirit—the most important are credit co-operation, or people's banking, and agricultural co-operation, two forms until recently unknown in the British Islands.

Confusion has sometimes arisen from the fact that while Rochdale Co-operation sets itself against "credit," continental co-operation is more concerned with obtaining credit for its members than with anything else. But credit is used in two senses. The English workman employed for wages is against the credit which means spending them before they are earned: continental co-operation seeks by collective credit to put into the hands of working peasants, craftsmen and traders, the stock and the tools without which their labour is vain. Credit for consumption is the road to poverty; credit for production the road to well-being.

Just as with co-operation in labour and in purchase, so mutual help in obtaining credit may doubtless be traced in primitive forms far back into history. It was certainly more or less "in the air" in Germany and France about 1848 and even earlier; but the beginning of systematic organized credit co-operation may be definitely fixed in the year 1849, when Raiffeisen began his *Darlehnskasse*, or loan bank, in Rhenish Prussia. Curiously enough it had also a second and entirely independent origin. For in the following year Schulze-Delitzsch, in a distant part of the same kingdom, established his Credit Society based on an entirely different system. As this second system spread much more rapidly than the other and attained, as indeed it retains, much greater commercial magnitude, it came to be regarded as the beginning of credit co-operation, of which for a long time it was the only important form. These two remain the two distinct types in every land. Thus Germany, which has innumerable co-operative societies of every form and of great importance, is in particular the mother of credit co-operation.

In the famine years of 1846 and 1847 and for some years after, Friedrich Wilhelm Raiffeisen was a burgomaster in the barren Westerwald. The people were hopelessly ground down by debt to money-lenders for small doles of capital, advanced to purchase stock, or meet times of special difficulty. It occurred to Raiffeisen that by combining to borrow a moderate sum of money on their joint responsibility, and afterwards to lend it out among themselves in small sums at a slightly greater rate of interest, the peasants might obtain relief from their burden of usury, and at the same time get the capital necessary to make their labour productive. Accordingly in 1849 at the little town of Flammersfeld, he set up a "Loan Bank." Despite its success, it remained the only one of its kind for five years, when Raiffeisen founded a second. There was no third for eight years more: it was only in 1880 that they began really to spread, but now they are found in many lands and are counted by thousands.

Such a bank is essentially an association of neighbours. Besides borrowing, it also receives savings deposits, which often produce a large part of, or even all, the capital it needs. Usually a few of the members are comparatively well to do people, who join to help their neighbours by increasing the society's credit. This Raiffeisen considered essential. They have no actual privilege, but by common consent they take a leading part. In the true Raiffeisen bank the liability of each member is unlimited, but limited liability has been introduced in some of its modifica-

tions. The Society confines its operations strictly to a small area, say a parish, where everyone knows everyone. Each borrower must specify the purpose for which he wants a loan, say to buy a cow or drain a field, or pay off a money-lender, and this is rigorously inquired into. Only members can borrow. Any member, however poor, can borrow for a profitable approved purpose, and no one, however rich, for any other. Practically all the members see that the money is applied as agreed; and, while the loan is often made for a long period, a year or two—even for ten or more—so as to repay itself out of the profit, power is reserved to call it in at short notice if misapplied. Loans are repayable by periodical instalments, but repayments must be made with absolute punctuality. No bills, mortgages or other securities are taken, except a note of hand either alone or with one or two sureties. There are two committees, one to lend and do the work of the society, and the other to supervise the first; and on both of these it is understood that the richer members are to be in a majority. No committeeman or officer receives any remuneration for his services, except that the accountant gets a small salary. Originally there were no shares, and when in 1889 the legislature ordained that there must be shares, the Raiffeisen banks made theirs as small as possible, generally ten or twelve shillings. Nothing is paid on the shares as interest or dividend, all profit being voted once for all to the ordinary reserve and the indivisible reserve, the latter the backbone of the system. In every large district the Raiffeisen banks are federated in a Union, and these Unions culminate in a General Agency. As an intermediary among themselves, and between them and the money market, the banks have also a central bank with a capital of £500,000, and with ten provincial branches. A great deal of agricultural co-operation has arisen from these banks as centres, and with the money they have supplied.

Raiffeisen banks boast that neither member nor creditor has ever lost a penny by them, and while this is denied it seems at least near the truth. Their credit is so good that they can obtain money at very low rates, and as their expenses are trifling they can re-lend to their members at rates but little higher. In Germany they usually lend at about 5%. Only men of good character can obtain membership: thus, besides spreading prosperity, they have everywhere been great promoters of sobriety and good conduct. They were only intended to meet the needs of the peasants, especially of the very poorest, and for this purpose they have proved admirably suited.

Very different were the people among whom Schulze-Delitzsch established his form of co-operative credit; and very different the organization he adopted and the results which have flowed from it. In 1850 Franz Hermann Schulze was a judge in his native town of Delitzsch, almost at the middle point of the southern edge of Prussia, and established there his first *Vorschussverein*, or Advance-Union. He had been in England and knew something of our co-operative movement, but he scarcely seems to have derived any part of his inspiration from it. The people he desired to help were townsmen, especially the small craftsmen working on their own account, the joiners, shoemakers and so forth; and his ideal was to do this merely by stimulating their thrift.

In a Schulze-Delitzsch bank, a number of such men combine together to raise a capital of guarantee: to do this every member takes up one share and one only, which is of large value, say £30 or £50 or even much more, but can be paid up by small instalments. Thus every member is committed to a long course of saving. On the strength of this capital in course of formation, and the unlimited liability of the members, the bank is able to borrow, or to receive as savings and deposits from members and others, a much larger capital. The funds so constituted it lends out at the highest rates it can command, originally 12% or 14%, but now very much less, and varying, of course, with the market. It lends to members only, but to any amount, for any purpose and on any good and sufficient security, whether acceptance, promissory note, overdraft, discount, mortgage, pledge, surety or what not. The loans, however, are always for a short period,

*Germany and credit co-operation.*

*Raiffeisen loan banks.*

*Schulze-Delitzsch banks.*

usually three months, renewable for another three months, and sometimes further than that. The committee of management are elected by the general meetings; they decide on all loans, and receive a salary, plus a commission on the business done. The council of supervision are also paid, or at least entitled to pay. The great objects which a bank keeps in view are security and a good return on capital. It is not confined to a small area, but works for as large and as varied a constituency as possible. With such a constitution the Schulze-Delitzsch banks grow big and accumulate a large capital of their own. On an average each bank has nearly 600 members and lends about £150,000 per annum, including loans renewed. Losses are sometimes made, but they are not heavy on the whole. All the profits are divided upon capital, or put to reserve, except some, usually small, sums given to charitable or educational purposes. Dividends average about 5%, but have been known to reach and even exceed 30%.

It may therefore justly be said that for co-operative institutions these banks smack too much of joint-stockism: they are in fact co-operative not much more than in the same sense that the Oldham cotton mills, and other "working-class limiteds," have sometimes been loosely called co-operative. They seem constituted to make the lender's interest supreme, but they have, nevertheless, conferred enormous benefits on the handicraftsmen, small traders, small cultivators and others who borrow from them. They have put capital within their reach at reasonable rates.

These banks also have their central point. In 1864 the German Co-operative Societies' Bank was founded to centralize the work of the local Schulze-Delitzsch banks and to bring the money market within their reach. It was not itself co-operative, and never confined its business to the co-operative banks. Beginning in a very small way, by 1903 it had attained a capital of a million and a half sterling and a yearly business of £154,000,000, of which £28,000,000 was specifically with co-operative credit societies. It was then amalgamated with another banking business, the *Dresdner Bank*, esteemed one of the most important and successful in Germany.

Thus these two types of credit co-operation agree in being founded on unlimited liability, but speaking broadly they are contrasted in that the Schulze-Delitzsch banks work primarily, though by no means solely, among townsmen, are based on share capital, work for profit, which they divide on shares, are conducted by paid directors, and confer their benefits not on the very poorest but rather, as their own friends say, on the middle classes; the Raiffeisen banks are designed for the peasantry, are not based upon share capital, neither divide, nor work for profit, are conducted by unpaid directors, and confer their benefits especially on the very poor. The Schulze-Delitzsch type is strong in self-help, but tends to commercialism as it grows; the other needs the help of the well-to-do to back up the self-help of the poor, but it tends to altruism and the union of classes.

The world has 30,000 co-operative credit societies, not counting building societies; and though they are organized in many groups, especially in their native Germany, for local reasons, or because of some modification, or some compromise between the two systems, the two types really include them all. There is, however, a strong tendency to introduce limited liability into various offshoots of the one type and the other; even into the orthodox Schulze-Delitzsch banks themselves, when they grow big. From Germany co-operative banks have spread into almost all European countries—even at last to Ireland and England—and to America and Asia. In Germany there are some fifteen thousand local, and no less than sixty central, co-operative credit associations, which lend out £180,000,000 a year including renewals. In Italy, Austria and Hungary they are also strong. In 1896 it was estimated that £150,000,000 a year must be very well within the total amount lent by money co-operation on the continent of Europe; eight years later it could not well fall short of £250,000,000, and the amount keeps constantly increasing. Of this total only a small percentage represents loans by banks of

the Raiffeisen type, which, though very numerous, often lend only a few hundred pounds each in the year.

Great controversy has prevailed as to the state subsidies given to co-operative credit. While governments are sometimes rather inclined to hinder co-operative distribution, they have shown a marked tendency to foster, whether for political or economic reasons, co-operative credit. The Prussian government in response to popular demand, vigorously supported by the agricultural interest, has founded and endowed with £2,500,000 of public money, the Central Co-operative Bank, whose object is to bring capital within the reach of the various groups of co-operative banks. The Schulze-Delitzsch Union was the only one to dispute the need of this, and though the bank has given a stimulus to the formation of co-operative societies, it still denies that this is a healthy propagation. Nevertheless, some even of the Schulze-Delitzsch societies resort to this state bank for money. It is under government administration and lends immense sums each year. In France the Bank of France has been compelled to lend £1,600,000 free of interest, and to give about £120,000 per annum out of its profits to assist agriculture; this money is being lent free to "regional" banks, and by them at about 3% to local societies. State help has also been given to the co-operative bank of the French workmen's productive societies. In Austria and in many other countries a great deal of similar help has been given.

Closely connected with certain developments of credit, and deserving to rank as the third, if not the second, great subdivision of co-operation, is agricultural co-operation, a movement in the main of the last twenty years, but amounting now to a great force, almost everywhere except in Great Britain, and in some countries almost to a revolution. It is important to say agricultural co-operation and not co-operative agriculture, for in spite of some customary mutual help in farm work, in spite of several attempts, and some small successes, in co-operative farming, the actual cultivation is almost everywhere individualistic; the farmer or peasant cultivates alone; or with his family, or servants; when he co-operates with his fellows, it is to manufacture, or to market, the products of his farm, or more often to obtain the things he needs for his farming, to raise stock, to own expensive machinery in common, or insure against risks. By these means the small farmer, without sacrificing his own peculiar advantages, obtains most of the advantages of the big farmer, to the immense improvement of his position.

At almost every point agricultural and credit co-operation touch; yet the most perfect example of agricultural co-operation is not concerned with credit co-operation in any form. The farmers of Denmark practise co-operation in almost every variety, except for raising capital: The commercial banks have provided money to start dairies and other co-operative societies; so that, it would appear, the need of credit co-operation has not been felt.

The Danish farmer is almost always a freeholder: it is little more than a century since his ancestors were serfs. It is little more than a generation since a few men, turning to account the strong national feeling aroused by the defeat of 1864, started a great educational movement which has left its mark on all strata of Danish society. After the People's High School, technical schools arose in various places; and to these, and to the excellent continuation schools in the country districts, the Danes are beholden for the regeneration of their agriculture. From 1867 co-operative distributive societies on the Rochdale plan had been spreading in Denmark; but it was not till 1882 that co-operation in agriculture began, and the first co-operative dairy was formed; ten years later there were about a thousand such, a number which has slightly increased since. These dairies are productive societies in which the cow-owners are the shareholders, and all shareholders have equal rights and equal voting power, whether they own one cow or one hundred. Almost every village has its co-operative dairy, fitted to deal with the milk of from 400 to 1400, or even 2000 cows. They far exceed all the other dairies of Denmark. More than four-fifths of all the milk of Denmark

*Denmark and agricultural co-operation.*

is used in them, and they produce butter worth more than nine millions sterling. The profits are divided among those who supply the cream, in proportion to the value of their supplies—a method of dividing profits characteristic of agricultural co-operation. The village dairies are united in federations to export their produce.

Side by side with the dairies are other co-operative societies, quite independent but largely composed of the same members, for buying collectively fodder, manures and other agricultural or household requisites, for collecting and exporting eggs, slaughtering hogs and curing bacon, improving the breed of stock, for bee-keeping, fruit-growing and so forth. By means of these societies the country has been greatly enriched. The farmer not uncommonly belongs to ten co-operative societies, besides probably a farmers' club. The work of starting and administering the societies is seldom paid, and many farmers give much time to it gratuitously. They are in the main organized on the same principles as the dairies, but with variations; the largest egg export society, for instance, has over 30,000 members. It is not a federation of village societies, but a centralized body with many branches.

The growth of the bacon-curing societies has been remarkable. The first of them was not founded until 1887, but they spread rapidly, and in seven years there were twenty, killing more than half the country's then produce of hogs. The movement has greatly increased since then, and multiplied its output about fourfold. Co-operation in collecting, grading and exporting eggs only began in 1895, and in eight years 65,000 members had joined the various egg societies, and the value of eggs exported had reached £436,000. Taken as a whole, the effect of agricultural co-operation in Denmark has amounted to little less than a revolution. It has brought the results of science within the peasant's reach, and he has been quick to avail himself of them: it has transformed a great part of farm work into a factory industry, increased the yield of the soil, improved the material position of the peasants, and drawn rich and poor together. Denmark, once so poor, is now, except England, probably the richest country in Europe in proportion to its population. Besides Denmark, Germany, France, Italy, Belgium, Holland, Finland, Australia, New Zealand, the United States, Canada, Ireland and many other countries have important developments of agricultural co-operation. In Germany, where it is closely connected with credit co-operation, it seems to date from 1866 only, yet in forty years agricultural co-operative societies have come to number six thousand, without counting the agricultural banks, which exceed twice that number. There are dairies, societies to purchase farm requisites, societies of grape-growers, hop-growers and beetroot-growers, distilleries, labour societies, insurance societies, societies to own warehouses and granaries and to sell produce, to purchase land and resell it in small holdings, and even several societies which purchase land to cultivate it in common. The close connexion between credit-societies and other agricultural co-operation is exemplified in the Central Union of orthodox Raiffeisen credit societies at Neuwied. Through a central bank and a trading department allied to it, it has negotiated the joint purchase of coal, feeding-stuffs, manures, machinery and so forth to large amounts, as well as the difficult business of the combined sale of agricultural produce. Moreover, several local centres connected with this union have granaries and warehouses for the storage of agricultural produce, and negotiate joint sales, while within the union facilities have been found for selling the products of one district to members in another.

In Ireland stores have not hitherto flourished, though a few exist. Irish co-operation is agricultural, and dates from the foundation of one co-operative dairy in 1889. Thence has grown a movement already of great importance, still advancing and comprising from eighty to ninety thousand members, belonging to some hundreds of societies—dairies, agricultural supply societies, banks and so forth, formed on the Danish model. To form a dairy the small working farmers of a district register a society and take up

shares of £1 each, in proportion to the number of their cows. Each brings his milk to be separated, is paid for the butter-making material it contains, and receives back skim milk. If any profit is divided, it belongs nine-tenths to the suppliers of milk in proportion to the value of their supplies, and one-tenth to the dairy employees as dividend on wages in pursuance of the co-partnership principle. These dairies produce butter worth more than £1,000,000. Their rapid spread is due to their great influence in improving the quality of butter, and hence increasing the farmer's gains. The co-operative banks are of the Raiffeisen type, though a few have limited liability. They aim at providing the peasants with necessary capital ("the lucky money" they have christened it) and expelling the usurer. They are increasing rapidly. Among other objects of Irish co-operation are selling eggs, poultry, barley and pigs, joint-grazing, potato-spraying, scutching flax, bacon curing, home industries, and of course supplying farm requisites. The movement promises much further growth in magnitude and variety. The dairy societies have federated into an agency for reaching the English market, and the supply societies into an Irish Wholesale for purchasing to the best advantage. Besides the direct profits and economies of these societies, they have greatly benefited Ireland by teaching men of all classes, parties and religions to act together for peaceful progress; they have led to a wide diffusion of better agricultural knowledge, and to the establishment by government of the Agricultural Department. (See IRELAND.)

In France, which Englishmen are apt to speak of as pre-eminently the country of co-operative production, the agricultural is the most important branch of co-operation; and the source and mainstay of agricultural co-operation are the *Syndicats Agricoles*. These are not technically co-operative societies; they are rather trade unions, not indeed of wage-earners only, or mainly, but of cultivators. They cannot legally trade, being constituted for the study and protection of the general interests of the members, the spread of information, and so forth. Their principal object however, seems in many cases to be to combine their members for the purchase of all farm requisites and especially of chemical manures. This they do by collecting, sorting and passing on orders. They cannot usually manage selling in common without the intervention of a society specially registered for that object. Beginning only in 1893, their number long ago ran into thousands and their membership into hundreds of thousands, drawn from all classes of cultivators and landowners, great and little. Among much other good work they have led to the formation of a large number of strictly co-operative societies for all the purposes of agriculture, except cultivation in common. Thus there are two thousand agricultural banks, besides butter factories, distilleries, associations for threshing, for sale of fruit and vegetables, for wine-making, oil-pressing, and so on, amounting altogether to some hundreds. There are also societies, mostly of ancient date, engaged in making Gruyère cheese: a few years ago these numbered 2000, but they are dwindling. Lastly, there are some eight thousand mutual insurance societies organized as agricultural syndicates.

Everywhere the main features of this agricultural movement are similar to those we have seen in Denmark and Ireland; it is supplementary to individual cultivation; hardly ever does it appear as associations for cultivating in common, and, speaking with certain important exceptions, it has no very ideal aims, but seeks chiefly to give the farmer a better profit. In England there are a number of farms worked by stores, and several large associations for the supply of farm requisites; but the typical agricultural co-operation, based on small village societies and federations of such societies, has only recently been made known and begun to take root.

It is notable that while the *Syndicats agricoles* are almost exactly what Fourier, the Robert Owen of France, foresaw as the next stage of social development, the other great branch of French co-operation, the workshop movement of the *Associations*

*Irish  
agri-  
culture.*

*Co-operative  
agri-  
culture  
in France  
and other  
countries.*

*ouvrières de production*, is directly due to his teaching, which led in 1848 to the starting of a large number of co-operative workshops. The suppression of association after the advent of Napoleon III. killed most of them, but with the return of liberty they revived and they have steadily increased ever since. They vary somewhat among themselves, but are in the main combinations of workmen to carry on their industries with their own capital or that of their trade unions. Their chief difference from English co-partnership societies is that they very rarely admit to membership any persons not belonging to the trade. They are engaged in a great variety of industries, selling comparatively little to co-operative distributive societies, as English co-partnership societies do, but taking contracts from government departments and the municipalities, and supplying the general public. Complete statistics of their total trade are not available, but it exceeds £2,000,000, and the separate societies seem to vary, like the majority of English co-partnership societies, from about £40,000 a year downwards, a few being larger but the great majority small. From about 140 societies in 1896 they have grown to between two and three times that number, and the increase continues with rapidity. More than two hundred of them are federated in the *Chambre consultative des associations ouvrières de production*, which looks after certain business interests of the societies, and also assists the formation of new ones by propaganda and advice. In Paris alone about a third of these societies are found.

It has been objected that their growth is artificial inasmuch as the government gives them certain advantages, such as preference over the private contractor at an equal price, exemption from the deposit of security, and special concessions as to payments on account. It also grants a subvention (recently about £7000 per annum), which was formerly all given to the societies in grants, but is now largely lent to them at not more than 2% interest through their own special bank. This bank was founded in 1893 to help the societies with loans and discounts, and was soon after endowed by a disciple of Fourier with £20,000. The societies have also benefited by other private beneficence and public help. As to the Government aid, it must be remembered that in France the state helps all forms of industry in ways unknown to us, and the French co-operative producers always declare that what is done for them is a trifle compared to what is done for other manufacturers. Moreover, they get many large contracts in open and unaided competition. In these societies the *auxiliaires*, or workers who are not members, are often numerous; but no society is now admitted to their federation which does not share profits with the *auxiliaires* and facilitate their admission to membership.

Consumers' co-operation, credit co-operation, agricultural co-operation, and workshop co-operation, as exemplified in Great Britain, Germany, Denmark and France, are found in most advanced countries, some in one and some in another, in forms roughly similar to those above described. Of co-operation for production it might have been said, a few years ago, that outside Great Britain it everywhere meant associations of producers. Except bakeries, there was but little consumers' production; that, however, seems now to be spreading in foreign countries also. The most important developments of co-operation not yet described are the socialist co-operation of Belgium, the co-operative building societies of the United States, the labour societies of Italy and Russia, the co-operation of German craftsmen to provide themselves with raw material, and the letting out of railway construction to temporary co-operative groups of workmen by the New Zealand and Victorian governments.

In Belgium co-operation is mostly socialist in the towns and Catholic in the country. In all the principal industrial centres are very important co-operative bakeries and distributive societies, owned by co-operative groups, numbering thousands of workmen of every calling. These *Maisons du peuple* are admitted to be well managed, even by those who dislike their politics. The socialist party look upon them chiefly as a means

of organizing and educating the working classes for political and economic emancipation, and of providing funds for political warfare. Like the English stores, and allied societies, they are based on the consumer, but unlike them they pay no interest on share capital, though they do on deposits. A much larger part of the profit than in England is devoted to propaganda and common purposes, though a part is also paid to the consumers individually in the form of checks exchangeable for bread or other goods. The workers employed also receive a share of profit as a dividend on their wages, and elect their representatives on the committee of management. By means of these societies the party has a press, buildings, and the funds to fight elections and support members in parliament. In France, where the store movement has been of an individualistic, and often middle class, tendency, the socialists have lately imitated the example of Belgium, and seem to be winning more success than the older French stores.

In the United States there has long been much important agricultural co-operation, and there have been many much-advertised attempts to establish Rochdale co-operation, but there have so often been failures and even dishonesties that co-operation has had a bad odour in the country, and the developments come and go with such rapidity that it is difficult to speak with confidence of its stability. The branch of co-operation which has been a great success in the United States consists of the great co-operative building societies, but building societies are not considered part of the co-operative movement in Great Britain.

Co-operation of all kinds is greatly developed in Italy, but one form is specially notable. The *Società di lavoro* are co-operative labour gangs of great importance. They are counted by hundreds, and are found among navvies, builders, masons, carriers, stevedores, agricultural labourers and other workmen, and have carried out very great works in Italy and in foreign countries. They have, for instance, drained lands in the Campagna and made a railway in Greece. They differ from productive societies markedly in that they have comparatively little to do with capital or material, but contract mainly for labour.

The Slavonic races seem to have a special aptitude for grouping together co-operatively: it is said that men meeting casually on a journey will do so for the brief time they are together. In countries like Serbia we see this ancient, and more or less customary, loose and unstable co-operation meeting the modern contractual, permanent co-operation of banks and other registered societies. So in Russia, where so large a part in the national organization is played by the *Artel* (see RUSSIA), which may be a transitory co-operative group of workmen undertaking a particular piece of work, e.g. to build a house, or a permanent association like that of the bank porters combined together to guarantee one another's honesty.

While English and some other forms of co-operation have always repudiated state help, and probably rightly, so far as their own work is concerned, the state in almost all *State help* countries, and conspicuously in England, has in fact helped to the extent of providing special legislation, and waiving fees, so as to encourage the formation of co-operative societies. A second form of state help is very noticeable in the modern development of agriculture, as in Denmark, Canada, New Zealand, Ireland and very many countries, where the state has played a great part in performing or assisting functions which neither voluntary association nor individual enterprise could well perform alone; in providing technical education, expert advisers, exhibitions and prizes; in distributing information in all forms; in finding out markets, controlling railway rates, subsidizing steamboats, and even grading, branding, warehousing and freezing produce, and maintaining trade agents abroad. These things have not been done for co-operative societies alone, but for agriculture in general; but co-operation has chiefly benefited, and much has been done expressly to encourage the formation of associations of cultivators, and provincial and national federations of such associations; and government departments of agriculture are found acting through such bodies, and with their advice and assistance. The third and most questionable

form of state help is by direct subventions, and we have seen how much has been done in this way for credit co-operation and particularly agricultural credit. Harm has undoubtedly been done in certain cases by forcing co-operative societies, whether from political motives or merely mistaken policy. Yet even as to money subventions, good authorities, while admitting the great dangers, remain convinced that the advantages overbalance them, self-help being evoked, and helped over initial difficulties which would otherwise be insuperable. Experience in fact shows that governments can do a very great deal, at least for agricultural co-operation, but only on condition that they encourage, and do not undermine, self-help and private initiative. Thus while voluntary association is sometimes advocated as a step towards, and sometimes on the other hand as a substitute for, and bulwark against, state socialism, we find in practice these two forces working each in its own sphere, and in ways complementary one to the other, while underlying and essential to both is the force of individual action and self-help.

We have now surveyed co-operation in its chief forms and in some of the countries where it is chiefly found. Some years ago it was roughly estimated that the members of one or other of its branches numbered six millions, representing with their families a population of 25,000,000 people. This must be much within the truth to-day. In no other country so much as in Great Britain do we find the tendency for all branches of co-operation to federate in one union and to help one another by mutual trade. Yet everywhere the instinct of co-operative societies is to federate with others—at least with others of their own particular shade; so that Wholesales and other federations are found more and more in many countries. Since 1895 the co-operators and co-operative societies of many far-distant lands—almost of the whole world—have been drawn together by the International Co-operative Alliance, a body which, without attempting to interfere in their differences, collects information from all, and distributes it to all, keeps them all in touch, and every few years calls their delegates together in congress, to discuss their problems, and to remember their common ideals.

**BIBLIOGRAPHY.**—International Co-operative Alliance, *International Co-operative Bibliography* (London, 1906); G. J. Holyoake, *History of Co-operation* (London, 1875-1879, new ed., 1906), *History of the Rochdale Pioneers* (London, 1893, new ed., 1900), *Self-Help a Hundred Years Ago* (London, 3rd ed., 1891), *Co-operative Movement of To-day* (London, 1891, new ed., 1896); Lloyd Jones, *Life and Times and Labours of Robert Owen* (London, 1890, new ed., 1895); F. Podmore, *Robert Owen* (London, 1906); E. T. Craig, *History of Ralahine* (London, 1882, new ed., 1893); Thomas Hughes and E. V. Neale, *A Manual for Co-operators* (Manchester, 1881, 1888); Catherine Webb (editor), *Industrial Co-operation* (Manchester, 1904); Beatrice Potter (Mrs Sidney Webb), *Co-operative Movement in Great Britain* (London, 1891, 1893, 1904); A. H. D. Acland and B. Jones, *Working Men Co-operators* (1898); Benjamin Jones, *Co-operative Production* (London, 1894); C. R. Fay, *Co-operation at Home and Abroad* (London, 1908); H. D. Lloyd, *Labour Co-partnership* (London and New York, 1898); D. F. Schloss, *Methods of Industrial Remuneration* (London, 2nd ed., 1894); N. P. Gilman, *Profit Sharing* (London, 1892); C. Robert, *Guide pratique de la participation* (Paris, 1892); Aneurin Williams, *Twenty-eight Years of Co-partnership at Guise* (Letchworth, 1908), *Relations of Co-operative Movement to National and International Commerce* (Manchester, 1896); Dallet-Fabre-Prudhommeaux, *Le Familistère illustré* (Paris, 1901); Bernadot, *Le Familistère de Guise* (Guise, 1892); E. O. Greening, *The Co-operative Traveller Abroad* (London, 1888); H. W. Wolff, *People's Banks* (London, 1893, 1896), *Co-operative Banking, its Principles and Practice, with a chapter on Co-operative Mortgage Credit* (London, 1907); de Rocquigny, *La Co-opération de production dans l'agriculture* (Paris, 1896); Merlin, *Les Associations ouvrières et patronales*, &c. (Paris, 1900); Mabileau and others, *La Prévoyance sociale en Italie* (Paris, 1898); Fr. Müller, *Wesen, Grundsätze und Nutzen der Consumvereine* (Basel, 1900). See also the annual Reports of the Government Labour Departments, and the *Monthly Bulletin* of the Internat. Co-op. Alliance. (A. Wl.)\*

**COOPERSTOWN**, a village and the county-seat of Otsego county, New York, U.S.A., where the Susquehanna river emerges from Otsego Lake; about 92 m. (by rail) W. of Albany. Pop. (1890) 2657; (1900) 2368; (1905, state census) 2446. It is served by the Cooperstown & Charlotte Valley railway (owned and controlled by the Delaware & Hudson), and is on the line of

the Oneonta & Mohawk Valley electric railway. The village lies in the midst of a hop-growing and dairying region, and has cheese factories and creameries. It has a public library, Thanksgiving hospital, a Y.M.C.A. hall, and the Diocesan orphanage (Protestant Episcopal). Cooperstown is a summer resort, Otsego Lake (9 m. long and with an average width of about 1 m.), the "Glimmerglass" of Cooper's novels, being one of the most picturesque of the New York lakes. Cooperstown occupies the site of an old Indian town. In 1785 the site became the property of Judge William Cooper, who in the following year founded there a village which took his name and was incorporated in 1807. Judge Cooper himself settled here with his family in 1790. His son, James Fenimore Cooper, who lived here for many years and is buried in the Episcopal cemetery here, made the region famous in his novels.

See J. Fenimore Cooper, *The Chronicles of Cooperstown* (Cooperstown, 1838).

**COOPER UNION**, a unique educational and charitable institution "for the advancement of science and art" in New York city. It is housed in a brownstone building in Astor Place, between 3rd and 4th Avenues immediately N. of the Bowery, and was founded in 1857-1859 by Peter Cooper, and chartered in 1859. In a letter to the trustees accompanying the trust-deed to the property, Cooper said that he wished the endowment to be "for ever devoted to the advancement of science and art, in their application to the varied and useful purposes of life"; provided for a reading-room, a school of art for women, and an office in the Union, "where persons may apply . . . for the services of young men and women of known character and qualifications to fill the various situations"; expressed the desire that students have monthly meetings held in due form, "as I believe it to be a very important part of the education of an American citizen to know how to preside with propriety over a deliberative assembly"; urged lectures and debates exclusive of theological and party questions; and required that no religious test should ever be made for admission to the Union. Cooper's most efficient assistant in the Union was Abram S. Hewitt. In 1900 Andrew Carnegie put the finances of the Union on a sure footing by gifts aggregating \$600,000. For the year 1907 its revenue was \$161,228 (including extraordinary receipts of \$25,565, from bequests, &c.), its expenditures \$161,390; at the same time its assets were \$3,870,520, of which \$1,070,877 was general endowment, building and equipment, and \$2,797,728 was special endowments (\$205,000 being various endowments by Peter Cooper; \$340,000, the William Cooper Foundation; \$600,000, the Cooper-Hewitt Foundation; \$391,656, the John Halstead Bequest; \$217,820, the Hewitt Memorial Endowment). The work has been very successful, the instruction is excellent, and the interest of the pupils is eager. All courses are free. The reading-room and library contain full files of current journals and magazines; the library has the rare complete old and new series of patent office reports, and in 1907 had 45,760 volumes; in the same year there were 578,582 readers. There is an excellent museum for the arts of decoration. Apart from valuable lecture courses, the principal departments of the Union, with their attendance in 1907, were: a night school of science—a five-year course in general science (667) and in chemistry (154), a three-year course in electricity (114), and a night school of art (1333); a day school of technical science—four years in civil, mechanical or electrical engineering—(237); a woman's art school (282); a school of stenography and typewriting for women (55); a school of telegraphy for women (31); a class in elocution (96); and classes in oratory and debate (146). During the year 2505 was the highest number in attendance at any time, and then 3000 were on the waiting list.

In the great hall of the Union free lectures for the people are given throughout the winter; one course, the Hewitt lectures, in co-operation with Columbia University, "of a very high grade, corresponding more nearly to those given by the Lowell Institute in Boston"; six (in 1907) courses in co-operation with the Board of Education of New York city, which, upon Mayor Hewitt's suggestion, made an appropriation for this work in



1887-1888, and extended such lecture courses to different parts of the city, all under the direction (after 1890) of Henry M. Leipziger (b. 1854), and several courses dealing especially with social and political subjects, and including, besides lectures and recitals, public meetings for the discussion of current problems.

**CO-OPTATION** (from Lat. *co-optare*; less correctly "co-option"), the election to vacancies on a legislative, administrative or other body by the votes of the existing members of the body, instead of by an outside constituency. Such bodies may be purely co-optative, as the Royal Academy, or may be elective with power to add to the numbers by co-optation, as municipal corporations in England.

**COORG** (an anglicized corruption of *Kodagu*, said to be derived from the Kanarese *Kudu*, "steep," "hilly"), a province of India, administered by a commissioner, subordinate to the governor-general through the resident of Mysore, who is officially also chief commissioner of Coorg. It lies in the south of the peninsula, on the plateau of the Western Ghats, sloping inland towards Mysore. It is an attractive field of coffee cultivation, though the greater part is still under forest, but the prosperity of the industry has declined since 1891. The administrative headquarters are at Mercara (pop. 6732). Coorg is the smallest province in India, its area being only 1582 sq. m. Of this amount about 1000 sq. m. consist of ghat, reserved and other forests. Coorg was constituted a province not on account of its size, but on account of its isolation. It lies at the top of the Western Ghats, and is cut off by them from easy communication with the British districts of South Kanara and Malabar, which form its western and southern boundaries, while on its other sides it is surrounded by the native state of Mysore. It is a mountainous district, presenting throughout a series of wooded hills and deep valleys; the lowest elevations are 3000 ft. above sea-level. The loftiest peak, Tadiandamol, has an altitude of 5729 ft.; Pushpagiri, another peak, is 5626 ft. high. The principal river is the Cauvery, which rises on the eastern side of the Western Ghats, and with its tributaries drains the greater part of Coorg. Besides these there are several large streams that take their rise in Coorg. In the rainy season, which lasts during the continuance of the southwest monsoon, or from June to the end of September, the rivers flow with violence and great rapidity. In July and August the rainfall is excessive, and the month of November is often showery. The yearly rainfall may exceed 160 in.; in the dense jungle tract it reaches from 120 to 150; in the bamboo district in the west from 60 to 100 in. The climate, though humid, is on the whole healthy; it is believed to have been rendered hotter and drier by the clearing of forest land. Coorg has an average temperature of about 60° F., the extremes being 52° and 82°. The hottest season is in April and May. In the direction of Mysore the whole country is thickly wooded; but to the westward the forests are more open. The flora of the jungle includes *Michelia* (Chumpak), *Mesua* (Ironwood), *Diospyros* (Ebony and other species), *Cedrela toona* (White cedar), *Chickrassia tubularis* (Red cedar), *Calophyllum angustifolium* (Poon spar), *Canarium strictum* (Black Dammar tree), *Artocarpus*, *Dipterocarpus*, *Garcinia*, *Euonymus*, *Cinnamomum iners*, *Myristica*, *Vaccinium*, *Myrtaceae*, *Melastomaceae*, *Rubus* (three species), and a rose. In the undergrowth are found cardamom, areca, plantain, canes, wild pepper, tree and other ferns, and arums. In the forest of the less thickly-wooded bamboo country in the west of Coorg the trees most common are the *Dalbergia latifolia* (Black wood), *Pterocarpus marsupium* (Kino tree), *Terminalia coriacea* (Mutti), *Lagerströmia parviflora* (Benteak), *Conocarpus latifolius* (Dindul), *Bassia latifolia*, *Butea frondosa*, *Nauclea parviflora*, and several acacias, with which, in the eastern part of the district, teak and sandalwood occur. Among the fauna may be mentioned the elephant, tiger, tiger-cat, cheetah or hunting leopard, wild dog, elk, bison, wild boar, several species of deer, hares, monkeys, the buceros and various other birds, the cobra di capello, and a few alligators. The most interesting antiquities of Coorg are the earth redoubts or war-trenches (*kadangas*), which are from 15 to 25 ft. high, and provided with a ditch 10 ft. deep by 8 or 10 ft. wide. Their linear extent is

reckoned at between 500 and 600 m. They are mentioned in inscriptions of the 9th and 10th centuries. The exports of Coorg are mainly rice, coffee and cardamoms; and the only important manufacture is a kind of coarse blanket. Fruits of many descriptions, especially oranges, are produced in abundance, and are of excellent quality.

In 1901 the population was 180,607, showing an increase of 4.4 % in the decade. Of the various tribes inhabiting Coorg, the Coorgs proper, or Kodagas, and the Yeravas, or Eravas, both special to the country, are the most numerous. The Kodagas (36,091) are a light-coloured race of unknown origin. They constitute a highland clan, free from the trammels of caste, and they have the manly bearing and independent spirit natural in men who have been from time immemorial the lords of the soil. Their religion consists of ancestor- and demon-worship, with a certain admixture of Brahman cults. The men are by tradition warriors and hunters, and while they will plough the fields and reap the rice, they leave all menial work to the women and servants. They speak Kodagu, a dialect of Hala Kannada or old Kanarese, midway between that and Malayalam. It has been asserted that the institution of polyandry was prevalent among them, according to which the brothers of a family had their wives in common. But if this institution ever existed it no longer does so. The Yeravas (14,586) are a race of an altogether inferior type, dark-skinned and thick-lipped, resembling the Australian aborigines who possibly, according to one theory, may have sprung from the same Dravidian stock (see AUSTRALIA: *Aborigines*). Though now nominally free, they were, before the establishment of British rule, the hereditary praedial slaves of the Kodagas. Some of them live a primitive life in the jungle, but the majority earn a livelihood as coolies. They are demon-worshippers, their favourite deity being Karingali (black Kali). Their language, a dialect of Malayalam, is peculiar to them. Among the other tribes or castes special to Coorg are the Heggades (1503 in 1901), cultivators from Malabar; the Ayiri (898), who constitute the artisan caste; the Medas (584), who are basket- and mat-makers, and act as drummers at feasts; the Binepatta (98), originally wandering musicians from Malabar, now agriculturists; the Kavadi (49), cultivators from Yedenälknäd; all these speak the Coorg language, wear the Coorg dress, and conform, more or less, to Coorg customs. Other tribes are not special to Coorg. Of these the Holeyas (27,000) are the most numerous. They are divided into four sections: Badagas from Mysore, Kembattis and Māringis from Malabar, Kukkas from S. Kanara. They were formerly the slaves of the Kodagas and now act as their menials. The Lingayats (8700) are rather a religious sect than a tribe. Of the Tulu (farmer) class the Gaudas (11,900), who live principally along the western boundary, are the most important; they speak Tulu and wear the Coorg dress. Other castes and tribes are the Tiyas (1500) and Nayars (1400), immigrants from Malayalam; the Vellala (1300), who are Tamils; the Mahrattas (2400) and Brahmans (1100). Of the Mussulmans the most numerous are the Moplals (6700) and the Shaikhs (4400), both chiefly traders. Of native Christians there are upwards of 3000. The official language of Coorg, which is that spoken by 45 % of the population, is Kanarese (Kannada), the Coorg language (Kodagu) coming next. The Coorg dress is very picturesque, its characteristics being a long coat (Kupasa), of dark-coloured cloth, reaching below the knees, folded across and confined at the waist by a red or blue girdle. The sleeves are cut off below the elbow, showing the arms of a white shirt. The head-dress is a red kerchief, or a peculiar large, flat turban, covering the back of the neck. The Coorg also carries a short knife, with an ivory or silver hilt, fastened with silver chains and stuck into the girdle. A large, broad-bladed waist knife, akin to the *kukri* of the Gurkhas, worn at the back, point upwards, was formerly a formidable weapon in hand-to-hand fighting, but is now used only for exhibitions of strength and skill on festive occasions.

The chief crops are rice and coffee. Some abandoned coffee land has been planted with tea as an experiment. The cultivation of cinchona has proved unprofitable. There is no railway;



There are no colleges, but twenty-four scholarships are given to maintain Coorg students at colleges in Madras and Mysore. There are secondary schools at Mercara and Virarajendrapet.

The early accounts of Coorg are purely legendary, and it was not till the 9th and 10th centuries that its history became the subject of authentic record. At this period, according to inscriptions, the country was ruled by the Gangas of Talakād, under whom the Changalvas, kings of Changa-nād, styled later kings of Nanjarayapatna or Nanjarajapatna, held the east and part of the north of Coorg, together with the Hunsur *taluk* in Mysore. After the overthrow, in the 11th century, of the Ganga power by the Cholas, the Changalvas became tributary to the latter. When the Cholas in their turn were driven from the Mysore country by the Hoysalas, in the 12th century, the Changalvas held out for independence; but after a severe struggle they were subdued and became vassals of the Hoysala kings. In the 14th century, after the fall of the Hoysala rule, they passed under the supremacy of the Vijayanagar empire. During this period, at the beginning of the 16th century, Nanja Raja founded the new Changalva capital Nanjarajapatna. In 1589 Piriya Raja or Rudragana rebuilt Singapatna and renamed it Piriapatna (Periapatam). The power of the Vijayanagar empire had, however, been broken in 1565 by the Mahomedans; in 1610 the Vijayanagar viceroy of Seringapatam was ousted by the raja of Mysore, who in 1644 captured Piriapatna. Vira Raja, the last of the Changalva kings, fell in the defence of his capital, after putting to death his wives and children.

Coorg, however, was not absorbed in Mysore, which was hard pressed by other enemies, and a prince of the Ikkeri or Bednur family (perhaps related to the Changalvas) succeeded in bringing the whole country under his sway, his descendants continuing to be rajas of Coorg till 1834. The capital was removed in 1681 by Muddu Raja to Madikeri or Mercara. In 1770 a disputed succession led to the intervention of Hyder Ali of Mysore in favour of Linga Raja, who had fled to him for help, and whom he placed on the throne on his consenting to cede certain territories and to pay tribute. On Linga Raja's death in 1780 Hyder Ali interned his sons, who were minors, in a fort in Mysore, and, under pretence of acting as their guardian, installed a Brahman governor at Mercara with a Mussulman garrison. In 1782, however, the Coorgs rose in rebellion and drove out the Mahomedans. Two years later Tippoo Sultan reduced the country; but the Coorgs having again rebelled in 1785 he vowed their destruction. Having secured some 70,000 of them by treachery, he drove them to Seringapatam, where he had them circumcised by force. Coorg was partitioned among Mussulman proprietors, and held down by garrisons in four forts. In 1788, however, Vira Raja (or Vira Rajendra Wodeyar), with his wife and his brothers Linga Raja and Appaji, succeeded in escaping from his captivity, at Periapatam and, placing himself at the head of a Coorg rebellion, succeeded in driving the forces of Tippoo out of the country. The British, who were about to enter on the struggle with Tippoo, now made a treaty with Vira Raja; and during the war that followed the Coorgs proved invaluable allies. By the treaty of peace Coorg, though not adjacent to the East India Company's territories, was included in the cessions forced upon Tippoo. On the spot where he had first met the British commander, General Abercromby, the raja founded the city of Virarajendrapet.

Vira Raja, who, in consequence of his mind becoming unhinged, was guilty towards the end of his reign of hideous atrocities, died in 1809 without male heirs, leaving his favourite daughter Devammāji as rani. His brother Linga Raja, however, after acting as regent for his niece, announced in 1811 his own assumption of the government. He died in 1820, and was succeeded by his son Vira Raja, a youth of twenty, and a monster of sensuality and cruelty. Among his victims were all the members of the families of his predecessors, including Devammāji. At last, in 1832, evidence of treasonable designs on the raja's part led to inquiries on the spot by the British resident at Mysore, as the result of which, and of the raja's refusal to amend his ways, a British force marched into Coorg in 1834. On the 11th of April

the raja was deposed by Colonel Fraser, the political agent with the force, and on the 7th of May the state was formally annexed to the East India Company's territory. In 1852 the raja, who had been deported to Vellore, obtained leave to visit England with his favourite daughter Gauramma, to whom he wished to give a European education. On the 30th of June she was baptized, Queen Victoria being one of her sponsors; she afterwards married a British officer who, after her death in 1864, mysteriously disappeared together with their child. Vira Raja himself died in 1863, and was buried in Kensal Green cemetery.

The so-called Coorg rebellion of 1837 was really a rising of the Gaudas, due to the grievance felt in having to pay taxes in money instead of in kind. A man named Virappa, who pretended to have escaped from the massacre of 1820, tried to take advantage of this to assert his claim to be raja, but the Coorgs remained loyal to the British and the attempt failed. In 1861, after the Mutiny, the loyalty of the Coorgs was rewarded by their being exempted from the Disarmament Act.

See "The Coorgs and Yeravas," by T. H. Holland in the *Journal of the Asiatic Society of Bengal*, vol. lxx. part iii. No. 2 (1901); Rev. G. Richter, *Castes and Tribes found in the Province of Coorg* (Bangalore, 1887); *Imperial Gazetteer of India* (Oxford, 1908), vol. xi. s.v., where, besides an admirable account of the country and its inhabitants, the history of Coorg is dealt with in some detail.

**COORNHERT, DIRCK VOLCKERTSZOON** (1522-1590), Dutch politician and theologian, youngest son of Volckert Coornhert, cloth merchant, was born at Amsterdam in 1522. As a child he spent some years in Spain and Portugal. Returning home, he was disinherited by his father's will, for his marriage with Cornelia (Neeltje) Simons, a portionless gentlewoman. He took for a time the post of major-domo to Reginald (Reinoud), count of Brederode. Soon he settled in Haarlem, as engraver on copper, and produced works which retain high values. Learning Latin, he published Dutch translations from Cicero, Seneca and Boetius. He was appointed secretary to the city (1562) and secretary to the burgomasters (1564). Throwing himself into the struggle with Spanish rule, he drew up the manifesto of William of Orange (1566). Imprisoned at the Hague (1568), he escaped to Cleves, where he maintained himself by his art. Recalled in 1572, he was secretary of state for a short time; his aversion to military violence led him to return to Cleves, where William continued to employ his services and his pen. As a religious man, he wrote and strove in favour of tolerance, being decidedly against capital punishment for heretics. He had no party views; the Heidelberg catechism, authoritative in Holland, he criticized. The great Arminius, employed to refute him, was won over by his arguments. He died at Gouda on the 29th of October 1590. His Dutch version of the New Testament, following the Latin of Erasmus, was never completed. His works, in prose and verse, were published in 1630, 3 vols.

See F. D. J. Moorrees, *Dirck Volckertszoon Coornhert* (1887); N. Delvenne, *Biog. des Pays-Bas* (1829); A. J. van der Aa, *Biog. Woordenboek der Nederlanden* (1855). (A. Go.\*)

**COOT**, a well-known water-fowl, the *Fulica atra* of Linnaeus, belonging to the family *Rallidae* or rails. The word coot, in some parts of England pronounced cute, or scute, is of uncertain origin, but perhaps cognate with scout and scoter—both names of aquatic birds—a possibility which seems to be more likely since the name "macreuse," by which the coot is known in the south of France, being in the north of that country applied to the scoter (*Oedemia nigra*) shows that, though belonging to very different families, there is in popular estimation some connexion between the two birds.<sup>1</sup> The Latin *Fulica* (in polite French, *Foulque*) is probably allied to *fuligo*, and has reference to the bird's dark colour.<sup>2</sup> The coot breeds abundantly in many of the larger inland waters of the northern parts of the Old World, in winter commonly resorting, and often in great numbers, to the mouth of rivers or shallow bays of the sea, where it becomes a general object of pursuit by gunners whether for sport or gain.

<sup>1</sup> It is owing to this interchange of their names that Yarrell in his *British Birds* refers Victor Hugo's description of the "chasse aux macreuses" to the scoter instead of the coot.

<sup>2</sup> Hence also we have *Fulix* or *Fuligula* applied to a duck of dingy appearance, and thus forming another parallel case.

At other times of the year it is comparatively unmolested, and being very prolific its abundance is easily understood. The nest is a large mass of flags, reeds or sedge, piled together among rushes in the water or on the margin, and not unfrequently contains as many as ten eggs. The young, when first hatched, are beautiful little creatures, clothed in jet-black down, with their heads of a bright orange-scarlet, varied with purplish-blue. This brilliant colouring is soon lost, and they begin to assume the almost uniform sooty-black plumage which is worn for the rest of their life; but a characteristic of the adult is a bare patch or callosity on the forehead, which being nearly white gives rise to the epithet "bald" often prefixed to the bird's name. The coot is about 18 in. in length, and will sometimes weigh over 2 lb. Though its wings appear to be short in proportion to its size, and it seems to rise with difficulty from the water, it is capable of long-sustained and rather rapid flight, which is performed with the legs stretched out behind the stumpy tail. It swims buoyantly, and looks a much larger bird in the water than it really is. It dives with ease, and when wounded is said frequently to clutch the weeds at the bottom with a grasp so firm as not even to be loosened by death. It does not often come on dry land, but when there, marches leisurely and not without a certain degree of grace. The feet of the coot are very remarkable, the toes being fringed by a lobed membrane, which must be of considerable assistance in swimming as well as in walking over the ooze—acting as they do like mud-boards.

In England the sport of coot-shooting is pursued to some extent on the broads and back-waters of the eastern counties—in Southampton Water and Christchurch Bay—and is often conducted battue-fashion by a number of guns. But even in these cases the numbers killed in a day seldom reach more than a few hundreds, and come very short of those that fall in the officially-organized *chasses* of the lakes near the coast of Languedoc and Provence, of which an excellent description is given by the Vicomte Louis de Dax (*Nouveaux Souvenirs de chasse, &c.*, pp. 53-65; Paris, 1860). The flesh of the coot is very variously regarded as food. To prepare the bird for the table, the feathers should be stripped, and the down, which is very close, thick and hard to pluck, be rubbed with powdered resin; the body is then to be dipped in boiling water, which dissolving the resin causes it to mix with the down, and then both can be removed together with tolerable ease. After this the bird should be left to soak for the night in cold spring-water, which will make it look as white and delicate as a chicken. Without this process the skin after roasting is found to be very oily, with a fishy flavour, and if the skin be taken off the flesh becomes dry and good for nothing (Hawker's *Instructions to Young Sportsmen*; Hele's *Notes about Aldeburgh*).

The coot is found throughout the Palaearctic region from Iceland to Japan, and in most other parts of the world is represented by nearly allied species, having almost the same habits. An African species (*F. cristata*), easily distinguished by two red knobs on its forehead, is of rare appearance in the south of Europe. The Australian and North American species (*F. australis* and *F. americana*) have very great resemblance to the English bird; but in South America half-a-dozen or more additional species are found which range to Patagonia, and vary much in size, one (*F. gigantea*) being of considerable magnitude. The remains of a very large species (*F. newtoni*) were discovered in Mauritius, where it must have been a contemporary of the dodo, but like that bird is now extinct. (A. N.)

**COOTE, SIR EYRE** (1726-1783), British soldier, the son of a clergyman, was born near Limerick, and entered the 27th regiment. He saw active service in the Jacobite rising of 1745, and some years later obtained a captaincy in the 39th regiment, which was the first British regiment sent to India. In 1756 a part of the regiment, then quartered at Madras, was sent forward to join Clive in his operations against Calcutta, which was re-occupied without difficulty, and Coote was soon given the local rank of major for his good conduct in the surprise of the Nawab's camp. Soon afterwards came the battle of Plassey, which would in all probability not have taken place but for Coote's soldierly

advice at the council of war; and after the defeat of the Nawab he led a detachment in pursuit of the French for 400 m. under extraordinary difficulties. His conduct won him the rank of lieutenant-colonel and the command of the 84th regiment, newly-raised for Indian service, but his exertions seriously injured his health. In October 1759 Coote's regiment arrived to take part in the decisive struggle between French and English in the Carnatic. He took command of the forces at Madras, and in 1760 led them in the decisive victory of Wandiwash (January 22). After a time the remnants of Lally's forces were shut up in Pondicherry. For some reason Coote was not entrusted with the siege operations, but he cheerfully and loyally supported Monson, who brought the siege to a successful end on the 15th of January 1761. Soon afterwards Coote was given the command of the East India Company's forces in Bengal, and conducted the settlement of a serious dispute between the Nawab Mir Cassim and a powerful subordinate, and in 1762 he returned to England, receiving a jewelled sword of honour from the Company and other rewards for his great services. In 1771 he was made a K.B. In 1779 he returned to India as lieutenant-general commanding in chief. Following generally the policy of Warren Hastings, he nevertheless refused to take sides in the quarrels of the council, and made a firm stand in all matters affecting the forces. Hyder Ali's progress in southern India called him again into the field, but his difficulties were very great and it was not until the 1st of June 1781 that the crushing and decisive defeat of Porto Novo struck the first heavy blow at Hyder's schemes. The battle was won by Coote under most unfavourable conditions against odds of five to one, and is justly ranked as one of the greatest feats of the British in India. It was followed up by another hard-fought battle at Pollilur (the scene of an earlier triumph of Hyder over a British force) on the 27th of August, in which the British won another success, and by the rout of the Mysore troops at Sholingarh a month later. His last service was the arduous campaign of 1782, which finally shattered a constitution already gravely impaired by hardship and exertions. Sir Eyre Coote died at Madras on the 28th of April 1783. A monument was erected to him in Westminster Abbey.

For a short biography of Coote see *Twelve British Soldiers* (ed. Wilkinson, London, 1899), and for the battles of Wandiwash and Porto Novo, consult Malleson, *Decisive Battles of India* (London, 1883). An account of Coote may be found in Wilk's *Historical Sketches of Mysore* (1810).

**COPAIBA**, or **COPAIVA** (from Brazilian *cupauba*), an oleo-resin—sometimes termed a balsam—obtained from the trunk of the *Copaifera Lansdorfii* (natural order Leguminosae) and from other species of *Copaifera* found in the West Indies and in the valley of the Amazon. It is a somewhat viscous transparent liquid, occasionally fluorescent and of a light yellow to pale golden colour. The odour is aromatic and very characteristic, the taste acrid and bitter. It is insoluble in water, but soluble in absolute alcohol, ether and the fixed and volatile oils. Its approximate composition is more than 50% of a volatile oil and less than 50% of a resin. The pharmacopoeias contain the oleo-resin itself, which is given in doses of from a half to one drachm, and the *oleum copaibae*, which is given in doses of from five to twenty minims, but which is inferior, as a medicinal agent, to the oleo-resin. Copaiba shares the pharmacological characters of volatile oils generally. Its distinctive features are its disagreeable taste and the unpleasant eructations to which it may give rise, its irritant action on the intestine in any but small doses, its irritant action on the skin, often giving rise to an erythematous eruption which may be mistaken for that of scarlet fever, and its exceptionally marked stimulant action on the kidneys. In large doses this last action may lead to renal inflammation. The resin is excreted in the urine and is continually mistaken for albumin since it is precipitated by nitric acid, but the precipitate is re-dissolved, unlike albumin, on heating. Its nasty taste, its irritant action on the bowel, and its characteristic odour in the breath, prohibit its use—despite its other advantages—in all diseases but gonorrhoea. For this disease it is a valuable

remedy, but it must not be administered until the acute symptoms have subsided, else it will often increase them. It is best given in cachets or in three times its own bulk of mucilage of acacia. Various devices are adopted to disguise its odour in the breath. The clinical evidence clearly shows that none of the numerous vegetable rivals to copaiba is equal to it in therapeutic value.

**COPAL** (Mexican *copalli*, incense), a hard lustrous resin, varying in hue from an almost colourless transparent mass to a bright yellowish-brown, having a conchoidal fracture, and, when dissolved in alcohol, spirit of turpentine, or any other suitable menstruum, forming one of the most valuable varnishes. Copal is obtained from a variety of sources; the term is not uniformly applied or restricted to the products of any particular region or series of plants, but is vaguely used for resins which, though very similar in their physical properties, differ somewhat in their constitution, and are altogether distinct as to their source. Thus the resin obtained from *Trachylobium Hornemannianum* is known in commerce as Zanzibar copal, or gum animé. Madagascar copal is the produce of *T. verrucosum*. From *Guibourtia copallifera* is obtained Sierra Leone copal, and another variety of the same resin is found in a fossil state on the west coast of Africa, probably the produce of a tree now extinct. From Brazil and other South American countries, again, copal is obtained which is yielded by *Trachylobium Martianum*, *Hymenaea Courbaril*, and various other species, while the dammar resins and the piney varnish of India are occasionally classed and spoken of as copal. Of the varieties above enumerated by far the most important from a commercial point of view is the Zanzibar or East African copal, yielded by *Trachylobium Hornemannianum*. The resin is found in two distinct conditions: (1) raw or recent, called by the inhabitants of the coast sandarusiza miti or chakazi, the latter name being corrupted by Zanzibar traders into "jackass" copal; and (2) ripe or true copal, the sandarusi inti of the natives. The raw copal, which is obtained direct from the trees, or found at their roots or near the surface of the ground, is not regarded by the natives as of much value, and does not enter into European commerce. It is sent to India and China, where it is manufactured into a coarse kind of varnish. The true or fossil copal is found embedded in the earth over a wide belt of the mainland coast of Zanzibar, on tracts where not a single tree is now visible. The copal is not found at a greater depth in the ground than 4 ft., and it is seldom the diggers go deeper than about 3 ft. It occurs in pieces varying from the size of small pebbles up to masses of several ounces in weight, and occasionally lumps weighing 4 or 5 lb have been obtained. After being freed from foreign matter, the resin is submitted to various chemical operations for the purpose of clearing the "goose-skin," the name given to the peculiar pitted-like surface possessed by fossil copal. The goose-skin was formerly supposed to be caused by the impression of the small stones and sand of the soil into which the soft resin fell in its raw condition; but it appears that the copal when first dug up presents no trace of the goose-skin, the subsequent appearance of which is due to oxidation or intermolecular change.

**COPALITE**, or **COPALINE**, also termed "fossil resin" and "Highgate resin," a naturally occurring organic substance found as irregular pieces of pale-yellow colour in the London clay at Highgate Hill. It has a resinous aromatic odour when freshly broken, volatilizes at a moderate temperature, and burns readily with a yellow, smoky flame, leaving scarcely any ash.

**COPÁN**, an ancient ruined city of western Honduras, near the Guatemalan frontier, and on the right bank of the Río Copán, a tributary of the Motagua. For an account of its elaborately sculptured stone buildings, which rank among the most celebrated monuments of Mayan civilization, see **CENTRAL AMERICA: Archaeology**. The city is sometimes regarded as identical with the Indian stronghold which, after a heroic resistance, was stormed by the Spaniards, under Hernando de Chaves, in 1530. It has given its name to the department in which it is situated.

**COPARCENARY** (co-; with, and *parcener*, i.e. sharer; from O. Fr. *parçonier*, Lat. *partitio*, division), in law, the descent of

lands of inheritance from an ancestor to two or more persons possessing an equal title to them. It arises either by common law, as where an ancestor dies intestate, leaving two or more females as his co-heiresses, who then take as coparceners or parceners; or, by particular custom, as in the case of gavelkind lands, which descend to all males in equal degrees, or in default of males, to all the daughters equally. These co-heirs, or parceners, have been so called, says Littleton (§ 241), "because by writ the law will constrain them, that partition shall be made among them." Coparcenary so far resembles joint tenancy in that there is unity of title, interest and possession, but whereas joint tenants always claim by purchase, parceners claim by descent, and although there is unity of interest there is no entirety, for there is no *jus accrescendi* or survivorship. Coparcenary may be dissolved (a) by partition; (b) by alienation by one coparcener; (c) by all the estate at last descending to one coparcener, who thenceforth holds in severalty; (d) by a compulsory partition or sale under the Partition Acts.

The term "coparcenary" is not in use in the United States, joint heirship being considered as *tenancy in common*.

**COPE, EDWARD DRINKER** (1840-1897), American palaeontologist, descended from a Wiltshire family who emigrated about 1687, was born in Philadelphia on the 28th of July 1840. At an early age he became interested in natural history, and in 1859 communicated a paper on the Salamandridae to the Academy of Natural Sciences at Philadelphia. He was educated partly in the University of Pennsylvania, and after further study and travel in Europe was in 1865 appointed curator to the Academy of Natural Sciences, a post which he held till 1873. In 1864-67 he was professor of natural science in Haverford College, and in 1889 he was appointed professor of geology and palaeontology in the University of Pennsylvania. To the study of the American fossil vertebrata he gave his special attention. From 1871 to 1877 he carried on explorations in the Cretaceous strata of Kansas, the Tertiary of Wyoming and Colorado; and in course of time he made known at least 600 species and many genera of extinct vertebrata new to science. Among these were some of the oldest known mammalia, obtained in New Mexico. He served on the U.S. Geological Survey in 1874 in New Mexico; in 1875 in Montana, and in 1877 in Oregon and Texas. He was also one of the editors of the *American Naturalist*. He died in Philadelphia on the 12th of April 1897.

**PUBLICATIONS**.—Reports for U.S. Geological Survey on *Eocene Vertebrata of Wyoming* (1872); on *Vertebrata of Cretaceous Formations of the West* (1875); *Vertebrata of the Tertiary Formations of the West* (1884); *The Origin of the Fittest: Essays on Evolution* (New York, 1887); *The Primary Factors of Organic Evolution* (Chicago, 1896). Memoir by Miss Helen D. King, *American Geologist*, Jan. 1899 (with portrait and bibliography); also memoir by P. Frazer, *American Geologist*, Aug. 1900 (with portrait).

**COPE, EDWARD MEREDITH** (1818-1873), English classical scholar, was born in Birmingham on the 28th of July 1818. He was educated at Ludlow and Shrewsbury schools and Trinity College, Cambridge, of which society he was elected fellow in 1842, having taken his degree in 1841 as senior classic. He was for many years lecturer at Trinity, his favourite subjects being the Greek tragedians, Plato and Aristotle. When the professorship of Greek became vacant, the votes were equally divided between Cope and B. H. Kennedy, and the latter was appointed by the chancellor. It is said that the keenness of Cope's disappointment was partly responsible for the mental affliction by which he was attacked in 1869, and from which he never recovered. He died on the 5th of August 1873. As his published works show, Cope was a thoroughly sound scholar, with perhaps a tendency to over-minuteness. He was the author of *An Introduction to Aristotle's Rhetoric* (1867), a standard work; *The Rhetoric of Aristotle*, with a commentary, revised and edited by J. E. Sandys (1877); translations of Plato's *Gorgias* (2nd ed., 1884) and *Phaedo* (revised by H. Jackson, 1875). Mention may also be made of his criticism of Grote's account of the Sophists, in the *Cambridge Journal of Classical Philology*, vols. i., ii., iii. (1854-1857).

The chief authority for the facts of Cope's life is the memoir prefixed to vol. i. of his edition of *The Rhetoric of Aristotle*.

**COPE** (M.E. *cape, cope*, from Med. Lat. *capa, cappa*), a liturgical vestment of the Western Church. The word "cope," now confined to this sense, was in its origin identical with "cape" and "cap," and was used until comparatively modern times also for an out-door cloak, whether worn by clergy or laity. This, indeed, was its original meaning, the *cappa* having been an outer garment common to men and women whether clerical or lay (see Du Cange, *Glossarium*, s.v.). The word *pluviale* (rain-cloak), which the cope bears in the Roman Church, is exactly parallel so far as change of meaning is concerned. In both words the etymology reveals the origin of the vestment, which is no more than a glorified survival of an article of clothing worn by all and sundry in ordinary life, the type of which survives, e.g. in the ample hooded cloak of Italian military officers. This origin is clearly traceable in the shape and details of the cope. When spread out this forms an almost complete semicircle. Along the straight edge there is usually a broad band, and at the neck is attached the "hood" (in Latin, the *clypeus* or shield), i.e. a shield-shaped piece of stuff which hangs down over the back. The vestment is secured in front by a broad tab sewn on to one side and fastening to the other with hooks, sometimes also by a brooch (called the *morse*, Lat. *morsus*). Sometimes the *morse* is attached as a mere ornament to the cross-piece. The cope thus preserves the essential shape of its secular original, and even the hood, though now a mere ornamental appendage, is a survival of an actual hood. The evolution of this latter into its present form was gradual; first the hood became too small for use, then it was transformed into a small triangular piece of stuff (13th century), which in its turn grew (14th and 15th centuries) into the shape of a shield (see Plate II., fig. 4), and this again, losing its pointed tip in the 17th century, expanded in the 18th into a flap which was sometimes enlarged so as to cover the whole back down to the waist. In its general effect, however, a cope now no longer suggests a "waterproof." It is sometimes elaborately embroidered all over; more usually it is of some rich material, with the borders in front and the hood embroidered; while the *morse* has given occasion for some of the most beautiful examples of the goldsmith's and jeweller's craft (see Plate II., figs. 5, 6).

The use of the cope as a liturgical vestment can be traced to the end of the 8th century: a *pluviale* is mentioned in the foundation charter of the monastery of Obona in Spain. Before this the so-called *cappa choralis*, a black, bell-shaped, hooded vestment with no liturgical significance, had been worn by the secular and regular clergy at choir services, processions, &c. This was in its origin identical with the chasuble (*q.v.*), and if, as Father Braun seems to prove, the cope developed out of this, cope and chasuble have a common source.<sup>1</sup> Father Braun cites numerous inventories and the like to show that the cope (*pluviale*) was originally no more than a more elaborate *cappa* worn on high festivals or other ceremonial occasions, sometimes by the whole religious community, sometimes—if the stock were limited—by those, e.g. the cantors, &c., who were most conspicuous in the ceremony. In the 10th century, partly under the influence of the wealthy and splendour-loving community of Cluny, the use of the cope became very widespread; in the 11th century it was universally worn, though the rules for its ritual use had not yet been fixed. It was at this time, however, *par excellence* the vestment proper to the cantors, choirmaster and singers, whose duty it was to sing the *invitatorium*, *responses*, &c., at office, and the *introitus*, *graduale*, &c., at Mass. This use survived in the ritual of the pre-Reformation Church in England, and has been introduced in certain Anglican churches, e.g. St Mary Magdalen's, Munster Square, in London.

<sup>1</sup> This derivation, suggested also by Dr Legg (*Archaeol. Journal*, 51, p. 39, 1894), is rejected by the five bishops in their report to Convocation (1908). Their statement, however, that it is "pretty clear" that the cope is derived from the Roman *lacerna* or *birrus* is very much open to criticism. We do not even know what the appearance and form of the *birrus* were; and the question of the origin of the cope is not whether it was derived from any garment of the time of the Roman Empire, and if so from which, but what garment in use in the 8th and 9th centuries it represents.

By the beginning of the 13th century the liturgical use of the cope had become finally fixed, and the rules for this use included by Pope Pius V. in the Roman Missal and by Clement VIII. in the *Pontificale* and *Caeremoniale* were consequently not new, but in accordance with ancient and universal custom. The substitution of the cope for the chasuble in many of the functions for which the latter had been formerly used was primarily due to the comparative convenience of a vestment opened at the front, and so leaving the arms free. A natural conservatism preserved the chasuble, which by the 9th century had acquired a symbolical significance, as the vestment proper to the celebration of Mass; but the cope took its place in lesser functions, i.e. the censuring of the altar during the Magnificat and at Mattins (whence the German name *Rauchmantel*, smoke-mantel), processions, solemn consecrations, and as the dress of bishops attending synods.

It is clear from this that the cope, though a liturgical, was never a sacerdotal vestment. If it was worn by priests, it could also be worn by laymen, and it was never worn by priests in their sacerdotal, i.e. their sacrificial, capacity. For this reason it was not rejected with the "Mass vestments" by the English Church at the Reformation, in spite of the fact that it was in no ecclesiastical sense "primitive." By the First Prayer-book of Edward VI., which represented a compromise, it was directed to be worn as an alternative to the "vestment" (i.e. chasuble) at the celebration of the Communion; this at least seems the plain meaning of the words "vestment or cope," though they have been otherwise interpreted. In the Second Prayer-book vestment and cope alike disappear; but a cope was worn by the prelate who consecrated Archbishop Parker, and by the "gentlemen" as well as the priests of Queen Elizabeth's chapel; and, finally, by the 24th canon (of 1603) a "decent cope" was prescribed for the "principal minister" at the celebration of Holy Communion in cathedral churches as well as for the "gospeller and epistler." Except at royal coronations, however, the use of the cope, even in cathedrals, had practically ceased in England before the ritual revival of the 19th century restored its popularity. The disuse implied no doctrinal change; the main motive was that the stiff vestment, high in the neck, was incompatible with a full-bottomed wig. Scarlet copes with white fur hoods have been in continuous use on ceremonial occasions in the universities, and are worn by bishops at the opening of parliament.

With the liturgical cope may be classed the red mantle (*mantum*), which from the 11th century to the close of the middle ages formed, with the tiara, the special symbol of the papal dignity. The *immantatio* was the solemn investiture of the new pope immediately after his election, by means of the *cappa rubea*, with the papal powers. This ceremony was of great importance. In the contested election of 1159, for instance, though a majority of the cardinals had elected Cardinal Roland (Alexander III.), the defeated candidate Cardinal Octavian (Victor IV.), while his rival was modestly hesitating to accept the honour, seized the *pluviale* and put it on his own shoulders hastily, upside down; and it was on this ground that the council of Pavia in 1160 based their declaration in favour of Victor, and anathematized Alexander. The *immantatio* fell out of use during the papal exile at Avignon and was never restored.

It will be convenient here to note other vestments that have developed out of the *cappa*. The *cappa choralis* has already



FIG. 1.—Seventeenth Century Coronation Cope at Westminster Abbey.

The  
Papal  
mantum.

been mentioned; it survived as a choir vestment that in winter took the place of the surplice, rochet or almuce. In the 12th century it was provided with arms (*cappa manicata*), but the use of this form was forbidden at choir services and other liturgical functions. From the hood of the *cappa* was developed the almuce (*q.v.*). At what

date the *cappa choralis* developed into the *cappa magna*, a non-liturgical vestment peculiar to the pope, cardinals, bishops and certain privileged prelates, is not known; but mention of it is found as early as the 15th century. This vestment is a loose robe, with a large hood (lined with fur in winter and red silk in summer) and a long train, which is carried by a cleric called the *caudatarius*. Its colour varies with the hierarchical rank of the wearer:—red for cardinals, purple for bishops, &c.; or, if the dignitary belong to a religious order, it follows the colour of the habit of the order. The right to wear a violet *cappa magna* is conceded by the popes to the chapters of certain important cathedrals, but the train in this case is worn folded over the left arm or tied under it. It may only be worn by them, moreover, in their own church, or when the chapter appears elsewhere in its corporate capacity.

Lastly, from the *cappa* is probably derived the *mozzetta*, a short cape with a miniature hood, fastened down the front with buttons. The name is derived from the Italian *mozzare*, to cut off, and points to its being an abbreviated *cappa*, as the episcopal "apron" is a shortened cassock. It is worn over the rochet by the pope, cardinals, bishops and prelates, the colours varying as in the case of the *cappa magna*. Its use as confined to bishops can be traced to the 16th century.

See Joseph Braun, S. J., *Die liturgische Gewandung* (Freiburg im Breisgau, 1907); also the bibliography to the article VESTMENTS.

(W. A. P.)

**COPELAND, HENRY**, an 18th century English cabinet-maker and furniture designer. He appears to have been the first manufacturing cabinet-maker who published designs for furniture. *A New Book of Ornaments* appeared in 1746, but it is not clear whether the engravings with this title formed part of a book, or were issued only in separate plates; a few of the latter are all that are known to exist. Between 1752 and 1769 several collections of designs were produced by Copeland in conjunction with Matthias Lock; in one of them Copeland is described as of Cheapside. Some of the original drawings are in the National Art library at the Victoria and Albert Museum. Copeland was probably the originator of a peculiar type of chair-back, popular for a few years in the middle of the 18th century, consisting of a series of interlaced circles. Much of his work has been attributed to Thomas Chippendale, and it is certain that one derived many ideas from the other, but which was the originator and which the copyist is by no means clear. The dates of Copeland's birth and death are unknown, but he was still living in 1768.

**COPENHAGEN** (Danish *Kjöbenhavn*), the capital of the kingdom of Denmark, on the east coast of the island of Zealand (*Sjælland*) at the southern end of the Sound. Pop. (1901) 400,575. The latitude is approximately that of Moscow, Berwick-on-Tweed and Hopedale in Labrador. The nucleus of the city is built on low-lying ground on the east coast of the island of Zealand, between the sea and a series of small freshwater lakes, known respectively as St Jörgens Sø, Peblings Sø and Sortedams Sø, a southern portion occupying the northern part of the island of Amager. An excellent harbour is furnished by the natural channel between the two islands; and communication from one division to the other is afforded by two bridges—the Langebro and the Knippelsbro, which replaced the wooden drawbridge built by Christian IV. in 1620. The older city, including both the Zealand and Amager portions, was formerly surrounded by a complete line of ramparts and moats; but pleasant boulevards and gardens now occupy the westward or landward site of fortifications. Outside the lines of the original city (about 5 m. in circuit), there are extensive suburbs, especially on the Zealand side (Österbro, Nørrebro and Vesterbro or Österfölld,

&c., and Frederiksberg), and Amagerbro to the south of Christianshavn.

The area occupied by the inner city is known as Gammelsholm (old island). The main artery is the Gothersgade, running from Kongens Nytorv to the western boulevards, and separating a district of regular thoroughfares and rectangular blocks to the north from one of irregular, narrow and picturesque streets to the south. The Kongens Nytorv, the focus of the life of the city and the centre of road communications, is an irregular open space at the head of a narrow arm of the harbour (Nyhavn) inland from the steamer quays, with an equestrian statue of Christian V. (d. 1699) in the centre. The statue is familiarly known as *Hesten* (the horse) and is surrounded by noteworthy buildings. The Palace of Charlottenborg, on the east side, which takes its name from Charlotte, the wife of Christian V., is a huge sombre building, built in 1672. Frederick V. made a grant of it to the Academy of Arts, which holds its annual exhibition of paintings and sculpture in April and May, in the adjacent *Kunstudstilling* (1883). On the south is the principal theatre, the Royal, a beautiful modern Renaissance building (1874), on the site of a former theatre of the same name, which dated from 1748. Statues of the poets Ludvig Holberg (d. 1754), and Adam Öhlenschläger (d. 1850), the former by Stein and the latter by H. V. Bissen, stand on either side of the entrance, and the front is crowned by a group by King, representing Apollo and Pegasus, and the Fountain of Hippocrene. Within, among other sculptures, is a relief figure of Ophelia, executed by Sarah Bernhardt. Other buildings in Kongens Nytorv are the foreign office, several great commercial houses, the commercial bank, and the Thotts Palais of c. 1685. The quays of the Nyhavn are lined with old gabled houses.

From the south end of Kongens Nytorv, a street called Holmens Kanal winds past the National Bank to the Holmens Kirke, or church for the royal navy, originally erected as an anchor-smithy by Frederick II., but consecrated by Christian IV., with a chapel containing the tombs of the great admirals Niels Juel and Peder Tordenskjöld, and wood-carving of the 17th century. The street then crosses a bridge on to the Slotsholm, an island divided from the mainland by a narrow arm of the harbour, occupied mainly by the Christiansborg and adjacent buildings. The royal palace of Christiansborg, originally built (1731-1745) by Christian VI., destroyed by fire in 1794, and rebuilt, again fell in flames in 1884. Fortunately most of the art treasures which the palace contained were saved. A decision was arrived at in 1903, in commemoration of the jubilee of the reign of Christian IX., to rebuild the palace for use on occasions of state, and to house the parliament. On the Slotssplads (Palace Square) which faces east, is an equestrian statue of Frederick VII. There are also preserved the bronze statues which stood over the portal of the palace before the fire—figures of Strength, Wisdom, Health and Justice, designed by Thorvaldsen. The palace chapel, adorned with works by Thorvaldsen and Bissen, was preserved from the fire, as was the royal library of about 540,000 volumes and 20,000 manuscripts, for which a new building in Christiansgade was designed about 1900.

The exchange (*Börsen*), on the quay to the east, is an ornate gabled building erected in 1619-1640, surmounted by a remarkable spire, formed of four dragons, with their heads directed to the four points of the compass, and their bodies entwining each other till their tails come to a point at the top. To the south is the arsenal (*Tøjhus*) with a collection of ancient armour.

The Thorvaldsen museum (1839-1848), a sombre building in a combination of the Egyptian and Etruscan styles, consists of two storeys. In the centre is an open court, containing the artist's tomb. The exterior walls are decorated with groups of figures of coloured stucco, illustrative of events connected with Thorvaldsen's life. Over the principal entrance is the chariot of Victory drawn by four horses, executed in bronze from a model by Bissen. The front hall, corridors and apartments are painted in the Pompeian style, with brilliant colours and with great artistic skill. The museum contains about 300



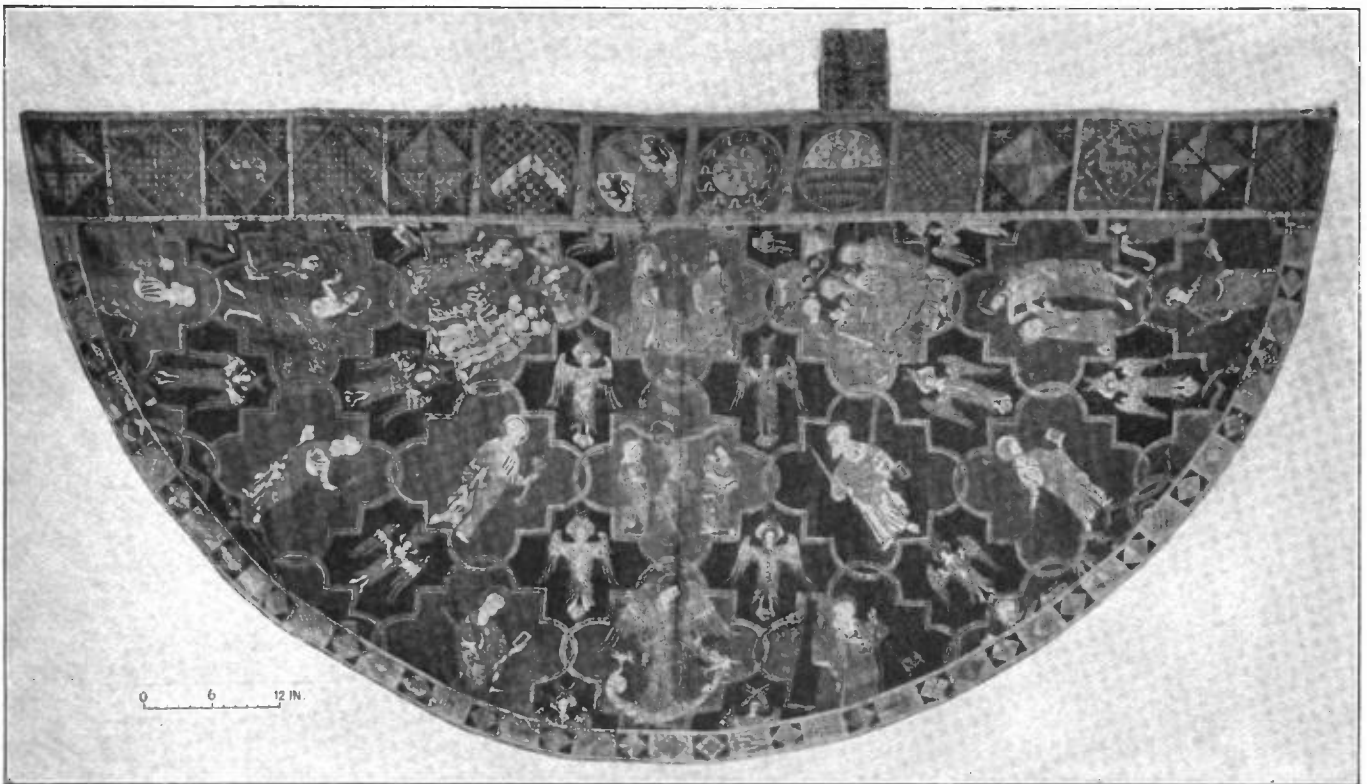

FIG. 2.—THE SYON COPE. (ENGLISH, 13TH CENTURY.)

The medallions with which it is embroidered contain representations of Christ on the Cross, Christ and St Mary Magdalene, Christ and Thomas, the death of the Virgin, the burial and coronation of the Virgin, St Michael and the twelve Apostles. Of the latter, four survive only in tiny fragments. The spaces between the four rows of medallions are filled with six-winged cherubim. The ground-work of the vestment is green silk embroidery, that of the medallions red. The figures are worked in silver and gold thread and coloured silks. The lower border and the orphrey with coats of arms do not belong to the original cope and are of somewhat later date. The cope belonged to the convent of Syon near Isleworth, was taken to Portugal at the Reformation, brought back early in the 19th century to England by exiled nuns and given by them to the Earl of Shrewsbury. In 1864 it was bought by the South Kensington Museum.

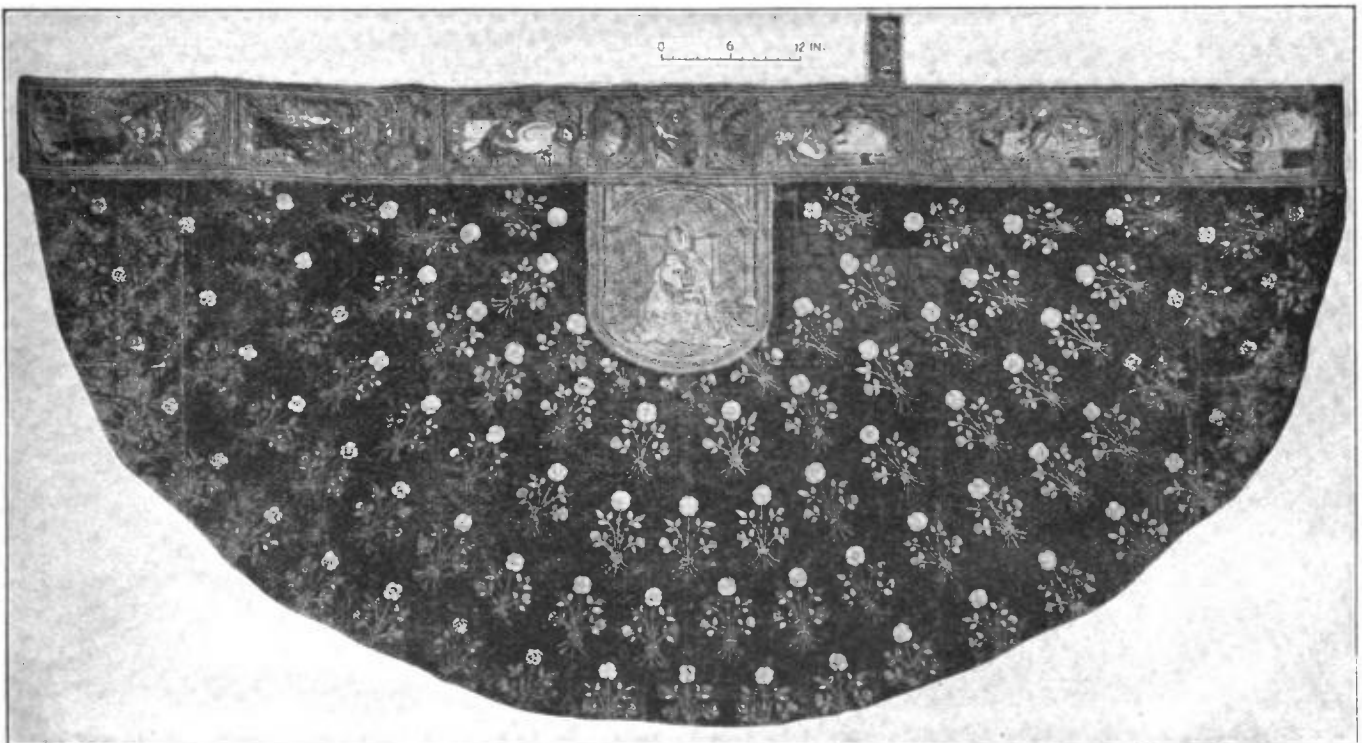

FIG. 3.—COPE OF BLUE SILK VELVET, WITH APPLIQUÉ WORK AND EMBROIDERY.

In the middle of the orphrey is a figure of Our Lord holding the orb in His left hand, and with His right hand raised in benediction. To the right are figures of St Peter, St Bartholomew and St Ursula; and to the left, St Paul, St John the Evangelist and St Andrew. On the hood is a seated figure of the Virgin Mary holding the Infant Saviour. GERMAN; early 16th century. (In the Victoria and Albert Museum, No. 91. 1904.)



COPE

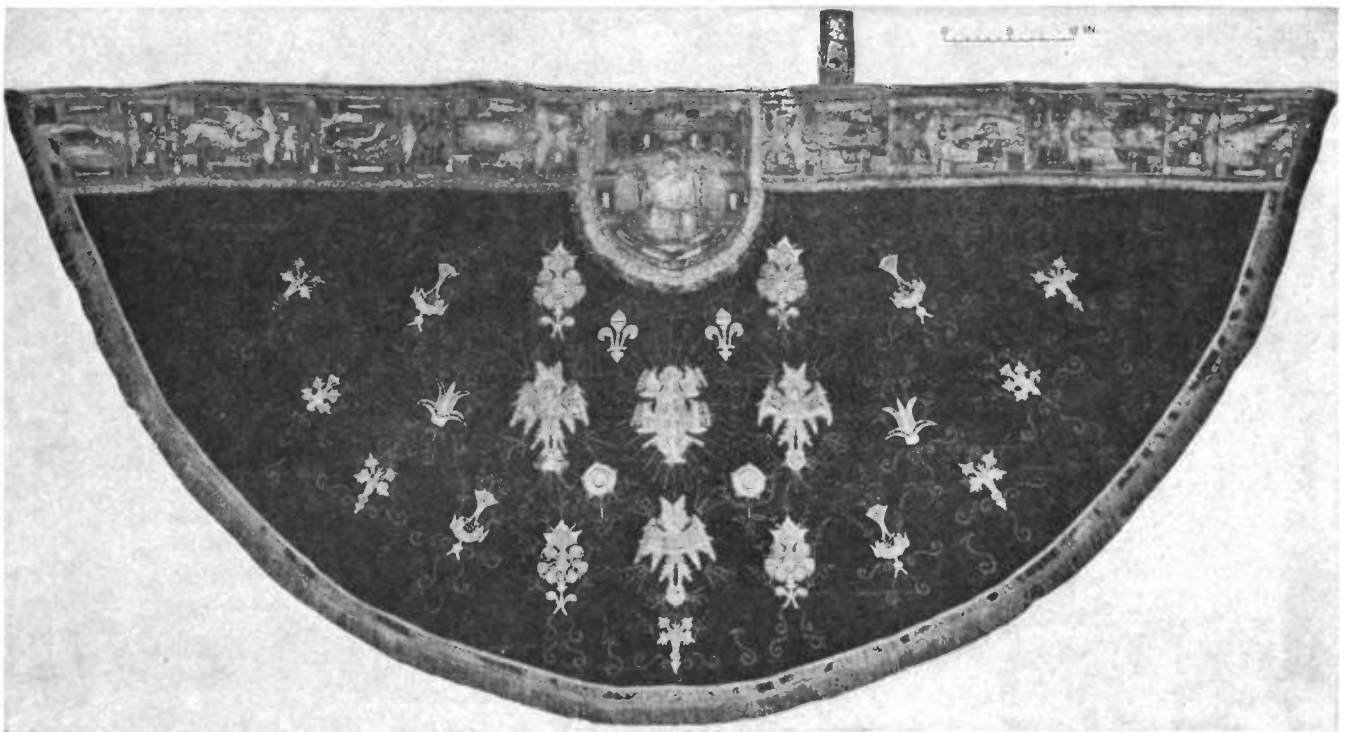

FIG. 4.—COPE OF EMBROIDERED PURPLE SILK VELVET.

In the middle is represented the Assumption of the Virgin; on the hood is a seated figure of the Almighty bearing three souls in a napkin. ENGLISH, about 1500. (In the Victoria and Albert Museum.)



FIG. 5.—COPE MORSE (GERMAN, 14TH CENTURY) IN THE CATHEDRAL AT AIX-LA-CHAPELLE.

(From a photograph by Father Joseph Braun, S. J.)



FIG. 6.—COPE MORSE (GERMAN, EARLY 14TH CENTURY), IN THE PARISH CHURCH AT ELTEN.

(From a photograph by Father Joseph Braun, S. J.)

of Thorvaldsen's works; and in one apartment is his sitting-room furniture arranged as it was found at the time of his death in 1844.

On the mainland, immediately west of the Slotsholm, is the Prinsens Palais, once the residence of Christian V. and Frederick VI. when crown princes, containing the national museum. This consists of four sections, the Danish, ethnographical, antique and numismatic. It was founded in 1807 by Professor Nyerup, and extended between 1815 and 1885 by C. J. Thomsen and J. J. A. Worsaae, and the ethnographical collection is among the finest in the world. From this point the Raadhusgade leads north-west to the combined Nytorv-og-Gammeltoiv, where is the old townhall (*Raadhus*, 1815), and continues as the Nørregade to the Vor Frue Kirke (Church of our Lady), the cathedral church of Copenhagen. This church, the site of which has been similarly occupied since the 12th century, was almost entirely destroyed in the bombardment of 1807, but was completely restored in 1811-1829. The works of Thorvaldsen which it contains constitute its chief attraction. In the pediment is a group of sixteen figures by Thorvaldsen, representing John the Baptist preaching in the wilderness; over the entrance within the portico is a bas-relief of Christ's entry into Jerusalem; on one side of the entrance is a statue of Moses by Bissen, and on the other a statue of David by Jerichau. In a niche behind the altar stands a colossal marble statue of Christ, and marble statues of the twelve apostles adorn both sides of the church.

Immediately north of Vor Frue Kirke is the university, founded by Christian I. in 1479; though its existing constitution dates from 1788. The building dates from 1836. There are five faculties—theological, juridical, medical, philosophical and mathematical. In 1851 an English and in 1852 an Anglo-Saxon lectureship were established. All the professors are bound to give a series of lectures open to the public free of charge. The university possesses considerable endowments and has several foundations for the assistance of poor students; the "regent's charity," for instance, founded by Christian, affords free residence and a small allowance to one hundred bursars. There are about 2000 students. In connexion with the university are the observatory, the chemical laboratory in Ny Vester Gade, the surgical academy in Bredgade, founded in 1786, and the botanic garden. The university library, incorporated with the former Classen library, collected by the famous merchants of that name, contains about 200,000 volumes, besides about 4000 manuscripts, which include Rask's valuable Oriental collection and the Arne-Magnean series of Scandinavian documents. It shares with the royal library the right of receiving a copy of every book published in Denmark. There is also a zoological museum. Adjacent is St Peter's church, built in a quasi-Gothic style, with a spire 256 ft. high, and appropriated since 1585 as a parish church for the German residents in Copenhagen. A short distance along the Krystalgade is Trinity church. Its round tower is 111 ft. high, and is considered to be unique in Europe. It was constructed from a plan of Tycho Brahe's favourite disciple Longomontanus, and was formerly used as an observatory. It is ascended by a broad inclined spiral way, up which Peter the Great is said to have driven in a carriage and four. From this church the Kjobermayergade runs south, a populous street of shops, giving upon the Høibro-plads, with its fine equestrian statue of Bishop Absalon, the city's founder. This square is connected by a bridge with the Slotsholm.

The quarter north-east of Kongens Nytorv and Gothersgaden is the richest in the city, including the palaces of Amalienborg, the castle and gardens of Rosenborg and several mansions of the nobility. The quarter extends to the strong moated citadel, which guards the harbour on the north-east. It is a regular polygon with five bastions, founded by Frederick III. about 1662-1663. One of the mansions, the Moltkes Palais, has a collection of Dutch paintings formed in the 18th century. This is in the principal thoroughfare of the quarter, Bredgaden, and close at hand the palace of King George of Greece faces the Frederikskirke or Marble church. This church, intended to have

been an edifice of great extent and magnificence, was begun in the reign of Frederick V. (1749), but after twenty years was left unfinished. It remained a ruin until 1874, when it was purchased by a wealthy banker, M. Tietgen, at whose expense the work was resumed. The edifice was not carried up to the height originally intended, but the magnificent dome, which recalls the finest examples in Italy, is conspicuous far and wide. The diameter is only a few feet less than that of St Peter's in Rome. As the church stands it is one of the principal works of the architect, F. Meldahl. Behind King George's palace from the Bredgade lies the Amalienborg-plads, having in the centre an equestrian statue of Frederick V., erected in 1768 at the cost of the former Asiatic Company. The four palaces, of uniform design, encircling this *plads*, were built for the residence of four noble families; but on the destruction of Christiansborg in 1794 they became the residence of the king and court, and so continued till the death of Christian VIII. in 1848. One of the four is inhabited by the king, the second and third by the crown prince and other members of the royal family, while the fourth is occupied by the coronation and state rooms. The Ameliegade crosses the *plads* and, with the Bredgade, terminates at the esplanade outside the citadel, prolonged in the pleasant promenade of Lange Linie skirting the Sound.

To the west of the citadel is the Ostbanegaard, or eastern railway station, from which start the local trains on the coast line to Klampenborg and Helsingør. South-west from this point extends the line of gardens which occupy the site of former landward fortifications, pleasantly diversified by water and plantations, skirted on the inner side by three wide boulevards, Østervold, Nørrevold and Vestervold Gade, and containing noteworthy public buildings, mostly modern. In the Østre Anlaeg is the art museum (1895) containing pictures, sculptures and engravings. In front of it is the Denmark monument (1896), commemorating the golden wedding (1892) of Christian IX. and Queen Louisa. Among various scenes in relief, the marriage of King Edward VII. of England and Queen Alexandra is depicted. The botanical garden (1874) contains an observatory with a statue of Tycho Brahe, and the chemical laboratory, mineralogical museum, polytechnic academy (1829) and communal hospital adjoin it. On the inner side of Østevold Gade is Rosenborg Park, with the palace of Rosenborg erected in 1610-1617. It is an irregular building in Gothic style, with a high pointed roof, and flanked by four towers of unequal dimensions. It contains the chronological collection of Danish monarchs, including a coin and medal cabinet, a fine collection of Venetian glass, the famous silver drinking-horn of Oldenburg (1474), the regalia and other objects of interest as illustrating the history of Denmark. The Riddersal, a spacious room, is covered with tapestry representing the various battles of Christian V., and has at one end a massive silver throne. The Nørrevold Gade leads through the Nørretorv past the Folke-teatre and the technical school to the Ørsted's park, and from its southern end the Vestervold Gade continues through the Raadhus Plads, a centre of tramways, flanked by the modern Renaissance town hall (1901), ornamented with bronze figures, with a tower at the eastern angle. Here is also the museum of industrial art, and the Ny-Carlsberg Glyptotek, with its collection of sculpture, is on this boulevard, which skirts the pleasure garden called Tivoli. From the Raadhus-plads the Vesterbro Gade runs towards the western quarter of the city, skirting the Tivoli. Here is the Dansk Folke museum, a collection illustrating the domestic life of the nation, particularly that of the peasantry since 1600. A column of Liberty (*Friheds-Støtte*) rises in an open space, erected in 1798 to commemorate the abolition of serfdom. Immediately north is the main railway station (*Banegaard*), and the North and Klampenborg stations near at hand. The western (residential) quarter contains the park of Frederiksberg, with its palace erected under Frederick IV. (d. 1730), used as a military school. The park contains a zoological garden, and is continued south in the pleasant Søndermarken, near which lies the old Glyptotek, which contained the splendid collection of sculptures, &c., made by H. C. Jacobsen

since 1887, until their removal to the new Glyptotek founded by him in the Vestre Boulevard.

The quarter of Christianshavn is that portion of the city which skirts the harbour to the south, and lies within the fortifications. It contains the Vor Frelzers Kirke (Church of Our Saviour), dedicated in 1696, with a curious steeple 282 ft. high, ascended by an external spiral staircase. The lower part of the altar is composed of Italian marble, with a representation of Christ's sufferings in the garden of Gethsemane; and the organ is considered the finest in Copenhagen. The city does not extend much farther south, though the Amagerbro quarter lies without the walls. The island of Amager is fertile, producing vegetables for the markets of the capital. It was peopled by a Dutch colony planted by Christian II. in 1516, and many old peculiarities of dress, manners and languages are retained.

The environs of Copenhagen to the north and west are interesting, and the country, both along the coast northward and inland westward is pleasant, though in no way remarkable. The railway along the coast northward passes the seaside resorts of Klampenborg (6 m.) and Skodsborg (10 m.). Near Klampenborg is the Dyrehave (Deer park) or Skoven (the forest), a beautiful forest of beeches. The Zealand Northern railway passes Lyngby, on the lake of the same name, a favourite summer residence, and Hillerød (21 m.), a considerable town, capital of the *amt* (county) of Frederiksberg, and close to the palace of Frederiksberg. This was erected in 1602-1620 by Christian IV., embodying two towers of an earlier building, and partly occupying islands in a small lake. It suffered seriously from fire in 1859, but was carefully restored under the direction of F. Meldahl. It contains a national historical museum, including furniture and pictures. The palace church is an interesting medley of Gothic and Renaissance detail. The villa of Hvidøre was acquired by Queen Alexandra in 1907.

Among the literary and scientific associations of Copenhagen may be mentioned the Danish Royal Society, founded in 1742, for the advancement of the sciences of mathematics, astronomy, natural philosophy, &c., by the publication of papers and essays; the Royal Antiquarian Society, founded in 1825, for diffusing a knowledge of Northern and Icelandic archaeology; the Society for the Promotion of Danish Literature, for the publication of works chiefly connected with the history of Danish literature; the Natural Philosophy Society; the Royal Agricultural Society; the Danish Church History Society; the Industrial Association, founded in 1838; the Royal Geographical Society, established in 1876; and several musical and other societies. The Academy of Arts was founded by Frederick V. in 1754 for the instruction of artists, and for disseminating a taste for the fine arts among manufacturers and operatives. Attached to it are schools for the study of architecture, ornamental drawing and modelling. An Art Union was founded in 1826, and a musical conservatorium in 1870 under the direction of the composers N. W. Gade and J. P. E. Hartmann.

Among educational institutions, other than the university, may be mentioned the veterinary and agricultural college, established in 1773 and adopted by the state in 1776, the military academy and the school of navigation. Technical instruction is provided by the polytechnic school (1829), which is a state institution, and the school of the Technical Society, which, though a private foundation, enjoys public subvention. The schools which prepare for the university, &c., are nearly all private, but are all under the control of the state. Elementary instruction is mostly provided by the communal schools.

The churches already mentioned belong to the national Lutheran Church; the most important of those belonging to other denominations are the Reformed church, founded in 1688, and rebuilt in 1731, the Catholic church of St Ansgarius, consecrated in 1842, and the Jewish synagogue in Krystalgade, which dates from 1853. Of the monastic buildings of medieval Copenhagen various traces are preserved in the present nomenclature of the streets. The Franciscan establishment gives its name to the Graabrødretorv or Grey Friars' market; and St Clara's Monastery, the largest of all, which was founded by

Queen Christina, is still commemorated by the Klareboder or Clara buildings, near the present post-office. The Duebrødre Kloster occupied the site of the hospital of the Holy Ghost.

Among the hospitals of Copenhagen, besides many modern institutions, there may be mentioned Frederick's hospital, erected in 1752-1757 by Frederick V., the Communal Hospital, erected in 1859-1863, on the eastern side of the Sortedamssø, the general hospital in Ameliegade, founded in 1769, and the garrison hospital, in Rigensgade, established in 1816 by Frederick VI. After the cholera epidemic of 1853, which carried off more than 4000 of the inhabitants, the medical association built several ranges of workmen's houses, and their example was followed by various private capitalists, among whom may be mentioned the Classen trustees, whose buildings occupy an open site on the western outskirts of the city.

Copenhagen is by far the most important commercial town in Denmark, and exemplifies the steady increase in the trade of the country. The harbour is mainly comprised in the narrow strait between the outer Sound and its inlet the Kalvebod or Kallebo Strand. The trading capabilities were aided by the construction in 1894 of the Frihavn (free port) at the northern extremity of the town, well supplied with warehouses and other conveniences. It is connected with the main railway station by means of a circular railway, while a short branch connects it with the ordinary custom-house quay. The commercial harbour is separated from the harbour for warships (*Orlogshavn*) by a barrier. The sea approaches are guarded by ten coast batteries besides the old citadel. The Middelgrund is a powerful defensive work completed in 1896 and most of the rest are modern. The landward defences of Copenhagen, it may be added, were left unprovided for after the Napoleonic wars until the patriotism of Danish women, who subscribed sufficient funds for the first fort, shamed parliament into granting the necessary money for others (1886-1895). Copenhagen is not an industrial town. The manufactures carried on are mostly only such as exist in every large town, and the export of manufactured goods is inconsiderable. The royal china factory is celebrated for models of Thorvaldsen's works in biscuit china. The only very large establishment is one for the construction of iron steamers, engines, &c., but some factories have been erected within the area of the free port for the purpose of working up imported raw materials duty free.

*History.*—Copenhagen (*i.e.* Merchant's Harbour, originally simply Havn, latinized as *Hafnia*) is first mentioned in history in 1043. It was then only a fishing village, and remained so until about the middle of the 12th century, when Valdemar I. presented that part of the island to Axel Hvide, renowned in Danish history as Absalon (*q.v.*), bishop of Roskilde, and afterwards archbishop of Lund. In 1167 this prelate erected a castle on the spot where the Christiansborg palace now stands, and the building was called after him Axel-huus. The settlement gradually became a great resort for merchants, and thus acquired the name which, in a corrupted form, it still bears, of Kaupmannahöfn, Kjöbmannshavn, or *Portus Mercatorum* as it is translated by Saxo Grammaticus. In 1186, Bishop Absalon bestowed the castle and village, with the lands of Amager, on the see of Roskilde; but, as the place grew in importance, the Danish kings became anxious to regain it, and in 1245 King Eric IV. drove out Bishop Niels Stigson. On the king's death (1250), however, Bishop Jacob Erlandsen obtained the town, and, in 1254, gave to the burghers their first municipal privileges, which were confirmed by Pope Urban III. in 1286. In the charter of 1254, while there is mention of a *communitas* capable of making a compact with the bishop, there is nothing said of any trade or craft guilds. These are, indeed, expressly prohibited in the later charter of Bishop Johann Kvag (1294); and the distinctive character of the constitution of Copenhagen during the middle ages consisted in the absence of the free gild system, and the right of any burgher to pursue a craft under license from the *Vogt* (*advocatus*) of the overlord and the city authorities. Later on, guilds were established, in spite of the prohibition of the old charters; but they were strictly subordinate

to the town authorities, who appointed their aldermen and suppressed them when they considered them useless or dangerous. The prosperity of Copenhagen was checked by an attack by the people of Lübeck in 1248, and by another on the part of Prince Jaromir of Rügen in 1259. In 1306 it managed to repel the Norwegians, but in 1362, and again in 1368, it was captured by the opponents of Valdemar Atterdag. In the following century a new enemy appeared in the Hanseatic league, which was jealous of its rivalry, but their invasion was frustrated by Queen Philippa. Various attempts were made by successive kings to obtain the town from the see of Roskilde, as the most suitable for the royal residence; but it was not till 1443 that the transference was finally effected and Copenhagen became the capital of the kingdom. From 1523 to 1524 it held out for Christian II. against Frederick I., who captured it at length and strengthened its defensive works; and it was only after a year's siege that it yielded in 1536 to Christian III. From 1658 to 1660 it was unsuccessfully beleaguered by Charles Gustavus of Sweden; and in the following year it was rewarded by various privileges for its gallant defence. In 1660 it gave its name to the treaty which concluded the Swedish war of Frederick III. In 1700 it was bombarded by the united fleets of England, Holland and Sweden; in 1728 a conflagration destroyed 1640 houses and five churches; another in 1795 laid waste 943 houses, the church of St Nicolas, and the *Raadhus*. In 1801 the Danish fleet was destroyed in the roadstead by the English (see below, § *Battle of Copenhagen*); and in 1807 the city was bombarded by the British under Lord Cathcart, and saw the destruction of the university buildings, its principal church and numerous other edifices.

See O. Nielsen, *København's Historie og Beskrivelse* (Copenhagen, 1877-1892); C. Bruun and P. Munch, *København, Skildring af dets Historie, &c.* (*ibid.* 1887-1901); Bering-Lüsberg, *København i gamle Dage* (*ibid.* 1898 et seq.). (O. J. R. H.)

#### BATTLE OF COPENHAGEN

The formation of a league between the northern powers, Russia, Prussia, Denmark and Sweden, on the 16th of December 1800, nominally to protect neutral trade at sea from the enforcement by Great Britain of her belligerent claims, led to the despatch of a British fleet to the Baltic on the 12th of March 1801. It consisted of fifty-three sail in all, of which eighteen were of the line. Prussia possessed no fleet. The nominal strength of the Russian fleet was eighty-three sail of the line, of the Danish twenty-three, and of the Swedish eighteen. But this force was for the most part only on paper. Some of the Russian ships were at Archangel, others in the Mediterranean. Of those actually in the Baltic and fit to go to sea, twelve were at Reval shut in by the ice, and the others were at Kronstadt. The Swedes could equip only eleven of the line for sea, and Denmark only seven or eight. It is highly doubtful whether the three powers could have collected more than forty ships of the line—and they would have been hastily manned, destitute of experience, and without confidence. A rapid British attack would in any case forestall the concentration of these heterogeneous squadrons. The superior quality of the veteran British crews was more than enough to counterbalance a mere superiority in numbers. The command of the British fleet was given to Sir Hyde Parker, an amiable man of no energy and little ability. He had Nelson with him as second in command—then a junior admiral but without rival in capacity and in his hold on the confidence of the fleet. Parker's orders were to give Denmark twenty-four hours in which to withdraw from the coalition, and on her refusal to destroy or neutralize her strength and then proceed against the Russians before the breaking up of the ice allowed the ships at Reval to join the squadron at Kronstadt.

On the 21st of March the British fleet, after a somewhat stormy passage, was at the entrance to the Sound. Nicholas Vansittart, afterwards Lord Bexley, the British diplomatic agent entrusted with the message to the Danish government, was landed, and left for Copenhagen. On the 23rd he returned with the refusal of the Danes. The British fleet then passed

the Danish fort at Cronenburg, unhurt by its distant fire, and without being molested by the forts on the Swedish shore. Nelson urged immediate attack, and recommended, as an alternative, that part of the British fleet should watch the Danes while the remainder advanced up the Baltic to prevent the junction of the Russian Reval squadron with the ships in Kronstadt. Sir Hyde Parker was, however, unwilling to go up the Baltic with the Danes unsubdued behind him, or to divide his force. It was therefore resolved that an attack should be made on the Danish capital with the whole fleet in two divisions. Copenhagen lies on the east side of the island of Zealand; opposite it is the shoal known as the Middle Ground. To the east of the Middle Ground is another shoal known as Saltholm Flat, and there is a passage available for large ships between them. The main fortification of Copenhagen was the powerful Trekrøner (Three Crown) battery at the northern end of the sea-front. Here the Danes had placed their strongest ships. The southern part of the city front was covered by hulks and gun-vessels or bomb-vessels. There were in all eighteen hulks or ships of the line in the Danish defence. To have made the attack from the northern end would in Nelson's words have been "to take the bull by the horns." He therefore proposed that he should be detached with ten sail of the line, and the frigates and small craft, to pass between the Middle Ground and Saltholm Flat, and assail the Danish line at the southern end while the remainder of the fleet engaged the Trekrøner battery from the north. Sir Hyde Parker accepted his offer, and added two ships of the line to the ten asked for by Nelson.

During the nights of the 30th and 31st of March the channel between the Middle Ground and Saltholm Flat was sounded by the boats of the British fleet, the Danes making no attempt to interfere with them. On the 1st of April Nelson brought his ships through. He had transferred his flag from his own ship the "St George" (98) to the "Elephant" (74), commanded by Captain Foley, because the water was too shallow for a three-decker. On the morning of the 2nd of April the wind was fair from the south-east, and at 9.30 A.M. the British squadron weighed anchor, led by the "Amazon" frigate, commanded by Captain Riou, and began to pass along the front of the Danish line. The Danes could bring into action 375 guns in all. Their hulks and bomb-vessels were supported by batteries on Zealand; but, as the water is shallow for a long distance from the shore, these defences were too far off to render them effectual aid on the south end of their line. Nelson disposed of a greater number of guns, 1058 in all, but some did not come into action. The "Agamemnon" (64), commanded by Captain Fancourt, was unable to round the south point of the Middle Ground. The "Bellona" (74), commanded by Captain Thompson, and the "Russel" (74), commanded by Captain Cuming, ran ashore on the Middle Ground, but within range though at too great a distance for fully effective fire. Captain Thompson lost his leg in the battle. The other ships passed between the "Bellona" and "Russel" and the Danes. The leading British ship, the "Defiance" (74), carrying the flag of Rear-Admiral Graves, anchored just south of the Trekrøner. As the wind was from the south-east Sir Hyde Parker was unable to make the proposed attack from the north. The place opposite the Danish fort which was to have been taken by him was occupied by Captain Riou and the frigates. The "Elephant" anchored almost in the middle of the line. Fire was opened about 10 A.M., and at 11.30 the action was at its height.

Until 1 o'clock there was no diminution of the Danish fire. Sir Hyde Parker, who saw the danger of Nelson's position, became anxious, and sent his second, Captain Robert Waller Ottway, to him with a message authorizing him to retire if he thought fit. Before Ottway, who had to go in a row-boat, reached the "Elephant," Sir Hyde Parker had reflected that it would be more magnanimous in him to take the responsibility of ordering the retreat. He therefore hoisted the signal of recall. It was a well-meant but ill-judged order. Nelson could only have retreated before the south-easterly wind by going past the Trekrøner fort, where the passage is narrow, and the navigation

difficult. He therefore disregarded the signal, and amused himself and the few officers about him by putting his glass to his blind eye and saying that he could not see it. The frigates opposite the *Trekroner* did retreat, Captain Riou being slain as they drew off.

At about 2.30 the fire from the Danish hulks had been much beaten down, but as their crews fell, fresh men were sent from the shore and the fire was resumed. Nelson astutely and legitimately seized the opportunity to open negotiations with the Danes. He sent a flag of truce carried by Sir F. Thesiger ashore to the crown prince of Denmark (then regent of the kingdom), to say that unless he was allowed to take possession of the hulks which had surrendered he would be compelled to burn them, a course which he deprecated on the ground of humanity and his tenderness of "the brothers of the English the Danes." The crown prince, who was shaken by the spectacle of the battle, allowed himself to be drawn into a reply, and to be referred to Sir Hyde Parker. Fire was suspended by the Danes to allow of time to receive Sir Hyde Parker's answer. Nelson with intelligent promptitude availed himself of the interval to withdraw his squadron past the *Trekroner*. The difficulty found in getting the ships out—one of them grounded—showed how disastrous an attempt to draw off under fire of the forts must have been.

The Danish government, which had entered the coalition largely from fear of Russia, was not prepared to make very great sacrifices, and now entered into negotiations for an armistice. It was the more ready to do so because it received news of the assassination of the tsar Paul, which had happened on the 24th of March. An armistice was made for fourteen weeks, which left the British fleet free to proceed up the Baltic. On the 12th of April, after lightening the three-deckers of their guns, the fleet passed over the shallows. But its presence had now lost all military significance. Sir Hyde Parker was assured by the Russian minister at Copenhagen that the new tsar Alexander I. would not continue the policy of hostility with England and alliance with France which had proved fatal to his father. The Swedes, who like the Danes had entered the coalition under pressure from Russia, did not send their ships to sea. The government of the new tsar was prepared for an arrangement with England. The date of the final settlement was in all probability delayed by the activity of Nelson, and his belief that a British fleet was the best negotiator in Europe. The British government learnt of the tsar's death on the 15th of April. On the 17th it instructed Sir Hyde Parker to agree to a suspension of hostilities, and not to take active measures against Russia so long as the *Reval* squadron did not put to sea. On the 21st of April, having now received a full account of the battle at Copenhagen, it recalled Sir Hyde Parker, whose vacillating conduct and want of enterprise had become manifest. He received the news of his recall on the 5th of May. Nelson, to whom the command passed, at once put to sea, and hastened with a part of his fleet to *Reval*, which he reached on the 12th of May. The Russian squadron had, however, cut a passage through the ice in the harbour on the 3rd, and had sailed for *Kronstadt*. Nelson was received with formal civility by the Russian officers, with whom he exchanged visits. He wrote a letter to Mr Garlike, secretary of the British embassy at *St Petersburg*, saying that he had come with a small squadron as the best way of paying "the very highest compliment" to the tsar.

The Russian government, which not unnaturally wished to avoid any appearance of acting under dictation, and was now in no anxiety for the *Reval* squadron, treated his presence as a menace. On the 13th of May Count Pahlen answered in a most peremptory letter informing Nelson that negotiations would be suspended while he remained at *Reval*. This retort caused Nelson annoyance which he did not attempt to conceal, but he justly concluded that he had nothing further to do at *Reval*, and therefore returned down the Baltic. Nelson remained with the fleet till he was relieved at his own request, and was able to sail for England on the 18th of June. He gave a proof of his regard for the service of the country by taking his passage home

in a small brig rather than withdraw a line of battle ship from the squadron, which his rank entitled him to do, and as other admirals of the time generally did. The British sailors and ships embargoed in Russia were released on the 17th of May. Great Britain released her prisoners on the 4th of June, and on the 17th of June was signed the convention which terminated the Baltic campaign.

See *Dispatches and Letters of Vice-Admiral Nelson*, by Sir N. Harris Nicolas (1845); *Life of Nelson*, by Capt. A. T. Mahan (London, 1899).

**COPERNICUS** (or **KOPPERNIGK**), **NICOLAUS** (1473-1543), Polish astronomer, was born on the 19th of February 1473, at Thorn in Prussian Poland, where his father, a native of Cracow, had settled as a wholesale trader. His mother, Barbara Watzelrode, belonged to a family of high mercantile and civic standing. After the death of his father in 1483, Nicolaus was virtually adopted by his uncle Lucas Watzelrode, later (in 1489) bishop of Ermeland. Placed at the university of Cracow in 1491, he devoted himself, during three years, to mathematical science under Albert Brudzewski (1445-1497), and incidentally acquired some skill in painting. At the age of twenty-three he repaired to Bologna, and there varied his studies of canon law by attending the astronomical lectures of Domenico Maria Novara (1454-1504). At Rome, in the Jubilee year 1500, he himself lectured with applause; but having been nominated in 1497 canon of the cathedral of Frauenburg, he recrossed the Alps in 1501 with the purpose of obtaining further leave of absence for the completion of his academic career. Late in the same year, accordingly, he entered the medical school of Padua, where he remained until 1505, having taken meanwhile a doctor's degree in canon law at Ferrara on the 31st of May 1503. After his return to his native country he resided at the episcopal palace of Heilsberg as his uncle's physician until the latter's death on the 29th of March 1512. He then retired to Frauenburg, and vigorously attended to his capitular duties. He never took orders, but acted continually as the representative of the chapter under harassing conditions, administrative and political; he was besides commissary of the diocese of Ermeland; his medical skill, always at the service of the poor, was frequently in demand by the rich; and he laid a scheme for the reform of the currency before the Diet of Graudenz in 1522. Yet he found time, amid these multifarious occupations, to elaborate an entirely new system of astronomy, by the adoption of which man's outlook on the universe was fundamentally changed.

The main lines of his great work were laid down at Heilsberg; at Frauenburg, from 1513, he sought, with scanty instrumental means, to test by observation the truth of the views it embodied (see *ASTRONOMY: History*). His dissatisfaction with Ptolemaic doctrines was of early date; and he returned from Italy, where so-called Pythagorean opinions were then freely discussed, in strong and irrevocable possession of the heliocentric theory. The epoch-making treatise in which it was set forth, virtually finished in 1530, began to be known through the circulation in manuscript of a *Commentariolus*, or brief popular account of its purport written by Copernicus in that year. Johann Albrecht Widmanstadt lectured upon it in Rome; Clement VII. approved, and Cardinal Schönberg transmitted to the author a formal demand for full publication. But his assent to this was only extracted from him in 1540 by the importunities of his friends, especially of his enthusiastic disciple George Joachim Rheticus (1514-1576), who printed, in the *Narratio prima* (Danzig, 1540), a preliminary account of the Copernican theory, and simultaneously sent to the press at Nuremberg his master's complete exposition of it in the treatise entitled *De revolutionibus orbium coelestium* (1543). But the first printed copy reached Frauenburg barely in time to be laid on the writer's death-bed. Copernicus was seized with apoplexy and paralysis towards the close of 1542, and died on the 24th of May 1543, happily unconscious that the fine Epistle, in which he had dedicated his life's work to Paul III., was marred of its effect by an anonymous preface, slipt in by Andreas Osiander (1498-1552), with a view to disarming prejudice by insisting upon the purely hypothetical



character of the reasonings it introduced. The trigonometrical character of the book had been issued as a separate treatise (Wittenberg, 1542) under the care of Rheticus. The only work published by Copernicus on his own initiative was a Latin version of the Greek Epistles of Theophylact (Cracow, 1509). His treatise *De monetæ cudendæ ratione*, 1526 (first printed in 1816), written by order of King Sigismund I., is an exposition of the principles on which it was proposed to reform the currency of the Prussian provinces of Poland. It advocates unity of the monetary system throughout the entire state, with strict integrity in the quality of the coin, and the charge of a seigniorage sufficient to cover the expenses of mintage.

**AUTHORITIES.**—Rheticus was the only contemporary biographer of Copernicus, and his narrative perished irretrievably. Gassendi's jejune *Life* (Paris, 1654) is thus the earliest extant of any note. It was supplemented, during the 19th century, by the various publications of J. Sniadecki (Warsaw, 1803-1818); of J. H. W. Westphal, J. Czynski, M. Curtze, H. A. Wolynski, F. Hipler, and others, but their efforts were overshadowed by Dr Leopold Prowe's exhaustive *Nicolaus Copernicus* (Berlin, 1883-1884), embodying the outcome of researches indefatigably prosecuted for over thirty years. The first volume (in two parts) is a detailed biography of the great astronomer; the second includes some of his minor writings and correspondence, family records, and historical documents of local interest. The effects of his Italian sojourn upon the nascent ideas of Copernicus may be profitably studied in Domenico Berti's *Copernico e le vicende del sistema Copernicano in Italia* (Roma, 1876), and in G. V. Schiaparelli's *I Precursori del Copernico nell' antichità* (Milano, 1873). A centenary edition of *De revolutionibus orbium coelestium* was issued at Thorn in 1873, and a German translation by C. L. Menzzer in 1879. (A. M. C.)

**COPIAPÓ**, a city of northern Chile, capital of the province of Atacama, about 35 m. from the coast on the Copiapó river, in lat. 27° 36' S., long. 70° 23' W. Pop. (1895) 9301. The Caldera & Copiapó railway (built 1848-1851 and one of the first in South America) extends beyond Copiapó to the Chañarcillo mines (50 m.) and other mining districts. Copiapó stands 1300 ft. above sea-level and has a mean temperature of about 67° in summer and 51° in winter. Its port, Caldera, 50 m. distant by rail, is situated on a well-sheltered bay with good shipping facilities about 6 m. N. of the mouth of the Copiapó river. Copiapó is perhaps the best built and most attractive of the desert region cities. The river brings down from the mountains enough water to supply the town and irrigate a considerable area in its vicinity. Beyond the small fertile valley in which it stands is the barren desert, on which rain rarely falls and which has no economic value apart from its minerals (especially saline compounds). Copiapó was founded in 1742 by José de Manso (afterwards Conde de Superunda, viceroy of Peru) and took its name from the Copayapu Indians who occupied that region. It was primarily a military station and transport post on the road to Peru, but after the discovery of the rich silver deposits near Chañarcillo by Juan Godoy in 1832 it became an important mining centre. It has a good mining school and reduction works, and is the supply station for an extensive mining district. For many years the Famatina mines of Argentina received supplies from this point by way of the Come-Caballo pass.

**COPING** (from "cope," Lat. *capa*), in architecture, the capping or covering of a wall. This may be made of stone, brick, tile, slate, metal, wood or thatch. In all cases it should be weathered to throw off the wet. In Romanesque work it was plain and flat, and projected over the wall with a throating to form a drip. In later work a steep slope was given to the weathering (mainly on the outer side), and began at the top with an astragal; in the Decorated style there were two or three sets off; and in the later Perpendicular period these assumed a wavy section, and the coping mouldings were continued round the sides, as well as at top and bottom, mitreing at the angles, as in many of the colleges at Oxford. The cheapest type of coping is that which caps the ordinary 9 in. brick wall, and consists of brick on edge above a double tile creasing, all in cement; the creasing consisting of one or two rows of tiles laid horizontally on the wall and projecting on each side about 2 in. to throw off the water (see also MASONRY).

**COPLAND, ROBERT** (fl. 1515), English printer and author, is said to have been a servant of William Caxton, and certainly worked for Wynkyn de Worde. The first book to which his name is affixed as a printer is *The Boke of Justices of Peace* (1515), at the sign of the Rose Garland, in Fleet Street, London. Anthony à Wood supposed, on the ground that he was more educated than was usual in his trade, that he had been a poor scholar of Oxford. His best known works are *The hye way to the Spytell hous*, a dialogue in verse between Copland and the porter of St Bartholomew's hospital, containing much information about the vagabonds who found their way there; and *Jyl of Breyntfords Testament*, dismissed in *Athenae Oxonienses* (ed. Bliss) as "a poem devoid of wit or decency, and totally unworthy of further notice." He translated from the French the romances of *Kynge Appolyne of Thyre* (W. de Worde, 1510), *The History of Helyas Knyght of the Swanne* (W. de Worde, 1513), and *The Life of Ipomydon (Hue of Rotelande)*, not dated. Among his other works is *The Complaynte of them that ben too late maryed*, an undated tract printed by W. de Worde.

William Copland, the printer, supposed to have been his brother, published three editions of *Howleglas*, perhaps by Robert, which in any case represent the earliest English version of *Till Eulenspiegel*.

The *Knyght of the Swanne* was reprinted in Thom's *Early Prose Romances*, vol. iii., and by the Grolier Club (1901); the *Hye Way* in W. C. Hazlitt's *Remains of the Early Popular Poetry of England*, vol. iv. (1866). See further the "Forewords" to Dr F. J. Furnivall's reprint of *Jyl of Breyntford* (for private circulation, 1871) and J. P. Collier, *Bibliographical and Critical Account of the Rarest Books in the English Language*, vol. i. p. 153 (1865). For the books issued from his press see *Hand-Lists of English Printers* (1501-1556), printed for the Bibliographical Society in 1896.

**COPLESTON, EDWARD** (1776-1849), English bishop, was born at Offwell in Devonshire, and educated at Oxford. He was elected to a tutorship at Oriel College in 1797, and in 1800 was appointed vicar of St Mary's, Oxford. As university professor of poetry (1802-1812) he gained a considerable reputation by his clever literary criticism and sound latinity. After holding the office of dean at Oriel for some years, he succeeded to the provostship in 1814, and owing largely to his influence the college reached a remarkable degree of prosperity during the first quarter of the 19th century. In 1826 he was appointed dean of Chester, and in the next year he was consecrated bishop of Llandaff. Here he gave his support to the new movement for church restoration in Wales, and during his occupation of the see more than twenty new churches were built in the diocese. The political problems of the time interested him greatly, and his writings include two able letters to Sir Robert Peel, one dealing with the *Variable Standard of Value*, the other with the *Increase of Pauperism* (Oxford, 1819).

**COPLEY, JOHN SINGLETON** (1737-1815), English historical painter, was born of Irish parents at Boston, Massachusetts. He was self-educated, and commenced his career as a portrait-painter in his native city. The germ of his reputation in England was a little picture of a boy and squirrel, exhibited at the Society of Arts in 1760. In 1774 he went to Rome, and thence in 1775 came to England. In 1777 he was admitted associate of the Royal Academy; in 1783 he was made Academician on the exhibition of his most famous picture, the "Death of Chatham," popularized immediately by Bartolozzi's elaborate engraving; and in 1790 he was commissioned to paint a portrait picture of the defence of Gibraltar. The "Death of Major Pierson," in the National Gallery, also deserves mention. Copley's powers appear to greatest advantage in his portraits. He was the father of Lord Chancellor Lyndhurst.

**COPPÉE, FRANÇOIS ÉDOUARD JOACHIM** (1842-1908), French poet and novelist, was born in Paris on the 12th of January 1842. His father held a small post in the civil service, and he owed much to the care of an admirable mother. After passing through the Lycée Saint-Louis he became a clerk in the ministry of war, and soon sprang into public favour as a poet of the young "Parnassian" school. His first printed verses date from 1864. They were republished with others in 1866 in



a collected form (*Le Reliquaire*), followed (1867) by *Les Intimités* and *Poèmes modernes* (1867–1869). In 1869 his first play, *Le Passant*, was received with marked approval at the Odéon theatre, and later *Fais ce que dois* (1871) and *Les Bijoux de la délivrance* (1872), short metrical dramas inspired by the war, were warmly applauded.

After filling a post in the library of the senate, Coppée was chosen in 1878 as archivist of the Comédie-Française, an office which he held till 1884. In that year his election to the Academy caused him to retire altogether from his public appointments. He continued to publish volumes of poetry at frequent intervals, including *Les Humbles* (1872), *Le Cahier rouge* (1874), *Olivier* (1875), *L'Exilée* (1876), *Contes en vers*, &c. (1881), *Poèmes et récits* (1886), *Arrière-saison* (1887), *Paroles sincères* (1890). In his later years his output of verse declined, but he published two more volumes, *Dans la prière et la lutte* and *Vers français*. He had established his fame as "le poète des humbles." Besides the plays mentioned above, two others written in collaboration with Armand d'Artois, and some light pieces of little importance, Coppée produced *Madame de Maintenon* (1881), *Severo Torelli* (1883), *Les Jacobites* (1885), and other serious dramas in verse, including *Pour la couronne* (1895), which was translated into English (*For the Crown*) by John Davidson, and produced at the Lyceum Theatre in 1896. The performance of a short episode of the Commune, *Le Pater*, was prohibited by the government (1889). Coppée's first story in prose, *Une Idylle pendant le siège*, appeared in 1875. It was followed by various volumes of short tales, by *Toute une jeunesse* (1890)—an attempt to reproduce the feelings, if not the actual wants, of the writer's youth,—*Les Vrais Riches* (1892), *Le Coupable* (1896), &c. He was made an officer of the Legion of Honour in 1888. A series of reprinted short articles on miscellaneous subjects, styled *Mon Franc Parler*, appeared from 1893 to 1896; and in 1898 was published *La Bonne Souffrance*, the outcome of Coppée's reconversion to the Roman Catholic Church, which gained very wide popularity. The immediate cause of his return to the faith was a severe illness which twice brought him to the verge of the grave. Hitherto he had taken little open interest in public affairs, but he now joined the most violent section of Nationalist politicians, while retaining contempt for the whole apparatus of democracy. He took a leading part against the prisoner in the Dreyfus case, and was one of the originators of the notorious Ligue de la Patrie Française. He died on the 23rd of May 1908.

Alike in verse and prose Coppée concerned himself with the plainest expressions of human emotion, with elemental patriotism, and the joy of young love, and the pitifulness of the poor, bringing to bear on each a singular gift of sympathy and insight. The lyric and idyllic poetry, by which he will chiefly be remembered, is animated by musical charm, and in some instances, such as *La Bénédiction* and *La Grève des forgerons*, displays a vivid, though not a sustained, power of expression. There is force, too, in the gloomy tale, *Le Coupable*. But he exhibits all the defects of his qualities. In prose especially, his sentiment often degenerates into sentimentality, and he continually approaches, and sometimes oversteps, the verge of the trivial. Nevertheless, by neglecting that canon of contemporary art which would reduce the deepest tragedies of life to mere subjects for dissection, he won those common suffrages which are the prize of exquisite literature.

See M. de Lescure's *François Coppée, l'homme, la vie, l'œuvre* (1889), and G. Druilhet, *Un Poète français* (1902).

**COPPÉE, HENRY** (1821–1895), American educationalist and author, was born in Savannah, Georgia, on the 13th of October 1821, of a French family formerly settled in Haiti. He studied at Yale for two years, worked as a civil engineer, graduated at West Point in 1845, served in the Mexican War as a lieutenant and was breveted captain for gallantry at Contreras and Churubusco, was professor of English at West Point from 1850 to 1855 (when he resigned from the army), was professor of English literature and history in the University of Pennsylvania 1855–1866, and on the 1st of April 1866 was chosen first president of Lehigh University. In 1875 he was succeeded by

John McD. Leavitt and became professor of history and English literature, but was president *pro tem.* from the death of Robert A. Lamberton (b. 1824) in September 1893 to his own death in Bethlehem on the 22nd of March 1895. He published elementary text-books of logic (1857), of rhetoric (1859), and of English literature (1872); various manuals of drill; *Grant, a Military Biography* (1866); *General Thomas* (1893), in the "Great Commanders" Series; *History of the Conquest of Spain by the Arab-Moors* (1881); and in 1862 a translation of Marmont's *Esprit des institutions militaires*, besides editing the Comte de Paris's *Civil War in America*.

**COPPER** (symbol Cu, atomic weight 63.1, H=1, or 63.6, O=16), a metal which has been known to and used by the human race from the most remote periods. Its alloy with tin (bronze) was the first metallic compound in common use by mankind, and so extensive and characteristic was its employment in pre-historic times that the epoch is known as the Bronze Age. By the Greeks and Romans both the metal and its alloys were indifferently known as χαλκός and *aes*. As, according to Pliny, the Roman supply was chiefly drawn from Cyprus, it came to be termed *aes cyprium*, which was gradually shortened to *cyprium*, and corrupted into *cuprum*, whence comes the English word copper, the French *cuivre*, and the German *Kupfer*.

Copper is a brilliant metal of a peculiar red colour which assumes a pinkish or yellowish tinge on a freshly fractured surface of the pure metal, and is purplish when the metal contains cuprous oxide. Its specific gravity varies between 8.91 and 8.95, according to the treatment to which it may have been subjected; J. F. W. Hampe gives 8.945 ( $\frac{4}{5}$ ) for perfectly pure and compact copper. Ordinary commercial copper is somewhat porous and has a specific gravity ranging from 8.2 to 8.5. It takes a brilliant polish, is in a high degree malleable and ductile, and in tenacity it only falls short of iron, exceeding in that quality both silver and gold. By different authorities its melting-point is stated at from 1000° to 1200° C.; C. T. Heycock and F. H. Neville give 1080°·5; P. Dejean gives 1085° as the freezing-point. The molten metal is sea-green in colour, and at higher temperatures (in the electric arc) it vaporises and burns with a green flame. G. W. A. Kahlbaum succeeded in subliming the metal in a vacuum, and H. Moissan (*Compt. rend.*, 1905, 141, p. 853) distilled it in the electric furnace. Molten copper absorbs carbon monoxide, hydrogen and sulphur dioxide; it also appears to decompose hydrocarbons (methane, ethane), absorbing the hydrogen and the carbon separating out. These occluded gases are all liberated when the copper cools, and so give rise to porous castings, unless special precautions are taken. The gases are also expelled from the molten metal by lead, carbon dioxide, or water vapour. Its specific heat is 0.0899 at 0° C. and 0.0942 at 100°; the coefficient of linear expansion per 1° C. is 0.001869. In electric conductivity it stands next to silver; the conducting power of silver being equal to 100, that of perfectly pure copper is given by A. Matthiessen as 96.4 at 13° C.

Copper is not affected by exposure in dry air, but in a moist atmosphere, containing carbonic acid, it becomes coated with a green basic carbonate. When heated or rubbed it emits a peculiar disagreeable odour. Sulphuric and hydrochloric acids have little or no action upon it at ordinary temperatures, even when in a fine state of division; but on heating, copper sulphate and sulphur dioxide are formed in the first case, and cuprous chloride and hydrogen in the second. Concentrated nitric acid has also very little action, but with the dilute acid a vigorous action ensues. The first products of this reaction are copper nitrate and nitric oxide, but, as the concentration of the copper nitrate increases, nitrous oxide and, eventually, free nitrogen are liberated.

Many colloidal solutions of copper have been obtained. A reddish-brown solution is obtained from solutions of copper chloride, stannous chloride and an alkaline tartrate (Lottermoser, *Anorganische Colloïde*, 1901).

*Occurrence*.—Copper is widely distributed in nature, occurring in most soils, ferruginous mineral waters, and ores. It has been discovered in seaweed; in the blood of certain Cephalopoda and Ascidia as haemocyanin, a substance resembling the ferruginous

haemoglobin, and of a species of *Limulus*; in straw, hay, eggs, cheese, meat, and other food-stuffs; in the liver and kidneys, and, in traces, in the blood of man and other animals (as an entirely adventitious constituent, however); it has also been shown by A. H. Church to exist to the extent of 5.9% in turacin, the colouring-matter of the wing-feathers of the Turaco.

Native copper, sometimes termed by miners malleable or virgin copper, occurs as a mineral having all the properties of the smelted metal. It crystallizes in the cubic system, but the crystals are often flattened, elongated, rounded or otherwise distorted. Twins are common. Usually the metal is arborescent, dendritic, filiform, moss-like or laminar. Native copper is found in most copper-mines, usually in the upper workings, where the deposit has been exposed to atmospheric influences. The metal seems to have been reduced from solutions of its salts, and deposits may be formed around mine-timber or on iron objects. It often fills cracks and fissures in the rock. It is not infrequently found in serpentine, and in basic eruptive rocks, where it occurs as veins and in amygdaloids. The largest known deposits are those in the Lake Superior region, near Keweenaw Point, Michigan, where masses upwards of 400 tons in weight have been discovered. The metal was formerly worked by the Indians for implements and ornaments. It occurs in a series of amygdaloidal dolerites or diabases, and in the associated sandstones and conglomerates. Native silver occurs with the copper, in some cases embedded in it, like crystals in a porphyry. The copper is also accompanied by epidote, calcite, prehnite, analcite and other zeolitic minerals. Pseudomorphs after calcite are known; and it is notable that native copper occurs pseudomorphous after aragonite at Corocoro, in Bolivia, where the copper is disseminated through sandstone.

**Ores.**—The principal ores of copper are the oxides cuprite and melaconite, the carbonates malachite and chessylite, the basic chloride atacamite, the silicate chrysocolla, the sulphides chalcocite, chalcopyrite, erubescite and tetrahedrite. Cuprite (*q.v.*) occurs in most cupriferous mines, but never by itself in large quantities. Melaconite (*q.v.*) was formerly largely worked in the Lake Superior region, and is abundant in some of the mines of Tennessee and the Mississippi valley. Malachite is a valuable ore containing about 56% of the metal; it is obtained in very large quantities from South Australia, Siberia and other localities. Frequently intermixed with the green malachite is the blue carbonate chessylite or azurite (*q.v.*), an ore containing when pure 55.16% of the metal. Atacamite (*q.v.*) occurs chiefly in Chile and Peru. Chrysocolla (*q.v.*) contains in the pure state 30% of the metal; it is an abundant ore in Chile, Wisconsin and Missouri. The sulphur compounds of copper are, however, the most valuable from the economic point of view. Chalcocite, redruthite, copper-glance (*q.v.*) or vitreous copper ( $\text{Cu}_2\text{S}$ ) contains about 80% of copper. Copper pyrites, or chalcopyrite, contains 34.6% of copper when pure; but many of the ores, such as those worked specially by wet processes on account of the presence of a large proportion of iron sulphide, contain less than 5% of copper. Cornish ores are almost entirely pyritic; and indeed it is from such ores that by far the largest proportion of copper is extracted throughout the world. In Cornwall copper lodes usually run east and west. They occur both in the "killas" or clay-slate, and in the "growan" or granite. Erubescite (*q.v.*), bornite, or horseflesh ore is much richer in copper than the ordinary pyrites, and contains 56 or 57% of copper. Tetrahedrite (*q.v.*), fahlerz, or grey copper, contains from 30 to 48% of copper, with arsenic, antimony, iron and sometimes zinc, silver or mercury. Other copper minerals are percyllite ( $\text{PbCuCl}_2(\text{OH})_2$ ), boleite ( $3\text{PbCuCl}_2(\text{OH})_3$ ,  $\text{AgCl}$ ), stromeyerite ( $\{(\text{Cu}, \text{Ag})_2\text{S}\}$ ), cubanite ( $\text{CuS}, \text{Fe}_2\text{S}_3$ ), stannite ( $\text{Cu}_2\text{S}, \text{FeSnS}_3$ ), tennantite ( $3\text{Cu}_2\text{S}, \text{As}_2\text{S}_3$ ), emplectite ( $\text{Cu}_2\text{S}, \text{Bi}_2\text{S}_3$ ), wolfsbergite ( $\text{Cu}_2\text{S}, \text{Sb}_2\text{S}_3$ ), famatinite ( $3\text{Cu}_2\text{S}, \text{Sb}_2\text{S}_3$ ) and enargite ( $3\text{Cu}_2\text{S}, \text{As}_2\text{S}_3$ ). For other minerals, see *Compounds of Copper* below.

**Metallurgy.**—Copper is obtained from its ores by three principal methods, which may be denominated—(1) the pyro-metallurgical or dry method, (2) the hydro-metallurgical or wet method, and (3) the electro-metallurgical method.

The methods of working vary according to the nature of the ores treated and local circumstances. The dry method, or ordinary smelting, cannot be profitably practised with ores containing less than 4% of copper, for which and for still poorer ores the wet process is preferred.

**Copper Smelting.**—We shall first give the general principles which underlie the methods for the dry extraction of copper, and then proceed to a more detailed discussion of the plant used. Since all sulphuretted copper ores (and these are of the most economic importance) are invariably contaminated with arsenic and antimony, it is necessary to eliminate these impurities, as far as possible, at a very early stage. This is effected by calcination or roasting. The roasted ore is then smelted to a mixture of copper and iron sulphides, known as copper "matte" or "coarse-metal," which contains little or no arsenic, antimony or silica. The coarse-metal is now smelted, with coke and siliceous fluxes (in order to slag off the iron), and the product, consisting of an impure copper sulphide, is variously known as "blue-metal," when more or less iron is still present, "pimple-metal," when free copper and more or less copper oxide is present, or "fine" or "white-metal," which is a fairly pure copper sulphide, containing about 75% of the metal. This product is re-smelted to form "coarse-copper," containing about 95% of the metal, which is then refined. Roasted ores may be smelted in reverberatory furnaces (English process), or in blast-furnaces (German or Swedish process). The matte is treated either in reverberatory furnaces (English process), in blast furnaces (German process), or in converters (Bessemer process). The "American process" or "Pyritic smelting" consists in the direct smelting of raw ores to matte in blast furnaces. The plant in which the operations are conducted varies in different countries. But though this or that process takes its name from the country in which it has been mainly developed, this does not mean that only that process is there followed.

The "English process" is made up of the following operations: (1) calcination; (2) smelting in reverberatory furnaces to form the matte; (3) roasting the matte; and (4) subsequent smelting in reverberatory furnaces to fine- or white-metal; (5) treating the fine-metal in reverberatory furnaces to coarse- or blister-copper, either with or without previous calcination; (6) refining of the coarse-copper. A shorter process (the so-called "direct process") converts the fine-metal into refined copper directly. The "Welsh process" closely resembles the English method; the main difference consists in the enrichment of the matte by smelting with the rich copper-bearing slags obtained in subsequent operations. The "German or Swedish process" is characterized by the introduction of blast-furnaces. It is made up of the following operations: (1) calcination, (2) smelting in blast-furnaces to form the matte, (3) roasting the matte, (4) smelting in blast-furnaces with coke and fluxes to "black-" or "coarse-metal," (5) refining the coarse-metal. The "Anglo-German Process" is a combination of the two preceding, and consists in smelting the calcined ores in shaft furnaces, concentrating the matte in reverberatory furnaces, and smelting to coarse-metal in either.

The impurities contained in coarse-copper are mainly iron, lead, zinc, cobalt, nickel, bismuth, arsenic, antimony, sulphur, selenium and tellurium. These can be eliminated by an oxidizing fusion, and slagging or volatilizing the products resulting from this operation, or by electrolysis (see below). In the process of oxidation, a certain amount of cuprous oxide is always formed, which melts in with the copper and diminishes its softness and tenacity. It is, therefore, necessary to reconvert the oxide into the metal. This is effected by stirring the molten metal with a pole of green wood ("poling"); the products which arise from the combustion and distillation of the wood reduce the oxide to metal, and if the operation be properly conducted "tough-pitch" copper, soft, malleable and exhibiting a lustrous silky fracture, is obtained. The surface of the molten metal is protected from oxidation by a layer of anthracite or charcoal. "Bean-shot" copper is obtained by throwing the molten metal into hot water; if cold water be used, "feathered-shot" copper is formed.

"Rosette" copper is obtained as thin plates of a characteristic dark-red colour, by pouring water upon the surface of the molten metal, and removing the crust formed. "Japan" copper is purple-red in colour, and is formed by casting into ingots, weighing from six ounces to a pound, and rapidly cooling by immersion in water. The colour of these two varieties is due to a layer of oxide. "Tile" copper is an impure copper, and is obtained by refining the first tappings. "Best-selected" copper is a purer variety.

*Calcination or Roasting and Calcining Furnaces.*—The roasting should be conducted so as to eliminate as much of the arsenic and antimony as possible, and to leave just enough sulphur as is necessary to combine with all the copper present when the calcined ore is smelted. The process is effected either in heaps, stalls, shaft furnaces, reverberatory furnaces or muffle furnaces. Stall and heap roasting require considerable time, and can only be economically employed when the loss of the sulphur is of no consequence; they also occupy much space, but they have the advantage of requiring little fuel and handling. Shaft furnaces are in use for ores rich in sulphur, and where it is desirable to convert the waste gases into sulphuric acid. Reverberatory roasting does not admit of the utilization of the waste gases, and requires fine ores and much labour and fuel; it has, however, the advantage of being rapid. Muffle furnaces are suitable for fine ores which are liable to decrepitate or sinter. They involve high cost in fuel and labour, but permit the utilization of the waste gases.

Reverberatory furnaces of three types are employed in calcining copper ores: (1) fixed furnaces, with either hand or mechanical rabbling; (2) furnaces with movable beds; (3) furnaces with rotating working chambers. Hand rabbling in fixed furnaces has been largely superseded by mechanical rabbling. Of mechanically rabbling furnaces we may mention the O'Harra modified by Allen-Brown, the Hixon, the Keller-Gaylord-Cole, the Ropp, the Spence, the Wethey, the Parkes, Pearce's "Turret" and Brown's "Horseshoe" furnaces. Blake's and Brunton's furnaces are reverberatory furnaces with a movable bed. Furnaces with rotating working chambers admit of continuous working; the fuel and labour costs are both low.

In the White-Howell revolving furnace with lifters—a modification of the Oxland—the ore is fed and discharged in a continuous stream. The Brückner cylinder resembles the Elliot and Russell black ash furnace; its cylinder tapers slightly towards each end, and is generally 18 ft. long by 8 ft. 6 in. in its greatest diameter. Its charge of from 8 to 12 tons of ore or concentrates is slowly agitated at a rate of three revolutions a minute, and in from 24 to 36 hours it is reduced from say 40 or 35% to 7% of sulphur. The ore is under better control than is possible with the continuous feed and discharge, and when sufficiently roasted can be passed red-hot to the reverberatory furnace. These advantages compensate for the wear and tear and the cost of moving the heavy dead-weight.

Shaft calcining furnaces are available for fine ores and permit the recovery of the sulphur. They are square, oblong or circular in section, and the interior is fitted with horizontal or inclined plates or prisms, which regulate the fall of the ore. In the Gerstenhoffer and Hasenclever-Helbig furnaces the fall is retarded by prisms and inclined plates. In other furnaces the ore rests on a series of horizontal plates, and either remains on the same plate throughout the operation (Ollivier and Perret furnace), or is passed from plate to plate by hand (Malétra), or by mechanical means (Spence and M'Dougall).

The M'Dougall furnace is turret-shaped, and consists of a series of circular hearths, on which the ore is agitated by rakes attached to revolving arms and made to fall from hearth to hearth. It has been modified by Herreshoff, who uses a large hollow revolving central shaft cooled by a current of air. The shaft is provided with sockets, into which movable arms with their rakes are readily dropped. The Peter Spence type of calcining furnace has been followed in a large number of inventions. In some the rakes are attached to rigid frames, with a reciprocating motion, in others to cross-bars moved by revolving chains. Some of

these furnaces are straight, others circular. Some have only one hearth, others three. This and the previous type of furnace, owing to their large capacity, are at present in greatest favour. The M'Dougall-Herreshoff, working on ores of over 30% of sulphur, requires no fuel; but in furnaces of the reverberatory type fuel must be used, as an excess of air enters through the slotted sides and the hinged doors which open and shut frequently to permit of the passage of the rakes. The consumption of fuel, however, does not exceed 1 of coal to 10 of ore. The quantity of ore which these large furnaces, with a hearth area as great as 2000 ft. and over, will roast varies from 40 to 60 tons a day. Shaft calcining furnaces like the Gerstenhoffer, Hasenclever, and others designed for burning pyrites fines have not found favour in modern copper works.

*The Fusion of Ores in Reverberatory and Cupola Furnaces.*—After the ore has been partially calcined, it is smelted to extract its earthy matter and to concentrate the copper with part of its iron and sulphur into a matte. In reverberatory furnaces it is smelted by fuel in a fireplace, separate from the ore, and in cupolas the fuel, generally coke, is in direct contact with the ore. When Swansea was the centre of the copper-smelting industry in Europe, many varieties of ores from different mines were smelted in the same furnaces, and the Welsh reverberatory furnaces were used. To-day more than eight-tenths of the copper ores of the world are reduced to impure copper bars or to fine copper at the mines; and where the character of the ore permits, the cupola furnace is found more economical in both fuel and labour than the reverberatory.

The Welsh method finds adherents only in Wales and Chile. In America the usual method is to roast ores or concentrates so that the matte yielded by either the reverberatory or cupola furnace will run from 45 to 50% in copper, and then to transfer to the Bessemer converter, which blows it up to 99%. In Butte, Montana, reverberatories have in the past been preferred to cupola furnaces, as the charge has consisted mainly of fine roasted concentrates; but the cupola is gaining ground there. At the Boston and Great Falls (Montana) works tilting reverberatories, modelled after open hearth steel furnaces, were first erected; but they were found to possess objectionable features. Now both these and the egg-shaped reverberatories are being abandoned for furnaces as long as 43 ft. 6 in. from bridge to bridge and of a width of 15 ft. 9 in. heated by gas, with regenerative checker work at each end, and fed with ore or concentrates, red-hot from the calciners, through a line of hoppers suspended above the roof. Furnaces of this size smelt 200 tons of charge a day. But even when the old type of reverberatory is preferred, as at the Argo works, at Denver, where rich gold- and silver-bearing copper matte is made, the growth of the furnace in size has been steady. Richard Pearce's reverberatories in 1878 had an area of hearth of 15 ft. by 9 ft. 8 in., and smelted 12 tons of cold charge daily, with a consumption of 1 ton of coal to 2.4 tons of ore. In 1900 the furnaces were 35 ft. by 16 ft., and smelted 50 tons daily of hot ore, with the consumption of 1 ton of coal to 3.7 tons of ore.

The home of cupola smelting was Germany, where it has never ceased to make steady progress. In Mansfeld brick cupola furnaces are without a rival in size, equipment and performance. They are round stacks, designed on the model of iron blast furnaces, 29 ft. high, fed mechanically, and provided with stoves to heat the blast by the furnace gases. The low percentage of sulphur in the roasted ore is little more than enough to produce a matte of 40 to 45%, and therefore the escaping gases are better fitted than those of most copper cupola furnaces for burning in a stove. But as the slag carries on an average 46% of silica, it is only through the utmost skill that it can be made to run as low on an average as 0.3% in copper oxide. As the matte contains on an average 0.2% of silver, it is still treated by the Ziervogel wet method of extraction, the management dreading the loss which might occur in the Bessemer process of concentration, applied as preliminary to electrolytic separation. Blast furnaces of large size, built of brick, have been constructed for treating the richest and more silicious ores of Rio Tinto, and

the Rio Tinto Company has introduced converters at the mine. This method of extraction contrasts favourably in time with the leaching process, which is so slow that over 10,000,000 tons of ore are always under treatment on the immense leaching floors of the company's works in Spain. In the United States the cupola has undergone a radical modification in being built of water-jacketed sections. The first water-jacketed cupola which came into general use was a circular inverted cone, with a slight taper, of 36 inches diameter at the tuyeres, and composed of an outer and an inner metal shell, between which water circulated. As greater size has been demanded, oval and rectangular furnaces—as large as 180 in. by 56 in. at the tuyeres—have been built in sections of cast or sheet iron or steel. A single section can be removed and replaced without entirely emptying the stack, as a shell of congealed slag always coats the inner surface of the jacket. The largest furnaces are those of the Boston & Montana Company at Great Falls, Montana, which have put through 500 tons of charge daily, pouring their melted slag and matte into large wells of 10 ft. in diameter. A combined brick- and water-cooled furnace has been adopted by the Iron Mountain Company at Keswick, Cal., for matte concentration. In it the cooling is effected by water pipes, interposed horizontally between the layers of bricks. The Mt. Lyell smelting works in Tasmania, which are of special interest, will be referred to later. (See *Pyritic Smelting* below.)

*Concentrating Matte to Copper in the Bessemer Converter.*—As soon as the pneumatic method of decarburizing pig iron was accepted as practicable, experiments were made with a view to Bessemerizing copper ores and mattes. One of the earliest and most exhaustive series of experiments was made on Rio Tinto ores at the John Brown works by John Hollway, with the aim of both smelting the ore and concentrating the matte in the same furnace, by the heat evolved through the oxidation of their sulphur and iron. Experiments along the same lines were made by Francis Bawden at Rio Tinto and Claude Vautin in Australia. The difficulty of effecting this double object in one operation was so great that in subsequent experiments the aim was merely to concentrate the matte to metallic copper in converters of the Bessemer type. The concentration was effected without any embarrassment till metallic copper commenced to separate and chill in the bottom tuyeres. To meet this obstacle P. Manhès proposed elevated side tuyeres, which could be kept clear by punching through gates in a wind box. His invention was adopted by the Vivians, at the Eguilles works near Sargues, Vaucluse, France, and at Leghorn in Italy. But the greatest expansion of this method has been in the United States, where more than 400,000,000 lb. of copper are annually made in Bessemer converters. Vessels of several designs are used—some modelled exactly after steel converters, other barrel-shaped, but all with side tuyeres elevated about 10 in. above the level of the bottom lining. Practice, however, in treating copper matte differs essentially from the treatment of pig iron, inasmuch as from 20 to 30% of iron must be eliminated as slag and an equivalent quantity of silica must be supplied. The only practical mode of doing this, as yet devised, is by lining the converter with a silicious mixture. This is so rapidly consumed that the converters must be cooled and partially relined after 3 to 6 charges, dependent on the iron contents of the matte. When available, a silicious rock containing copper or the precious metals is of course preferred to barren lining. The material for lining, and the frequent replacement thereof, constitute the principal expense of the method. The other items of cost are *labour*, the quantity of which depends on the mechanical appliances provided for handling the converter shells and inserting the lining; and the *blast*, which in barrel-shaped converters is low and in vertical converters is high, and which varies therefore from 3 to 15 lb to the square inch. The quantity of air consumed in a converter which will blow up about 35 tons of matte per day is about 3000 cub. ft. per minute. The operation of raising a charge of 50% matte to copper usually consists of two blows. The first blow occupies about 25 minutes, and oxidizes all but a small quantity of the iron and some of the sulphur, raising

the product to white metal. The slag is then poured and skimmed, the blast turned on and converter retilted. During the second blow the sulphur is rapidly oxidized, and the charge reduced to metal of 99% in from 30 to 40 minutes. Little or no slag results from the second blow. That from the first blow contains between 1% and 2% of copper, and is usually poured from ladles operated by an electric crane into a reverberatory, or into the settling well of the cupola. The matte also, in all economically planned works, is conveyed, still molten, by electric cranes from the furnace to the converters. When lead or zinc is not present in notable quantity, the loss of the precious metals by volatilization is slight, but more than 5% of these metals in the matte is prohibitive. Under favourable conditions in the larger works of the United States the cost of converting a 50% matte to metallic copper is generally understood to be only about  $\frac{1}{8}$  to  $\frac{1}{10}$  of a cent per lb. of refined copper.

*Pyritic Smelting.*—The heat generated by the oxidation of iron and sulphur has always been used to maintain combustion in the kilns or stalls for roasting pyrites. Pyritic smelting is a development of the Russian engineer Semenikov's treatment (proposed in 1866) of copper matte in a Bessemer converter. Since John Hollway's and other early experiments of Lawrence Austin and Robert Sticht, no serious attempts have been made to utilize the heat escaping from a converting vessel in smelting ore and matte either in the same apparatus or in a separate furnace. But considerable progress has been made in smelting highly sulphuretted ores by the heat of their own oxidizable constituents. At Tilt Cove, Newfoundland, the Cape Copper Company smelted copper ore, with just the proper proportion of sulphur, iron and silica, successfully without any fuel, when once the initial charge had been fused with coke. The furnaces used were of ordinary design and built of brick. Lump ore alone was fed, and the resulting matte showed a concentration of only 3 into 1. When, however, a hot blast is used on highly sulphuretted copper ores, a concentration of 8 of ore into 1 of matte is obtained, with a consumption of less than one-third the fuel which would be consumed in smelting the charge had the ore been previously calcined. A great impetus to pyritic smelting was given by the investigations of W. L. Austin, of Denver, Colorado, and both at Leadville and Silverton raw ores are successfully smelted with as low a fuel consumption as 3 of coke to 100 of charge.

Two types of pyritic smelting may be distinguished: one, in which the operation is solely sustained by the combustion of the sulphur in the ores, without the assistance of fuel or a hot blast; the other in which the operation is accelerated by fuel, or a hot blast, or both. The largest establishment in which advantage is taken of the self-contained fuel is at the smelting works of the Mt. Lyell Company, Tasmania. There the blast is raised from 600° to 700° F. in stoves heated by extraneous fuel, and the raw ore smelted with only 3% of coke. The ore is a compact iron pyrites containing copper 2.5%, silver 3.83 oz., gold 0.139 oz. It is smelted raw with hot blast in cupola furnaces, the largest being 210 in. by 40 in. The resulting matte runs 25%. This is reconcentrated raw in hot-blast cupolas to 55%, and blown directly into copper in converters. Thus these ores, as heavily charged with sulphur as those of the Rio Tinto, are speedily reduced by three operations and without roasting, with a saving of 97.6% of the copper, 93.2% of the silver and 93.6% of the gold.

Pyritic smelting has met with a varying economic success. According to Herbert Lang, its most prominent chance of success is in localities where fuel is dear, and the ores contain precious metals and sufficient sulphides and arsenides to render profitable dressing unnecessary.

*The Nicholls and James Process.*—Nicholls and James have applied, very ingeniously, well-known reactions to the refining of copper, raised to the grade of white metal. This process is practised by the Cape Copper and Elliot Metal Company. A portion of the white metal is calcined to such a degree of oxidation that when fused with the unroasted portion, the reaction between the oxygen in the roasted matte and the sulphur in the raw

material liberates the metallic copper. The metal is so pure that it can be refined by a continuous operation in the same furnace.

*Wet Methods for Copper Extraction.*—Wet methods are only employed for low grade ores (under favourable circumstances ore containing from  $\frac{1}{4}$  to 1% of copper has admitted of economic treatment), and for gold and silver bearing metallurgical products.

The fundamental principle consists in getting the ore into a solution, from which the metal can be precipitated. The ores of any economic importance contain the copper either as oxide, carbonate, sulphate or sulphide. These compounds are got into solution either as chlorides or sulphates, and from either of these salts the metal can be readily obtained. Ores in which the copper is present as oxide or carbonate are soluble in sulphuric or hydrochloric acids, ferrous chloride, ferric sulphate, ammoniacal compounds and sodium thiosulphate. Of these solvents, only the first three are of economic importance. The choice of sulphuric or hydrochloric acid depends mainly upon the cost, both acting with about the same rapidity; thus if a Leblanc soda factory is near at hand, then hydrochloric acid would most certainly be employed. Ferrous chloride is not much used; the Douglas-Hunt process uses a mixture of salt and ferrous sulphate which involves the formation of ferrous chloride, and the new Douglas-Hunt process employs sulphuric acid in which ferrous chloride is added after leaching.

Sulphuric acid may be applied as such on the ores placed in lead, brick, or stone chambers; or as a mixture of sulphur dioxide, nitrous fumes (generated from Chile saltpetre and sulphuric acid), and steam, which permeates the ore resting on the false bottom of a brick chamber. When most of the copper has been converted into the sulphate, the ore is lixiviated. Hydrochloric acid is applied in the same way as sulphuric acid; it has certain advantages of which the most important is that it does not admit the formation of basic salts; its chief disadvantage is that it dissolves the oxides of iron, and accordingly must not be used for highly ferriferous ores. The solubility of copper carbonate in ferrous chloride solution was pointed out by Max Schaffner in 1862, and the subsequent recognition of the solubility of the oxide in the same solvent by James Douglas and Sterry Hunt resulted in the "Douglas-Hunt" process for the wet extraction of copper. Ferrous chloride decomposes the copper oxide and carbonate with the formation of cuprous and cupric chlorides (which remain in solution), and the precipitation of ferrous oxide, carbon dioxide being simultaneously liberated from the carbonate. In the original form of the Douglas-Hunt process, ferrous chloride was formed by the interaction of sodium chloride (common salt) with ferrous sulphate (green vitriol), the sodium sulphate formed at the same time being removed by crystallization. The ground ore was stirred with this solution at 70° C. in wooden tubs until all the copper was dissolved. The liquor was then filtered from the iron oxides, and the filtrate treated with scrap iron, which precipitated the copper and reformed ferrous chloride, which could be used in the first stage of the process. The advantage of this method rests chiefly on the small amount of iron required; but its disadvantages are that any silver present in the ores goes into solution, the formation of basic salts, and the difficulty of filtering from the iron oxides. A modification of the method was designed to remedy these defects. The ore is first treated with dilute sulphuric acid, and then ferrous or calcium chloride added, thus forming copper chlorides. If calcium chloride be used the precipitated calcium sulphate must be removed by filtration. Sulphur dioxide is then blown in, and the precipitate is treated with iron, which produces metallic copper, or milk of lime, which produces cuprous oxide. Hot air is blown into the filtrate, which contains ferrous or calcium chlorides, to expel the excess of sulphur dioxide, and the liquid can then be used again. In this process ("new Douglas-Hunt") there are no iron oxides formed, the silver is not dissolved, and the quantity of iron necessary is relatively small, since all the copper is in the cuprous condition. It is not used in the treatment of ores, but finds application in the case of calcined argentiferous lead and copper mattes.

The precipitation of the copper from the solution, in which it is present as sulphate, or as cuprous and cupric chlorides, is generally effected by metallic iron. Either wrought, pig, iron sponge or iron bars are employed, and it is important to notice that the form in which the copper is precipitated, and also the time taken for the separation, largely depend upon the condition in which the iron is applied. Spongy iron acts most rapidly, and after this follow iron turnings and then sheet clippings. Other precipitants such as sulphuretted hydrogen and solutions of sulphides, which precipitate the copper as sulphides, and milk of lime, which gives copper oxides, have not met with commercial success. When using iron as the precipitant, it is desirable that the solution should be as neutral as possible, and the quantity of ferric salts present should be reduced to a minimum; otherwise, a certain amount of iron would be used up by the free acid and in reducing the ferric salts. Ores in which the copper is present as sulphate are directly lixiviated and treated with iron. Mine waters generally contain the copper in this form, and it is extracted by conducting the waters along troughs fitted with iron gratings.

The wet extraction of metallic copper from ores in which it occurs as the sulphide, may be considered to involve the following operations: (1) conversion of the copper into a soluble form, (2) dissolving out the soluble copper salt, (3) the precipitation of the copper. Copper sulphide may be converted either into the sulphate, which is soluble in water; the oxide, soluble in sulphuric or hydrochloric acid; cupric chloride, soluble in water; or cuprous chloride, which is soluble in solutions of metallic chlorides.

The conversion into sulphate is generally effected by the oxidizing processes of weathering, calcination, heating with iron nitrate or ferric sulphate. It may also be accomplished by calcination with ferrous sulphate, or other easily decomposable sulphates, such as aluminium sulphate. Weathering is a very slow, and, therefore, an expensive process; moreover, the entire conversion is only accomplished after a number of years. Calcination is only advisable for ores which contain relatively much iron pyrites and little copper pyrites. Also, however slowly the calcination may be conducted, there is always more or less copper sulphide left unchanged, and some copper oxide formed. Calcination with ferrous sulphate converts all the copper sulphide into sulphate. Heap roasting has been successfully employed at Agordo, in the Venetian Alps, and at Majdanpek in Servia. Josef Perino's process, which consists in heating the ore with iron nitrate to 50°–150° C., is said to possess several advantages, but it has not been applied commercially. Ferric sulphate is only used as an auxiliary to the weathering process and in an electrolytic process.

The conversion of the sulphide into oxide is adopted where the Douglas-Hunt process is employed, or where hydrochloric or sulphuric acids are cheap. The calcination is effected in reverberatory furnaces, or in muffle furnaces, if the sulphur is to be recovered. Heap, stall or shaft furnace roasting is not very satisfactory, as it is very difficult to transform all the sulphide into oxide.

The conversion of copper sulphide into the chlorides may be accomplished by calcining with common salt, or by treating the ores with ferrous chloride and hydrochloric acid or with ferric chloride. The dry way is best; the wet way is only employed when fuel is very dear, or when it is absolutely necessary that no noxious vapours should escape into the atmosphere. The dry method consists in an oxidizing roasting of the ores, and a subsequent chloridizing roasting with either common salt or *Abraumsalz* in reverberatory or muffle furnaces. The bulk of the copper is thus transformed into cupric chloride, little cuprous chloride being obtained. This method had been long proposed by William Longmaid, Max Schaffner, Becchi and Haupt, but was only introduced into England by the labours of William Henderson, J. A. Phillips and others. The wet method is employed at Rio Tinto, the particular variant being known as the "Dötsch" process. This consists in stacking the broken ore in heaps and adding a mixture of sodium sulphate and ferric



chloride in the proportions necessary for the entire conversion of the iron into ferric sulphate. The heaps are moistened with ferric chloride solution, and the reaction is maintained by the liquid percolating through the heap. The liquid is run off at the base of the heaps into the precipitating tanks, where the copper is thrown down by means of metallic iron. The ferrous chloride formed at the same time is converted into ferric chloride which can be used to moisten the heaps. This conversion is effected by allowing the ferrous chloride liquors slowly to descend a tower, filled with pieces of wood, coke or quartz, where it meets an ascending current of chlorine.

The sulphate, oxide or chlorides, which are obtained from the sulphuretted ores, are lixiviated and the metal precipitated in the same manner as we have previously described.

The metal so obtained is known as "cement" copper. If it contains more than 55% of copper it is directly refined, while if it contains a lower percentage it is smelted with matte or calcined copper pyrites. The chief impurities are basic salts of iron, free iron, graphite, and sometimes silica, antimony and iron arsenates. Washing removes some of these impurities, but some copper always passes into the slimes. If much carbonaceous matter be present (and this is generally so when iron sponge is used as the precipitant) the crude product is heated to redness in the air; this burns out the carbon, and, at the same time, oxidizes a little of the copper, which must be subsequently reduced. A similar operation is conducted when arsenic is present; basic-lined reverberatory furnaces have been used for the same purpose.

**Electrolytic Refining.**—The principles have long been known on which is based the electrolytic separation of copper from the certain elements which generally accompany it, whether these, like silver and gold, are valuable, or, like arsenic, antimony, bismuth, selenium and tellurium, are merely impurities. But it was not until the dynamo was improved as a machine for generating large quantities of electricity at a very low cost that the electrolysis of copper could be practised on a commercial scale. To-day, by reason of other uses to which electricity is applied, electrically deposited copper of high conductivity is in ever-increasing demand, and commands a higher price than copper refined by fusion. This increase in value permits of copper with not over £2 or \$10 worth of the precious metals being profitably subjected to electrolytic treatment. Thus many million ounces of silver and a great deal of gold are recovered which formerly were lost.

The earliest serious attempt to refine copper industrially was made by G. R. Elkington, whose first patent is dated 1865. He cast crude copper, as obtained from the ore, into plates which were used as anodes, sheets of electro-deposited copper forming the cathodes. Six anodes were suspended, alternately with four cathodes, in a saturated solution of copper sulphate in a cylindrical fire-clay trough, all the anodes being connected in one parallel group, and all the cathodes in another. A hundred or more jars were coupled in series, the cathodes of one to the anodes of the next, and were so arranged that with the aid of side-pipes with leaden connexions and india-rubber joints the electrolyte could, once daily, be made to circulate through them all from the top of one jar to the bottom of the next. The current from a Wilde's dynamo was passed, apparently with a current density of 5 or 6 amperes per sq. ft., until the anodes were too crippled for further use. The cathodes, when thick enough, were either cast and rolled or sent into the market direct. Silver and other insoluble impurities collected at the bottom of the trough up to the level of the lower side-tube, and were then run off through a plug in the bottom into settling tanks, from which they were removed for metallurgical treatment. The electrolyte was used until the accumulation of iron in it was too great, but was mixed from time to time with a little water acidulated by sulphuric acid. This process is of historic interest, and in principle it is identical with that now used. The modifications introduced have been chiefly in details, in order to economize materials and labour, to ensure purity of product, and to increase the rate of deposition.

The chemistry of the process has been studied by Martin Kiliani (*Berg- und Hüttenmännische Zeitung*, 1885, p. 249), who found that, using the (low) current-density of 1.8 ampere per sq. ft. of cathode, and an electrolyte containing 1½ lb of copper sulphate and ¼ lb of sulphuric acid per gallon, all the gold, platinum and silver present in the crude copper anode remain as metals, undissolved, in the anode slime or mud, and all the lead remains there as sulphate, formed by the action of the sulphuric acid (or SO<sub>4</sub> ions); he found also that arsenic forms arsenious oxide, which dissolves until the solution is saturated, and then remains in the slime, from which on long standing it gradually dissolves, after conversion by secondary reactions into arsenic oxide; antimony forms a basic sulphate which in part dissolves; bismuth partly dissolves and partly remains, but the dissolved portion tends slowly to separate out as a basic salt which becomes added to the slime; cuprous oxide, sulphide and selenides remain in the slime, and very slowly pass into solution by simple chemical action; tin partly dissolves (but in part separates again as basic salt) and partly remains as basic sulphate and stannic oxide; zinc, iron, nickel and cobalt pass into solution—more readily indeed than does the copper. Of the metals which dissolve, none (except bismuth, which is rarely present in any quantity) deposits at the anode so long as the solution retains its proper proportion of copper and acid, and the current-density is not too great. Neutral solutions are to be avoided because in them silver dissolves from the anode and, being more electro-negative than copper, is deposited at the cathode, while antimony and arsenic are also deposited, imparting a dark colour to the copper. Electrolytic copper should contain at least 99.92% of metallic copper, the balance consisting mainly of oxygen with not more than 0.01% in all of lead, arsenic, antimony, bismuth and silver. Such a degree of purity is, however, unattainable unless the conditions of electrolysis are rigidly adhered to. It should be observed that the free acid is gradually neutralized, partly by chemical action on certain constituents of the slime, partly by local action between different metals of the anode, both of which effect solution independently of the current, and partly by the peroxidation (or aëration) of ferrous sulphate formed from the iron in the anode. At the same time there is a gradual substitution of other metals for copper in the solution, because although copper *plus* other (more electro-positive) metals are constantly dissolving at the anode, only copper is deposited at the cathode. Hence the composition and acidity of the solution, on which so much depends, must be constantly watched.

The dependence of the mechanical qualities of the copper upon the current-density employed is well known. A very weak current gives a pale and brittle deposit, but as the current-density is increased up to a certain point, the properties of the metal improve; beyond this point they deteriorate, the colour becoming darker and the deposit less coherent, until at last it is dark brown and spongy or pulverulent. The presence of even a small proportion of hydrochloric acid imparts a brown tint to the deposit. Baron H. v. Hübl (*Mittheil. des k. k. militär-geograph. Inst.*, 1886, vol. vi. p. 51) has found that with neutral solutions a 5% solution of copper sulphate gave no good result, while with a 20% solution the best deposit was obtained with a current-density of 28 amperes per sq. ft.; with solutions containing 2% of sulphuric acid, the 5% solution gave good deposits with current-densities of 4 to 7.5 amperes, and the 20% solution with 11.5 to 37 amperes, per sq. ft. The maximum current-densities for a *pure* acid solution at rest were: for 15% pure copper sulphate solutions 14 to 21 amperes, and for 20% solutions 18.5 to 28 amperes, per sq. ft.; but when the solutions were kept in gentle motion these maxima could be increased to 21-28 and 28-37 amperes per sq. ft. respectively. The necessity for adjusting the current-density to the composition and treatment of the electrolyte is thus apparent. The advantage of keeping the solution in motion is due partly to the renewal of solution thus effected in the neighbourhood of the electrodes, and partly to the neutralization of the tendency of liquids undergoing electrolysis to separate into layers, due to the different specific gravities of the solutions flowing from the opposing electrodes. Such an irregular distribution of the bath, with strong copper sulphate solution from the anode at the bottom and acid solution from the cathode at the top, not only alters the conductivity in different strata and so causes irregular current-distribution, but may lead to the current-density in the upper layers being too great for the proportion of copper there present. Irregular and defective deposits are therefore obtained. Provision for circulation of solution is made in the systems of copper-refining now in use. Henry Wilde, in 1875, in depositing copper on iron printing-rollers, recognized this principle and rotated the rollers during electrolysis, thereby renewing the surfaces of metal and liquid in mutual contact, and imparting sufficient motion to the solution to prevent stratification; as an alternative he imparted motion to the electrolyte by means of propeller blades. Other workers have followed more or less on the same lines; reference may be made to the patents of F. E. and A. S. Elmore, who sought to improve the character of the deposit by burnishing during electrolysis, of E. Dumoulin, and Sherard Cowper-Coles (*Engineering Review*, 1905, vol. xiii. p. 392), who prefers to rotate the cathode at a speed that maintains a peripheral velocity of at least 1000 ft. per minute. Certain other inventors have applied the same principle in a different way. H. Thofehn in America and J. C. Graham in



England have patented processes by which jets of the electrolyte are caused to impinge with considerable force upon the surface of the cathode, so that the renewal of the liquid at this point takes place very rapidly, and current-densities per sq. ft. of 50 to 100 amperes are recommended by the former, and of 300 amperes by the latter. Graham has described experiments in this direction, using a jet of electrolyte forced (beneath the surface of the bath) through a hole in the anode upon the surface of the cathode. Whilst the jet was playing, a good deposit was formed with so high a current-density as 280 amperes per sq. ft., but if the jet was checked, the deposit (now in a still liquid) was instantaneously ruined. When two or more jets were used side by side the deposit was good opposite the centre of each, but bad at the point where two currents met, because the rate of flow was reduced. By introducing perforated shields of ebonite between the electrodes, so that the full current-density was only attained at the centres of the jets, these ill effects could be prevented. One of the chief troubles met with was the formation of arborescent growths around the edges of the cathode, due to the greater current-density in this region; this, however, was also obviated by the use of screens. By means of a very brisk rotation of cathode, combined with a rapid current of electrolyte, J. W. Swan has succeeded in depositing excellent copper at current-densities exceeding 1000 amperes per sq. ft. The methods by which such results are to be obtained cannot, however, as yet be practised economically on a working scale; one great difficulty in applying them to the refining of metals is that the jets of liquid would be liable to carry with them articles of anode mud, and Swan has shown that the presence of solid particles in the electrolyte is one of the most fruitful causes of the well-known nodular growths on electro-deposited copper. Experiments on a working scale with one of the jet processes in America have, it is reported, been given up after a full trial.

In copper-refining practice, the current-density commonly ranges from 7.5 to 12 or 15, and occasionally to 18, amperes per sq. ft. The electrical pressure required to force a current of this intensity through the solution, and to overcome a certain opposing electromotive force arising from the more electro-negative impurities of the anode, depends upon the composition of the bath and of the anodes, the distance between the electrodes, and the temperature, but under the usual working conditions averages 0.3 volt for every pair of electrodes in series. In nearly all the processes now used, the solution contains about  $1\frac{1}{2}$  to 2 lb of copper sulphate and from 5 to 10 oz. of sulphuric acid per gallon of water, and the space between the electrodes is from  $1\frac{1}{2}$  to 2 in., whilst the total area of cathode surface in each tank may be 200 sq. ft., more or less. The anodes are usually cast copper plates about (say) 3 ft. by 2 ft. by  $\frac{3}{4}$  or 1 in. The cathodes are frequently of electro-deposited copper, deposited to a thickness of about  $\frac{3}{8}$  in. on black-leaded copper plates, from which they are stripped before use. The tanks are commonly constructed of wood lined with lead, or tarred inside, and are placed in terrace fashion each a little higher than the next in series, to facilitate the flow of solution through them all from a cistern at one end to a well at the other. Gangways are left between adjoining rows of tanks, and an overhead travelling-crane facilitates the removal of the electrodes. The arrangement of the tanks depends largely upon the voltage available from the electric generator selected; commonly they are divided into groups, all the baths in each group being in series. In the huge Anaconda plant, for example, in which 150 tons of refined copper can be produced daily by the Thofehrn multiple system (not the jet system alluded to above), there are 600 tanks about  $8\frac{1}{2}$  ft. by  $4\frac{1}{2}$  ft. by  $3\frac{1}{2}$  ft. deep, arranged in three groups of 200 tanks in series. The connexions are made by copper rods, each of which, in length, is twice the width of the tank, with a bayonet-bend in the middle, and serves to support the cathodes in the one and the anodes in the next tank. Self-registering voltmeters indicate at any moment the potential difference in every tank, and therefore give notice of short circuits occurring at any part of the installation. The chief differences between the commercial systems of refining lie in the arrangement of the baths, in the disposition and manner of supporting the electrodes in each, in the method of circulating the solution, and in the current-density employed. The various systems are often classed in two groups, known respectively as the *Multiple* and *Series* systems, depending upon the arrangement of the electrodes in each tank. Under the multiple system anodes and cathodes are placed alternately, all the anodes in one tank being connected to one rod, and all the cathodes to another, and the potential difference between the terminals of each tank is that between a single pair of plates. Under the series system only the first anode and the last cathode are connected to the conductors; between these are suspended, isolated from one another, a number of intermediate bi-polar electrode plates of raw copper, each of these plates acting on one side as a cathode, receiving a deposit of copper, and on the other as an anode, passing into solution; the voltage between the terminals of the tank will be as many times as great as that between a single pair of plates as there are spaces between electrodes in the tank. In time the original impure copper of the plates becomes replaced by refined copper, but if the plates are initially very impure and dissolve irregularly, it may happen that much residual scrap may have to be remelted, or that some of the metal may be twice refined, thus involving a

waste of energy. Moreover, the high potential difference between the terminals of the series tank introduces a greater danger of short-circuiting through scraps of metal at the bottom of the bath; for this reason, also, lead-lined vats are inadmissible, and tarred slate tanks are often used instead. A valuable comparison of the multiple and series systems has been published by E. Keller (see *The Mineral Industry*, New York, 1899, vol. vii. p. 229). G. Kroupa has calculated that the cost of refining is 8s. per ton of copper higher under the series than it is under the multiple system; but against this, it must be remembered that the new works of the Baltimore Copper Smelting and Rolling Company, which are as large as those of the Anaconda Copper Mining Company, are using the Hayden process, which is the chief representative of the several series systems. In this system rolled copper anodes are used; these, being purer than many cast anodes, having flat surfaces, and being held in place by guides, dissolve with great regularity and require a space of only  $\frac{1}{4}$  in. between the electrodes, so that the potential difference between each pair of plates may be reduced to 0.15-0.2 volt.

J. A. W. Borchers, in Germany, and A. E. Schneider and O. Szontagh, in America, have introduced a method of circulating the solution in each vat by forcing air into a vertical pipe communicating between the bottom and top of a tank, with the result that the bubbling of the air upward aspirates solution through the vertical pipe from below, at the same time aerating it, and causing it to overflow into the top of the tank. Obviously this slow circulation has but little effect on the rate at which the copper may be deposited. The electrolyte, when too impure for further use, is commonly recrystallized, or electrolysed with insoluble anodes to recover the copper.

The yield of copper per ampere (in round numbers, 1 oz. of copper per ampere per diem) by Faraday's law is never attained in practice: and although 98% may with care be obtained, from 94 to 96% represents the more usual current-efficiency. With 100% current-efficiency and a potential difference of 0.3 volt between the electrodes, 1 lb of copper should require about 0.154 electrical horse-power hours as the amount of energy to be expended in the tank for its production. In practice the expenditure is somewhat greater than this; in large works the gross horse-power required for the refining itself and for power and lighting in the factory may not exceed 0.19 to 0.2 (or in smaller works 0.25) horse-power hours per pound of copper refined.

Many attempts have been made to use crude sulphide of copper or matte as an anode, and recover the copper at the cathode, the sulphur and other insoluble constituents being left at the anode. The best known of these is the Marchese process, which was tested on a working scale at Genoa and Stolberg in Rhenish Prussia. As the operation proceeded, it was found that the voltage had to be raised until it became prohibitive, while the anodes rapidly became honeycombed through and, crumbling away, filled up the space at the bottom of the vat. The process was abandoned, but in a modified form appears to be now in use in Nijni-Novgorod in Russia. Siemens and Halske introduced a combined process in which the ore, after being part-roasted, is leached by solutions from a previous electrolytic operation, and the resulting copper solution electrolysed. In this process the anode solution had to be kept separate from the cathode solution, and the membrane which had in consequence to be used, was liable to become torn, and so to cause trouble by permitting the two solutions to mix. Modifications of the process have therefore been tried.

Modern methods in copper smelting and refining have effected enormous economy in time, space, and labour, and have consequently increased the world's output. With pyritic smelting a sulphuretted copper ore, fed into a cupola in the morning, can be passed directly to the converter, blown up to metal, and shipped as 99% bars by evening—an operation which formerly, with heap roasting of the ore and repeated roasting of the mattes in stalls, would have occupied not less than four months. A large furnace and a Bessemer converter, the pair capable of making a million pounds of copper a month from a low-grade sulphuretted ore, will not occupy a space of more than 25 ft. by 100 ft.; and whereas, in making metallic copper out of a low-grade sulphuretted ore, one day's labour used to be expended on every ton of ore treated, to-day one day's labour will carry at least four tons of ore through the different mechanical and metallurgical processes necessary to reduce them to metal. About 70% of the world's annual copper output is refined electrolytically, and from the 461,583 tons refined in the United States in 1907, there were recovered 13,995,436 oz. of silver and 272,150 oz. of gold. The recovery of these valuable metals has contributed in no small degree to the expansion of electrolytic refining.

*Production.*—The sources of copper, its applications and its metallurgy, have undergone great changes. Chile was the largest producer in 1869 with 54,867 tons; but in 1899 her

production had fallen off to 25,000 tons. Great Britain, though she had made half the world's copper in 1830, held second place in 1860, making from native ores 15,968 tons; in 1900 her production was 777 tons, and in 1907, 711 tons. The United States made only 572 tons in 1850, and 12,600 tons in 1870; but she today makes more than 60% of the world's total. In 1879, Spain was the largest producer, but now ranks third.

The estimated total production for each decade of the 19th century in metric tons is here shown:—

1801-1810	91,000
1811-1820	96,000
1821-1830	135,000
1831-1840	218,400
1841-1850	291,000
1851-1860	506,999
1861-1870	900,000
1871-1880	1,189,000
1881-1890	2,373,398
1891-1900	3,708,901

The following table gives the output of various countries and the world's production for the years 1895, 1900, 1905, 1907:—

Country.	1895.	1900.	1905.	1907.
United States	175,294	274,933	397,003	398,736
Spain and Portugal	55,755	53,718	45,527	50,470
Japan	18,725	28,285	36,485	49,718
Chile	22,428	26,016	29,632	27,112
Germany	16,799	20,635	22,492	20,818
Australasia	10,160	23,368	34,483	41,910
Mexico	12,806	22,473	70,010	61,127
Russia	5,364	8,128	8,839	15,240
World's production	339,994	496,819	699,514	723,807

As the stock on hand rarely exceeds three months' demand, and is often little more than a month's supply, it is evident that consumption has kept close pace with production.

The large demand for copper to be used in sheathing ships ceased on the introduction of iron in shipbuilding because of the difficulty of coating iron with an impervious layer of copper; but the consumption in the manufacture of electric apparatus and for electric conductors has far more than compensated.

**Alloys of Copper.**—Copper unites with almost all other metals, and a large number of its alloys are of importance in the arts. The principal alloys in which it forms a leading ingredient are brass, bronze, and German or nickel silver; under these several heads their respective applications and qualities will be found.

**Compounds of Copper.**—Copper probably forms six oxides, viz.  $\text{Cu}_4\text{O}$ ,  $\text{Cu}_3\text{O}$ ,  $\text{Cu}_2\text{O}$ ,  $\text{CuO}$ ,  $\text{Cu}_2\text{O}_2$  and  $\text{CuO}_2$ . The most important are cuprous oxide,  $\text{Cu}_2\text{O}$ , and cupric oxide,  $\text{CuO}$ , both of which give rise to well-defined series of salts. The other oxides do not possess this property, as is also the case of the hydrated oxides  $\text{Cu}_3\text{O}_2 \cdot 2\text{H}_2\text{O}$  and  $\text{Cu}_4\text{O}_5 \cdot 5\text{H}_2\text{O}$ , described by M. Siewert.

Cuprous oxide,  $\text{Cu}_2\text{O}$ , occurs in nature as the mineral cuprite (*q.v.*). It may be prepared artificially by heating copper wire to a white heat, and afterwards at a red heat, by the atmospheric oxidation of copper reduced in hydrogen, or by the slow oxidation of the metal under water. It is obtained as a fine red crystalline precipitate by reducing an alkaline copper solution with sugar. When finely divided it is of a fine red colour. It fuses at red heat, and colours glass a ruby-red. The property was known to the ancients and during the middle ages; it was then lost for several centuries, to be rediscovered in about 1827. Cuprous oxide is reduced by hydrogen, carbon monoxide, charcoal, or iron, to the metal; it dissolves in hydrochloric acid forming cuprous chloride, and in other mineral acids to form cupric salts, with the separation of copper. It dissolves in ammonia, forming a colourless solution which rapidly oxidizes and turns blue. A hydrated cuprous oxide,  $(4\text{Cu}_2\text{O} \cdot \text{H}_2\text{O})$ , is obtained as a bright yellow powder, when cuprous chloride is treated with potash or soda. It rapidly absorbs oxygen, assuming a blue colour. Cuprous oxide corresponds to the series of cuprous salts, which are mostly white in colour, insoluble in water, and readily oxidized to cupric salts.

Cupric oxide,  $\text{CuO}$ , occurs in nature as the mineral melaconite (*q.v.*), and can be obtained as a hygroscopic black powder by the gentle ignition of copper nitrate, carbonate or hydroxide; also by heating the hydroxide. It oxidizes carbon compounds to carbon dioxide and water, and therefore finds extensive application in analytical organic chemistry. It is also employed to colour glass, to which it imparts a light green colour. Cupric hydroxide,  $\text{Cu}(\text{OH})_2$ , is obtained as a greenish-blue flocculent precipitate by

mixing cold solutions of potash and a cupric salt. This precipitate always contains more or less potash, which cannot be entirely removed by washing. A purer product is obtained by adding ammonium chloride, filtering, and washing with hot water. Several hydrated oxides, e.g.  $\text{Cu}(\text{OH})_2 \cdot 3\text{CuO}$ ,  $\text{Cu}(\text{OH})_2 \cdot 6\text{H}_2\text{O}$ ,  $6\text{CuO} \cdot \text{H}_2\text{O}$ , have been described. Both the oxide and hydroxide dissolve in ammonia to form a beautiful azure-blue solution (Schweizer's reagent), which dissolves cellulose, or perhaps, holds it in suspension as water does starch; accordingly, the solution rapidly perforates paper or calico. The salts derived from cupric oxide are generally white when anhydrous, but blue or green when hydrated.

Copper quadratoxide,  $\text{Cu}_4\text{O}$ , is an olive-green powder formed by mixing well-cooled solutions of copper sulphate and alkaline stannous chloride. The trioxoide,  $\text{Cu}_3\text{O}$ , is obtained when cupric oxide is heated to  $1500^\circ$ – $2000^\circ$  C. It forms yellowish-red crystals, which scratch glass, and are unaffected by all acids except hydrofluoric; it also dissolves in molten potash. Copper dioxide,  $\text{CuO}_2 \cdot \text{H}_2\text{O}$ , is obtained as a yellowish-brown powder, by treating cupric hydrate with hydrogen peroxide. When moist, it decomposes at about  $6^\circ$  C., but the dry substance must be heated to about  $180^\circ$ , before decomposition sets in (see L. Moser, *Abst. J.C.S.*, 1907, ii. p. 549).

Cuprous hydride,  $(\text{CuH})_2$ , was first obtained by Wurtz in 1844, who treated a solution of copper sulphate with hypophosphorous acid, at a temperature not exceeding  $70^\circ$  C. According to E. J. Bartlett and W. H. Merrill, it decomposes when heated, and gives cupric hydride,  $\text{CuH}_2$ , as a reddish-brown spongy mass, which turns to a chocolate colour on exposure. It is a strong reducing agent.

Cuprous fluoride,  $\text{CuF}$ , is a ruby-red crystalline mass, formed by heating cuprous chloride in an atmosphere of hydrofluoric acid at  $1100^\circ$ – $1200^\circ$  C. It is soluble in boiling hydrochloric acid, but it is not reprecipitated by water, as is the case with cuprous chloride. Cupric fluoride,  $\text{CuF}_2$ , is obtained by dissolving cupric oxide in hydrofluoric acid. The hydrated form,  $(\text{CuF}_2 \cdot 2\text{H}_2\text{O} \cdot 5\text{HF})$ , is obtained as blue crystals, sparingly soluble in cold water; when heated to  $100^\circ$  C. it gives the compound  $\text{CuF}(\text{OH})$ , which, when heated with ammonium fluoride in a current of carbon dioxide, gives anhydrous copper fluoride as a white powder.

Cuprous chloride,  $\text{CuCl}$  or  $\text{Cu}_2\text{Cl}_2$ , was obtained by Robert Boyle by heating copper with mercuric chloride. It is also obtained by burning the metal in chlorine, by heating copper and cupric oxide with hydrochloric acid, or copper and cupric chloride with hydrochloric acid. It dissolves in the excess of acid, and is precipitated as a white crystalline powder on the addition of water. It melts at below red heat to a brown mass, and its vapour density at both red and white heat corresponds to the formula  $\text{Cu}_2\text{Cl}_2$ . It turns dirty violet on exposure to air and light; in moist air it absorbs oxygen and forms an oxychloride. Its solution in hydrochloric acid readily absorbs carbon monoxide and acetylene; hence it finds application in gas analysis. Its solution in ammonia is at first colourless, but rapidly turns blue, owing to oxidation. This solution absorbs acetylene with the precipitation of red cuprous acetylde,  $\text{Cu}_2\text{C}_2$ , a very explosive compound. Cupric chloride,  $\text{CuCl}_2$ , is obtained by burning copper in an excess of chlorine, or by heating the hydrated chloride, obtained by dissolving the metal or cupric oxide in an excess of hydrochloric acid. It is a brown deliquescent powder, which rapidly forms the green hydrated salt  $\text{CuCl}_2 \cdot 2\text{H}_2\text{O}$  on exposure. The oxychloride  $\text{Cu}_2\text{O}_2 \cdot \text{Cl}_2 \cdot 4\text{H}_2\text{O}$  is obtained as a pale blue precipitate when potash is added to an excess of cupric chloride. The oxychloride  $\text{Cu}_4\text{O}_5 \cdot \text{Cl}_2 \cdot 4\text{H}_2\text{O}$  occurs in nature as the mineral atacamite. It may be artificially prepared by heating salt with ammonium copper sulphate to  $100^\circ$ . Other naturally occurring oxychlorides are botallackite and tallingite. "Brunswick green," a light green pigment, is obtained from copper sulphate and bleaching powder.

The bromides closely resemble the chlorides and fluorides. Cuprous iodide,  $\text{Cu}_2\text{I}_2$ , is obtained as a white powder, which suffers little alteration on exposure, by the direct union of its components or by mixing solutions of cuprous chloride in hydrochloric acid and potassium iodide; or, with liberation of iodine, by adding potassium iodide to a cupric salt. It absorbs ammonia, forming the compound  $\text{Cu}_2\text{I}_2 \cdot 4\text{NH}_3$ . Cupric iodide is only known in combination, as in  $\text{CuI}_2 \cdot 4\text{NH}_3 \cdot \text{H}_2\text{O}$ , which is obtained by exposing  $\text{Cu}_2\text{I}_2 \cdot 4\text{NH}_3$  to moist air.

Cuprous sulphide,  $\text{Cu}_2\text{S}$ , occurs in nature as the mineral chalcocite or copper-glance (*q.v.*), and may be obtained as a black brittle mass by the direct combination of its constituents. (See above, *Metallurgy*.) Cupric sulphide,  $\text{CuS}$ , occurs in nature as the mineral covellite. It may be prepared by heating cuprous sulphide with sulphur, or trituration cuprous sulphide with cold strong nitric acid, or as a dark brown precipitate by treating a copper solution with sulphuretted hydrogen. Several polysulphides, e.g.  $\text{Cu}_2\text{S}_8$ ,  $\text{Cu}_2\text{S}_6$ ,  $\text{Cu}_4\text{S}_8$ ,  $\text{Cu}_2\text{S}_4$ , have been described; they are all unstable, decomposing into cupric sulphide and sulphur. Cuprous sulphite,  $\text{CuSO}_2 \cdot \text{H}_2\text{O}$ , is obtained as a brownish-red crystalline powder by treating cuprous hydrate with sulphurous acid. A cuproso-cupric sulphite,  $\text{Cu}_2\text{SO}_3$ ,  $\text{CuSO}_3 \cdot 2\text{H}_2\text{O}$ , is obtained by mixing solutions of cupric sulphate and acid sodium sulphite.

Cupric sulphate or "Blue Vitriol,"  $\text{CuSO}_4$ , is one of the most important salts of copper. It occurs in cupriferous mine waters and as the minerals chalcantite or cyanosite,  $\text{CuSO}_4 \cdot 5\text{H}_2\text{O}$ , and boothite,  $\text{CuSO}_4 \cdot 7\text{H}_2\text{O}$ . Cupric sulphate is obtained commercially by the

oxidation of sulphuretted copper ores (see above, *Metallurgy; wet methods*), or by dissolving cupric oxide in sulphuric acid. It was obtained in 1644 by Van Helmont, who heated copper with sulphur and moistened the residue, and in 1648 by Glauber, who dissolved copper in strong sulphuric acid. (For the mechanism of this reaction see C. H. Sluiter, *Chem. Weekblad*, 1906, 3, p. 63, and C. M. van Deventer, *ibid.*, 1906, 3, p. 515.) It crystallizes with five molecules of water as large blue triclinic prisms. When heated to 100°, it loses four molecules of water and forms the bluish-white monohydrate, which, on further heating to 250°-260°, is converted into the white  $\text{CuSO}_4$ . The anhydrous salt is very hygroscopic, and hence finds application as a desiccating agent. It also absorbs gaseous hydrochloric acid. Copper sulphate is readily soluble in water, but insoluble in alcohol; it dissolves in hydrochloric acid with a considerable fall in temperature, cupric chloride being formed. The copper is readily replaced by iron, a knife-blade placed in an aqueous solution being covered immediately with a bright red deposit of copper. At one time this was regarded as a transmutation of iron into copper. Several basic salts are known, some of which occur as minerals; of these, we may mention brochantite (*q.v.*),  $\text{CuSO}_4 \cdot 3\text{Cu}(\text{OH})_2$ , langite,  $\text{CuSO}_4 \cdot 3\text{Cu}(\text{OH})_2$ ,  $\text{H}_2\text{O}$ , lyellite (or devilline), warringtonite; woodwardite and enysite are hydrated copper-aluminium sulphates, connellite is a basic copper chlorosulphate, and spangolite is a basic copper aluminium chlorosulphate. Copper sulphate finds application in calico printing and in the preparation of the pigment Scheele's green.

A copper nitride,  $\text{Cu}_3\text{N}$ , is obtained by heating precipitated cuprous oxide in ammonia gas (A. Guntz and H. Bassett, *Bull. Soc. Chim.*, 1906, 35, p. 201). A maroon-coloured powder, of composition  $\text{CuNO}_2$ , is formed when pure dry nitrogen dioxide is passed over finely-divided copper at 25°-30°. It decomposes when heated to 90°; with water it gives nitric oxide and cupric nitrate and nitrite. Cupric nitrate,  $\text{Cu}(\text{NO}_3)_2$ , is obtained by dissolving the metal or oxide in nitric acid. It forms dark blue prismatic crystals containing 3, 4, or 6 molecules of water according to the temperature of crystallization. The trihydrate melts at 114.5° and boils at 170°, giving off nitric acid, and leaving the basic salt  $\text{Cu}(\text{NO}_3)_2 \cdot 3\text{Cu}(\text{OH})_2$ . The mineral gerhardtite is the basic nitrate  $\text{Cu}_3(\text{OH})_2\text{NO}_3$ .

Copper combines directly with phosphorus to form several compounds. The phosphide obtained by heating cupric phosphate,  $\text{Cu}_2\text{H}_2\text{P}_2\text{O}_8$ , in hydrogen, when mixed with potassium and cuprous sulphides or levigated coke, constitutes "Abel's fuse," which is used as a primer. A phosphide,  $\text{Cu}_3\text{P}_2$ , is formed by passing phosphor-etted hydrogen over heated cuprous chloride. (For other phosphides see E. Heyn and O. Bauer, *Rep. Chem. Soc.*, 1906, 3, p. 39.) Cupric phosphate,  $\text{Cu}_2(\text{PO}_4)_2$ , may be obtained by precipitating a copper solution with sodium phosphate. Basic copper phosphates are of frequent occurrence in the mineral kingdom. Of these we may notice libethenite,  $\text{Cu}_2(\text{OH})\text{PO}_4$ ; chalcosiderite, a basic copper iron phosphate; torbernite, a copper uranyl phosphate; andrewsite, a hydrated copper iron phosphate; and henwoodite, a hydrated copper aluminium phosphate.

Copper combines directly with arsenic to form several arsenides, some of which occur in the mineral kingdom. Of these we may mention whitneyite,  $\text{Cu}_3\text{As}$ , algodonite,  $\text{Cu}_4\text{As}$ , and domeykite,  $\text{Cu}_4\text{As}$ . Copper arsenate is similar to cupric phosphate, and the resemblance is to be observed in the naturally occurring copper arsenates, which are generally isomorphous with the corresponding phosphates. Olivenite corresponds to libethenite; clinoclase, euchroite, cornwallite and tyrolite are basic arsenates; zeunerite corresponds to torbernite; chalcophyllite (tamarite or "copper-mica") is a basic copper aluminium sulphato-arsenate, and bayldonite is a similar compound containing lead instead of aluminium. Copper arsenite forms the basis of a number of once valuable, but very poisonous, pigments. Scheele's green is a basic copper arsenite; Schweinfurt green, an aceto-arsenite; and Casselmann's green a compound of cupric sulphate with potassium or sodium acetate.

Normal cupric carbonate,  $\text{CuCO}_3$ , has not been definitely obtained, basic hydrated forms being formed when an alkaline carbonate is added to a cupric salt. Copper carbonates are of wide occurrence in the mineral kingdom, and constitute the valuable ores malachite and azurite. Copper rust has the same composition as malachite; it results from the action of carbon dioxide and water on the metal. Copper carbonate is also the basis of the valuable blue to green pigments verditer, Bremen blue and Bremen green. Mountain or mineral green is a naturally occurring carbonate.

By the direct union of copper and silicon, cuprosilicon, consisting mainly of  $\text{Cu}_2\text{Si}$ , is obtained (Lebeau, *C.R.*, 1906; Vigouroux, *ibid.*). Copper silicates occur in the mineral kingdom, many minerals owing their colour to the presence of a cupriferelement. Dioptase (*q.v.*) and chrysocolla (*q.v.*) are the most important forms.

**Detection.**—Compounds of copper impart a bright green coloration to the flame of a Bunsen burner. Ammonia gives a characteristic blue coloration when added to a solution of a copper salt; potassium ferrocyanide gives a brown precipitate, and, if the solution be very dilute, a brown colour is produced. This latter reaction will detect one part of copper in 500,000 of water. For the borax beads and the qualitative separation of copper from other metals, see **CHEMISTRY: Analytical**. For the quantitative estimation, see **ASSAYING: Copper**.

**Medicine.**—In medicine copper sulphate was employed as an emetic, but its employment for this purpose is now very rare, as it is exceedingly depressant, and if it fails to act, may seriously damage the gastric mucous membrane. It is, however, a useful superficial caustic and antiseptic. All copper compounds are poisonous, but not so harmful as the copper arsenical pigments.

**REFERENCES.**—See generally H. J. Steven's *Copper Handbook* (annual), W. H. Weld, *The Copper Mines of the World* (1907), *The Mineral Industry* (annual), and *Mineral Resources of the United States* (annual). For the dry metallurgy, see E. D. Peters, *Principles of Copper Smelting* (New York, 1907); for pyritic smelting, see T. A. Rickard, *Pyrite Smelting* (1905); for wet methods, see Eissler, *Hydrometallurgy of Copper* (London, 1902); and for electrolytic methods, see T. Ulke, *Die elektrolytische Raffination des Kupfers* (Halle, 1904). Reference should also be made to the articles **METALLURGY** and **ELECTRO-METALLURGY**. For the chemistry of copper and its compounds see the references in the article **CHEMISTRY: Inorganic**. Toxicologic and hygienic aspects are treated in Tschirsch's *Das Kupfer vom Standpunkt der gerichtlichen Chemie, Toxikologie und Hygiene* (Stuttgart, 1893).

**COPPERAS** (Fr. *couperose*; Lat. *cupri rosa*, the flower of copper), green vitriol, or ferrous sulphate,  $\text{FeSO}_4 \cdot 7\text{H}_2\text{O}$ , having a bluish-green colour and an astringent, inky and somewhat sweetish taste. It is used in dyeing and tanning, and in the manufacture of ink and of Nordhausen sulphuric acid or fuming oil of vitriol (see **IRON**).

**COPPER-GLANCE**, a mineral consisting of cuprous sulphide,  $\text{Cu}_2\text{S}$ , and crystallizing in the orthorhombic system. It is known also as chalcocite, redruthite and vitreous copper (German, *Kupferglaserz* of G. Agricola, 1546). The crystals have the form of six-sided tables or prisms; the angle between the prism faces (lettered *o* in the figure) being 60° 25'. When twinned on the prism planes *o*, as is frequently the case, the crystals simulate hexagonal symmetry still more closely, as in the minerals aragonite and chrysoberyl. Twinning also takes place according to two other laws, giving rise to interpenetrating crystals with the basal planes (*s*) of the two individuals inclined at angles of 60° or 87° 56' respectively. The mineral also occurs as compact masses of considerable extent. The colour is dark lead-grey with a metallic lustre, but this is never very bright, since the material is readily altered, becoming black and dull on exposure to light. The mineral is soft ( $H = 2\frac{1}{2}$ ) and sectile, and can be readily cut with a knife, like argentite; sp. gr. 5.7. Analyses agree closely with the formula  $\text{Cu}_2\text{S}$ , which corresponds to 79.8% of copper; small quantities of iron and silver are sometimes present.

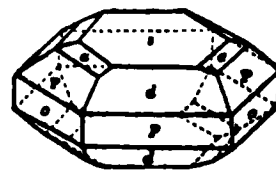

Next to chalcopyrite, copper-glance is the most important ore of copper. It usually occurs in the upper part of the copper-bearing lodes, and is a secondary sulphide derived from the chalcopyrite met with at greater depths; sometimes, however, the two minerals are found together in the same part of the lodes. The best crystals are from St Just, St Ives, and Redruth in Cornwall, and from Bristol in Connecticut. Small crystals of recent formation are found on Roman bronze coins in the thermal springs at Bourbonne-les-Bains.

Copper-glance readily alters to other minerals, such as malachite, covellite, melaconite and chalcopyrite. On the other hand, it is found as pseudomorphs after chalcopyrite, galena, and organic structures such as wood; copper-glance pseudomorphous after galena preserves the cleavage of the original mineral and is known as harrisite.

Isomorphous with copper-glance is the orthorhombic mineral stromeyerite, a double copper and silver sulphide,  $\text{CuAgS}$ , which occurs in abundance in the Altai Mountains. (L. J. S.)

**COPPERHEADS**, an American political epithet, applied by Union men during the Civil War to those men in the North who, deeming it impossible to conquer the Confederacy, were earnestly in favour of peace and therefore opposed to the war policy of the president and of Congress. Such men were not necessarily friends of the Confederate cause. The term originated in the autumn of 1862, and its use quickly spread throughout the North. In the Western states early in 1863 the terms "Copperhead"

and "Democrat" had become practically synonymous. The name was adopted because of the fancied resemblance of the peace party to the venomous copperhead snake, and, though applied as a term of opprobrium, it was willingly assumed by those upon whom it was bestowed.

**COPPERMINE**, a river of Mackenzie district, Canada, about 475 m. long, rising in a small lake in approximately  $110^{\circ} 20' W.$  and  $65^{\circ} 50' N.$ , and flowing south to Lake Gras and then north-westward to Coronation Gulf in the Arctic Ocean. Like Back's river, the only other large river of this part of Canada, it is unnavigable, being a succession of lakes and violent rapids. The country through which it flows is a mass of low hills and morasses. The river was discovered by Samuel Hearne in 1771, and was explored from Point Lake to the sea by Captain (afterwards Sir John) Franklin in 1821.

**COPPER-PYRITES**, or **CHALCOPYRITE**, a copper iron sulphide ( $CuFeS_2$ ), an important ore of copper. The name copper-pyrites is from the Ger. *Kupferkies*, which was used as far back as 1546 by G. Agricola; chalcopyrite (from  $\chi α λ κ ο ς$ , "copper," and pyrites) was proposed by J. F. Henckel in his *Pyritologia, oder Kiess-Historie* (1725). By the ancients copper-pyrites was included with other minerals under the term pyrites, though the copper-ore from Cyprus referred to by Aristotle as chalcites may possibly have been identical with this mineral.

Chalcopyrite crystallizes in the tetragonal system with inclined hemihedrism, but the form is so nearly cubic that it was not recognized as tetragonal until accurate measurements were made in 1822. Crystals are usually tetrahedral in aspect, owing to the large development of the sphenoid P {111}. The faces of this form are dull and striated, whilst the smaller faces of the complementary sphenoid P' {111} (fig. 1) are bright and smooth. The combination of these two forms produces a figure resembling

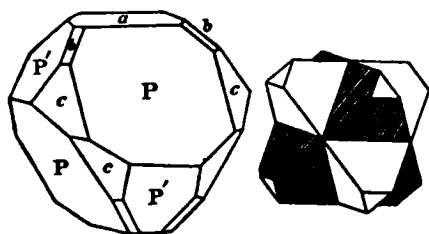

FIG. 1.

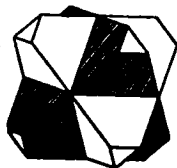

FIG. 2.

an octahedron, the angle between P and P' being  $70^{\circ} 7\frac{1}{2}'$ , corresponding to the angle  $70^{\circ} 32'$  of the regular octahedron. The other faces shown in fig. 1 are the basal pinacoid,  $a$  {001}, and two square pyramids,  $b$  {101} and  $c$  {201}. Crystals are usually twinned, and are often complex and difficult to decipher. There are three twin-laws, the twin-planes being (111), (101) and (110) respectively. Twinning according to the first law is effected by rotation about an axis normal to the sphenoidal face (111), the resulting form resembling the twins of blende and spinel. Twinning according to the second law can only be explained by reflection across the plane (101), not by rotation about an axis; chalcopyrite affords an excellent example of this comparatively rare type of symmetric twinning. Interpenetration twins (fig. 2) with (110) as twin-plane are of very rare occurrence.

Crystals have imperfect cleavages parallel to the eight faces of the pyramid  $c$  {201}. The fracture is conchoidal, and the material is brittle. Hardness 4; specific gravity 4.2. The colour is brass-yellow, and the lustre metallic; the streak, or colour of the powder, is greenish-black. The mineral is especially liable to surface alteration, tarnishing with beautiful iridescent colours; a blue colour usually predominates, owing probably to the alteration of the chalcopyrite to covellite ( $CuS$ ). The massive and compact mineral frequently exhibits this iridescent tarnish, and is consequently known to miners as "peacock ore" or "peacock copper." The massive mineral sometimes occurs in mammillary and botryoidal forms with a smooth brassy surface, and is then known to Cornish miners as "blister-copper-ore."

Chalcopyrite or copper-pyrites may be readily distinguished from iron-pyrites (or pyrites), which it somewhat resembles

in appearance, by its deeper colour and lower degree of hardness: the former is easily scratched by a knife, whilst the latter can only be scratched with difficulty or not at all. Chalcopyrite is decomposed by nitric acid with separation of sulphur and formation of a green solution; ammonia added in excess to this solution changes the green colour to deep blue and precipitates red ferric hydroxide.

The chemical formula  $CuFeS_2$  corresponds with the percentage composition  $Cu=34.5$ ,  $Fe=30.5$ ,  $S=35.0$ . Analyses usually, however, show the presence of more iron, owing to the intimate admixture of iron-pyrites. Traces of gold, silver, selenium or thallium are sometimes present, and the mineral is sometimes worked as an ore of gold or silver.

Chalcopyrite is of wide distribution and is the commonest of the ores of copper. It occurs in metalliferous veins, often in association with iron-pyrites, chalybite, blende, &c., and in Cornwall and Devon, where it is abundant, with cassiterite. The large deposits at Falun in Sweden occur with serpentine in gneiss, and those at Montecatini, near Volterra in the province of Pisa, serpentine and gabbro. At Rammelsberg in the Harz it forms a bed in argillaceous schist, and at Mansfeld in Thuringia it occurs in the Kupferschiefer with ores of nickel and cobalt. Extensive deposits are mined in the United States, particularly at Butte in Montana, and in Namaqualand, South Africa. Well-crystallized specimens are met with at many localities; for example, formerly at Wheal Towan (hence the name towanite, which has been applied to the species) in the St Agnes district of Cornwall, at Freiberg in Saxony, and Joplin, Missouri. (L. J. S.)

**COPPICE**, or **COPSE** (from an O. Fr. *copeis* or *coupeis*, from Late Lat. *colpare*, to cut with a blow; *colpas*, the Late Lat. for "blow," is a shortened form of *colapus* or *colaphus*, adapted from the Gr.  $\kappa \omicron λ α φ ο ς$ ), a small plantation or thicket of planted or self-sown trees, which are cut periodically for use or sale, before the trees grow into large timber. Whether naturally or artificially grown the produce is looked on by the English law as *fructus industrialis*. The tenant for life or years may appropriate this produce (see *Dashwood v. Magniac*, 1891, 3 Ch. 306).

**COPRA** (a Spanish and Portuguese adaptation of the Malay *kopperah*, and Hindustani *khopra*, the coco-nut), the dried broken kernel of the coco-nut from which coco-nut oil is extracted by boiling and pressing. Copra is the form in which the product of the coco-nut is exported for commercial purposes (see **COCONUT PALM**).

**COPROLITES** (from Gr.  $\kappa \omicron π ρ ο ς$ , dung, and  $\lambda \acute{\iota} θ ο ς$ , stone), the fossilized excrements of extinct animals. The discovery of their true nature was made by Dr William Buckland, who observed that certain convoluted bodies occurring in the Lias of Gloucestershire had the form which would have been produced by their passage in the soft state through the intestines of reptiles or fishes. These bodies had long been known as "fossil fir cones" and "bezoar stones." Buckland's conjecture that they were of faecal origin, and similar to the *album grecum* or excrement of hyaenas, was confirmed by Dr W. Prout, who on analysis found they consisted essentially of calcium phosphate and carbonate, and not infrequently contained fragments of unaltered bone. The name "coprolites" was accordingly given to them by Buckland, who subsequently expressed his belief that they might be found useful in agriculture on account of the calcium phosphate they contained. The Liassic coprolites are described by Buckland as resembling oblong pebbles, or kidney-potatoes; they are mostly 2 to 4 in. long, and from 1 to 2 in. in diameter, but those of the larger ichthyosauri are of much greater dimensions. In colour they vary from ash-grey to black, and their fracture is conchoidal. Internally they are found to consist of a lamina twisted upon itself, and externally they generally exhibit a tortuous structure, produced, before the cloaca was reached, by the spiral valve of a compressed small intestine (as in skates, sharks and dog-fishes); the surface shows also vascular impressions and corrugations due to the same cause. Often the bones, teeth and scales of fishes are to

be found dispersed through the coprolites, and sometimes the bones of small ichthyosauri, which were apparently a prey to the larger marine saurians. Coprolites have been found at Lyme Regis, enclosed by the ribs of ichthyosauri, and in the remains of several species of fish; also in the abdominal cavities of a species of fossil fish, *Macropoma Mantelli*, from the chalk of Lewes. Professor T. Jäger has described coprolites from the alum-slate of Gaildorf in Württemberg; the fish-coprolites of Burdiehouse and of Newcastle-under-Lyme are of Carboniferous age. The so-called "beetle-stones" of the coal-formation of Newhaven, near Leith, which have mostly a coprolite nucleus, have been applied to various ornamental purposes by lapidaries. The name "cololites" (from the Greek κώλον, the large intestine, λίθος, stone) was given by Agassiz to fossil wormlike bodies, found in the lithographic slate of Solenhofen, which he determined to be either the petrified intestines or contents of the intestines of fishes. The bone-bed of Axmouth in Devonshire and Westbury and Aust in Gloucestershire, in the Penarth or Rhaetic series of strata, contains the scales, teeth and bones of saurians and fishes, together with abundance of coprolites; but neither there nor at Lyme Regis is there a sufficient quantity of phosphatic material to render the working of it for agricultural purposes remunerative.

The term coprolites has been made to include all kinds of phosphatic nodules employed as manures, such, for example, as those obtained from the Coralline and the Red Crag of Suffolk. At the base of the Red Crag in that county is a bed, 3 to 18 in. thick, containing rolled fossil bones, cetacean and fish teeth, and shells of the Crag period, with nodules or pebbles of phosphatic matter derived from the London Clay, and often investing fossils from that formation. These are distinguishable from the grey Chalk coprolites by their brownish ferruginous colour and smooth appearance. When ground they give a yellowish-red powder. These nodules were at first taken by Professor J. S. Henslow for coprolites; they were afterwards termed by Buckland "pseudo-coprolites." "The nodules, having been imbued with phosphatic matter from their matrix in the London Clay, were dislodged," says Buckland, "by the waters of the seas of the first period, and accumulated by myriads at the bottom of those shallow seas where is now the coast of Suffolk. Here they were long rolled together with the bones of large mammalia, fishes, and with the shells of molluscous creatures that lived in shells. From the bottom of this sea they have been raised to form the dry lands along the shores of Suffolk, whence they are now extracted as articles of commercial value, being ground to powder in the mills of Mr [afterwards Sir John] Lawes, at Deptford, to supply our farms with a valuable substitute for guano, under the accepted name of coprolite manure." The phosphatic nodules occurring throughout the Red Crag of Suffolk are regarded as derived from the Coralline Crag. The Suffolk beds have been worked since 1846; and immense quantities of coprolite have also been obtained from Essex, Norfolk and Cambridgeshire. The Cambridgeshire coprolites are believed to be derived from deposits of Gault age; they are obtained by washing from a stratum about a foot thick, resting on the Gault, at the base of the Chalk Marl, and probably homotaxeous with the Chloritic Marl. An acre used to yield on an average 300 tons of phosphatic nodules, value £750. About £140 per acre was paid for the lease of the land, which after two years was restored to its owners re-soiled and levelled. Plicatulae have been found attached to these coprolites, showing that they were already hard bodies when lying at the bottom of the Chalk ocean. The Cambridgeshire coprolites are either amorphous or finger-shaped; the coprolites from the Greensand are of a black or dark-brown colour; while those from the Gault are greenish-white on the surface, brownish-black internally. Samples of Cambridgeshire and Suffolk coprolite have been found by A. Voelcker to give on analysis phosphoric acid equivalent to about 55 and 52.5% of tribasic calcium phosphate respectively (*Journ. R. Agric. Soc. Eng.*, 1860, xxi. 358). The following analysis of a saurio-coprolite from Lyme Regis is given by T. J. Herapath (*ibid.* xii. 91):—

Water	3.976
Organic matter	2.001
Calcium sulphate	2.026
Calcium carbonate	28.121
Calcium fluoride	not determined
Calcium and magnesium phosphate	53.996
Magnesium carbonate	0.423
Aluminic phosphate	1.276
Ferric phosphate	6.182
Silica	0.733

98.734

An ichthyo-coprolite from Tenby was found to contain 15.4% of phosphoric anhydride. The pseudo-coprolites of the Suffolk Crag have been estimated by Herapath to be as rich in phosphates as the true ichthyo-coprolites and saurio-coprolites of other formations, the proportion of  $P_2O_5$  contained varying between 12.5 and 37.25%, the average proportion, however, being 32 or 33%.

Coprolite is reduced to powder by powerful mills of peculiar construction, furnished with granite and buhrstones, before being treated with concentrated sulphuric acid. The acid renders it available as a manure by converting the calcium phosphate,  $Ca_3P_2O_8$ , that it contains into the soluble monocalcium salt,  $CaH_4P_2O_8$ , or "superphosphate." The phosphate thus produced forms an efficacious turnip manure, and is quite equal in value to that produced from any other source. The Chloritic Marl in the Wealden district furnishes much phosphatic material, which has been extensively worked at Froyle. In the vicinity of Farnham it contains a bed of "coprolites" of considerable extent and 2 to 15 ft. in thickness. Specimens of these from the Dippen Hall pits, analysed by Messrs J. M. Paine and J. T. Way, showed the presence of phosphates equivalent to 55.96 of bone-earth (*Journ. R. Agric. Soc. Eng.* ix. 56). Phosphatic nodules occur also in the Chloritic Marl of the Isle of Wight and Dorsetshire, and at Wroughton, near Swindon. They are found in the Lower Greensand, or Upper Neocomian series, in the Atherfield Clay at Stopham, near Pulborough; occasionally at the junction of the Hythe and Sandgate beds; and in the Folkeston beds, at Farnham. At Woburn, Leighton, Ampthill, Sandy, Upware, Wicken and Potton, near the base of Upper Neocomian iron-sands, there is a band between 6 in. and 2 ft. in thickness containing "coprolites"; these consist of phosphatized wood, bones, casts of shells, and shapeless lumps. The coprolitic stratum of the Speeton Clay, on the coast to the north of Flamborough Head, is included by Professor Judd with the Portland beds of that formation. In 1864 two phosphatic deposits, a limestone 3 ft. thick, with beds of calcium phosphate, and a shale of half that thickness, were discovered by Hope Jones in the neighbourhood of Cwmgyfen, about 16 m. from Oswestry. They are at a depth of about 12 ft., in slaty shale containing Llandeilo fossils and contemporaneous felspathic ash and scoriae. A specimen of the phosphatic limestone analysed by A. Voelcker yielded 34.92% tricalcium phosphate, a specimen of the shale 52.15% (*Report of Brit. Assoc.*, 1865). Phosphatic beds, supposed to have had a coprolitic origin, are found in the Lower Silurian rocks of Canada.

See T. J. Herapath, *Chem. Gaz.*, 1849, p. 449; W. Buckland, *Geology and Mineralogy* (4th ed., 1869); O. Fisher, *Quart. Journ. Geol. Soc.*, 1873, p. 52; J. J. H. Teall, *On the Potton and Wicken Phosphatic Deposits* (Sedgwick Prize Essay for 1873) (1875) and "The Natural History of Phosphatic Deposits," *Proc. Geol. Assoc.* xvi. (1900); L. W. Collet, *Proc. Roy. Soc. Edin.* xxv. pt. 10, p. 862; T. G. Bonney, *Cambridgeshire Geology* (1875); L. Gruner, *Bull. soc. géol. franc.* xxviii. (2nd series), p. 62; J. Martin, *ibid.* iii. (3rd series), p. 273.

**COPTOS** (Egyptian *Keft*, *Kebto*), the modern **ΚΟΥΤ** (a village with railway station a short distance from the west bank of the Nile about 25 m. north-east of Thebes), an ancient city, capital of the fifth nome of Upper Egypt, and the starting-point of several roads to the Red Sea, of which that which passes along the valley running due east to Kosseir past the ancient quarries of Hammāmāt was the most frequented, until the foundation of Berenice (*q.v.*) by Ptolemy Philadelphus made an even more important line of traffic to the south-west. The growth of trade with Arabia



and India thereafter raised Copts to great commercial prosperity; but in A.D. 292 its share in the rebellion against Diocletian led to an almost total devastation. It again appears, however, as a place of importance, and as the seat of a considerable Christian community, though the stream of traffic turned aside to the neighbouring Κῆς. During part of the 7th century it was called Justinianopolis in honour of the emperor Justinian.

The local god of Coptos, as of Khemmis (Akhmīm, *q.v.*), was the ithyphallic Min; but in late times Isis was of equal importance in the city. Min was especially the god of the desert routes. Petrie's excavations on the site of the temple brought to light remains of all periods, the most remarkable objects being three very primitive limestone statues of the god with figures of an elephant, swords of sword-fish, sea-shells, &c., engraved upon them: there were also found some very peculiar terra-cottas of the Old Kingdom, and the decree of an Antef belonging to the latter part of the Middle Kingdom, deposing the monarch for siding with the king's enemy.

**COPTS**, the early native Christians of Egypt and their successors of the Monophysite sect, now racially the purest representatives of the ancient Egyptians. The name is a Europeanized form, dating perhaps from the 14th century, of the Arabic *Ḳibt* (or *Ḳubt*), which, in turn, is derived from the Greek *Αἰγύπτιος*, "Egyptians" (the Copts in the Coptic language likewise style themselves *ⲡⲉⲗⲁⲛⲭⲙⲁⲓ*, "people of Egypt," "Egyptians").

The limited application of the name is explained by the circumstances of the time when Mahomet sent forth his challenge to the world and 'Amr conquered Egypt (A.D. 627-641). At that time the population of Egypt was wholly Christian (except for a sprinkling of Jews, &c.), divided into two fiercely hostile sects, the Monophysites and the Melkites. The division was in great measure racial. The Melkites, adherents of the orthodox or court religion sanctioned by the council of Chalcedon, were mainly of foreign extraction, from the various Hellenistic races which peopled the Eastern Roman empire, while the bulk of the population, the true Egyptians, were Monophysite. Amongst the latter political aspirations, apart from religion, may be said not to have existed. It has generally been held that the Copts invited and aided the Moslems to seize the country in order that at all costs they might be freed from the yoke of the state religion imposed by the Eastern Roman Empire; but Dr A. J. Butler has shown this view to be untenable, while admitting that the religious feuds of the Christians made the task of the Arabs easy. The mysterious *Muḳauḳis*, who treacherously handed over Alexandria, impregnable as it was for Arab warriors, and then capitulated, was none other than Cyrus, the Melkite patriarch and governor of Egypt; the native Monophysite party, however, smarting under the persecution of the Emperor Heraclius, seemed to have most to gain by a change of masters. The prophet Mahomet himself had prescribed indulgence to the Copts before his death, and 'Amr was mercifully disposed to them. Although they offered resistance in some places, after the Roman forces had been destroyed or had abandoned Egypt they generally acquiesced in the inevitable; and when in 646 a Roman fleet and army recaptured Alexandria and harried the Delta, the Copts helped the Moslems to cast out the Christian invaders. Some of the Copts embraced Islam at once, but as yet they formed practically a solid Christian nation under the protection of the conquering Arabs, and the religious and political distinction between the "true believers" and the Christians was so sharp that a native Christian turning Moslem was no longer a Copt, *i.e.* Egyptian; he practically changed his nationality.

The beginnings of Christianity in Egypt are obscure; the existence of it among the natives (as opposed to the mixed "Greek" population of Egypt and Alexandria which produced so many leading figures and originated leading doctrines in the early church) can be traced back as far as the Decian persecution (A.D. 249-251) in the purely Egyptian names of several martyrs. St Anthony (*c.* A.D. 270) was a Copt; so also was Pachomius, the founder of Egyptian monasticism at the beginning of the 4th century. The scriptures were translated into Coptic not later than the 4th century. A religion founded on morality and with

a clear doctrine of life after death was especially congenial to the Egyptians; thus the lower orders in the country embraced Christianity fervently, while the Alexandrian pagans were lost in philosophical speculation and Neoplatonism was spread amongst the rich "Greek" landowners; these last, partly out of religious enthusiasm, partly from greed, annoyed and oppressed their Christian peasantry. Egypt was then terribly impoverished; the upper country was constantly overrun by raiders from Nubia and the desert; and the authority of the imperial government was too weak to interfere actively on behalf of the Christians. The monasteries, however, were refuges that could bid defiance to the most powerful of the pagan aristocracy as well as to barbarian hordes, and became centres of united action that, at the summons of Shenoute, the organizer of the national church, swept away the idols of the oppressors in riot and bloodshed. In the course of the 5th century the Christians reached a position in which they were able to treat the pagans mercifully as a feeble remnant.

The Copts had little interest in theology; they were content to take their doctrine as prepared for them by the subtler minds of their Greek leaders at Alexandria, choosing the simplest form when disputes arose. In 325 their elected patriarch, Athanasius, and his following of Greeks and Copts, triumphed at the council of Nicaea against Arius; but in 451 the banishment of Dioscorus, patriarch of Alexandria, by the council of Chalcedon created a great schism, the Egyptian church holding to his Monophysite tenets (see *Coptic Church*, below), while the Catholic and imperial party at Constantinople ever sought to further the "Melkite" cause in Egypt at the expense of the native church. Thenceforward there were generally two patriarchs, belonging to the rival communities, and the Copts were oppressed by the Melkites; Heraclius, in 638 after the repulse of the Persians, endeavoured to unite the churches, but, failing in that, he persecuted the Monophysites more severely than ever before, until 'Amr brought Egypt under the Moslem rule of 'Omar, as has been related above. Under the persecution many Copts had gone over to the Melkites, but now it was the turn of the Melkites, as supporters of the emperor of Constantinople, to suffer, and they almost entirely disappeared from Egypt, though a remnant headed by a patriarch of Alexandria of the Orthodox Christians has survived to this day.

But after a few years of the mild rule of 'Amr the Egyptians began to be squeezed for the benefit of the Moslem exchequer and persecuted for their religion. Many of the more thoughtful and sober Christians must long have been disgusted with religious strife, and had already embraced the simple and congenial doctrines of Islam; others went over for the sake of material gain. Conflicts arose from time to time between the Mahommedan minority and the Christians. The Copts were excellent scribes and accountants and were continued in their posts under the Arab rule; the government offices were full of them; sometimes even the wazirate (*vizierate*) was held by a Copt, and that too in a time of persecution of the Christians. The pride of the Copts, still seen in the objection which the poorest among them have to engaging in any mean work or trade, was a serious danger, perhaps even a chief source of their troubles, in earlier days; devout Moslems on more than one occasion stirred the mob to fury when they saw Christians lording it over "true believers." The lower orders of the Copts were continually oppressed. Thus there was every inducement amongst the Christians to turn Mahommedan. Arab tribes, too, were encouraged to settle in Egypt until the Mahommedans exceeded the Copts in numbers.

The history of the Copts consists on the one hand of the record of religious strife, of growing scandals in the church, such as simony, and attempted reforms; and on the other hand of persecutions at the hands of the Moslems. As examples of the severity of the persecutions, it may be noted that, in the 8th century, the monks not only were compelled to pay a capitation tax, but were branded with name and number, civilians were oppressed with heavy taxation, churches demolished, pictures and crosses destroyed (722-723). Degrading dresses were imposed upon the Christians (849-850); later, under Hakiri (997), they



were compelled to wear heavy crosses and black turbans as an ignominious distinction. Salaheddin (Saladin) in 1171 re-enforced these statutes and defiled the churches. In 1301, the blue turban was introduced, but many Copts preferred a change of religion to the adoption of this head-dress. In 1348 a religious war, attended by the destruction of churches and mosques and great loss of life, raged at Cairo between the Copts and Mahomedans, and large numbers of the former embraced Islam. Their oppression practically ceased under Mehemet Ali (1811).

There have been very few cases of conversion from Mahomedanism to Christianity; and, as intermarriage of Christians with Mahomedans implied conversion to Islam, the Copts have undoubtedly preserved the race of the Egyptians as it existed at the time of the Arab conquest in remarkable purity. The Coptic agricultural population (fellahin) in the villages of Upper Egypt and elsewhere are not markedly different from the Mahomedan fellahin, who, of course, are of the same stock, but mixed with Arab blood. The Copts in the towns, who have always been engaged in sedentary occupations, as scribes and handicraftsmen, have a more delicate frame and complexion, and may have mingled with Syrian and Armenian Christians.

According to the 1907 census, there were 667,036 orthodox Copts in Egypt, or less than  $\frac{1}{4}$ th of the total population, this being the same proportion as in 1830, when, according to Lane, they numbered about 150,000. The number of churches and monasteries at the same time had risen from 146 to 450, not including Protestant chapels nor Coptic Catholic churches. At the 1907 census the total number of Christians in Egypt described as Copts was 706,322; among them there were 24,710 Protestants and 14,576 Roman Catholics.

Monogamy is strict among the Copts, and divorce is granted only for adultery. Circumcision of both sexes is common before baptism. In regard to dress, at present only the clergy retain the old distinctive costume and black turban. The rest of the Copts dress exactly like their Moslem brethren, from whom they can be distinguished only by the cross which many of them still have tattooed just below the palm of the right hand. Since the British occupation of the country there has been a tendency amongst the Coptic women to give up the veil, which they had borrowed from the Mahomedans; this is especially noticeable at places like Assiut, where, thanks to the efforts of American missionaries, female education has made much progress.

In trades and professions, so long as the Copts had no foreign competition to contend against, they maintained their supremacy over the rest of the population. They filled government offices; in towns and villages they monopolized trades and professions requiring care and skill. They were the accountants, the architects, the goldsmiths, the carpenters, the land-surveyors, the bonesetters, &c. But, with the extension of railways and agricultural roads and the increased facilities of communication and prosperity, there has been a great influx of Italian, Greek, Armenian and other Levantine workmen, who, with their better tools, are undoubtedly superior to the Copts, and have proved most formidable rivals. Furthermore, the importation of cheap European wares of every description is slowly killing all native industry. Lastly, since the British, as the dominant race, have filled most posts of responsibility in the government, the Moslems, in general, are obliged to content themselves with the subordinate posts which in the past they left to the Copts. Some Copts have attained high office, and in 1908 a Copt became prime minister. Moreover, the Copts have to a certain extent made up for the ground they lose elsewhere by engaging in agriculture and banking, and there are now to be found many rich Coptic landowners and farmers, especially in Upper Egypt.

*Language.*—The language spoken by the Copts was of various dialects, named Sahidic, Akhmimic, Fayumic, &c., descended from the ancient Egyptian with more or less admixture of Greek (for the Coptic dialects see EGYPT: *Language*). Coptic, however, has been entirely extinct as a spoken language for over 200 years, having been supplanted by Arabic; in the 13th century it was already so much decayed that Arabic translations of the liturgies were necessary. The Gospels, however, are still read in the

churches in the Bohairic dialect. This dialect appears in literature later than the others, having become of importance only with the extinction of Greek in Lower Egypt; for a time it shared the field with Sahidic, after the disappearance of Akhmimic and Fayumic, but eventually displaced it in the churches, where it now survives alone.

Coptic literature is almost entirely religious, and consists mainly of translations from the Greek. Such was the enthusiasm for Christianity amongst the lower classes in Egypt that translations of the Bible were made into three of the dialects of Coptic before the council of Chalcedon; they probably date back at least as early as the middle of the 4th century. For the dwellers in the Delta the Greek version was probably sufficient, until the break with the Greek (Melkite) Church in the 5th century induced them to make a separate translation in their own native northern or Bohairic dialect. The Gnostic heresy, otherwise known only through the works of its opponents, is illustrated in some Coptic MSS. of the 4th century, the so-called *Pistis Sophia* or Askew Codex, and the Bruce Codex, respectively in the British Museum and Bodleian Libraries. According to Schmidt and Harnack, they are translations dating from the 3rd century and belong to an ascetic or encratic sect of the Gnostics which arose in Egypt itself. There is abundance of apocryphal works, of apocalypses, of patristic writings from Athanasius to the council of Chalcedon, homilies, lives of saints and anecdotes of holy men, acts of martyrs extending from the persecution of Diocletian to that of the Persians in the 7th century, and lives of later ascetics and martyrs reaching down to the 14th century. Unless some of the Egyptian *acta sanctorum et martyrum* should prove to have been originally written in Coptic, almost the only original works in that language of any importance are the numerous sermons and letters of Shenoute, a monk of Atrépe near Akhmim, written in the Sahidic dialect in the 4th century. After the Arab conquest, as a defence to the threatened church, language and nationality, versifications of the Proverbs, of Solomon's Song and of various legends were composed, with other religious songs. They are mostly antiphonal, a number of stresses in a line marking the rhythm. There is no musical notation in the MSS., but traditional church tunes are generally referred to or prescribed for the songs. Of secular literature strangely little existed or at least has survived: only a few magical texts, fragments of a medical treatise, of the story of Alexander, and of a story of the conquest of Egypt by Cambyses, are known, apart from numerous legal and business documents.

Coptic was occasionally employed for literary purposes as late as the 14th century, but from the 10th century onward the Copts wrote mostly in Arabic. Severus of Eshmunain (c. 950), who wrote a history of the patriarchs of Alexandria, was one of the first to employ Arabic; Cyril ibn Laklak and others in the 13th and 14th centuries translated much of the older literature from Coptic into Arabic and Ethiopic for the use of the Egyptian and Abyssinian churches. From this period also date the native Coptic grammars and lexicons of Ibn 'Assal and others. At the present time literature among the Copts is represented by Claudius Labib, an enthusiast for the revival of the Coptic tongue, Marcus Simaika, a leader of the progressive movement, and others. (F. LL. G.)

*The Coptic Church.*—Up to the 5th century the church of Alexandria played a part in the Christian world scarcely second to that of Rome: the names of Origen, Athanasius and Cyril bear witness to her greatness. But in the time of the patriarch Dioscorus the church, always fond of speculation, was rent asunder by the controversy concerning the single or twofold nature of our Lord, as stated by Eutyches. The Eutychiean doctrine, approved by the council of Ephesus, was condemned by that of Chalcedon in 451. But to this decision, though given by 636 bishops, the Copts refused assent—a refusal which profoundly affected both the religious and the political history of their country. From that moment they were treated as heretics. The emperor appointed a new bishop of Alexandria, whose adherents the Copts styled Melkites or Imperialists, while the

Copts are distinguished as Monophysites and Jacobites. The court party and the native party each maintained its own line of patriarchs, and each treated the other with bitter hostility. For nearly two centuries strife and persecution continued. The well-meant ecthesis of Heraclius was a failure and was followed by repression, till in 640 the Copts were released from the Roman dominion by the Saracen invasion. But it was only after prolonged resistance to the Arabs that the Copts accepted a change of masters, which gave them for a while religious freedom. The orthodox or Melkite party, consisting mostly of Byzantine Greeks, was swept away, and the double succession of patriarchs practically ceased. True, even now there is an orthodox patriarch of Alexandria living in Cairo, but he has only a few Greeks for followers, and scarcely a nominal succession has been maintained. But the Coptic succession has been continuous and real.

The distinctive Monophysite doctrine of the Copts is not easy to state intelligibly, and yet they cling to it with something of the tenacity which has marked their whole history. **Doctrine.** They repudiate the heresy of Eutyches as strongly as that of Nestorius, and claim to stand between the two doctrines teaching that Christ was one person with one nature which was made up by the indissoluble union of a divine and a human nature, but that notwithstanding this absolute union the two natures remained after union distinct, unconfounded and uncommingled, separate though inseparable. The creed thus savours of paradox, not to say contradiction. It is set forth in the Liturgy and recited at every Coptic mass in the following words:—"I believe that this is the life-giving flesh which thine only Son took from the . . . Holy Mary. He united it with His Divinity without mingling and without confusion and without alteration. . . . I believe that His Divinity was not separated from His Manhood for one moment or for the twinkling of an eye." On all other points of dogma, including the single procession of the Holy Ghost, the Copts agree with the Greek Church.

"The most holy pope and patriarch of the great city of Alexandria and of all the land of Egypt, of Jerusalem the holy **Hierarchy.** city, of Nubia, Abyssinia and Pentapolis, and all the preaching of St Mark," as he is still called, had originally jurisdiction over all the places named. Jurisdiction over Abyssinia remains, but from Nubia and Pentapolis Christianity has disappeared. The ancient rule is that no bishop is eligible for the patriarchate. The requirement of a period of desert life has so far prevailed that no one but a monk from one of the desert monasteries is now qualified. This rule, harmless perhaps when the monasteries were the great schools of learning and devotion, now puts a premium on ignorance, and is disastrous to the church; more particularly as even bishops must be chosen from the monks. The patriarch is elected by an assembly of bishops and elders. The candidate is brought in chains from the desert, and, if only in monk's orders, is passed through the higher grades except that of bishop. The patriarch's seat was transferred some time after the Arab conquest from Alexandria to the fortress town of Babylon (Old Cairo), and in modern times it was shifted to Cairo proper. The other orders and offices in the church are metropolitan, bishop, chief priest, priest, archdeacon, deacon, reader and monk. The number of bishoprics in ancient times was very large—Athanasius says nearly 100. At present there remain ten in Egypt, one at Khartoum and three in Abyssinia.

The numerous remaining churches in Egypt but faintly represent the vast number standing in ancient times. Rufinus says that he found 10,000 monks in the one region **Buildings.** of Arsinoe. Later, in 616, the Persians are described as destroying 600 monasteries near Alexandria. Abū Sālih (12th century) gives a list of churches surviving in his day, and their number is astonishing. The earliest were cut out of rocks and caverns. In the days of Constantine and Justinian basilicas of great splendour were built, such as the church of St Mark at Alexandria and the Red Monastery in Upper Egypt. This type of architecture permanently influenced Coptic builders,

but there prevailed also a type, probably native in origin, though possessing Byzantine features, such as the domed roofing. There is no church now standing which bears any trace of the fine glass mosaics which once adorned the basilicas, nor is there any example of a well-defined cruciform ground-plan. But the use of the dome by Coptic architects is almost universal, and nearly every church has at least three domes overshadowing the three altars. The domes are sometimes lighted by small windows; but the walls are windowless, and the churches consequently gloomy. Among the most interesting churches are those of Old Cairo, those in the Wadi Natron, and the Red and White Monasteries (*Der el-Abiad* and *Der el-Akmar*) near Suhag in Upper Egypt.

Every church has three altars at the eastern end in three contiguous chapels. The central division is called the *haikal* or sanctuary, which is always divided from the choir by a fixed partition or screen with a small arched doorway closed by double doors. This resembles **Church fittings.** the Greek iconostasis, the screen on which the "icons" or sacred pictures are placed. *Haikal* screen and choir screen are often sumptuously carved and inlaid. A marble basin for the mandatum in the nave, and an epiphany tank at the west are common features. The altar is usually built of brick or stone, hollow within, and having an opening to the interior. A wooden altar-slab covered with crosses, &c., lies in a rectangular depression on the surface, and it is used in case of need as a portable altar. Chalice and paten, ewer and basin, cresset and chrysmatory, are found as in the Western churches. The aster consists of two crossed half-hoops of silver and is used to place over the wafer. The flabellum is used, though now rarely made of precious metal. Some examples of silver-cased textus now remaining are very fine. Every church possesses thuribles—the use of incense being universal and frequent—and diadems for the marriage service. The use of church bells is forbidden by the Moslems, except in the desert, and church music consists merely of cymbals and triangles which accompany the chanting.

The sacramental wine is usually made from raisins, but the juice must be fermented. Churches even in Cairo have a press for crushing the raisins. The eucharistic bread is baked in an oven built near the sanctuary. The wafer is **Rites and ceremonies.** a small loaf about 3 inches in diameter and 1 inch thick, stamped with the trisagion and with crosses. Communion must be received fasting. Confession is required, but has somewhat fallen into disuse. Laymen receive in both kinds. The wafer being broken into the chalice, crumbs or "pearls" are taken out in a spoon and so administered, as in the Greek rite. Reservation is uncanonical. Renaudot states that it was permitted in cases of great extremity, when the host remained upon the altar with lamps burning and a priest watching, but it is not now practised, and there is no evidence of any such vessel as a pyx in Coptic ritual. Small benedictional crosses belong to each altar, and processional crosses are common. The crucifix is unknown, for while paintings and frescoes abound, graven images are absolutely forbidden. The liturgy was read exclusively in the extinct Coptic language till the end of the 19th century, but parts are now read in Arabic, while the lessons have long been read in Arabic as well as in Coptic. The services are still excessively long, that of Good Friday lasting eleven hours; but benches are now provided in the newer churches. Seven sacraments are recognized—baptism, confirmation, eucharist, penance, orders, matrimony, and unction of the sick. The chief fasts are those of Advent, of Nineveh, of Heraclius, Lent and Pentecost. Pilgrimage to Jerusalem is a duty and sometimes a penance.

The Coptic ritual deserves much fuller study than it has received. Since the 7th century the church has been so isolated as to be little influenced by changes affecting other communions. Consequently it remains in many respects the most ancient monument of primitive rites and ceremonies in Christendom. But centuries of subjection to Moslem rule have much weakened it. For the liturgical dress see VESTMENTS; CHASUBLE, &c.

The British occupation of Egypt profoundly modified Coptic

religious life. Before it the Copts lived in their own semi-fortified quarters in Cairo or Old Cairo or in country or desert Dairs (Ders). Walls and gates were now thrown down or disused: the Copts began to mix and live freely among the Moslems, their children to frequent the same schools, and the people to abandon their distinctively Christian dress, names, customs and even religion. Freedom and prosperity threatened to injure the Church more than centuries of persecution. Many of the younger generation of Copts began openly to boast their indifference and even scepticism: in the large towns churches came to be too often frequented only by the old or the uneducated, confession and fasts fell into neglect and the number of communicants diminished; while the facility of divorce granted by Islam occasioned many perversions from among the Copts to that religion. On the other hand the necessity of resistance to these tendencies and of reform from within was strongly realized. Unfortunately, the institution of a lay council of eminent churchmen, which has been formed for the patriarch and for every bishop in his own diocese, has led to prolonged struggles and on one occasion to a serious crisis, in which the patriarch and the metropolitan of Alexandria were for a while banished to the desert. A principal object of these lay councils is to control the financial and legal powers vested in patriarch and bishops—powers which have often been greatly abused. Other objects are (1) to provide Christian religious education in all Coptic schools and to raise these schools to a high standard in secular matters; (2) to promote the education of women; (3) to apply church revenues to the maintenance of churches and schools and to the better payment of the clergy, who are now often compelled to live on charity; (4) to ensure prompt administration of justice in ecclesiastical causes such as divorce, inheritance, &c.; and (5) to establish colleges for the efficient training of the clergy. Educated Copts remember the time when the church of Alexandria was as famous for learning as for zeal. They desire also to resist the serious encroachments of Roman Catholic, American Presbyterian, and other foreign missions upon their ancient faith.

(A. J. B.)

**AUTHORITIES.**—(1) *History and Religion*: Johann Michael Wansleben (Vansleb), a Dominican and learned orientalist (1635–1679), *Hist. de l'église d'Alexandrie* (Paris, 1677), written at Cairo in 1672 and 1673 mainly from original native sources, and *Nouvelle Relation . . . d'un voyage fait en Égypte, &c.* (Paris, 1677 and 1698, Eng. trans., London, 1678); Eusebe Renaudot the younger (1646–1720), *Historia Patriarcharum Alexandrinorum* (Paris, 1713); Abū Dakn (Josephus Abudacnus), *Historia Jacobitarum* (Oxford, 1675, Eng. trans. by Sir E. Sadleir, London, 1693); S. C. Malan, *Original Documents of the Coptic Church* (London, 1874); Denzinger, *Ritus Orientalium* (Würzburg, 1863); Hon. Robert Curzon, *Visits to Monasteries in the Levant* (London, 1849); J. M. Neale, *Hist. of the Patriarchate of Alexandria* (2 vols., *ib.*, 1847), in the *Hist. of the Holy Eastern Church*, coloured by the writer's Anglo-Catholic point of view; A. J. Butler, *Ancient Coptic Churches of Egypt* (Oxford, 1884); B. T. A. Evetts and Butler, *Churches and Monasteries of Egypt*, by Abū Sāleh (Oxford, 1895); E. Amélineau, *Monuments pour servir à l'histoire de l'Égypte chrétienne aux IV<sup>e</sup> et V<sup>e</sup> siècles*, Coptic and Arabic documents published and translated for the first time, in *Mém. de la mission archéolog. franç. au Caire*, t. iv. (Paris, 1888), and *Monuments . . . au IV<sup>e</sup> siècle* in the *Annales du musée Guimet*, t. xvii. (Paris, 1889); P. Rohrbach, *Die alexandrinischen Patriarchen* (Berlin, 1891); Jullien, *L'Égypte: souvenirs bibliques et chrétiens* (Lille, 1891); Macaire, *Histoire de l'église d'Alexandrie* (Cairo, 1894); Porphyrius, *The Christian East: Alexandrian Patriarchate* (St Petersburg, 1898; in Russian); Strzygowski, *Orient oder Rom?* (Leipzig, 1901); De Bock, *Matériaux pour servir à l'archéologie de l'Égypte chrétienne* (St Petersburg, 1901); *Kitāb al Hulājī al Muḳāddas* (Cairo, 1902); A. Gayet, "Les Monuments coptes du musée de Boulaq," in the *Mém. miss. archéolog. franç. au Caire*, t. iii. (Paris, 1889); *id.*, *L'Art copte* (Paris, 1902); Horner, *The Statutes of the Apostles* (London, 1904); *Egypt Exploration Fund Reports*, section "Christian Egypt"; W. E. Crum, article "Koptische Kirche" in *Realencyklopädie für protestantische Theologie und Kirche*, 3. Aufl.; J. M. Fuller's article "Coptic Church" in *Smith's Dictionary of Biography*; A. J. Butler, *The Arab Conquest of Egypt* (Oxford, 1902); J. Leipoldt, *Schenute von Atripe und die Entstehung des national-ägyptischen Christentums* (Leipzig, 1903), *Die Entstehung der koptischen Kirche* (a valuable essay printed as the introduction to R. Haupt's *Katalog* 5, Halle, 1905); B. T. A. Evetts, "The Patriarchal History of Severus" in Graffin's *Patrologia orientalis* (Paris); J. Milne, *A History of Egypt under Roman Rule* (1898).

**Literature.**—See Crum's article above referred to, his *Catalogue of Coptic MSS. in the British Museum*, and his annual reviews in the *Archaeological Report of the Egypt Exploration Fund*; J. Leipoldt in *Geschichte der christlichen Literaturen des Orients* (Leipzig, 1907); H. Junker, *Koptische Poesie des zehnten Jahrhunderts*, 1. Teil (Berlin, 1908); Archdeacon Dowling, *The Egyptian Church* (London, 1909).

**Modern People.**—E. W. Lane's description of the Copts in his *Modern Egyptians* is interesting, but founded on imperfect information, and, moreover, coloured by prejudices in favour of the Moslems whom he studied with so much sympathy. See Klunzinger, *Upper Egypt*, pp. 61 et seqq.; also the last chapter of *The Story of the Church of Egypt*, by Mrs E. L. Butcher (1897), on the social life and customs.

**COPYHOLD**, in English law, an ancient form of land tenure, legally defined as a "holding at the will of the lord according to the custom of the manor." Though nowadays of diminishing practical importance, its incidents are historically interesting. Its origin is to be found in the occupation by villani, or non-free men, of portions of land belonging to the manor of a feudal lord. In the time of the Domesday survey the manor was in part granted to free tenants, in part reserved by the lord himself for his own uses. The estate of the free tenants is the freehold estate of English law; as tenants of the same manor they assembled together in manorial court or court baron, of which they were the judges. The portion of the manor reserved for the lord (the *demesne*, or domain) was cultivated by labourers who were bound to the land (*adscripti glebae*). They could not leave the manor, and their service was obligatory. These villani, however, were allowed by the lord to cultivate portions of land for their own use. It was a mere occupation at the pleasure of the lord, but in course of time it grew into an occupation by right, recognized first of all by custom and afterwards by law. This kind of tenure is called by the lawyers *villenagium*, and it probably marks a great advance in the general recognition of the right when the name is applied to lands held on the same conditions not by villeins but by free men. The tenants in villenage were not, like the freeholders, members of the court baron, but they appear to have attended in a humbler capacity, and to have solicited the succession to the land occupied by a deceased father, or the admission of a new tenant who had purchased the goodwill, as it might be called, of the holding, paying for such favours certain customary fines or dues. In relation to the tenants in villenage, the court baron was called the customary court. The records of the court constituted the title of the villein tenant, held by copy of the court roll (whence the term "copyhold"); and the customs of the manor therein recorded formed the real property law applicable to his case.

Copyhold had long been established in practice before it was formally recognized by the law. At first it was in fact, as it is now in the fictitious theory of the law, a tenancy at will, for which none of the legal remedies of a freeholder were available. In the reign of Edward IV., however, it was held that a tenant in villenage had an action of trespass against the lord. In this way a species of tenant-right, depending on and strongly supported by popular opinion, was changed into a legal right. But it retained many incidents characteristic of its historical origin. The life of copyhold assurance, it is said, is custom. Copyhold is necessarily parcel of a manor, and the freehold is said to be in the lord of the manor. The court roll of the manor is the evidence of title and the record of the special laws as to fines, quit rents, heriots, &c., prevailing in the manor. When copyhold land is conveyed from one person to another, it is surrendered by the owner to the lord, who by his payment of the customary fine makes a new grant of it to the purchaser. The lord must admit the vendor's nominee, but the form of the conveyance is still that of surrender and re-grant. The lord, as legal owner of the fee-simple of the lands, has a right to all the mines and minerals and to all the growing timber, although the tenant may have planted it himself. Hence it appears that the existence of copyhold tenures may sometimes be traced by the total absence of timber from such lands, while on freehold lands it grows in abundance. Hence also the popular saying that the "oak grows not except on free land." The copyholder must not commit waste either by cutting

down timber, &c., or by neglecting to repair buildings. In such respects the law treats him as a mere lessee,—the real owner being supposed to be the lord. On the other hand, the lord may not enter the land to cut his own timber or open his mines. The limitations of estates usual in respect of other lands, as found in copyhold, become subject of course to the operations of its peculiar conditions as to the relation of lord and tenant. An estate for life, or *pour autre vie* (i.e. for another's life), an estate entail, or in fee-simple, may be carved out of copyhold.

A species of tenure resembling copyhold is what is known as *customary freehold*. The land is held by copy of court-roll, but not by will of the lord. The question has been raised whether the freehold of such lands is in the lord of the manor or in the tenant, and the courts of law have decided in favour of the former. In some instances copyhold for lives alone is recognized, and in such cases the lord of the manor may ultimately, when all the lives have dropped, get back the land into his own hands.

The feudal obligations attaching to copyhold tenure have been found to cause much inconvenience to the tenants, while they are of no great value to the lord. One of the most vexatious of these is the *heriot*, under which name the lord is entitled to seize the tenant's best beast or other chattel in the event of the tenant's death. The custom dates from the time when all the copyholder's property, including the copyholder himself, belonged to the lord, and is supposed to have been fixed by way of analogy to the custom which gave a military tenant's habiliments to his lord in order to equip his successor. Instances have occurred of articles of great value being seized as heriots for the copyhold tenements of their owners. A race horse worth £2000 or £3000 was thus seized. The fine payable on the admission of a new tenant, whether by alienation or succession, is to a certain extent arbitrary, but the courts long ago laid down the rule that it must be reasonable, and anything beyond two years' improved value of the lands they disallowed.

The inconvenience caused by these feudal incidents of the tenure led to a series of statutes, having for their object the conversion of copyhold into freehold. The first Copyhold Act, that of 1841, was consolidated by the Copyhold Act 1894. Owing to the incidents attaching to land "holden by copy of court roll according to the custom of the manor" in the shape of fines and heriots, the inability to grant a lease for a term exceeding a year, and to the peculiar rules as to descent, waste, dower, curtesy, alienation, and other matters, varying often from manor to manor and widely differing from the uniform law applicable to land in general, enfranchisement, or the conversion of land held by copyhold tenure into freehold, is often desired. This could and may still be effected at common law, but only by agreement on the part of both the lord and the tenant. Moreover, it was subject to other disadvantages. The cost fell on the tenant, and the land when enfranchised was subject to the encumbrances attaching to the manor, and so an investigation into the lord's title was necessary. In 1841 an act was passed to provide a statutory method of enfranchisement, removing some of the barriers existing at common law; but the machinery created was only available where both lord and tenant were in agreement. The Copyhold Act 1852 went further, and for the first time introduced the principle of compulsory enfranchisement on the part of either party. By the Copyhold Act 1894, which now governs statutory enfranchisement, the former Copyhold Acts 1841-1887, were repealed, and the law was consolidated and improved. Enfranchisement is now effected under this act, though in certain cases it is also to be obtained under special acts, such as the Land Clauses Consolidation Act 1848; and the old common law method with all its disadvantages is still open. The Copyhold Act 1894 deals both with compulsory and with voluntary enfranchisement. In either case the sanction of the Board of Agriculture must be obtained; and powers are bestowed on it to decide questions arising on enfranchisement, with an appeal to the High Court. The actual enfranchisement, where it is compelled by one of the parties, is effected by an award made by the board; in the case of a voluntary enfranchisement it is completed by deed. Under the act it is open to both lord

and tenant to compel enfranchisement, though the expenses are to be borne by the party requiring it. The compensation to the lord, in the absence of an agreement, is ascertained under the direction of the board on a valuation made by a valuer or valuers appointed by the lord and tenant; and may be paid either in a gross sum or by way of an annual rent charge issuing out of the land enfranchised, and equivalent to interest at the rate of 4% on the amount fixed upon as compensation. This rent charge is redeemable on six months' notice at twenty-five times its annual amount. The tenant, even if he is the compelling party, may elect either method; but the lord has not the same option, and where the enfranchisement is at his instance, unless there is either an agreement to the contrary or a notice on the part of the tenant to exercise his option, the compensation is a rent charge. Power is conferred on the lord to purchase the tenant's interest where a change in the condition of the land by enfranchisement would prejudice his mansion house, park or gardens; while on the other hand, in the interest of the public or the other tenants, the board is authorized to continue conditions of user for their benefit.

So far the provisions relating to compulsory enfranchisement have been dealt with; but even in the case of a voluntary agreement the lord and tenant are only entitled to accept enfranchisement with the consent of the Board of Agriculture. The consideration in addition to a gross sum or a rent charge may consist of a conveyance of land, or of a right to mines or minerals, or of a right to waste in lands belonging to the manor, or partly in one way and partly in another. The effect of enfranchisement, whether it be voluntary or compulsory, is that the land becomes of freehold tenure subject to the same laws relating to descent, dower and curtesy as are applicable to freeholds, and so freed from Borough English, Gavelkind (save in Kent), and other customary modes of descent, and from any custom relating to dower or free-bench or tenancy by curtesy. Nevertheless, the lord is entitled to escheat in the event of failure of heirs, just as if the land had not been enfranchised. The land is held under the same title as that under which it was held at the date at which the enfranchisement takes effect; but it is not subject to any estate right, charge, or interest affecting the manor. Every mortgage of copyhold estate in the land enfranchised becomes a mortgage of the freehold, though subject to the priority of the rent charge paid in compensation under the act. All rights and interests of any person in the land and all leases remain binding in the same manner. On the other hand the tenant's rights of common still continue attached to the freehold; and, without express consent in writing of the lord or tenant respectively, the right of either in mines or minerals shall not be affected by the change. No creation of new copyholds by granting land out of the waste is permissible, save with the consent of the Board of Agriculture; and the act enacts that a valid admittance of a new copyholder may be made without holding a court.

Under the earlier acts, machinery to free the land from the burden of the old rents, fines and heriots was set up, commuting them into a rent charge or a fine. Commutation, however, is never compulsory, and differs from enfranchisement in that, whereas by enfranchisement the land in question is converted into freehold, by commutation it still continued parcel of the manor, though subject to a rent charge or a fine, as might have been agreed. The ordinary laws of descent, dower, and curtesy were, however, substituted for the customs in relation to these matters incidental to the land in question before commutation, and the timber became the tenant's.

**AUTHORITIES.**—C. I. Elton, *Law of Copyholds* (1898); C. Watkins, *On Copyholds* (1825); *Scriven on Copyholds*, ed. A. Brown (1896); A. Brown, *Copyhold Enfranchisement Acts* (1895).

**COPYING MACHINES.** Appliances of various kinds have been devised for producing copies of writings made by the pen or pencil. A simple method commonly adopted when only a single copy is required is to write the original with specially prepared copying ink (formed by adding some thickening substance like sugar or gum to ordinary ink), to place upon it a damped sheet of thin absorbent paper, and to press the two

together in some way, as in a copying press. The resulting impression, being reversed, must be read from the back of the absorbent paper, which is thin enough to be transparent. Another process, by which a considerable number of copies can be made simultaneously, consists in interleaving a number of sheets of thin white paper with sheets of paper prepared with lampblack ("carbon paper") and writing on the top sheet with a "style" or other sharp-pointed instrument. The hectograph may be taken as typical of manifolding processes analogous to lithography. In it the writing is in first instance done with aniline ink, and then a transfer is made to a plate of a gelatinous composition, from which a series of duplicates can be taken off. Another class of methods involves the preparation of what are essentially stencils. In the cyclostyle, paper of a special kind is stretched over a smooth metal plate, and the writing instrument consists of a holder having at the end a small wheel provided with a serrated edge on its periphery, which perforates the paper with lines of minute cuts and thus forms a stencil. When ink is passed over this stencil with a roller it goes through the perforations and leaves an impression on a piece of paper placed underneath. In the tryptograph a similar result is attained by using a simple style for writing, but stretching the paper over a metal plate having its surface covered with fine sharp corrugations which pierce the paper as the style is moved over them. In the Edison electric pen the stencil is formed by the aid of a style containing a fine needle, which is rapidly moved up and down by a small electric motor mounted at the top of the pen, and thus a series of minute holes is punctured in the paper by the act of writing. For copying plans and drawings, engineers, architects, &c., use a "blue print" process which depends on the action of light on certain salts of iron (see SUN-COPYING and PHOTOGRAPHY).

**COPYRIGHT**, in law, the right, belonging exclusively to the author or his assignees, of multiplying for sale copies of an original work or composition, in literature or art. As a recognized form of property it is, compared with others, of recent origin, being in fact, in the use of literary works, mainly the result of the facility for multiplying copies created by the discovery of printing. It is with copyright in literary compositions that we are here primarily concerned, as it was established first, the analogous right as regards works of plastic art, &c., following in its train.

1. Whether copyright was recognized at all by the common law of England was long a much debated legal question. Blackstone thinks that "this species of property, being grounded on labour and invention, is more properly reducible to the head of occupancy than any other, since the right of occupancy itself is supposed by Mr Locke and many others to be founded on the personal labour of the occupant." But he speaks doubtfully of its existence—merely mentioning the opposing views, "that on the one hand it hath been thought no other man can have a right to exhibit the author's work without his consent, and that it is urged on the other hand that the right is of too subtle and unsubstantial a nature to become the subject of property at the common law, and only capable of being guarded by positive statutes and special provisions of the magistrate." He notices that the Roman law adjudged that if one man wrote anything on the paper or parchment of another, the writing should belong to the owner of the blank materials, but as to any other property in the works of the understanding the law is silent, and he adds that "neither with us in England hath there been (till very lately) any final determination upon the rights of authors at the common law." The common law undoubtedly gives a right to restrain the publication of *unpublished* compositions; but when a work is once published, its protection depends on the statutes regulating copyright. The leading case on the subject of unpublished works is *Prince Albert v. Strange* (1849), 2 De G. & Sm. 652. Copies of etchings by Queen Victoria and Prince Albert, which had been lithographed for private circulation, fell into the hands of the defendant, a London publisher, who proposed to exhibit them, and issued a catalogue entitled *A Descriptive Catalogue of the Royal Victoria and Albert Gallery of Etchings*. The court of chancery restrained the publication of the catalogue, holding

that property in mechanical works, or works of art, does certainly subsist, and is invaded, before publication, not only by copying but by description or catalogue. This protection includes news (*Exchange Telegraph Co. v. Central News*, 1897).

As a matter of principle, the nature of copyright itself, and the reasons why it should be recognized in law, have, as already stated, been the subject of bitter dispute. It was attacked as constituting a monopoly, and it has been argued that copyright should be looked upon as a doubtful exception to the general law regulating trade, and should be strictly limited in point of duration. On the other hand, it is claimed that copyright, being in the nature of personal property, should be perpetual. A man's own work, in this view, is as much *his* as his house or his money, and should be protected by the state. Historically, and in legal definition, there would appear to be no doubt that copyright, as regulated by statute, is strictly a monopoly. The parliamentary protection of works of art for the period of fourteen years by an act of 1709 and later statutes appears, as Blackstone points out, to have been suggested by the exception in the Statute of Monopolies 1623. The object of that statute was to suppress the royal grants of exclusive right to trade in certain articles, and to reassert in relation to all such monopolies the common law of the land. Certain exceptions were made on grounds of public policy, and among others it was allowed that a royal patent of privilege might be granted for fourteen years "to any inventor of a new manufacture for the sole working or making of the same." Copyright, like patent right, would be covered by the legal definition of a monopoly. It is a mere right to prevent other people from manufacturing certain articles. But objections to monopolies in general do not apply to this particular class of cases, in which the author of a new work in literature or art has the right of preventing others from manufacturing copies thereof and selling them to the public. The rights of persons licensed to sell spirits, to hold theatrical exhibitions, &c., are also of the nature of monopolies, and may be defended on special grounds of public policy. The monopoly of authors and inventors rests on the general sentiment underlying all civilized law, that a man should be protected in the enjoyment of the fruits of his own labour.

#### LITERARY COPYRIGHT

2. *United Kingdom*.—On the invention of printing (see PRESS LAWS) the crown, or other sovereign powers, granted patents or licences with the object of restricting the right of multiplying copies of literary works, and this supervision of publication still has certain historical results.

A special kind of what amounts to perpetual copyright in various publications has for various reasons been recognized by the laws (1) in the crown, and (2) in the universities and colleges. The various copyright acts, referred to below, except from their provisions the copyrights vested in the two English and the four Scottish universities, Trinity College, Dublin, and the colleges of Eton, Westminster and Winchester. Crown copyrights are saved by the general principle which exempts crown rights from the operation of statutes unless they are expressly mentioned. Among the books in which the crown has claimed copyright are the English translation of the Bible, the Book of Common Prayer, statutes, orders of privy council, proclamations, almanacs, Lilly's Latin Grammar, year books and law reports. The copyright in the Bible is rested by some on the king's position as head of the church; Lord Lyndhurst rested it on his duties as the chief executive officer of the state charged with the publication of authorized manuals of religion. The right of printing the Bible and the Book of Common Prayer is vested in the king's printer and the universities of Oxford and Cambridge. These copyrights do not extend to prohibit independent translations from the original. The obsolete copyright of the crown in Lilly's Latin Grammar was founded on the fact of its having been drawn up at the king's expense. The universities have a joint right (with the crown's patentees) of printing acts of parliament. Law reports were decided to be the property of the crown in the reign of Charles II.; by act of parliament they were forbidden



to be published without licence from the chancellor and the chiefs of the three courts, and this form of licence remained in use after the act had expired. University and college copyrights were made perpetual by an act of George III., but only on condition of the books being printed at their printing presses and for their own benefit.

3. The first definite statute, or Copyright Act, in England was passed in 1709. The preamble states that printers, booksellers and other persons were frequently in the habit of printing, reprinting, and publishing "books and other writings without the consent of the authors or proprietors of such books and writings, to their very great detriment, and too often to the ruin of them and their families." "For preventing, therefore, such practices for the future, and for the encouragement of learned men to compose and write useful books, it is enacted that the author of any book or books already printed, who hath not transferred to any other the copy or copies of such book or books in order to print or reprint the same, shall have the sole right and liberty of printing such book or books for the term of one-and-twenty years, and that the author of any book or books already composed, and not printed and published, or that shall hereafter be composed, and his assignee, or assignees, shall have the sole liberty of printing and reprinting such book or books for the term of fourteen years, to commence from the day of first publishing the same, and no longer." The penalty for offences against the act was declared to be the forfeiture of the illicit copies to the true proprietor, and the fine of one penny per sheet, half to the crown, and half to any person suing for the same. "After the expiration of the said term of fourteen years the sole right of printing or disposing of copies shall return to the authors thereof, if they are then living, or their representatives, for another term of fourteen years." To secure the benefit of the act registration at Stationers' Hall was necessary. In section 4 was contained the provision that if any person thought the price of a book "too high and unreasonable," he might complain to the archbishop of Canterbury, the lord chancellor, the bishop of London, the chiefs of the three courts at Westminster, and the vice-chancellors of the two universities in England, and to the lord president, lord justice general, lord chief baron of the exchequer, and the rector of the college of Edinburgh in Scotland, who might fix a reasonable price. Nine copies of each book were to be provided for the royal library, the libraries of the universities of Oxford and Cambridge, the four Scottish universities, Sion College, and the faculty of advocates at Edinburgh.

It was believed for a long time that this statute had not interfered with the rights of authors at common law. Ownership of literary property at common law appears indeed to have been recognized in some earlier statutes. The Licensing Act 1662 prohibited the printing of any work without the consent of the owner on pain of forfeiture, &c. This act expired in 1679, and attempts to renew it were unsuccessful. The records of the Stationers' Company show that the purchase and sale of copyrights had become an established usage, and the loss of the protection, incidentally afforded by the Licensing Act, was felt as a serious grievance, which ultimately led to the statute of 1709. That statute, as the judges in *Millar v. Taylor* (1769, 4 Burr. 2303) pointed out, speaks of the ownership of literary property as a known thing. Many cases are recorded in which the courts protected copyrights not falling within the periods laid down by the act. Thus in 1735 the master of the rolls restrained the printing of an edition of the *Whole Duty of Man*, published in 1657. In 1739 an injunction was granted by Lord Hardwicke against the publication of *Paradise Lost*, at the instance of persons claiming under an assignment from Milton in 1667. In the case of *Millar v. Taylor* the plaintiff, who had purchased the copyright of Thomson's *Seasons* in 1729, claimed damages for an unlicensed publication thereof by the defendant in 1763. The jury found that before the statute it was usual to purchase from authors the perpetual copyright of their works. Three judges, among whom was Lord Mansfield, decided in favour of the common law right; one was of the contrary opinion. The majority thought that the act of 1709 was not intended to destroy

copyright at common law, but merely to protect it more efficiently during the limited periods. *Millar v. Taylor*, however, was speedily overruled by the case of *Donaldson v. Beckett* in the House of Lords in 1774. The judges were called upon to state their opinions. A majority (seven to four) were of opinion that the author and his assigns had at common law the sole right of publication in perpetuity. A majority (six to five) were of opinion that this right had been taken away by the statute of 1709, and a term of years substituted for the perpetuity. The decision appears to have taken the trade by surprise. Many booksellers had purchased copyrights not protected by the statute, and they now petitioned parliament to be relieved from the consequences of the decision in *Donaldson v. Beckett*. A bill for this purpose actually passed the House of Commons, but Lord Camden's influence succeeded in defeating it in the House of Lords. The result is that from that time on ordinary copyright has been recognized except in so far as it is sanctioned by statute. The university copyrights were, however, protected in perpetuity by an act passed in 1775.

By an act of 1801 the penalty for infringement of copyright was increased to threepence per sheet, in addition to the forfeiture of the book. The proprietor was to have an action on the case against any person in the United Kingdom, or British dominions in Europe, who should print, reprint, or import without the consent of the proprietor, first had in writing, signed in the presence of two or more credible witnesses, any book or books, or who knowing them to be printed, &c., without the proprietor's consent should sell, publish, or expose them for sale; the proprietor to have his damages as assessed by the jury, and double costs of suit. A second period of fourteen years was confirmed to the author, should he still be alive at the end of the first. Further, it was forbidden to import into the United Kingdom for sale books first composed, written, or printed and published within the United Kingdom, and reprinted elsewhere. Another change was made by the act of 1814, which in substitution for the two periods of fourteen years gave to the author and his assignees copyright for the full term of twenty-eight years from the date of the first publication, "and also, if the author be living at the end of that period, for the residue of his natural life."

4. The Copyright Act of 1842 repealed the previous acts on the same subject, and is the basis of the existing law. Its preamble stated its object to be to encourage the production of "literary matter of lasting benefit to the world." The principal clause is the following (§ 3): "That the copyright in every book which shall after the passing of this act be published in the lifetime of its author shall endure for the natural life of such author, and for the further term of seven years, commencing at the time of his death, and shall be the property of such author and his assignees; provided always that if the said term of seven years shall expire before the end of forty-two years from the first publication of such book the copyright shall in that case endure for such period of forty-two years; and that the copyright of every book which shall be published after the death of its author shall endure for the term of forty-two years from the first publication thereof, and shall be the property of the proprietor of the author's manuscript from which such book shall be first published and his assigns." The benefit of the enlarged period was extended to subsisting copyrights, unless they were the property of an assignee who had acquired them by purchase, in which case the period of copyright would be extended only if the author or his personal representative agreed with the proprietor to accept the benefit of the act. By section 5 the judicial committee of the privy council may license the republication of books which the proprietor of the copyright thereof refuses to publish after the death of the author. The sixth section provides for the delivery within certain times of copies of all books published after the passing of the act, and of all subsequent editions thereof, at the British Museum. And a copy of every book and its subsequent editions must be sent *on demand* to the following libraries: the Bodleian at Oxford, the public library at Cambridge, the library of the faculty of advocates in Edinburgh, and that of Trinity College, Dublin. Other libraries (the libraries

Act of  
1842.



of the four Scottish Universities, King's Inns, Dublin, and Sion College) entitled to this privilege under the earlier acts had been deprived thereof by an act passed in 1836, and grants from the treasury, calculated on the annual average value of the books they had received, were ordered to be paid to them as compensation. A book of registry is ordered to be kept at Stationers' Hall for the registration of copyrights, to be open to inspection on payment of one shilling for every entry which shall be searched for or inspected. And the officer of Stationers' Hall shall give a certified copy of any entry when required, on payment of five shillings; and such certified copies shall be received in evidence in the courts as prima facie proof of proprietorship or assignment of copyright or licence as therein expressed, and, in the case of dramatic or musical pieces, of the right of representation or performance. False entries shall be punished as misdemeanours. The entry is to record the title of the book, the time of its publication, and the name and place of abode of the publisher and proprietor of copyright. Without making such entry no proprietor can bring an action for infringement of his copyright, but the entry is not otherwise to affect the copyright itself. Any person deeming himself aggrieved by an entry in the registry may complain to one of the superior courts, which will order it to be expunged or varied if necessary. A proprietor may bring an action on the case for infringement of his copyright, and the defendant in such an action must give notice of the objections to the plaintiff's title on which he means to rely. No person except the proprietor of the copyright is allowed to import into the British dominions for sale or hire any book first composed or written or printed and published in the United Kingdom, and reprinted elsewhere, under penalty of forfeiture and a fine of £10. The proprietor of any encyclopaedia, review, magazine, periodical work, or work published in a series of books or parts, who shall have employed any person to compose the same, or any volumes, parts, essays, articles, or portions thereof, for publication on the terms that the copyright therein shall belong to such proprietor, shall enjoy the term of copyright granted by the act.<sup>1</sup> But the proprietor may not publish separately any article or review without the author's consent, nor may the author unless he has reserved the right of separate publication. Where neither party has reserved the right they may publish by agreement, but the author at the end of twenty-eight years may publish separately. Proprietors of periodical works shall be entitled to all the benefits of registration under the act, on entering in the registry the title, the date of first publication of the first volume or part, and the names of proprietor and publisher.

The interpretation clause of the act defines a book to be every volume, part, or division of a volume, pamphlet, sheet of letter-press, sheet of music, map, chart, or plan separately published.

5. During the last quarter of the 19th century the question of copyright became continually more prominent, and a considerable extension was given by judicial interpretation to the scope of the act of 1842. "Literary matter of lasting benefit to the world" came to include every publication (not being illegal) which could be described as "literary" or "original," the criterion as to the latter qualification being, in the last resort, whether (see *Trade Auxiliary Co. v. Middlesborough Association*, 1889, 40 Ch.D. 425) the author or compiler has really put his own brain-work into it.

6. The most marked and certain progress has been in the application of the law of copyright to the periodical press, in order to protect within reasonable limits the labour and expenditure of newspapers that obtain for the public the earliest news and arrange it for publication. It is settled law since 1881 (*Walter v. Howe*, 17 Ch.D. 708, overruling *Cox v. Land & Water Journal Co.*, 1869), that a newspaper is a book within the meaning of the act, and can claim all rights that a book has under the Copyright Act. Thus, leading articles, special articles, and even news items are protected (*Walter v. Steinkopff*, 1892, 3 Ch. 489; *Exchange Telegraph Co. v. Gregory*

<sup>1</sup> Such articles must be paid for, in order to vest copyright in the proprietor. The leading case about encyclopaedias is that of *Lawrence and Bullen v. Aftalo*, decided by the House of Lords in 1904.

and *Co.*, 1896, 1 Q.B. 147). Current prices of stocks and shares, translations, the compilation of a directory, summaries of legal proceedings, and other similar literary work, so far as the literary form, the labour and money are concerned, are equally protected. In short, the test may now be broadly stated to be, whether labour of the brain and expenditure of money have been given for the production; whilst the old requirement of original matter is very broadly interpreted. The leading case on the subject is *Walter v. Lane* (decided in the House of Lords, 6th August 1900). The question there raised was, whether or not copyright applied under the act of 1842 in respect of *verbatim* reports of speeches. Four law lords, viz. Lord Chancellor Halsbury, Lord Davey, Lord James of Hereford and Lord Brampton upheld the claim to copyright in such cases, whilst Lord Robertson was the sole dissentient.

Apart from newspapers, protection has been extended to publications having no literary character; Messrs Maple's furniture catalogue, and the Stock Exchange prices on the "tape" have been awarded the same protection as directories. The courts have declined to protect works which are mere copies of railway time-tables, or the "tips" of a sporting prophet, or mechanical devices with no independent literary matter, such as patterns for cutting ladies' sleeves.

7. The publication of lectures without consent of the authors or their assignees is prohibited by the Lecture Copyright Act 1835, which reinforces the common law against publication of "unpublished" matter, and gives a copyright for 28 years. This act, however, excepts from its provisions: (1) lectures of which notice has not been given two days before their delivery to two justices of the peace living within 5 m. to the place of delivery (an impracticable condition), and (2) lectures delivered in universities and other public institutions. Sermons by clergy of the established Church are believed to fall within this exception. The leading cases are *Nicols v. Pitman*, 1884, 26 Ch.D. 374, and *Caird v. Sime*, 1887, 12 A.C. 326.

8. The writer of private letters sent to another person may in general restrain their publication. It was urged in some of the cases that the sender had abandoned his property in the letter by the act of sending; but this was denied by Lord Hardwicke (*Pope v. Curl* in 1741), who held that at most the receiver only might take some kind of joint property in the letter along with the author. Judge Story, in the American case of *Folsom v. Marsh*, 2 Story (Amer.) 100, states the law as follows: "The author of any letter or letters, and his representatives, whether they are literary letters or letters of business, possess the sole and exclusive copyright therein; and no person, neither those to whom they are addressed, nor other persons, have any right or authority to publish the same upon their own account or for their own benefit." But there may be special occasions justifying such publication. See also the English case of *Macmillan v. Dent* (1905).

9. The question of what is an infringement of copyright has been the subject of much discussion. It was decided under the statute of 1709 that a repetition from memory was not a publication so as to be an infringement of copyright. In the case of *Reade v. Conquest*, 1861, 9 C.B., the same view was taken. The defendant had dramatized the plaintiff's novel *It's Never too Late to Mend*, and the piece was performed at his theatre. This was held to be no breach of copyright; but the circulation of copies of a drama, so taken from a copyright novel, whether gratuitously or for sale, is not allowed. Then again it is often a difficult question to decide whether the alleged piratical copyright does more than make that fair use of the original author's materials which the law permits. It is not every act of borrowing literary matter from another which is piracy, and the difficulty is to draw the line between what is fair and what is unfair. Lord Eldon put the question thus,—whether the second publication is a legitimate use of the other in the fair exercise of a mental operation deserving the character of an original work. Another test proposed is "whether you find on the part of the defendant an *animus furandi*—an intention to take for the purpose of saving himself

Lectures.

Private letters.

Text of infringement.

Recent extensions.

News-papers.

labour." No one, it has been said, has a right to take, whether with or without acknowledgment, a material and substantial portion of another's work, his arguments, his illustrations, his authorities, for the purpose of making or improving a rival publication. When the materials are open to all, an author may acquire copyright in his selection or arrangement of them. Several cases have arisen on this point between the publishers of rival directories. Here it has been held that the subsequent compiler is bound to do for himself what the original compiler had done. When the materials are thus *in medio*, as the phrase is, it is considered a fair test of piracy to examine whether the mistakes of both works are the same. If they are, piracy will be inferred. Translations stand to each other in the same relation as books constructed of materials in common. The *animus furandi*, mentioned above as a test of piracy, does not imply deliberate intention to steal; it may be quite compatible with ignorance even of the copyright work. Abridgments, moreover, of original works appear to be favoured by the courts—when the act of abridgment is itself an act of the understanding, "employed in carrying a large work into a smaller compass, and rendering it less expensive." Lord Hatherley, however, in *Tinsley v. Lacy*, 1863, 1 H. & M. 747, incidentally expressed his disapproval of this feeling—holding that the courts had gone far enough in this direction, and that it was difficult to acquiesce in the reason sometimes given that the compiler of an abridgment is a benefactor to mankind by assisting in the diffusion of knowledge. A mere selection or compilation, so as to bring the materials into smaller space, will not be a bona fide abridgment; "there must be real substantial condensation, and intellectual labour, and judgment bestowed thereon" (Justice Story). A publication professing to be *A Christmas Ghost Story, Reoriginated from the Original by Charles Dickens, Esq., and Analytically Condensed expressly for this Work*, was found (*Dickens v. Lee*, 1844, 8 Jur. 183) to be an invasion of Charles Dickens's copyright in the original.

10. There can be no copyright in any but innocent publications. Books of an immoral or irreligious tendency have been repeatedly decided to be incapable of being made the subject of copyright. In a case (*Lawrence v. Smith*, 1 Jac. 471) before Lord Eldon in 1822, an injunction had been obtained against a pirated publication of the plaintiff's *Lectures on Physiology, Zoology, and the Natural History of Man*, which the judge refused to continue, "recollecting that the immortality of the soul is one of the doctrines of the Scriptures, and considering that the law does not give protection to those who contradict the Scriptures." The same judge refused in 1822 to restrain a piracy of Lord Byron's *Cain*, and *Don Juan* was refused protection in 1823. Compare also *Cowan v. Milbourn*, 1867, L.R. 2 Ex. 230, in which a contract to let a room for lectures of an irreligious character was held not to be binding.

11. The quasi-copyright in titles of books, periodicals, &c. is founded on the desirability of preventing one person from putting off on the public his own productions as those of another. This is, however, not copyright, but a question of ordinary fraud. The name of a journal (if sufficiently established) is a species of trade-mark in which the law recognizes what it calls a "species of property," provided any misleading of the public is involved. Thus, the *Wonderful Magazine* was invaded (1803) by a publication calling itself the *Wonderful Magazine, New Series Improved*. *Bell's Life in London* was pirated (1859) by a paper calling itself the *Penny Bell's Life*. The proprietors of the *London Journal* got an injunction (1859) against the *Daily London Journal*, which was projected by the person from whom they had bought their own paper, and who had covenanted with them not to publish any weekly journal of a similar nature. A song published under the title of *Minnie*, sung by Madame Anna Thillon and Miss Dolby at Monsieur Jullien's concerts, was invaded (1855) by a song to the same air published as *Minnie Dale, Sung at Jullien's Concerts by Madame Anna Thillon*. On the other hand, the *Sphere* and *Spear*, titles of misleading similarity, assumed by two weekly periodicals that appeared almost simultaneously in London in

1900, could not successfully attack each other, because neither had an established reputation when first adopted.

12. Dramatic and musical compositions stand on this peculiar footing, that they may be the subject of two entirely distinct rights. As writings they come within the general Copyright Act, and the unauthorized multiplication of copies is a piracy of the usual sort. This was decided to be so even in the case of musical compositions under the act of 1709. The Copyright Act of 1842 includes a "sheet of music" in its definition of a book. Separate from the copyright thus existing in dramatic or musical compositions is the stage-right or right of representing them on the stage; this was the right created by the Dramatic Copyright Act of 1833, in the case of dramatic pieces. This act gave the owner of the stage-right (right of representation) a period of twenty-eight years, or the duration of the author's life if longer. The Copyright Act 1842 extended this right to musical compositions, and made the period in both cases the same as that fixed for copyright. And the act expressly provides (meeting a contrary decision in the courts) that the assignment of copyright of dramatic and musical pieces shall not include the right of representation unless that is expressly mentioned. The act of 1833 prohibited representation "at any place of public entertainment," a phrase which was omitted in the act of 1842, and it may perhaps be inferred that the restriction is now more general and would extend to any unauthorized representation anywhere. A question has also been raised whether, to obtain the benefit of the act, a musical piece must be of a dramatic character. The dramatization of a novel, *i.e.* the acting of a drama constructed out of materials derived from a novel, is not necessarily an infringement of the copyright in the novel (supposing it to be possible to do it without making any sort of colourable copy of the literary form), but to publish a drama so constructed has been held to be a breach of copyright (*Tinsley v. Lacy*, 1863, 1 H. & M. 747, where defendant had published two plays founded on two of Miss Braddon's novels, and reproducing the incidents and in many cases the language of the original). Where two persons dramatize the same novel, what, it may be asked, are their respective rights? In *Toole v. Young*, 1874, 9 Q.B. 523, this point actually arose. A, the author of a published novel, dramatized it and assigned the drama to the plaintiff, but it was never printed, published or represented upon the stage. B, ignorant of A's drama, also dramatized the novel and assigned his drama to the defendant, who represented it on the stage. It was held that any one might dramatize A's published novel, and that the representation of B's drama was not a representation of A's drama. This case may be compared with *Reade v. Lacy* (1861).

In the "Little Lord Fauntleroy" case (1888) the person who dramatized the novel of another without his consent, an operation up to that time believed to be unassailable in law, was attacked successfully, by preventing him from using printed or written copies of the play, either to deposit with the lord chamberlain or as prompt-books. In every case where much of the original dialogue of the novel is taken, this stops the production of the dramatization.

In music, statutes of 1882 and 1888 have prevented the use of the provisions inflicting penalties for the performance of copyright songs for purposes of extortion, by allowing the court to inflict a penalty of one farthing and make the plaintiff pay the costs, if justice requires it. Authors reserving the right of public performance are required to print a notice to that effect on all copies of the music.

An important decision (which appears to be a grave injustice) on musical copyright is the case of *Boosey v. Whight* (1899; followed in other cases—see *Mabe v. Conner*, 1909), in which it was held that the reproduction of copyright tunes on the perforated slips for an Aeolian or other mechanical instrument is not an infringement of copyright. In Germany it has been decided (*Lincke v. Gramophone Co.*) that the reproduction of copyright music on a gramophone is an infringement, and an injunction was granted. It has also been held in France that the production of copyright *words* (but not music) was an

*Drama  
and  
music.*

*Injurious  
works.*

*Titles of  
works.*

infringement, while in the United States the Copyright Act of 1909 extended copyright control to mechanical reproductions, and gave the copyright proprietor power to exact royalties.

The copyright in music was subject to serious injury in England from the selling of pirated copies in the streets by hawkers; and in 1902 an act was passed enabling summary proceedings to be taken for having such copies seized and destroyed. But this act had various practical defects, which still left publishers largely at the mercy of the pirates. In 1905 the evil had become so serious that the chief music publishers announced their intention of not producing any further works till the law was altered; but the new Musical Copyright Bill of that year was obstructed and talked out in the House of Commons. In November 1905 an important prosecution, instituted by Messrs Chappell on behalf of the associated music-publishers and composers, was brought against a coterie of pirates. In the session of 1906 another attempt, this time successful, was made to pass a Musical Copyright Bill. This act (the Musical Copyright Act 1906) made it a criminal offence, punishable with fine and imprisonment, to reproduce or sell, or to possess plates for the production of, pirated copies of musical works. The act also gave power to a constable to arrest without warrant any person who in any public place exposes for sale or has in his possession for sale, or canvasses or personally advertises pirated copies, provided that the apparent owner of the copyright signs an authority requesting such arrest at his own risk. Also a court of summary jurisdiction may grant a search warrant, if there is reasonable ground for believing that an offence against the act is being committed on any premises.

13. The right of foreigners under the English copyright acts produced at one time an extraordinary conflict of judicial opinion. A foreigner who during residence in the British dominions should publish a work was admitted to have a copyright therein. The question was whether residence at the time of publication was necessary. In *Cocks v. Purday*, the court of common pleas held that it was not. In *Boosey v. Davidson*, the court of queen's bench, following the decision of the court of common pleas in *Cocks v. Purday*, held that a foreign author might have copyright in works first published in England, although he was abroad at the time of publication. But the court of exchequer, in *Boosey v. Purday*, refused to follow these decisions, holding that the legislature intended only to protect its own subjects,—whether subjects by birth or by residence. The question came before the House of Lords on appeal in the case of *Boosey v. Jeffreys* (1854), in which the court of exchequer had taken the same line. The judges having been consulted were found to be divided in opinion. Six of them held that a foreigner resident abroad might acquire copyright by publishing first in England. Four maintained the contrary. The views of the minority were affirmed by the House of Lords (Lord Chancellor Cranworth and Lords Brougham and St Leonards). The lord chancellor's opinion was founded upon "the general doctrine that a British senate would legislate for British subjects properly so called, or for such persons who might obtain that character for a time by being resident in this country, and therefore under allegiance to the crown, and under the protection of the laws of England." Lord Brougham said that

"The statute of Anne had been passed for the purpose of encouraging learned men, and with that view that act had given them the exclusive right in their publications for twenty-one years. This, however, was clear, they had no copyright at common law, for if they had there would have been no necessity for the passing of that statute. It could scarcely be said that the legislature had decided a century and a half since that act was to be passed to create a monopoly in literary works solely for the benefit of foreigners. In the present case he was clearly of opinion that the copyright did not exist, and therefore that foreign law should not prevail over British law where there was such diversity between the two."

Against the authority of this case, however, must be set the opinion of two great lord chancellors—Lord Cairns and Lord Westbury. In the case of *Routledge v. Low*, L.R. 3 H. L. 100, 1868, Lord Cairns said,

"The aim of the legislature is to increase the common stock of

the literature of the country; and if that stock can be increased by the publication for the first time here of a new and valuable work composed by an alien who has never been in the country, I see nothing in the wording of the act which prevents, nothing in the policy of the act which should prevent, and everything in the professed object of the act and in its wide and general provisions which should entitle such a person to the protection of the act, in return and compensation for the addition he has made to the literature of the country."

And Lord Westbury said, in the same case,

"The case of *Jeffreys v. Boosey* is a decision which is attached to and depends on the particular statute of which it was the exponent, and as that statute had been repealed and is now replaced by another act, with different enactments expressed in different language, the case of *Jeffreys v. Boosey* is not a binding authority in the exposition of this later statute. The act appears to have been dictated by a wise and liberal spirit, and in the same spirit it should be interpreted, adhering of course to the settled rules of legal construction. The preamble is, in my opinion, quite inconsistent with the conclusion that the protection given by the statute was intended to be confined to the works of British authors. The real condition of obtaining its advantages is the first publication by the author of his work in the United Kingdom. Nothing renders necessary his bodily presence here at the time, and I find it impossible to discover any reason why it should be required, or what it can add to the merit of the first publication. If the intrinsic merits of the reasoning on which *Jeffreys v. Boosey* was decided be considered, I must frankly admit that it by no means commands my assent."

These conclusions might follow also from the Naturalization Act of 1870, which enacts that real and personal property of every description may be taken, acquired, held, and disposed of by an alien in the same manner in all respects as by a natural born British subject. At the present time the International Copyright Act has largely removed the question from the area of conflict.

14. *International Copyright*.—Books published in one country and circulated in another depend for their protection in the latter upon international copyright. Until 1886 international copyright in Great Britain rested on a series of orders in council, made under the authority of the International Copyright Act 1844 (superseding acts of 1820 and 1826), conferring on the authors of a particular foreign country the same rights in Great Britain as British authors, on condition of their registering their work in Great Britain within a year of first publication abroad. A condition of the granting of each order was that the sovereign should be satisfied that reciprocal protection was given in the country in question to British authors. As the result of conferences at Bern in 1885 and 1887, this system was simplified and made more general by the treaty known as "The Bern Convention," signed at Bern on the 5th of September 1887. The contracting parties were the British Empire, Belgium, France, Germany, Italy, Spain, Switzerland, Tunis and Hayti. Luxemburg, Monaco, Norway and Japan afterwards joined. Austria and Hungary have a separate convention with Great Britain, concluded on the 24th of April 1893. The notable absentees among European powers are Holland and Russia. So far as the United States is concerned, the matter is regulated by the American copyright acts, which are dealt with separately below.

The basis of the Bern convention was that authors of any of the countries of the Union, or the publishers of works first published in one of them, should enjoy in each of the other countries of the Union the same rights as the law of that country granted to native authors. The only conditions were that the work should comply with the necessary formalities, such as registration, in the country where it was first published, in which case it was exempt from all such formalities elsewhere; and that the protection required from any country should not exceed that given in the country of origin. The rights conferred included the sole right of making a translation of the work for ten years from its first publication. The convention was retrospective; that is to say, it applied to copyright works published before its coming into existence, each country being allowed to protect vested interests, or copies already made by others, as it should think best.

The rights of foreign authors in Great Britain rest on legislation

*The Bern Convention.*

giving effect to the Bern convention, namely, the International Copyright Act of 1886, and an order in council made under that act, dated 28th November 1887. These confer on the author or publisher of a work of literature or art first published in one of the countries which are parties to the convention, after compliance with the formalities necessary there, the same rights as if the work had been first published in the United Kingdom, provided that those rights are not greater than those enjoyed in the foreign country.

The rights of British authors in foreign countries rest in each country on the domestic legislation by which the particular country has given effect to its promise contained in the Bern convention, and are enforced by the courts of that country. The Bern convention was revised in minor details not affecting its broad principles by a conference meeting in 1896 in Paris, and Great Britain adopted the results of their labours by an order in council dated 7th March 1898. A further simplification in the international law of copyright was expected to result from the efforts of the international conference at Berlin in 1908, July 1910 being the latest date at which ratification by the states concerned might take place, but it cannot here be stated to what extent legislation may give effect to the decisions arrived at. So far as these decisions affect Great Britain, the greatest alterations of existing law would be in establishing throughout the Union protection of musical copyright, especially with regard to singing and talking machines, and also in the matter of newspaper copyright. The conference adopted a threefold division of newspaper matter: (1) serial stories, tales and all other work, literary, scientific and artistic, which is to have absolute protection; (2) all newspaper matter, except the foregoing and mere items of general news (*faits divers*), of which reproduction is to be permitted on acknowledgment of the source, unless such reproduction is expressly forbidden; (3) news of the day and simple facts, to which no protection is given. An endeavour was also made to have a uniform period throughout the Union for copyright of the author's life and 50 years.

15. *Colonial Copyright*.—Under English copyright, books of the United Kingdom were formerly protected in the colonies by the Colonial Copyright Act of 1847, and copies of them printed or reprinted elsewhere could not be imported into the colonies. In 1876 a royal commission was appointed to consider the whole question of home, colonial and international copyright; and various recommendations were made. But the matter now rests on the English International Copyright Act 1886, which contains provisions designed to extend the benefit of the British copyright acts to works first produced in the colonies, while allowing each colony to legislate separately for works first produced within its own limits. The colonies at present are all included in the system of international copyright established by the Bern convention.

In 1875 an act was passed (re-enacted in 1886 in the revised Canadian statutes) to give effect to an act of the parliament of the Dominion of Canada respecting copyright. An order in council in 1868 had suspended the prohibition against the importation of foreign reprints of English books into Canada, and the parliament had passed a bill on the subject of copyright as to which doubts had arisen whether it was not repugnant to the Order in Council. It was also enacted that, after the bill came into operation, if an English copyright book became entitled to Canadian copyright, no Canadian reprints thereof should be imported into the United Kingdom, unless by the owner of the copyright. The following points in the Canadian act are worth noting:—Any person printing or publishing an unprinted manuscript without the consent of the author or legal proprietor shall be liable in damages (§ 3). Any person domiciled in Canada, or in any part of the British possessions, or being a citizen of any country having an international copyright treaty with the United Kingdom, who is the author of any book, map, &c., &c., shall have the sole right and liberty of printing, reprinting, publishing, &c., for the term of twenty-eight years. The work must be printed and published, or reprinted or republished in Canada, whether before or after its publication elsewhere: and the Canadian privilege is not to be con-

tinued after the copyright has ceased elsewhere. And "no immoral or licentious, or irreligious, or treasonable, or seditious literary, scientific or artistic work" shall be the subject of copyright (§ 4). A further period of fourteen years will be continued to the author or his widow and children. An "interim copyright" pending publication may be obtained by depositing in the office of the minister of agriculture (who keeps the register of copyrights) a copy of the title of the work; and works printed first in a series of articles in a periodical, but intended to be published as books, may have the benefit of this interim copyright. If a copyright work becomes out of print, the owner may be notified of the act through the minister of agriculture, who, if he does not apply a remedy, may license a new edition, subject to a royalty to the owner. Anonymous books may be entered in the name of the first publisher. In 1889 an amending Canadian act was passed, which led to a long controversy with the Mother Country,—the imperial government refusing to sanction it,—till in 1900 a compromise was effected, and a further act amending that of 1886 became law. It applies only to books copyright in Canada, and, subject to certain reservations, allows the minister of agriculture to prohibit the importation, without consent of the licensees, of any copies printed elsewhere of books published in the British dominions licensed by the owners to be reproduced in Canada.

The Australian states all have copyright laws modelled on the English. New Zealand provides for a term of 28 years, or the author's life. In Cape Colony the term for books is the author's life and 5 years, or a minimum of 30 years. The Indian act of 1847 is modelled on the English.

16. *Other Countries*.—The following notes give the general terms of the copyright law in other countries of importance. For details reference must be made to text-books. We only deal specifically with the history and particulars of American copyright.

*Austria*, by a law of 1895, gives copyright for thirty years after author's death.

*Belgium*.—Copyright formerly perpetual, now limited to the life of the author, and 50 years thereafter.

*France*.—Copyright in France is recognized in the most ample manner. Two distinct rights are secured by law—1st, the right of reproduction of literary works, musical compositions, and works of art; and 2nd, the right of representation of dramatic works and musical compositions. The period is for the life of the author and fifty years after his death. After the author's death the surviving consort has the usufructuary enjoyment of the rights which the author has not disposed of in his lifetime or by will, subject to reduction for the benefit of the author's protected heirs if any. The author may dispose of his rights in the most absolute manner in the forms and within the limits of the Code Napoléon. Piracy is a crime punishable by fine of not less than 100 nor more than 2000 francs; in the case of a seller from 25 to 500 francs. The pirated edition will be confiscated. Piracy also forms the ground for a civil action of damages to the amount of the injury sustained—the produce of the confiscation, if any, to go towards payment of the indemnity (Penal Code, Art. 425-429).

*Germany*.—Period fixed in 1837 at ten years; but copyright for longer periods was granted for voluminous and costly works, and for the works of German poets. Among others the works of Schiller, Goethe, Wieland, &c., were protected for a period of twenty years from the date of the decree in each case. In 1845 the period was extended in all cases to the author's life and thirty years after. The present law rests on a Codifying Act of 1901, the term being the author's life and 30 years, or not less than 10 years in any case.

*Greece*.—Copyright is for fifteen years from publication.

*Holland*.—Fifty years, or author's life, whichever is longer.

*Hungary*.—by a law of 1884, gives a copyright for the author's life and 50 years after.

*Italy*.—Life of author, or 40 years from date of publication; and afterwards a further period of 40 years, subject to a right in others to reproduce on payment of 5% on each copy.

*Japan*.—Author's life and 30 years after.

*Foreign Law.*

*Norway*, by a law of 1893, gives protection for author's life and 50 years after.

*Portugal*.—Author's life and 50 years after.

*Russia*.—Author's life and 50 years.

*Spain*.—Author's life and 80 years thereafter.

*Sweden and Denmark* provide for a term of the author's lifetime and 50 years after.

*Switzerland*.—Author's life and 30 years after.

*Turkey*.—Author's life, or 40 years, whichever is the longer.

17. *United States*.—American copyright is provided for by an act of March 1909, which replaced acts of July 1870 and

**American law.**

March 1891, both of which had introduced important modifications in the original act of 1790. Under all acts preceding that of 1891, copyright had been granted to "citizens or residents of the United States," the term "resident" having been, in decisions prior to 1891, construed to mean a person domiciled in the United States with the intention of making there his permanent abode. The works of foreigners could thus be reproduced without authorization, and they were so reproduced in so far as there was prospect of financial gain. The leading publishers, however, had from the earliest times made terms with British authors, or with their representatives, the British publishers, for producing authorized American editions. But at most they were only able to secure by this means an advantage of a few weeks' priority over the unauthorized editions, and the good-will of the conscientious buyer; so that if they paid the author any considerable sum, the price of the authorized editions had to be made so high that it was not easy to secure a remunerative sale. The unauthorized editions had the further advantage in competition, that for the purpose of being manufactured more promptly and more economically, they could be and often were issued in an abbreviated and garbled form, an injury which to not a few writers seemed more grievous than the lack of pecuniary profit. In Great Britain, during the first half of the 19th century, the copyright law had been so interpreted as to secure recognition of the rights of American authors for such works as were produced there not later than in any other country, so that authors like Washington Irving and Fenimore Cooper secured for a time satisfactory returns; but after 1850 the conditions became the same as in the United States. Unauthorized editions were published, and were often incomplete and garbled.

As from decade to decade the books produced on either side of the Atlantic, which possessed interest for readers of the other side, increased in quantity and in importance, the evil of these unrestricted piracies increased. The injury to British authors was greater only in proportion as the English books were more numerous. The pressure from Great Britain during the last half of the 19th century for international copyright was continuous; and in America it was recognized by authors, by representative publishers, and by the more intelligent people everywhere, that the existing conditions were of material disadvantage. The loss to American authors was direct; and the loss to legitimate American publishers was also clear, in that better returns could be secured by adequate payments for rights that could be protected by law than by "courtesy" payments for authorizations that carried no legal rights. An injury was being done to American literature; for, when authorized editions of American works had to compete against unauthorized and more cheaply produced editions of English works, the business incentive for literary production was seriously lessened. In fiction particularly, authors had to contend against a flood of cheaply produced editions of "appropriated" English books. Equally to be condemned were the ethics of a relation under which one class of property could be appropriated while other classes secured legal protection. On these several grounds efforts had long been made to secure international copyright. Between 1843 and 1886 no less than eleven international copyright bills were drafted, for the most part at the instance of the copyright associations or copyright leagues. They were one after the other killed in committee. In 1886 the twelfth international copyright bill was brought before the Senate by Senator

Jonathan Chace of Rhode Island, and was referred to the committee on patents. In 1887 the American Publishers' Copyright League (succeeding the earlier American Publishers' Association) was organized, with William H. Appleton as president and G. H. Putnam as secretary. The executive committee of this league formed, with a similar committee of the Author's Copyright League, a conference committee, under the direction of which the campaign for copyright was continued until the passage of the act of March 1891. Of the Authors' Copyright League James Russell Lowell was the first president, being succeeded by Edmund Clarence Stedman. The secretary during the active work of the league was Robert U. Johnson. Under the initiative of the conference committee copyright leagues were organized in Boston, Chicago, St Louis, Cincinnati, Minneapolis, Denver, Colorado City and other places. The Chace Bill was introduced in the House in March 1888. In May 1890 this bill, with certain modifications, came before the House, and was there defeated. In March 1891 the same measure, with certain further modifications, secured a favourable vote in the House during the last hour of the last day of the session, was passed by the Senate, and was promptly signed by President Harrison. Thus, after a struggle extending over fifty-three years, the United States accepted the principle at all events of international copyright.

18. The act of 1891 was criticized in several respects: (1) A condition was that books or works of art must be "manufactured" in America; consideration not being given to books originally produced in some language other than English. (2) It required publication in the United States simultaneously with that in the country of origin. (3) The term of copyright (28 years, with an extension of 14 years to the author if alive, or to widow or children) was shorter than that accorded under the law of any other literature-producing country, excepting Greece. Minor amending acts were passed in 1893, 1895 and 1897, that of Feb. 19, 1897, establishing as the copyright department of the library of Congress a Bureau of Copyrights, the head of which bears the title of Register of Copyrights. Eventually, after hard work by the American Authors' Copyright League and the Publishers' Copyright League, and after sittings extending to a period of three years, a new bill submitted to Congress by the two Committees on Patents of the House of Representatives and the Senate was successfully passed. It came into force on the 1st of July 1909. Its provisions may be briefly summarized as follows:—

Copyright is granted to authors for twenty-eight years from the date of first publication, whether the copyrighted work bears the author's true name or is published anonymously or under an assumed name. A further term of twenty-eight years is granted to the author if at the expiration of the first term he be still living, or to his widow and children if he be dead. If the author's widow and children be dead an extension is granted to the author's executors, or in the absence of a will, to his next of kin. Applications for renewal and extension must be made to the copyright office and duly registered therein within one year prior to the expiration of the existing term. To any work in which copyright subsists at the time the act went into force the act extends renewal for a period of twenty-eight years at the expiration of the time provided for under the previously existing law (first period 28 years, renewal period 14 years). The works for which copyright may be secured under the act "shall include all the writings of an author." For purposes of registration the act classifies (1) books, including composite and cyclopaedic works, directories, gazetteers and other compilations; (2) periodicals, including newspapers; (3) lectures, sermons, addresses, prepared for oral delivery; (4) dramatic or dramatico-musical compositions; (5) musical compositions; (6) maps; (7) works of art; models or designs for works of art; (8) reproductions of a work of art; (9) drawings or plastic works of a scientific or technical character; (10) photographs and (11) prints and pictorial illustrations. But compilations or abridgments, adaptations, arrangements, dramatizations, translations or other versions of copyrighted works, when produced with the consent of the proprietors of the copyrighted work are, under the 1909 act, new works subject to copyright. A citizen or subject of a foreign state can secure copyright only when he is domiciled within the United States at the time of the first publication of his work, or when the foreign state or nation of which he is a subject grants, either by treaty, convention, agreement or law, to citizens of the United States the benefit of

**Provisions of Act of 1909.**

**Term of copyright.**

**Definition of copyright.**



copyright on substantially the same basis as to its own citizens, or copyright protection equal to that secured by the foreign author under the United States act, or when the foreign state is a party to an international agreement providing for reciprocity in the granting of copyright, and the United States may, by the terms of that agreement, become a party thereto. After copyright has been secured by publication of a work, two complete copies of the best edition published must be "promptly" deposited in the copyright office, or mailed to the register of copyrights, the postmaster, on request, giving a receipt and mailing the books without cost. If the work be a contribution to a periodical, one copy of the issue containing it must be sent, or if it be a work not reproduced in copies for sale, a copy, print, photograph or other identifying reproduction must accompany the claim. Prior to 1891 the works of authors could be put into print on either side of the Atlantic. The act of 1891 laid down that, in order to secure copyright, all editions of the works of all authors, resident or non-resident, must be entirely

**"Manufacture" class.**

manufactured within the United States, the term "manufactured" including the setting of type as well as printing and binding. This manufacturing condition was insisted on by the typographical unions. There is no logical connexion, however, between the right of an author or artist to the control of his production and the interests of American workmen; the attempt to legislate for them jointly must bring about no little confusion and inequity. If American working-men cannot secure a living in competition with labourers on the other side of the Atlantic, their needs should be cared for under the provisions of the protective tariff. It is, however, the belief of a large number of those who are engaged in the manufacturing of books that, with his advanced methods of work, the skilled American labourer has no reason to dread the competition of European craftsmen. With this manufacturing condition out of the way, there would be nothing to prevent the United States from becoming a party to the Bern Convention. This would place intellectual property on both sides of the Atlantic on the same footing. The power of the unions was sufficiently strong to prevent this condition being eliminated from the act of 1909, but the just claims were met of authors whose books are originally produced in some language other than English, the

**Exemption of text of foreign book.**

"original text of a book of foreign origin in a language or languages other than English" being exempted from the requirements as to type-setting in the United States. On the other hand the manufacturing condition is extended by the act of 1909 to illustrations within a book, and also to separate lithographs or photo-engravings, "except where in either case the subjects represented are located in a foreign country and illustrate a scientific work or reproduce a work of art." The notice of copyrights required by the act consists either of the word "copyright" or by the abbreviation "Copr.," accompanied by the name of the copyright proprietor, and in the case of printed literary, musical or dramatic works, the notice must include also the year in which the copyright was secured by publication. In the case of works specified in 6 to 11 inclusive, of the classification given above, the copyright notice may consist of the letter C enclosed within a circle, thus: ©, accompanied by the initials, monogram, mark or symbol of the copyright proprietor, provided that on some accessible portion of the copy or of the margin, or on the back or pedestal his name appears.

The act of 1909 gives an *interim* protection to a book published abroad in the English language before publication in the United States, the deposit in the copyright office, not later than thirty days after its publication abroad, of one complete copy of the foreign edition, with a request for the reservation of the copyright and a statement of the name and nationality of the author and copyright proprietor, securing copyright for thirty days from the date of deposit. Any person infringing a copyright work is liable to an injunction, and to pay such damages as the copyright proprietor may have suffered by the infringement; in lieu of actual damages and profits the courts may award such damages as appear to be just, and in assessing them may, at its discretion, allow the amounts mentioned below, except that in the case of a newspaper reproduction of a copyrighted photograph such damages must not exceed the sum of two hundred and fifty dollars or be less than fifty dollars, and in no other case must the damages be more than five thousand dollars or less than two hundred and fifty dollars: (1) In the case of a painting, statue or sculpture, ten dollars for any infringing copy made or sold or found in the possession of the infringer or his agents or employees; (2) in the case of any work enumerated in the classification given before, except a painting, statue or sculpture, one dollar for every infringing copy; (3) in the case of a lecture, sermon or address, fifty dollars for every infringing delivery; (4) in the case of dramatic or dramatico-musical or a choral or orchestral composition, one hundred dollars for the first and fifty dollars for every subsequent infringing performance; in the case of other musical compositions, ten dollars for every infringing performance; all infringing copies and devices must also be delivered up for destruction. The act gives full control over his compositions to a musical composer, and the right to make any arrangement or setting of it, or of the melody of it, in any system of

**Infringement.**

notation or form of record from which it may be read or reproduced. His right to control the reproduction of his music by mechanical instruments is restricted (1) to cover only music published and copyrighted after the act went into effect; (2) to include a musical composition by a foreign composer only in the case of a citizen of a foreign state that grants to citizens of the United States similar rights; (3) where the owner of a musical copyright has permitted the use of his work upon parts of instruments serving to reproduce the composition mechanically, permission for a similar use of such work must be accorded to any other person on the payment of a fixed royalty of two cents on each part manufactured. The act makes a clear distinction between the property in the copyright and that in the material object representing the copyright, and enacts that the sale or conveyance of the material object shall not of itself constitute a transfer of the copyright. Transfer of copyright in the United States is to be effected by an instrument in writing signed by the proprietor of the copyright, or the copyright may be bequeathed by will. Assignment of copyright executed in a foreign country must be acknowledged by the assignor before a consular officer of the United States. Every assignment of copyright must be recorded in the copyright office within three calendar months after its execution in the United States or within six months without the limits of the United States. The importation into the United States is forbidden of any piratical copies of a copyrighted book or of any copies not produced in accordance with the manufacturing provisions of the act (although authorized by the author or proprietor), but importation is allowed to any society or institution incorporated for educational, literary, philosophical, scientific or religious purposes, or for the encouragement of the fine arts, or to any State school, college, &c., or to free public libraries, when importation is for use and not for sale. The act of 1891 allowed "two copies in any one invoice" to be imported, but by the act of 1909 not more than *one* copy is to be imported in one invoice.

**Musical compositions.**

The provisions having to do with international copyright become operative in the case of a foreign state only when the president proclaims that the state has fulfilled the condition of reciprocity. The act of 1891 was put into force with foreign states as follows:—1st of July 1891, Great Britain, Belgium, France, Switzerland; 8th of March 1892, Germany (by separate treaty); 31st of October 1892, Italy; 8th of May 1893, Denmark; 15th of July 1895, Spain; 20th of July 1895, Portugal; 27th of February 1896, Mexico; 13th of April 1896, Sweden and Norway; 25th of May 1896, Chile; 19th of October 1899, Costa Rica; 20th of November 1899, the kingdom of the Netherlands. In the case of each state the territory covered by the provisions of the law included the possessions, dependencies, &c. The copyright agreement with Great Britain therefore covered the crown colonies of the empire, including India and the self-governing dominions and states, such as Canada, Australia, &c. An American work duly entered for copyright in Great Britain secures, as a British publication secures, the protection of copyright under the provisions of the Bern convention throughout the territory of the several states that are parties to that convention.

**Transfer and assignment of copyright.**

**Importation of copyright works.**

**ARTISTIC COPYRIGHT**

19. Literary authors had protection for their literary work much earlier than artists for their artistic productions. Pictures and illustrations, when included in books or newspapers, are protected by the law which applies to the latter, but that is a separate question. It was not until the reign of George II. that the legislature in England afforded any protection for the work of artists. The English law on artistic copyright is alone considered in this account, the American having been included in the section *United States* above (18), while for other countries the details are so various that it is only possible to refer the reader to the leading text-books.

The first Artists' Copyright Bill was passed in the interest of William Hogarth, one of the greatest of English painters, who was engraver as well as painter, and who devoted a considerable portion of his time to engraving his own works. No sooner, however, were these published than his market was seriously damaged by the issue of inferior copies of his engravings by other publishers. To protect Hogarth from such piracy the Engraving Copyright Act 1734 was passed, which provided that "every person who should invent and design, engrave, etch, or work in mezzotinto or chiaroscuro, any historical or other print or prints, should have the sole right and

**Engravings.**



liberty of printing and representing the same for the term of fourteen years, to commence from the day of the first publishing thereof, which shall be truly engraved with the name of the proprietor on each plate, and printed on every such print or prints." The penalty for piracy was the forfeiture of the plate and all prints, with a fine of 5s. for every pirated print.

In 1766, in the reign of George III., a second Engraving Copyright Act was passed "to amend and render more effectual" the first act, and "for vesting and securing to Jane Hogarth, widow, the property in certain prints," which extended the protection beyond the designer, who was also engraver, to any person who, not being himself a designer, made, or caused to be made, an engraving from any picture or other work of art. Jane Hogarth, the widow of the painter, found herself nearing the termination of the fourteen years' term of copyright grant by the first act, with the probability that immediately on its expiry the engravings of her husband then on sale, and on which her livelihood depended, would be immediately pirated. It was mainly to save her from the loss of her livelihood that this second Copyright Bill extended the term of the copyright to twenty-eight years.

The engravers and publishers of the day were not over-scrupulous, and they sought to evade the penalties of the copyright acts by taking the designs, and adding to them or taking from them, or both, and producing fresh engravings, seeking to make it appear that they were producing new works. These practices assumed such proportions that it became necessary, in 1777, to call upon parliament to put through another short measure still further to protect the engraver, by prohibiting the copying "in whole or in part" (a clause not contained in the previous acts), by varying, adding to, or diminishing from, the main design of an engraving without the express consent of the proprietor or proprietors. These three acts remain in force to the present day. In 1852, in an international copyright act, it was declared that the Engraving Copyright Acts collectively were intended to include prints taken by lithography or any other mechanical process.

20. In May 1814 the Sculpture Copyright Act was passed to give protection to sculptors. The term of copyright for sculptors *Sculpture.* was a peculiar one. It was to last for fourteen years, with the proviso that, should the author be still alive, he should enjoy a further period of fourteen years, the copyright returning to him for the second fourteen should he have disposed of it for the first period. It is a condition of copyright with the sculptor that the author must put his name with the date upon every work before putting it forth or publishing it. A curious and interesting point in the interpretation of this act is, that according to the opinion of eminent jurists it is necessary to an infringement of the copyright of a piece of sculpture that the copy of it must take the form of another piece of sculpture; that a photograph, drawing, or engraving of a piece of sculpture is not to be considered a reproduction of it, and is therefore not an infringement of the sculptor's copyright.

21. Strange as it may seem, painting was the last branch of the arts to receive copyright protection. The cause of the *Painting.* painters was taken up by the Society of Arts, who endeavoured, in the first instance, to pass an amendment and consolidation bill dealing with engraving, sculpture and painting; but, failing in their first effort, they limited their second to an attempt to pass a bill in favour of painting, drawing and photography. It was in the year 1862 that this act, having passed through parliament, came into force. The absence of any antecedent protection for the painter is clearly stated in its preamble, which reads as follows: "Whereas by law as now established, the authors of paintings, drawings, and photographs have no copyright in such their works, and it is expectant that the law should in that respect be amended. Be it, therefore, enacted," &c. This preamble makes it clear that there is no copyright in any paintings, drawings, or photographs executed and dealt with before the year 1862—to be exact, 20th July of that year. The duration of the term of copyright in this act of 1862 differs from its predecessors, by being made dependent on the life of the author, to which life seven years were added. In

the Literary Copyright Act there are two terms—the life of the author and seven years, or forty-two years, whichever may prove the longer. In taking a fixed term like forty-two years it is necessary to have something to start from, and with a literary work it was easy to start from the date of publication. But pictures are not published. They may pass from the studio to the wall of the purchaser without being made public in any way. The difficulty was evidently before the author of this act, and the artist's term was made his life and seven years after his death without any alternative. This term applies equally to photographers. Perhaps no bill which ever passed through parliament ostensibly for the purpose of benefiting a certain set of people has failed so completely as has this bill to accomplish its end. It started by proposing to give copyright to authors of paintings, drawings and photographs, and it would seem that no difficulty ought to have arisen as to whom such copyright should rightly belong; but the following clause of the act has introduced confusion into the question of ownership:—

Provided that when any painting, or drawing, or the negative of any photograph, shall for the first time after the passing of this act be sold or disposed of, or shall be made or executed for or on behalf of any other person for a good or valuable consideration, the person so selling or disposing of, or making or executing the same, shall not retain the copyright thereof unless it be expressly reserved to him by agreement in writing, signed at or before the time of such sale or disposition, by the vendee or assignee of such painting or drawing, or such negative of a photograph, or by the person on whose behalf the same shall be so made or executed; but the copyright shall belong to the vendee or assignee of such painting or drawing, or such negative of a photograph, or to the person for or on whose behalf the same shall have been made or executed; nor shall the vendee or assignee thereof be entitled to such copyright unless at or before the time of such sale or disposition an agreement in writing, signed by the person so selling or disposing of the same, or by his agent duly authorized, shall have been made to that effect.

That is to say, after promising the author copyright in his work for life and seven years, the act stipulates that in order to get it the author must, at the time of the first sale or disposition of his picture, obtain a document in writing from the purchaser of the picture, reserving the copyright to the author, and the act goes on to say that if he does not take this step the copyright becomes the property of the purchaser of the picture, but with the proviso, in order to secure it to him, he must have a document signed by the artist assigning the copyright to him; but if neither of these things is done, and no document is signed, the copyright does not belong to either the artist who sells or the client who buys, and the act is silent as to whom it does belong to. It has disappeared and belongs to no one. There is no copyright existing in the work for any one. It has passed into the public domain, and any one who can get access to the work may reproduce it. Now, as most purchases are made from the walls of exhibitions, in ninety-nine cases out of a hundred the copyright is absolutely lost. And where the sale is arranged directly between the artist and his client, the difficulty experienced by the artist in raising the question as to whom the copyright shall belong to is so great, owing to the dread lest the mere mention of the signing of a document should cause the selling of the picture to fall through, that in numerous such cases the copyright lapses and becomes public property. Photographers are not affected by this clause, because they do not as a rule sell the negatives they produce, and with them the copyright lies in the negative. They carry on their trade in prints without the question of the negative arising. The picture-dealer, also, who buys a picture and copyright is not subjected to the same disability as the painter. The picture-dealer can sell a picture without saying a word to his client as to the copyright, which he, nevertheless, retains intact; the provision is applicable only to the *first* sale of the work, which, therefore, throws the whole of the disability upon the painter.

The act gives the copyright of every work executed on commission to the person by whom it is commissioned. It makes it compulsory upon every owner of a copyright that he should register it at Stationers' Hall before he can take any action at law to protect it. The copyright does not lapse if unregistered, but so long as it remains unregistered no action at law can be

taken on account of any infringement. A copyright can be registered at any time, even after an infringement, but the owner of the copyright cannot recover for any infringement before registration. The act provides for both penalties and damages in the following cases:—(1) For infringing copyright in the ordinary way by issuing unlawful copies. (2) For fraudulently signing or affixing a fraudulent signature to a work of art. (3) For fraudulently dealing with a work so signed. (4) For fraudulently putting forth a copy of a work of art, whether there be copyright in it or no, as the original work of the artist. (5) For altering, adding to, or taking away from a work during the lifetime of the author if it is signed, and putting it forth as the unaltered work of the author. (6) For importing pirated works.

The incongruities of this act were so apparent that its promoters desired to stop it, feeling that it would be better to have no bill at all than one which conferred so little upon the people it was intended to benefit; but Lord Westbury, the lord chancellor, who had charge of the bill in the House of Lords, advised them to let it go through with all its imperfections, that they might get the right of the painter to protection recognized. This advice was followed, and the bill had no sooner become law than a fresh effort was started to have it amended. Year by year the agitation went on, with the exception only of a period when Irish affairs took up all the attention of parliament, and domestic legislation was rendered impossible. But in 1898 the Copyright Association of Great Britain promoted a bill, which was introduced into the House of Lords by Lord Herschell. It was a measure designed to deal with all forms of copyright—literary, musical, dramatic and artistic—and was remitted by the House of Lords for consideration to a committee, which, having sat for three sessions, decided not to proceed with Lord Herschell's measure, but to treat literature and art in separate bills. It had under its consideration an artistic bill, drafted for and presented by the Royal Academy, and a literary bill and an artistic bill drafted by the committee itself. The main proposals in the latter were to give copyright to the author of any artistic work or photograph for a period of life and thirty years, unless the work be commissioned, in which case the copyright was to be the property of the employer, except in the case of sculpture intended to be placed in a street or public place. The bill provided summary remedies for dealing with pirated works. It omitted altogether any reference to registration, and it provided for international copyright.

22. To sum up the position of artistic copyright in 1909, we find five British acts, three dealing with engraving, one with sculpture, and one with painting, drawing and photography, and between them very little relation. We have three terms of duration of copyright—28 years for engraving, 14 for sculpture, with a second 14 if the artist be alive at the end of the first, life and 7 years for painting, drawing or photography. There are two different relations of the artist to his copyright. The sculptor's right to sell his work and retain his copyright has never been questioned so long as he signs and dates it. The painter's copyright is made to depend upon the signing of a document by the purchaser of his work. The engraver and the sculptor are not required to register; but the author's name, and the date of putting forth or publishing, must appear on his work. The painter cannot protect his copyright without registration, but this registration as it is now required is merely a pitfall for the unwary. Designed to give the public information as to the ownership and duration of copyrights, the uncertainty of its operation results in the prevention of information on these very points.

The Berlin Convention of 1908 led to the appointment of a British committee to deal with its recommendations, and their report in 1909 foreshadowed important changes in the law both of literary and of artistic copyright, whenever Parliament should give its attention seriously to the subject.

Difficult and complicated as is the whole subject of artistic copyright, it is perhaps not to be wondered at that ignorance of the law on the subject is very widespread, even amongst those who are most interested in its action. One of the commonest beliefs amongst artists is, that all they have to do to secure copyright is to register a picture at Stationers' Hall; but the authorities at Stationers' Hall ask no questions, and simply enter any particulars submitted to them on their printed form. Some artists make a practice, when they send a picture away to exhibition, to fill up one of these forms, reserving the copyright by their entry to themselves, in

the belief that, if accompanied by the fee required by the Hall, its entry will reserve the copyright to them, oblivious of the fact that the only thing which can reserve the copyright to them is the possession of a document assigning the copyright to them by the purchaser of the picture. Another useless method of attempting to reserve artists' copyrights is that adopted by the promoters of public exhibitions, with whom it is an almost constant practice to print on some portion of the catalogue of the exhibition a statement that "copyrights of all pictures are reserved," the impression apparently prevailing that a notice of this kind effectively reserves the copyright for the artist while selling his picture from the walls. It, of course, does no such thing, and the copyright of any picture sold in these circumstances, without the necessary document from the purchaser, must be lost to the artist, and pass irrevocably into the public domain.

In a work of art the work itself and the copyright are two totally distinct properties, and may be held by different persons. The conditions differ materially from those of a work of literature, in which as a rule there is no value apart from publication. There is a value in a work of art for its private enjoyment quite apart from its commercial value in the form of reproductions; but when the two properties exist in different hands, the person holding the copyright has no power to force the owner of the work of art to give him access to it for purposes of reproduction; this can only be effected by private arrangement. It has been argued that, as the two properties are so distinct, the owner of the copyright ought to have the right of access to the picture for the purpose of exercising his right to reproduce it. But it is easy to see that it would destroy the value of art property if proprietors knew that at any moment they might be forced to surrender their work for the purpose of reproduction, though for a time only.

There is often a strong sympathy between the artist and the person who buys his picture, and it is not at all unusual, when application is made to the owner of the picture for access to it, for him to submit the question of reproduction to the artist. Although the latter may really have no right in it, it is felt, as a practical matter, that he is largely interested in the character of the reproduction it is proposed to make. Hence the courtesy which is usually extended to him.

Owing also to the increased facilities of reproduction, the practice has become very common of splitting up copyrights and granting licences in what may be described as very minute forms. It would, of course, be impossible for a publisher to pay an artist the sum at which he values his entire copyright, simply that he might reproduce his picture in the form of a black-and-white block in a magazine, and it has consequently become quite common for the artist to grant a licence for any and every particular form of reproduction as it may be required, so that he may grant the right of reproduction in one particular form in one particular publication, and even for a particular period of time, reserving to himself thus the right to grant similar licences to other publishers. This is apparently not to the injury of the artist; it is probably to his advantage, and it certainly promotes business.

23. The great obstacle in the way of securing a really good Artistic Bill has been the introduction into it of photography. It was by a sort of accident that the photographer was given the same privileges as the painter in the bill of 1862. The promoters of the bill thought that the photographer would be protected by the Engraving Acts which covered prints; but since the photographers feared that, as their prints were of a different character from the prints from a plate, the Engraving Acts might not protect them, it was at the last moment decided to put photography into the Art Bill. The result of this was that the painter lost his chance of copyright on all works executed on commission. Legislators feared that if photographers held copyright in all their works the public would have no protection from the annoyance of seeing the photographs of their wives and daughters exhibited and sold in shop windows by the side of "professional beauties" and other people, and

made articles of commerce. So in the case of commissioned works the copyright was denied to both painters and photographers.

The royal commission which reported on the subject in 1878 proposed two distinct terms of copyright for painting and photography. The term for the painter was dependent on his life; that for the photographer was a definitely fixed term of years from the date of publication of his photographs; and there can be little doubt that this is the right way to deal with the two branches of copyright. The artist who paints a picture signs it, and there is no difficulty in knowing who is the author of a painting and in whom the term of copyright is vested. In a very large number of cases a photograph is taken by an employee, who is here to-day and gone to-morrow, and even his employer knows nothing of his existence. Of course, it may suit an employer to be able to maintain secrecy as to the authorship of his negative, inasmuch as it enables him to go on claiming copyright fees indefinitely; but it is not to the public interest. In most countries on the continent of Europe a photographer has the fixed term of five years' copyright in an original photograph dating from its publication, which date, together with the name and address of the photographer, has to be stamped on every copy issued. In the public interest this is a good method of dealing with photographs.

24. The "authorship" of a photograph has been much debated in the law courts; and "author" was defined in *Nottage v. Jackson* (1883) as "the man who really represents or creates, or gives to ideas, or fancy, or imagination, true local habitation—the man in fact who is most nearly the effective cause of the representation" (*per* Lord Justice Bowen). He is not necessarily the owner of the camera, or the proprietor of the business; it depends on the circumstances. He is essentially the person who groups and effectively superintends the picture. When a photographer takes a portrait without fee, the copyright vests in him and not in the sitter, who cannot prevent its publication; but if the photograph is commissioned and paid for by the sitter the copyright—in the absence of contrary stipulations—vests in him, and he can restrain exhibition or multiplication of copies; "the bargain includes, by implication, an agreement that the prints taken from the negative are to be appropriated to the use of the customer only" (Mr Justice North in *Pollard v. Photographic Co.*, 1888). And this applies even when the sitter is not the actual purchaser of the negative (*Boucas v. Cooke*, 1903). But in several cases the "celebrity" who has sat to a photographer at his request and without payment has not been allowed to distribute his photograph to newspapers for reproduction without the photographer's consent. The fact that a sitter pays the photographer for prints, though he has not commissioned the sitting, would not vest the copyright in him.

25. The "Living Pictures" case in 1894 (*Hanfstängel v. Empire Palace*) was a curious one. The Empire music-hall in London produced some *tableaux vivants*, representing certain pictures, of which Messrs Hanfstängel owned the copyright, and an action was brought by them for an injunction. The courts of chancery and of appeal decided against the plaintiffs, on the ground that a reproduction of a painting must be by a painting or something cognate; but in an action for infringement, though the view already given was confirmed, the plaintiffs succeeded so far as the backgrounds to the grouping were concerned. Meanwhile two newspapers had published sketches of the same *tableaux vivants*, and Messrs Hanfstängel brought actions for infringement (*Hanfstängel v. News*, and *v. Baines*, 1894). Mr Justice Stirling found for the plaintiffs, but on appeal, and finally in the House of Lords, this decision was reversed.

26. *Copyright in Designs*.—An act of 1787 first gave protection to printed designs on linen and cotton fabrics; and in 1839 a further act included designs on animal fabrics, or mixed animal and vegetable fabrics; while in the same year another act protected designs for manufactured articles. These acts had been preceded in France by laws of 1737 and 1744 creating a property by law in manufacturers' designs. The British law, which in various acts established a copyright (a) in ornamental and (b) useful designs, was in 1883 consolidated in the

Patents, Designs and Trade Marks Act, with amending acts up to 1888; and these acts were further consolidated and amended by an act of 1905. See TRADE-MARKS and PATENTS.

#### BRITISH IMPERIAL COPYRIGHT BILL OF 1910

The consolidation of the British copyright law, not only in the United Kingdom but in the Dominions, and its amendment so as to include the recommendations of the Berlin International Convention of 1908, were the objects of a government bill introduced into parliament by the president of the Board of Trade on the 26th of July 1910, discussion on which was reserved for a later period in the year. The passing of this bill, though the date of it was uncertain owing to the peculiar circumstances of English politics at the moment, was practically assured by the facts that, apart altogether from the crying need for a revision of the English law, the draft had previously been considered and accepted, not only by a Board of Trade Committee which reported unanimously in favour of the recommendations of the Berlin Convention, but also by an Imperial Conference. The bill for the first time brought British copyright entirely under statutory law and consolidated and amended all previous enactments; it adopted the suggestions of the Imperial Conference (attended by representatives of Canada, Australia, South Africa, New Zealand and Newfoundland, other interests being covered by home representatives of the Foreign Office, India Office, Colonial Office and Board of Trade) as to providing for its extension by their declaration to the Dominions; and with its enactment a great simplification of the British law of copyright came in sight, though for historical reasons the details given above of the law as unamended must still remain of value.

Briefly, the new points of importance, apart from the placing of all copyright on a purely statutory basis and the inclusion of literary and artistic copyright within one arrangement, were as follows. All compulsory formalities of registration were abolished. The length of the period for which copyright lasted was extended to the life of the author and 50 years after. This reform was qualified, however, by a clause intended to protect the public from its abuse, and providing that after the author's death, if the work was withheld from the public or published at too high a price, or if the reasonable requirements of the public were not satisfied, a licence might be granted to publish or perform it. These changes applied to all the subject-matters of copyright, which were now put on the same level and treated uniformly. In certain cases, already discussed above, protection was extended: *e.g.* translations and lectures, original adaptations and arrangements, works of artistic novelty, including architectural designs; and the right to dramatize a novel or "novelize" a drama was conferred in each case on the author. Musical works were protected against unauthorized reproduction by mechanical means without payment; but protection was also extended to the mechanical record when authorized.

In including all sorts of intellectual product the bill followed the recommendation (resolution 6) of the Imperial Conference as to the definition of copyright (Parl. Paper Cd. 5272): "the Conference is of opinion that, subject to proper qualifications, copyright should include the sole right to produce or reproduce a work, or any substantial part thereof, in any material form whatsoever and in any language, to perform, or in the case of a lecture, to deliver, the work or any substantial part thereof in public, and, if the work is unpublished, to publish the work, and should include the sole right to dramatize novels and vice versa, and to make records, &c., by means of which a work may be mechanically performed." As to architecture and artistic crafts the Conference recommended (resolution 9) that "an original work of art should not lose the protection of artistic copyright solely because it consists of, or is embodied in, a work of architecture or craftsmanship; but it should be clearly understood that such protection is confined to its artistic form and does not extend to the processes or methods of reproduction, or to an industrial design capable of registration under the law relating to designs and destined to be multiplied by way of manufacture or trade."

As to the application of the new period of copyright to existing

works, the Conference recommended (resolution 10) "that existing works in which copyright actually subsists at the commencement of the new act (but no others) should enjoy, subject to existing rights, the same protection as future works, but the benefit of any extension of terms should belong to the author of the work, subject, in the case where he has assigned his existing rights, to a power on the part of the assignee at his option either to purchase the full benefit of the copyright during the extended term, or, without acquiring the full copyright, to continue to publish the work on payment of royalties, the payment in either case to be fixed by arbitration if necessary."

The Conference was also of opinion (resolution 4a) that, under the new Imperial Act, copyright should subsist only in works of which the author was a British subject or bona fide resident in one of the parts of the British Empire to which it extended; and that copyright should cease if the work were first published elsewhere than in such parts of the Empire.

The sensible basis on which the new bill was framed, and the authority it represented, commended it, in spite of many controversial points, to the acceptance both of the public and of the various parties concerned. But nobody who had ever wrestled with all the difficulties of international copyright, as complicated by the law in the United States, would suppose that it was the last word on the subject. What the bill did was to bring British legislation into better shape, and to amend it on certain points which had worked unjustly. The great distinction between the requirements for British and for American copyright still remained, namely, the American manufacturing clause. Perhaps the most notable innovation was the clause enabling a licence to be granted for the publication of a copyright work where the owners of the copyright had not exercised it for the "reasonable requirements" of the public. Some such clause was clearly called for when the period of monopoly was being extended; but the interpretation to be put upon the occasions which would justify such interference might well be difficult. It may perhaps be suggested that this innovation pointed to a reconsideration of the true relations of "publishers" and "authors" (in the widest sense) in respect of copyright, which sooner or later might be approached from a different point of view. The new clause was intended for the protection of the public from the mishandling of an author's work after his death, while greater protection was given him during his life. From a purely business point of view, the question might well be whether a publisher or other party not the author should have a copyright at all, and whether equity would not be satisfied if copyright vested solely in the author and his family, with liberty to any one to "publish" on fair terms, consideration being had to an original publisher's reasonable claims and existing contracts. The advisability of any such advance on the principle now asserted must depend rather on experience of actual business and the working of the clause; but even under the procedure provided by the bill of 1910 it would equally be imperative for a publisher who owned a deceased author's copyright to show that he had given or was giving the public valuable consideration for his monopoly, in order to uphold it against any one willing, on payment of a reasonable royalty, to serve the public better.

**AUTHORITIES.**—For special points see W. A. Copinger's *The Law of Copyright in Works of Literature and Art*, 4th ed., by J. M. Easton (1904); or T. E. Scrutton's *Law of Copyright* (3rd ed., 1896). See also E. J. MacGillivray, *A Treatise on the Law of Copyright* (1902); Richard Winslow, M.A., LL.B., *The Law of Artistic Copyright* (London, 1889); A. Birrell, *Copyright in Books* (London, 1899); B. A. Cohen, *Law of Copyright* (London, 1896); L. Edmunds, *Copyright in Designs* (London, 1908); Knox and Hind, *Copyright in Designs* (London, 1899); W. Briggs, *Law of International Copyright* (1906); W. M. Colles and H. Hardy, *Playright and Copyright in all Countries* (1906).

**COQUELIN, BENOÎT CONSTANT** (1841-1909), French actor, known as Coquelin *ainé*, was born at Boulogne on the 23rd of January 1841. He was originally intended to follow his father's trade of baker (he was once called *un boulanger manqué* by a hostile critic), but his love of acting led him to the Conservatoire, where he entered Regnier's class in 1859. He won the first prize for comedy within a year, and made his début on the 7th of December 1860 at the Comédie Française as the comic valet,

Gros-René, in Molière's *Dépit amoureux*, but his first great success was as Figaro, in the following year. He was made *sociétaire* in 1864, and during the next twenty-two years he created at the Français the leading parts in forty-four new plays, including Théodore de Banville's *Gringoire* (1867), Paul Ferrier's *Tabarin* (1871), Émile Augier's *Paul Forestier* (1871), *L'Étrangère* (1876) by the younger Dumas, Charles Lomon's *Jean Dacier* (1877), Edward Pailleron's *Le Monde où l'on s'ennuie* (1881), Erckmann and Chatrian's *Les Rantsau* (1884). In consequence of a dispute with the authorities over the question of his right to make provincial tours in France he resigned in 1886. Three years later, however, the breach was healed; and after a successful series of tours in Europe and the United States he rejoined the Comédie Française as *pensionnaire* in 1890. It was during this period that he took the part of Labussière, in the production of Sardou's *Thermidor*, which was interdicted by the government after three performances. In 1892 he broke definitely with the Comédie Française, and toured for some time through the capitals of Europe with a company of his own. In 1895 he joined the Renaissance theatre in Paris, and played there until he became director of the Porte Saint Martin in 1897. Here he won successes in Edmond Rostand's *Cyrano de Bergerac* (1897), Émile Bergerat's *Plus que reine* (1899), Catulle Mendès' *Scarron* (1905), and Alfred Capus and Lucien Descaves' *L'Attentat* (1906). In 1900 he toured in America with Sarah Bernhardt, and on their return continued with his old colleague to appear in *L'Aiglon*, at the Théâtre Sarah Bernhardt. He was rehearsing for the creation of the leading part in Rostand's *Chantecler*, which he was to produce, when he died suddenly in Paris, on the 27th of January 1909. Coquelin was an Officier de l'Instruction Publique and of the Legion of Honour. He published *L'Art et le comédien* (1880), *Molière et le misanthrope* (1881), essays on *Eugène Manuel* (1881) and *Sully-Prudhomme* (1882), *L'Arnolphe de Molière* (1882), *Les Comédiens* (1882), *L'Art de dire le monologue* (with his brother, 1884), *Tartuffe* (1884), *L'Art du comédien* (1894).

His brother, ERNEST ALEXANDRE HONORÉ COQUELIN (1848-1909), called Coquelin *cadet*, was born on the 16th of May 1848 at Boulogne, and entered the Conservatoire in 1864. He graduated with the first prize in comedy and made his début in 1867 at the Odéon. The next year he appeared with his brother at the Théâtre Français and became a *sociétaire* in 1879. He played a great many parts, in both the classic and the modern répertoire, and also had much success in reciting monologues of his own composition. He wrote *Le Livre des convalescents* (1880), *Le Monologue moderne* (1881), *Fairiboles* (1882), *Le Rire* (1887), *Pirouettes* (1888). He died on the 8th of February 1909.

JEAN COQUELIN (1865- ), son of Coquelin *ainé*, was also an actor, first at the Théâtre Français (début, 1890), later at the Renaissance, and then at the Porte Saint Martin, where he created the part of Raigoné in *Cyrano de Bergerac*.

**COQUEREL, ATHANASE JOSUÉ** (1820-1875), French Protestant divine, son of A. L. C. Coquerel (q.v.), was born at Amsterdam on the 16th of June 1820. He studied theology at Geneva and at Strassburg, and at an early age succeeded his uncle, C. A. Coquerel, as editor of *Le Lien*, a post which he held till 1870. In 1852 he took part in establishing the *Nouvelle Revue de théologie*, the first periodical of scientific theology published in France, and in the same year helped to found the "Historical Society of French Protestantism." Meanwhile he had gained a high reputation as a preacher, and especially as the advocate of religious freedom; but his teaching became more and more offensive to the orthodox party, and on the appearance (1864) of his article on Renan's *Vie de Jésus* in the *Nouvelle Revue de théologie* he was forbidden by the Paris consistory to continue his ministerial functions. He received an address of sympathy from the consistory of Anduze, and a provision was voted for him by the Union Protestante Libérale, to enable him to continue his preaching. He received the cross of the Legion of Honour in 1862. He died at Fismes (Marne), on the 24th of July 1875. His chief works were *Jean Calas et sa famille* (1858); *Des Beaux-Arts en Italie* (Eng. trans. 1859); *La Saint Barthélemy* (1860); *Précis de l'église réformée* (1862);

*Le Catholicisme et le protestantisme considérés dans leur origine et leur développement* (1864); *Libres études*, and *La Conscience et la foi* (1867).

**COQUEREL, ATHANASE LAURENT CHARLES** (1795-1868), French Protestant divine, was born in Paris on the 17th of August 1795. He received his early education from his aunt, Helen Maria Williams, an Englishwoman, who at the close of the 18th century gained a reputation by various translations and by her *Letters from France*. He completed his theological studies at the Protestant seminary of Montauban, and in 1816 was ordained minister. In 1817 he was invited to become pastor of the chapel of St Paul at Jersey, but he declined, being unwilling to subscribe to the Thirty-nine Articles of the Church of England. During the following twelve years he resided in Holland, and preached before Calvinistic congregations at Amsterdam, Leiden and Utrecht. In 1830, at the suggestion of Baron Georges de Cuvier, then minister of Protestant worship, Coquerel was called to Paris as pastor of the Reformed Church. In the course of 1833 he was chosen a member of the consistory, and rapidly acquired the reputation of a great pulpit orator, but his liberal views brought him into antagonism with the rigid Calvinists. He took a warm interest in all matters of education, and distinguished himself so much by his defence of the university of Paris against a sharp attack, that in 1835 he was chosen a member of the consistory of the Legion of Honour. In 1841 appeared his *Réponse to the Leben Jesu* of Strauss. After the revolution of February 1848, Coquerel was elected a member of the National Assembly, where he sat as a moderate republican, subsequently becoming a member of the Legislative Assembly. He supported the first ministry of Louis Napoleon, and gave his vote in favour of the expedition to Rome and the restoration of the temporal power of the pope. After the *coup d'état* of the 2nd of December 1851, he confined himself to the duties of his pastorate. He was a prolific writer, as well as a popular and eloquent speaker. He died at Paris on the 10th of January 1868. A large collection of his sermons was published in 8 vols. between 1819 and 1852. Other works were *Biographie sacrée* (1825-1826); *Histoire sainte et analyse de la Bible* (1839); *Orthodoxie moderne* (1842); *Christologie* (1858), &c.

His brother, **CHARLES AUGUSTIN COQUEREL** (1797-1851), was the author of a work on English literature (1828), an *Essai sur l'histoire générale du christianisme* (1828) and a *Histoire des églises du désert, depuis la revocation de l'édit de Nantes* (1841). A liberal in his views, he was the founder and editor of the *Annales protestantes*, *Le Lien*, and the *Revue protestante*.

**COQUES** (or **COCX**), **GONZALEZ** (1614-1684), Flemish painter, son of Pieter Willemsen Cox, a respectable Flemish citizen, and not, as his name might imply, a Spaniard, was born at Antwerp. At the age of twelve he entered the house of Pieter, the son of "Hell" Breughel, an obscure portrait painter, and at the expiration of his time as an apprentice became a journeyman in the workshop of David Ryckaert the second, under whom he made accurate studies of still life. At twenty-six he matriculated in the gild of St Luke; he then married Ryckaert's daughter, and in 1653 joined the literary and dramatic club known as the "Retorijkerkamer." After having been made president of his gild in 1665, and in 1671 painter in ordinary to Count Monterey, governor-general of the Low Countries, he married again in 1674, and died full of honours in his native place. One of his canvases in the gallery at the Hague represents a suite of rooms hung with pictures, in which the artist himself may be seen at a table with his wife and two children, surrounded by masterpieces composed and signed by several contemporaries. Partnership in painting was common amongst the small masters of the Antwerp school; and it has been truly said of Coques that he employed Jacob von Arthois for landscapes, Ghering and van Ehrenberg for architectural backgrounds, Steenwijck the younger for rooms, and Pieter Gysels for still life and flowers; but the model upon which Coques formed himself was Van Dyck, whose sparkling touch and refined manner he imitated with great success. He never ventured beyond the "cabinet," but in this limited field the family groups of his middle time are full of life,

brilliant from the sheen of costly dress and sparkling play of light and shade, combined with finished execution and enamelled surface.

**COQUET** (pronounced Cocket), a river of Northumberland, draining a beautiful valley about 40 m. in length. It rises in the Cheviot Hills. Following a course generally easterly, but greatly winding, it passes Harbottle, near which relics of the Stone Age are seen, and Holystone, where it is recorded that Bishop Paulinus baptized a great body of Northumbrians in the year 627. Several earthworks crown hills above this part of the valley, and at Cartington, Fosson and Whitton are relics of medieval border fortifications. The small town of Rothbury is beautifully situated beneath the rugged Simonside Hills. The river dashes through a narrow gully called the Thrum, and then passes Brinkburn priory, of which the fine Transitional Norman church was restored to use in 1858, while there are fragments of the monastic buildings. This was an Augustinian foundation of the time of Henry I. The dale continues well wooded and very beautiful until Warkworth is reached, with its fine castle and remarkable hermitage. A short distance below this the Coquet has its mouth in Alnwick Bay (North Sea), with the small port of Amble on the south bank, and Coquet Island a mile out to sea. The river is frequented by sportsmen for salmon and trout fishing. No important tributary is received, and the drainage area does not exceed 240 sq. m.

**COQUET** (pronounced co-kétte), to simulate the arts of love-making, generally from motives of personal vanity, to flirt; in a figurative sense, to trifle or dilly-dally with anything. The word is derived from the French *coqueter*, which originally means, "to strut about like a cock-bird," i.e. when it desires to attract the hens. The French substantive *coquet*, in the sense of "beau" or "lady-killer," was formerly commonly used in English; but the feminine form, *coquette*, now practically alone survives, in the sense of a woman who gratifies her vanity by using her powers of attraction in a frivolous or inconstant fashion. Hence "to coquet," the original and more correct form, has come frequently to be written "to coquette." Coquetry (Fr. *coquetterie*), primarily the art of the coquette, is used figuratively of any dilly-dallying or "coqueting" and, by transference of idea, of any superficial qualities of attraction in persons or things. "Coquet" is still also occasionally used adjectivally, but the more usual form is "coquettish"; e.g. we speak of a "coquettish manner," or a "coquettish hat." The crested humming-birds of the genus *Lophornis* are known as coquettes (Fr. *coquets*).

**COQUIMBO**, an important city and port of the province and department of Coquimbo, Chile, in 29° 57' 4" S., 71° 21' 12" W. Pop. (1895) 7322. The railway connexions are with Ovalle to the S., and Vicuña (or Elqui) to the E., but the proposed extension northward of Chile's longitudinal system would bring Coquimbo into direct communication with Santiago. The city has a good well-sheltered harbour, reputed the best in northern Chile, and is the port of La Serena, the provincial capital, 9 m. distant, with which it is connected by rail. There are large copper-smelting establishments in the city, which exports a very large amount of copper, some gold and silver, and cattle and hay to the more northern provinces.

The province of Coquimbo, which lies between those of Aconcagua and Atacama and extends from the Pacific inland to the Argentine frontier, has an area of 13,461 sq. m. (official estimate) and a population (1895) of 160,898. It is less arid than the province of Atacama, the surface near the coast being broken by well-watered river valleys, which produce alfalfa, and pasture cattle for export. Near the mountains grapes are grown, from which wine of a good quality is made. The mineral resources include extensive deposits of copper, and some less important mines of gold and silver. The climate is dry and healthy, and there are occasional rains. Several rivers, the largest of which is the Coquimbo (or Elqui) with a length of 125 m., cross the province from the mountains. The capital is La Serena, and the principal cities are Coquimbo, Ovalle (pop. 5565), and Illapel (3170).



**CORACLE** (Welsh *corwg-l*, from *corwg*, cf. Irish and mod. Gaelic *curach*, boat), a species of ancient British fishing-boat which is still extensively used on the Severn and other rivers of Wales, notably on the Towy and Teifi. It is a light boat, oval in shape, and formed of canvas stretched on a framework of split and interwoven rods, and well-coated with tar and pitch to render it water-tight. According to early writers the framework was covered with horse or bullock hide (*corium*). So light and portable are these boats that they can easily be carried on the fisherman's shoulders when proceeding to and from his work. Coracle-fishing is performed by two men, each seated in his coracle and with one hand holding the net while with the other he plies his paddle. When a fish is caught, each hauls up his end of the net until the two coracles are brought to touch and the fish is then secured. The coracle forms a unique link between the modern life of Wales and its remote past; for this primitive type of boat was in existence amongst the Britons at the time of the invasion of Julius Caesar, who has left a description of it, and even employed it in his Spanish campaign.

**CORAIUS** (KORAIUS, **ADAMANTIOS** [in French, **DIAMANT CORAY**] (1748–1833), Greek scholar and patriot, was born at Smyrna, the son of a merchant. As a schoolboy he distinguished himself in the study of ancient Greek, but from 1772 to 1779 he was occupied with the management of his father's business affairs in Amsterdam. In 1782, on the collapse of his father's business, he went to Montpellier, where for six years he studied medicine, supporting himself by translating German and English medical works into French. He then settled in Paris, where he lived until his death on the 10th of April 1833. Inspired by the ideals of the French Revolution, he devoted himself to furthering the cause of Greek independence both among the Greeks themselves and by awakening the interest of the chief European Powers against the Turkish rule. His great object was to rouse the enthusiasm of the Greeks for the idea that they were the true descendants of the ancient Hellenes by teaching them to regard as their own inheritance the great works of antiquity. He sought to purify the ordinary written language by eliminating the more obvious barbarisms, and by enriching it with classical words and others invented in strict accordance with classical tradition (see further **GREEK LANGUAGE: modern**). Under his influence, though the common patois was practically untouched, the language of literature and intellectual intercourse was made to approximate to the pure Attic of the 5th and 4th centuries B.C. His chief works are his editions of Greek authors contained in his 'Ελληνική Βιβλιοθήκη and his Πάρεργα; his editions of the *Characters* of Theophrastus, of the *De aëre, aquis, et locis* of Hippocrates, and of the *Aethiopica* of Heliodorus, elaborately annotated.

His literary remains have been edited by Mamoukas and Damalas (1881–1887); collections of letters written from Paris at the time of the French Revolution have been published (in English, by P. Ralli, 1898; in French, by the Marquis de Queux de Saint-Hilaire, 1880). His autobiography appeared at Paris (1829; Athens, 1891), and his life has been written by D. Thereianos (1889–1890); see also A. R. Rhangabé, *Histoire littéraire de la Grèce moderne* (1877).

**CORAL**, the hard skeletons of various marine organisms. It is chiefly carbonate of lime, and is secreted from sea-water and deposited in the tissues of Anthozoan polyps, the principal source of the coral-reefs of the world (see **ANTHOZOA**), of Hydroids (see **HYDROMEDUSAE**), less important in modern reef-building, but extremely abundant in Palaeozoic times, and of certain Algae. The skeletons of many other organisms, such as Polyzoa and Mollusca, contribute to coral masses but cannot be included in the term "coral." The structure of coral animals (sometimes erroneously termed "coral insects") is dealt with in the articles cited above; for the distribution and formation of reefs see **CORAL-REEFS**.

Beyond their general utility and value as sources of lime, few of the corals present any special feature of industrial importance, excepting the red or precious coral (*Corallium rubrum*) of the Mediterranean Sea. It, however, is and has been from remote times very highly prized for jewelry, personal ornamentation and decorative purposes generally. About the

beginning of the Christian era a great trade was carried on in coral between the Mediterranean and India, where it was highly esteemed as a substance endowed with mysterious sacred properties. It is remarked by Pliny that, previous to the existence of the Indian demand, the Gauls were in the habit of using it for the ornamentation of their weapons of war and helmets; but in his day, so great was the Eastern demand, that it was very rarely seen even in the regions which produced it. Among the Romans branches of coral were hung around children's necks to preserve them from danger, and the substance had many medicinal virtues attributed to it. A belief in its potency as a charm continued to be entertained throughout medieval times; and even to the present day in Italy it is worn as a preservative from the evil eye, and by females as a cure for sterility.

The precious coral is found widespread on the borders and around the islands of the Mediterranean Sea. It ranges in depth from shallow water (25 to 50 ft.) to water over 1000 ft., but the most abundant beds are in the shallower areas. The most important fisheries extend along the coasts of Tunisia, Algeria and Morocco; but red coral is also obtained in the vicinity of Naples, near Leghorn and Genoa, and on the coasts of Sardinia, Corsica, Catalonia and Provence. It occurs also in the Atlantic off the north-west of Africa, and recently it has been dredged in deep water off the west of Ireland. Allied species of small commercial value have been obtained off Mauritius and near Japan. The black coral (*Antipathes abies*), formerly abundant in the Persian Gulf, and for which India is the chief market, has a wide distribution and grows to a considerable height and thickness in the tropical waters of the Great Barrier Reef of Australia.

From the middle ages downwards the securing of the right to the coral fisheries on the African coasts was an object of considerable rivalry among the Mediterranean communities of Europe. Previous to the 16th century they were controlled by the Italian republics. For a short period the Tunisian fisheries were secured by Charles V. to Spain; but the monopoly soon fell into the hands of the French, who held the right till the Revolutionary government in 1793 threw the trade open. For a short period (about 1806) the British government controlled the fisheries, and now they are again in the hands of the French authorities. Previous to the French Revolution much of the coral trade centred in Marseilles; but since that period, both the procuring of the raw material and the working of it up into the various forms in which it is used have become peculiarly Italian industries, centring largely in Naples, Rome and Genoa. On the Algerian coast, however, boats not flying the French flag have to pay heavy dues for the right to fish, and in the early years of the 20th century the once flourishing fisheries at La Calle were almost entirely neglected. Two classes of boats engage in the pursuit—a large size of from 12 to 14 tons, manned by ten or twelve hands, and a small size of 3 or 4 tons, with a crew of five or six. The large boats, dredging from March to October, collect from 650 to 850 lb of coral, and the small, working throughout the year, collect from 390 to 500 lb. The Algerian reefs are divided into ten portions, of which only one is fished annually—ten years being considered sufficient for the proper growth of the coral.

The range of value of the various qualities of coral, according to colour and size, is exceedingly wide, and notwithstanding the steady Oriental demand its price is considerably affected by the fluctuations of fashion. While the price of the finest tints of rose pink may range from £80 to £120 per oz., ordinary red-coloured small pieces sell for about £2 per oz., and the small fragments called *collette*, used for children's necklaces, cost about 5s. per oz. In China large spheres of good coloured coral command high prices, being in great requisition for the button of office worn by the mandarins. It also finds a ready market throughout India and in Central Asia; and with the negroes of Central Africa and of America it is a favourite ornamental substance.

**CORALLIAN** (Fr. *Corallien*), in geology, the name of one of the divisions of the Jurassic rocks. The rocks forming this division



are mainly calcareous grits with oolites, and rubbly coral rock—often called “Coral Rag”; ferruginous beds are fairly common, and occasionally there are beds of clay. In England the Corallian strata are usually divided into an upper series, characterized by the ammonite *Perisphinctes plicatilis*, and a lower series with *Aspidoceras perarmatus* as the zonal fossil. When well developed these beds are seen to lie above the Oxford Clay and below the Kimeridge Clay; but it will save a good deal of confusion if it is recognized that the Corallian rocks of England are nothing more than a variable, local lithological phase of the two clays which come respectively above and below them. This caution is particularly necessary when any attempt is being made to co-ordinate the English with the continental Corallian.

The Corallian rocks are nowhere better displayed than in the cliffs at Weymouth. Here Messrs Blake and Huddleston recognized the following beds:—

Upper Corallian	}	Upper Coral Rag and Abbotsbury Iron Ore.
		Sandsfoot Grits.
		Sandsfoot Clay.
		Trigonia Beds.
Lower Corallian	}	Osmington Oolite (quarried at Marnhull and Todbere).
		Bencliff Grits.
		Nothe Clay.
		Nothe Grit.

In Dorsetshire the Corallian rocks are 200 ft. thick, in Wiltshire 100 ft., but N.E. of Oxford they are represented mainly by clays, and the series is much thinner. (At Upware, the “Upware limestone” is the only known occurrence of beds that correspond in character with the Coralline oolite between Wiltshire and Yorkshire). In Yorkshire, however, the hard rocky beds come on again in full force. They appear once more at Brora in Sutherlandshire. Corallian strata have been proved by boring in Sussex (241 ft.). In Huntingdon, Bedfordshire, parts of Buckinghamshire, Cambridgeshire and Lincolnshire the Corallian series is represented by the “Amphill Clay,” which has also been called “Bluntesham” or “Tetworth” Clay. Here and there in this district hard calcareous inconstant beds appear, such as the Elsworth rock, St Ives rock and Boxworth rock.

In Yorkshire the Corallian rocks differ in many respects from their southern equivalents. They are subdivided as follows:—

Kimeridge Clay	}	Corallian Rock “Coralline Oolite”	Upper Calcareous Grit	} <i>A. plicatilis.</i>
			Coral Rag and Upper Lime- stone	
			Middle Calcareous Grit	
Oxford Clay	}	“Coralline Oolite”	Lower Limestone	} <i>A. perarmatus.</i>
			Passage Beds	
			Lower Calcareous Grit	

These rocks play an important part in the formation of the Vale of Pickering, and the Hambleton and Howardian Hills; they are well exposed in Gristhorpe Bay.

The passage beds, highly siliceous, flaggy limestones, are known locally as “Greystone” or “Wall stones”; some portions of these beds have resisted the weathering agencies and stand up prominently on the moors—such are the “Bridestones.” Cement stone beds occur in the upper calcareous grit at North Grimstone; and in the middle and lower calcareous grits good building stones are found.

Among the fossils in the English Corallian rocks corals play an important part, frequently forming large calcareous masses or “doggers”; *Thamnastrea*, *Thecosmilia* and *Isastrea* are prominent genera. Ammonites and belemnites are abundant and gasteropods are very common (*Nerinea*, *Chemnitzia*, *Bourgetia*, &c.). *Trigonia*s are very numerous in certain beds (*T. perlata* and *T. mariani*). *Astarte ovata*, *Lucina aliena* and other pelecypods are also abundant. The echinoderms *Echinobrissus scutatus* and *Cidaris florigemma* are characteristic of these beds.

Rocks of the same age as the English Corallian are widely spread over Europe, but owing to the absence of clearly-marked stratigraphical and palaeontological boundaries, the nomenclature has become greatly involved, and there is now a tendency amongst continental geologists to omit the term Corallian altogether. According to A. de Lapparent’s classification the

English Corallian rocks are represented by the *Séquanien* stage, with two substages, an upper *Astartien* and lower *Rauracien*; but this does not include the whole Corallian stage as defined above, the lower part being placed by the French author in his *Oxfordien* stage. For the table showing the relative position of these stages see the article JURASSIC.

See also “The Jurassic Rocks of Great Britain,” vol. i. (1892) and vol. v. (1895) (*Memoirs of the Geological Survey*); Blake and Huddleston, “On the Corallian Rocks of England,” *Q.J.G.S.* vol. xxxiii. (1877). (J. A. H.)

**CORAL-REEFS.** Many species of coral (*q.v.*) are widely distributed, and are found at all depths both in warmer and colder seas. *Lophohelia prolifera* and *Dendrophyllia ramea* form dense beds at a depth of from 100 to 200 fathoms off the coasts of Norway, Scotland and Portugal, and the “*Challenger*,” and other deep-sea dredging expeditions have brought up corals from great depths in the Pacific and Atlantic oceans. But the larger number of species, particularly the more massive kinds, occur only in tropical seas in shallow waters, whose mean temperature does not fall below 68° Fabr., and they do not flourish unless the temperature is considerably higher. These conditions of temperature are found in a belt of ocean which may roughly be indicated as lying between the 28th N. and S. parallels. Within these limits there are numerous reefs and islands formed of coral intermixed with the calcareous skeletons of other animals, and their formation has long been a matter of dispute among naturalists and geologists.

Coral formations may be classed as fringing or shore reefs, barrier reefs and atolls. *Fringing reefs* are platforms of coral rock extending no great distance from the shores of a continent or island. The seaward edge of the platform is usually somewhat higher than the inner part, and is often awash at low water. It is intersected by numerous creeks and channels, especially opposite those places where streams of fresh water flow down from the land, and there is usually a channel deep enough to be navigable by small boats between the edge of the reef and the land. The outer wall of the reef is rather steep, but descends into a comparatively shallow sea. Since corals are killed by fresh water or by deposition of mud or sand, it is obvious that the outer edge of the reef is the region of most active coral growth, and the boat channel and the passages leading into it from the open sea have been formed by the suppression of coral growth by one of the above-mentioned causes, assisted by the scour of the tides and the solvent action of sea-water. *Barrier reefs* may be regarded as fringing reefs on a large scale. The great Australian barrier reef extends for no less a distance than 1250 m. from Torres Strait in 9.5° S. lat. to Lady Elliot island in 24° S. lat. The outer edge of a barrier reef is much farther from the shore than that of a fringing reef, and the channel between it and the land is much deeper. Opposite Cape York the seaward edge of the great Australian barrier reef is nearly 90 m. distant from the coast, and the maximum depth of the channel at this point is nearly 20 fathoms. As is the case in a fringing reef, the outer edge of a barrier reef is in many places awash at low tides, and masses of dead coral and sand may be piled up on it by the action of the waves, so that islets are formed which in time are covered with vegetation. These islets may coalesce and form a strip of dry land lying some hundred yards or less from the extreme outer edge of the reef, and separated by a wide channel from the mainland. Where the barrier reef is not far from the land there are always gaps in it opposite the mouths of rivers or considerable streams. The outer wall of a barrier reef is steep, and frequently, though not always, descends abruptly into great depths. In many cases in the Pacific Ocean a barrier reef surrounds one or more island peaks, and the strips of land on the edge of the reef may encircle the peaks with a nearly complete ring. An *atoll* is a ring-shaped reef, either awash at low tide or surmounted by several islets, or more rarely by a complete strip of dry land surrounding a central lagoon. The outer wall of an atoll generally descends with a very steep but irregular slope to a depth of 500 fathoms or more, but the lagoon is seldom more than 20 fathoms deep, and may be much less. Frequently, especially to the

leeward side of an atoll, there may be one or more navigable passages leading from the lagoon to the open sea.

Though corals flourish everywhere under suitable conditions in tropical seas, coral reefs and atolls are by no means universal in the torrid zone. The Atlantic Ocean is remarkably free from coral formations, though there are numerous reefs in the West Indian islands, off the south coast of Florida, and on the coast of Brazil. The Bermudas also are coral formations, their high land being formed by sand accumulated by the wind and cemented into rock, and are remarkable for being the farthest removed from the equator of any recent reefs, being situated in  $32^{\circ}$  N. lat. In the Pacific Ocean there is a vast area thickly dotted with coral formations, extending from  $5^{\circ}$  N. lat. to  $25^{\circ}$  S. lat., and from  $130^{\circ}$  E. long. to  $145^{\circ}$  W. long. There are also extensive reefs in the westernmost islands of the Hawaiian group in about  $25^{\circ}$  N. lat. In the Indian Ocean, the Laccadive and Maldive islands are large groups of atolls off the west and south-west of India. Still farther south is the Chagos group of atolls, and there are numerous reefs off the north coast of Madagascar, at Mauritius, Bourbon and the Seychelles. The Cocos-Keeling Islands, in  $12^{\circ}$  S. lat. and  $96^{\circ}$  E. long., are typical atolls in the eastern part of the Indian Ocean.

The remarkable characters of barrier reefs and atolls, their isolated position in the midst of the great oceans the seemingly unfathomable depths from which they rise their peaceful and shallow lagoons and inner channels, their narrow strips of land covered with coco-nut palms and other vegetation, and rising but a few feet above the level of the ocean, naturally attracted the attention of the earlier navigators, who formed sundry speculations as to their origin. The poet-naturalist, A. von Chamisso, was the first to propound a definite theory of the origin of atolls and encircling reefs, attributing their peculiar features to the natural growth of corals and the action of the waves. He pointed out that the larger and more massive species of corals flourish best on the outer sides of a reef, whilst the more interior corals are killed or stunted in growth by the accumulation of coral and other debris. Thus the outer edge of a submerged reef is the first to reach the surface, and a ring of land being formed by materials piled up by the waves, an atoll with a central lagoon is produced. Chamisso's theory necessarily assumed the existence of a great number of submerged banks reaching nearly, but not quite, to the surface of the sea in the Pacific and Indian oceans, and the difficulty of accounting for the existence of so many of these led C. Darwin to reject his views and bring forward an explanation which may be called the theory of *subsidence*. Starting from the well-known premise that reef-building species of corals do not flourish in a greater depth of water than 20 fathoms, Darwin argued that all

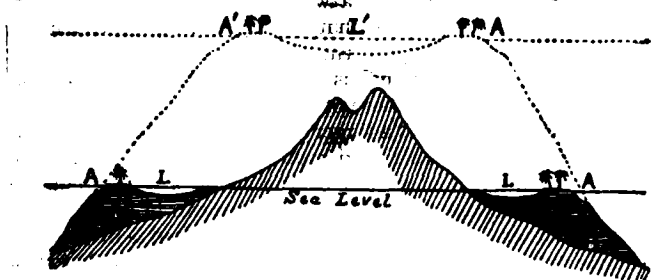

Diagram showing the formation of an atoll during subsidence. (After C. Darwin.) The lower part of the figure represents a barrier reef surrounding a central peak.

A, A, outer edges of the barrier reef at the sea-level; the coco-nut trees indicate dry land formed on the edges of the reef.

L, L, lagoon channel.

A', A', outer edges of the atoll formed by upgrowth of the coral during the subsidence of the peak.

L', lagoon of the atoll.

The vertical scale is considerably exaggerated as compared with the horizontal scale.

coral islands must have a rocky base, and that it was inconceivable that, in such large tracts of sea as occur in the Pacific and Indian oceans, there should be a vast number of submarine peaks or banks all rising to within 20 or 30 fathoms of the surface and none emerging above it. But on the supposition that the atolls and

encircling reefs were formed round land which was undergoing a slow movement of subsidence, their structure could easily be explained. Take the case of an island consisting of a single high peak. At first the coral growth would form a fringing reef clinging to its shores. As the island slowly subsided into the ocean the upward growth of coral would keep the outer rim of the reef level with or within a few fathoms of the surface, so that, as subsidence proceeded, the distance between the outer rim of the reef and the sinking land would continually increase, with the result that a barrier-reef would be formed separated by a wide channel from the central peak. As corals and other organisms with calcareous skeletons live in the channel, their remains, as well as the accumulation of coral and other debris thrown over the outer edge of the reef, would maintain the channel at a shallower depth than that of the ocean outside. Finally, if the subsidence continued, the central peak would disappear beneath the surface, and an atoll would be left consisting of a raised margin of reef surrounding a central lagoon, and any pause during the movement of subsidence would result in the formation of raised islets or a strip of dry land along the margin of the reef. Darwin's theory was published in 1842, and found almost universal acceptance, both because of its simplicity and its applicability to every known type of coral-reef formation, including such difficult cases as the Great Chagos Bank, a huge submerged atoll in the Indian Ocean.

Darwin's theory was adopted and strengthened by J. D. Dana, who had made extensive observations among the Pacific coral reefs between 1838 and 1842, but it was not long before it was attacked by other observers. In 1851 Louis Agassiz produced evidence to show that the reefs off the south coast of Florida were not formed during subsidence, and in 1863 Karl Semper showed that in the Pelew islands there is abundant evidence of recent upheaval in a region where both atolls and barrier-reefs exist. Latterly, many instances of recently upraised coral formations have been described by H. B. Guppy, J. S. Gardiner and others, and Alexander Agassiz and Sir J. Murray have brought forward a mass of evidence tending to shake the subsidence theory to its foundations. Murray has pointed out that the deep-sea soundings of the "Tuscarora" and "Challenger" have proved the existence of a large number of submarine elevations rising out of a depth of 2000 fathoms or more to within a few hundred fathoms of the surface. The existence of such banks was unknown to Darwin, and removes his objections to Chamisso's theory. For although they may at first be too far below the surface for reef-building corals, they afford a habitat for numerous echinoderms, molluscs, crustacea and deep-sea corals, whose skeletons accumulate on their summits, and they further receive a constant rain of the calcareous and silicious skeletons of minute organisms which teem in the waters above. By these agencies the banks are gradually raised to the lowest depth at which reef-building corals can flourish, and once these establish themselves they will grow more rapidly on the periphery of the bank, because they are more favourably situated as regards food-supply. Thus the reef will rise to the surface as an atoll, and the nearer it approaches the surface the more will the corals on the exterior faces be favoured, and the more will those in the centre of the reef decrease, for experiment has shown that the minute pelagic organisms on which corals feed are far less abundant in a lagoon than in the sea outside. Eventually, as the margin of the reef rises to the surface and material is accumulated upon it to form islets or continuous land, the coral growth in the lagoon will be feeble, and the solvent action of sea-water and the scour of the tide will tend to deepen the lagoon. Thus the considerable depth of some lagoons, amounting to 40 or 50 fathoms, may be accounted for. The observations of Guppy in the Solomon islands have gone far to confirm Murray's conclusions, since he found in the islands of Ugi, Santa Anna and Treasury and Stirling islands unmistakable evidences of a nucleus of volcanic rock, covered with soft earthy bedded deposits several hundred feet thick. These deposits are highly fossiliferous in parts, and contain the remains of pteropods, lamellibranchs and echinoderms, embedded in a foraminiferous deposit mixed with volcanic debris, like the deep-sea muds brought up by

the "Challenger." The flanks of these elevated beds are covered with coralline limestone rocks varying from 100 to 16 ft. in thickness. One of the islands, Santa Anna, has the form of an upraised atoll, with a mass of coral limestone 80 ft. in vertical thickness, resting on a friable and sparingly argillaceous rock resembling a deep-sea deposit. A. Agassiz, in a number of important researches on the Florida reefs, the Bahamas, the Bermudas, the Fiji islands and the Great Barrier Reef of Australia, has further shown that many of the peculiar features of these coral formations cannot be explained on the theory of subsidence, but are rather attributable to the natural growth of corals on banks formed by prevailing currents, or on extensive shore platforms or submarine flats formed by the erosion of pre-existing land surfaces.

In face of this accumulated evidence, it must be admitted that the subsidence theory of Darwin is inapplicable to a large number of coral reefs and islands, but it is hardly possible to assert, as Murray does, that no atolls or barrier reefs have ever been developed after the manner indicated by Darwin. The most recent research on the structure of coral reefs has also been the most thorough and most convincing. It is obvious that, if Murray's theory were correct, a bore hole sunk deep into an atoll would pass through some 100 ft. of coral rock, then through a greater or less thickness of argillaceous rock, and finally would penetrate the volcanic rock on which the other materials were deposited. If Darwin's theory is correct, the boring would pass through a great thickness of coral rock, and finally, if it went deep enough, would pass into the original rock which subsided below the waters. An expedition sent out by the Royal Society of London started in 1896 for the island of Funafuti, a typical atoll of the Ellice group in the Pacific Ocean, with the purpose of making a deep boring to test this question. The first attempt was not successful, for at a depth of 105 ft. the refractory nature of the rock stopped further progress. But a second attempt, under the management of Professor Edgeworth David of Sydney, proved a complete success. With improved apparatus, the boring was carried down to a depth of 697 ft. (116 fathoms), and a third attempt carried it down to 1114 ft. (185 fathoms). The boring proves the existence of a mass of pure limestone of organic origin to the depth of 1114 ft., and there is no trace of any other rock. The organic remains found in the core brought up by the drill consist of corals, foraminifera, calcareous algae and other organisms. A boring was also made from the deck of a ship into the floor of the lagoon, which shows that under 100 ft. of water there exists at the bottom of the lagoon a deposit more than 100 ft. thick, consisting of the remains of a calcareous alga, *Halimeda opuntia*, mixed with abundant foraminifera. At greater depths, down to 245 ft., the same materials, mixed with the remains of branching madreporae, were met with, and further progress was stopped by the existence of solid masses of coral, fragments of porites, madrepora and heliopora having been brought up in the core. These are shallow-water corals, and their existence at a depth of nearly 46 fathoms, buried beneath a mass of *Halimeda* and foraminifera, is clear evidence of recent subsidence. *Halimeda* grows abundantly over the floor of the lagoon of Funafuti, and has been observed in many other lagoons. The writer collected a quantity of it in the lagoon of Diego Garcia in the Chagos group. The boring demonstrates that the lagoon of Funafuti has been filled up to an extent of at least 245 ft. (nearly 41 fathoms), and this fact accords well with Darwin's theory, but is incompatible with that of Murray. In the present state of our knowledge it seems reasonable to conclude that coral reefs are formed wherever the conditions suitable for growth exist, whether in areas of subsidence, elevation or rest. A considerable number of reefs, at all events, have not been formed in areas of subsidence, and of these the Florida reefs, the Bermudas, the Solomon islands, and possibly the Great Barrier Reef of Australia are examples. Funafuti would appear to have been formed in an area of subsidence, and it is quite probable that the large groups of low-lying islands in the Pacific and Indian oceans have been formed under the same conditions. At the same time, it must be remembered that the atoll or barrier

reef shape is not necessarily evidence of formation during subsidence, for the observations of Karl Semper, A. Agassiz, and Guppy are sufficient to prove that these forms of reefs may be produced by the natural growth of coral, modified by the action of waves and currents in regions in which subsidence has certainly not taken place.

See A. Agassiz, many publications in the *Mem. Amer. Acad.* (1883) and *Bull. Mus. Comp. Zool.* (Harvard, 1889-1899); J. D. Dana, *Corals and Coral Islands* (1853; 2nd ed., 1872; 3rd ed., 1890); C. Darwin, *The Structure and Distribution of Coral Reefs* (3rd ed., 1889); H. B. Guppy, "The Recent Calcareous Formations of the Solomon Group," *Trans. Roy. Soc. Edinb.* xxxii. (1885); R. Langenbeck, "Die neueren Forschungen über die Korallenriffe," *Hettner geogr. Zeitsch.* iii. (1897); J. Murray, "On the Structure and Origin of Coral Reefs and Islands," *Proc. Roy. Soc. Edinb.* x. (1879-1880); J. Murray and Irvine, "On Coral Reefs and other Carbonate of Lime Formations in Modern Seas," *Proc. Roy. Soc. Edinb.* (1889); W. Savile Kent, *The Great Barrier Reef of Australia* (London, W. H. Allen & Co., 1893); Karl Semper, *Animal Life*, "Internat. Sci. Series," vol. xxxi. (1881); J. S. Gardiner, *Nature*, lxi. 371. (G. C. B.)

**CORAM, THOMAS** (1668-1751), English philanthropist, was born at Lyme Regis, Dorset. He began life as a seaman, and rose to the position of merchant captain. He settled at Taunton, Massachusetts, for several years engaging there in farming and boat-building, and in 1703 returned to England. His acquaintance with the destitute East End of London, and the miserable condition of the children there, inspired him with the idea of providing a refuge for such of them as had no legal protector; and after seventeen years of unwearied exertion, he obtained in 1739 a royal charter authorizing the establishment of his hospital for foundling infants (see **FOUNDLING HOSPITALS**). It was opened in Hatton Garden, on the 17th of October 1740, with twenty inmates. For fifteen years it was supported by voluntary contributions; but in 1756 it was endowed with a parliamentary grant of £10,000 for the support of all that might be sent to it. Children were brought, however, in such numbers, and so few (not one-third, it is said) survived infancy, that the grant was stopped, and the charity, which had been removed to Guilford Street, was from that time only administered under careful restrictions. Coram's later years were spent in watching over the interests of the hospital; he was also one of the promoters of the settlement of Georgia and Nova Scotia; and his name is honourably connected with various other charities. In carrying out his philanthropic schemes he spent nearly all his private means; and an annuity of £170 was raised for him by public subscription. He died on the 20th of March 1751.

**COR ANGLAIS**, or **ENGLISH HORN** (Ger. *englisches Horn* or *alt Hoboe*; Ital. *cornò inglese*), a wood-wind double-reed instrument of the oboe family, of which it is the tenor. It is not a horn, but bears the same relation to the oboe as the basset horn does to the clarinet. The cor anglais differs slightly in construction from the oboe; the conical bore of the wooden tube is wider and slightly longer, and there is a larger globular bell and a bent metal crook to which the double reed mouthpiece is attached. The fingering and method of producing the sound are so similar in both instruments that the player of the one can in a short time master the other, but as the cor anglais is pitched a fifth lower, the music must be transposed for it into a key a fifth higher than the real sounds produced. The compass of the cor anglais extends over two octaves and a fifth:

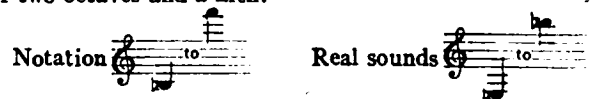

The true quality of the cor anglais is penetrating like that of the oboe, but mellow and more melancholy.

The cor anglais is the alto Pommer (*q.v.*) or *haute-contre de hautbois* (see **OBOE**), gradually developed, improved and provided with key-work. It is not known exactly when the change took place, but it was probably during the 17th century, after the Schalmey or Shawm had been transformed into the oboe. In a 17th century MS. (Add. 30,342, f. 145) in the British Museum, written in French, giving pen and ink sketches of many instruments, is an "accord de hautbois" which comprises a *pédalle*

(bass oboe or Pommer), a *sacquebute* (sackbut) as *basse-contre*, a *taille* (tenor) with a note that the *haute-contre* (the cor anglais) *est de mesme sinon plus petite*. The tubes of all the members of the hautbois family are straight in this drawing. Before 1688 the French hoboy, made in four parts and having two keys, was known in England.<sup>1</sup> It is probable that in France, where the hautbois played such an important part in court music, the cor anglais, under the name of *haute-contre de hautbois*, was also provided with keys. At the end of the 17th century there were two players of the *haute-contre de hautbois* among the musicians of the Grande Écurie du Roi.<sup>2</sup>

The origin of the name of the instrument is also a matter of conjecture. Two theories exist—one that cor anglais is a corruption of *cor anglé*, a name given on account of the angular bend



FIG. 1.—Modern Cor anglais. (Besson & Co.)

In that case the name, but not necessarily the instrument, probably originated in France early in the 18th century, for Gluck scored for two cors anglais in his Italian version of *Alceste* played in Vienna in 1767. When a French version of this opera was given in Paris two years later, the cor anglais, not being known or available there, was replaced by oboes. It was not until 1808 that the cor anglais was heard at the Paris Opera. when it was played by the oboist Vogt in Catel's *Alexandre chez Apelle*. This, however, proves only that the name was not familiar in France, where the oboe of the same pitch was called *haute-contre de hautbois*. The bending of the tube and the development of the cor anglais as solo instrument originated in Germany, unless the *oboe da caccia* was identical with the cor anglais, in which case Italy would be the country of origin. Thomas Stanesby, junior, made an oboe da caccia in 1740 of straight pattern in four pieces, having a bent metal crook for the insertion of the reed and two saddle keys; but the bell was like the bell of the oboe, not globular like that of the cor anglais, a form to which the veiled quality of its *timbre* is due. It is interesting in this connexion to recall some experiments in bending the cor anglais, which do not appear to have

led to any practical result. A French broadside (c. 1650), "La Musique," preserved in the British Museum, contains drawings of many musical instruments in use in the 17th century; among them are an oboe with keys in a perforated case, and two other wood wind instruments of the same family, which may be taken to represent attempts to dispose of the inconvenient length of the *haute-contre* (1) by bending the tube at right angles for about one quarter of its length from the mouthpiece, which contains a large

<sup>1</sup> See Harleian MS. 2034, f. 207b, British Museum, in the third part of Randle Holme's *Academy of Armoury*, written before 1688, where an outline sketch in ink is also given.

<sup>2</sup> See J. Écorcheville, "Quelques documents sur la musique de la Grande Écurie du Roi," *Sammelband intern. Musikges.* ii. 4, pp. 609 and 625. Deeds exist creating charges for four hautbois and musettes de Poitou in the hand of King John, middle of 14th century, see p. 633.

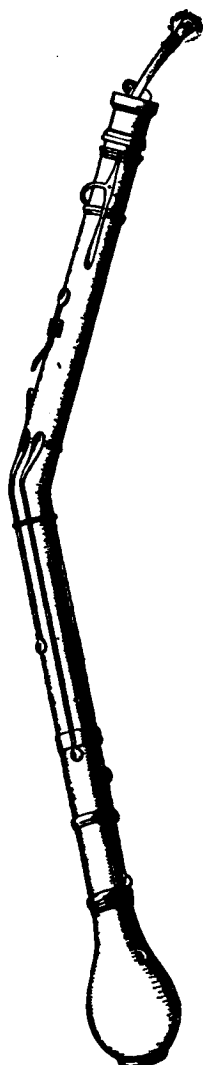

From Richard Hofmann's *Katechismus der Musikinstrumente*.

FIG. 2.—Cor anglé, 18th century.

double reed, (2) by bending the tube in the elongated "S" shape of the *cornu torto* or bass Zinke, for which the drawing in question might be mistaken but for the bent crook inserted in the end for the reception of the reed, which, however, is missing. The other hypothesis is that when the cor anglais was given a bend in order to facilitate the handling, the name was adopted to mark its resemblance to a kind of hunting-horn said to be in use in England at the time. This suggestion does not seem to be a happy one; for if the reference be to the crescent-shaped horn, that instrument was in use in all countries at various periods before the 17th century, while if it be to the angular form, then a reproduction of such a horn should be forthcoming to support the statement.

The idea of bending the instrument is attributed to Giovanni or Giuseppe Ferlendis of Bergamo,<sup>3</sup> brothers and virtuosi on the oboe. One of these had settled in Salzburg, and both were equally renowned as performers on the English horn. They visited Venice, Brescia, Trieste, Vienna, London (in 1795) and Lisbon, where Giuseppe died. In this case we might expect the name to have been given in Italian, *cornu inglese*; yet Gluck in his Italian edition used the French name already in 1767, when Giuseppe was but twelve years old. We must await some more conclusive explanation, but we may suppose that the new name was bestowed when the instrument assumed a form entirely new to the family of hautbois or oboes. The cor anglais was well known in England before 1774, for in a quaint book of travels through England, published in that year, we read that Signor Sougelder, "an eminent surgeon of Bristol," was a performer "on the English horn."

The experiment of bending the cor anglais did not prove satisfactory, for the tube instead of being bored had to be cut out of two pieces of wood which were then glued together and covered with leather. Even the most skilful craftsman did not succeed in making the inside of the tube quite smooth; the roughness of the wood was detrimental to the tone and gave the cor anglais a veiled, somewhat hoarse quality, and makers before long reverted to the direct or vertical form. (K. S.)

**CORATO**, a city of Apulia, Italy, in the province of Bari, 26 m. W. of Bari by steam tramway. Pop. (1901) 41,573. It is situated in the centre of an agricultural district. It contains no buildings of great interest, but is a clean and well-kept town.

**CORBAN** (קרבן), an Aramaic word meaning "a consecrated gift." Josephus uses the word of Nazirites and of the temple treasure of Jerusalem. Such a votive offering lay under a curse if it were diverted to ordinary purposes, like the spoil of Jericho which Achan appropriated (Josh. vii.), or the temple treasure of Delphi which was seized by the Phocians, 356 B.C. The word is found in Mark vii. 11, the usual interpretation of which is that Jesus refers to an abuse—a man might declare that any part of his property which came into his parents' hands was *corban*, consecrated, *i.e.* that a curse rested on any benefit they might get from it. The Jewish scribes thus fenced the law of vows with a traditional interpretation which made men break the most binding injunctions of the Mosaic Law, in this case the fifth commandment. A totally different explanation of the passage is put forward by J. H. A. Hart in *The Jewish Quarterly Review* for July 1907, the gist of which is that Jesus commends the Pharisees for insisting that when a man has vowed a vow to God he should pay it even though his parents should suffer.

**CORBEIL, WILLIAM OF** (d. 1136), archbishop of Canterbury, was born probably at Corbeil on the Seine, and was educated at Laon. He was soon in the service of Ranulf Flambard, bishop of Durham; then, having entered the order of St Augustine, he became prior of the Augustinian foundation at St Osyth in Essex. At the beginning of 1123 he was chosen from among several candidates to be archbishop of Canterbury, and as he refused to admit that Thurstan, archbishop of York, was independent of the see of Canterbury, this prelate refused to consecrate him, and the ceremony was performed by his own suffragan bishops. Proceeding to Rome the new archbishop found that Thurstan had anticipated his arrival in that city and had made out a strong case against him to Pope Calixtus II.; however, the exertions of the English king Henry I. and of the emperor Henry V. prevailed, and the pope gave William the pallium. The archbishop's next dispute was with the papal

<sup>3</sup> See Henri Lavoix, *Histoire de l'instrumentation*, p. 111; Gerber, *Lexikon*, "Giuseppe Ferlendis"; Robert Eitner, *Quellen-Lexikon der Tonkünstler*, "Giuseppe Ferlendis." Fétis and Pohl also refer to him.

<sup>4</sup> See *Musical Travels thro' England* (London, 1774), p. 56.

legate, Cardinal John of Crema, who had arrived in England and was acting in an autocratic manner. Again travelling to Rome, William gained another victory, and was himself appointed papal legate (*legatus natus*) in England and Scotland, a precedent of considerable importance in the history of the English Church. The archbishop had sworn to Henry I. that he would support the claim of his daughter Matilda to the English crown, but nevertheless he crowned Stephen in December 1135. He died at Canterbury on the 21st of November 1136. William built the keep of Rochester Castle, and finished the building of the cathedral at Canterbury, which was dedicated with great pomp in May 1130.

See W. F. Hook, *Lives of the Archbishops of Canterbury* (1860-1884); and W. R. W. Stephens, *History of the English Church* (1901).

**CORBEIL**, a town of northern France, capital of an arrondissement in the department of Seine-et-Oise, at the confluence of the Essonne with the Seine, 21 m. S. by E. of Paris on the Orléans railway to Nevers. Pop. (1906) 9756. A bridge across the Seine unites the main part of the town on the left bank with a suburb on the other side; handsome boulevards lead to the village of Essonnes (pop. 7255), about a mile to the south-west. St Spire, the only survivor of the formerly numerous churches of Corbeil, dates from the 12th to the 15th centuries. Behind the church there is a Gothic gateway. A monument has been erected to the brothers Galignani, publishers of Paris, who gave a hospital and orphanage to the town. Corbeil is the seat of a sub-prefect, and has tribunals of first instance and commerce and a chamber of commerce. It has important flour-mills, tallow-works, printing-works, large paper-works at Essonnes, and carries on boat and carriage-building, and the manufacture of plaster. The Decauville engineering works are in the vicinity. There is trade in grain and flour.

From the 10th to the 12th century Corbeil was the chief town of a powerful countship, but it was united to the crown by Louis VI.; it continued for a long time to be an important military post in connexion with the commissariat of Paris. In 1258 St Louis concluded a treaty here with James I. of Aragon. Of the numerous sieges to which it has been exposed the most important were those by the Huguenots in 1562, and by Alexander Farnese, prince of Parma, in 1590.

**CORBEL** (Lat. *corbellus*, a diminutive of *corvus*, a raven, on account of the beak-like appearance; Ital. *mensola*, Fr. *corbeau*, *cul-de-lampe*, Ger. *Kragstein*), the name in medieval architecture for a piece of stone jutting out of a wall to carry any superincumbent weight. A piece of timber projecting in the same way was called a tassel or a bragger. Thus the carved ornaments from which the vaulting shafts spring at Lincoln are corbels. Norman corbels are generally plain. In the Early English period they are sometimes elaborately carved, as at Lincoln above cited, and sometimes more simply so, as at Stone. They sometimes end with a point apparently growing into the wall, or forming a knot, as at Winchester, and often are supported by angels and other figures. In the later periods the foliage or ornaments resemble those in the capitals. The corbels carrying the arches of the corbel tables in Italy and France were often elaborately moulded, and sometimes in two or three courses projecting over one another; those carrying the machicolations of English and French castles had four courses. The corbels carrying balconies in Italy and France were sometimes of great size and richly carved, and some of the finest examples of the Italian Cinquecento style are found in them. Throughout England, in half-timber work, wood corbels abound, carrying window-sills or oriels in wood, which also are often carved. A "corbel table" is a projecting moulded string course supported by a range of corbels. Sometimes these corbels carry a small arcade under the string course, the arches of which are pointed and trefoiled. As a rule the corbel table carries the gutter, but in Lombard work the arcaded corbel table was utilized as a decoration to subdivide the storeys and break up the wall surface. In Italy sometimes over the corbels will be a moulding, and above a plain piece of projecting wall forming a parapet (see also MASONRY).

**CORBET, RICHARD** (1582-1635), English bishop and poet, was born in 1582, the son of a nurseryman at Ewell, Surrey. At Oxford, to which he proceeded from Westminster school in 1597, he was noted as a wit. On taking orders he continued to display this talent from the pulpit, and James I., in consideration of his "fine fancy and preaching," made him one of the royal chaplains. In 1620 he became vicar of Stewkley, Berkshire, and in the same year was made dean of Christchurch, Oxford. In 1628 he was made bishop of Oxford, and in 1632 translated thence to the see of Norwich. Corbet was the author of many poems, for the most part of a lively, satirical order, his most serious production being the *Fairies' Farewell*. His verses were first collected and published in 1647. His conviviality was famous, and many stories are told of his youthful merry-making in London taverns in company with Ben Jonson, who always remained his close friend, and other dramatists. He died at Norwich on the 28th of July 1635.

**CORBIE** (Lat. *corvus*), a crow or raven. In architecture, "corbie steps" is a Scottish term (cf. CORBEL) for the steps formed up the sides of the gable by breaking the coping into short horizontal beds.

**CORBRIDGE**, a small market town in the Hexham parliamentary division of Northumberland, England; 3½ m. E. of Hexham, on the north bank of the river Tyne, which is here crossed by a fine seven-arched bridge dating from 1674. Pop. (1901) 1647. Corbridge was formerly of greater importance than at present. Its name, derived from the small river Cor, a tributary of the Tyne, is said to be associated with the Brigantian tribe of Corionototai. About 760 it became the capital of Northumbria; later it was a borough and was long represented in parliament. In 1138 David of Scotland made it a centre of military operations, and it was ravaged by Wallace in 1296, by Bruce in 1312, and by David II. in 1346. Its chief remains of antiquity are a square peel-tower and the cruciform church of St Andrew, of which part of the fabric is of pre-Conquest date, though the building is mainly Early English. Extensive use is made of building materials from the Roman station of *Corstopitum* (also called Corchester), which lay half a mile west of Corbridge at the junction of the Cor with the Tyne. This site has from time to time yielded many valuable relics, notably a silver dish, discovered in 1734, 148 oz. in weight and ornamented with figures of deities; but the first-rate importance of the station was only revealed by careful excavations undertaken in 1907 seq. There were then unearthed remains of several buildings fronting a broad thoroughfare, one of which is the largest Roman building, except the baths at Bath, yet discovered in England. Two of these buildings were granaries, and indicate the importance of Corstopitum as a base of the northward operations of Antoninus Pius. After his conquests had been lost, and Corstopitum ceased to be a military centre, its military buildings passed into civilian occupation, of which many evidences have been found. A fine hoard of gold coins, wrapped in lead-foil and hidden in a wall, was discovered in 1908. Corstopitum ceased to exist early in the 5th century, and the site was never again occupied.

**CORBULO, GNAEUS DOMITIUS** (1st century A.D.), Roman general, was the half-brother of Caesonia, one of the wives of the emperor Caligula. In the reign of Tiberius he held the office of praetor, and was appointed to the superintendence of the roads and bridges. Under Claudius he was governor of lower Germany (A.D. 47). He punished the Frisii who refused to pay the tribute, and was on the point of advancing against the Chauci, but was recalled by the emperor and ordered to withdraw behind the Rhine. In order to provide employment for his soldiers, Corbulo made them cut a canal from the Mosa (Meuse) to the northern branch of the Rhine, which still forms one of the chief drains between Leiden and Sluys, and before the introduction of railways was the ordinary traffic road between Leiden and Rotterdam. Soon after the accession of Nero, Vologaes (Vologasus), king of Parthia, overran Armenia, drove out Rhadamistus, who was under the protection of the Romans, and set his own brother Tiridates on the throne. Corbulo was thereupon sent out to the East with full military powers. After some delay, he took



the offensive in 58, and, reinforced by troops from Germany, attacked Tiridates. Artaxata and Tigranocerta were captured, and Tigranes, who had been brought up in Rome and was the obedient servant of the government, was installed king of Armenia. In 61 Tigranes invaded Adiabene, an integral portion of the Parthian kingdom, and a conflict between Rome and Parthia seemed unavoidable. Vologaeses, however, thought it better to come to terms. It was agreed that both the Roman and Parthian troops should evacuate Armenia, that Tigranes should be dethroned, and the position of Tiridates recognized. The Roman government declined to accede to these arrangements, and L. Caesennius Paetus, governor of Cappadocia, was ordered to settle the question by bringing Armenia under direct Roman administration. The protection of Syria in the meantime claimed all Corbulo's attention. Paetus, a weak and incapable man, suffered a severe defeat at Rhandea (62), where he was surrounded and forced to capitulate and to evacuate Armenia. The command of the troops was again entrusted to Corbulo. In 63, with a strong army, he crossed the Euphrates, but Tiridates declined to give battle and concluded peace. At Rhandea he laid down his diadem at the foot of the emperor's statue, promising not to resume it until he received it from the hand of Nero himself in Rome. In 67 disturbances broke out in Judaea, but Nero, jealous of Corbulo's success and popularity, ordered Vespasian to take command of the forces and summoned Corbulo to Greece. On his arrival at Cenchræa, the port of Corinth, messengers from Nero met Corbulo, and ordered him to commit suicide. Without hesitation he obeyed, exclaiming, "I have deserved it." Whether he had really given any grounds for suspicion is unknown; but there is no doubt, so great was his popularity with the soldiers and such the hatred felt for Nero, that he could easily have seized the throne. Corbulo wrote an account of his Asiatic experiences, which is lost.

See Tacitus, *Annals*, xii.-xv.; Dio Cassius lix. 15, lx. 30, lxii. 19-23, lxiii. 6, 17, lxvi. 3; H. Schiller, *Geschichte des römischen Kaiserreichs unter der Regierung des Nero* (1872); E. Egli, "Feldzüge in Armenien von 41-63," in M. Büdinger's *Untersuchungen zur römischen Kaisergeschichte*, i. (1868); Mommsen, *Hist. of the Roman Provinces*, ii. (1886); for the Armenian campaigns see B. W. Henderson in *Classical Review* (April, May, June, 1901); in general D. T. Schoonover, *A Study of Cn. Domitius Corbulo* (Chicago, 1909).

**CORD** (derived through the Fr. *corde*, from the Lat. *chorda*, Gr. *χορδή*, the string of a musical instrument), a length of twisted or woven strands, in thickness coming between a rope and a string, a smaller kind of rope (*q.v.*). From the use of such a cord for measuring, the word is applied to a quantity of cut wood, differing according to locality. The variant "chord," which, in spelling, reverts to the original Latin, is used in particular senses, as, in physiology, for such cord-like structures as the vocal chords; in the case of the "umbilical cord," the other spelling is usually retained. In mathematics a "chord" is a straight line joining any two points on the same curve, and, in music, the word is used of several musical notes sounded simultaneously and in harmony (*q.v.*). In this last sense, "chord" is properly a shortened form of "accord," agreement, from Late Lat. *accordare*, and the spelling with *h* is due to a confusion.

**CORDAY D'ARMONT, MARIE ANNE CHARLOTTE** (1768-1793), French revolutionary heroine, the murderess of Marat, born at St Saturnin des Lignerets, near Sées in Normandy, was descended from a noble but poor family, and numbered among her ancestors the dramatist Corneille. Charlotte Corday was educated in the convent of the Holy Trinity at Caen, and then sent to live with an aunt. Here she saw hardly any one but her relative, and passed her lonely hours in reading the works of the *philosophes*, especially Voltaire and the Abbé Raynal. Another of her favourite authors was Plutarch, from whose pages she doubtless imbibed the idea of classic heroism and civic virtue which prompted the act that has made her name famous. On the outbreak of the Revolution she began to study current politics, chiefly in the papers issued by the party afterwards known as the Girondins. On the downfall of this party, on May 31, 1793, many of the leaders took refuge in Nor-

mandy, and proposed to make Caen the headquarters of an army of volunteers, at the head of whom Félix de Wimpffen, who commanded the army assembled for the defence of the coasts at Cherbourg, was to have marched upon Paris. Charlotte attended their meetings, and heard them speak; but we have no reason to believe that she saw any of them privately, till the day when she went to ask for introductions to friends of theirs in Paris. She saw that their efforts in Normandy were doomed to fail. She had heard of Marat as a tyrant and the chief agent in their overthrow, and she had conceived the idea of going alone to Paris and assassinating him,—doubtless thinking that this would break up the party of the Terrorists and be the signal of a counter-revolution, and ignorant of the fact that Marat was ill almost to the point of death, and that others were more influential than he.

Apparently she had thought of going to Paris in April, before the fall of the Girondins, for she had then procured a passport which she used in July. It contained the usual description of the bearer, and ran thus: *Laissez passer la citoyenne Marie, &c., Corday, âgée de 24 ans, taille de 5 pieds 1 pouce, cheveux et sourcils châtain, yeux gris, front élevé, nez long, bouche moyenne, menton rond fourchu, visage ovale.* Arrived in Paris she first attended to some business for a friend at Caen, and then she wrote to Marat: "Citizen, I have just arrived from Caen. Your love for your native place doubtless makes you desirous of learning the events which have occurred in that part of the republic. I shall call at your residence in about an hour; have the goodness to receive me and to give me a brief interview. I will put you in a condition to render great service to France." On calling she was refused admittance, and wrote again, promising to reveal important secrets, and appealing to Marat's sympathy on the ground that she herself was persecuted by the enemies of the republic. She was again refused an audience, and it was only when she called a third time (July 13) that Marat, hearing her voice in the ante-chamber, consented to see her. He lay in a bathing tub, wrapped in towels, for he was suffering from a horrible disease which had almost reduced him to a state of putrefaction. Our only source of information as to what followed is Charlotte's own confession. She spoke to Marat of what was passing at Caen, and his only comment on her narrative was that all the men she had mentioned should be guillotined in a few days. As he spoke she drew from her bosom a dinner-knife (which she had bought the day before for two francs) and plunged it into his left side. It pierced the lung and the aorta. He cried out, "*À moi, ma chère amie!*" and expired. Two women rushed in, and prevented Charlotte from escaping. A crowd collected round the house, and it was with difficulty that she was escorted to the prison of the Abbaye. On being brought before the Revolutionary Tribunal she gloried in her act, and when the indictment against her was read, and the president asked her what she had to say in reply, her answer was, "Nothing, except that I have succeeded." Her advocate, Claude François Chauveau Lagarde, put forward in vain the plea of insanity. She was sentenced to death, and calmly thanked her counsel for his efforts on her behalf, adding that the only defence worthy of her was an avowal of the act. She was then conducted to the Conciergerie, where at her own desire her portrait (now in the museum of Versailles) was painted by the artist Jean Jacques Hauer. She preserved her perfect calmness to the last. When she saw the guillotine, she placed herself in position under the fatal blade without assistance from any one. The knife fell, and one of the executioners held up her head by the hair, and had the brutality to strike it with his fist. Many believed they saw the dead face blush,—probably an effect of the red stormy sunset. It was the 17th of July 1793. It is difficult to analyse the character of Charlotte Corday; but there was in it much that was noble and exalted. Her mind had been formed by her studies on a pagan type. To C. J. M. Barbaroux and the Girondins of Caen she wrote from her prison, anticipating happiness "with Brutus in the Elysian Fields" after her death, and with this letter she sent a simple loving farewell to her father, revealing a tender side to her character that otherwise we would hardly have looked for in such a woman. Lamartine called her



*l'ange de l'assassinat*, and Vergniaud said, "Elle nous perd, mais elle nous apprend à mourir."

See *Œuvres politiques de Charlotte Corday* (Caen, 1863; some letters and an *Adresse aux Français amis des lois et de la paix*), with a supplement printed in the same year; Louvet de Couvrai, *Mémoires* (ed. Aulard, Paris, 1889); Alphonse Esquiros, *Charlotte Corday* (2nd ed., 2 vols., Paris, 1841); Cheron de Villiers, *Marie Anne Charlotte Corday* (Paris, 1865); Casimir Périer, "La Jeunesse de Charlotte Corday" (*Revue des deux mondes*, 1862); C. Vatel, *Dossiers du procès criminel de Charlotte de Corday . . . extraits des archives impériales* (Paris, 1861), and *Dossier historique de Charlotte Corday* (Paris, 1872); Austin Dobson, *Four Frenchwomen* (London, 1890); A. Ducos, *Les Trois Girondines, Mme Roland, Charlotte Corday . . .* (Paris, 1896); Dr Cabanès, "La vraie Charlotte Corday," in *Le Cabinet secret de l'histoire* (4 vols., 1897-1900). Her tragic history was the subject of two anonymous tragedies, *Charlotte Corday* (1795), said to be by the Conventual F. J. Gamon, and *Charlotte Corday* (Caen, 1797), neither of which have any merit; another by J. B. Salles is published by C. Vatel in *Charlotte de Corday et les Girondins* (1864-1872). See further bibliographical articles in M. Tourneux, *Bibl. de l'hist. de Paris . . .* (vol. iv., 1906), and in the *Bibliographie des femmes célèbres* (3 vols., Turin and Rome, 1892-1905); and also E. Defrance, *Charlotte Corday et la mort de Marat* (1909).

**CORDELIERS, CLUB OF THE, OR SOCIETY OF THE FRIENDS OF THE RIGHTS OF MAN AND OF THE CITIZEN**, a popular society of the French Revolution. It was formed by the members of the district of the Cordeliers, when the Constituent Assembly suppressed the 60 districts of Paris to replace them with 48 sections (21st of May 1790). It held its meetings at first in the church of the monastery of the Cordeliers,—the name given in France to the Franciscan Observantists,—now the Dupuytren museum of anatomy in connexion with the school of medicine. From 1791, however, the Cordeliers met in a hall in the rue Dauphine. The aim of the society was to keep an eye on the government; its emblem on its papers was simply an open eye. It sought as well to encourage revolutionary measures against the monarchy and the old régime, and it was it especially which popularized the motto "Liberty, Equality, Fraternity." It took an active part in the movement against the monarchy of the 20th of June and the 10th of August 1792; but after that date the more moderate leaders of the club, Danton, Fabre d'Eglantine, Camille Desmoulins, seem to have ceased attending, and the "enragés" obtained control, such as J. R. Hébert, F. N. Vincent, C. P. H. Ronsin and A. F. Momoro. Its influence was especially seen in the creation of the revolutionary army destined to assure provisions for Paris, and in the establishment of the worship of Reason. The Cordeliers were combated by those revolutionists who wished to end the Terror, especially by Danton, and by Camille Desmoulins in his journal *Le Vieux Cordelier*. The club disowned Danton and Desmoulins and attacked Robespierre for his "moderation," but the new insurrection which it attempted failed, and its leaders were guillotined on the 24th of March 1794, from which date nothing is known of the club. We know little of its composition.

The papers emanating from the Cordeliers are enumerated in M. Tourneux, *Bibliographie de l'histoire de Paris pendant la Révolution* (1894), i. (on the trial of the Hébertists) Nos. 4204-4210, ii. Nos. 9795-9834 and 11,813. See also A. Bougeart, *Les Cordeliers, documents pour servir à l'histoire de la Révolution* (Caen, 1891); G. Lenotre, *Paris révolutionnaire* (Paris, 1895); G. Tridon, *Les Hébertistes, plainte contre une calomnie de l'histoire* (Paris, 1864). The last-named author was condemned to four months' prison; his work was reprinted in 1871. The inventory of the pictures found in 1790 in the monastery of the Cordeliers was published by J. Guiffrey in *Nouvelles archives de l'art français*, viii., 2nd series, iii. (1880). (R. A.)\*

**CORDERIUS**, the Latinized form of name used by MATHURIN CORDIER (c. 1480-1564), French schoolmaster, a native of Normandy or Perche. He possessed special tact and liking for teaching children, and taught first at Paris, where Calvin was among his pupils, and, after a number of changes, finally at Geneva, where he died on the 8th of September 1564. He wrote several books for children; the most famous is his *Colloquia* (*Colloquiorum scholasticorum libri quatuor*), which has passed through innumerable editions, and was used in schools for three centuries after his time. He also wrote: *Principia Latine loquendi scribendique, sive selecta quaedam ex Epistolis Ciceronis*; *De corrupti sermonis apud Gallos emendatione et Latine loquendi Ratione*; *De syllabarum quantitate*; *Conciones sacrae viginti sex Galliae*; *Catonis disticha de moribus* (with Latin and French

translation); *Remonstrances et exhortations au roi et aux grands de son royaume*.

See monograph by E. A. Berthault, *De M. Corderio et creatis apud Protestantibus litterarum studiis* (1875).

**CORDES**, a town of southern France, in the department of Tarn, 15 m. N.W. of Albi by road. Pop. (1906) 1619. Cordes, which covers the summit and slopes of an isolated hill, was a bastide founded by Raymond VII., count of Toulouse, in the first half of the 13th century. It preserves its medieval aspect to a remarkable degree, a large number of houses of the 13th and 14th centuries, with decorated fronts, forming its chief attraction. A church of the same periods and remains of the original ramparts are also to be seen.

**CORDILLERA**, a Spanish term for a range or chain of mountains, derived from the Old Spanish *cordilla*, the diminutive of *cuerda*, a cord or rope. The name was first given to the Andes ranges of South America, *Las Cordilleras de los Andes*, and applied to the extension of the system into Mexico. In North America the parallel ranges of mountains running between and including the Rocky Mountains and the Sierra Nevada are known as the "Cordilleras," and that part of the western continent crossed by them has been termed the "Cordilleran region." Although the name has been applied to the eastern mountain system of Australia, the word is not, outside America, used as a generic term for parallel ranges of mountains.

**CORDITE**, the name given to the smokeless propellant in use in the British army and navy. The material is produced in the form of cylindrical rods or strings of varying thicknesses by pressing the material, whilst in a soft and pasty state, through dies or perforations in a steel plate by hydraulic or screw pressure, hence the name cordite. The thickness or size of the rods varies from about 1 mm. diameter to 5 or more mm. according to the nature of the charge for which it is intended. The smallest diameter is used for revolver cartridge and the largest for heavy guns. When first devised by the Ordnance Committee, presided over by Sir Frederick Abel, in 1891, this explosive consisted of 58% of nitro-glycerin, 37% of gun-cotton, and 5% of mineral jelly. This variety is now known as Cordite Mark 1. At the present time a modification is made which contains gun-cotton 65%, nitro-glycerin 30%, and mineral jelly 5%. This is known as Cordite M.D. The advantages of Cordite M.D. over Mark 1 are slightly reduced rate of burning, higher velocities and more regular pressure in the gun, and lower temperature.

Cordite of either mark is a perfectly waterproof substance, containing only traces of water remaining from the manufacturing processes. It has a density of about 1.56 at the ordinary temperature (15° C.), and, as its coefficient of expansion is small, this density does not change to any serious extent under climatic temperature variations. A rod may be bent to a moderate extent without breaking, and Cordite M.D. especially shows considerable elasticity. It can be impressed by the nail and cut with a knife, but is not in the least sticky, nor does the nitro-glycerin exude to any appreciable extent. It can be obtained in a finely-divided state by scraping with a sharp knife, or on a new file, or by grinding in a mill, such as a coffee-mill, but can scarcely be pounded in a mortar. Cordite is of a brownish colour in mass, but is much paler when finely ground or scraped. The rods easily become electrified by gentle friction with a dry substance. Like all colloidal substances it is an exceedingly bad conductor of heat. A piece ignited in air burns with a yellowish flame. With the smaller sizes, about 2 mm. diameter or less, this flame may be blown out, and the rod will continue to burn in a suppressed manner without actual flame, fumes containing oxides of nitrogen being emitted. Temperature appears to have an effect on the rate of burning. When much cooled it certainly burns more slowly than when at the ordinary air temperature, and is also more difficult to ignite. Rods of moderate thickness, say from 5 mm. diameter, will continue to burn under water if first ignited in air and the burning portion slowly immersed. The end of a rod of cordite may be struck a moderately heavy blow on an anvil without exploding or igniting. The rod will first flatten out. A sharp blow will then detonate

or explode the portion immediately under the hammer, the remainder of the rod remaining quite intact. Bullets may be fired through a bundle or package of cordite without detonating or inflaming it. This is of course a valuable quality. The exact temperature at which substances ignite or take fire is in all cases difficult to determine with any exactness. Cordite is not *instantly* ignited on contact with a flame such as that of a candle, because, perhaps, of the condensation of some moisture from the products of burning of the candle upon it. A blow-pipe flame or a red-hot wire is more rapid in action. The ignition temperature may be somewhere in the region of 180° C.

All the members of this class of explosive when kept for some time at (for them) moderately high temperatures, such as the boiling-point of water (100° C.), show signs of decomposition; oxides of nitrogen are liberated, and some complex oxidation processes are started. Carefully prepared gun-cotton and nitro-glycerin will, however, withstand this temperature for a long time without serious detriment, excepting that nitro-glycerin is slightly volatilized. When incorporated in cordite, however, the nitro-glycerin appears to be much less volatile than when free at this temperature. Under reduced pressure (3 or 4 in. only of mercury instead of 30) it is possible to distil away a considerable amount of nitro-glycerin from cordite at 100° C. It is very doubtful whether at ordinary temperatures and pressures any nitro-glycerin whatever evaporates.

Cordite may be kept in contact with clean, dry metals, wood, paper, and a number of ordinary substances without deterioration. In contact with damp and easily oxidizable metals all the substances of the gun-cotton class are liable to a slight local action, but the colloid nature, and probably also the contained mineral jelly, protect cordite considerably in these circumstances. Ammonia has a deleterious action, but even this proceeds but slowly. Cordite does not appear to change when kept under water.

The manufacturing processes comprise: drying the gun-cotton and nitro-glycerin; melting and filtering the mineral jelly; weighing and mixing the nitro-glycerin with the gun-cotton; moistening this mixture with acetone until it becomes a jelly; and then incorporating in a special mixing mill for about three hours, after which the weighed amount of mineral jelly is added and the incorporation continued for about one hour or until judged complete. The incorporating or mixing machine is covered as closely as possible to prevent too great evaporation of the very volatile acetone. Before complete incorporation the mixture is termed, in the works, "paste," and, when finally mixed, "dough."

The right consistency having been produced, the material is placed in a steel cylinder provided with an arrangement of dies or holes of regulated size at one end, and a piston or plunger at the other. The plunger is worked either by hydraulic power or by a screw (driven from ordinary shafting). Before reaching and passing through the holes in the die, the material is filtered through a disk of fine wire gauze to retain any foreign substances, such as sand, bits of wood or metal, or unchanged fibres of cellulose, &c., which might choke the dies or be otherwise dangerous. The material issues from the cylinders in the form of cord or string of the diameter of the holes of the die. The thicker sizes are cut off, as they issue, into lengths (of about 3 ft.), it being generally arranged that a certain number of these—say ten—should have, within narrow limits, a definite weight. The small sizes, such as those employed for rifle cartridges, are wound on reels or drums, as the material issues from the press cylinders, in lengths of many yards.

Some of the solvent or gelatinizing material (acetone) is lost during the incorporating, and more during the pressing process and the necessary handling, but much still remains in the cordite at this stage. It is now dried in heated rooms, where it is generally spread out on shelves, a current of air passing through carrying the acetone vapour with it. In the more modern works this air current is drawn, finally, through a solution of a substance such as sodium bisulphite; a fixed compound is thus formed with the acetone, which by suitable treatment

may be recovered. The time-taken in the drying varies with the thickness of the cordite from a few days to several weeks. For several reasons it is desirable that this process should go on gradually and slowly.

After drying, all the various batches of cordite of the same size are carefully "blended," so that any slight differences in the manufacture of one batch or one day's output may be equalized as much as possible. Slight differences may arise from the raw materials, cotton waste or glycerin, or in the making of these into gun-cotton or nitro-glycerin respectively. To help in controlling the blending, each "make" of gun-cotton and nitro-glycerin is "marked" or numbered, and carries its mark to the cordite batch of which it is an ingredient. The history of each box of large-sized or reel of small-sized cordite is therefore known up to the operation of blending and packing. The final testing is by firing proofs, as in the case of the old gunpowders.

The gun-cotton employed for cordite is made in the usual way (see GUN-COTTON), with the exception of treating with alkali. It is also after complete washing with water gently pressed into small cylinders (about 3 in. diameter and 4 in. high) whilst wet, and these are carefully dried before the nitro-glycerin is added. The pressure applied is only sufficient to make the gun-cotton just hold together so that it is easily mixed with the nitro-glycerin. The mineral jelly or vaseline is obtained at a certain stage of distillation of petroleum, and is a mixture of hydrocarbons, paraffins, olefines and some other unsaturated hydrocarbons, possibly aromatic, which no doubt play a very important part as preservatives in cordite.

The stability of cordite, that is, its capability of keeping without chemical or ballistic changes, is judged of by certain "heat tests." The Abel heat test consists in subjecting a weighed quantity, 2 grams, of the finely divided cordite contained in a test tube, to a temperature of 70° C. maintained constant by a water bath. The test tube is about 6 × ¼ in., and dips into the water sufficiently to immerse about 2 in., viz. the part containing the cordite. In the upper free portion a piece of filter-paper impregnated with a mixture of potassium iodide and starch paste is suspended by a platinum wire from the stopper of the tube. A portion of the test paper is moistened with a solution of glycerin to render it more sensitive than the dry part. A faint brown colour appearing on the moistened portion indicates that some oxides of nitrogen have been evolved from the cordite. This brown tint is compared with a standard, and the time taken before the standard tint appears is noted. The time fixed upon as a test of relative stability is an arbitrary one determined by examination of well-known specimens. Should the cordite or other explosive contain traces of mercury salts, such as mercuric chloride, which is sometimes added as a preservative, this test is rendered nugatory, and no coloration may appear (or only after a long exposure), although the sample may be of indifferent stability. It is now customary to examine specially for mercury, either by heating the explosive in contact with gold leaf or silver foil, or by burning the substance and examining the flame in the spectroscope.

The method of examination known as the vacuum silvered vessel process is probably not interfered with by the presence of very small quantities of mercury. It consists in heating 50 grams of the finely divided explosive in a Dewar's silvered vacuum glass bulb to a rigidly constant temperature of 80° C. for many hours. A sensitive thermometer having its bulb immersed in the centre of the cordite shows when the temperature rises above 80°. Such a rise indicates internal oxidation or decomposition of the explosive; it is accompanied by an evolution of nitrogen dioxide, NO<sub>2</sub>, the depth of colour of which is noted through a side tube attached to the bulb. As all explosives of this class would in time decompose sufficiently to give these indications, time periods or limits have been fixed at which an appreciable and definite rise in temperature and production of red fumes indicate relative stability or instability. (W. R. E. H.)

CÓRDOBA, GONZALO FERNANDEZ DE (1853-1915), Spanish general and statesman, usually spoken of by the Italianized form of his Christian name as GONSALVO DE CÓRDOBA, or as "the

Great Captain," was the second son of Don Pedro Fernandez de Córdoba, count of Aguilar, and of his wife Elvira de Herrera, who belonged to the family of Enriquez, the hereditary admirals of Castile, a branch of the royal house. Gonzalo was born at Montilla near the city of Córdoba (Cordoba) on the 16th of March 1453. The father died when he and his elder brother, Don Alonso, were mere boys. The counts of Aguilar carried on an hereditary feud with the rival house of Cabra, and the children were carried by their vassals into the faction fights of the two families. As a younger son Gonzalo had his fortune to make, but he was generously aided by the affection of his elder brother, who was very wealthy. War and service in the king's court offered the one acceptable career outside the church to a gentleman of his birth.

He was first attached to the household of Don Alphonso, the king's brother, and upon his death devoted himself to Isabella, afterwards the queen. During the civil war, and the conflict with Portugal which disturbed the first years of her reign, he fought under the grand master of Santiago, Alonso de Cardenas. After the battle of Albuera, the grand master gave him especial praise, saying that he could always see Gonzalo to the front because he was conspicuous by the splendour of his armour. Indeed the future Great Captain, who, as a general, was above all things astute and patient, could, and habitually did, display the most reckless personal daring, going into a fight as if he loved it, and having a shrewd sense that a reputation for intrepidity, a free-handed profusion, and the personal magnificence which strikes the eye, would secure him the devotion of his soldiers. During the ten years' war for the conquest of Granada he completed his apprenticeship under his brother, the count of Aguilar, the grand master of Santiago, and the count of Tendilla, of whom he always spoke as his masters. It was a war of surprises and defences of castles or towns, of skirmishes, and of ambushes in the defiles of the mountains. The military engineer and the "guerrillero" were about equally employed. Gonzalo's most distinguished single feat was the defence of the advanced post of Illora, but he commanded the queen's escort when she wished to take a closer view of Granada, and he beat back a sortie of the Moors under her eyes. When Granada surrendered, he was one of the officers chosen to arrange the capitulation, and on the peace he was rewarded by a grant of land.

So far he was only known as an able subordinate, but his capacity could not be hidden from such an excellent judge of character as Isabella, to whom as a woman he appealed by a chivalrous union of devotion and respect. When, therefore, the Catholic sovereigns decided to support the Aragonese house of Naples against Charles VIII. of France, Gonzalo was chosen by the influence of the queen, and in preference to older men, to command the Spanish expedition. It was in Italy that he won the title of the Great Captain; Guicciardini says that it was given him by the customary arrogance of the Spaniards, but it was certainly accepted as just by all the soldiers of the time of whatever nationality. A detailed account of his campaigns cannot be given here. He held the command in Italy twice. In 1495 he was sent with a small force of little more than five thousand men to aid Ferdinand of Naples to recover his kingdom, and he returned home after achieving success, in 1498. After a brief interval of service against the conquered Moors who had risen in revolt, he returned to Italy in 1501. Ferdinand of Spain had entered into his iniquitous compact with Louis XII. of France for the spoliation and division of the kingdom of Naples. The Great Captain was chosen to command the Spanish part of this robber coalition. As general and as viceroy of Naples he remained in Italy till 1507. During his first command he was mostly employed in Calabria in mountain warfare which bore much resemblance to his former experience in Granada. There was, however, a material difference in the enemy. The French forces, commanded by the Scotsman Stuart d'Aubigny, consisted largely of Swiss pikemen, and of their own men-at-arms. With his veterans of the Granadine war, foot soldiers armed with sword and buckler, or arquebuses and crossbows, and light cavalry, trained to unsleeping vigilance, capable of long marches,

and of an endurance unparalleled among the soldiers of the time, he could carry on a guerrillero warfare which wore down his opponents, who suffered far more than the Spaniards from the heat. But he saw clearly that this was not enough. His experience in Seminara showed him that something more was wanted on the battlefield. The action was lost mainly because King Ferdinand, disregarding the advice of Gonzalo, persisted in fighting a pitched battle with inferior numbers, some of whom were untrustworthy Neapolitans. The Spanish foot behaved excellently, but the result showed that in the open field their loose formation and their swords put them at a disadvantage as against a charge of heavy cavalry or pikemen. Gonzalo therefore introduced a much more strict formation, and adopted the pike as the weapon of a part of his foot. The division of the Spanish infantry into the "battle" or main central body of pikemen, and the wings (*alas*) of "shot" to be employed in outflanking the enemy, was primarily due to the Great Captain.

The French were expelled by 1498 without another battle. When the Great Captain reappeared in Italy he had first to perform the congenial task of driving the Turk from Cephalonia, then to aid in robbing the king of Naples, Frederick, brother of his old ally Ferdinand. When the king of Naples had been despoiled, the French and Spaniards quarrelled over the booty. The Great Captain now found himself with a much outnumbered army in the presence of the French. The war was divided into two phases very similar to one another. During the end of 1502 and the early part of 1503 the Spaniards stood at bay in the entrenched camp at Barletta near the Ofanto on the shores of the Adriatic. He resolutely refused to be tempted into battle either by the taunts of the French or the discontent of his own soldiers. Meanwhile he employed the Aragonese partisans in the country, and flying expeditions of his own men, to harass the enemy's communications. When he was reinforced, and the French committed the mistake of scattering their forces too much to secure supplies, he took the offensive, pounced on the enemy's depot of provisions at Cerignola, took a strong position, threw up hasty field works, and strengthened them with a species of wire entanglements. The French made a headlong front attack, were repulsed, assailed in flank, and routed. The later operations on the Garigliano were very similar, and led to the total expulsion of the French from Naples. Gonzalo remained as governor of Naples till 1507. But he had become too great not to arouse the jealousy of such a typical king of the Renaissance as Ferdinand the Catholic. The death of the queen in 1504 had deprived him of a friend, and it must be allowed that he was profuse in rewarding his captains and his soldiers out of the public treasury. Ferdinand loaded him with titles and fine words, but recalled him so soon as he could, and left him unemployed till his death on the 2nd of December 1515.

The Great Captain is sometimes spoken of as the first of modern generals. The expression is uncritical, for modern generalship arose from many sides, but he was emphatically a general. There is much in his methods which bears a curious likeness to those of the duke of Wellington; Barletta, for instance, has a distinct resemblance to the Torres Vedras campaign, and the battle on the Garigliano to Assaye. As an organizer he founded the Spanish infantry of the 16th and 17th centuries, and he gave the best proof of his influence by forming a school of officers. The best generals of Charles V. were either the pupils of the Great Captain or were trained by them.

There is no life of Gonzalo de Córdoba written by a scholar who was also a good judge of war. The dull *Cronica del Gran Capitan* gives the bare events of his campaigns rather wearisomely but fully. Paulus Govius, *Vitae illustrium virorum*, translated by Domenichi (Florence, 1550), is elegant and very readable. Don José Quintana includes him in his *Españoles celebres (Rivadeneira Biblioteca de autores españoles*, vol. xix., Madrid, 1846-1880); and Prescott collected the authorities, and made good use of them in his *Ferdinand and Isabella*. See also P. du Roncet, *Histoire de Gonsalve de Cordoue* (Paris, 1714). The *Gonsalve de Cordoue, ou Grenade reconquise* of Florian (Paris, 1791) is a romance. (D. H.)

**CÓRDOBA**, a large central province of the Argentine Republic, bounded N. by Santiago del Estero, E. by Santa Fé, S. by Buenos Aires and La Pampa, W. by San Luis and Rioja, and N.W. by

Catamarca. Pop. (1895) 351,223; (1904, estimate) 465,464; area, 62,160 sq. m. The greater part of the province belongs to the pampas, though less fertile and grassy than the plains farther E. and S. It likewise includes large saline and swampy areas. The N.W. part of the province is traversed by an isolated mountain system made up of the Córdoba, Pocho and Ischilin sierras, which extend for a distance of some 200 m. in a N. and S. direction. These ranges intercept the moist winds from the Atlantic, and receive on their eastern slopes an abundant rainfall, which gives them a strikingly verdant appearance in comparison with the surrounding plains. West and N.W. of the sierras are extensive saline basins called Las Salinas Grandes, which extend into the neighbouring provinces and are absolutely barren. In the N.E. the land is low and swampy; here are the large saline lagoons of Mar Chiquita and Los Porongos. The principal rivers, which have their sources in the sierras and flow eastward, are the Primero and Segundo, which flow north-easterly into the lacustrine basin of Mar Chiquita; the Tercero and Cuarto, which unite near the Santa Fé frontier to form the Carcaraña, a tributary of the Paraná; and the Quinto, which flows south-easterly into the swamps of the Laguna Amarga in the S. part of the province. Countless small streams also descend the eastern slopes of the sierras and are lost in the great plains. The eastern districts are moderately fertile, and are chiefly devoted to cattle-breeding, though cereals are also produced. In the valleys and well-watered foothills of the sierras, however, cereals, alfalfa and fruit are the principal products. The rainfall is limited throughout the province, and irrigation is employed in but few localities. The mineral resources include gold, silver, copper, lead and iron, but mining is carried on only to a very limited extent. Salt and marble are also produced. Córdoba is traversed by several railway lines—those running westward from Buenos Aires and Rosario to Mendoza and the Chilean frontier, those connecting the city of Córdoba with the same cities, and with Tucuman on the N. and Catamarca and Rioja on the N.W. The chief towns are Córdoba, the capital, Rio Cuarto, Villa Maria, an important railway centre 82 m. S.E. of Córdoba, and Cruz del Eje on the W. slopes of the sierras, 110 m. N.W. of Córdoba.

**CÓRDOBA**, a city in the central part of the Argentine Republic, capital of the above province, on the Rio Primero, 435 m. by rail N.W. of Buenos Aires by way of Rosario, 246 m. from the latter. Pop. (1895) 42,783—the suburbs having 11,679 more—(1905, estimate) 60,000. The city is connected by railway with Buenos Aires and Rosario, and with the capitals of all the surrounding provinces. Córdoba stands on a high eastward-sloping plain called the "Altos," 1240 ft. above sea-level, and is built in a broad river bottom washed out by periodical inundations and the action of the rains on the alluvial banks. The inundations have been brought under control by the construction of barriers and dams, but the banks are constantly broken down. The city is regularly laid out, and contains many fine edifices and dwellings. Several suburban settlements surround the city, the more important of which are served by the urban tramway lines. The streets are lighted by gas and electricity, and an excellent telephone service is maintained. The noteworthy public buildings include the cathedral, a handsome edifice curiously oriental in appearance, a massive old Jesuit church with a ceiling of richly carved and gilded cedar, the old university, founded in 1613, which still occupies the halls built by the Jesuits around a large quadrangle, the fine old *cabildo*, or government house, of Moorish appearance, and the national observatory on the *barranca* overlooking the city. There are, also, two national normal schools, a national college, an episcopal seminary, an endowed Carmelite orphanage, a national meteorological station, a national academy of sciences, and a good public library. Among the attractive features of the city is an alameda of about six acres, within which is a square artificial lake of 4 acres, surrounded by shrubbery and shaded walks; the alameda dates from the time when the Jesuits ruled the city, and to them also are due the tiled baths, supplied with running water. A short avenue connects the alameda with the

principal *plaza*, a pretty garden and promenade. The water supply of Córdoba is derived from the Rio Primero, 12 m. above the city, where an immense dam (Dique San Roque), one of the largest of its kind in South America, has been built across the river valley. This dam also serves to irrigate the valley below, and to furnish power for the electric plant which provides Córdoba with light and electric power. In and about the city there are several industrial establishments which have sprung into existence since the opening of the first railway in 1870. The surrounding country is irrigated and well cultivated, and produces an abundance of fruit and vegetables.

The city was founded in 1573 by Luis Geronimo de Cabrera and was for a long time distinguished for its learning and piety. It was the headquarters of the Jesuits in this part of South America for two centuries, and for a time the capital of the Spanish *intendencia* of Tucuman. The expulsion of the Jesuits in 1767 proved to be a serious blow to the academic reputation of the city, from which it did not recover until 1870, when President Sarmiento engaged some eminent scientific men from Europe to teach modern science in the university.

**CÓRDOBA**, a town of the state of Vera Cruz, Mexico, 55 m. W.S.W. of the port of Vera Cruz, in a highly fertile valley, near the volcano of Orizaba, and 2880 ft. above sea-level. Pop. (1895) 7974. The surrounding district produces sugar, tobacco and coffee, Córdoba being one of the principal coffee-producing centres of Mexico. It also manufactures cotton and woollen fabrics. The town is regularly laid out and built of stone, and contains several handsome edifices, chief of which is the old cathedral. Córdoba was a town of considerable importance in colonial times, but fell into decay after the revolution. The railway from Vera Cruz to Mexico, which passes through it, and the development of coffee production, have helped the city to recover a part of its lost trade.

**CORDON** (a French derivative of *corde*, cord), a word used in many applications of its meaning of "line" or "cord," and particularly of a cord of gold or silver lace worn in military and other uniforms. The word is especially used of the sash or ribbon worn by members of an order of knighthood, crossing from one shoulder to the opposite hip. The *cordón bleu*, the sky-blue ribbon of the knight's grand cross of the order of the Holy Spirit, the highest order of the Bourbon kings of France, was, like the "blue ribbon" of the English Garter, taken as a type of the highest reward or prize to which any one can attain (see also COOKERY). In heraldry, "cordons" are the ornamental cords which, with the hats to which they are attached, ensign the shields of arms of certain ecclesiastical dignitaries; they are interlaced to form a mesh or network and terminate in rows of tassels. A cardinal's cordon is *gules* with five rows of fifteen tassels, an archbishop's *vert* with four rows of ten, and a bishop's also *vert*, with three rows of six. In architecture a "cordon" is a projecting band of stone along the outside of a building, a string-course. The word is frequently used in a transferred sense of a line of posts or stations to guard an enclosed area from unauthorized passage, e.g. a military or police cordon, and especially a sanitary cordon, a line of posts to prevent communication from or with an area infected with disease.

**CORDOVA** (Span. *Córdoba*), an inland province of southern Spain, bounded on the N.E. by Ciudad Real, E. by Jaén, S.E. by Granada, S. by Málaga, S.W. and W. by Seville, and N.W. by Badajoz. Pop. (1900) 455,859; area, 5299 sq. m. The river Guadalquivir divides the province into two very dissimilar portions. On the right bank is the mountainous region of the Sierra Morena, less peopled and fertile than the left bank, with its great plains (*La Campiña*) and slightly undulating country towards the south and south-east, where the surface again becomes mountainous with the outlying ridges of the Sierra Nevada. The Guadalquivir, flowing from E.N.E. to W.S.W., waters the richest districts of Cordova, and has many tributaries, notably the Bembezar, Guadiato and Guadamellato, on the right, and the Genil and Guadajoz on the left. The northern districts (*Los Pedroches*) are drained by several small tributaries of the Guadiana. The climate is much varied. Snow is to be found

for months on the highest peaks of the mountains; mild temperature in the plains, except in the few torrid summer months, when rain seldom falls. The peasantry are chiefly occupied in various branches of husbandry; sheep-farming and the culture of the olive employ large numbers. The agricultural wealth of Cordova is, however, not fully exploited, owing to the conservatism and backward education of the peasantry. There are no great manufacturing towns, but mining is an industry of some importance. In 1903 coal was obtained in considerable quantities in the Belmez district; argentiferous lead and zinc near Pozoblanco and elsewhere; iron ore at Luque, near Baena. A small amount of bismuth is also obtained. Mining is facilitated by a fairly complete and well-kept system of communication by road and railway. The main line Madrid-Lináres-Seville follows the Guadalquivir valley throughout the province, passing through the capital, Cordova. Here it meets the line from Almorchón, on the north, to Málaga, on the south, which has three important branches—Belmez-Fuente del Arco, Cordova-Utrera, and Puente Genil-Jaén. After the capital, the principal towns are Aguilar de la Frontera (13,236), Baena (14,539), Cabra (13,127), Fuente Ovejuna (11,777), Lucena (21,179), Montilla (13,603), Montoro (14,581), Pozoblanco (12,792), Priego de Cordoba (16,904) and Puente Genil (12,956). These are described under separate headings. Other towns of less importance are Adamuz (6974), Belalcázar (7682), Belmez (8978), Bujalance (10,756), Castro del Río (11,821), Hinojosa del Duque (10,673), Palma del Río (7914), Rute (10,740) and Villafranca de Córdoba (9771).

**CORDOVA** (Span. *Córdoba*; Lat. *Corduba*), the capital of the Spanish province of Cordova, on the southern slopes of the Sierra de Cordova, and the right bank of the river Guadalquivir. Pop. (1900) 58,275. At Cordova the Madrid-Seville railway meets the branch line from Almorchón to Málaga. The city is an episcopal see. Few fragments remain of its Moorish walls, which were erected on Roman foundations and enclosed a very wide area, now largely occupied by garden-ground cleared from the ruins of ancient buildings. On the outskirts are many modern factories in striking contrast with the surrounding orange, lemon and olive plantations, and with the pastures which belong to the celebrated Cordovan school of bull-fighting. Nearer the centre the streets are for the most part narrow and crooked. Almost every building, however, is profusely covered with whitewash, and thus there is little difference on the surface between the oldest and the most modern houses. The southern suburb communicates with the town by means of a bridge of sixteen arches across the river, exhibiting the usual combination of Roman and Moorish masonry and dominated at the one end by an elevated statue of the patron saint, St Raphael, whose effigy is to be seen in various other quarters of the city. The most important of the public buildings are the cathedral, the old monastic establishments, the churches, the bishop's palace, the city hall, the hospitals and the schools and colleges, including the academy for girls founded in 1590 by Bishop Pacheco of Cordova, which is empowered to grant degrees. The Alcázar, or royal palace, stands on the south-west amid the gardens laid out by its builder, the caliph Abd-ar-Rahman III. (912-961). Its older parts are in ruins, and even the so-called New Alcázar, erected by Alphonso XI. of Castile in 1328, and long used as the offices of the Holy Inquisition, has only one wing in good repair, which serves as a prison.

But the glory of Cordova, surpassing all its other Moorish or Christian buildings, is the *mezquita*, or mosque, now a cathedral, but originally founded on the site of a Roman temple and a Visigothic church by Abd-ar-Rahman I. (756-788), who wished to confirm the power of his caliphate by making its capital a great religious centre. Immigration from all the lands of Islam soon rendered a larger mosque necessary, owing to the greatly increased multitude of worshippers, and, by orders of Abd-ar-Rahman II. (822-852) and Al-Hakim II. (961-976), the original size was doubled. After various minor additions, Al-Mansur, the vizier of the caliph Hisham II. (976-1009), again enlarged the *Zeca*, or House of Purification, as the mosque was named, to twice its former size, rendering it the largest sacred building of Islam, after the Kaaba at Mecca. The ground plan of the

completed mosque forms a rectangle, measuring 570 ft. in length and 425 in breadth, or little less than St Peter's in Rome. About one-third of this area is occupied by the courtyard, and the cloisters which surround it on the north, west and east. The exterior, with the straight lines of its square buttress towers, has a heavy and somewhat ungainly appearance; but the interior is one of the most beautiful specimens of Moorish architecture. Passing through a grand courtyard about 500 ft. in length, shady with palm and cypress and orange trees and watered by five fountains, the visitor enters on the south a magnificent and bewildering labyrinth of pillars in which porphyry, jasper and many-coloured marbles are boldly combined. Part came from the spoils of Nîmes or Narbonne, part from Seville or Tarragona, some from the older ruins of Carthage, and others as a present to Abd-ar-Rahman I. from the East Roman emperor Leo IV., who sent also from Constantinople his own skilled workmen, with 16 tons of tesserae for the mosaics. Originally of different heights, the pillars have been adjusted to their present standard of 12 ft. either by being sunk into the soil or by the addition of Corinthian capitals. Twelve hundred was the number of the columns in the original building, but many have been destroyed. The pillars divide the area of the building from north to south, longitudinally into nineteen and transversely into twenty-nine aisles—each row supporting a tier of open Moorish arches of the same height (12 ft.) with a third and similar tier superimposed upon the second. The full height of the ceiling is thus about 35 ft. The Moorish character of the building was unfortunately impaired in the 16th century by the formation in the interior of a *crucero*, or high altar and cruciform choir, by the addition of numerous chapels along the sides of the vast quadrangle, and by the erection of a belfry 300 ft. high in room of the old minaret. The *crucero* in itself is no disgrace to the architect Hernan Ruiz, but every lover of art must sympathize with the rebuke administered by the emperor Charles V. (1500-1558) to the cathedral authorities: "You have built here what could have been built as well anywhere else; and you have destroyed what was unique in the world." Magnificent, indeed, as the cathedral still is, it is almost impossible to realize what the mosque must have been when the worshippers thronged through its nineteen gateways of bronze, and its 4700 lamps, fed with perfumed oil, illuminated its brilliant aisles. Of the exquisite elaboration bestowed on the more sacred portions abundant proof is afforded by the third *Mihrab*, or prayer-recess, a small 10th-century chapel, heptagonal in shape, roofed with a single shell-like block of snow-white marble, and inlaid with Byzantine mosaics of glass and gold.

Cordova was celebrated in the time of the Moors for its silver-smiths, who are said to have come originally from Damascus; and it exported a peculiar kind of leather which took its name from the city, whence is derived the word *cordwainer*. Fine silver filigree ornaments are still produced; and Moorish work in leather is often skilfully imitated, although this handicraft almost disappeared in the 15th century. The chief modern industries of Cordova are distillation of spirits and the manufacture of woollen, linen and silken goods.

Corduba, probably of Carthaginian origin, was occupied by the Romans under Marcus Marcellus in 152 B.C., and shortly afterwards became the first Roman *colonia* in Spain. From the large number of men of noble rank among the colonists, the city obtained the title of *Patricia*; and to this day the Cordovese pride themselves on the purity and antiquity of their descent. In the 1st century B.C. Cordova aided the sons of Pompey against Caesar; but after the battle of Munda, in 45 B.C., it fell into the hands of Caesar, who avenged the obstinacy of its resistance by massacring 20,000 of the inhabitants. Under Augustus, if not before, it became a municipality, and was the capital of the thoroughly Romanized province of Baetica. In the lifetime of Strabo, however (c. 63 B.C.—A.D. 21), it still ranked as the largest city of Spain. Its prosperity was due partly to its position on the Baetis, and on the Via Augusta, the great commercial road from northern Spain built by Augustus, and partly



to its proximity to mines and rich grazing and grain-producing districts. Hosius, its bishop, presided over the first council of Nicaea in 345; and its importance was maintained by the Visigothic kings, whose rule lasted from the 5th to the beginning of the 8th century. Under the Moors, Cordova was at first an appanage of the caliphate of Damascus; but after 756 Abd-ar-Rahman I. made it the capital of Moorish Spain, and the centre of an independent caliphate (see ABD-AR-RAHMAN). It reached its zenith of prosperity in the middle of the 10th century, under Abd-ar-Rahman III. At his death, it is recorded by native chroniclers, probably with Arabic exaggeration, that Cordova contained within its walls 200,000 houses, 600 mosques, 900 baths, a university, and numerous public libraries; whilst on the bank of the Guadalquivir, under the power of its monarch, there were eight cities, 300 towns and 12,000 populous villages. A period of decadence began in 1016, owing to the claims of the rival dynasties which aimed at succeeding to the line of Abd-ar-Rahman; the caliphate never won back its position, and in 1236 Cordova was easily captured by Ferdinand III. of Castile. The substitution of Spanish for Moorish supremacy rather accelerated than arrested the decline of art, industry and population; and in the 19th century Cordova never recovered from the disaster of 1808, when it was stormed and sacked by the French. Few cities of Spain, however, can boast of so long a list of illustrious natives in the Moorish and Roman periods, and even, to a less extent, in modern times. It was the birthplace of the rhetorician Marcus Annaeus Seneca, and his more famous son Lucius (c. 3 B.C.—A.D. 65); of the poet Lucan (A.D. 39–65); of the philosophers Averroes (1126–1198) and Maimonides (1135–1204); of the Spanish men of letters Juan de Mena (c. 1411–1456), Lorenzo de Sepúlveda (d. 1574) and Luis de Gongora y Argote (1561–1627); and the painters Pablo de Céspedes (1538–1608) and Juan de Valdés Leal (1630–1691). The celebrated captain Gonzalo Fernandez de Córdoba (q.v.), the conqueror of Naples (1495–1498), was born in the neighbouring town of Montilla.

See *Estudio descriptivo de los monumentos árabes de Granada y Córdoba*, by R. Contreras (Madrid, 1885); *Córdoba*, a large illustrated volume of the series *España*, by P. de Madrazo (Barcelona, 1884); *Inscripciones árabes de Córdoba*, by R. Amador de los Ríos y Villalta (Madrid, 1886).

**CORDUROY**, a cotton cloth of the fustian kind, made like a ribbed velvet. It is generally a coarse heavy material and is used largely for workmen's clothes, but some finer kinds are used for ladies' dresses, &c. According to the *New English Dictionary* the word is understood to be of English invention, "either originally intended, or soon after assumed, to represent a supposed French *corde du roi*." It is said that a coarse woollen fabric called *duroy*, made in Somerset during the 18th century, has no apparent connexion with it. From the ribbed appearance of the cloth the name *corduroy* is applied, particularly in America, to a rough road of logs laid transversely side by side, usually across swampy ground.

**CORDUS, AULUS CREMUTIUS**, Roman historian of the later Augustan age. He was the author of a history (perhaps called *Annales*) of the events of the civil wars and the reign of Augustus, embracing the period from at least 43–18 B.C. In A.D. 25 he was brought to trial for having eulogized Brutus and spoken of Cassius as the last of the Romans. His real offence was a witticism at the expense of Sejanus, who put up two of his creatures to accuse him in the senate. Seeing that nothing could save him, Cordus starved himself to death. A decree of the senate ordered that his works should be confiscated and burned by the aediles. Some copies, however, were saved by the efforts of Cordus's daughter Marcia, and after the death of Tiberius the work was published at the express wish of Caligula. It is impossible to form an opinion of it from the scanty fragments (H. Peter, *Historicorum Romanorum Fragmenta*, 1883). According to ancient authorities, the writer was very outspoken in his denunciations, and his relatives considered it necessary to strike out the most offensive passages of the work before it was widely circulated (Quintilian, *Instit.* x. 1, 104). Two passages in Pliny (*Nat. Hist.* x. 74 [37], xvi. 108 [45]) seem to refer to a work of a different nature from

the history—perhaps a treatise on *Admiranda* or remarkable things.

See Tacitus, *Annals*, iv. 34, 35; Suetonius, *Tiberius*, 61, *Caligula*, 16; Seneca, *Suasoriae*, vii., esp. the *Consolatio* to Cordus's daughter Marcia; Dio Cassius lvii. 24. There are monographs by J. Held (1841) and C. Rathlef (1860). Also H. Peter, *Die geschichtliche Literatur über die römische Kaiserzeit* (1897); Teuffel-Schwabe, *Hist. of Roman Lit.*, Eng. trans., 277, 1.

**CORELLI, ARCANGELO** (1653–1713), Italian violin-player and composer, was born on the 12th or 13th of February 1653, at Fusignano near Imola, and died in 1713. Of his life little is known. His master on the violin was Bassani. Matteo Simonelli, the well-known singer of the pope's chapel, taught him composition. His first decided success was gained in Paris at the age of nineteen. To this he owed his European reputation. From Paris Corelli went to Germany. In 1681 he was in the service of the electoral prince of Bavaria; between 1680 and 1685 he spent a considerable time in the house of his friend Farinelli. In 1685 he was certainly in Rome, where he led the festival performances of music for Queen Christine of Sweden and was also a favourite of Cardinal Ottoboni. From 1689 to 1690 he was in Modena, the duke of which city made him handsome presents. In 1708 he went once more to Rome, living in the palace of Cardinal Ottoboni. His visit to Naples, at the invitation of the king, took place in the same year. The style of execution introduced by Corelli and preserved by his pupils, such as Geminiani, Locatelli, and many others, has been of vital importance for the development of violin-playing, but he employed only a limited portion of his instrument's compass, as may be seen by his writings, wherein the parts for the violin never proceed above D on the first string, the highest note in the third position; it is even said that he refused to play, as impossible, a passage which extended to A in altissimo in the overture to Handel's *Trionfo del Tempo*, and took serious offence when the composer played the note in evidence of its practicability. His compositions for the instrument mark an epoch in the history of chamber music; for his influence was not confined to his own country. Even Sebastian Bach submitted to it. Musical society in Rome owed much to Corelli. He was received in the highest circles of the aristocracy, and arranged and for a long time presided at the celebrated Monday concerts in the palace of Cardinal Ottoboni. Corelli died possessed of a sum of 120,000 marks and a valuable collection of pictures, the only luxury in which he had indulged. He left both to his benefactor and friend, who, however, generously made over the money to Corelli's relations. Corelli's compositions are distinguished by a beautiful flow of melody and by a masterly treatment of the accompanying parts, which he is justly said to have liberated from the strict rules of counterpoint. Six collections of concerti, sonatas and minor pieces for violin, with accompaniment of other instruments, besides several concerted pieces for strings, are authentically ascribed to this composer. The most important of these is the *XII. Suonati a violino e violone o cimbalo* (Rome, 1700).

**CORELLI, MARIE** (1864– ), English novelist, was the daughter of an Italian father and a Scottish mother, but in infancy was adopted by Charles Mackay (q.v.), the song-writer and journalist, whose son Eric, at his death, became her guardian. She was sent to be educated in a French convent with the object of training her for the musical profession, and while still a girl composed various pieces of music. But her journalistic connexion proved a stronger stimulus to expression, and editors who were friends of her adopted father printed some of her early poetry. Then she produced what was at least a clever, if not a remarkably well written, romantic story, on the theme of a self-revelation connecting the Christian Deity with a world force in the form of electricity, which was published in 1886 under the title of *A Romance of Two Worlds*. It had an immediate and large sale, which resulted, naturally, in her devoting her inventive faculty to satisfy the public demand for similar work. Thus she wrote in succession a series of melodramatic romantic novels, original in some aspects of their treatment, daring in others, but all combining a readable plot with enough *au fond* of what the majority demanded in ethical and religious



correctness to suit a widespread contemporary taste; these were *Vendetta* (1886), *Thelma* (1887), *Ardath* (1889), *The Soul of Lilith* (1892), *Barabbas* (1893), *The Sorrows of Satan* (1895),—the very titles were catching,—*The Mighty Atom* (1896),—which appealed to all who knew enough of modern science to wish to think it wicked,—and others, down to *The Master Christian* (1900), again satisfying the socio-ethico-religious demand, and *Temporal Power* (1902), with its contemporary suggestion from the accession of Edward VII. Miss Corelli had the advantage of writing quite sincerely and with conviction, amid what superior critics sneered at as bad style and sensationalism, on themes which conventional readers nevertheless enjoyed, and round plots which were dramatic and vigorous. Her popular success was great and advertised itself. It was helped by a well-spread belief that Queen Victoria preferred her novels to any other. Reviewers wrote sarcastically, and justly, of her obvious literary lapses and failings; she retorted by pitying the poor reviewers and letting it be understood that no books of hers were sent to the Press for criticism. When she went to live at Stratford-on-Avon, her personality, and her importance in the literary world, became further allied with the historic associations of the place; and in the public life of women writers her utterances had the *réclame* which is emphasized by journalistic publicity. Such success is not to be gauged by purely literary standards; the popularity of Miss Corelli's novels is a phenomenon not so much of literature as of literary energy—entirely creditable to the journalistic resource of the writer, and characteristic of contemporary pleasure in readable fiction.

**CORENZIO, BELISARIO** (c. 1558–1643), Italian painter, a Greek by birth, studied at Venice under Tintoretto, and then settled at Naples, where he became famous for unscrupulous conduct as a man and rapid execution as an artist. Though careless in composition and a mannerist in style, he possessed an acknowledged fertility of invention and readiness of hand; and these qualities, allied to a certain breadth of conception, seem in the eyes of his contemporaries to have atoned for many defects. When Guido Reni came in 1621 to Naples to paint in the chapel of St Januarius, Corenzio suborned an assassin to take his life. The hired bravo killed Guido's assistant, and effectually frightened Reni, who prudently withdrew to Rome. Corenzio, however, only suffered temporary imprisonment, and lived long enough to supplant Ribera in the good graces of Don Pedro di Toledo, viceroy of Naples, who made him his court painter. Corenzio vainly endeavoured to fill Guido's place in the chapel of St Januarius. His work was adjudged to have been under the mark, and yet the numerous frescoes which he left in Neapolitan churches and palaces, and the large wall paintings which still cover the cupola of the church of Monte Casino are evidence of uncommon facility, and show that Corenzio was not greatly inferior to the *fa prestos* of his time. His florid style, indeed, seems well in keeping with the overlaid architecture and full-blown decorative ornament peculiar to the Jesuit builders of the 17th century. Corenzio died, it is said, at the age of eighty-five by a fall from a scaffolding.

**CO-RESPONDENT**, in law, generally, a person made respondent to, or called upon to answer, along with another or others, a petition or other proceeding. More particularly, since the Matrimonial Causes Act 1857, the term is applied to the person charged by a husband, when presenting a petition praying for the dissolution of his marriage on the ground of adultery, with misconduct with his wife, and made, jointly with her, a respondent to the suit. (See also **DIVORCE**.)

**CORFE CASTLE**, a town in the eastern parliamentary division of Dorsetshire, England, in the district called the Isle of Purbeck, 120½ m. S.W. by W. from London by the London & South-Western railway. Pop. (1901) 1440. The castle, through which the town is famous, guarded a gap in the line of considerable hills which rise in the centre of Purbeck. It is strongly placed on an eminence falling almost sheer on three sides. Its ruins are extensive, and date for the most part from the Norman period to the reign of Edward I. There is, however, a trace of early masonry which may have belonged to the Saxon house where,

in 978, King Edward the Martyr was murdered. Corfe Castle was held for the empress Maud against King Stephen in 1139, was frequently the residence of King John, and was a stronghold of the barons against Henry III. Edward II. was imprisoned here for a short period. The castle withstood a protracted siege by the Parliamentarians in 1643, and fell to them by treachery in 1646, after which it was dismantled and wrecked. The church in the town, almost wholly rebuilt, is dedicated to St Edward the Martyr. The quarrying of Purbeck stone and the raising of potters' clay are the chief industries.

Probably Corfe Castle (*Corfes geat*, *Corf geat*, *Corve*, *Corph*) was an early Anglo-Saxon settlement. According to William of Malmesbury the church was founded by St Aldhelm in the 7th century. In 1086 the abbey of Shaftesbury held the manor, which afterwards passed to the Norman kings, who raised the castle. Its date is disputed, but the town dependent on it seems to have grown up during the 13th century, being first mentioned in 1290, when an inquisition states that the mayor has pesage of wool and cheese. The rights of the burgesses seem to have been undefined, for frequent commissions attest to encroachments on the rights of warren, forest and wreckage belonging to the royal manor. In 1380–1381 at an inquisition into the liberties of Corfe Castle, the jurors declared that from time immemorial the constable and his steward had held all pleas and amerciements except those of the mayor's court of Pie Powder, but that the town had judgment by fire, water and combat. The tenants, or "barons," elected themselves a mayor and coroners, but the constable received the assize of ale. Elizabeth in 1577 gave exclusive admiralty jurisdiction within the island of Purbeck to Sir Christopher Hatton, and granted the mayor and "barons" of Corfe the rights they enjoyed by prescription and charter and that of not being placed on juries or assizes in matters beyond the island. Charles II. incorporated Corfe Castle in 1663, the mayor being elected at a court leet from three nominees of the lord of the manor. Corfe Castle first returned two representatives to parliament in 1572, but was disfranchised in 1832. A market for each Saturday was granted to Corfe in 1214, and in 1248 the town obtained a fair and a market on each Thursday, while Elizabeth granted fairs on the feasts of St Philip and St James and of St Luke; both of these still survive. As early as the 14th century the quarrying and export of marble gave employment to the men of Corfe, and during the 18th century the knitting of stockings was a flourishing industry.

See T. Bond, *History and Description of Corfe Castle* (London and Bournemouth, 1883).

**CORFINIUM**, in ancient Italy, the chief city of the Paeligni, 7 m. N. of Sulmona in the valley of the Aternus. The site of the original town is occupied by the village of Pentima. It probably became subject to Rome in the 4th century B.C., though it does not appear in Roman history before the Social War (90 B.C.), in which it was at first adopted by the allies as the capital and seat of government of their newly founded state under the name Italia (this form, not Italica, is vouched for by the coins). It appears also as a fortress of importance in the Civil War, though it only resisted Caesar's attack for a week (49 B.C.). Whether the Via Valeria ran as far as Corfinium before the time of Claudius is uncertain: he, however, certainly extended it to the Adriatic, and at the same time constructed a cross road, the Via Claudia Nova, which diverged from the Via Claudia Valeria at a point 6 m. farther north, and led past Peltuinum and Aveia to Foruli on the Via Salaria. Another road ran S.S.E. past Sulmo to Aesernia. It was thus an important road centre, and must have been, in the imperial period, a town of some size, as may be gathered from the inscriptions that have been discovered there, and from the extent rather than the importance of the buildings visible on the site (among them may be noted the remains of two aqueducts), which has, however, never been systematically excavated. Short accounts of discoveries will be found in *Notizie degli Scavi, passim*, and a museum, consisting chiefly of the contents of tombs, has been formed at Pentima. In one corner of a large enclosed space (possibly a *palaestra*) was constructed the church of S. Pelino.

The present building dates from the 13th century, though its origin may be traced to the end of the 5th when it was the cathedral of the see of Valva, which appears to have been the name of Corfinium at the close of the Roman period. (T. As.)

**CORFU** (anc. and mod. Gr. *Κέρκυρα* or *Κόρκυρα*, Lat. *Corcyra*), an island of Greece, in the Ionian Sea, off the coast of Albania or Epirus, from which it is separated by a strait varying in breadth from less than 2 to about 15 m. The name Corfu is an Italian corruption of the Byzantine *Κορυφή*, which is derived from the Greek *Κορυφή* (crests). In shape it is not unlike the sickle (*drepanē*), to which it was compared by the ancients,—the hollow side, with the town and harbour of Corfu in the centre, being turned towards the Albanian coast. Its extreme length is about 40 m. and its greatest breadth about 20. The area is estimated at 227 sq. m., and the population in 1907 was 99,571, of whom 28,254 were in the town and suburbs of Corfu. Two high and well-defined ranges divide the island into three districts, of which the northern is mountainous, the central undulating and the southern low-lying. The most important of the two ranges is that of San Salvador, probably the ancient Istone, which stretches east and west from Cape St Angelo to Cape St Stefano, and attains its greatest elevation of 3300 ft. in the summit from which it takes its name. The second culminates in the mountain of Santi Deca, or Santa Decca, as it is called by misinterpretation of the Greek designation of *Ἁγία Δέκα*, or the Ten Saints. The whole island, composed as it is of various limestone formations, presents great diversity of surface, and the prospects from the more elevated spots are magnificent.

Corfu is generally considered the most beautiful of all the Greek isles, but the prevalence of the olive gives some monotony to its colouring. It is worthy of remark that Homer names, as adorning the garden of Alcinous, seven plants only—wild olive, oil olive, pear, pomegranate, apple, fig and vine. Of these the apple and the pear are now very inferior in Corfu; the others thrive well and are accompanied by all the fruit trees known in southern Europe, with addition of the Japanese medlar (or loquat), and, in some spots, of the banana. When undisturbed by cultivation, the myrtle, arbutus, bay and ilex form a rich brushwood and the minor *flora* of the island is extensive.

The common form of land tenure is the *colonia perpetua*, by which the landlord grants a lease to the tenant and his heirs for ever, in return for a rent, payable in kind, and fixed at a certain proportion of the produce. Of old, a tenant thus obtaining half the produce to himself was held to be co-owner of the soil to the extent of one-fourth; and if he had three-fourths of the crop, his ownership came to one-half. Such a tenant could not be expelled except for non-payment, bad culture or the transfer of his lease without the landlord's consent. Attempts have been made to prohibit so embarrassing a system; but as it is preferred by the agriculturists, the existing laws permit it. The portion of the olive crop due to the landlord, whether by *colonia* or ordinary lease, is paid, not according to the actual harvest, but in keeping with the estimates of valuers mutually appointed, who, just before the fruit is ripe, calculate how much each tree will probably yield. The large old fiefs (*baronie*) in Corfu, as in the other islands, have left their traces in the form of quit-rents (known in Scotland by the name of feu-duties), generally equal to one-tenth of the produce. But they have been much subdivided, and the vassals may by law redeem them. Single olive trees of first quality yield sometimes as much as 2 gallons of oil, and this with little trouble or expense beyond the collecting and pressing of the fallen fruit. The trees grow unrestrained, and some are not less than three hundred years old. The vineyards are laboured by the broad heart-shaped hoe. The vintage begins on the festival of Santa Croce, or the 26th of September (O.S.). None of the Corfu wines is much exported. The capital is the only city or town of much extent in the island; but there are a number of villages, such as Benizze, Gasturi, Ipso, Glypho, with populations varying from 300 to 1000. Near Gasturi stands the Achilleion, the palace built for the Empress Elizabeth of Austria, and purchased in 1907 by the German emperor, William II.

The town of Corfu stands on the broad part of a peninsula, whose termination in the citadel is cut from it by an artificial fosse formed in a natural gully, with a salt-water ditch at the bottom. Having grown up within fortifications, where every foot of ground was precious, it is mostly, in spite of recent improvements, a labyrinth of narrow, tortuous, up-and-down streets, accommodating themselves to the irregularities of the ground, few of them fit for wheel carriages. There is, however, a handsome esplanade between the town and the citadel, and a promenade by the seashore towards Castrades. The palace, built by Sir Thomas Maitland (?1759–1824; lord high commissioner of the Ionian Islands, 1815), is a large structure of white Maltese stone. In several parts of the town may be found houses of the Venetian time, with some traces of past splendour, but they are few, and are giving place to structures in the modern and more convenient French style. Of the thirty-seven Greek churches the most important are the cathedral, dedicated to Our Lady of the Cave (*ἡ Παναγία Σπηλιώτισσα*); St Spiridon's, with the tomb of the patron saint of the island; and the suburban church of St Jason and St Sospater, reputed the oldest in the island. The city is the seat of a Greek and a Roman Catholic archbishop; and it possesses a gymnasium, a theatre, an agricultural and industrial society, and a library and museum preserved in the buildings formerly devoted to the university, which was founded by Frederick North, 5th earl of Guilford (1766–1827, himself the first chancellor in 1824,) in 1823, but disestablished on the cessation of the English protectorate. There are three suburbs of some importance—Castrades, Manduchio and San Rocco. The old fortifications of the town, being so extensive as to require a force of from 10,000 to 20,000 troops to man them, were in great part thrown down by the English, and a simpler plan adopted, limiting the defences to the island of Vido and the old citadel; these are now dismantled.

*History.*—According to the local tradition Corcyra was the Homeric island of Scheria, and its earliest inhabitants the Phaeacians. At a date no doubt previous to the foundation of Syracuse it was peopled by settlers from Corinth, but it appears to have previously received a stream of emigrants from Eretria. The splendid commercial position of Corcyra on the highway between Greece and the West favoured its rapid growth, and, influenced perhaps by the presence of non-Corinthian settlers, its people, quite contrary to the usual practice of Corinthian colonies, maintained an independent and even hostile attitude towards the mother city. This opposition came to a head in the early part of the 7th century, when their fleets fought the first naval battle recorded in Greek history (about 664 B.C.). These hostilities ended in the conquest of Corcyra by the Corinthian tyrant Periander (c. 600), who induced his new subjects to join in the colonization of Apollonia and Anactorium. The island soon regained its independence and henceforth devoted itself to a purely mercantile policy. During the Persian invasion of 480 it manned the second largest Greek fleet (60 ships), but took no active part in the war. In 435 it was again involved in a quarrel with Corinth and sought assistance from Athens. This new alliance was one of the chief immediate causes of the Peloponnesian War (q.v.), in which Corcyra was of considerable use to the Athenians as a naval station, but did not render much assistance with its fleet. The island was nearly lost to Athens by two attempts of the oligarchic faction to effect a revolution; on each occasion the popular party ultimately won the day and took a most bloody revenge on its opponents (427 and 425). During the Sicilian campaigns of Athens Corcyra served as a base for supplies; after a third abortive rising of the oligarchs in 410 it practically withdrew from the war. In 375 it again joined the Athenian alliance; two years later it was besieged by a Lacedaemonian armament, but in spite of the devastation of its flourishing countryside held out successfully until relief was at hand. In the Hellenistic period Corcyra was exposed to attack from several sides; after a vain siege by Cassander it was occupied in turn by Agathocles and Pyrrhus. It subsequently fell into the hands of Illyrian corsairs, until in 229 it was delivered by the Romans, who retained it as a naval

station and gave it the rank of a free state. In 31 B.C. it served Octavian (Augustus) as a base against Antony.

Eclipsed by the foundation of Nicopolis, Corcyra for a long time passed out of notice. With the rise of the Norman kingdom in Sicily and the Italian naval powers, it again became a frequent object of attack. In 1081-1085 it was held by Robert Guiscard, in 1147-1154 by Roger II. of Sicily. During the break-up of the Later Roman Empire it was occupied by Genoese privateers (1197-1207) who in turn were expelled by the Venetians. In 1214-1259 it passed to the Greek despots of Epirus, and in 1267 became a possession of the Neapolitan house of Anjou. Under the latter's weak rule the island suffered considerably from the inroads of various adventurers; hence in 1386 it placed itself under the protection of Venice, which in 1401 acquired formal sovereignty over it. Corcyra remained in Venetian hands till 1797, though several times assailed by Turkish armaments and subjected to two notable sieges in 1536 and 1716-1718, in which the great natural strength of the city again asserted itself. The Venetian feudal families pursued a mild but somewhat enervating policy towards the natives, who began to merge their nationality in that of the Latins and adopted for the island the new name of Corfu. The Corfiotes were encouraged to enrich themselves by the cultivation of the olive, but were debarred from entering into commercial competition with Venice. The island served as a refuge for Greek scholars, and in 1732 became the home of the first academy of modern Greece, but no serious impulse to Greek thought came from this quarter.

By the treaty of Campo Formio Corfu was ceded to the French, who occupied it for two years, until they were expelled by a Russo-Turkish armament (1799). For a short time it became the capital of a self-governing federation of the Heptanesos ("Seven Islands"); in 1807 its faction-ridden government was again replaced by a French administration, and in 1809 it was vainly besieged by a British fleet. When, by the treaty of Paris of November 5, 1815, the Ionian Islands were placed under the protectorate of Great Britain, Corfu became the seat of the British high commissioner. The British commissioners, who were practically autocrats in spite of the retention of the native senate and assembly, introduced a strict method of government which brought about a decided improvement in the material prosperity of the island, but by its very strictness displeased the natives. In 1864 it was, with the other Ionian Islands, ceded to the kingdom of Greece, in accordance with the wishes of the inhabitants. The island has again become an important point of call and has a considerable trade in olive oil; under a more careful system of tillage the value of its agricultural products might be largely increased.

Corfu contains very few and unimportant remains of antiquity. The site of the ancient city of Corcyra (Κέρκυρα) is well ascertained, about 1½ m. to the south-east of Corfu, upon the narrow piece of ground between the sea-lake of Calichiopulo and the Bay of Castrades, in each of which it had a port. The circular tomb of Menecrates, with its well-known inscription, is on the Bay of Castrades. Under the hill of Ascension are the remains of a temple, popularly called of Neptune, a very simple Doric structure, which still in its mutilated state presents some peculiarities of architecture. Of Cassiope, the only other city of ancient importance, the name is still preserved by the village of Cassopo, and there are some rude remains of building on the site; but the temple of Zeus Cassius for which it was celebrated has totally disappeared. Throughout the island there are numerous monasteries and other buildings of Venetian erection, of which the best known are Paleocastrizza, San Salvador and Pelleka.

**AUTHORITIES.**—Strabo vi. p. 269; vii. p. 329; Herodotus vii. 168; Thucydides i.-iii.; Xenophon, *Hellenica*, vi. 2; Polybius ii. 9-11; Plutarch, *Quæstiones Græcæ*, ch. xi.; H. Jervis, *The Ionian Islands during the Present Century* (London, 1863); D. F. Ansted, *The Ionian Islands in the Year 1863* (London, 1863); Riemann, *Recherches archéologiques sur les Îles ioniennes* (Paris, 1879-1880); J. Partsch, *Die Insel Korfu* (Gotha, 1887); B. Schmidt, *Korkyräische Studien* (Leipzig, 1890); B. V. Head, *Historia Numorum* (Oxford, 1887), pp. 275-277; H. Lutz in *Philologus*, 56 (1897), pp. 71-77; also art. **NUMISMATICS:** *Greek*, § "Epirus." (E. Gr.; M. O. B. C.)

**CORI** (anc. *Cora*), a town and episcopal see of the province of Rome, Italy, 36 m. S.E. by rail from the town of Rome, on the lower slopes of the Volscian mountains, 1300 ft. above sea-level. Pop. (1901) 6463. It occupies the site of the ancient Volscian town of Cora, the foundation of which is by classical authors variously ascribed to Trojan settlers, to the Volscians (with a later admixture of Latins), and to the Latins themselves. The last is more probable (though in that case it was the only town of the Prisci Latini in the Volscian hills), as it appears among the members of the Latin league. Coins of Cora exist, belonging at latest to 350-250 B.C. It was devastated by the partisans of Marius during the struggle between him and Sulla. Before the end of the Republic it had become a *municipium*. It lay just above the older road from Velitrae to Terracina, which followed the foot of the Volscian hills, but was 6 m. from the Via Appia, and it is therefore little mentioned by classical writers. It is comparatively often spoken of in the 4th century, but from that time to the 13th we hear hardly anything of it, as though it had almost ceased to exist. The remains of the city walls are considerable: three different *enceintes*, one within the other, enclose the upper and lower town and the acropolis. They are built in Cyclopean work, and different parts vary considerably in the roughness or fineness of the jointing and hewing of the blocks; but explorations at Norba (*q.v.*) have proved that inferences as to their relative antiquity based upon such considerations are not to be trusted. There is a fine single-arched bridge, now called the Ponte della Catena, just outside the town on the way to Norba, to which an excessively early date is often assigned.

At the summit of the town is a beautiful little Doric tetrastyle temple, belonging probably to the 1st century B.C., built of limestone with an inscription recording its erection by the *duumviri*. It is not known to what deity it was dedicated; and there is no foundation for the assertion that the porphyry statue of Minerva (or Roma) now in front of the Palazzo del Senatore, at Rome, was found here in the 16th century. Lower down are two columns of a Corinthian temple dedicated to Castor and Pollux, as the inscription records. The church of Santa Oliva stands upon the site of a Roman building. The cloister, constructed in 1466-1480, is in two storeys; the capitals of the columns are finely sculptured by a Lombard artist (G. Giovannoni in *L'Arte*, 1906, p. 108). There are remains of several other ancient buildings in the modern town, especially of a series of large cisterns probably belonging to the imperial period. Some interesting frescoes of the Roman school of the 15th century are to be found in the chapel of the Annunziata outside the town (F. Hermanin in *L'Arte*, 1906, p. 45).

See G. B. Piranesi, *Antichità di Cora* (Rome, n.d., c. 1770); A. Nibby, *Analisi della Carta dei Dintorni di Roma* (Rome, 1848), i. 487 seq. (T. As.)

**CORIANDER**, the fruit, improperly called seed, of an umbelliferous plant (*Coriandrum sativum*), a native of the south of Europe and Asia Minor, but cultivated in the south of England, where it is also found as an escape, growing apparently wild. The name is derived from the Gr. *kópis* (a bug), and was given on account of its foetid, bug-like smell. The plant produces a slender, erect, hollow stem rising 1 to 2 ft. in height, with bipinnate leaves and small flowers in pink or whitish umbels. The fruit is globular and externally smooth, having five indistinct ridges, and the mericarps, or half-fruits, do not readily separate from each other. It is used in medicine as an aromatic and carminative, the active principle being a volatile oil, obtained by distillation, which is isomeric with Borneo camphor, and may be given in doses of ½ to 3 minims. On account of its pleasant and pungent flavour it is a favourite ingredient in hot curries and sauces. The fruit is also used in confectionery, and as a flavouring ingredient in various liqueurs. The essential oil on which its aroma depends is obtained from it by distillation. The tender leaves and shoots of the young plant are used in soups and salads.

**CORINGA**, a seaport of British India, in the district of Godavari and presidency of Madras, on the estuary of a branch of the

Godavari river. The harbour is protected from the swell of the sea by the southward projection of Point Godavari, and affords a shelter to vessels during the south-west monsoon; but though formerly the most important on this coast it has been silted up and lost its trade. The repairing and building of small coasting ships is an industry at Tallarevu in the vicinity. In 1787 a gale from the north-east occasioned an inundation which swept away the greater part of Coringa with its inhabitants; and in 1832 another storm desolated the place, carrying vessels into the fields and leaving them aground. Of Europeans the Dutch were the first to establish themselves at Coringa. In 1759 the English took possession of the town, and erected a factory 5 m. to the south of it.

**CORINNA**, surnamed "the Fly," a Greek poetess, born at Tanagra in Boeotia, flourished about 500 B.C. She is chiefly known as the instructress and rival of Pindar, over whom she gained the victory in five poetical contests. According to Pausanias (ix. 22. 3), her success was chiefly due to her beauty and her use of the local Boeotian dialect. The extant fragments of her poems, dealing chiefly with mythological subjects, such as the expedition of the Seven against Thebes, will be found in Bergk's *Poëtae Lyrici Graeci*.

Some considerable remains of two poems on a 2nd-century papyrus (*Berliner Klassikertexte*, v., 1907) have also been attributed to Corinna (W. H. D. Rouse's *Year's Work in Classical Studies*, 1907; J. M. Edmonds, *New Fragm. of . . . and Corinna*, 1910).

**CORINTH**, a city of Greece, situated near the isthmus (see **CORINTH, ISTHMUS OF**) which connects Peloponnesus and central Greece, and separates the Saronic and the Corinthian gulfs on E. and W. The ancient town stood 1½ m. from the latter, in a plain extending westward to Sicyon. The citadel, or Acrocorinthus, rising precipitously on the S. to a height of 1886 ft. was separated by a ravine from Oneium, a range of hills which runs E. to the isthmus entrance. Between this ridge and the offshoots of Geraneia opposite a narrow depression allowed of easy transit across the Isthmus neck. The territory of Corinth was mostly rocky and unfertile; but its position at the head of two navigable gulfs clearly marked it out as a commercial centre. Its natural advantages were enhanced by the "Diolcus" or tram-road, by which ships could be hauled across the Isthmus. It was connected in historic times with its western port of Lechaëum by two continuous walls, with Cenchreae and Schoenus on the east by chains of fortifications. The city walls attained a circuit of 10 m.

**I. History.**—In mythology, Corinth (originally named Ephyre) appears as the home of Medea, Sisyphus and Bellerophon, and already has over-sea connexions which illustrate its primitive commercial activity. Similarly the early presence of Phoenician traders is attested by the survival of Sidonian cults (Aphrodite Urania, Athena Phoenice, Melicertes, *i.e.* Melkarth). In the Homeric poems Corinth is a mere dependency of Mycenae; nor does it figure prominently in the tradition of the Dorian migrations. Though ultimately conquered by the invaders it probably retained much of its former "Ionian" population, whose god Poseidon continued to be worshipped at the national Isthmian games throughout historic times; of the eight communal tribes perhaps only three were Dorian. Under the new dynasty of Aletes, which reigned according to tradition from 1074 to 747, Corinthian history continues obscure. The government subsequently passed into the hands of a small corporation of nobles descended from a former king Bacchis, and known as the Bacchidae, who nominated annually a Prytanis (president) from among their number. The maritime expansion of Corinth at this time is proved by the foundation of colonies at Syracuse and Corcyra, and the equipment of a fleet of triremes (the newly invented Greek men-of-war) to quell a revolt of the latter city.

But Corinth's real prosperity dates from the time of the tyranny (657–581), established by a disqualified noble Cypselus (*q.v.*) and continued under his son Periander (*q.v.*). Under these remarkable men, whose government was apparently mild, the city rapidly developed. She extended her sphere of influence throughout the coast-lands of the western gulf; by the settle-

ment of numerous colonies in N.W. Greece she controlled the Italian and Adriatic trade-routes and secured a large share of the commerce with the western Greeks. In Levantine waters connexions grew up with the great marts of Chalcis and Miletus, with the rulers of Lydia, Phrygia, Cyprus and Egypt. As an industrial centre Corinth achieved pre-eminence in pottery, metal-work and decorative handicraft, and was the reputed "inventor" of painting and tiling; her bronze and her pottery, moulded from the soft white clay of Oneium, were widely exported over the Mediterranean. The chief example of her early art was the celebrated "chest of Cypselus" at Olympia, of carved cedar and ivory inlaid with gold. The city was enriched with notable temples and public works (see § *Archaeology*), and became the home of several Cyclic poets and of Arion, the perfecter of the dithyramb.

The tyranny was succeeded by an oligarchy based upon a graduated money qualification, which ruled with a consistency equalling that of the Venetian Council, but pursued a policy too purely commercial to the neglect of military efficiency. Late in the 6th century Corinth joined the Peloponnesian league under Sparta, in which her financial resources and strategic position secured her an unusual degree of independence. Thus the city successfully befriended the Athenians against Cleomenes I. (*q.v.*), and supported them against Aegina, their common commercial rival in eastern waters. In the great Persian war of 480 Corinth served as the Greek headquarters: her army took part at Thermopylae and Plataea and her navy distinguished itself at Salamis and Mycale. Later in the century the rapid development of Athenian trade and naval power became a serious menace. In 459 the Corinthians, in common with their former rivals the Aeginetans, made war upon Athens, but lost both by sea and land. Henceforward their Levantine commerce dwindled, and in the west the Athenians extended their rivalry even into the Corinthian Gulf. Though Syracuse remained friendly, and the colonies in the N.W. maintained a close commercial alliance with the mother-city, the disaffection of Corcyra hampered the Italian trade. The alliance of this latter power with Athens accentuated the rising jealousy of the Corinthians, who, after deprecating a federal war in 440, virtually forced Sparta's hand against Athens in 432. In the subsequent war Corinth displayed great activity in the face of heavy losses, and the support she gave to Syracuse had no little influence on the ultimate issue of the war (see **PELOPONNESIAN WAR**). In 395 the domineering attitude of Sparta impelled the Corinthians to conclude an alliance with Argos which they had previously contemplated on occasions of friction with the former city, as well as with Thebes and with Athens, whose commercial rivalry they no longer dreaded. In the ensuing "Corinthian War" the city suffered severely, and the war-party only maintained itself by the help of an Argive garrison and a formal annexation to Argos. Since 387 the Spartan party was again supreme, and after Leuctra Corinth took the field against the Theban invaders of Peloponnesus (371–366). In 344 party struggles between oligarchs and democrats led to a usurpation by the tyrant Timophanes, whose speedy assassination was compassed by his brother Timoleon (*q.v.*).

After the campaign of Chaeronea, Philip II. of Macedon summoned a Greek congress at Corinth and left a garrison on the citadel. This citadel, one of the "fetters of Greece," was eagerly contended for by the Macedonian pretenders after Alexander's death; ultimately it fell to Antigonos Gonatas, who controlled it through a tyrant. In 243 Corinth was freed by Aratus and incorporated into the Achaean league. After a short Spartan occupation in 224 it was again surrendered to Macedonia. T. Quinctius Flaminius, after proclaiming the liberty of Greece at the Isthmus, restored Corinth to the league (196). With the revival of its political and commercial importance the city became the centre of resistance against Rome. In return for the foolish provocation of war in 146 B.C. the Roman conquerors despoiled Corinth of its art treasures and destroyed the entire settlement: the land was partly made over to Sicyon and partly became public domain.

In 46 Julius Caesar re-peopled Corinth with Italian freedmen and dispossessed Greeks. Under its new name *Lous Julii* and an Italian constitution it rapidly recovered its commercial prosperity. Augustus made it the capital of Achaëa; Hadrian enriched it with public works. Its prosperity, as also its profligacy, is attested by the New Testament, by Strabo and Pausanias. After the Gothic raids of 267 and 395 Corinth was secured by new fortifications at the Isthmus. Though restricted to the citadel, the medieval town became the administrative and ecclesiastical capital of Peloponnesus, and enjoyed a thriving trade and silk industry until in 1147 it was sacked by the Normans. In 1210 it was joined to the Latin duchy of the Morea, and subsequently was contended for by various Italian pretenders. Since the Turkish conquest (1459) the history of Corinth has been uneventful, save for a raid by the Maltese in 1611 and a Venetian occupation from 1687 to 1715.

**AUTHORITIES.**—Strabo, pp. 378-382; Pausanias ii. 1-4; Curtius, *Peloponnesos* (Gotha, 1851), ii. 514-556; E. Wilisch, *Die Altgriechische Thonindustrie* (Leipzig, 1892) and *Geschichte Korinths* (1887, 1896, 1901); G. Gilbert, *Griechische Staatsaltertümer* (Leipzig, 1885), ii. pp. 87-91. (M. O. B. C.)

**II. Archaeology and Modern Town.**—The modern town of New Corinth, the head of a district in the province of Corinth (pop. 71,229), is situated on the Isthmus of Corinth near the south-eastern recess of the Gulf of Corinth,  $3\frac{1}{2}$  m. N.E. from the site of the ancient city. It was founded in 1858, when Old Corinth was destroyed by an earthquake. It is connected by railway with Athens (57 m.), with Patras (80 m.), and with Nauplia (40 m.), the capital of Argolis. Communication by sea with Athens, Patras, the Ionian Islands and the shores of the Ambracian Gulf, is constant since the opening of the Corinthian ship canal, in 1893. It has not, however, attained great prosperity. It has broad streets and low houses, but is architecturally unattractive, like most of the creations of the time of King Otto. Its chief exports are seedless grapes ("currants"), olive-oil, silk and cereals. Pop. (1905) about 4300.

Old Corinth passed through its various stages, Greek, Roman, Byzantine, Turkish. After the War of Liberation it was again Greek, and, being a considerable town, was suggested as the capital of the new kingdom of Greece. The earthquake of 1858 levelled it to the ground with the exception of about a dozen houses. A mere handful of the old inhabitants remained on the site. But fertile fields and running water made it attractive; and outsiders gradually came in. At present it is an untidy, poverty-stricken village of about 1000 inhabitants, mostly of Albanian blood. Like the ancient city, it spreads out over two terraces, one about 100 ft. above the other. These were formed in different geological ages by the gulf, which had in historical times receded to a distance of  $1\frac{1}{4}$  m. from the city. At the nearest point to the city was laid out the harbour, Lechaëum, a basin dug far into the shore and joined with the city by long walls. At about the middle of the two terraces,  $1\frac{1}{2}$  m. long, the edge of the upper one was worn back into a deep indentation, probably by running water, possibly by quarrying. Here was the heart of the ancient city. At the lower end of the indentation is the modern public square, shaded by a gigantic and picturesque plane tree, nourished by the surplus water of Pirene. As the visitor looks from the square up the indentation he sees on a height to the right a venerable temple ruin, and, directly in front, Acro-Corinth, rising over 1500 ft. above the village. Even from the village, the view over the gulf, including Parnassus with its giant neighbours on the N., Cyllene and its neighbours on the W., and Geraneia on the N.E., is very fine. But from Acro-Corinth the view is still finer, and is perhaps unsurpassed in Greece.

The excavations begun in 1896 by the American school of Classical Studies at Athens, under the direction of Rufus B. Richardson, have brought to light important monuments of the ancient city, both Greek and Roman.

The first object was the locating of the agora, or public square, first because Pausanias says that most of the important monuments of the city were either on or near the agora; and secondly because, beginning with the agora, he mentions, sometimes with

a brief description, the principal monuments in order along three of the principal thoroughfares radiating from it. In the first year's work twenty-one trial trenches were dug in the hope of finding a clue to its position. Somewhat less than a quarter of a mile to the N.W. of the temple, set back into the edge of the upper terrace, there was found, under 20 ft. of soil, a ruined Roman theatre built upon the ruins of a Greek theatre. This theatre was, according to Pausanias, on the street leading from the agora towards Sicyon, and so to the west of the agora. Another trench dug across the deep indentation to the E. of the temple revealed a broad limestone pavement leading from the very northern edge of the city up through the indentation, in the direction of Acro-Corinth. It required little sagacity to

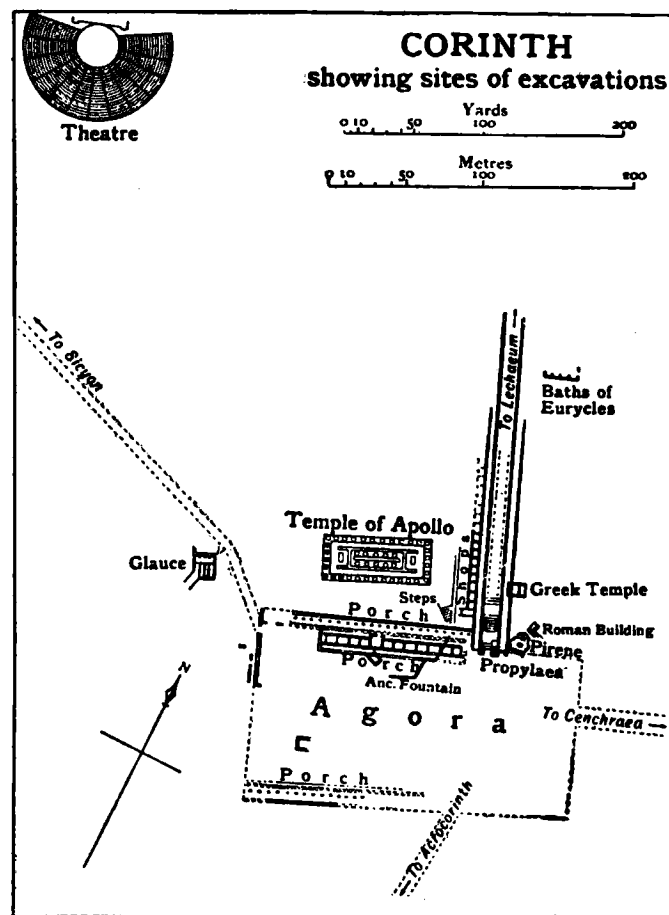

identify it with the street mentioned by Pausanias as leading from the agora towards Lechaëum. It was practically certain that by following up this pavement to its point of intersection with the road from Sicyon the agora would be discovered.

The limestone pavement, with long porches on either side, was found to stop at the foot of a marble staircase of thirty-four steps of Byzantine construction, underneath which appeared a Roman arrangement of the two flights with a platform halfway up. The top flight led up to the propylaea. The remains of the propylaea above ground are few; but the foundations are massive and well laid, at the end of the upper terrace where it is farthest worn back. These foundations are clearly those of a Roman triumphal arch, which perhaps took the name "propylaea" from an ancient Greek structure on the same spot. This arch appears on Roman coins from Augustus to Commodus; according to Pausanias it bore two four-horse chariots, one driven by Helios and the other by Phaëthon, his son, all in gilded bronze.

Although a considerable part of the agora has been excavated, none of the statues which Pausanias saw in it have been discovered. On the upper (S.) side are excellent foundations of a long porch. On the N. side, stretching westward from the



propylaea, are two porches of different periods. The older one, which still existed in Roman times, was backed up against the temple hill, which was cut away to make room for it. An ancient staircase, 15 ft. broad, led down from the temple hill into the lower area of the broad pavement, from which access to the agora and the Pirene was easy.

To the E. of the paved road and close up against the agora itself, only at a much lower level, was found, buried under 35 ft. of earth, the famous fountain Pirene, tallying exactly with the description of Pausanias, as "a series of chambers that are like caves, and bearing a façade of white marble." This Pirene originally had a two-storey façade of Roman fashion made of limestone, but, before the time of Pausanias, it had received a covering of marble which has now fallen off, but has left traces of itself in the holes drilled into the limestone, in the rough hacking away of the half columns, and in the numerous marble fragments which lay in front of the façade. This was not, however, the earliest form of Pirene. It was built up in front of a more simple Greek fountain-structure which consisted of seven cross-walls placed under the edge of the stratum forming the upper terrace. Six chambers were thus formed which showed the chaste beauty of Greek workmanship, while the stratum of native rock which covered them gave a touch of nature and made them caves. The walls ended at the front in the form of an *antæ* delicately carved. On a parapet at the rear of each chamber a single slender Ionic column between two *antæ* supported an Ionic entablature. The stuccoed walls were striped horizontally and vertically with red on a blue field, on which appear fishes swimming. The chambers were really reservoirs, filled by the water which flowed along their backs.

We know nothing further about the Greek system, but in the Roman adjustment the water was led from this series of cisterns into a large rectangular basin which formed the centre of a quadrangle 50 ft. square. In the N.E. corner is a hole through which it was drained, and at the N. end a flight of five steps led down into it. Besides the four orifices through which water flowed into it there were two other holes about 4 in. lower down to keep the basin from overflowing. Two uses of water are mentioned by Pausanias. "The water," he says, "was sweet to drink," and also good for tempering bronze. It seems clear then, that the basin was at stated times used for the latter purpose, and was converted into a tank. The bronze was plunged into the water in a red hot condition, and thus acquired its peculiar excellence.

In Byzantine times five columns, of various diameters, with no two bases of the same size, bearing Corinthian capitals, were set up about 6 ft. in front of the façade. Blocks of marble which had seen use elsewhere ran from them back into the façade, which was hacked away in rough fashion to receive them. Probably these blocks formed the floor of a balcony, a tawdry marble addition.

Pirene was at all times the heart of the city. Here it was that Athena helped Bellerophon to bridle Pegasus; and hence she received the epithet of "the Bridler," Chalinitis. The importance of the fountain is attested by the fact that the Greek poets and the Delphic oracle instead of saying Corinth said, "the city of Pirene." That it was a place of common resort is shown by Euripides (*Medea*, 68 f.), where it is said that the elders were to be found "near the august waters of Pirene, playing draughts (*παισι*)." The quadrangle, with its walls 20 ft. high, and its three apses probably covered with half domes, provided considerable shade. There is reason for supposing that the marble coating of the façade, and perhaps the erection of the quadrangle, also covered with marble, were the work of Herodes Atticus, and therefore just completed when Pausanias saw them. A base on which stood a statue of Herodes' wife, Regilla, was found close to the façade, inscribed with fulsome praise, stating that the statue was "set up by order of the Sisyphaean Senate at the outpouring of the streams." Two inscriptions of Roman times make the identity of Pirene certain, if there could be any doubt in the face of the exact agreement of Pausanias's description with the structure.

Of the surviving monuments of the Greek city the most important is the temple of Apollo. While it was probably badly wrecked by the Romans at the sack of the city, its massive columns with the entablature survived. That it was restored and was in use in Roman time is shown by the fact that both the seven columns still standing and two fallen columns discovered in the excavations, to say nothing of several fragments of others, have a thick coating of Roman stucco laid over the finer Greek. The style of the temple points to 600 B.C., when Periander was at the height of his power. According to Herodotus he made his doubtful adherents deposit pledges of faithfulness in the temple of Apollo. Quite near the W. end of the temple is the fountain Glaucē cut out of a cube of rock, apparently left standing when the material for the temple was quarried around it. In it were carved out four chambers or reservoirs all connected and a porch consisting of three pillars between two *antæ* in which the side walls ended. The water coming down from Acro-Corinth was introduced from behind. Approached by a flight of steps partly rock-cut, it had at the rear of the porch a balustrade with marble lions' heads through which the water overflowed. Two of these heads were found. The top of the system of reservoirs was too heavy for the slender cross walls and pillars, only the stumps of which remain; a collapse took place, by which the porch and the W. compartment were carried away. From its location only about 50 yds. from the temple it seems to have been the temple fountain. It was named after the second wife of Jason, Glaucē, who plunged into it to quench the fire of the poisoned bridal garments given her by Medea.

It is not surprising that monuments were found of which there is no record in ancient writings. Such was a very ancient fountain W. of the propylaea, 25 ft. below the surface. Under remains of the Roman city appeared a triglyphon of porous stone with an extent from N. to S. of about 30 ft. At the N. end it turned westward at an obtuse angle and extended about 10 ft. in that direction. The system is about 4 ft. high. While the colours on the metopes and triglyphs had faded somewhat, the border above them, topped with a cornice projecting 6 in., retained a most brilliant meander pattern of red, blue and yellow, while below these were two bands of godroons of blue and red. On the top of this system as a foundation were set several statue bases, one bearing the signature of Lysippus, which shows that the system stood there at least as early as the 4th century B.C. Some parts of it may have been taken from older buildings, but not the cornice nor the corner metope block which formed an obtuse angle. Near the middle of the long side is an opening; and from it a flight of seven steps led down to a trapezoidal chamber, on the back wall of which are two lions' heads of bronze, through which water, conducted in long semi-cylindrical channels of bronze, from behind the wall, poured out into pitchers for which holes are cut in the floor. Channels for the overflow were cut along the back and sides of the chamber. All this was once approached from the front at the level of the floor, long before the triglyphon was set up, 7 ft. above it. Considering its depth this fountain must be dated back to the 5th century, probably near the beginning. The style of the lions' heads would hardly admit a later date. This is the only case of an ancient Greek fountain of such an early date, unaltered and intact. The pains taken to preserve it suggest that it was invested with a sacred character.

Sculptures in large numbers, both of the Greek city and the Roman, are collected in the new museum erected by the Greek government near the plane tree. The finest of the Greek sculptures is the head of a youth found in the orchestra of the theatre at a depth of 23 ft. It lacks only the lower part of the bridge of the nose, and has style and character, resembling Myron's heads in shape and in the hair. A large fragment of a relief also of early date, represents two dancing maenads half life-size. Most impressive is a colossal female figure of grand style and excellent drapery. If not an original of the 5th century it is one of the finest of copies. Of the great amount of Roman sculpture the best single piece is a head of Dionysus under the



influence of wine, crowned with a wreath of ivy, his right hand thrown carelessly over his head. The fine execution is all that differentiates it from the numerous copies in various museums. The most important sculptures of the Roman period, however, are a group of colossal figures supporting an entablature, a large part of which has been recovered. One of the figures, a barbarian captive, effeminate like those which appear on Roman triumphal arches, is practically intact. Another, its counterpart, is preserved down to the hips. These differ from Caryatids, which bear the architrave on their heads. Here a pilaster forming the back of the figure receives a Corinthian capital, upon which the architrave rests; and the figures merely brace up the pilaster. Two of these figures stood at the end of a re-entrant curve, several pieces of which are preserved. Two female heads of like proportions belong to the system, since the backs of their heads are cut away in the same manner as the male heads. The building to which the figures belonged, a porch, extended westward from the propylaea; and may be traced for 45 ft. All that is left of it is the core of *opus incertum*.

The excavations brought to light vases and fragments of vases, of nearly every period except the Mycenaean. On the N. side of the hill on which stands the village schoolhouse, from which one looks across the indentation to the Apollo temple, several vertical shafts in the limestone stratum were found, and underneath it in horizontal passages were bodies surrounded with vases. These are pre-Mycenaean, and their only ornament is scratches, into which white matter has been pressed. There are over fifty of these vases, of multiform shapes. By the side of the Lechaem road, near the steps leading to the propylaea, were found in deep diggings thirteen early Geometric vases. Proto-Corinthian vases also were everywhere strongly represented. The best find of pottery, however, was an Old Corinthian celebē (κέλεβη, drinking vessel), about a foot high, in forty-six fragments, found in a well, 30 ft. below the surface. On one side are a boar and a leopard confronting each other, and on the other side two cocks in the same heraldic arrangement. On the projecting plates supported by the handles are palmettes.

Two inscriptions in the Old Corinthian alphabet came to light. But, on the whole, inscriptions before the Roman times were almost entirely lacking. One inscription, though of late date, deserves mention. On a marble block broken away at both ends, which in a second use was a lintel, we read ΑΓΩΓΗΕΒΡ, which can only be συναγωγή Ἑβραίων (synagogue of the Hebrews).

The excavations were confined to a small part of the city, but there is little doubt that it was the most important part. By good fortune the earth here was very deep. On the high level of the agora and the Apollo temple, where the depth of earth is comparatively slight, there is little hope of important finds. There is no hope of finding the great bronze Athena, which stood in the middle of the agora. To the west, beyond the theatre, one might find the temple of Athena Chalinitis and the fountain Lerna, and somewhere near Glaucē, the Odeum and the tomb of Medea's children; but it is more likely that they have disappeared. On the Lechaem road, on which a bewildering wealth of fountains and statues is enumerated, only the Baths of Eurycles below the plane tree were found; deep diggings were made into them, and the foundations of the façade laid bare. This great complex was apparently supplied with water from Hadrian's aqueduct from Lake Stympalus. On the street going eastward from the agora nothing is mentioned between it and the city wall. This level eastern part was probably given up to fine houses, all traces of which have perished. Outside the gate, apparently, was the famous Craneion, shaded by cypress trees, and near it the tombs of Lais and Diogenes, a precinct of Bellerophon and of Athena Melaenis. The number of temples and shrines enumerated by Pausanias along the road leading up to Acro-Corinth is bewildering. Here were represented Isis and Serapis, Helios, the Mother of the Gods, the Fates, Demeter and Persephone; but no trace of these temples remains. At the highest point of the road, according to Pausanias, there stood the famous temple of Aphrodite, but the remains excavated at this point seem to be

those of a late tower, and the few foundations below it do not resemble those of a temple. We are equally unfortunate in regard to Strabo's splendid marble Sisyphaeum just below the summit. The fountain Pirene, "behind the temple," still exists, but so much earth has accumulated about it that one now approaches it by going down a ladder. The water is so crystal clear that one inadvertently steps into it. The identity of name with that of Pirene in the city is justified by the fact that the upper spring is the source of the Pirene below.

See, for details, the *American Journal of Archaeology* (from 1896). (R. B. R.)

**CORINTH**, a city and the county-seat of Alcorn county, Mississippi, U.S.A., situated in the N.E. part of the state, about 90 m. E. by S. of Memphis, Tennessee. Pop. (1890) 2111; (1900) 3661 (1174 negroes); (1910) 5020. It is served by the Mobile & Ohio and the Southern railways; and by a branch of the Illinois Central connecting Jackson, Miss., and Birmingham, Ala. It has woollen mills, cotton compresses, clothing, furniture, and spoke and stave factories and machine shops, and is a cotton market. Because of its situation and its importance as a railway junction, Corinth played an important part in the western campaigns of the Civil War. After the first Confederate line of defence had been broken by the capture of Fort Henry and Fort Donelson (February 1862), Corinth was fortified by General P. G. T. Beauregard, and was made the centre of the new line along the Memphis & Charleston railway, "the great East and West artery of the Confederacy." Grant's advance on this centre, then defended by General A. S. Johnston, led to the battle of Shiloh, fought on April 6/7 about 20 m. N.E. of Corinth; after this engagement Beauregard withdrew to Corinth. General H. W. Halleck, with a greatly superior force, cautiously and slowly advanced upon the Confederate position, consuming more than a month in the operation. During the night of the 29th of May Beauregard evacuated the place (which was occupied by the Federals on the following day), and re-established his line at Tupelo. Corinth then became the headquarters of the Union forces under General W. S. Rosecrans, who on the 3/4 of October 1862 was fiercely attacked here by General Earl von Dorn, whom he repulsed, both sides suffering considerable losses in killed and wounded, and the Confederates leaving many prisoners behind.

**CORINTH, ISTHMUS OF**, an isthmus of Greece, dividing the Gulf of Corinth from the Saronic Gulf. Ships were sometimes dragged across it in ancient times at a place called the Diolcus (διόλκος, to pull or cut through). Nero, in A.D. 67, began cutting a canal through it; but the project was abandoned. In 1893 a ship canal was opened, with its western entrance about 1 1/4 m. N.E. of the little town of New Corinth. It was begun in 1881 by a French company, which ceased operations in 1889, a Greek company completing the undertaking. The canal is about 70 ft. broad, nearly 4 m. long, and 26 ft. deep. It shortens the journey from the Adriatic to the Peiraeus by 202 m., but foreign steamships seldom use it, as the narrowness of the canal and the strength of the current at times render the passage dangerous. About 1 m. from its western end it is crossed by the iron bridge of the Athens and Corinth railway. Traces of the Isthmian wall may still be seen parallel to the canal; it was constructed, at an unknown date, for the fortification of the Isthmus. Just to the S. of it, and about 1/2 m. from the sea are the remains of the Isthmian precinct of Poseidon and its stadium, where the Isthmian games were celebrated. This precinct served also as a fortress. Within it have been found traces of the temple of Poseidon and other buildings. (E. Gr.)

**CORINTHIANS, EPISTLES TO THE**, two books of the Bible (New Testament). The two letters addressed to the Christian church at Corinth are, with Romans, the longest of the Pauline epistles. They possess a singular interest and value, due to the apostle's close acquaintance with the members of the church addressed and their circumstances. In consequence of this intimate character the First Epistle to the Corinthians presents a picture, unrivalled in fulness and colour, of the life of a Pauline church, while the Second Epistle, written out of strong feeling, gives a revelation of the innermost feelings and characteristic

temperament of Paul himself, such as is not elsewhere to be found. Dealing, as both epistles do, with concrete problems of morals and with such tendencies of thought and life as find their parallel in all times, they are full of instruction to the modern Church; and this instruction increases in effectiveness the better we come to understand ancient modes of thought in their diversity from our own.

Lofty and vivid expression of the apostle's thought on the highest themes is also to be found here—witness the "Hymn to Love" (1 Cor. xiii.), the declaration of the resurrection (1 Cor. xv. 51-57), or the list of signatures of the true servant of God (2 Cor. vi. 3-10). In important historical statements, also, these epistles stand second to none, not even to Galatians—as may be indicated by a reference to the words about the institution of the Lord's supper (1 Cor. xi. 23-26) and the death and resurrection of Jesus Christ (1 Cor. xv. 1-8); or to the autobiographical utterances in which Paul explains that he was once a persecutor of Christians (1 Cor. xv. 9), mentions his escape from Damascus (2 Cor. xi. 32 f.), describes his coming to Corinth (1 Cor. ii. 1 f.), enumerates his sufferings for the Gospel (2 Cor. xi. 16-31), tells of his visions (2 Cor. xii. 1-9). In the Corinthian epistles we come in contact, as nowhere else, with the man Paul and his daily life.

The history of Paul's relations with Corinth can be made out from the Acts and the Epistles with considerable clearness. The chronology of Paul's life is not at any point surely determinable within a range of less than five years, but it must have been in the autumn of one of the years A.D. 49-53 (the usual chronology has fixed on A.D. 52) that the arrival of Paul in Corinth took place as described in Acts xviii. 1. In his so-called second missionary journey Paul had been driven by irresistible inner impulses to push on into Greece the missionary work already begun in Asia Minor. First he preached in the province of Macedonia, where the work opened auspiciously at Philippi, Thessalonica and Berea; then, apparently driven out by the violent opposition of the Jews, he moved on to Achaëa, and after rather unsuccessful attempts to secure converts among the philosophers of Athens came to Corinth.

This ancient city, taken and destroyed by the Romans in 146 B.C., had been refounded by Julius Caesar as a Roman colony in 46 B.C., settled with Italian colonists, and made a residence of the Roman governor. Its situation on the isthmus of Corinth made it a stage on the greatest of the trade routes between Rome and the East, and it was at this time the commercial capital of Greece. The traditions of licentiousness and sensuality associated with the worship of Aphrodite, which had given rise to the sinister word *corinthianize*, increased the natural tendencies of a great city to wickedness and wanton luxury. Here, as in all great centres of trade and industry, there was a body of Jews, with a synagogue. The conditions of life in Corinth—the heathen surroundings, the temptations to vice, the competition and disputes of trading life, the controversial arguments of Jews, the alertness of mind of a lively city people, the haughty temper of the inhabitants of the capital—all these are to be seen reflected in the earnest paragraphs of Paul's two epistles.

The founding of the church in Corinth (cf. 1 Cor. iv. 15) and nearly everything important that we know of Paul's first visit there will be found, well told, in Acts xviii. 1-18, a passage for which, evidently, the writer of the history had excellent sources of information. Of the somewhat chastened spirit with which Paul came he himself tells in 1 Cor. ii. 1-5. His success was prompt and large, and in the year and six months of his stay a vigorous church was gathered, including Aquila and Priscilla, as well as Crispus, the ruler of the synagogue, of whom we hear again in 1 Cor. i. 14; whether Sosthenes, who seems to have succeeded Crispus in his office (Acts xviii. 17), was afterwards converted and became the Christian brother mentioned in 1 Cor. i. 1 cannot be known. The church evidently consisted mainly of Gentile converts, but with some Jews (1 Cor. x. 14, "flee from idolatry"; xii. 2, "when ye were Gentiles"; vii. 18, "was any man called being circumcised?").

The apostle's next long stay was at Ephesus, whither he seems to have gone in the course of the same year in which he left Corinth (A.D. 51-55) and where he stayed three years. Before he arrived at Ephesus Aquila and Priscilla, who had settled there, made the acquaintance of Apollos, a Jew from Alexandria, well-educated and zealous, who with imperfect Christian knowledge was preaching the gospel of Jesus to his fellow-countrymen in the synagogue. He presently went to Corinth and carried on Christian work there with success (Acts xviii. 24-28). "I planted," says Paul (1 Cor. iii. 6), "Apollos watered." From this point on our information comes from the epistles, of which the first was written from Ephesus before Pentecost of the year in which Paul left that city, *i.e.* A.D. 54-58 (1 Cor. xvi. 8).

It appears that the church grew in numbers, for Paul refers in 2 Cor. i. 1 to "saints who are in all Achaëa." Its membership was mostly of humble people (1 Cor. i. 26-29), but probably not exclusively so, for Crispus and Stephanas (who with his household was able to render services that may well have been costly, 1 Cor. xvi. 15), Gaius and Erastus (Rom. xvi. 23), would appear to have been persons of substance. The references to law-suits perhaps imply fairly prosperous traders, the tone of the letters suggests considerable education and a reasonable degree of property on the part of many (though not all) of the readers.

The first need of the church for help from Paul seems to have grown out of the dangers from surrounding heathenism. In 1 Cor. v. 9 we read of a letter in which Paul had directed the Christians "not to have company with fornicators." This letter, so far as we know, opened the correspondence which was maintained during the three years of Paul's stay in Ephesus, whence there was easy and frequent communication with Corinth. He refers to it in order to explain the injunction which had been (perhaps wilfully) misunderstood and exaggerated.<sup>1</sup>

While at Ephesus Paul was visited by persons of the household of Chloe (1 Cor. i. 11), and by Stephanas with Fortunatus and Achaicus (probably his slaves, xvi. 17). From them and from a letter (vii. 1), which was brought perhaps by Stephanas, he was able to gain the intimate knowledge which the epistles everywhere reveal. The letter from Corinth must have contained inquiries as to practical conduct with regard to marriage (vii. 1), meat offered to idols (viii. 1), and the "spiritual gifts" (xii. 1), and may well have related to other matters, such as the collection of money for Jerusalem (xvi. 1), the visit of Apollos (xvi. 12), the position of women (xi. 2). Paul's reply includes many other topics. When it was sent, his trusted helper Timothy had also started on his way (probably through Macedonia) to Corinth, to contribute there to the edification of the Christians (iv. 17, xvi. 10). The letter itself was doubtless sent by the hand of returning Corinthians, possibly by the unnamed brethren referred to in xvi. 11, and was expected to arrive before Timothy.

*First Epistle.*—The first epistle (in many respects the most systematic of all Paul's letters) is a pastoral letter, dealing both with positive evils that need correction, and with difficult questions of practice and of thought upon which advice may be valued. Through it all there is a genial undercurrent of confidence in the personal loyalty of the Corinthian church to Paul, its founder and father. We shall be aided to understand its contents by a brief summary of the tendencies and conditions at Corinth which it reflects.

First of all there was a lack of supreme devotion to the Cause itself, which led the Corinthians to forget that they were first, last and always Christians, and so to form factions and parties. Of these there were distinguished at least three, attached to the names respectively of the founder Paul, of the learned Apollos, and of the great pillar-apostle at Jerusalem, Peter, besides, as many hold, a fourth, which arrogantly claimed to be the party of Christ (i. 12). What were the precise motives and principles of these parties cannot be determined. They do not in any case seem to represent recognizable definite points of view

<sup>1</sup> Hilgenfeld, Bacon and others hold that this letter is partly preserved in 2 Cor. vi. 14-vii. 1, but the evidence for removing those verses from their present position is insufficient.

with regard to the controverted matters that are taken up in the epistle. Yet some conjectures are possible. Paul and Apollos were personally on friendly terms (xvi. 12, cf. iii. 5-9, iv. 6), and were understood to be in fundamental agreement. But doubtless the more elaborate discourses of Apollos were admired, and Paul's teaching seemed in contrast bare, plain and crude (cf. 2 Cor. x. 10). The contrast between the Hellenic and Jewish types of thought may well have played a part also. Paul seems to be replying to such criticisms brought against him when he declares that he deliberately chose to bring to Corinth not the "wisdom of men" but the "power of God" (i. 17, ii. 1-5), and informs them that he has a store of wisdom for those who are ready for it (ii. 6). On the other hand the party of Cephas must have had Jewish-Christian leanings. A little later, in the second epistle, such a tendency is seen breaking out into violent opposition to Paul. The "Christ-party," if, as is probable, it existed, must also have been a party with a Judaizing turn (cf. 2 Cor. x. 7, xi. 22 f.), perhaps of a more extreme character. The danger of shattering the solid front of the Christian church against surrounding heathenism was keenly felt by Paul, as nearly every one of his epistles testifies. How serious it was at Corinth is shown by the long passage (chaps. i.-iv.) in which he points out that sectarianism is a mark not of superior but of inferior maturity and devotion.

Other difficulties arose from various causes. The influences of the heathen world, from which most of the Corinthian Christians had come and to which their friends and neighbours belonged, were always with them, and the problems created by these relations were very numerous. Christianity had brought over and had even intensified the moral code of Judaism, and, especially in the relations of the sexes, this brought a strain upon the naturalistic impulses and lower standards of converts trained in a different system.

Again, there were law-suits in the ordinary courts, a natural result of the frictions and strains of an oriental trading community. To Paul this was abhorrent, and here too he urges a complete break with their past. With regard to the social customs of meals at which meat that had been offered in heathen sacrifices was a part, and of feasts actually at heathen temples, doubtful questions arose. Was it a denial of the faith to eat such food or not? Mixed marriages, too, had their problems; ought the believing wife to separate herself? Ought the believing husband to insist that his heathen wife stay with him against her will? And, further, in the case of slaves, does the consciousness of Christian manhood give a new motive for trying to gain worldly freedom? In all these matters Paul gives sensible advice. There were clearly two groups of Christians, the "weak," or scrupulous, whose principle was to abstain, and the "strong," or free, who maintained that the morally insignificant must not usurp a place to which it has no right. Paul sides with neither, but follows two principles, one that the church and its members must be kept pure, the other that the moral welfare not only of the individual but of his neighbour must be the controlling motive.

Not due so much to heathen influences as to the natural tendencies of imperfect and passionate human nature were other conditions. The most striking incident here, and one which gave Paul much concern, was the case of a man who after his father's death had married his own stepmother ("the case of incest"). That this was rare in the ancient world and generally abominated both by Jews and Greeks made it seem to Paul the more imperative that this stain on the Christian church should be removed. His language shows his indignation and grief that the Corinthians themselves have not already taken the matter in hand.

Besides these troubles from heathenism there were questions of asceticism; the Greek reaction against naturalism held that nature was vile and marriage wrong. Paul had a qualified tendency to asceticism, but he shows excellent good sense in his discussion of these delicate matters.

A different set of difficulties arose from the freedom into which Christianity had introduced persons from all classes of life. What degree of freedom was permissible to a Christian woman?

How far must a woman of the lower classes who became a Christian subject herself to the restrictions of a higher class of society? Might a woman, as a free child of God, take part in the Christian public meeting?

Also in matters pertaining to the common religious life of the new society the new situation raised new problems. How should reasonable order be maintained in the wholly democratic forms of the church devotional meeting? What value should be assigned to the different religious functions or "spiritual gifts"? Did any of them confer the right to a consciousness of God's special favour? Again, the celebration of the Lord's supper, which was associated with a proper meal, was marred by exhibitions of selfishness and irreverence that needed correction.

The great variety of practical problems present to the anxious minds of the Corinthians themselves and of germinant abuses revealed to the paternal scrutiny of the apostle, opens to us some notion of the exciting times in which the Corinthian Christians stood, and explains the intensity and detailed concern of the apostle. From every side and at every moment new and often difficult questions were arising; to every one of them belonged remoter relations that made it profoundly important. It is by no accident that Paul is in the habit of treating the simplest moral issues by reference to the highest principles of his theology. From the situation at Corinth we gain an idea of what was taking place in many cities, but in the seething life of so great a capital with more rapid and varied development.

Of strictly intellectual and theological problems or errors only one is treated systematically, although at many other points in the practical discussions we can detect the theoretical basis of the errors combated and the theological foundations of Paul's own judgments. Questions about the resurrection, however, had appeared, of a rationalistic nature and evincing an Hellenic failure to understand the Jewish view. In his reply Paul shows that he too recognizes the significance of the Greek's difficulties and he presents a conception which, fortunately for the later Church, does some measure of justice to the superior scientific insight of their attitude.

*Second Epistle.*—After the despatch of First Corinthians there took place, it would appear, the riot in the theatre at Ephesus (Acts xix. 23 ff.), to which 2 Cor. i. 8 seems to refer. On leaving Ephesus Paul went to Troas (2 Cor. ii. 12), then to Macedonia, and from Macedonia (2 Cor. vii. 5, viii. 1, ix. 2) he wrote Second Corinthians. This must have been in the autumn of one of the years A.D. 54-58, nearly or quite a year after First Corinthians was written (cf. "a year ago," 2 Cor. viii. 10, ix. 2 and 1 Cor. xvi. 1-4). In the meantime there had been exciting developments in Paul's relations with Corinth, the course of which we can partly trace by the aid of the second epistle. These events explain the great difference in tone between the second epistle and the first.

Several allusions in Second Corinthians show that Paul had already twice visited Corinth (2 Cor. ii. 1, xii. 14, xii. 21, xiii. 2). The second of these visits is not mentioned in Acts; it is referred to by Paul as having a painful character. The most natural hypothesis is that, in consequence of a growing spirit of insubordination on the part of the Corinthians, Paul found it necessary to go to Corinth from Ephesus (probably by sea direct) at some time after First Corinthians was written. Of what happened on this visit, which the writer of Acts has naturally enough thought it unnecessary to mention, we seem to learn further from certain passages in the letter (2 Cor. ii. 5-11, vii. 9) which refer to some sort of an insult to Paul for which there has now been repentance and which the apostle heartily forgives. For the offender he entreats also the pardon of the church. It may well be that the sad affair had to do with the gross offender of the "case of incest" (1 Cor. v. 1-8), who with the support of his fellow Christians may have refused to conform to Paul's imperative commands. We may suppose an angry scene, possibly an attack of Paul's bodily ailment (especially if the "thorn in the flesh" be understood to be epilepsy), the immediate triumph of the adversaries, Paul's speedy departure in grief.

If, as other scholars hold, the offender was not the same as in the first epistle, the general picture of the visit will not have to be much changed.

Besides making this visit it is probable that Paul also wrote to Corinth a letter, now lost, intended to secure the result of which the unfortunate visit had failed (ii. 3, 4, 9, vii. 8, 12). It is, however, possible that the allusions merely refer to 1 Cor. v., in which case it is not necessary to assume this intermediate letter. The letter, if there was one, may have been sent by Titus, whom Paul in any case commissioned to go to Corinth and try to mend matters. Paul describes his anxiety over this last resource in touching language (ii. 12, 13). Disappointed that Titus did not meet him at Troas, he moved on to Macedonia, and there (vii. 5-9) was rejoiced by the coming of the envoy with good news of the complete return of the Corinthians to integrity and loyalty.

Second Corinthians was Paul's response to this friendly attitude reported by Titus. It went by the hand of Titus, who was promptly sent back to complete the work he had so well begun (viii. 6, 16-24). In company with him (viii. 18) was sent a brother (unnamed) who had already been appointed as the representative of the churches to accompany Paul in carrying to Jerusalem the great collection of money now nearly completed. The greater part of the epistle consists of the outpouring of Paul's thankful and loving heart (chaps. i.-vii.), together with directions and exhortations relating to the collection.

But the epistle contains evidence of another and a disagreeable side to the affairs of the Corinthian church. Especially the last four chapters, but also references in the earlier chapters, show that virulent personal opponents of Paul and his work had been exercising an evil activity. It is not easy to discover the precise relation of these persons to the parties at Corinth or to the series of events which have just been sketched, but we can well understand that their presence and efforts played a large part in the history. We learn that Jewish Christians (xi. 22) had come to Corinth, doubtless from Jerusalem, with letters of recommendation (iii. 1). They urged their own claims as apostles (though not of the twelve), and set themselves up as superior to Paul (xi. 5, xii. 11, v. 12, xi. 18). Paul calls them "false apostles" (xi. 13-15), and declares that they preach "another Jesus, another Spirit, another Gospel" (xi. 4). That in Paul's judgment his influence with the Corinthian church depended on overthrowing the power of these disturbers of the peace is plain, and this accounts for the strenuous, and occasionally violent, tone of his polemic in chapters x.-xiii. As we compare them with the Judaizers of Galatia it seems that their polemic was less on the ground of principles and doctrines, and more a personal attack. Paul does not much argue, as he does in Galatians, against the inclination of Gentile Christians to subject themselves to the Law (yet note the contrast of the old veiled covenant and the new open revelation, iii. 4-18, esp. iii. 6); he is engaged in personal defence against charges of carnal motives (x. 2), perhaps even of embezzlement (xii. 16-18), and also of fickleness (i. 12-ii. 4). When he ironically calls himself a "fool" (xi. 1, 16, 17, 19, 21, xii. 6-11), he is doubtless taking up their term of abuse, and in many of the hard passages of this most difficult of all Paul's epistles we may suspect that half-quoted flings of the enemy glimmer through his retort. From 2 Cor. x. 7, xi. 22 it may be inferred that these Jewish Christians had something to do with the "Christ-party" of which we seem to hear in the first epistle.

To the tact and firmness of Titus must be ascribed much of the successful issue of these dealings with the Corinthians. Paul spent the following winter at Corinth (Acts xx. 2, 3); while there he wrote the Epistle to the Romans, which in its milder tone gives clear indication that the day of violent controversy with Judaizing emissaries like those who came to Galatia had passed. There was indeed, as might have been expected, trouble from enemies among the Jews, but Paul escaped the danger, and with the money for the mother church, the collection of which had so long lain near his heart, he was able to start for Jerusalem in the spring of one of the years 55-59 (See PAUL).

In later time (*circ.* A.D. 95) we hear from the epistle of Clement of Rome that the Corinthian church paid full honour to Paul's memory; and *circ.* A.D. 139, the excellent Catholic (though Hebrew) Christian Hegesippus found himself deeply refreshed by the honest life and the fidelity to Christian truth of the descendants and successors of the Christians over whom Paul had laboured with such faithful oversight and so many anxious tears.

*Critical Questions.*—The manuscript evidence for the Corinthian epistles is the same as for the other epistles of Paul (see BIBLE: *New Testament*). Of early attestation the amount is rather greater for First Corinthians than for other epistles. Not only were both epistles included without question in the Pauline canon of Marcion (*circ.* A.D. 150) and in the Muratorian list (end of 2nd century), and known to various Gnostic sects of the 2nd century, but Clement of Rome (*circ.* A.D. 95) makes a specific reference (xlvii. 1) to the fact that the Corinthians "received the Epistle of the blessed Apostle Paul," and proceeds with an unmistakable quotation from 1 Cor. i. 11-13. Other quotations from First Corinthians are found in Clement, Ignatius, Polycarp, Athenagoras, Theophilus, Irenaeus, Clement of Alexandria, Tertullian, while use of the epistle can probably be detected in Hermas. Second Corinthians was, and still remains, less quotable, but it is probably used by Polycarp, perhaps by Ignatius, and by the presbyters known to Irenaeus, and it was freely used by Theophilus, Irenaeus, Clement of Alexandria and Tertullian.

The only serious doubt of the genuineness of First and Second Corinthians has been that of the so-called Dutch school of critics, in the latter part of the 19th century, and forms a part of their attempt (the first since that of Baur) entirely to reconstruct the history of early Christianity. Their view that the Corinthian epistles are the product of a body of progressive Christians in the 2nd century, who ascribed to a legendary Paul the advanced views they had themselves developed, has not commended itself to critics, and seems to be burdened by nearly all possible difficulties. The genuineness of both epistles is, in fact, amply attested not only by early writers, but by the surer proof of complicated and consistent concreteness, with perfect adaptation to all we know of Paul and of the passing circumstances of the earliest days of Christianity in Greece. For a writer a century later to have composed the Corinthian epistles and then successfully passed them off as the work of Paul could be explained only by an hypothesis of inspiration! It would have been as difficult as to forge a daily newspaper. It is to be observed that the two epistles are so intimately connected by their contents with Romans and Galatians that the four together support one another's genuineness.

In Second Corinthians two important questions of integrity have been much discussed. (1) 2 Cor. vi. 14-vii. 1 is a passage somewhat distinct from its context, and introduced by a seemingly abrupt break in the sequence of thought. It is, therefore, held by some (including G. Heinrici) to be an interpolation by another writer, by others (as A. Hilgenfeld) to be a part of the letter referred to in 1 Cor. v. 9. But the arguments against Pauline authorship are not convincing; there is after all a certain real connexion to be traced between the section and vi. 1; and the resemblance to the substance of 1 Cor. v. 9 is natural in any case. (2) More important is the question as to 2 Cor. x.-xiii. Since J. S. Semler (1776) it has been held by careful scholars that these chapters are written in a tone of excited irritation which is out of accord with the genial tone of gratified affection and confidence that pervades chaps. i.-ix. Hence such scholars as A. Hausrath, R. A. Lipsius, O. Pfeleiderer, P. W. Schmiedel, A. C. M'Giffert have adopted the view that these four chapters were not written as part of Second Corinthians, but, while unquestionably from Paul's hand, were from a separate letter (the "Vierkapitel-Brief"), probably the same as that supposed to be referred to in 2 Cor. ii. 3-9, vii. 8-12. This theory is, however, probably not correct, for while, on the one hand, it is based on an exaggeration of the differences and a neglect of certain lines of connexion between the chaps. x.-xiii. and chaps. i.-ix., on the other hand the identification supposed is made difficult by several facts.

Thus these chapters contain no mention whatever of the offender of 2 Cor. ii. 5-11, of whose case the intervening letter must have mainly treated; again, x. 1, 9, 10, 11 imply a previous sharp rebuke already administered, such as is hardly accounted for merely by First Corinthians; and finally, xii. 18 implies that these four chapters were not written until after Titus's visit, that is, that they were written at just the same time as Second Corinthians.

An apocryphal correspondence of Paul and the church at Corinth, consisting of the church's letter and Paul's reply, had canonical authority in the Syrian church in the 4th century (Aphraates, Ephraem). It is preserved in Armenian and Latin manuscripts, and is now known to have been a part of the Acts of Paul, written in the 2nd century. The letters relate to the condemnation of certain Gnostic views. For a translation see Stanley's *Epistles of St Paul to the Corinthians* (4th ed., 1876), pp. 593-598. See Harnack, *Geschichte der altchristlichen Literatur*, i. pp. 37-39, ii. 1, pp. 506-508; Bardenhewer, *Geschichte der altkirchlichen Literatur*, i. pp. 463-467; Hennecke, *Neutestamentliche Apokryphen*, pp. 362-364, 378-380.

**BIBLIOGRAPHY.**—On the Corinthian Epistles consult the *Introductions to the New Testament* of H. Holtzmann (1885, 3rd ed. 1892); B. Weiss (1886, 3rd ed. 1897, Eng. trans. 1887); G. Salmon (1887); A. Jülicher (1894, 5th and 6th ed. 1906, Eng. trans. 1904); T. Zahn (1897-1899, 2nd ed. 1900); and the articles in the Bible dictionaries, especially those by A. Robertson in Hastings's *Dictionary*. See also *Lives of Paul*; and the general works on the *Apostolic Age* of C. von Weizsäcker (1886, 2nd ed. 1892); O. Pfeiderer, *Das Urchristentum* (1887, 2nd ed. 1902, Eng. trans. 1906); and A. C. M'Giffert (1897). Especially valuable for 1 and 2 Corinthians is E. von Dobschütz, *Christian Life in the Primitive Church* (1902, Eng. trans. 1904).

In English, Dean Stanley's work (1855, 4th ed. 1876) is now out of date. On First Corinthians reference may be made to the works of T. Evans in *Speaker's Commentary* (1881); T. C. Edwards (1885); C. J. Ellicott (1887); Fr. Godet (1886-1887, Eng. trans. 1887); on both epistles to those of H. A. W. Meyer (5th ed. 1870, Eng. trans. 1877-1879) and J. J. Lias, in *Cambridge Greek Testament* (1886-1892). F. W. Robertson's classic *Sermons on St Paul's Epistles to the Corinthians* (1859) should not be neglected. In German there are commentaries of much value by G. Heinrici (1880-1887) and in Heinrici's revision of Meyer's *Kommentar* (8th ed., 1896-1900), and by P. W. Schmiedel in *Hand-Commentar* (1891, 2nd ed. 1892). For further literature see Robertson's art. "Corinthians, First Epistle to the," in Hastings's *Dictionary of the Bible*. On early attestation see A. H. Charteris, *Canonicity* (1880), and the Oxford Committee's *New Testament in the Apostolic Fathers* (1905). (J. H. Rs.)

**CORINTO**, a seaport on the Pacific coast of Nicaragua, in the department of Chinandega, built on the small island of Asserradores or Corinto, at the entrance to Realejo Bay, 65 m. by rail N.W. of Managua. Pop. (1900) about 3000. The town, which was founded in 1849, and first came into prominence as a port in 1863, has a spacious and sheltered harbour, the best in Nicaragua. It possesses no docks or wharves, and vessels anchor some 500 yds. off-shore to load or discharge cargo by means of lighters. On the mainland is the terminus of a railway to Leon, Managua and other commercial centres. Coffee, gold, mahogany, rubber and cattle are largely exported; and more than half the foreign trade of Nicaragua passes through this port, which has completely superseded the roadstead of Realejo, now partly filled with sandbanks, but from 1550 to 1850 the principal seaport of the country. About 450 ocean-going ships, of some 450,000 tons, annually enter the port. Most of the foreign vessels are owned in Germany or the United States. The coasting trade is restricted to Nicaraguan boats.

**CORIOLANUS, GAIUS** (or **GNAEUS**) **MARCIUS**, Roman legendary hero of patrician descent. According to tradition, his surname was due to the bravery displayed by him at the siege of Corioli (493 B.C.) during the war against the Volscians (but see below). In 492, when there was a famine in Rome, he advised that the people should not be relieved out of the supplies obtained from Sicily, unless they would consent to the abolition of their tribunes. For this he was accused by the tribunes, and, being condemned to exile, took refuge with his friend Attius Tullius, king of the Volscians. A pretext for a quarrel with Rome was found, and Coriolanus, in command of the Volscian army, advanced against his native city. In vain the first men of Rome prayed for

moderate terms. He would agree to nothing less than the restoration to the Volscians of all their land, and their admission among the Roman citizens. A mission of the chief priests also failed. At last, persuaded by his mother Veturia and his wife Volumnia, he led back the Volscian army, and restored the conquered towns. He died at an advanced age in exile amongst the Volscians; according to others, he was put to death by them as a traitor; a third tradition (mentioned, but ridiculed, by Cicero) represents him as having taken his own life.

The whole legend is open to serious criticism. At the traditional date (493 B.C.) Corioli was not a Volscian possession, but one of the Latin cities which had concluded a treaty of alliance with Rome; further, Livy himself states that the chroniclers knew nothing of a campaign carried on by the consul Postumus Cominius Auruncus (under whom Coriolanus is said to have served) against the Volscians. Only one of the consuls was mentioned as having concluded the treaty; the absence of the other was consequently assumed, and a reason for it found in a Volscian war. The bestowal of a cognomen from a captured city was unknown at the time, the first instance being that of Scipio; in any case, it would have been conferred upon the commander-in-chief, Postumus Cominius Auruncus, not upon a subordinate. The conquest of Corioli by Coriolanus is invented to explain the surname. The details of the famine are borrowed from those of later years, especially 433 and 411. The incident of Coriolanus taking refuge with the Volscian king, who, according to Plutarch, was his bitter enemy, curiously resembles the appeal of Themistocles to the Molossian king Admetus. Further, the tradition that Coriolanus, like Themistocles, committed suicide, renders it a probable conjecture that these incidents are derived from a Greek source. The contradictions in the accounts of the campaign against Rome and its inherent improbability give further ground for suspicion. Twelve important towns are taken in a single summer apparently without resistance on the part of the Romans, and after the retirement of Coriolanus they are immediately abandoned by the conquerors. It is strange that the Volscians should have entrusted a stranger with the command of their army, and it is possible that the attribution of their successes to a Roman general was intended to gratify the national pride and obliterate the memory of a disastrous war. It is suggested that Coriolanus never commanded the Volscian army at all, but that, like Appius Herdonius—the Sabine chieftain who in 460, with a band of fugitives and slaves, obtained possession of the capitol—he appeared at the gates of Rome at the head of a body of exiles (but at a much later date, c. 443), at a time when the city was in great distress, perhaps as the result of a pestilence, and only desisted from making himself master of Rome at the earnest entreaty of his mother. This seems to be the historical nucleus of the tradition, which accentuates the great influence exercised by and the respect shown to the Roman matrons in early times.

**ANCIENT AUTHORITIES.**—Plutarch's *Life*; Livy ii. 34-40; Dion. Halic. vi. 92-94, vii. 21-27, 41-47, viii. 1-60; Cicero, *Brutus*, x. 42. The story is the subject of Shakespeare's *Coriolanus*. For a critical examination of the story see Schweigler, *Römische Geschichte*, bk. xxiv.; Sir G. Cornwall Lewis, *Credibility of Early Roman History*, ch. xii. 19-23; W. Ihne, *History of Rome*, i.; T. Mommsen, "Die Erzählung von Cn. Marcus Coriolanus," in *Hermes*, iv. (1869); E. Pais, *Storia di Roma*, i. ch. 4 (1898).

**CORIOLI**, an ancient Volscian city in *Latium adiectum*, taken, according to the Roman annals in 493 B.C., with Longula and Pollusca, and retaken (but see above) for the Volsci by Gaius Marcius Coriolanus, its original conqueror, who, in disgust at his treatment by his countrymen, had deserted to the enemy. After this it does not appear in history, and we hear soon afterwards (443 B.C.) of a dispute between Ardea and Aricia about some land which had been part of the territory of Corioli, but had at an unknown date passed to Rome with Corioli. The site is apparently to be sought in the N.W. portion of the district between the sea, the river Astura and the Alban Hills; but it cannot be more accurately fixed (the identification with Monte Giove, S. of the Valle-Ariciana, rests on no sufficient evidence), and even in the time of Pliny it ranked among the lost cities of Latium.



**CORIPPUS, FLAVIUS CRESCONIUS**, Roman epic poet of the 6th century A.D. He was a native of Africa, and in one of the MSS. is called *grammaticus* (teacher). He has been identified, but on insufficient grounds, with Cresconius, an African bishop (7th century), author of a *Concordia Canonum*, or collection of the laws of the church. Nothing is known of Corippus beyond what is contained in his own poems. He appears to have held the office of tribune or notary (*scriniarius*) under Anastasius, imperial treasurer and chamberlain of Justinian, at the end of whose reign he left Africa for Constantinople, in consequence of having lost his property during the Moorish and Vandal wars. He was the author of two poems, of considerable importance for the history of the times, one of which was not discovered till the beginning of the 19th century. The latter poem, dedicated to the nobles of Carthage, which comes first in point of time, is called *Johannis* or *De bellis Libycis*, and relates the overthrow of the Moors by a certain Johannes, *magister militum* in 546; it is in eight books (the last is unfinished) and contains about 5000 hexameters. The narrative commences with the despatch of Johannes to the theatre of war by Justinian, and ends with the decisive victory near Carthage (548). The other poem (*In laudem Justinii minoris*), in four books, contains the death of Justinian, the coronation of his successor Justin II. (14th of November 565), and the early events of his reign. It is preceded by a preface, and a short and fulsome panegyric on Anastasius, the poet's patron. The *Laus* was published at Antwerp in 1581 by Michael Ruyz Azagra, secretary to the emperor Rudolf II., from a 9th or 10th century MS. The preface contains a reference to a previous work by the author on the wars in Africa, and although Johannes Cuspinianus (1473-1529) in his *De Caesaribus et Imperatoribus* professed to have seen a MS. of it in the library at Buda (destroyed by Suleiman II. in 1527), it was not till 1814 that it was discovered at Milan by Cardinal Mazzucchelli, librarian of the Ambrosian library, from the codex Trivultianus (in the library of the marquis Trivulzi), the only MS. of the *Johannis* still extant.

The *Johannis* is of great value, not only from a purely historical point of view, but also as giving a description of the land and people of Africa, which conscientiously records the impressions of an intelligent native observer; many of his statements as to manners and customs are confirmed both by independent ancient authorities (such as Procopius) and by our knowledge of the modern Berbers. Virgil, Lucan, and Claudian were the poet's chief models. The *Laus*, which was written when he was advanced in years, although marred by Byzantine servility and gross flattery of a by no means worthy object, throws much light upon Byzantine court ceremony, as in the account of the accession of Justin and the reception of the embassy of the Avars. On the whole the language and metre of Corippus, considering the age in which he lived and the fact that he was not a native Italian, is remarkably pure. That he was a Christian is rendered probable by negative indications, such as the absence of all the usual mythological accessories of an epic poem, positive allusions to texts of Scripture, and the highly orthodox passage *Laus* iv. 294 ff.

The editions of the *Johannis* by P. Mazzucchelli (1820) and of the *Laus* by P. F. Foggini (1777) are still valuable for their commentaries. They are both included in the 28th volume of the Bonn *Corpus scriptorum historiae Byzantinae*. The best modern editions are by J. Partsch (in *Monumenta Germaniae historica*, 1879), with very valuable prolegomena, and M. Petschenig (*Berliner Studien für klassische Philologie*, iv., 1886); see also Gibbon, *Decline and Fall*, ch. xlv.

**CORISCO**, the name of a bay and an island on the Guinea Coast, West Africa. The bay is bounded N. by Cape San Juan (1° 10' N.) and S. by Cape Esterias (0° 36' N.), and is about 31 m. across, while it extends inland some 15 m. The bay is much encumbered with sandbanks, which impair its value as a harbour. Whereas the Muni river or estuary, which enters the bay on its northern side, has a maximum depth of over 100 ft., vessels entering it have to come by a channel with an average depth of six fathoms. The entrance to the southern part of the bay is obstructed by the Bana Bank, which extends for 9 m., rendering

navigation dangerous. The bay encloses many small islands and islets, some hardly distinguishable from sandbanks and submerged at high water, giving rise to a native saying that "half the islands live under water." The principal islands are four, Bana, Great and Little Elobey, and Corisco, the last-named lying farthest to seaward and giving its name to the bay.

Corisco Island, the largest of the group, is some 3 m. long by 1½ m. in breadth and has an area of about 5½ sq. m. The surface of the island is very diversified. On a miniature scale it possesses mountains and valleys, rivers, lakes, forests and swamps, grassland and bushland, moorland and parkland. The forests supply ebony and logwood for export. The natives are a Bantu-Negro tribe called Benga. There are among them many converts to Roman Catholicism and a few Protestants. Corisco and the other islands named are Spanish possessions and are governed as dependencies of Fernando Po.

See Mary H. Kingsley, *Travels in West Africa*, ch. xvii. (London, 1897); E. L. Perea, "Guinea española: La isla de Corisco," in *Revista de geog. colon. y mercantil* (Madrid, 1906).

**CORK, RICHARD BOYLE**, 1ST EARL OF (1566-1643), Irish statesman, second son of Roger Boyle of Faversham in Kent, a descendant of an ancient Herefordshire family, and of Joan, daughter of Robert Naylor of Canterbury, was born at Canterbury on the 3rd of October 1566, and was educated at the King's school and at Bennet (Corpus Christi) College, Cambridge, where he was admitted in 1583. He afterwards studied law at the Middle Temple and became clerk to Sir Richard Manwood, chief baron of the exchequer; but finding his position offered little opportunity for advancement he determined to make a new start in Ireland. He landed in Dublin on the 23rd of June 1588, as he relates himself, with £27, 3s. in money, a gold bracelet worth £10, and a diamond ring, besides some fine wearing apparel. He began to make his fortune almost immediately. In 1590 he obtained the appointment of deputy escheator to John Crofton, the escheator-general, and in 1595 he married Joan, daughter and co-heiress of William Appsey of Limerick, who died in 1599, having brought him an estate of £500 a year.

Meanwhile he had been the object of the attacks of Sir Henry Wallop and others, incited, according to his own account, by envy at his success and increasing prosperity, and was apprehended on various charges of fraud in his office, being more than once thrown into prison. He was on the point of leaving for England to justify himself to the queen, when the rebellion in Munster in October 1598 again reduced him to poverty and obliged him to return to London to his chambers at the Temple. He was, however, almost immediately taken by Essex into his service, when Sir Henry Wallop again renewed his prosecution, with the result that Boyle was summoned before the star chamber. His enemies appear to have failed in substantiating their accusations, and in the course of the inquiry, at which he had secured the presence of the queen herself, he was able to expose several instances of malversation on the part of his opponent, who was dismissed in consequence from his office of treasurer, while Boyle himself, who had favourably impressed the queen, was declared by her as "a man fit to be employed by ourselves" and was at once made clerk of the council of Munster. He brought to Elizabeth the news of the victory near Kingsale in December 1601, and in October 1602 was again sent over by Sir George Carew, the president of Munster, on Irish affairs; and on this occasion, at the instance of Carew, he bought for £1000 the whole of Sir Walter Raleigh's lands in Cork, Waterford and Tipperary, consisting of 12,000 acres with immense capabilities of development. This offered a splendid opportunity for the exercise of his genius for business and administration. Manufactures were established, the breeding of cattle and fish introduced, mines opened, colonists from England encouraged to come over, the natural resources of the land developed, bridges, harbours and roads constructed, and towns settled, order being maintained by 13 castles garrisoned by retainers.

While himself quickly accumulating vast riches, the services



which Boyle rendered to the government and to the nation at such a time of disorder and transition were incalculable. He soon became the most powerful subject in Ireland. On the 25th of July 1603 he married, as his second wife, Catherine, daughter of Sir Geoffrey Fenton, secretary of state, and was knighted. In 1606 he became a privy councillor for Munster and in 1613 for Ireland. On the 6th of September 1616 he was raised to the peerage as Lord Boyle, baron of Youghal, and on the 26th of October 1620 was created earl of Cork and Viscount Dungarvan. He was appointed on the 26th of October 1629 a lord justice, and on the 9th of November 1631 lord high treasurer. Though no peer of England, he was "by writ called into the Upper House by His Majesty's great grace," and took his place as an "assistant sitting on the inside of the Woollack."<sup>1</sup> The appointment of Wentworth (Lord Strafford), however, as lord deputy in 1633 put an end to the predominant power and influence of Cork in Ireland. "A most cursed man," he writes in his diary on Wentworth's arrival, "to all Ireland and to me in particular." In reality these two great men had much in common, held similar views of administration, and had the same talents for practical statesmanship. Cork had already carried out in Munster the policy which Strafford desired to see extended to the whole of Ireland. But Cork belonged to the "spacious days of great Elizabeth," and for such a man there was no room within the narrow despotism and intolerance of the government of Charles. The subjection of the great was part of Strafford's settled policy, and consequently, instead of seeking his collaboration in developing the country and in maintaining order, he studied merely to diminish his influence. He subjected him to various humiliations. He forced him to remove his wife's tomb from the choir in St Patrick's at Dublin, and deprived him arbitrarily of the greater part of the revenues of Youghal, a portion of the Raleigh estates. "No physic," wrote Laud, delighted, "better than a vomit if it be given in time, and therefore you have taken a very judicious course to administer one so early to my Lord of Cork. I hope it will do him good. . . ."<sup>2</sup> Cork, however, refrained from any systematic or retaliatory resistance, and even simulated an admiration for Strafford's rule. At the latter's trial he was an important witness, but took no active part in the prosecution, though he thoroughly approved of his condemnation and execution. Scarcely had he returned to Ireland from witnessing his rival's destruction when the rebellion broke out, but his influence and preparations, supported by the military prowess of his sons, were sufficient to offer a successful resistance to the rebels in Munster and to save the province from ruin. This was his last great service to the state. He died about the 15th of September 1643, leaving a large and illustrious family by his second wife.

Four of his seven sons received independent peerages,—Richard, created Baron Clifford and earl of Burlington; Lewis, Viscount Kinalmeaky, killed in 1642 at the battle of Liscarroll; Roger, baron of Broghill and earl of Orrery; and Francis, Viscount Shannon. Another son was Robert Boyle (*q.v.*), the famous natural philosopher and chemist.

The title passed to the eldest surviving son, RICHARD BOYLE, 1st earl of Burlington and 2nd earl of Cork (1612–1698), who matriculated at Christ Church, Oxford, and was knighted in 1624. Returning home after travelling abroad he married in 1635 Elizabeth, daughter and heir of Henry, Lord Clifford, later earl of Cumberland. On the outbreak of the rebellion he supported his father in Munster, fought at the battle of Liscarroll, and raised forces for the first war with the Scots. In 1640 he represented Appleby in the Long Parliament, and in the civil war he supported zealously the royal cause, being created in 1643 Baron Clifford of Lanesborough in the peerage of England, in addition to the earldom of Cork which he inherited from his father the same year. At the Restoration he obtained also the earldom of Burlington (or Bridlington), and was appointed lord-lieutenant of the West Riding of Yorkshire, resigning this office through opposition to the government of James II. He held the office of lord treasurer of Ireland from 1680 till 1695.

<sup>1</sup> *Lords Journals*.

<sup>2</sup> *Strafford Letters*, i. 156.

He died on the 15th of January 1698. His two sons having predeceased him, he was succeeded in his titles by his grandson Charles, issue of his eldest son Charles, as 2nd earl of Burlington and 3rd earl of Cork; and on the extinction of the direct male line in the person of Richard, the 4th earl, in 1753 the earldom of Cork fell to the younger branch of the Boyle family, in the person of John, 5th earl of Orrery, he and later earls being "of Cork and Orrery."

JOHN BOYLE, 5th earl of Cork and Orrery (1707–1762), only son of the 4th earl of Orrery, was born on the 2nd of January 1707. He was educated at Christ Church, Oxford, and was led by indifferent health and many untoward accidents to cultivate in retirement his talents for literature and poetry. His translation of the *Letters of Pliny the Younger*, with various notes, for the use of his eldest son, was published in 1751. He also published *Remarks on the Life and Writings of Jonathan Swift* (1751), in several letters addressed to his second son, and *Memoirs of Robert Carey, earl of Monmouth*, from the original manuscript, with preface and notes. He died on the 16th of November 1762. His *Letters from Italy* appeared in 1774, edited, with memoir, by the Rev. J. Duncombe. The earldom continued in later years in the Boyle family, being held in 1909 by the 10th earl (b. 1861). The wife of the 7th earl (see CORK AND ORRERY, MARY, COUNTESS OF) was a famous figure in society in the early 19th century.

BIBLIOGRAPHY FOR 1ST EARL.—*True Remembrances*, written by himself and printed by Birch in his edition of the works of Robert Boyle; *Lismore Papers*, ed. by A. B. Grosart (10 vols., 1886–1887), 1st series consisting of the diary from 1611 to his death and of autobiographical notes, and 2nd series of correspondence; *Life of Lord Cork*, by Dorothea Townshend (1904); article in the *Dict. of Nat. Biog.*, with authorities there given; *Egerton MSS.* 80 (copies of correspondence); *Add. MSS.*, Brit. Mus., 19831–19832 (rebellion in Munster, examination before the Star Chamber, correspondence) and 18023; *Strafford's Letters*; *Calendars of State Papers, Domestic and Irish*, and *Carew Papers*; E. Lodge's *Irish Peerage*, i. 144; E. Budgell's *Memoirs of the Boyles* (1737); Ed. Edwards's *Life of Raleigh*; Gardiner's *Hist. of England*; Charles Smith's *History of Cork* (1893); R. Caulfield's *Council Book of Youghal*; also the biography in *Biographia Britannica*, Kippis, vol. ii.

CORK, a county of Ireland in the province of Munster, bounded S. by the Atlantic Ocean, E. by the counties Waterford and Tipperary, N. by Limerick, and W. by Kerry. It is the largest county in Ireland, having an area of 1,849,686 acres, or about 2890 sq. m. The outline is irregular; the coast is for the most part bold and rocky, and is intersected by the bays of Bantry, Dunmanus, and Roaring Water. The southern part of the coast projects several headlands into the Atlantic, and its south-eastern side is indented by Cork Harbour, and Ballycotton and Youghal Bays. The surface is undulating. It consists of low rounded ridges, with corresponding valleys, running east and west, except in the western portion of the county, which is more mountainous. The principal rivers are the Blackwater, the Lee, and the Bandon, flowing generally eastward from their sources in the high ground of the west. The most elevated part of the county is in the Boggeragh Mountains, in the north-west, which reach an extreme height of 2118 ft. To the south are the Shehy Mountains, at the root of the two promontories flanking Bantry Bay, the Caha Mountains forming the backbone of the northern of these promontories, and the hills of the district of Corbery to the south of the Shehy range. North of the Blackwater the country is comparatively level, being a branch of the great plain which occupies a large part of the centre of Ireland. Of the principal rivers the Blackwater has its source in the county Limerick. The Lee originates in the wild and picturesque Gouganebarra Lough, and the Bandon river rises in the Cullinagh Lough. There are also some smaller streams which flow directly into the sea, the more important of these being in the south-west portion of the county. No lakes of any magnitude occur, the largest being Lough Allua, or Inchigeelagh, an expansion of the river Lee. The scenery of the western parts of the county is bold and rugged. In the central and eastern parts, especially in the valleys, it is green and quiet, and in some spots well wooded.

**Geology.**—The county presents a remarkable simplicity of geological structure. Its surface is controlled throughout by the "Hercynian" folds, running from the Kerry border eastward to the sea at Youghal. The Old Red Sandstone comes out in the north, forming the heather-clad Ballyhoura Hills, which are repeated across the limestone hollow of Mitchelstown by the western spur of the Knockmealdown Mountains. On the west, beds as high as the Millstone Grit and Coal Measures remain above the limestone, extending from Mallow and Kanturk to the Limerick and Kerry borders. Another synclinal of Carboniferous Limestone runs from Millstreet through Lismore, and the Blackwater has worn out an easy course along it. Then the Old Red Sandstone again rises as an undulating upland through the centre of the county, with a few synclinal patches of Carboniferous Shale and Limestone caught in on its back. Cork city lies on the north slope and in the floor of a larger synclinal, and the Yellow Sandstone, which forms the passage-beds from the Old Red Sandstone to the Carboniferous, appears near the city. This hollow continues across the Lee through Middleton. The limestone in it has become crystalline, veined and brecciated, while a fine red staining, especially at Little Island, adds to its value as a marble. After another anticlinal of Old Red Sandstone, the Carboniferous Slate occupies most of the country southward, with occasional appearances of the basal Coomhola Grits and of the underlying Old Red Sandstone along anticlinals. The soils thus vary from sandy loams, usually on the higher ground, to stiff clays along the limestone hollows.

This country admirably illustrates the system of river-development originally traced out by Prof. J. B. Jukes in 1862, and further explained by Prof. W. M. Davis and others. The folded series, culminating originally in Upper Carboniferous strata, was worn down, perhaps as far back as Permian times, until it possessed a fairly uniform surface. This surface, or "peneplain," was probably the result of denudation working away the beds almost to sea-level. A subsequent elevation enabled the streams, as in so many cases now recognized, to cut into the surface along the direction of greatest inclination, which here happened to be southward. When the higher strata had been worn away, the rivers and their tributaries worked upon rocks of very various hardness, but with a common strike from east to west. The tributaries, running along the strike, speedily confined themselves to the synclinals of limestone, along which they could erode and dissolve long valleys. The present surface of anticlinal sandstone ridges and synclinal limestone hollows thus began to arise; but the main streams still held on their courses across the strike, that is, from north to south. Here and there a more active tributary worked its way back at its head into the basin of one of the cross-streams, and drew off into its own system the head-waters of this other stream. With this new flood of water the strengthened system still further deepened its original ravine across the strike, while the beheaded cross-stream or streams rapidly dwindled in importance. Ultimately, the tributaries of the surviving river-systems appeared as the most important feature, stretching far west—in the case of county Cork—along the synclinal hollows; while the original cross-ravine remained in the course of each river, a right-angled bend occurring thus in the lower portion of the valleys. Jukes urged that the upper part of the original cross-ravine can be traced above the bend in each case, though the stream now descending along it seems merely a tributary entering parallel with the north-and-south portion of the main stream. Moreover, the tributaries on the north side of the great synclinal valleys may in many cases be the relics of original cross-streams that once flowed directly to the sea until captured by the growth along the synclinal of the tributary of another stream. The Blackwater, rising on Upper Carboniferous beds on the Kerry border, thus falls steeply southward to Rathmore, and then turns eastward along the synclinal valley of limestone from Millstreet to Cappoquin. Here it abruptly turns south, keeping, in fact, to that part of its valley which was first developed. The Lee, rising in the Old Red Sandstone moors of Gouganebarra, runs east, encountering one or two patches of limestone in the floor of the synclinal on its way, mere residues of the rock that once occupied the hollow. Near Cork, the limestone and accompanying shale are better preserved; but the river, instead of continuing along the synclinal through Middleton to Youghal, turns south, and forms the now submerged valley of Cork Harbour. Observations have shown that the coast lay much at its present level in pre-Glacial times, and that Cork Harbour was thus a marine inlet before the ice descended into it. The synclinal valleys of Bantry Bay and Dunmanus Bay were also, in all probability, submerged at this same early epoch.

The county has been famous for its copper-mines, notably at Allihies in the extreme west. The region south-west of Bantry has been mined in several places. Both gold and silver have been found in the copper-ores of this latter area. Barytes has been mined near Bantry, Schull and Clonakilty, and manganese-ore at Glandore. Anthracite has been raised from time to time in the band of Coal Measures south-west of Kanturk. The marble of Little Island near Cork is quarried under the name of "Cork Red," and the veined pink and grey marble of Middleton is also much esteemed.

**Climate and Watering-places.**—The climate is moist and warm, the prevailing winds being from the west and south-west. The

annual rainfall in the city of Cork is about 40 in., that of the whole county being somewhat higher. The mean annual temperature is about 52° F. The snow-fall during the winter is usually slight, and snow rarely remains long on the ground except in sheltered places. The thermal spring of Mallow was formerly in considerable repute; it is situated in a basin on the banks of the Blackwater, rising from the base of a limestone hill. The chief places for sea-bathing are Blackrock, Passage, Monkstown, Queenstown, and other waterside villages in the vicinity of Cork; Bantry, Baltimore, Kinsale, Glengarrif and Youghal are also much frequented during the summer months.

**Industries.**—The soils of the county exhibit no great variety. They may be reduced in number to four: the calcareous in the limestone districts; the deep mellow loams found in districts remote from limestone, and generally occurring in the less elevated parts of the grey and red sandstone districts; the light shallow soils, and the moorland or peat soils, the usual substratum of which is coarse retentive clay. About one-sixth of the total area is quite barren. In a district of such extent and variety of surface, the state of agriculture must be liable to much variation. The more populous parts near the sea, and in the vicinity of the great lines of communication, exhibit favourable instances of agricultural improvement. Oats, potatoes and turnips are the principal crops, but the extent of land under tillage shows a general decrease. Pasture land, however, extends, and the number of cattle, sheep and poultry rises; for dairies are numerous and the character of the Cork butter and farmyard produce stands high in English and foreign markets.

Youghal, Kinsale, Queenstown, Castletown and Bearhaven are the deep-sea and coast fishing district centres of the county; while the salmon fishing is distributed among the districts of Cork, Bandon, Skibbereen and Bantry. The mackerel fishery is especially productive from mid-March to mid-June. The Blackwater, Lee and Bandon, apart from the netting industry, afford good rod-fishing for salmon, especially the first, on which Lismore, Fermoy and Mallow are the principal centres. The loughs, the upper waters of these rivers and their tributaries, frequently abound in trout. Macroom, Inchigeelagh, Bandon, Dunmanus and Glandore, with Bantry and Skibbereen, are all good stations.

**Communications.**—The main line of the Great Southern & Western railway, entering the county from the north at Charleville, serves Cork and Queenstown. The Cork, Bandon & South Coast line runs west to Skibbereen, Baltimore, Bantry, Clonakilty and Kinsale; and there are also the Cork & Macroom line to Macroom; the Cork, Blackrock & Passage to the western waterside villages of Cork Harbour, and the Great Southern & Western branch eastward from Cork to Youghal; while from Mallow a branch of the same system continues towards Killarney and the south-western coast of Ireland. There is also connexion from this junction with Fermoy, Mitchelstown and county Waterford eastward. The Timoleague and Courtmacsherry line connects these villages with the Clonakilty branch of the Cork, Bandon & South Coast Railway.

**Population.**—The population (438,432 in 1891; 404,611 in 1901) exhibits a decrease among the most serious of the Irish counties, and emigration is correspondingly heavy. Of the total about 90% are Roman Catholics, and about 70% constitute the rural population. The principal towns are Cork (pop. 76,122, a county of a city); Queenstown (7909), Fermoy (6126); Kinsale (4250), Bandon (2830), Youghal (5393), Mallow (4542), Skibbereen (3208), Macroom (3016), Bantry (3109), Middleton (3361), Clonakilty (3098), and among smaller towns Charleville, Mitchelstown, Passage West, Doneraile and Kanturk. Crookhaven in the extreme S.W. is of importance as a harbour of refuge, but the chief ports are Cork and Queenstown. The county is divided into east and west ridings, and contains twenty-three baronies and 249 parishes. Assizes are held at Cork, and quarter-sessions at Cork, Fermoy, Kanturk, Kinsale, Mallow, Middleton, and Youghal in the east riding; and Bandon, Bantry, Clonakilty, Macroom and Skibbereen in the west riding. The county is in the Protestant diocese of Cork, and the Roman Catholic diocese

of Cork, Cloyne, Kerry and Ross. There are seven parliamentary divisions, east, mid, north, north-east, south, south-east and west, each returning one member.

*History.*—Cork is one of the counties which is generally considered to have been instituted by King John. It had not always its present extent, for its existing boundaries include part of the ancient territory of Desmond (*q.v.*), which, in the later half of the 16th century, ranked as a separate county. In 1598, however, there were two sheriffs in the county Cork, one especially for Desmond, which was then included in Cork, but was afterwards amalgamated with the county Kerry. In the same period wide lands in the county were given to settlers under the crown, and among these were Sir Walter Raleigh and Edmund Spenser the poet, who received 40,000 acres and 3028 acres respectively. In 1602 a large portion of the estates of Sir Walter Raleigh and Fane Beecher were purchased by Richard Boyle, 1st earl of Cork, who had them colonized with English settlers; and by founding or rebuilding the towns of Bandon, Clonakilty, Baltimore, Youghal, and afterwards those of Middleton, Castlemartyr, Charleville and Doneraile, which were incorporated and made parliamentary boroughs, the family of Boyle became possessed of nearly the entire political power of the county.

*Antiquities.*—The earlier antiquities of the county are rude monuments of the Pagan era. There are two so-called druids' altars, the most perfect near Cloyne, and certain pillar stones scattered through the county, with straight marks cut on the edges called Ogham inscriptions, the interpretation of which is a subject of much controversy. The remains of the old ecclesiastical buildings are in a very ruinous condition, being used as burial-places by the country people. The principal is Kilcrea, founded by Cormac M'Carthy about 1485, some of the tombs of whose descendants are still in the chancel; the steeple is still nearly perfect, and chapter-house, cloister, dormitory and kitchen can be seen. Timoleague church, situated on a romantic spot on rising ground at the extreme end of Courtmacsherry Bay, contains some tombs of interest, and is still in fair condition. Buttevant Abbey (13th century) contains some tombs of the Barrys and other distinguished families. There is a good crypt here. All these were the property of the Franciscans. There are two round towers in the county, one in a fine state of preservation opposite Cloyne Cathedral, the other at Kinneigh. On the chapter seal at Ross, which is dated 1661, and seems to have been a copy of a much earlier one, there is a good example of a round tower and stone-roofed church, with St Fachnan, to whom the church is dedicated, standing by, with a book in one hand and a cross in the other. The present church dates from 1837, but is on the site of a former cathedral united to Cork in 1583. Of Mourne Abbey, near Mallow, once a preceptory of the Knights Templars, and Tracton Abbey, which once sent a prior to parliament, the very ruins have perished. On an island of Lough Gouganearra are remains of an oratory of St Finbar.

Of the castles, Lohort, built in the reign of King John, is by far the oldest, and in its architectural features the most interesting; it is still quite perfect and kept in excellent repair by the owner, the Earl of Egmont. Blarney Castle, built by Cormac M'Carthy about 1449, has a wide reputation (see **BLARNEY**). Castles Mahon and Macroom have been incorporated into the residences of the earls of Bandon and Bantry. The walls of Mallow Castle attest its former strength and extent, as also the castle of Kilbolane. The castles of Buttevant, Kilcrea and Dripsy are still in good condition. At Kanturk is a huge Elizabethan castle still known as "M'Donagh's Folly," left unfinished owing to objections raised by a jealous government. At Kilcolman castle near Doneraile the "Faerie Queene" was written by Spenser.

**CORK**, a city, county of a city, parliamentary and municipal borough and seaport of Co. Cork, Ireland, at the head of the magnificent inlet of Cork Harbour, on the river Lee, 165½ m. S.W. of Dublin by the Great Southern & Western railway. Pop. (1901) 76,122. Until the middle of the 19th century it ranked second only to Dublin, but is now surpassed by Belfast in commercial importance. It is the centre of a considerable

railway system, including the Great Southern & Western, the Cork, Bandon & South Coast, the Cork & Macroom Direct, the Cork, Blackrock & Passage railways, and the Cork & Muskerry light railway; each of which companies possesses a separate station in the city. The passenger steamers to Great Britain, mainly under the control of the City of Cork Steam Packet Company, serve Fishguard, Glasgow, Liverpool, Plymouth and Southampton, London and other ports, starting from Penrose Quay on the North Channel.

The nucleus of the city occupies an island formed by the North and South Channels, two arms of the river Lee, and in former times no doubt merited its name, which signifies a swamp. In the beginning of the 18th century, indeed, this island was broken up into many parts connected by drawbridges, by numerous small channels navigable at high tide. It now includes most of the principal thoroughfares, which form a notable contrast to many of the smaller streets and alleys, in which good building and cleanliness are lacking. Three bridges cross the North Channel, a footbridge, North Gate bridge and St Patrick's bridge, the last a handsome three-arch structure leading to St Patrick's Street, a wide and pleasant thoroughfare, containing a statue of Father Mathew, the celebrated Capuchin advocate of temperance, born in 1790. It communicates with the Grand Parade and this in turn with Great George's Street, to the west, and the South Mall to the east, the last containing the principal banks, the County Club house, and good commercial buildings. The Clarks, South Gate, Parliament and Parnell bridges cross the South Channel to the southern parts of the city. Public grounds are few, but on the outskirts of the city are a park and race-course, with the fashionable Marina promenade; while the Mardyke walk, on the west of the island, is pleasantly shaded by a fine avenue, and was the site of the International exhibition held in 1902. Electric tramways connect the city and suburbs and traverse the principal streets and the St Patrick's and Parnell bridges. Both branches of the Lee are lined with fine quays of cut limestone, extending in total length over 4 m.

The principal church is the Protestant cathedral, founded in 1865, and consecrated on St Andrew's Day 1870; while the central tower was completed in 1879. It is dedicated to St Fin Barre or Finbar, who founded the original cathedral in the 7th century. The present building is in the south-west part of the city, and replaces a somewhat mean structure erected in 1735 on the site of the ancient cathedral, which suffered during the siege of Cork in September 1689. Money for the erection of the building of 1735 was raised by the curious method of a tax on imported coal. The new cathedral is in the Early French (pointed) style, with an eastern apse and a striking west front. Its design was by William Burges (d. 1881), and its erection was due to the indefatigable exertions and munificence of Dr John Gregg, bishop of Cork, Cloyne and Ross; while the tower and spires were the gift of two merchants of Cork. The other principal Protestant churches are St Luke's, St Nicholas and St Anne Shandon, with its striking tower of parti-coloured stones; and its peal of bells extolled in Father Prout's lyric "The Bells of Shandon." The Roman Catholic cathedral, also dedicated to St Finbar, is conspicuous on the north side of the city; it dates from 1808, but has been since restored. Other fine churches of this faith are St Mary, St Peter and Paul, St Patrick, Holy Trinity and St Vincent de Paul. St Finbar's cemetery has handsome monuments, and St Joseph's, founded by Father Mathew in 1830 on the site of the old botanic gardens of the Cork Institution, is beautifully planted. The court house in Great George's Street has a good Corinthian portico, happily undamaged in a fire which destroyed the rest of the building in 1891. The custom-house commands the river in a fine position at the lower junction of the branches. The usual commercial and public buildings are mainly on the island. The most notable educational establishment is the University College, founded as Queen's College (1849), with those of the same name at Belfast and Galway, under an Act of 1845. A new charter was granted to it under letters patent pursuant to the Irish Universities Act 1908, when it was given its present name. The building,



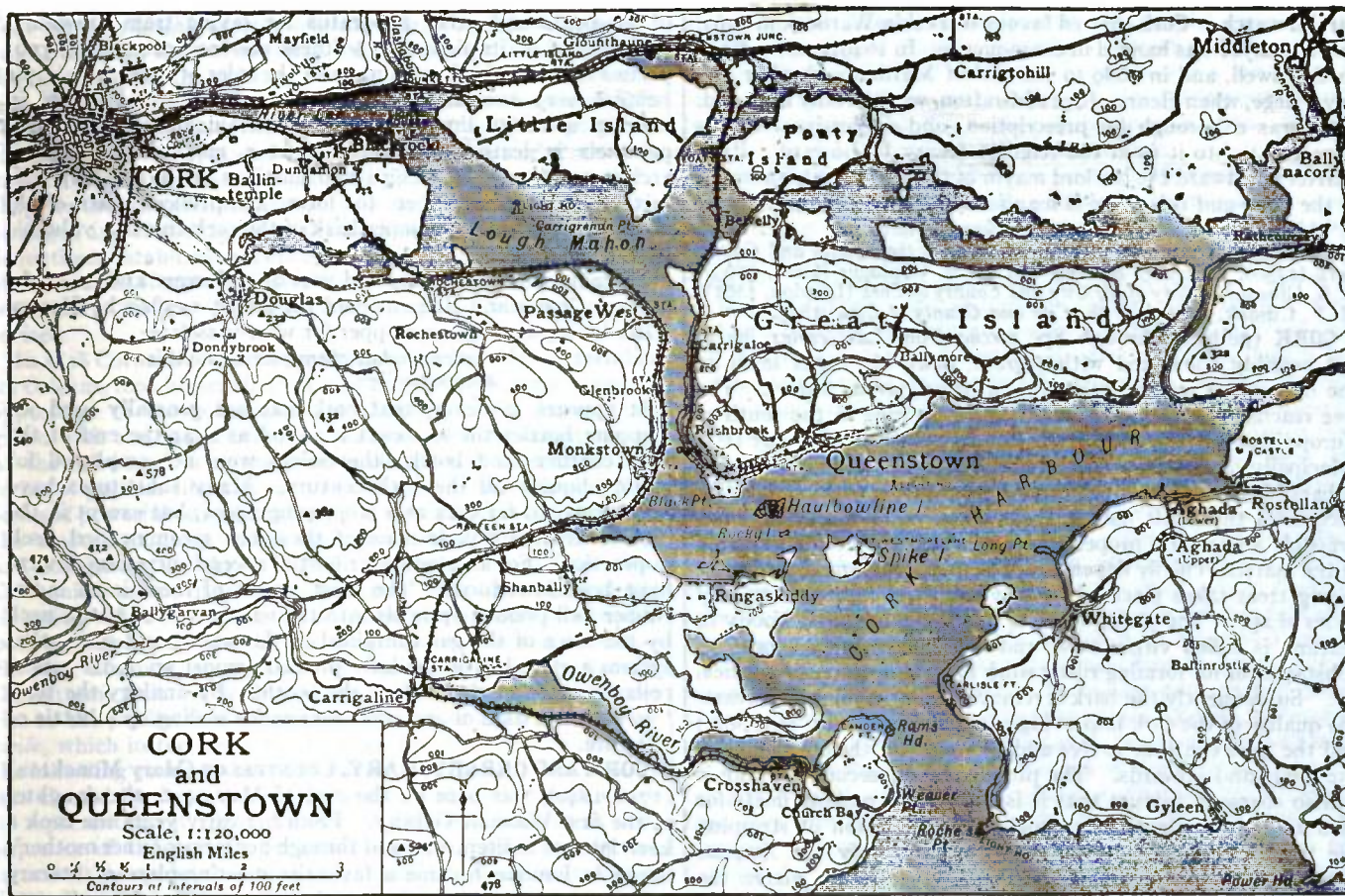

Based on information embodied from the Ordnance Survey, by permission of the Controller of H. M. Stationery Office.

designed by Sir Thomas Deane, occupies a beautiful site on the river in the west of the city, where Gill Abbey, of the 7th century, formerly stood. It is a fine building in Tudor Style, "worthy," said Macaulay, "to stand in the High Street of Oxford." A large library, museum and well-furnished laboratory are here. The Crawford School of Science (1885); and the Munster Dairy and Agricultural School, 1 m. west of the city, also claim notice; while besides parochial and industrial schools several of the religious orders located here devote themselves to education. The Cork library (founded 1790) contains a valuable collection of books. The Royal Cork Institution (1807), in addition to an extensive library and a rare collection of Oriental MSS., possesses a valuable collection of minerals, and the collections of casts from the antique presented by the pope to George IV. There are numerous literary and scientific societies, including the Cork Cuvierian and Archaeological Society. The principal clubs are the County and the Southern in South Mall, and the City in Grand Parade; while for sport there are the Cork Golf Club, Little Island, three rowing clubs, and the Royal Munster and Royal Cork Yacht clubs, the latter located at Queenstown. The theatres are the opera-house in Nelson's Place, and the Theatre Royal.

The country neighbouring to Cork is highly attractive. The harbour, with the ceaseless activity of shipping, its calm waters, sheltered by many islands, and its well-wooded shores studded with pleasant watering-places, affords a series of charming views, apart from its claim to be considered one of the finest natural harbours in the kingdom. Military depots occupy several of the smaller islets, and three batteries guard the entry. This is about 1 m. wide, but within the width increases to 3 m. while the length is about 10 m. The Atlantic port of Queenstown (*q.v.*) is on Great Island at the head of the outer harbour. Tivoli (the residence of Sir Walter Raleigh), Fort William, Lota Park, and Blackrock Castle are notable features on the shore; and Passage, Blackrock, Glenbrook and Monkstown are waterside

resorts. Inland from Cork runs the picturesque valley of the Lee, and low hills surround the commanding situation of the port.

The harbour is by far the most important on the south coast of Ireland, and dredging operations render the quays approachable for vessels drawing 20 ft. at all states of the tide. Its trade is mainly with Bristol and the ports of South Wales. The imports, exceeding £1,000,000 in annual value, include large quantities of wheat and maize, while the exports (about £9000 annually) are chiefly of cattle, provisions, butter and fish. The Cork Butter Exchange, where classification of the various qualities is carried out by branding under the inspection of experts, was important in the early part of the 17th century, and an unbroken series of accounts dates from 1769 when the present market was founded. There are distilleries, breweries, tanneries and iron foundries in the city; and manufactures of woollen and leather goods, tweeds, friezes, gloves and chemical manure. Nearly six-sevenths of the population are Roman Catholics. The city does not share with the county the rapid decrease of population. It is governed by a lord mayor, 14 aldermen and 42 councillors. The parliamentary borough returns two members.

The original site of Cork seems to have been in the vicinity of the Protestant cathedral; St Finbar's ecclesiastical foundation attracting many students and votaries. In the 9th century the town was frequently pillaged by the Northmen. According to the *Annals of the Four Masters* a fleet burned Cork in 821; in 846 the Danes appear to have been in possession of the town, for a force was collected to demolish their fortress; and in 1012 Cork again fell in flames. The Danes then appear to have founded the new city on the banks of the Lee as a trading centre. It was anciently surrounded with a wall, an order for the reparation of which is found so late as 1748 in the city council books (which date from 1610). Submission and homage were made to Henry II. on his arrival in 1172, and subsequently the English held the town for a long period against the Irish, by constant and

careful watch. Cork showed favour to Perkin Warbeck in 1492, and its mayor was hanged in consequence. In 1649 it surrendered to Cromwell, and in 1689 to the earl of Marlborough after five days' siege, when Henry, duke of Grafton, was mortally wounded. Cork was a borough by prescription, and successive charters were granted to it from the reign of Henry II. onward. By a charter of Edward IV. the lord mayor of Cork was created admiral of the port, and this office is manifested in a triennial ceremony in which the mayor throws a dart over the harbour.

See C. Smith, *Ancient and Present State of the County and City of Cork* (1750), edited by R. Day and W. A. Copinger (Cork, 1893); C. B. Gibson, *History of the City and County of Cork* (London, 1861); M. F. Cusack, *History of the City and County of Cork*, 1875.

**CORK** (perhaps through Sp. *corcha* from Lat. *cortex*, bark, but possibly connected with *quercus*, oak), the outer layer of the bark of an evergreen species of oak (*Quercus Suber*). The tree reaches the height of about 30 ft., growing in the south of Europe and on the North African coasts generally; but it is principally cultivated in Spain and Portugal. The outer layer of bark in the cork oak by annual additions from within gradually becomes a thick soft homogeneous mass, possessing those compressible and elastic properties upon which the economic value of the material chiefly depends. The first stripping of cork from young trees takes place when they are from fifteen to twenty years of age. The yield, which is rough, unequal and woody in texture, is called virgin cork, and is useful only as a tanning substance, or for forming rustic work in ferneries, conservatories, &c. Subsequently the bark is removed every eight or ten years, the quality of the cork improving with each successive stripping; and the trees continue to live and thrive under the operation for 150 years and upwards. The produce of the second barking is still so coarse in texture that it is only fit for making floats for nets and for similar applications. The operation of stripping the trees takes place during the months of July and August. Two cuts are made round the stem—one a little above the ground, and the other immediately under the spring of the main branches. Between these three or four longitudinal incisions are then made, the utmost care being taken not to injure the inner bark. The cork is thereafter removed in the sections into which it has been cut, by inserting under it the wedge-shaped handle of the implement used in making the incisions. After the outer surface has been scraped and cleaned, the pieces are flattened by heating them over a fire and submitting them to pressure on a flat surface. In the heating operation the surface is charred, and thereby the pores are closed up, and what is termed "nerve" is given to the material. In this state the cork is ready for manufacture or exportation.

Though specially developed in the cork-oak, the substance cork is an almost universal product in the stems (and roots) of woody plants which increase in diameter year by year. Generally towards the end of the first year the original thin protective layer of a stem or branch is replaced by a thin layer of "cork," that is a layer of cells the living contents of which have disappeared while the walls have become thickened and toughened as the result of the formation in them of a substance known as suberin. Fresh cork is formed each season by an active formative layer below the layer developed last season, which generally peels off. Where the formation is extensive and persistent as in the cork-oak, a thick covering of cork is formed. In some cases, as on young shoots of the cork-elm, the development is irregular and wing-like outgrowths of cork are formed. In northern Russia a similar method to that used for obtaining cork from the cork-oak is employed with the birch.

Cork possesses a combination of properties which peculiarly fits it for many and diverse uses, for some of which it alone is found applicable. The leading purpose for which it is used is for forming bungs and stoppers for bottles and other vessels containing liquids. Its compressibility, elasticity and practical imperviousness to both air and water so fit it for this purpose that the term cork is even more applied to the function than to the substance. Its specific lightness, combined with strength and durability, recommend it above all other substances for forming life-buoys, belts and jackets, and in the construction

of life-boats and other apparatus for saving from drowning. On account of its lightness, softness and non-conducting properties it is used for hat-linings and the soles of shoes, the latter being a very ancient application of cork. It is also used in making artificial limbs, for lining entomological cases, for pommels in leather-dressing, and as a medium for making architectural models. Chips and cuttings are ground up and mixed with india-rubber to form kamptulicon floor-cloth, or "cork-carpet." The inner bark of the cork-tree is a valuable tanning material.

Certain of the properties and uses of cork were known to the ancient Greeks and Romans, and the latter, we find by Horace (*Odes* iii. 8), used it as a stopper for wine-vessels:—

"corticem adstrictum pice dimovebit  
amphorae"—

It appears, however, that cork was not generally used for stopping bottles till so recent a period as near the end of the 17th century, and bottles themselves were not employed for storing liquids till the 15th century. Many substitutes have been proposed for cork as a stoppering agent; but except in the case of aerated liquids none of these has recommended itself in practice. For aerated water bottles several successful devices have been introduced. The most simple of these is an india-rubber ball pressed upwards into the narrow of the bottle neck by the force of the gas contained in the water; and in another system a glass ball is similarly pressed against an india-rubber collar inserted in the neck of the bottle. By analogy the term "to cork" is used of any such devices for sealing up a bottle or aperture.

**CORK AND ORRERY, MARY, COUNTESS OF** (Mary Monckton) (1746–1840), was born on the 21st of May 1746, the daughter of the first Viscount Galway. From her early years she took a keen interest in literature, and through her influence her mother's house in London became a favourite meeting-place of literary celebrities. Dr Johnson was a frequent guest. According to Boswell, Miss Monckton's "vivacity enchanted the sage, and they used to talk together with all imaginable ease." Sheridan, Reynolds, Burke and Horace Walpole were among her constant visitors, and Mrs Siddons was her closest friend. In 1786 she married the seventh earl of Cork and Orrery, who died in 1798. As Lady Cork, her love of social "lions" became more pronounced than ever. Among her regular guests were Canning and Castlereagh, Byron, Sir Walter Scott, Lord John Russell, Sir Robert Peel, Theodore Hook and Sydney Smith. She is supposed to have been the original of Lady Bellair in Disraeli's *Henrietta Temple*, and Dickens is believed to have drawn on her for some of the peculiarities of Mrs Leo Hunter in *Pickwick*. Lady Cork had a remarkable memory, and was a brilliant conversationalist. She died in London on the 30th of May 1840. She was then ninety-four, but within a few days of her death had been either dining out or entertaining every night. There is a fine portrait of her by Reynolds.

**CORLEONE** (Saracen, *Korliun*), a town of Sicily, in the province of Palermo, 42 m. S. of Palermo by rail and 21 m. direct, 1949 ft. above sea-level. Pop. (1901) 14,803. The town was a Saracen settlement, but a Lombard colony was introduced by Frederick II. Two medieval castles rise above the town, and there are some churches of interest.

**CORMENIN, LOUIS MARIE DE LA HAYE, VICOMTE DE** (1788–1868), French jurist and political pamphleteer, was born at Paris on the 6th of January 1788. His father and his grandfather both held the rank of lieutenant-general of the admiralty. At the age of twenty he was received advocate, and about the same time he gained some reputation as a writer of piquant and delicate poems. In 1810 he received from Napoleon I. the appointment of auditor to the council of state; and after the restoration of the Bourbons he became master of requests. During the period of his connexion with the council he devoted himself zealously to the study of administrative law. He was selected to prepare some of the most important reports of the council. Among his separate publications at this time are noted, —*Du conseil d'état envisagé comme conseil et comme juridiction*



*dans notre monarchie constitutionnelle* (1818), and *De la responsabilité des agents du gouvernement*. In the former he claimed, for the protection of the rights of private persons in the administration of justice, the institution of a special court whose members should be irremovable, the right of oral defence, and publicity of trial. In 1822 appeared his *Questions de droit administratif*, in which he for the first time brought together and gave scientific shape to the scattered elements of administrative law. These he arranged and stated clearly in the form of aphorisms, with logical deductions, establishing them by proofs drawn from the archives of the council of state. This is recognized as his most important work as a jurist. The fifth edition (1840) was thoroughly revised.

In 1828 Cormenin entered the Chamber of Deputies as member for Orleans, took his seat in the Left Centre, and began a vigorous opposition to the government of Charles X. As he was not gifted with the qualifications of the orator, he seldom appeared at the tribune; but in the various committees he defended all forms of popular liberties, and at the same time delivered, in a series of powerful pamphlets, under the pseudonym of "Timon," the most formidable blows against tyranny and all political and administrative abuses. After the revolution of July 1830, Cormenin was one of the 221 who signed the protest against the elevation of the Orleans dynasty to the throne; and he resigned both his office in the council of state and his seat in the chamber. He was, however, soon re-elected deputy, and now voted with the extreme Left. The discussions on the budget in 1831 gave rise to the publication of his famous series of *Lettres sur la liste civile*, which in ten years ran through twenty-five editions. In the following year he was elected deputy for Belley. In 1834 he was elected by two arrondissements, and sat for Joigny, which he represented till 1846. In this year he lost his seat in consequence of the popular prejudice aroused against him by his trenchant pamphlet *Oui et non* (1845) against attacks on religious liberty, and a second entitled *Feul Feul* (1845), written in reply to those who demanded a retraction of the former. Sixty thousand copies were rapidly sold.

Cormenin was an earnest advocate of universal suffrage before the revolution of February 1848, and had remorselessly exposed the corrupt practices at elections in his pamphlet—*Ordre du jour sur la corruption électorale*. After the revolution he was elected by four departments to the Constituent Assembly, and became one of its vice-presidents. He was also member and president of the constitutional commission, and for some time took a leading part in drawing up the republican constitution. But the disputes which broke out among the members led him to resign the presidency. He was soon after named member of the council of state and president of the *comité du contentieux*. It was at this period that he published two pamphlets—*Sur l'indépendance de l'Italie*. After the *coup d'état* of December 2, 1851, Cormenin, who had undertaken the defence of Prince Louis Napoleon after his attempt at Strassburg, accepted a place in the new council of state of the empire. Four years later, by imperial ordinance, he was made a member of the Institute. One of the most characteristic works of Cormenin is the *Livre des orateurs*, a series of brilliant studies of the principal parliamentary orators of the restoration and the monarchy of July, the first edition of which appeared in 1838, and the eighteenth in 1860. In 1846 he published his *Entretiens de village*, which procured him the Montyon prize, and of which six editions were called for the same year. His last work was *Le Droit de tonnage en Algérie* (1860). He died at Paris, on the 6th of May 1868. Two volumes of his *Reliquiae* were printed in Paris in the same year.

**CORMON, FERNAND** (1845- ), French painter, was born in Paris. He became a pupil of Cabanel, Fromentin and Portaels, and one of the leading historical painters of modern France. At an early age he attracted attention by the better class of sensationalism in his art, although for a time his powerful brush dwelled with particular delight on scenes of bloodshed, such as the "Murder in the Seraglio" (1868) and the "Death of Ravara, Queen of Lanka" at the Toulouse Museum. The Luxembourg has his "Cain flying before Jehovah's Curse"; and for the

Mairie of the fourth arrondissement of Paris he executed in grisaille a series of Panels: "Birth," "Death," "Marriage," "War," &c. "A Chief's Funeral," and pictures having the Stone Age for their subject, occupied him for several years. He was appointed to the Legion of Honour in 1880. Subsequently he also devoted himself to portraiture.

**CORMONTAINGNE, LOUIS DE** (c. 1697-1752), French military engineer, was born at Strassburg. He was present as a volunteer at the sieges of Freiburg and Landau in the later years of the War of the Spanish Succession, and in 1715 he entered the engineers. After being stationed for some years at Strassburg he became captain, and was put in charge (at first in a subordinate capacity, and subsequently as chief engineer) of the new works, Forts Moselle and Bellecroix, at Metz, which he built according to his own system of fortification. He was present at the siege of Philipsburg in 1733, and as a lieutenant-colonel took part in most of the sieges in the Low Countries during the War of the Austrian Succession. He attained the rank of brigadier and finally that of *maréchal de camp*, and was employed in fortification work until his death. His *Architecture militaire*, written in 1714, was long kept secret by order of the authorities, but, an unauthorized edition having appeared at the Hague in 1741, he himself prepared another version called *Premier mémoire sur la fortification*, which from 1741 onwards was followed by others. His ideas are closely modelled on those of Vauban (*q.v.*), and in his lifetime he was not considered the equal of such engineers as d'Asfeld and Filley. It was not until twenty years after his death that his system became widely known. Fourcroy de Rainecourt, then chief of engineers, searching the archives for valuable matter, chose the numerous memoirs of Cormontaigne for publication amongst engineer officers in 1776. Even then they only circulated privately, and it was not until the engineer Bousmard published Cormontaigne's *Mémorial de l'attaque des places* (Berlin, 1803) that Fourcroy, and after him General La Fitte de Clavé, actually gave to the general public the *Œuvres posthumes de Cormontaigne* (Paris, 1806-1809).

His system of fortification was not marked by any great originality of thought, which indeed could not be expected of a member of the *corps du génie*, the characteristics of which were a close caste spirit and an unquestioning reverence for the authority of Vauban. Forts Moselle and Bellecroix are still in existence.

See Von Brese-Winiari, *Über Entstehen etc. der neueren Befestigungsmethode* (Berlin, 1844); Prévost du Vernois, *De la fortification depuis Vauban* (Paris, 1861); Cosseron de Villenoisy, *Essai historique sur la fortification* (Paris, 1869).

**CORMORANT** (from the Lat. *corvus marinus*,<sup>1</sup> through the Fr., in some *patois* of which it is still "cor marin"; in certain Ital. dialects are the forms "corvo marin" or "corvo marino"), a large sea-fowl belonging to the genus *Phalacrocorax*<sup>2</sup> (*Carbo*, *Halieus* and *Graculus* of some ornithologists), and that group of the Linnaean order *Anseres*, now partly generally recognized by Illiger's term *Steganopodes*, of which it with its allies forms a family *Phalacrocoracidae*.

The cormorant (*P. carbo*) frequents almost all the sea-coast of Europe, and breeds in societies at various stations, most generally on steep cliffs, but occasionally on rocky islands as well as on trees. The nest consists of a large mass of sea-weed, and, with the ground immediately surrounding it, generally looks as though bespattered with whitewash, from the excrement of the bird, which lives entirely on fish. The eggs, from four to six in number, are small, and have a thick, soft, calcareous shell, bluish-white when first laid, but soon becoming discoloured. The young are hatched blind, and covered with an inky-black skin. They remain for some time in the squab-condition, and are then highly esteemed for food by the northern islanders, their flesh being said to taste as well as a roasted hare's. Their first plumage is of a sombre brownish-black above, and more or less white beneath. They take two or three years to assume the fully adult

<sup>1</sup> Some authors, following Caius, derive the word from *corvus vorans* and spell it corvorant, but doubtless wrongly.

<sup>2</sup> So spelt since the days of Gesner; but possibly *Phalarocorax* would be more correct.



dress, which is deep black, glossed above with bronze, and varied in the breeding-season with white on the cheeks and flanks, besides being adorned by filamentary feathers on the head, and further set off by a bright yellow gape. The old cormorant looks nearly as big as a goose, but is really much smaller; its flesh is quite uneatable.

Taken when young from the nest, this bird is easily tamed and can be trained to fish for its keeper, as was of old time commonly done in England, where the master of the cormorants was one of the officers of the royal household. Nowadays the practice is nearly obsolete. When taken out to furnish sport, a strap is fastened round the bird's neck so as, without impeding its breath, to hinder it from swallowing its captures.<sup>1</sup> Arrived at the waterside, it is cast off. It at once dives and darts along the bottom as swiftly as an arrow in quest of its prey, rapidly scanning every hole or pool. A fish is generally seized within a few seconds of its being sighted, and as each is taken the bird rises to the surface with its capture in its bill. It does not take much longer to dispose of the prize in the dilatable skin of its throat so far as the strap will allow, and the pursuit is recommenced until the bird's gular pouch, capacious as it is, will hold no more. It then returns to its keeper, who has been anxiously watching and encouraging its movements, and a little manipulation of its neck effects the delivery of the booty. It may then be let loose again, or, if considered to have done its work, it is fed and restored to its perch. The activity the bird displays under water is almost incredible to those who have not seen its performances, and in a shallow river scarcely a fish escapes its keen eyes, and sudden turns, except by taking refuge under a stone or root, or in the mud that may be stirred up during the operation, and so avoiding observation (see Salvin and Freeman, *Falconry*, 1859).

Nearly allied to the cormorant, and having much the same habits, is the shag, or green cormorant of some writers (*P. graculus*). The shag (which name in many parts of the world is used in a generic sense) is, however, about one-fourth smaller in linear dimensions, is much more glossy in plumage, and its nuptial embellishment is a nodding plume instead of the white patches of the cormorant. The easiest diagnostic on examination will be found to be the number of tail-feathers, which in the former are fourteen and in the shag twelve. The latter, too, is more marine in the localities it frequents, scarcely ever entering fresh or indeed inland waters.

In the south of Europe a much smaller species (*P. pygmaeus*) is found. This is almost entirely a fresh-water bird, and is not uncommon on the lower Danube. Other species, to the number perhaps of thirty or more, have been discriminated from other parts of the world, but all have a great general similarity to one another. New Zealand and the west coast of northern America are particularly rich in birds of this genus, and the species found there are the most beautifully decorated of any. All, however, are remarkable for their curiously-formed feet, the four toes of each being connected by a web, for their long stiff tails, and for the absence, in the adult, of any exterior nostrils. When gorged, or when the state of the tide precludes fishing, they are fond of sitting on an elevated perch, often with extended wings, and in this attitude they will remain motionless for a considerable time, as though hanging themselves out to dry. It was perhaps this peculiarity that struck the observation of Milton, and prompted his well-known similitude of Satan to a cormorant (*Parad. Lost*, iv. 194); but when not thus behaving they themselves provoke the more homely comparison of a row of black bottles. Their voracity is proverbial. (A. N.)

**CORN** (a common Teutonic word; cf. Lat. *granum*, seed, grain), originally meaning a small hard particle or grain, as of sand, salt, gunpowder, &c. It thus came to be applied to the small hard seed of a plant, as still used in the words barley-corn and pepper-corn. In agriculture it is generally applied to the seed of the cereal plants. It is often locally understood to mean that kind of cereal which is the leading crop of the district;

<sup>1</sup> According to Willoughby it was formerly the custom to carry the cormorant hooded till it was required; in modern practice the bearer wears a face-mask to protect himself from its beak.

thus in England it refers to wheat, in Scotland and Ireland to oats, and in the United States to maize (Indian corn). See GRAIN TRADE; CORN LAWS; AGRICULTURE; WHEAT; MAIZE; &c.

The term "corned" is given to a preparation of meat (especially beef) on account of the original manner of preserving it by the use of salt in grains or "corns."

**CORN** (from Lat. *cornu*, horn), in pathology (technically *clavus*), a localized outgrowth of the epidermic layer of the skin, most commonly of the toe, with a central ingrowth of a hard horny plug. The underlying papillae are atrophied, causing a cup-shaped hollow, whilst the surrounding papillae are hypertrophied. The condition is mainly caused by badly fitting boots, though any undue pressure, of insufficient power to give rise to ulceration, may be the cause of a corn. Corns may be hard or soft. The hard corn usually occurs on one of the toes, is a more or less conical swelling and may be extremely painful at times. If suppuration occurs around the corn, it is apt to burrow, and if unattended to may give rise to arthritis or even necrosis. The best treatment is to soften the corn with hot water, pare it very carefully with a sharp knife, and then paint it with a solution of salicylic acid in collodion. The painting must be repeated three times a day for a week or ten days. The soft corn occurs between the toes and is usually a more painful condition. Owing to the absorption of sweat its surface may become white and sodden in appearance. The treatment is much the same, but spirits of camphor should be painted on each night, and a layer of cotton wool placed between the toes during the daytime.

**CORNARO, CATERINA** (1454-1510), queen of Cyprus, was the daughter of Marco Cornaro, a Venetian noble, whose brother Andrea was an intimate friend of James de Lusignan, natural son of King John II. of Cyprus. In the king's death in 1458 the succession was disputed, and James, with the help of the sultan of Egypt, seized the island. But several powers were arrayed against him—the duke of Savoy, who claimed the island on the strength of the marriage of his son Louis to Charlotte, the only legitimate daughter of John II.,<sup>2</sup> the Genoese, and the pope. It was important that he should make a marriage such as would secure him powerful support. Andrea Cornaro suggested his niece Caterina, famed for her beauty, as that union would bring him Venetian help. The proposal was agreed to, and approved of by Caterina herself and the senate, and the contract was signed in 1468. But further intrigues caused delay, and it was not until 1471 that James's hesitations were overcome. Caterina was solemnly adopted by the doge as a "daughter of the Republic" and sailed for Cyprus in 1472 with the title of queen of Cyprus, Jerusalem and Armenia. But she only enjoyed one year of happiness, for in 1473 her husband died of fever, leaving his kingdom to his queen and their child as yet unborn. Enemies and rival claimants arose on all sides, for Cyprus was a tempting bait. In August the child James III. was born, but as soon as the Venetian fleet sailed away a plot to depose him in favour of Zarla, James's illegitimate daughter, broke out, and Caterina was kept a prisoner. The Venetians returned, and order was soon restored, but the republic was meditating the seizure of Cyprus, although it had no valid title whatever, and after the death of Caterina's child in 1474 it was Venice which really governed the island. The poor queen was surrounded by intrigues and plots, and although the people of the coast towns loved her, the Cypriot nobles were her bitter enemies and hostile to Venetian influence. In 1488 the republic, fearing that Sultan Bayezid II. intended to attack Cyprus, and having also discovered a plot to marry Caterina to King Alphonso II. of Naples, a proposal to which she seemed not averse, decided to recall the queen to Venice and formally annex the island. Caterina at first refused, for she clung to her royalty, but Venice was a severe parent to its adopted daughter and would not be gainsaid; she was forced to abdicate in favour of the republic, and returned to Venice in 1489. The government conferred on

<sup>2</sup> Whence the kings of Italy derive their title of kings of Cyprus and Jerusalem.

her the castle and town of Asolo for life, and there in the midst of a learned and brilliant little court, of which Cardinal Bembo (*q.v.*) was a shining light, she spent the rest of her days in idyllic peace. She died in July 1510. Titian's famous portrait of her is in the Uffizi gallery in Florence.

**BIBLIOGRAPHY.**—A. Centelli, *Caterina Cornaro e il suo regno* (Venice, 1892); S. Romanin, *Storia documentata di Venezia*, vol. iv. (Venice, 1855), and his *Lezioni di storia Veneta* (Florence, 1875); L. de Mas Latrie, *Histoire de l'île de Chypre* (Paris, 1852-1861); and Horatio Brown's essay in his *Studies in Venetian History* (London, 1907), which gives the best sketch of the queen's career and a list of authorities. (L. V. \*)

**CORNARO, LUIGI** (1467-1566), a Venetian nobleman, famous for his treatises on a temperate life. In his youth he lived freely, but after a severe illness at the age of forty, he began under medical advice gradually to reduce his diet. For some time he restricted himself to a daily allowance of 12 oz. of solid food and 14 oz. of wine; later in life he reduced still further his bill of fare, and found he could support his life and strength with no more solid meat than an egg a day. At the age of eighty-three he wrote his treatise on *The Sure and Certain Method of Attaining a Long and Healthful Life*, the English translation of which went through numerous editions; and this was followed by three others on the same subject, composed at the ages of eighty-six, ninety-one and ninety-five respectively. The first three were published at Padua in 1558. They are written, says Addison (*Spectator*, No. 195), "with such a spirit of cheerfulness, religion and good sense, as are the natural concomitants of temperance and sobriety." He died at Padua at the age of ninety-eight.

**CORNBRASH**, in geology, the name applied to the uppermost member of the Bathonian stage of the Jurassic formation in England. It is an old English agricultural name applied in Wiltshire to a variety of loose rubble or "brash" which, in that part of the country, forms a good soil for growing corn. The name was adopted by William Smith for a thin band of shelly limestone which, in the south of England, breaks up in the manner indicated. Although only a thin group of rocks (10-25 ft.), it is remarkably persistent; it may be traced from Weymouth to the Yorkshire coast, but in north Lincolnshire it is very thin, and probably dies out in the neighbourhood of the Humber. It appears again, however, as a thin bed in Gristhorpe Bay, Cayton Bay, Wheatcroft, Newton Dale and Langdale. In the inland exposures in Yorkshire it is difficult to follow on account of its thinness, and the fact that it passes up into dark shales in many places—the so-called "clays of the Cornbrash," with *Avicula echinata*.

The Cornbrash is a very fossiliferous formation; the fauna indicates a transition from the Lower to the Middle Oolites, though it is probably more nearly related to that of the beds above than to those below. Good localities for fossils are Radipole near Weymouth, Clossworth, Wincanton, Trowbridge, Cirencester, Witney, Peterborough and Sudbrook Park near Lincoln. A few of the important fossils are: *Waldheimia lagenalis*, *Pecten levis*, *Avicula echinata*, *Ostrea flabelloides*, *Myacites decurtatus*, *Echinobrissus clunicularis*; *Macrocephalites macrocephalus* is abundant in the midland counties but rarer in the south; belemnites are not known. The remains of saurians (*Steneosaurus*) are occasionally found. The Cornbrash is of little value for building or road-making, although it is used locally; in the south of England it is not oolitic, but in Yorkshire it is a rubby, marly, frequently ironshot oolitic limestone. In Bedfordshire it has been termed the Bedford limestone.

See JURASSIC; also H. B. Woodward, "The Jurassic Rocks of Britain," vol. iv. (1894); and C. Fox Strangways, vol. i.; both *Memoirs of the Geological Survey*. (J. A. H.)

**CORNEILLE, PIERRE** (1606-1684), French dramatist and poet, was born at Rouen, in the rue de la Pie, on the 6th of June 1606. The house, which was long preserved, was destroyed not many years ago. His father, whose Christian name was the same, was *avocat du roi à la Table de Marbre du Palais*, and also held the position of *maître des eaux et forêts* in the *vicomté* (or *bailliage*, as some say) of Rouen. In this latter office he is said to have shown himself a vigorous magistrate, suppressing

brigandage and plunder without regard to his personal safety. He was ennobled in 1637 (it is said not without regard to his son's distinction), and the honour was renewed in favour of his sons Pierre and Thomas in 1669, when a general repeal of the letters of nobility recently granted had taken place. There appears, however, to be no instance on record of the poet himself assuming the "de" of nobility. His mother's name was Marthe le Pesant.

After being educated by the Jesuits of Rouen, Corneille at the age of eighteen was entered as *avocat*, and in 1624 took the oaths, as we are told, four years before the regular time, a dispensation having been procured. He was afterwards appointed advocate to the admiralty, and to the "waters and forests," but both these posts must have been of small value, as we find him parting with them in 1650 for the insignificant sum of 6000 livres. In that year and the next he was *procureur-syndic des États de Normandie*. His first play, *Mélite*, was acted in 1629. It is said by B. le B. de Fontenelle (his nephew) to have been inspired by personal experiences, and was extremely popular, either because or in spite of its remarkable difference from the popular plays of the day, those of A. Hardy. In 1632 *Clitandre*, a tragedy, was printed (it may have been acted in 1631); in 1633 *La Veuve* and the *Galerie du palais*, in 1634 *La Suivante* and *La Place Royale*, all the last-named plays being comedies, saw the stage. In 1634 also, having been selected as the composer of a Latin elegy to Richelieu on the occasion of the cardinal visiting Rouen, he was introduced to the subject of his verses, and was soon after enrolled among the "five poets." These officers (the others being G. Colletet, Boisrobert and C. de l'Étoile, who in no way merited the title, and J. de Rotrou, who was no unworthy yokefellow even of Corneille) had for task the more profitable than dignified occupation of working up Richelieu's ideas into dramatic form. No one could be less suited for such work than Corneille, and he soon (it is said) incurred his employer's displeasure by altering the plan of the third act of *Les Thuilleries*, which had been entrusted to him.

Meanwhile the year 1635 saw the production of *Médée*, a grand but unequal tragedy. In the next year the singular extravaganza entitled *L'illusion comique* followed, and was succeeded about the end of November by the *Cid*, based on the *Mocedades del Cid* of Guillem de Castro. The triumphant success of this, perhaps the most "epoch-making" play in all literature, the jealousy of Richelieu and the Academy, the open attacks of Georges de Scudéry and J. de Mairet and others, and the pamphlet-war which followed, are among the best-known incidents in the history of letters. The trimming verdict of the Academy, which we have in J. Chapelain's *Sentiments de l'Académie française sur la tragi-comédie du Cid* (1638), when its arbitration was demanded by Richelieu, and not openly repudiated by Corneille, was virtually unimportant; but it is worth remembering that no less a writer than Georges de Scudéry, in his *Observations sur le Cid* (1637), gravely and apparently sincerely asserted and maintained of this great play that the subject was utterly bad, that all the rules of dramatic composition were violated, that the action was badly conducted, the versification constantly faulty, and the beauties as a rule stolen! Corneille himself was awkwardly situated in this dispute. The *esprit bourru* by which he was at all times distinguished, and which he now displayed in his rather arrogant *Excuse à Ariste*, unfitted him for controversy, and it was of vital importance to him that he should not lose the outward marks of favour which Richelieu continued to show him. Perhaps the pleasantest feature in the whole matter is the unshaken and generous admiration with which Rotrou, the only contemporary whose genius entiled him to criticise Corneille, continued to regard his friend, rival, and in some sense (though Rotrou was the younger of the two) pupil. Finding it impossible to make himself fairly heard in the matter, Corneille (who had retired from his position among the "five poets") withdrew to Rouen and passed nearly three years in quiet there, perhaps revolving the opinions afterwards expressed in his three *Discours* and in the *Examens* of his plays, where he bows, somewhat as in the house of Rimmon, to "the rules." In 1639,

or at the beginning of 1640, appeared *Horace* with a dedication to Richelieu. The good offices of Madame de Combalet, to whom the *Cid* had been dedicated, and perhaps the satisfaction of the cardinal's literary jealousy, had healed what breach there may have been, and indeed the poet was in no position to quarrel with his patron. Richelieu not only allowed him 500 crowns a year, but soon afterwards, it is said, though on no certain authority, employed his omnipotence in reconciling the father of the poet's mistress, Marie de Lampérière, to the marriage of the lovers (1640). In this year also *Cinna* appeared. A brief but very serious illness attacked him, and the death of his father the year before had increased his family anxieties by leaving his mother in very indifferent circumstances. It has, however, been recently denied that he himself was at any time poor, as older traditions asserted.

In the following year Corneille figured as a contributor to the *Guirlande de Julie*, a famous album which the marquis de Montausier, assisted by all the literary men of the day, offered to his lady-love, Julie d'Angennes. 1643 was, according to the latest authorities (for Cornelian dates have often been altered), a very great year in the dramatist's life. Therein appeared *Polyeucte*, the memorable comedy of *Le Menteur*, which though adapted from the Spanish stood in relation to French comedy very much as *Le Cid*, which owed less to Spain, stood to French tragedy; its less popular and far less good *Suite*,—and perhaps *La Mort de Pompée*. *Rodogune* (1644) was a brilliant success; *Théodore* (1645), a tragedy on a somewhat perilous subject, was the first of Corneille's plays which was definitely damned. Some amends may have been made to him by the commission which he received next year to write verses for the *Triumphes poétiques de Louis XIII*. Soon after (22nd of January 1647) the Academy at last (it had twice rejected him on frivolous pleas) admitted the greatest of living French writers. *Héraclius* (1646), *Andromède* (1650), a spectacle-opera rather than a play, *Don Sanche d'Aragon* (1650) and *Nicomède* (1651) were the products of the next few years' work; but in 1652 *Pertharite* was received with decided disfavour, and the poet in disgust resolved, like Ben Jonson, to quit the loathed stage. In this resolution he persevered for six years, during which he worked at a verse translation of the *Imitation of Christ* (finished in 1656), at his three *Discourses on Dramatic Poetry*, and at the *Examens* which are usually printed at the end of his plays. In 1659 Fouquet, the Maecenas of the time, persuaded him to alter his resolve, and *Œdipe*, a play which became a great favourite with Louis XIV., was the result. It was followed by *La Toison d'or* (1660), *Sertorius* (1662) and *Sophonisbe* (1663). In this latter year Corneille (who had at last removed his residence from Rouen to Paris in 1662) was included among the list of men of letters pensioned at the proposal of Colbert. He received 2000 livres. *Othon* (1664), *Agésilas* (1666), *Attila* (1667), and *Tite et Bérénice* (1670), were generally considered as proofs of failing powers,—the cruel quatrain of Boileau—

"Après l'*Agésilas*  
Hélas!  
Mais après l'*Attila*  
Holà!"

in the case of these two plays, and the unlucky comparison with Racine in the *Bérénice*, telling heavily against them. In 1665 and 1670 some versifications of devotional works addressed to the Virgin had appeared. The part which Corneille took in *Psyché* (1671), Molière and P. Quinault being his coadjutors, showed signs of renewed vigour; but *Pulchérie* (1672) and *Suréna* (1674) were allowed even by his faithful followers to be failures. He lived for ten years after the appearance of *Suréna*, but was almost silent save for the publication, in 1676, of some beautiful verses thanking Louis XIV. for ordering the revival of his plays. He died at his house in the rue d'Argenteuil on the 30th of September 1684. For nine years (1674–1681), and again in 1683, his pension had, for what reason is unknown, been suspended. It used to be said that he was in great straits, and the story went (though, as far as Boileau is concerned, it has been invalidated), that at last Boileau, hearing of this,

went to the king and offered to resign his own pension if there were not money enough for Corneille, and that Louis sent the aged poet two hundred pistoles. He might, had it actually been so, have said, with a great English poet in like case, "I have no time to spend them." Two days afterwards he was dead.

Corneille was buried in the church of St Roch, where no monument marked his grave until 1821. He had six children, of whom four survived him. Pierre, the eldest son, a cavalry officer who died before his father, left posterity in whom the name has continued; Marie, the eldest daughter, was twice married, and by her second husband, M. de Farcy, became the ancestress of Charlotte Corday. Repeated efforts have been made for the benefit of the poet's descendants, Voltaire, Charles X. and the *Comédie française* having all borne part therein.

The portraits of Corneille (the best and most trustworthy of which is from the burin of M. Lasne, an engraver of Caen), represent him as a man of serious, almost of stern countenance, and this agrees well enough with such descriptions as we have of his appearance, and with the idea of him which we should form from his writings and conduct. His nephew Fontenelle admits that his general address and manner were by no means prepossessing. Others use stronger language, and it seems to be confessed that either from shyness, from pride, or from physical defects of utterance, probably from all three combined, he did not attract strangers. Racine is said to have assured his son that Corneille made verses "cent fois plus beaux" than his own, but that his own greater popularity was owing to the fact that he took some trouble to make himself personally agreeable. Almost all the anecdotes which have been recorded concerning him testify to a rugged and somewhat unamiable self-contentment. "Je n'ai pas le mérite de ce pays-ci," he said of the court. "Je n'en suis pas moins Pierre Corneille," he is said to have replied to his friends as often as they dared to suggest certain shortcomings in his behaviour, manner or speech. "Je suis saoul de gloire et affamé d'argent" was his reply to the compliments of Boileau. Yet tradition is unanimous as to his affection for his family, and as to the harmony in which he lived with his brother Thomas who had married Marguerite de Lampérière, younger sister of Marie, and whose household both at Rouen and at Paris was practically one with that of his brother. No story about Corneille is better known than that which tells of the trap between the two houses, and how Pierre, whose facility of versification was much inferior to his brother's, would lift it when hard bestead, and call out "Sans-souci, une rime!" Notwithstanding this domestic felicity, an impression is left on the reader of Corneille's biographies that he was by no means a happy man. Melancholy of temperament will partially explain this, but there were other reasons. He appears to have been quite free from envy properly so called, and to have been always ready to acknowledge the excellences of his contemporaries. But, as was the case with a very different man—Goldsmith—praise bestowed on others always made him uncomfortable unless it were accompanied by praise bestowed on himself. As Guizot has excellently said, "Sa jalousie fut celle d'un enfant qui veut qu'un sourire le rassure contre les caresses que reçoit son frère."

Although his actual poverty has been recently denied, he cannot have been affluent. His pensions covered but a small part of his long life and were most irregularly paid. He was no "dedicator," and the occasional presents of rich men, such as Montauron (who gave him a thousand, others say two hundred, pistoles for the dedication of *Cinna*), and Fouquet (who commissioned *Œdipe*), were few and far between, though they have exposed him to reflections which show great ignorance of the manners of the age. Of his professional earnings, the small sum for which, as we have seen, he gave up his offices, and the expression of Fontenelle that he practised "sans goût et sans succès," are sufficient proof. His patrimony and his wife's dowry must both have been trifling. On the other hand, it was during the early and middle part of his career impossible, and during the later part very difficult, for a dramatist to live decently by his pieces. It was not till the middle of the century that the custom

of allowing the author two shares in the profits during the first run of the piece was observed, and even then revivals profited him nothing. Thomas Corneille himself, who to his undoubted talents united wonderful facility, untiring industry, and (gift valuable above all others to the playwright) an extraordinary knack of hitting the public fancy, died, notwithstanding his simple tastes, "as poor as Job." We know that Pierre received for two of his later pieces two thousand livres each, and we do not know that he ever received more.

But his reward in fame was not stinted. Corneille, unlike many of the great writers of the world, was not driven to wait for "the next age" to do him justice. The cabal or clique which attacked the *Cid* had no effect whatever on the judgment of the public. All his subsequent masterpieces were received with the same ungrudging applause, and the rising star of Racine, even in conjunction with the manifest inferiority of Corneille's last five or six plays, with difficulty prevailed against the older poet's towering reputation. The great men of his time—Condé, Turenne, the maréchal de Grammont, the knight-errant duc de Guise—were his fervent admirers. Nor had he less justice done him by a class from whom less justice might have been expected, the brother men of letters whose criticisms he treated with such scant courtesy. The respectable mediocrity of Chapelain might misapprehend him; the lesser geniuses of Scudéry and Mairêt might feel alarm at his advent; the envious Claverets and D'Aubignacs might snarl and scribble. But Balzac did him justice; Rotrou, as we have seen, never failed in generous appreciation; Molière in conversation and in print recognized him as his own master and the foremost of dramatists. We have quoted the informal tribute of Racine; but it should not be forgotten that Racine, in discharge of his duty as respondent at the Academical reception of Thomas Corneille, pronounced upon the memory of Pierre perhaps the noblest and most just tribute of eulogy that ever issued from the lips of a rival. Boileau's testimony is of a more chequered character; yet he seems never to have failed in admiring Corneille whenever his principles would allow him to do so. Questioned as to the great men of Louis XIV.'s reign, he is said to have replied: "I only know three,—Corneille, Molière and myself." "And how about Racine?" his auditor ventured to remark. "He was an extremely clever fellow to whom I taught the art of elaborate rhyming" (*rimer difficilement*). It was reserved for the 18th century to exalt Racine above Corneille. Voltaire, who was prompted by his natural benevolence to comment on the latter (the profits went to a relation of the poet), was not altogether fitted by nature to appreciate Corneille, and moreover, as has been ingeniously pointed out, was not a little wearied by the length of his task. His partially unfavourable verdict was endorsed earlier by Vauvenargues, who knew little of poetry, and later by La Harpe, whose critical standpoint has now been universally abandoned. Napoleon I. was a great admirer of Corneille ("s'il vivait, je le ferais prince," he said), and under the Empire and the Restoration an approach to a sounder appreciation was made. But it was the glory of the romantic school, or rather of the more catholic study of letters which that school brought about, to restore Corneille to his true rank. So long, indeed, as a certain kind of criticism was pursued, due appreciation was impossible. When it was thought sufficient to say with Boileau that Corneille excited, not pity or terror, but admiration which was not a tragic passion; or that

"D'un seul nom quelquefois le son dur ou bizarre  
Rend un poème entier ou burlesque ou barbare;"

when Voltaire could think it crushing to add to his exposure of the "infamies" of *Théodore*—"après cela comment osons-nous condamner les pièces de Lope de Véga et de Shakespeare?"—it is obvious that the *Cid* and *Polyeucte*, much more *Don Sanche d'Aragon* and *Rodogune*, were sealed books to the critic.

Almost the first thing which strikes a reader is the singular inequality of this poet, and the attempts to explain this inequality, in reference to his own and other theories, leave the fact untouched. Producing, as he certainly has produced, work which classes him with the greatest names in literature, he has

also signed an extraordinary quantity of verse which has not merely the defects of genius, irregularity, extravagance, *bizarrellé*, but the faults which we are apt to regard as exclusively belonging to those who lack genius, to wit, the dulness and tediousness of mediocrity. Molière's manner of accounting for this is famous in literary history or legend. "My friend Corneille," he said, "has a familiar who inspires him with the finest verses in the world. But sometimes the familiar leaves him to shift for himself, and then he fares very badly." That Corneille was by no means destitute of the critical faculty his *Discourses* and the *Examens* of his plays (often admirably acute, and, with Dryden's subsequent prefaces, the originals to a great extent of specially modern criticism) show well enough. But an enemy might certainly contend that a poet's critical faculty should be of the Promethean, not be Epimethean order. The fact seems to be that the form in which Corneille's work was cast, and which by an odd irony of fate he did so much to originate and make popular, was very partially suited to his talents. He could imagine admirable situations, and he could write verses of incomparable grandeur—verses that reverberate again and again in the memory, but he could not, with the patient docility of Racine, labour at proportioning the action of a tragedy strictly, at maintaining a uniform rate of interest in the course of the plot and of excellence in the fashion of the verse. Especially in his later plays a verse and a couplet will crash out with fulgurous brilliancy, and then be succeeded by pages of very second-rate declamation or argument. It was urged against him also by the party of the *Doucereux*, as he called them, that he could not manage, or did not attempt, the great passion of love, and that except in the case of Chimène his principle seemed to be that of one of his own heroines:—

"Laissons, seigneur, laissons pour les petites âmes  
Ce commerce rampant de soupirs et de flammes."

(Aristie in *Sertorius*.)

There is perhaps some truth in this accusation, however much some of us may be disposed to think that the line just quoted is a fair enough description of the admired ecstasies of Achille and Bajazet. But these are all the defects which can be fairly urged against him; and in a dramatist bound to a less strict service they would hardly have been even remarked. They certainly neither require, nor are palliated by, theories of his "megalomania," of his excessive attention to conflicts of will and the like. On the English stage the liberty of unrestricted incident and complicated action, the power of multiplying characters and introducing prose scenes, would have exactly suited his somewhat intermittent genius, both by covering defects and by giving greater scope for the exhibition of power.

How great that power is can escape no one. The splendid soliloquies of Medea which, as Voltaire happily says, "annoncent Corneille," the entire parts of Rodogune and Chimène, the final speech of Camille in *Horace*, the discovery scene of *Cinna*, the dialogues of Pauline and Sévère in *Polyeucte*, the magnificently-contrasted conception and exhibition of the best and worst forms of feminine dignity in the Cornélie of *Pompée* and the Cléopâtre of *Rodogune*, the singularly fine contrast in *Don Sanche d'Aragon*, between the haughtiness of the Spanish nobles and the unshaken dignity of the supposed adventurer Carlos, and the characters of Aristie, Viriate and Sertorius himself, in the play named after the latter, are not to be surpassed in grandeur of thought, felicity of design or appropriateness of language. "Admiration" may or may not properly be excited by tragedy, and until this important question is settled the name of tragedian may be at pleasure given to or withheld from the author of *Rodogune*. But his rank among the greatest of dramatic poets is not a matter of question. For a poet is to be judged by his best things, and the best things of Corneille are second to none.

*The Plays*.—It was, however, some time before his genius came to perfection. It is undeniable that the first six or seven of his plays are of no very striking intrinsic merit. On the other hand, it requires only a very slight acquaintance with the state of the drama in France at the time to see that these works, poor as they may now seem, must have struck the spectators as something

new and surprising. The language and dialogue of *Médée* are on the whole simple and natural, and though the construction is not very artful (the fifth act being, as is not unusual in Corneille, superfluous and clumsy), it is still passable. The fact that one of the characters jumps on another's back, and the rather promiscuous kissing which takes place, are nothing to the liberties usually taken in contemporary plays. A worse fault is the *στυγούβλια*, or, to borrow Butler's expression, the Cat-and-Puss dialogue, which abounds. But the common objection to the play at the time was that it was *too* natural and too devoid of striking incidents. Corneille accordingly, as he tells us, set to work to cure these faults, and produced a truly wonderful work, *Citandre*. Murders, combats, escapes and outrages of all kinds are provided; and the language makes *The Rehearsal* no burlesque. One of the heroines rescues herself from a ravisher by blinding him with a hair-pin, and as she escapes the seducer apostrophizes the blood which trickles from his eye, and the weapon which has wounded it, in a speech forty verses long. This, however, was his only attempt of the kind. For his next four pieces, which were comedies, there is claimed the introduction of some important improvements, such as the choosing for scenes places well known in actual life (as in the *Galerie du palais*), and the substitution of the soubrette in place of the old inconvenient and grotesque nurse. It is certain, however, that there is more interval between these six plays and *Médée* than between the latter and Corneille's greatest drama. Here first do we find those sudden and magnificent lines which characterize the poet. The title-rôle is, however, the only good one, and as a whole the play is heavy. Much the same may be said of its curious successor *L'illusion comique*. This is not only a play within a play, but in part of it there is actually a *third* involution, one set of characters beholding another set discharging the parts of yet another. It contains, however, some very fine lines, in particular, a defence of the stage and some heroics put into the mouth of a braggadocio. We have seen it said of the *Cid* that it is difficult to understand the enthusiasm it excited. But the difficulty can only exist for persons who are insensible to dramatic excellence, or who so strongly object to the forms of the French drama that they cannot relish anything so presented. Rodrigue, Chimène, Don Diègue are not of any age, but of all time. The conflicting passions of love, honour, duty, are here represented as they never had been on a French stage, and in the "strong style" which was Corneille's own. Of the many objections urged against the play, perhaps the weightiest is that which condemns the frigid and superfluous part of the *Infanta*. *Horace*, though more skilfully constructed, is perhaps less satisfactory. There is a hardness about the younger Horace which might have been, but is not made, imposing, and Sabine's effect on the action is quite out of proportion to the space she occupies. The splendid declamation of Camille, and the excellent part of the elder Horace, do not altogether atone for these defects. *Cinna* is perhaps generally considered the poet's masterpiece, and it undoubtedly contains the finest single scene in all French tragedy. The blot on it is certainly the character of *Émilie*, who is spiteful and thankless, not heroic. *Polyeucte* has sometimes been elevated to the same position. There is, however, a certain coolness about the hero's affection for his wife which somewhat detracts from the merit of his sacrifice; while the Christian part of the matter is scarcely so well treated as in the *Saint Genest* of Rotrou or the *Virgin Martyr* of Massinger. On the other hand, the entire parts of *Pauline* and *Sévère* are beyond praise, and the manner in which the former reconciles her duty as a wife with her affection for her lover is an astonishing success. In *Pompée* (for *La Mort de Pompée*, though the more appropriate, was not the original title) the splendid declamation of *Cornélie* is the chief thing to be remarked. *Le menteur* fully deserves the honour which Molière paid to it. Its continuation, notwithstanding the judgment of some French critics, we cannot think so happy. But *Théodore* is perhaps the most surprising of literary anomalies. The central situation, which so greatly shocked Voltaire and indeed all French critics from the date of the piece, does not seem to blame. A virgin martyr who is threatened

with loss of honour as a bitterer punishment than loss of life offers points as powerful as they are perilous. But the treatment is thoroughly bad. From the heroine who is, in a phrase of Dryden's, "one of the coolest and most insignificant" heroines ever drawn, to the undignified Valens, the termagant Marcelle, and the peevish Placide, there is hardly a good character. Immediately upon this in most printed editions, though older in representation, follows the play which (therein agreeing rather with the author than with his critics) we should rank as his greatest triumph, *Rodogune*. Here there is hardly a weak point. The magnificent and terrible character of *Cléopâtre*, and the contrasted dispositions of the two princes, of course attract most attention. But the character of *Rodogune* herself, which has not escaped criticism, comes hardly short of these. *Héraclius*, despite great art and much fine poetry, is injured by the extreme complication of its argument and by the blustering part of *Pulchérie*. *Andromède*, with the later spectacle piece, the *Toison d'or*, do not call for comment, and we have already alluded to the chief merit of *Don Sanche*. *Nicomède*, often considered one of Corneille's best plays, is chiefly remarkable for the curious and unusual character of its hero. Of *Pertharite* it need only be said that no single critic has to our knowledge disputed the justice of its damnation. *Œdipe* is certainly unworthy of its subject and its author, but in *Sertorius* we have one of Corneille's finest plays. It is remarkable not only for its many splendid verses and for the nobility of its sentiment, but from the fact that not one of its characters lacks interest, a commendation not generally to be bestowed on its author's work. Of the last six plays we may say that perhaps only one of them, *Agésilas*, is almost wholly worthless. Not a few speeches of *Suréna* and of *Othon* are of a very high order. As to the poet's non-dramatic works, we have already spoken of his extremely interesting critical dissertations. His minor poems and poetical devotions are not likely to be read save from motives of duty or curiosity. The verse translation of à Kempis, indeed, which was in its day immensely popular (it passed through many editions), condemns itself.

**BIBLIOGRAPHY.**—The subject of the bibliography of Corneille was treated in the most exhaustive manner by M. E. Picot in his *Bibliographie Cornélienne* (Paris, 1875–1876). Less elaborate, but still ample information may be found in J. A. Taschereau's *Vie* and in M. Marty-Laveaux's edition of the *Works*. The individual plays were usually printed a year or two after their first appearance: but these dates have been subjected to confusion and to controversy, and it seems better to refer for them to the works quoted and to be quoted. The chief collected editions in the poet's lifetime were those of 1644, 1648, 1652, 1660 (with important corrections), 1664 and 1682, which gives the definitive text. In 1692 T. Corneille published a complete *Théâtre* in 5 vols. 12mo. Numerous editions appeared in the early part of the 18th century, that of 1740 (6 vols. 12mo, Amsterdam) containing the *Œuvres diverses* as well as the plays. Several editions are recorded between this and that of Voltaire (12 vols. 8vo; Geneva, 1764, 1776, 8 vols. 4to), whose *Commentaires* have often been reprinted separately. In the year IX. (1801) appeared an edition of the *Works* with Voltaire's commentary and criticisms thereon by Palissot (12 vols. 8vo, Paris). Since this the editions have been extremely numerous. Those chiefly to be remarked are the following. Lefèvre's (12 vols. 8vo, Paris, 1854), well printed and with a useful variorum commentary, lacks bibliographical information and is disfigured by hideous engravings. Of Taschereau's, in the *Bibliothèque élzévirienne*, only two volumes were published. Lahure's appeared in 5 vols. (1857–1862) and 7 vols. (1864–1866). The edition of Ch. Marty-Laveaux in Regnier's *Grands Écrivains de la France* (1862–1868), in 12 vols. 8vo, is still the standard. In appearance and careful editing it leaves nothing to desire, containing the entire works, a lexicon, full bibliographical information, and an album of illustrations of the poet's places of residence, his arms, some title-pages of his plays, facsimiles of his writings, &c. Nothing is wanting but variorum comments, which Lefèvre's edition supplies. Fontenelle's life of his uncle is the chief original authority on that subject, but Taschereau's *Histoire de la vie et des ouvrages de P. Corneille* (1st ed. 1829, 2nd in the *Bibl. élzévirienne*, 1855) is the standard work. Its information has been corrected and augmented in various later publications, but not materially. Of the exceedingly numerous writings relative to Corneille we may mention the *Recueil de dissertations sur plusieurs tragédies de Corneille et de Racine* of the abbé Granet (Paris, 1740), the criticisms already alluded to of Voltaire, La Harpe and Palissot, the well-known work of Guizot, first published as *Vie de Corneille* in 1813 and revised as *Corneille et son temps* in 1852, and the essays, repeated in his *Portraits*



*littéraires*, in *Port-Royal*, and in the *Nouveaux Lundis* of Sainte-Beuve. More recently, besides essays by MM. Brunetière, Faguet and Lemaitre and the part appurtenant of M. E. Rigal's work on 16th century drama in France, see Gustave Lanson's "Corneille" in the *Grands Écrivains français* (1898); F. Bouquet's *Points obscurs et nouveaux de la vie de Pierre Corneille* (1888); *Corneille inconnu*, by J. Levallois (1876); J. Lemaitre, *Corneille et la poétique d'Aristote* (1888); J. B. Segall, *Corneille and the Spanish Drama* (1902); and the recently discovered and printed *Fragments sur Pierre et Thomas Corneille* of Alfred de Vigny (1905). On the *Cid* quarrel E. H. Chardon's *Vie de Rotrou* (1884) bears mainly on a whole series of documents which appeared at Rouen in the proceedings of the *Société des bibliophiles normands* during the years 1891-1894. The best-known English criticism, that of Hallam in his *Literature of Europe*, is inadequate. The translations of separate plays are very numerous, but of the complete *Théâtre* only one version (into Italian) is recorded by the French editors. Fontenelle tells us that his uncle had translations of the *Cid* in every European tongue but Turkish and Slavonic, and M. Picot's book appraises us that the latter want, at any rate, is now supplied. Corneille has suffered less than some other writers from the attribution of spurious works. Besides a tragedy, *Sylla*, the chief piece thus assigned is *L'Occasion perdue recouverte*, a rather loose tale in verse. Internal evidence by no means fathers it on Corneille, and all external testimony is against it. It has never been included in Corneille's works. It is curious that a translation of Statius (*Thebaid*, bk. iii.), an author of whom Corneille was extremely fond, though known to have been written, printed and published, has entirely dropped out of sight. Three verses quoted by Ménage are all we possess. (G. SA.)

**CORNEILLE, THOMAS** (1625-1709), French dramatist, was born at Rouen on the 20th of August 1625, being nearly twenty years younger than his brother, the great Corneille. His skill in verse-making seems to have shown itself early, as at the age of fifteen he composed a piece in Latin which was represented by his fellow-pupils at the Jesuits' college of Rouen. His first French play, *Les Engagements du hasard*, was acted in 1647. *Le Feint Astrologue*, imitated from the Spanish, and imitated by Dryden, came next year. At his brother's death he succeeded to his vacant chair in the Academy. He then turned his attention to philology, producing a new edition of the *Remarques* of C. F. Vaugelas in 1687, and in 1694 a dictionary of technical terms, intended to supplement that of the Academy. A complete translation of Ovid's *Metamorphoses* (he had published six books with the *Heroic Epistles* some years previously) followed in 1697. In 1704 he lost his sight and was constituted a "veteran," a dignity which preserved to him the privileges, while it exempted him from the duties, of an academician. But he did not allow his misfortune to put a stop to his work, and in 1708 produced a large *Dictionnaire universel géographique et historique* in three volumes folio. This was his last labour. He died at Les Andelys on the 8th of December 1709, aged eighty-four. It has been the custom to speak of Thomas Corneille as of one who, but for the name he bore, would merit no notice. This is by no means the case; on the contrary, he is rather to be commiserated for his connexion with a brother who outshone him as he would have outshone almost any one. But the two were strongly attached to one another, and practically lived in common. Of his forty-two plays (this is the utmost number assigned to him) the last edition of his complete works contains only thirty-two, but he wrote several in conjunction with other authors. Two are usually reprinted as his masterpieces at the end of his brother's selected works. These are *Ariane* (1672) and the *Comte d'Essex*, in the former of which Rachel attained success. But of *Laodice*, *Camma*, *Stilico* and some other pieces, Pierre Corneille himself said that "he wished he had written them," and he was not wont to speak lightly. *Camma* (1661, on the same story as Tennyson's *Cup*) especially deserves notice. Thomas Corneille is in many ways remarkable in the literary gossip-history of his time. His *Timocrate* boasted of the longest run (80 nights) recorded of any play in the century. For *La Devineresse* he and his coadjutor de Visé (1638-1710, founder of the *Mercurie galant*, to which Thomas contributed) received above 6000 livres, the largest sum known to have been thus paid. Lastly, one of his pieces (*Le Baron des Fondrières*) contests the honour of being the first which was hissed off the stage.

There is a monograph, *Thomas Corneille, sa vie et ses ouvrages* (1892), by G. Reynier. See also the *Fragments inédits de critique sur Pierre et Thomas Corneille* of Alfred de Vigny, published in 1905. (G. SA.)

**CORNELIA** (2nd cent. B.C.), daughter of Scipio Africanus the Elder, mother of the Gracchi and of Sempronia, the wife of Scipio Africanus the Younger. On the death of her husband, refusing numerous offers of marriage, she devoted herself to the education of her twelve children. She was so devoted to her sons Tiberius and Gaius that it was even asserted that she was concerned in the death of her son-in-law Scipio, who by his achievements had eclipsed the fame of the Gracchi, and was said to have approved of the murder of Tiberius. When asked to show her jewels she presented her sons, and on her death a statue was erected to her memory inscribed, "Cornelia, the mother of the Gracchi." After the murder of her second son Gaius she retired to Misenum, where she devoted herself to Greek and Latin literature, and to the society of men of letters. She was a highly educated woman, and her letters were celebrated for their beauty of style. The genuineness of the two fragments of a letter from her to her son Gaius, printed in some editions of Cornelius Nepos, is disputed.

See L. Mercklin, *De Corneliae vita* (1844), of no great value; J. Sörgel, *Cornelia, die Mutter der Gracchen* (1868), a short popular sketch.

**CORNELIUS**, pope, was elected in 251 during the lull in the persecution of the emperor Decius. Two years afterwards, under the emperor Gallus, he was exiled to Centumcellae (Civita Vecchia), where he died. He was very intimate with St Cyprian, and is commemorated with him on the 16th of September, which is not, however, the anniversary of his death. He died in June 253.

**CORNELIUS, CARL AUGUST PETER** (1824-1874), German musician and poet, son of an actor at Wiesbaden, grandson of the engraver Ignaz Cornelius, and nephew of Cornelius the painter, was born at Mainz on the 24th of December 1824. In his childhood his bent was towards languages, but his musical gifts were carefully cultivated and he learned to sing and to play the violin. Cornelius the elder, anxious for his son to become an actor, himself taught the boy the elements of the art. These theatrical studies, however, were interrupted early by a visit paid by Peter Cornelius to England as second violin in the Mainz orchestra. On returning home young Cornelius made his stage debut as John Cook in *Kean*. But after two more appearances, as the lover in the comedy *Das war Ich* and as Perin in Moreto's *Donna Diana*, he practically abandoned the stage for music, his idea being to become a comic opera composer. In 1843 his father died. Hitherto Cornelius's musical studies had been unsystematic. Now opportunity served to remedy this, for his relative, Cornelius the painter, summoned him in 1844 to Berlin, and enabled him a year later to become a pupil of Siegfried Wilhelm Dehn (1799-1858), counterpoint and theory generally being worked at laboriously. After leaving Dehn, Cornelius proved his independence by writing a trio in A minor, a quartet in C, as well as two comic opera texts. In 1847 he returned to Dehn and immediately composed an enormous mass of music, including a second trio, 30 vocal canons, several sonatas, a Mass, a *Stabat Mater*; he also wrote a number of translations of old French poems, which are classics of their kind. In 1852 he first came in touch with Liszt, through his uncle's instrumentality. At Weimar, whither he went in 1852, he heard Berlioz's delightful *Benvenuto Cellini*, a work which ultimately exercised great influence over him. For the time, however, he devoted himself, on Liszt's advice, to further Church compositions, the influence of the Church on him at that time being so great that he applied, but vainly, for a place in a Jesuit college. Still his mind was bent on the production of a comic opera, but the composition was long delayed by the work of translating the prefaces for Liszt's symphonic poems and the texts of works by Berlioz and Rubinstein. Between October 1855 and September in the following year, Cornelius wrote the book of the *Barbier von Bagdad*, and on December 15, 1858, the opera was produced at Weimar under Liszt, and hissed off the stage. Thereupon Liszt resigned his post, and shortly afterwards Cornelius went to Vienna and Munich, and still later came very much under Wagner's influence. Cornelius's *Cid* was completed and produced at Weimar in 1865. For the last nine years of his life (1865-1874)

Cornelius was occupied with his opera *Guntöd* and other compositions, besides writing ably and abundantly on Wagner's music-dramas. In 1867 he became teacher of rhetoric and harmony at the Musikschule, Munich, and married Berthe Jung. He died on the 26th of October 1874. Not the least of Cornelius's many claims to fame was his remarkable versatility. Many of his original poems, as well as his translations from the French, rank high. Among his songs, special mention may be made of the lovely "Weihnachtslieder," and of the "Vätergruft," an unaccompanied vocal work for baritone solo and choir.

**CORNELIUS, PETER VON** (1784-1867), German painter, was born in Düsseldorf in 1784. His father, who was inspector of the Düsseldorf gallery, died in 1799, and the young Cornelius was stimulated to extraordinary exertions. In a letter to the Count Raczynski he says, "It fell to the lot of an elder brother and myself to watch over the interests of a numerous family. It was at this time that it was attempted to persuade my mother that it would be better for me to devote myself to the trade of a goldsmith than to continue to pursue painting—in the first place, in consequence of the time necessary to qualify me for the art, and in the next, because there were already so many painters. My dear mother, however, rejected all this advice, and I felt myself impelled onward by an uncontrollable enthusiasm, to which the confidence of my mother gave new strength, which was supported by the continual fear that I should be removed from the study of that art I loved so much." His earliest work of importance was the decoration of the choir of the church of St Quirinus at Neuss. At the age of twenty-six he produced his designs from *Faust*. On October 14, 1811, he arrived in Rome, where he soon became one of the most promising of that brotherhood of young German painters which included Overbeck, Schadow, Veit, Schnorr and Ludwig Vogel (1788-1879),—a fraternity (some of whom selected a ruinous convent for their home) who were banded together for resolute study and mutual criticism. Out of this association came the men who, though they were ridiculed at the time, were destined to found a new German school of art.

At Rome Cornelius participated, with other members of his fraternity, in the decoration of the Casa Bartoldi and the Villa Massimi, and while thus employed he was also engaged upon designs for the illustration of the *Nibelungenlied*. From Rome he was called to Düsseldorf to remodel the Academy, and to Munich by the then crown-prince of Bavaria, afterwards Louis I., to direct the decorations for the Glyptothek. Cornelius, however, soon found that attention to such widely separated duties was incompatible with the just performance of either, and most inconvenient to himself; eventually, therefore, he resigned his post at Düsseldorf to throw himself completely and thoroughly into those works for which he had been commissioned by the crown-prince. He therefore left Düsseldorf for Munich, where he was joined by those of his pupils who elected to follow and to assist him. At the death of Director Langer, 1824-1825, he became director of the Munich Academy.

The fresco decorations of the Ludwigskirche, which were for the most part designed and executed by Cornelius, are perhaps the most important mural works of modern times. The large fresco of the Last Judgment, over the high altar in that church, measures 62 ft. in height by 38 ft. in width. The frescoes of the Creator, the Nativity, and the Crucifixion in the same building are also upon a large scale. Amongst his other great works in Munich may be included his decorations in the Pinakothek and in the Glyptothek; those in the latter building, in the hall of the gods and the hall of the hero-myths, are perhaps the best known. About the year 1830-1840 he left Munich for Berlin to proceed with that series of cartoons, from the Apocalypse, for the frescoes for which he had been commissioned by Frederick William IV., and which were intended to decorate the Campo Santo or royal mausoleum. These were his final works.

Cornelius, as an oil painter, possessed but little technical skill, nor do his works exhibit any instinctive appreciation of colour. Even as a fresco painter his manipulative power was not great. And in critically examining the execution in colour of some of

his magnificent designs, one cannot help feeling that he was, in this respect, unable to do them full justice. Cornelius and his associates endeavoured to follow in their works the spirit of the Italian painters. But the Italian strain is to a considerable extent modified by the Dürer heritage. This Dürer influence is manifest in a tendency to overcrowding in composition, in a degree of attenuation in the proportions of, and a poverty of contour in, the nude figure, and also in a leaning to the selection of Gothic forms for draperies. These peculiarities are even noticeable in Cornelius's principal work of the "Last Judgment," in the Ludwigskirche in Munich. The attenuation and want of flexibility of contour in the nude are perhaps most conspicuous in his frescoes of classical subjects in the Glyptothek, especially in that representing the contention for the body of Patroclus. But notwithstanding these peculiarities there is always in his works a grandeur and nobleness of conception, as all must acknowledge who have inspected his designs for the Ludwigskirche, for the Campo Santo, &c. If he were not dexterous in the handling of the brush, he could conceive and design a subject with masterly purpose. If he had an imperfect eye for colour, in the Venetian, the Flemish, or the English sense, he had vast mental foresight in directing the German school of painting; and his favourite motto of *Deutschland über alles* indicates the direction and the strength of his patriotism. Karl Hermann was one of Cornelius's earliest and most esteemed scholars, a man of simple and fervent nature, painstaking to the utmost, a very type of the finest German student nature; Kaulbach and Adam Eberle were also amongst his scholars. Every public edifice in Munich and other German cities which were embellished with frescoes, became, as in Italy, a school of art of the very best kind; for the decoration of a public building begets a practical knowledge of design. The development of this institution of scholarship in Munich was a work of time. The cartoons for the Glyptothek were all by Cornelius's own hand. In the Pinakothek his sketches and small drawings sufficed; but in the Ludwigskirche the invention even of some of the subjects was entrusted to his scholar Hermann.

To comprehend and appreciate thoroughly the magnitude of the work which Cornelius accomplished for Germany, we must remember that at the beginning of the 19th century Germany had no national school of art. Germany was in painting and sculpture behind all the rest of Europe. Yet in less than half a century Cornelius founded a great school, revived mural painting, and turned the gaze of the art world towards Munich. The German revival of mural painting had its effect upon England, as well as upon other European nations, and led to the famous cartoon competitions held in Westminster Hall, and ultimately to the partial decoration of the Houses of Parliament. When the latter work was in contemplation, Cornelius, in response to invitations, visited England (November 1841). His opinion was in every way favourable to the carrying out of the project, and even in respect of the durability of fresco in the climate of England. Cornelius, in his teaching, always inculcated a close and rigorous study of nature, but he understood by the study of nature something more than what is ordinarily implied by that expression, something more than constantly making studies from life; he meant the study of nature with an inquiring and scientific spirit. "Study nature," was the advice he once gave, "in order that you may become acquainted with its *essential* forms."

The personal appearance of Cornelius could not but convey to those who were fortunate enough to come into contact with him the impression that he was a man of an energetic, firm and resolute nature. He was below the middle height and squarely built. There was evidence of power about his broad and overhanging brow, in his eagle eyes and firmly gripped attenuated lips, which no one with the least discernment could misinterpret. Yet there was a sense of humour and a geniality which drew men towards him; and towards those young artists who sought his teaching and his criticism he always exhibited a calm patience.

See Förster, *Peter von Cornelius* (Berlin, 1874). (W. C. T.)

**CORNELL UNIVERSITY**, one of the largest of American institutions of higher education, situated at Ithaca, New York. Its campus is finely situated on a hill above the main part of the city; it lies between Fall Creek and Cascadilla Creek (each of which has cut a deep gorge), and commands a beautiful view of the valley and of Lake Cayuga. The university is co-educational (since 1872), and comprises the graduate school, with 306 students in 1909; the college of arts and sciences (902 students); the college of law (225 students), established in 1887; the medical college (217 students, of whom 29 were taking freshman or sophomore work in Ithaca, where all women entering the college must pursue the first two years of work)—this college was established in 1898 by the gift of Oliver Hazard Payne, and has buildings opposite Bellevue hospital on First Avenue and 28th Street, New York city; the New York state veterinary college (94 students), established by the state legislature in 1894; the New York state college of agriculture (413 students), established as such by the state legislature in 1904,—the teaching of agriculture had from the beginning been an important part of the university's work,—with an agricultural experiment station, established in 1887 by the Federal government; the college of architecture (133 students); the college of civil engineering (569 students); and the Sibley College of mechanical engineering and mechanic arts (1163 students), named in honour of Hiram Sibley (1807-1888), a banker of Rochester, N.Y., who gave \$180,000 for its endowment and equipment and whose son Hiram W. Sibley gave \$130,000 to the college. A state college of forestry was established in connexion with the university in 1898, but was discontinued after several years. The total enrolment of regular students in 1909 was 3980; in addition, 841 students were enrolled in the 1908 summer session (which is especially for teachers) and 364 in the "short winter course in agriculture" in 1909. Nearly all the states and territories of the United States and thirty-two foreign countries were represented—e.g. there were 33 students from China, 12 from the Argentine Republic, 6 from India, 10 from Japan, 10 from Mexico, 5 from Peru, &c.

In the W. central part of the campus is the university library building, which, with an endowment (1891) of \$300,000 for the purchase of books and periodicals, was the gift of Henry Williams Sage (1814-1897), second president of the board of trustees; in 1906 it received an additional endowment fund of about \$500,000 by the bequest of Prof. Willard Fiske. The building, of light grey Ohio sandstone, houses the general library (300,050 volumes in 1909), the seminary and department libraries (7284 volumes), and the forestry library (1007 volumes). Among the special collections of the general library are the classical library of Charles Anthon, the philological library of Franz Bopp, the Goldwin Smith library (1869), the White architectural and historical libraries, the Spinoza collection presented by Andrew D. White (1894), the library of Jared Sparks, the Samuel J. May collection of works on the history of slavery, the Zarncke library, especially rich in Germanic philology and literature, the Eugene Schuyler collection of Slavic folk-lore, literature and history, the Willard Fiske Rhaeto-Romanic, Icelandic, Dante and Petrarch collections, and the Herbert H. Smith collection of works on Latin America (in addition there are college and department libraries—that of the college of law numbers 38,735 volumes—bringing the total to 353,638 bound volumes in 1909). Among the other buildings are: Morse Hall, Franklin Hall, Sibley College, Lincoln Hall (housing the college of civil engineering), Goldwin Smith Hall (for language and history), Stimson Hall (given by Dean Sage to the medical college), Boardman Hall (housing the college of law), Morrill Hall (containing the psychological laboratory), McGraw Hall and White Hall—these, with the library, forming the quadrangle; S. of the quadrangle, Sage chapel (with beautiful interior decorations), Barnes Hall (the home of the Cornell University Christian Association), Sage College (a dormitory for women), and the armoury and gymnasium; E. of the quadrangle, the Rockefeller Hall of Physics (1906) and the New York State College of Agriculture (completed in 1907); and S.E. of the quadrangle the New York State

Veterinary College and the Fuertes Observatory. The university is well-equipped with laboratories, the psychological laboratory, the laboratories of Sibley college and the hydraulic laboratory of the college of civil engineering being especially noteworthy; the last is on Fall Creek, where a curved concrete masonry dam has been built, forming Beebe Lake. East of the campus is the university playground and athletic field (55 acres), built with funds raised from the alumni. Cayuga Lake furnishes opportunity for rowing, and the Cornell crews are famous. During their first two years all undergraduates, unless properly excused, must take a prescribed amount of physical exercise. Normally the first year's exercise for male students is military drill under the direction of a U.S. army officer detailed as commandant.

The reputation of the university is particularly high in mechanical engineering; Sibley college was built up primarily under Prof. Robert Henry Thurston (1839-1903), a well-known engineer, its director in 1885-1903. The college includes the following departments: machine design and construction, experimental engineering, power engineering, and electrical engineering. The "Susan Linn Sage School of Philosophy," so called since the gift (1891) of \$200,000 from Henry W. Sage in memory of his wife, issues *The Philosophical Review* and *Cornell Studies in Philosophy*, and is well known for the psychological laboratory investigations under Prof. E. B. Titchener (b. 1867). Equally well known are the college of agriculture under Prof. Liberty Hyde Bailey (b. 1858); the "Cornell School" of Latin grammarians, led first by Prof. W. G. Hale and then by Prof. C. E. Bennett; the department of entomology under Prof. J. H. Comstock (b. 1849), the department of physics under Prof. E. L. Nichols (b. 1854), and other departments. The university publishes *Cornell Studies in Classical Philology*, the *Journal of Physical Chemistry*, the *Physical Review*, *Publications of Cornell University Medical College*, various publications of the college of agriculture, and *Studies in History and Political Science* (of "The President White School of History and Political Science"). Among the student publications are *The Cornell Era* (1868, weekly), *The Cornell Daily Sun* (1880), *The Sibley Journal of Engineering* (1882), *The Cornell Magazine*, a literary monthly, and *The Cornell Widow* (1892), a comic tri-weekly. The regular annual tuition fee is \$100, but in medicine, in architecture, and in civil and mechanical engineering it is \$150. In the veterinary and agricultural colleges there are no tuition fees for residents of New York state. There are 150 free-tuition state scholarships (one for each of the state assembly districts), and, in addition, there are 36 undergraduate university scholarships (annual value, \$200) tenable for two years, and 23 fellowships and 17 graduate scholarships (annual value, \$300-600 each). In the college of arts and sciences the elective system, with certain restrictions, obtains.

The university has always been absolutely non-sectarian; its charter prescribes that "persons of every religious denomination, or of no religious denomination, shall be equally eligible to all offices and appointments" and that "at no time shall a majority of the board (of trustees) be of one religious sect or of no religious sect." There is, however, an active Christian Association and religious services—provided for by the Dean Sage Preachership Endowment—are conducted in Sage chapel by eminent clergymen representing various sects and denominations.

The affairs of Cornell university are under the administration of a board which must consist of forty trustees, of whom ten are elected by the alumni. The following are *ex officio* members of the board: the president of the university, the librarian of the Cornell Library (in Ithaca), the governor and the lieutenant-governor of the state, the speaker of the state assembly, the state commissioners of education and of agriculture, and the president of the state agricultural society. The internal government is in the hands of the university faculty (which consists of the president, the professors and the assistant professors, and has jurisdiction over matters concerning the university as a whole), and of the special faculties, which consist of the president, the professors, the assistant professors, and the instructors of

the several colleges, and which have jurisdiction over distinctively collegiate matters.

In 1909 the invested funds of the university amounted to about \$8,594,300, yielding an annual income of about \$428,800; the income from state and nation was about \$232,050, and from tuition fees about \$336,100; the campus and buildings were valued at about \$4,263,400, and the Library, collections, apparatus, &c. at about \$1,826,100.

The university was incorporated by the legislature of New York state on the 27th of April 1865, and was named in honour of Ezra Cornell,<sup>1</sup> its principal benefactor. In 1864 Cornell, at the suggestion of Andrew D. White, his fellow member of the state senate, decided to found a university of a new type—which should be broad and liberal in its scope, should be absolutely non-sectarian, and which should recognize and meet the growing need for practical training and adequate instruction in the sciences as well as in the humanities. He offered to the state as an endowment \$500,000 (with 200 acres of land) on condition that the state add to this fund the proceeds of the sales of public lands granted to it by the Morrill Act of 1862 for “the endowment, support and maintenance of at least one college, where the leading object shall be . . . to teach such branches of learning as are related to agriculture and the mechanic arts . . .” The charter provided that “such other branches of science and knowledge may be embraced in the plan of instruction and investigation pertaining to the university as the trustees may deem useful and proper,” and Ezra Cornell expressed his own ideal in the oft-quoted words: “I would found an institution where any person can find instruction in any study.” The opposition to Cornell’s plan was bitter, especially on the part of denominational schools and press, but incorporation was secured, and the trustees first met on the 5th of September 1865. Andrew D. White was elected president and the entire educational scheme was left to him. Dr White’s ideals in part were: a closer union between the advanced and the general educational system of the state; liberal instruction of the industrial classes; increased stress on technical instruction; unsectarian control; “a course in history and political and social science adapted to the practical needs of men worthily ambitious in public affairs”; a more thorough study of modern languages and literatures, especially English; the “steady effort to abolish monastic government and pedantic instruction”; the elective system of studies; and the stimulus of non-resident lecturers. On the 7th of October 1868 the Cornell University opened with some confusion due to the condition of the campus, and to the presence of 412 would-be pupils, many of whom expected to “work their way through.” The brilliance of the faculty and especially of its non-resident members (including J. R. Lowell, Louis Agassiz, G. W. Curtis, Bayard Taylor, Theodore D. Dwight, and Goldwin Smith, who was a resident professor in 1866–1869), was to a degree over-shadowed during the fifteen years 1868–1882 by financial difficulties. But Ezra Cornell himself paid many salaries during early years, and provided much valuable equipment solely at his own expense; and because the state’s land scrip was selling too low to secure an adequate endowment for the University, in 1866 he bought the land scrip yet unsold

<sup>1</sup> Ezra Cornell (1807–1874) was born in Westchester county, New York, on the 11th of January 1807. His parents were Quakers from Massachusetts. He received a scanty education; worked as a carpenter in Syracuse and as a machinist in Ithaca; became interested (about 1842) in the development of the electric telegraph; and after unsuccessful or over-expensive attempts to ground the telegraph wires in 1844 solved the difficulty by stringing them on poles. He organized many telegraph construction companies, was one of the founders of the Western Union Telegraph Company, and accumulated a large fortune. He was a delegate to the first national convention of the Republican party (1856) and was a member of the New York assembly in 1862–1863 and of the state senate in 1864–1867. He founded a public library (dedicated in 1866) in Ithaca, and died there on the 9th of December 1874. Consult Alonzo B. Cornell, *True and Firm: A Biography of Ezra Cornell* (New York, 1884).

<sup>2</sup> New York’s share amounted to 990,000 acres. The Morrill Act prescribed that the proceeds from the sale of this land should not be used for the purchase, erection or maintenance of any building or buildings.

(819,920 acres)<sup>2</sup> by the state at the rate of sixty cents an acre on the understanding that all profits, in excess of the purchase money, should constitute a separate endowment fund to which the restrictions in the Morrill Act should not apply; and in 1866–1867 he “located” 512,000 acres in Wisconsin, Minnesota, and Kansas. In November 1874 he transferred these lands, which had cost him \$576,953 more than he had received from them, to the university. This actual deficit on the lands owned by the university steadily increased up to 1881, when, after the trustees had refused (in 1880) an offer of \$1,250,000 for 275,000 acres of pine lands, they sold about 140,600 acres for \$2,319,296; ultimately 401,296 acres of the land turned over to the university by Cornell were sold, bringing a net return of about \$4,800,000. The university was put on a sound financial footing; the number of students, less in 1881–1882 than in 1868 at the opening of the university, again increased, so that it was 585 in 1884–1885, and 2120 in 1897–1898. The presidents of the university have been: Andrew Dickson White, 1865–1885; Charles Kendall Adams, 1885–1892; and Jacob Gould Schurman.

**CORNET**, a word having two distinct significations and two etymological histories, both, however, ultimately referable to the same Latin origin:—

1. (Fr. *cornette*, dim. of *corne*, from Lat. *cornu*, a horn), a small standard, formerly carried by a troop of cavalry, and similar to the pennon in form, narrowing gradually to a point. The term was then applied to the body of cavalry which carried a cornet. In this sense it is used in the military literature of the 16th century and, less frequently, in that of the 17th. Before the close of the 16th century, however, the word had also come to mean a junior officer of a troop of cavalry who, like the “ensign” of foot, carried the colour. The spelling “coronet” occurs in the 16th century, and has perhaps contributed to obscure the derivation of “colonel” or “coronel.” The rank of “cornet” remained in the British cavalry until the general adoption of the term “second lieutenant.” In the Boer republics “field-cornets” were local subordinate officers of the commando (*q.v.*), the unit of the military forces. Elected for three years by the wards into which the electoral districts were divided, they had administrative as well as military duties, and acted as magistrates, inspectors of natives and registration officers for their respective wards. In 1907, the “field-cornet” system was re-established in the Transvaal; the new duties of the “field-cornets” are those performed by assistant magistrates, viz. petty jurisdiction, registration of voters, births and deaths, the carrying out of regulations as to animal diseases, and maintenance of roads. The “field-cornets” are appointed by government for three years.

2. (Fr. *cornet*, Ital. *cornetto*, Med. Lat. *cornetum*, a hughle, from Lat. *cornu*, a horn), in music, the name of two varieties of wind instruments (see below), and also of certain stops of the organ. The great organ “solo cornet” was a mixture or compound stop, having either 5, 4, or 3 ranges of pipes; occasionally it was placed on a separate soundboard, when it was known as a “mounted cornet.” The “echo cornet” was a similar stop, but softer and enclosed in a box. In German and Dutch organs the term cornet is sometimes applied to a pedal reed stop.

(a) CORNET or CORNETT (Fr. *cornet*, *cornet à bouquin*; Ger. *Zinck*, *Zincken*; Ital. *cornetto*) is the name given to a family of wood wind instruments, now obsolete, having a cup-shaped mouthpiece and a conical bore without a bell, and differing entirely from the modern cornet à pistons. The old cornets were of two kinds, the straight and the curved, characterized by radical differences in construction. There were two very different kinds of straight cornets (Ger. *gerader Zinck*, Ital. *cornetto diretto* or *recto*), the one most commonly used having a detachable cup-shaped mouthpiece similar to that of the trumpet, while the other was made to all appearance without mouthpiece, there being not even a moulded rim at the end of the tube to

<sup>3</sup> He had previously—in 1865—bought scrip for 100,000 acres for \$50,000, on the understanding that all profits which might accrue from the sale of the land should be paid to the university.

break the rigid straight line. Examination of the tube, however, reveals the secret of the characteristic sweet tone of this latter kind of cornet; unsuspected inside the top of the tube is cut out of the thickness of the wood a mouthpiece, not cup-shaped, but like a funnel similar to that of the French horn, which merges gradually into the bore of the instrument. This mode of construction, together with the narrower bore adopted, greatly influenced the timbre of the instrument, whose softer tone was thus due mainly to the substitution of the funnel for the sharp angle of incidence at the bottom of the cup mouthpiece known as the throat (see MOUTHPIECE), where it communicates with the tube. It is this sharp angle, which in the other cornets with detachable mouthpiece, causes the column of air to break, producing a shrill quality of tone, while the wider bore and slightly rough walls of the tube account for the harshness. In Germany the sweet-toned cornet was known as *stiller* or *sansier Zinck*, and in Italy as *cornetto muto* (fig. 1), while in France the instruments with detachable mouthpiece were distinguished

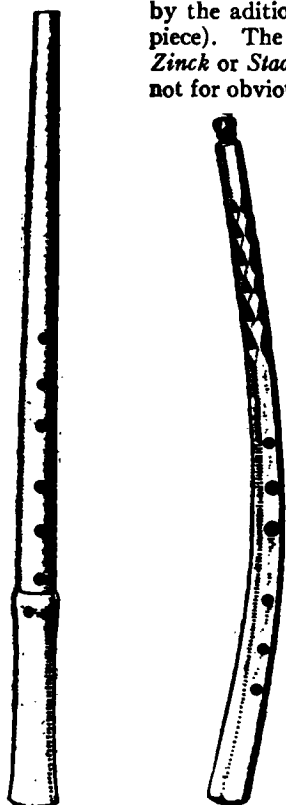

From Capt. C. R. Day's *Descriptive Catalogue of Musical Instruments*, by permission of Messrs. Eyre & Spottiswoode.

FIG. 1.—Cornetto Muto. FIG. 2.—Cornetto Curvo.

by the addition of *à bouquin* (=with mouthpiece). The curved cornet (Ger. *krummer Zinck* or *Stadtkalb*; Ital. *cornetto curvo*) could not for obvious reasons have the bore pierced through a single piece of wood; the channel for the vibrating column of air was, therefore, hollowed out of two pieces of wood, the diameter increasing from the mouthpiece to the lower end. The two pieces of wood thus prepared were joined together with glue and covered with leather, the outer surface of the tube being finished off in octagonal shape. The separate mouthpiece, made indifferently of wood, horn, ivory or metal,<sup>1</sup> analogous to that of the trumpet, was distinctly cup-shaped and fixed by a tenon to the upper extremity of the pipe. The primitive instrument was an animal's horn.

Pipes of such short length give only, besides the first or fundamental, the second and sometimes the third note of the harmonic series. Thus a pipe that has for its fundamental A will, if the pressure of breath and tension of the lips be steadily increased, give the octave A and the twelfth E. In order to connect the first and second harmonics diatonically, the length of the pipe was progressively shortened by boring lateral holes through the tube for the fingers to cover. The successive opening of these holes furnished the instrumentalist with the different intervals of the scale, six holes sufficing for this purpose:



The fundamental was thus connected with its octave by all the degrees of a diatonic scale, which became chromatic by the help of cross-fingering and the greater or less tension of the lips stretched as vibrating reeds across the opening of the mouthpiece. This increased compass of twenty-seven notes obtained

<sup>1</sup> See Marin Mersenne, *L'Harmonie universelle* (Paris, 1636-1637), bk. v., pp. 273-274.

by cross-fingering is very clearly shown in a table by Eisel.<sup>2</sup> The fingering was completed by a seventh hole, which had for its object the production of the octave without the necessity of closing all the holes in order to produce the second note of the harmonic series. The first complete octave, thus obtained by a succession of fundamental notes, was easily octaved by a stronger pressure of breath and tension of the lips across the mouthpiece, and thus the ordinary limits of the compass of a *Zinck* or cornet could be extended to a fifteenth. Whether straight or curved it was pierced laterally with seven holes, six through the front, and the seventh, that nearest the mouthpiece, through the back. The first three holes were usually covered with the third, second and first fingers of the right hand, the next four with the third, second and first fingers and the thumb of the left hand. But some instrumentalists inverted the position of the hands. Virdung<sup>3</sup> shows, besides the *cornetto recto*, a kind of *Zinck* made of an animal's horn with only four holes, three in the front of the pipe and one at the back. Such an instrument as this had naturally a very limited compass, since these four holes only sufficed to produce the intermediate notes between the second and third proper tones of the harmonic scale, the lower octave comprised between the first and second remaining incomplete; by overblowing, however, the next octave would be obtained in addition.

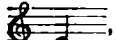
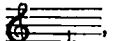
At the beginning of the 17th century Praetorius<sup>4</sup> represents the *Zincken* as a complete family comprising: (1) the little *Zinck* with the lowest note , (2) the ordinary *Zinck* with the lowest note , (3) the great *Zinck*, *cornon* or *corno torto*, a great

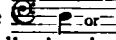
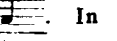
cornet in the shape of an  with the lowest note . In France<sup>5</sup> the family was composed of the following instruments:

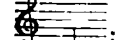
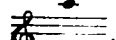
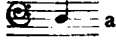
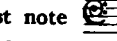
- (1) The *'dessus* or treble cornet with the lowest note 
- (2) the *haute-contre* or alto cornet with the lowest note 
- (3) the *taille* or tenor cornet with the lowest note  and the *basse* or bass or *pédalle*<sup>6</sup> cornet with the lowest note 

The cornets of the lowest pitch were sometimes furnished with an open key which, when closed, lengthened the tube and extended the compass downwards by a note. Mersenne figures a *cornon* with a key.

During the middle ages these instruments were in such favour that an important part was given to them in all instrumental combinations. At Dresden,<sup>7</sup> between 1647 and 1651, the Kapelle of the electoral prince of Saxony included two cornets, the bass being supplied by the trombone. Monteverde introduced two cornets in the 3rd and 4th acts of his *Orfeo* (1607). In France the charges for the *Chapelle-Musique* of the kings of France for the year 1619 contain two entries of the sum of 450 *livres tournois*, salary paid to one Marcel Cayty, *joueur de cornet*, a post held by him from 1604 until at least 1631, when another cornet player, Jean Daneau, is also mentioned.<sup>8</sup>

In Germany in the 17th and 18th centuries, *Zincken* were used with trombones in the churches to accompany the chorales. There are examples of this use of the instrument in the sacred cantatas of J. S. Bach, where the cornet is added to the upper voice parts to strengthen them. Johann Mattheson, conductor of the opera at

<sup>2</sup> See Eisel's (Anon.) *Musicus Abrodidaxros, oder der sich selbst informirende Musicus* (Erfurt, 1738), p. 93 and table vi.

<sup>3</sup> Sebastian Virdung, *Musica getuschit und ausgezogen* (Basel, 1511).

<sup>4</sup> Michael Praetorius, *Syntag. Music.*, vol. ii. *De Organographia* (Wolfenbüttel, 1618), pp. 25 and 41, pls. 8 and 13.

<sup>5</sup> See Mersenne, *loc. cit.*

<sup>6</sup> See Ad. MS. 30342, Brit. Museum, fol. 145. A tract in French containing pen and ink sketches of musical instruments, which dates from the 17th or perhaps the 18th century, and was formerly in the possession of the Jesuit college in Paris. Here the *pédalle* is the bass pommer, or *hautbois*, and the sackbut is indicated as second bass or *basse-contre*. As also in Mersenne, the cornets are curved.

<sup>7</sup> See Moritz Fürstenau, *Geschichte der Musik und des Theaters am Hofe zu Dresden* (Dresden, 1861-1862), p. 28.

<sup>8</sup> See Michel Brenet, "Deux comptes de la Chapelle Musique des rois de France," *Sammelband der Intern. Mus. Ges.*, vi. 1 (Leipzig, 1904), pp. 20, 21, 29; and *Archives nationales* (Paris), Z. Ia. 486.



Hamburg, writing on the orchestra in 1713<sup>1</sup> gives a description of the *Zinck* as a member of the orchestra, but in 1739,<sup>2</sup> in his work on the perfect conductor, he deplors the decrease of its popularity in church music, from which it seems to be banished as useless, Gluck was the last composer of importance who scored for the cornet, as for instance in *Orfeo*, in *Paride ed Elena*, in *Alceste* and in *Armide*, &c. The great vogue of the curved cornet is not to be accounted for by its musical qualities, for it had a hard, hoarse, piercing sound, and it failed utterly in truth of intonation; these natural defects, moreover, could only be modified with great difficulty. Mersenne's eulogium of the *dessus*, then more employed than the other cornets, can only be appreciated at its full value if we look upon the art of cornet playing as a lost art. "The *dessus*," he says, "was used in the vocal concerts and to make the treble with the organ, which is ravishing when one knows how to play it to perfection like the *Sieur Guiclet*;" and again further on, "the character of its tone resembles the brilliance of a sunbeam piercing the darkness, when it is heard among the voices in churches, cathedrals or chapels."<sup>3</sup> Mersenne further observes that the serpent is the true bass of the cornet, that one without the other is like body without soul. A drawing in pen and ink of a curved cornet is given by Randle Holme in his *Academy of Armoury* (1688);<sup>4</sup> and at the end of the description of the instrument he adds, "It is a delicate pleasant wind musick, if well played and humoured." Giovanni Maria Artusi<sup>5</sup> of Bologna, writing at the end of the 16th century, devotes much space to the cornet, explaining in detail the three kinds of tonguing used with the instrument. By tonguing is understood a method of articulation into the mouthpiece of flute, cornet à pistons or trumpet, of certain syllables which add brilliance to the tone. Artusi advocates (1) for the guttural effect, *ler, ler, ler, der, ler, der, ler; ter, ler, ter; ler, ter, ler*; (2) for the tongue effect, *tere, tere, tere*; (3) for the dental effect, *teche, teche, teche*, used by those who wish to strike terror into the hearts of the hearers—an effect, however, which offends the ear. A clue to the popularity of the instrument during the middle ages may perhaps be found in Artusi's remark that this instrument is the most apt in imitating the human voice, but that it is very difficult and fatiguing to play; the musician, he adds elsewhere, should adopt an instrument to imitate the voice as much as possible, such as the cornetto and the trombone. He mentions two players in Venice, Il Cavaliero del Cornetto and M. Girolamo da Udine, who excelled in the art of playing the cornet.

Being derived from the horn of an animal through which lateral holes had been pierced, the curved cornet was probably the earlier, and when the instrument came to be copied in metal and in wood the straight cornet was the result of an attempt to simplify the construction. The evolution probably took place in Asia Minor, where tubes with conical bore were the rule, and the instrument was thence introduced into Europe. A straight *Zinck*, having a grotesque animal's head at the bell-end, and six holes visible, is pictured in a miniature of the 11th century.<sup>6</sup> What appears to be precisely the same kind of instrument, although differing widely in reality, the chaunter being reed-blown, is to be found in illuminated MSS. as the chaunter of the bagpipe, as for example in a royal roll of Henry III. at the British Museum,<sup>7</sup> where it occurs twice played by a man on stilts. The grotesque was probably added to the chaunter in imitation of that on the straight *Zinck*. Two *stille Zincken* or *cornetti muti* are among the musical instruments represented in the triumphal procession of the emperor Maximilian I.<sup>8</sup> (d. 1519), designed at his command by H. Burgmair under the superintendence of Albrecht Dürer.

(b) CORNET À PISTONS, CORNET, CORNOPEAN (Fr. *cornet à pistons*; Ger. *Cornett*; Ital. *cornetto*), are the names of a modern brass wind instrument of the same pitch as the trumpet. Being a transformation of the old post-horn, the cornet should have a conical bore of wide diameter in proportion to the length of tube, but in practice usually only a small portion of the tube is conical, *i.e.* from the mouthpiece to the slide of the first valve and from the slide of the third valve to the bell. The tube of the cornet is doubled round upon itself. The cup-shaped mouthpiece is larger than that of the trumpet; the shape of the cup in conjunction with the length of the tube and the proportions

<sup>1</sup> *Das neu-eröffnete Orchester* (Hamburg, 1713), p. 253.

<sup>2</sup> *Der vollkommene Kapellmeister* (Hamburg, 1739).

<sup>3</sup> See Mersenne, *op. cit.*, bk. v., p. 274.

<sup>4</sup> Part of book iii. in MS. Harleian, 2034, fol. 207b. Brit. Museum.

<sup>5</sup> *Delle imperfettioni della moderna musica* (Venice, 1600), pp. 4, 5, 6 and 12b.

<sup>6</sup> Gräfl. Schönborn Bibl. Pommersfelden, Cod. 2776, reproduced in E. Buhle's *Die musikalischen Instrumente in den Miniatur-Handschriften des Mittelalters*, part i. (Leipzig, 1903) pl. 6 and p. 24, where other references will be found.

<sup>7</sup> Royal Roll, 14 B. v. 13th century. See also Augustus Hughes-Hughes, *Catalogue of MS. Music in the British Museum*, part iii.

<sup>8</sup> See "Triumphzug des Kaisers Maximilians I.," *Beilage zum 1sten Bd. d. Jahrbuch der Samml. des Allerhöchsten Kaiserhauses* (Vienna, 1883), part i. p. 26, and letterpress, Bd. i. pp. 154-181.

of the bore determines the timbre of the instrument. The outline of the bottom of the cup, where it communicates with the bore, is of the greatest importance.<sup>9</sup> If, as in the trumpet, it presents angles against which the column of air breaks, it produces a brilliant tone quality. In the cornet mouthpiece there are no angles at the bottom of the cup, which curves into the bore; hence the cornet's loose, coarse quality of tone. The sound is produced by stretching the lips across the mouthpiece, and making them act as double reeds, set in vibration by the breath. There are no fixed notes on the cornet as in instruments with lateral holes, or with keys; the musical scale is obtained by means of the power the performer possesses—once he has learned how to use it—of producing the notes of the harmonic series by overblowing, *i.e.* by varying the tension of the lips and the pressure of breath. In the cornet this series is short, comprising only the harmonics from the 2nd to the 8th:

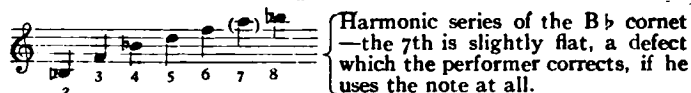

The intermediate notes completing the chromatic scale are obtained by means of three pistons which, on being depressed, open valves leading into supplementary wind-ways, which lengthen the original tube. The pitch of the instrument is thus lowered respectively one tone, half a tone, and one tone and a half. The action of the piston temporarily changes the key of the instrument and with it the notes of the harmonic series. Before a performer, therefore, can play a note he must know in which harmonic series it is best obtained and use the proper piston in conjunction with the requisite lip tension. By means of the pistons the compass of the cornet is thus extended from

Real sounds for the cornet in C.

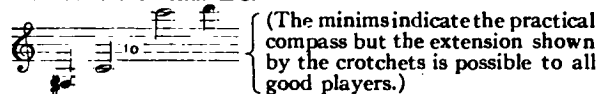

The treble clef is used in notation, and in England the music for the cornet is usually written as sounded, but most French and German composers score for it as for a transposing instrument; for example, the music for the Bb cornet is written in a key one tone higher than that of the composition.

The *timbre* of the cornet lies somewhere between that of the horn and the trumpet, having the blaring, penetrating quality of the latter without its brilliant noble sonorousness. The great favour with which the cornet meets is due to the facility with which it speaks, to the little fatigue it causes, and to the simplicity of its mechanism. We must, however, regret from the point of view of art that its success has been so great, and that it has ended in usurping in brass bands the place of the bugles, the tone colour of which is infinitely preferable as a foundation for an ensemble composed entirely of brass instruments. Even the symphonic orchestra has not been secure from its intrusion, and the growing tendency in some orchestras, notably in France, to allow the cornet to supersede the trumpet, to the great detriment of tone colour, is to be deplored. The cornet used in a rich orchestral harmony is of value for completing the chords of trumpets, or to undertake diatonic and chromatic passages which on account of their rapidity cannot easily be fingered by trombones or horns. The technical possibilities of the instrument are very great, almost unrivalled in the brass wind:—notes sustained, crescendo or diminuendo; diatonic and chromatic scale and arpeggio passages; leaps, shakes, and in fact all kinds of musical figures in any key, can be played with great facility on the three-valved cornet. Double tonguing is also practicable, the articulation with the tongue of the syllables *ti-ke* for double, and of *ti-ke-ti* for triple time producing a striking staccato effect.

The cornet was evolved in Germany, at the beginning of the 19th century, from the post-horn, by the application of the

<sup>9</sup> See Victor Mahillon, *Éléments d'acoustique musicale et instrumentale* (Brussels, 1874), pp. 96, 97, &c., with diagrams, and Friedrich Zamminer, *Die Musik und die musikalischen Instrumente*, &c. (Giessen, 1855), p. 310, &c., with diagrams.

newly invented pistons of Staelzel and Blümel patented in 1815. It was introduced into Great Britain and France about 1830. There were at first only two pistons—for a whole tone and for a half tone—from which there naturally resulted gaps in the chromatic scale of the instrument. The use of a combination of pistons (see BOMBARDON and VALVES) fails to give acoustically correct intervals, because the length of tubing thus thrown open is not of the theoretical length required to produce the interval. A tube about 4 ft. long, such as that of the B $\flat$  cornet, needs an additional length of about 3 in. to lower the pitch a semitone; but, if this cornet has already been lowered one tone to the key of A $\flat$ , the length of tube has increased some 6 in., and the 3-in. semitone piston no longer adds sufficient tubing to

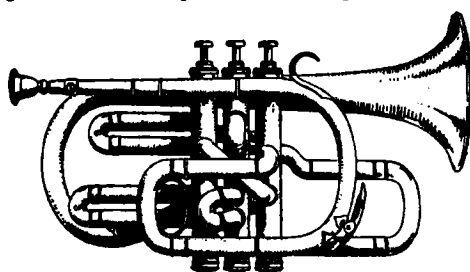

FIG. 3.—B $\flat$  Cornet with enharmonic valves (Besson & Co.).

produce a semitone of correct intonation. To the performer falls the task of concealing the shortcomings of his instrument, and he therefore corrects the intonation by varying the lip tension. At first the cornet was supplied with a great many crooks for A, A $\flat$ , G, F, E, E $\flat$  and D, but from the explanation but now given, it will be readily understood that they were found unpractical for valve instruments, and all but the first two mentioned have been abandoned. The history of the cornet is a record of the endeavours of successive musical instrument makers to overcome this inherent defect in construction. The most ingenious and successful of these improvements are the following:—(1) The *six-valve-independent system*<sup>1</sup> of Adolphe Sax, designed about 1850, by which a separate valve was used for each position, thus obviating the necessity of using combinations of pistons. This theoretically perfect system unfortunately introduced great difficulties in practice, the valves being made *ascending* instead of *descending*, and each piston cutting off a definite length of wind-way from the open tube, instead of adding to it. The system was eventually abandoned. (2) The *Besson*

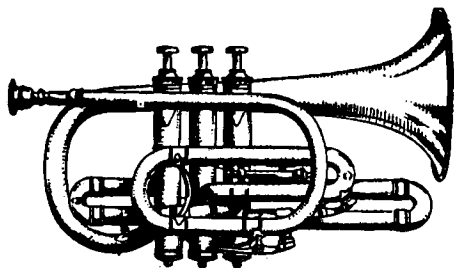

FIG. 4.—B $\flat$  Cornet with strictly conical bore throughout, Klusmann's patent (Rudall, Carte & Co.).

*Registre* giving eight independent positions, afterwards modified as the (3) *Besson compensating system transpositeur*, patented in England in 1859, which was considered so successful that the idea was extensively used by other makers. (4) The *Boosey automatic compensating piston*, invented by D. J. Blaikley, and patented in 1878, a very ingenious device whereby when two or more pistons are used simultaneously the length of the air column is automatically adjusted to the theoretical length required to ensure correct intonation. (5) Victor Mahillon's automatic regulating pistons (*pistons régulateur automatique*) produced about 1886, the result of independent efforts in the same direction as Blaikley, and equally ingenious and effectual.<sup>2</sup> Finally we have (6) more recently the *Besson enharmonic valve system* (fig. 3) with three pistons and six independent tuning

<sup>1</sup> For a fuller description of this system see Capt. C. R. Day, *Descriptive Catalogue of Musical Instruments* (London, 1891), p. 207, No. 406.

<sup>2</sup> *Id.*, pp. 192-193.

slides which give the seven positions independently, thus realizing in a simple effectual manner all that Sax strove to accomplish with his six pistons. The enharmonic valves give all notes theoretically true; there are in addition separate means for adjusting each of the first six lengths, for although these lengths are theoretically correct there are always certain modifying conditions connected with brass instruments which render it essential to provide means for adjustment. All notes being true on this Besson cornet, they can be fingered to the greatest advantage for smoothness and rapidity. (7) Rudall, Carte & Co.'s cornet (fig. 4), with strictly conical bore (Klusmann's patent) throughout the open tube and additional lengths from the mouth-piece to the bell, gives a perfect intonation and is at the same time easy to blow. There are no crooks to this cornet when constructed in B $\flat$ , but it may be instantaneously transposed into the key of A major by means of an undetachable slide guided by a piston rod. (V. M.; K. S.)

**CORNETO TARQUINIA** (anc. *Tarquini*), a town of Italy, in the province of Rome, 62 m. N.W. by rail from the town of Rome, 490 ft. above sea-level. Pop. (1901) 5273. Corneto probably arose after the ancient town had been destroyed by the Saracens. In the 10th century it began to acquire importance, and for some time was an independent commune. It is picturesquely situated, and commands a fine view. It possesses medieval fortifications, and no less than twenty-five towers are still standing in various parts of the town, which thus has a remarkably medieval appearance. The castle on the N. contains the Romanesque church of S. Maria in Castello, begun in 1121, with a fine portal of 1143, a *ciborium* of 1168 and a pulpit of 1209, both in "cosmatesque" work; the pavement in marble mosaic also is fine. There are several other Romanesque and Gothic churches in the town more or less restored. The oldest parts of the Palazzo Comunale date from about 1000. The Gothic Palazzo Vitelleschi (1439) contains remarkably rich windows. The municipal museum (which is to be transferred to this palace) and the Palazzo Bruschi, contain fine collections of Etruscan antiquities from the tombs of Tarquini. Four miles to the S.W. is the Porto Clementino (perhaps the ancient *Graviscæ*, the port of Tarquini), with government saltworks, in which convicts are employed.

See L. Dasti, *Notizie storiche archeologiche di Tarquinia e Corneto* (Rome, 1878); for the cemeteries, *Notizie degli Scavi*, 1906, 1907.

**CORNICE** (Fr. *corniche*, Ital. *cornice*), in architecture, the projection at the top of a wall, which is provided to throw off the rain water from the roof, beyond the face of the building. As employed in classic architecture it forms the upper part of the entablature of an order, and is there subdivided into bed mould, corona and cymatium. The term is also generally applied to any moulding projection which crowns the feature to which it is attached; thus doors and windows, internally as well as externally, have each their cornice, and the same applies to pieces of furniture (see also MASONRY).

**CORNIFICIUS**, the author of a work on rhetorical figures, and perhaps of a general treatise (*ars, τέχνη*) on the art of rhetoric (Quintilian, *Instit.*, iii. 1. 21, ix. 3. 89). He has been identified with the author of the four books of *Rhetorica* dedicated to a certain Q. Herennius and generally known under the title of *Auctor ad Herennium*. The chief argument in favour of this identity is the fact that many passages quoted by Quintilian from Cornificius are reproduced in the *Rhetorica*. Jerome, Priscian and others attributed the work to Cicero (whose *De inventione* was called *Rhetorica prima*, the *Auctor ad Herennium*, *Rhetorica secunda*), while the claims of L. Aelius Stilo, M. Antonius Gniphio, and Ateius Praetextatus to the authorship have been supported by modern scholars. But it seems improbable that the question of authorship will ever be satisfactorily settled. Internal indications point to the date of compositions as 86-82 B.C., the period of Marian domination in Rome. The unknown author, as may be inferred from the treatise itself, did not write to make money, but to oblige his relative and friend Herennius, for whose instruction he promises to supply other works on grammar, military matters and political administration. He

expresses his contempt for the ordinary school rhetorician, the hair-splitting dialecticians and their "sense of inability to speak, since they dare not even pronounce their own name for fear of expressing themselves ambiguously." Finally, he admits that rhetoric is not the highest accomplishment, and that philosophy is far more deserving of attention. Politically, it is evident that he was a staunch supporter of the popular party.

The first and second books of the *Rhetorica* treat of *inventio* and forensic rhetoric; the third, of *dispositio*, *pronuntiatio*, *memoria*, deliberative and demonstrative rhetoric; the fourth, of *elocutio*. The chief aims of the author are conciseness and clearness (*breviter et dilucide scribere*). In accordance with this, he ignores all rhetorical subtleties, the useless and irrelevant matter introduced by the Greeks to make the art appear more difficult of acquisition; where possible, he uses Roman terminology for technical terms, and supplies his own examples of the various rhetorical figures. The work as a whole is considered very valuable. The question of the relation of Cicero's *De inventione* to the *Rhetorica* has been much discussed. Three views were held: that the Auctor copied from Cicero; that they were independent of each other, parallelisms being due to their having been taught by the same rhetorician at Rome; that Cicero made extracts from the *Rhetorica*, as well as from other authorities, in his usual eclectic fashion. The latest editor, F. Marx, puts forward the theory that Cicero and the Auctor have not produced original works, but have merely given the substance of two *ῥήγναι* (both emanating from the Rhodian school); that neither used the *ῥήγναι* directly, but reproduced the revised version of the rhetoricians whose school they attended, the introductions alone being their own work; that the lectures on which the Ciceronian treatise was based were delivered before the lectures attended by the Auctor.

The best modern editions are by C. L. Kayser (1860), in the Tauchnitz, and W. Friedrich (1889), in the Teubner edition of Cicero's works, and separately by F. Marx (1894); see also *De scholiis Rhetorices ad Herennium*, by M. Wisen (1905). Full references to authorities will be found in the articles by Brzoska in Pauly-Wissowa, *Realencyclopädie* (1901); M. Schanz, *Geschichte der römischen Litt.*, i. (2nd ed., pp. 387-394); and Teuffel-Schwabe, *Hist. of Roman Lit.* (Eng. trans., p. 162); see also Mommsen, *Hist. of Rome*, bk. iv. ch. 13.

**CORNING, ERASTUS** (1794-1872), American capitalist, was born in Norwich, Connecticut, on the 14th of December 1794. In 1807 he became a clerk in a hardware store at Troy, New York, but in 1814 he removed to Albany, where he eventually became the owner of extensive ironworks, obtained a controlling interest in various banking institutions, and accumulated a large fortune. He was prominently connected with the early history of railway development in New York, became president of the Utica & Schenectady line, and was the principal factor in the extension and consolidation of the various independent lines that formed the New York Central system, of which he was president from 1853 to 1865. He was also interested in the building of the Michigan Central and the Chicago, Burlington & Quincy railways, and was president of the company which constructed the Sault Sainte Marie ship canal, providing a navigable waterway between Lakes Huron and Superior. He was prominent in politics as a Democrat, and, after serving as mayor of Albany from 1834 to 1837, and as state senator from 1842 to 1845, he was a representative in Congress in 1857-1859 and in 1861-1863, being re-elected for a third term in 1862, but resigning before the opening of the session. In 1861 he was a delegate to the Peace Congress, but when the Civil War actually began he loyally supported the Lincoln administration. He was a delegate to the New York constitutional convention of 1867, and was for many years vice-chancellor of the board of regents of the University of the State of New York. He died at Albany, New York, on the 9th of April 1872.

**CORNING**, a city of Steuben county, New York, U.S.A., in the S. part of the state, on the Chemung river, 10 m. W.N.W. of Elmira. Pop. (1890) 8550; (1900) 11,061, of whom 1410 were foreign-born; (1910) 13,730. Corning is served by the Erie, the Delaware, Lackawanna & Western, and the New

York Central & Hudson River railways. Among the principal buildings and institutions are a fine city hall, a Federal building, a county court house, the Corning hospital, a free public library and St Mary's orphan asylum (Roman Catholic). Corning is one of the principal markets in New York state for tobacco, which is extensively produced in the surrounding country. The principal industry is the making of cut and flint glass, and, of the several extensive plants devoted to this industry, that of the Corning Glass Works is one of the largest in the world. The city also has railway car shops and foundries, and among its manufactures are pressed brick, tile and terra-cotta, papier-mâché and lumber. The total value of the factory products in 1905 was \$3,083,515, 35.7% more than in 1900. There were settlers on the site of Corning as early as 1789, but it was not until 1848 that it was incorporated as a village under its present name, given in honour of Erastus Corning, the railway builder. Corning was chartered as a city in 1890.

See C. H. M'Master, *History of the Settlement of Steuben County* (Bath, N.Y., 1853).

**CORN LAWS.** In England, legislation on corn was early applied both to home and foreign trade in this essential produce. Roads were so bad, and the chain of home trade so feeble, that there was often scarcity of grain in one part, and plenty in another part of the same kingdom. Export by sea or river to some foreign market was in many cases more easy than the carriage of corn from one market to another within the country. The frequency of local dearths, and the diversity and fluctuation of prices, were thus extreme. It was out of this general situation that the first corn laws arose, and they appear to have been wholly directed towards lowering the price of corn. Exportation was prohibited, and home merchandise in grain was in no repute or toleration. As long as the rent of land, including the extensive domains of the crown, was paid in kind, the sovereign, the barons and other landholders had little interest in the price of corn different from that of other classes of people, the only demand for corn being for consumption and not for resale or export. But as rents of land came to be paid in money, the interest of the farmer to be distinguished by a remove from that of the landowner, the difference between town and country to be developed, and the business of society to be more complex, the ruling powers of the state were likely to be actuated by other views; and hence the force which corn legislation afterward assumed in favour of what was deemed the agricultural interest. But during four centuries after the Conquest the corn law of England simply was that export of corn was prohibited, save in years of extreme plenty under forms of state licence, and that producers carried their surplus grain into the nearest market town, and sold it there for what it would bring among those who wanted it to consume; and the same rule prevailed in the principal countries of the continent of Europe. This policy, though, as one may argue from its long continuance, probably not felt to be acutely oppressive, was of no avail in removing the evils against which it was directed. On the contrary it prolonged and aggravated them. The prohibition of export discouraged agricultural improvement, and in so much diminished the security and liberality even of domestic supply; while the intolerance of any home dealing or merchandise in corn prevented the growth of a commercial and financial interest strong enough to improve the means of transport by which the plenty of one part of the same country could have come to the aid of the scarcity in another.

Apart from this general feudal germ of legislation on corn, the history of the British corn laws may be said to have begun with the statute in the reign of Henry VI. (1436), by English corn laws, 1436-1603. which exportation was permitted without state licence, when the price of wheat or other corn fell below certain prices. The reason given in the preamble of the statute was that the previous state of the law had compelled farmers to sell their corn at low prices, which was no doubt true, but which also showed the important turn of the tide that had set in. J. R. M'Culloch, in an elaborate article in the *Commercial Dictionary*, says that the fluctuation of the prices of corn in that age was so great, and beyond all present conception, that "it is

not easy to determine whether the exportation price of 6s. 8d. for wheat " [12s. 10d. in present money per quarter ] " was above or below the medium price." But while the medium price of the kingdom must be held to be unascertainable in a remote time, when the medium price in any principal market town of England did not agree with that of another for any year or series of years, one may readily perceive that the cultivators of the wheat lands in the south-eastern counties of England, for example, who could frequently have sold their produce in that age to Dutch merchants to better advantage than in their own market towns, or even in London, but were prohibited to export abroad, and yet had no means of distributing their supplies at home so as to realize the highest medium price in England, must have felt aggrieved, and that their barons and knights of the shire would have a common interest in making a strong effort to rectify the injustice in parliament. This object appears to have been in some measure accomplished by this statute, and twenty-seven years afterwards (1463) a decided step was taken towards securing to agriculturists a monopoly of the home market by a statute prohibitory of importation from abroad. Foreign import was to be permitted only at and above the point of prices where the export of domestic produce was prohibited. The landed interest had now adopted the idea of sustaining and equalizing the value of corn, and promoting their own industry and gains, which for four centuries, under various modifications of plan, and great changes of social and political condition, were to maintain a firm place in the legislation and policy of England. But there were many reasons why this idea, when carried into practice, should not have the results anticipated from it.

The import of grain from abroad, even in times of dearth and high prices at home, could not be considerable as long as the policy of neighbouring countries was to prohibit export; nor could the export of native corn, even with the Dutch and other European ports open to such supplies, be effective save in limited maritime districts, as long as the internal corn trade was suppressed, not only by want of roads, but by legal interdict. The regulation of liberty of export and import by rates of price, moreover, had the same practical objection as the various sliding-scales, bounties, and other legislative expedients down to 1846, viz. that they failed, probably more in that age than in later times, to create a permanent market, and aimed only at a casual trade. When foreign supplies were needed, they were often not to be found; and when there was an excess of corn in the country a profitable outlet was both difficult and uncertain. It would appear, indeed, that during the Wars of the Roses the statutes of Henry VI. and Edward IV. had become obsolete; for a law regulating export prices in identical terms of the law of 1436 was re-enacted in the reign of Philip and Mary (1554). In the preceding reign of Edward VI., as well as in the succeeding long reign of Elizabeth, there were unceasing complaints of the decay of tillage, the dearth of corn, and the privations of the labouring classes; and these complaints were met by the same kind of measures—by statutes encouraging tillage, forbidding the enlargement of farms, imposing severer restrictions on storing and buying and selling of grain, and by renewed attempts to regulate export and import according to prices. In 1562 the price at which export might take place was raised to 10s. per quarter for wheat, and 6s. 8d. for barley and malt. This only lasted a few years, and in 1570 the export of wheat and barley was permitted from particular districts on payment of a duty of 1s. 8d. per quarter, although still liable to prohibition by the government or local authority, while it was entirely prohibited under the old regulations from other districts. Only at the close of Elizabeth's reign (1603) did a spark of new light appear in a further statute, which removed the futile provisions in favour of tillage and against enlargement of pastoral farms, and rested the whole policy for promoting an equable supply of corn, while encouraging agriculture, on an allowed export of wheat and other grain at a duty of 2s. and 1s. 4d. when the price of wheat was not more than 20s., and of barley and malt 12s. per quarter. The import of corn appears to have been much lost sight of from the period of the statute of 1463. The internal state of England,

as well as the policy of other countries of Europe, was unfavourable to any regular import of grain, though many parts of the kingdom were often suffering from dearth of corn. It is obvious that this legislation, carried over more than a century and a half, failed of its purpose, and that it neither promoted agriculture nor increased the supply of bread. So great a variance and conflict between the intention of statutes and the actual course of affairs might be deemed inexplicable, but for an explanation which a close economic study of the circumstances of the times affords.

Besides the general reasons of the failure already indicated, there were three special causes in active operation, which, though not seen at the period, have become distinct enough since. (1) A comparatively free export of wool had been permitted in England from time immemorial. It was subject neither to conditions of price nor to duties in the times under consideration, was easier of transport and much less liable to damage than corn, and, under the extending manufactures of France and the Low Countries, was sure of a foreign as well as a domestic market. Here was one description of rural produce on which there was the least embargo, and on which some reliance could be placed that it would in all circumstances bring a fair value; while corn, the prime rural produce, was subject as a commodity of merchandise to every difficulty, internally and externally, which meddling legislation and popular prejudice could impose. The numerous statutes enjoining tillage and discouraging pastoral farms—or in other words requiring that agriculturists should turn from what was profitable to what was unprofitable—had consequently no substantial effect, save in the many individual instances in which the effect may have been injurious. (2) The value of the standard money of the kingdom had been undergoing great depreciation from two opposite quarters at once. The pound sterling of England was reduced in weight of pure metal from £1 : 18 : 9 in 1436, the date of the first of the corn statutes, to 4s. 7½d. in 1551, as far as can be estimated in present money, and to £1 : 0 : 6½ under the restoration of the coinage in the following year. At the same time the greater abundance of silver, which now began to be experienced in Europe from the discovery of the South American mines, was steadily reducing the intrinsic value of the metal. Hence a general rise of prices remarked by Hume and other historians; and hence also it followed that a price of corn fixed for export or import at one period became always at another period more or less restrictive of export than had been designed. (3) The wages of labour would have followed the advance in the prices of commodities had wages been left free, but they were kept down by statute to the three or four pence per day at which they stood when the pound sterling contained one-fourth more silver, and silver itself was much more valuable. This was a refinement of cruelty. The feudal system was breaking up; a wage-earning population was rapidly increasing both in the farms and in the towns; but the spirit of feudalism remained, and the iron collar of serfdom was riveted round the necks of the labourers by these statutes many generations after they had become nominally freemen.<sup>1</sup> The result was chronic privation and discontent among the common people, by which all the conditions of agriculture and trade in corn were further straitened and barbarized; and an age, in some high respects among the most brilliant in the annals of England, was marked by an enormous increase of pauperism, and by the introduction of the merciful but wasteful remedy of the Poor Laws.

The corn legislation of Elizabeth remained without change during the reign of James, the civil wars and the Commonwealth. But on the restoration of Charles II. in 1660, the question was resumed, and an act was passed of a more prohibitory character. Export and import of corn, while nominally permitted,

<sup>1</sup> M'Culloch found from a comparison of the prices of corn and wages of labour in the reign of Henry VII. and the latter part of the reign of Elizabeth, that in the former period a labourer could earn a quarter of wheat in 20, a quarter of rye in 12, and a quarter of barley in 9 days; whereas, in the latter period, to earn a quarter of wheat required 48, a quarter of rye 32, and a quarter of barley 29 days' labour.

were alike subjected to heavy duties—the need of the exchequer being the paramount consideration, while the agriculturists were no doubt pleased with the complete command secured to them in the home market. This act was followed by such high prices of corn, and so little advantage to the revenue, that parliament in 1663 reduced the duties on import to 9% *ad valorem*, while at the same time raising the price at which export ceased to 48s., and reducing the duty on export from 20s. to 5s. 4d. per quarter. In a few years this was found to be too much free-trade for the agricultural liking, and in 1670 prohibitory duties were re-imposed on import when the home price was under 53s. 4d., and a duty of 8s. between that price and 80s., with the usual make-weight in favour of home supply, that export should be prohibited when the price was 53s. 4d. and upwards. But complaints of the decline of agriculture continued to be as rife under this act as under the others, till on the accession of William and Mary, the landed interest, taking advantage of the Revolution as they had taken advantage of the Restoration to promote their own interests, took the new and surprising step of enacting a bounty on the export of grain. This evil continued to affect the corn laws of the kingdom, varied, on one occasion at least, with the further complication of bounties on import, until the 19th century. The duties on export being abolished, while the heavy duties on import were maintained, this is probably the most one-sided form which the British corn laws ever assumed, but it was attended with none of the advantages anticipated. The prices of corn fell, instead of rising. There had occurred at the period of the Revolution a depreciation of the money of the realm, analogous in one respect to that which marked the first era of the corn statutes (1436–1551), and forming one of the greatest difficulties which the government of William had to encounter. The coin of the realm was greatly debased, and as rapidly as the mint sent out money of standard weight and purity, it was melted down, and disappeared from the circulation. The influx of silver from South America to Europe had spent its action on prices before the middle of the century; the precious metals had again hardened in value; and for forty years before the Revolution the price of corn had been steadily falling in money price. The liberty of exporting wool had also now been cut down before the English manufactures were able to take up the home supply, and agriculturists were consequently forced to extend their tillage. When the current coin of the kingdom became wholly debased by clipping and other knaveries, there ensued both irregularity and inflation of nominal prices, and the producers and consumers of corn found themselves equally ill at ease. The farmers complained that the home-market for their produce was unremunerative and unsatisfactory; the masses of the people complained with no less reason that the money wages of labour could not purchase them the usual necessaries of life. Macaulay, in his *History of England*, says of this period, with little exaggeration, that “the price of the necessaries of life, of shoes, of ale, of oatmeal, rose fast. The labourer found that the bit of metal which, when he received it, was called a shilling, would hardly, when he purchased a pot of beer or a loaf of rye bread, go as far as sixpence.” The state of agriculture could not be prosperous under these conditions. But when the government of William surmounted this difficulty of the coinage, as they did surmount it, under the guidance of Sir Isaac Newton, with remarkable statesmanship, it necessarily followed that prices, so far from rising, declined, because, for one reason, they were now denominated in a solid metallic value. The rise of prices of corn attending the first years of the export bounty was consequently of very brief duration. The average price of wheat in the Winchester market, which in the ten years 1690–1699 was £2: 10s., fell in the ten years 1716–1725 to £1: 5s. 4d., and in the ten years 1746–1755 to £1: 1s. 2d. The system of corn law established in the reign of William and Mary was probably the most perfect to be conceived for advancing the agricultural interest of any country. Every stroke of the legislature seemed complete to this end. Yet it wholly failed of its purpose. The price of wheat again rose in 1750–1760 and

1760–1770 to £1: 19s. 3d. and £2: 11s. 3d., but many causes had meanwhile been at work, as invariably happens in such economic developments, the operation of which no statutes could embrace, either to control or to prevent. Between the reign of William and Mary and that of George III., the question of bounty on export of grain had, in the general progress of the country, fallen into the background, while that of the heavy embargoes on import had come to the front. Therefore it is that Burke's Act of 1773, as a deliberate attempt to bring the corn laws into some degree of reason and order, is worthy of special mention. This statute permitted the import of foreign wheat at a nominal duty of 6d. when the home price was 48s. per quarter, and it stopped both the liberty to export and the bounty on export together when the home price was 44s. per quarter. The one blemish of this statute was the stopping export and cutting off bounty on export at the same point of price.

Few questions have been more discussed or more differently interpreted than the elaborate system of corn laws dating from the reign of William and Mary. So careful an observer as Malthus was of opinion that the bounty on export had enlarged the area of subsistence. That it had large operation is sufficiently attested by the fact that, in the years from 1740 to 1751, bounties were paid out of the exchequer to the amount of £1,515,000, and in 1749 alone they amounted to £324,000. But the trade thus forced was of no permanence, and the British exports of corn, which reached a maximum of 1,667,778 quarters in 1749–1750, had fallen to 600,000 quarters in 1760 and continued to decrease.

Burke's Act lasted long enough to introduce a regular import of foreign grain, varying with the abundance or scarcity of the home harvest, yet establishing in the end a systematic preponderance of imports over exports. The period, 1791-1846. moreover, was marked by great agricultural improvements, by extensive reclamation of waste lands, and by an increased home produce of wheat, in the twenty years from 1773 to 1793, of nearly 2,000,000 quarters. Nor had the course of prices been unsatisfactory. The average price of British wheat in the twenty years was £2: 6s. 3d., and in only three years of the twenty was the price a fraction under £2. But the ideas in favour of greater freedom of trade, of which the act of 1773 was an indication, and of which another memorable example was given in Pitt's commercial treaty with France, were overwhelmed in the extraordinary excitement caused by the French Revolution, and all the old corn law policy was destined to have a sudden revival. The landowners and farmers complained that an import of foreign grain at a nominal duty of 6d., when the price of wheat was only 48s., deprived them of the ascending scale of prices when it seemed due; and on this instigation an act was passed in 1791, whereby the price at which importation could proceed at the nominal duty of 6d. was raised to 54s., with a duty of 2s. 6d. from 54s. to 50s., and at 50s. and under 50s. a prohibitory duty of 24s. 3d. The bounty on export was maintained by this act, but exportation was allowed without bounty till the price reached 46s.; and the permission accorded by the statute of 1773 to import foreign corn at any price, to be re-exported duty free, was modified by a warehouse duty of 2s. 6d. in addition to the duties on import payable at the time of sale, when the corn, instead of being re-exported, happened to be sold for home consumption. The legislative vigilance in this statute to prevent foreign bread from reaching the home consumer is remarkable. There were deficient home harvests for some years after 1791, particularly in 1795 and 1797, and parliament was forced to the new expedient of granting high bounties on importation. At this period the country was involved in a great war; all the customary commercial relations were violently disturbed; freight, insurance and other charges on import and export were multiplied fivefold; heavier and heavier taxes were imposed; and the capital resources of the kingdom were poured with a prodigality without precedent into the war channels. The consequence was that the price of corn, as of all other commodities, rose greatly; and the Bank of England having



stopped paying in specie in 1797, this raised nominal prices still more under the liberal use of bank paper in loans and discounts, and the difference that began to be established in the actual value of Bank of England notes and their legal par in bullion.

The average price of British wheat rose to £5 : 19 : 6 in 1801. So unusual a value must have led to a large extension of the area under wheat, and to much corn-growing on land that after great outlay was ill prepared for it. In the following years there were agricultural complaints; and in 1804, though in 1803 the average price of wheat had been as high as £2 : 18 : 10, an act was passed, so much more severe than any previous statute, that its object would appear to have been to keep the price of corn somewhere approaching the high range of 1801. A prohibitory duty of 24s. 3d. was imposed on the import of foreign wheat when the home price was 63s. or less; and the price at which the bounty was paid on export was lowered to 40s., while the price at which export might proceed without bounty was raised to 54s. Judging from the prices that ruled during the remaining period of the French wars, this statute would appear to have been effective for its end, though, under all the varied action of the times on a rise of prices, it would be difficult to assign its proper place in the general effect. The average price of wheat rose to £4 : 9 : 9 in 1805, and the bank paper price in 1812 was as high even as £6 : 6 : 6. The bullion prices from 1809 to 1813 ranged from 86s. 6d. to 100s. 3d. But it was foreseen that when the wars ended a serious reaction would ensue, and that the rents of land, and the general condition of agriculture, under the warlike, protective and monetary stimulation they had received, would be imperilled. In the brief peace of 1814 the average bullion price of British wheat fell to 55s. 8d. All the means of select committees of inquiry on agricultural distress, and new modifications of the corn laws, were again brought into requisition. The first idea broached in parliament was to raise the duties on foreign imports, as well as the prices at which they were to be leviable, and to abolish the bounty on export, while permitting freedom of export whatever the home price might be. The latter part of the scheme was passed into law in the session of 1814; but the irritation of the manufacturing districts against the new scale of import duties was too great to be resisted. In the subsequent session an act was passed, after much opposition, fixing 80s. (14s. more than during the wars) as the price at which import of wheat was to become free of duty.

This act of 1815 was intended to keep the price of wheat in the British markets at about 80s. per quarter; but the era of war and great expenditure of money raised by public loans had ended, the ports of the continent were again open to some measure of trade and to the equalizing effect of trade upon prices, the Bank of England and other banks of issue had to begin the uphill course of a resumption of specie payments, the nation had to begin to feel the whole naked weight of the war debt, and the idea of the protectors of a high price of corn was proved by the event to be an utter hallucination. The corn statutes of the next twenty years, though occupying an enormous amount of time and attention in the Houses of Parliament, may be briefly treated, for they are simply a record of the impotence of legislation to maintain the price of a commodity at a high point when all the natural economic causes in operation are opposed to it. In 1822 a statute was passed reducing the limit of prices at which importation could proceed to 70s. for wheat, 35s. for barley, 25s. for oats; but behind the apparent relaxation was a new scale of import duties, by which foreign grain was subjected to heavy three-month duties up to a price of 85s.,—17s. when wheat was 70s., 12s. when between 70s. and 80s., and 10s. when 85s., showing the grasping spirit of the would-be monopolizers of the home supply of corn, and their reluctance to believe in a lower range of value for corn as for all other commodities. This act never operated, for the reason that, with the exception in some few instances of barley, prices never were so high as its projectors had contemplated. The corn trade had passed rapidly beyond reach of the statutes by which it was to be so painfully controlled; and as there were occasional seasons of scarcity, particularly in oats, the king in

council was authorized for several years to override the statutes, and do whatever the public interests might require.

In 1827 Canning introduced a new system of duties, under which there would have been a fixed duty of 1s. per quarter when the price of wheat was at or above 70s., and an increased duty of 2s. for every shilling the price fell below 69s.; but though Canning's resolutions were adopted by a large majority in the House of Commons, his death and the consequent change of ministers involved the failure of his scheme of corn duties. In the following year Charles Grant introduced another scale of import duties on corn, by which the duty was to be 23s. when the price was 64s., 16s. 8d. when the price was 69s., and only 1s. when the price was 73s. or above 73s. per quarter; and this became law the same year. This sliding scale was more objectionable, as a basis of foreign corn trade, than that of Canning, though not following so closely shilling by shilling the variation of prices, because of the abrupt leaps it made in the amount of duties leviable. For example, a merchant who ordered a shipment of foreign wheat when the home price was 70s. and rising to 73s., instead of having a duty of 1s. to pay, should on a backward drop of the home price to 69s. have 16s. 8d. of duty to pay. The result was to introduce wide and incalculable elements of speculation into all transactions in foreign corn. The prices during most part of this period were under the range at which import was practically prohibited. The average price of British wheat was 96s. 11d. in 1817, but from that point there was in succeeding years a rapid and progressive decline, varied only by the results of the domestic harvests, till in 1835 the average price of wheat was 39s. 4d., of barley 29s. 11d. and oats 22s. The import of foreign grain in these years consisted principally of a speculative trade, under a privilege of warehousing accorded in the statute of 1773, and extended in subsequent acts, by which the grain might be sold for home consumption on payment of the duties, or re-exported free, as suited the interest of the holders.

The act of 1822 admitted corn of the British possessions in North America under a favoured scale of duties, and in 1825 a temporary act was passed, allowing the import of wheat from these provinces at a fixed duty of 5s. per quarter, irrespective of the home price, which, if maintained, would have given some stability to the trade with Canada. The idea of a fixed duty on all foreign grain, however, appears to have grown in favour from about this period. It was included in the programme of import duty reforms of the Whig government in 1841, and fell with its propounders in the general election of that year. Sir Robert Peel, on succeeding to office, and commencing his remarkable career as a free-trade statesman, introduced and carried in 1842 a new sliding scale of duties somewhat better adjusted to the current values. But public opinion by this time was changing, and the prime minister, convinced, as he confessed, by the arguments of Cobden and the Anti-Corn-Law League, and stimulated into action by the failure of the potato crop in Ireland, put an effectual end to the history of the corn laws by the famous act of 1846. It was provided under this measure that the maximum duty on foreign wheat was to be immediately reduced to 10s. per quarter when the price was under 48s., to 5s. on barley when the price was under 26s., and to 4s. on oats when the price was under 18s., with lower duties as prices rose above these figures; but the conclusive part of the enactment was that in three years—on the 1st of February 1849—these duties were to cease, and all foreign corn to be admitted at a duty of 1s. per quarter, and all foreign meal and flour at a duty of 4½ d. per cwt.—the same nominal imposts which were conceded to grain and flour of British possessions abroad from the date of the act. In 1869 even these nominal duties were abolished by Robert Lowe in a Customs Duties Act. In 1902 a registration duty of 3d. per cwt. was imposed on imported corn, and 5d. per cwt. on imported flour, in the expectation that such a duty would broaden the basis of taxation. The duty was, however, repealed the following year. But a low duty on imported foreign corn was made an essential part of the tariff reform scheme advocated by Mr. J. Chamberlain (*q.v.*) from 1903 onwards.

*Foreign Corn Laws.*—Freedom of export of corn from customs

duties has become the general rule of nearly all foreign countries. It is somewhat curious that Spain saw the advantage to her wheat-

**Spain.** producing provinces of freedom of export of wheat as early as 1820, and three years afterwards extended this freedom to all "fruits of the soil" in Spain. The import duty on wheat, as on other grain, has varied from time to time. The tariff of 1882 fixed the duty at 2s. 3½d. per cwt.; a law of February 1895 raised the duty to 4s. 3½d. per cwt., at which rate it remained till 1898, when it was reduced to 2s. 5½d., though in this same year, that of the war with the United States, it was for some three months suspended, owing to distress in the country. In 1899 it was raised to 3s. 3d., and by a law of March 1904 fixed at 6.00 pesetas per 100 kilos (2s. 5½d. per cwt.) as long as the average price of wheat in the markets of Castile does not fall below 27.00 pesetas per 100 kilos (11s. per cwt.). The duty on rye, oats, barley and maize is 1s. 9½d. per cwt. The duty on flour varied from 3s. 4½d. per cwt. in 1882 to 7s. 0½d. in 1895; by the law of March 1904 it was fixed at 4s. 0½d. per cwt. The duty on rice is 2s. 1½d. per cwt. in the husk and 4s. 3½d. not in the husk.

**Portugal.** In Portugal the import duty on wheat was fixed by a law of May 1888 at 20 reis per kilo (4s. 7d. per cwt.). By a law of July 1889, as amended by laws of August 1891 and July 1899, importation is prohibited except in the event of the home-grown crop being insufficient, and even then permission is confined to millers. The duty, in the event of permission to import being accorded, is to be charged on a sliding scale intended to keep the cost of wheat to the millers, including the duty, at 60 reis (3½d.) per kilo (2.2 lbs.). Maize is subject to a duty of 4s. 1½d. per cwt., and rye, oats and barley to one of 3s. 8d. per cwt. By laws of July 1889 and August 1891 the importation of flour was prohibited except in the event of a strike of the mill-hands, and the duty was fixed at 6s. 2d. per cwt. Export and import of grain in France were prohibited down to the period of the repeal of the British corn laws, save when prices were below certain limits in the one case and above certain other limits in the other. But export of grain and flour from France has long been free of duty. On the other hand, import duties have varied considerably. By a law of 1881, the duty on wheat was fixed at 3d. per cwt.; this duty was raised in 1885 to 1s. 2½d. per cwt. and again in 1887 to 2s. 0½d. By a law of 1894 the duty was fixed at 2s. 10½d. per cwt. In 1898, owing to the sudden rise in the price of corn occasioned by the war between Spain and the United States, the duty was temporarily (the 4th of May to the 30th of June) suspended. By a law of 1873 free importation of rye, barley, maize and oats was permitted, but by a law of 1885 a duty was fixed at 7½d. per cwt., and this was subsequently (1887) increased to 1s. 2½d. In 1881 the duty on imported flour was as low as 5½d. per cwt., but this was increased successively by laws of 1885, 1887, 1891 and 1892, and in 1894 was fixed at 4s. 5½d. per cwt. at the rate of extraction of 70% and over; 5s. 5½d. at 70 to 60%; and 6s. 6d. at 60% and under. In Belgium both the

**France.** export and import of wheat, rye, barley and maize are free of duty; so also were oats and flour. Since 1895, however, there has been a duty of 1s. 2½d. on oats, and of 9½d. on flour. The policy of the Netherlands was, owing to the advantages possessed by its ports, long favourable to the import and export of grain. But for some years prior to 1845 there was a moderate sliding scale of import duties, and this gave place, on the ravages of the potato disease, to a low fixed duty; since 1877, however, the importation of cereals and flour has been free. In Italy there are no duties on the

**Belgium.** export of grain. The import duties show a progressive increase. In 1878 the import duty on wheat was 6½d. per cwt.; this was increased to 1s. 2½d. in 1888, and in 1894 to 3s. 0½d. As in Spain and France, there was a temporary reduction and suspension during 1898, on the Spanish-American war. The duty on rye, barley, oats and maize was fixed by the tariff of 1878 at 5½d. per cwt. By a decree of 1894 the duty on rye was raised to 1s. 10d.; that on barley, by a decree of 1896, to 1s. 7½d.; that on oats, by a decree of 1888, to 1s. 7½d.; and that on maize, by a decree of 1896, to 3s. 0½d. The duty on flour, fixed at 1s. 1½d., by the tariff of 1878, was raised to 2s. 5½d. in 1888, to 3s. 6½d. in

1888, and to 5s. in 1894. In Germany, the duty on wheat and rye, as fixed by the tariff of 1879, was 6d. per cwt. In 1885 this was raised to 1s. 6½d., and in 1888 to 2s. 6½d. By treaty in 1892 this was decreased to 1s. 9½d. On oats the duty in 1879 was 6d. per cwt., increased to 9½d. in 1885, and again, in 1888, to 2s. 0½d., but reduced to 1s. 5d. in 1892. On barley the duty in 1879 was 3d., in 1885 9½d., in 1888 1s. 1½d., and in 1892 1s. 0½d. On maize, 3d. in 1879, 6d. in 1885, 1s. 0½d. in 1888, and 9½d. in 1892. On flour, 1s. 0½d. in 1879, 3s. 9½d. in 1885, 5s. 4d. in 1888, and 3s. 8½d. in 1892. The new German tariff of 1906 which formed the basis for the new German commercial treaties with Russia, Italy, Austria-Hungary, &c., and which was passed when the influence of the agrarian party was predominant, increased still more the import duties on cereals. Under this tariff there are two rates of duties: (1). Those of the new "general" tariff as applied to imports from all countries entitled to most favoured-nation treatment. (2). "Conventional" tariff rates, conceded to other states as the result of treaties. Under this tariff the "general" and "conventional" duties, respectively, on wheat are 3s. 9½d. and 2s. 9d.; on oats and rye, 3s. 6½d. and 2s. 6½d.; on "common baker's produce," 8s. 3d. and 5s. 2d. In Austria-Hungary the import duty on wheat and rye is, under the tariff of 1887, 1s. 6½d. per cwt.; on barley and oats, 9½d.; on maize, 6d., and on flour, 3s. 9½d.

The great countries, famous for a production of raw materials much beyond their own means of consumption, are favourable, of course, to the utmost freedom of export. The empire of China itself was never unwilling to sell to foreigners tea for which there was no domestic use. The United States promotes transit and export of grain, internally and externally, with all the intelligence and resources of a civilized people. Although the import duty on "breadstuffs" imposed by the United States tariff is very high, and is, possibly, a useful protection against the importation of "baker's products," yet it is to a certain extent unnecessary for a country which must dispose of its surplus by exportation. The same remark applies to Russia, whose exportation and importation are alike free, though there is an import duty on wheat flour of 2s. 11½d. per cwt. In the British colonies probably the only example of an export duty is that on rice in British India; it amounts to 3 annas per maund (4d. per cwt.). The import of grain into India is free. In Australia, New Zealand, Canada, and all mainly agricultural countries, there is no export duty. In each of these countries, however, there is an import duty; in the cases of Australia and New Zealand, designed, to a certain extent, as a precaution against possible rivalry on the part of the other. The Australian import duty is 1s. 6d. per cental (100 lb av.), and the New Zealand 9d. per cental. The Canadian import duties on grain are important only in the light of being a species of retaliation against similar duties imposed by the United States with the design of restricting inter-frontier exchange. The Canadian import duty is, on barley, 30% *ad valorem*; on buckwheat, rye and oats, 4.93d. per bushel, and on wheat, 5.92d. per bushel. The South African production of cereal is still insufficient to meet the demand for home consumption, and there is a considerable grain importation. The import duty, which undoubtedly acts as an encouragement to home agriculture, is 1s. per cental. (See also GRAIN TRADE.) (R. So.; T. A. I.)

**CORN-SALAD**, or LAMB'S LETTUCE, *Valerianella olitoria* (natural order Valerianaceae), a weedy annual, native of southern Europe, but naturalized in cornfields in central Europe, and not infrequent in Britain. In France it is used in salads during winter and spring as a substitute for lettuces, but it is less esteemed in England. The plant is raised from seed sown on a bed or border of light rich earth, and should be weeded and watered, as occasion requires, till winter, when it should be protected with long litter during severe frost. The largest plants should be drawn for use in succession. Sowing may be made every two or three weeks from the beginning of August till

Germany.

Austria-Hungary.

United States.

Russia.

India.

Australia, New Zealand, Canada.

South Africa.

October, and again in March, if required in the latter part of the spring. The sorts principally grown are the Round-leaved and the Italian; the last is a distinct species, *Valerianella eriocarpa*.

**CORNU, MARIE ALFRED** (1841–1902), French physicist, was born at Orleans on the 6th of March 1841, and after being educated at the École Polytechnique and the École des Mines, became in 1867 professor of experimental physics in the former institution, where he remained throughout his life. Although he made various excursions into other branches of physical science, undertaking, for example, with J. B. A. Baille about 1870 a repetition of Cavendish's experiment for determining the mean density of the earth, his original work was mainly concerned with optics and spectroscopy. In particular he carried out a classical redetermination of the velocity of light by A. H. L. Fizeau's method, introducing various improvements in the apparatus, which added greatly to the accuracy of the results. This achievement won for him, in 1878, the *prix Lacaze* and membership of the Academy of Sciences in France, and the Rumford medal of the Royal Society in England. In 1899, at the jubilee commemoration of Sir George Stokes, he was Rede lecturer at Cambridge, his subject being the undulatory theory of light and its influence on modern physics; and on that occasion the honorary degree of D.Sc. was conferred on him by the university. He died at Paris on the 11th of April 1902.

**CORNU COPIAE**, later CORNUCOPIA ("horn of plenty"), a horn; generally twisted, filled with fruit and flowers, or an ornament representing it. It was used as a symbol of prosperity and abundance, and hence in works of art it is placed in the hands of Plutus, Fortuna and similar divinities (for the mythological account see AMALTHEIA). The symbol probably originated in the practice of using the horns of oxen and goats as drinking-cups; hence the *rhyton* (drinking-horn) is often confounded with the *cornu copiae*. For its representation in works of art, in which it is very common, especially in those belonging to the Roman period, see article in Daremberg and Saglio's *Dictionnaire des Antiquités*.

**CORNUS**, an ancient town of Sardinia, of Phoenician origin, on the west coast, 18 m. from Tharros, and the same from Bosa. At the time of the Second Punic War it is spoken of as the principal city of the district, and its capture by the Romans was the last act in the suppression of the rebellion of 215 B.C., it having served as a place of refuge for the fugitives after the defeat of the combined forces of the rebels and the Carthaginians. The site of the ancient acropolis, covered with débris, may still be made out. Here were found three inscriptions in 1831, with dedications by the *ordo*, or town council, of Cornus to various patrons, from one of which it seems that it was a colony, though when it became so is unknown (Th. Mommsen, *Corp. Inscr. Lat.* x. 7915 sqq.). Unimportant remains of an aqueduct and (perhaps) of a church exist. Excavations in the necropolis of the Roman period are recorded by F. Nissardi, *Notizie degli Scavi*, 1887, p. 47. Phoenician rock-cut tombs may also be seen.

**CORNUTUS, LUCIUS ANNAEUS**, Stoic philosopher, flourished in the reign of Nero. He was a native of Leptis in Libya, but resided for the most part in Rome. He is best known as the teacher and friend of Persius, whose satires he revised for publication after the poet's death, but handed them over to Caesius Bassus to edit, at the special request of the latter. He was banished by Nero (in 66 or 68) for having indirectly disparaged the emperor's projected history of the Romans in heroic verse (Dio Cassius lxi. 29), after which time nothing more is heard of him. He was the author of various rhetorical works in both Greek and Latin (*Ῥητορικὰ Τέχνη*, *De figuris sententiarum*). Another rhetorician, also named Cornutus, who flourished A.D. 200–250 (or in the second half of the 2nd century) was the author of a treatise *Τέχνη τοῦ πολιτικοῦ λόγου* (ed. J. Graeven, 1890). A philosophical treatise, *Theologiae Graecae compendium* (of which the Greek title is uncertain; perhaps, *Ἑλληνικὴ θεολογία*, or *Περὶ τῆς τῶν θεῶν φύσεως*, though the latter may be the title of an abridgment of the former) is still extant. It is a manual of "popular mythology as expounded in the etymological and symbolical interpretations of the Stoics" (Sandys), and although marred by many absurd etymologies, abounds in beautiful

thoughts (ed. C. Lang, 1881). Simplicius and Porphyry refer to his commentary on the *Categories* of Aristotle, whose philosophy he is said to have defended against an opponent Athenodorus in a treatise *Ἀντιγραφή πρὸς Ἀθηνοδωρον*. His Aristotelian studies were probably his most important work. A commentary on Virgil (frequently quoted by Servius) and *Scholía* to Persius are also attributed to him; the latter, however, are of much later date, and are assigned by Jahn to the Carolingian period. Excerpts from his treatise *De enuntiatione vel orthographia* are preserved in Cassiodorus. The so-called *Disticha Cornuti* (ed. Liebl, Straubing, 1888) belong to the late middle ages.

See G. Martini, *De L. Annaeo Cornuto* (1825); O. Jahn, *Prolegomena* to his edition of Persius; H. von Arnim in Pauly-Wissowa's *Realencyclopädie*, i. pt. ii. (1894); M. Schanz, *Geschichte der römischen Literatur*, i. 2 (1901), p. 285; W. Christ, *Geschichte der griechischen Literatur* (1898), pp. 702, 755; Teuffel-Schwabe, *Hist. of Roman Literature* (Eng. trans.), § 299, 2.

**CORNWALL**, the capital of the united counties of Stormont, Dundas and Glengarry, Ontario, Canada, 67 m. S.W. of Montreal, on the left bank of the St Lawrence river. Pop. (1901) 6704. It is an important station on the Grand Trunk and the Ottawa & New York railways, and is a port of call for all steamers between Montreal and Lake Ontario ports. The surplus from the Cornwall canal furnishes excellent water privileges for its factories, which include cotton and woollen mills and grist and saw mills. The town has long been celebrated for its lacrosse club. On the opposite bank of the river is St Régis, inhabited chiefly by Indians of the Iroquois tribe.

**CORNWALL**, the south-westernmost county of England, bounded N. and N.W. by the Atlantic Ocean, E. by Devonshire, and S. and S.W. by the English Channel. The area is 1356.6 sq. m. The most southerly extension is Lizard Point, and the most westerly point of the mainland Land's End, but the county also includes the Scilly Isles (*q.v.*), lying 25 m. W. by S. of Land's End. No county in England has a stronger individuality than Cornwall, whether in economic or social conditions, in history, nomenclature, tradition, or even in the physical characteristics of the land. Such individuality is hardly to be compassed within political boundaries, and in some respects it is shared by the neighbouring county of Devon, yet the traveller hardly feels its influence before passing west of the Tamar.

Physically, Cornwall is a great promontory with a direct length of 75 m. from N.N.E. to S.S.W., and an extreme breadth, at the junction with Devonshire, of 45 m. The river Tamar here forms the greater part of the boundary, and its valley divides the high moors of Devonshire and the succession of similar broad-topped hills which form the backbone of the Cornish promontory. The scenery is full of contrast. To the west of Launceston the principal mass of high land rises to 1375 ft. in Brown Willy, the highest point in the county. This district is broken and picturesque, with rough *tors* or hills and boulders. A remarkable pile of rocks called the Cheese-wring, somewhat resembling an inverted pyramid in form, is seen on the moor north of Liskeard. This district is for the most part a region of furze and heather; but after passing Bodmin, the true Cornish moorland asserts itself, bare, desolate and impracticable, broken and dug into hillocks, which are sometimes due to early mining works, sometimes to more modern search for metals. The seventy miles from Launceston to Mount's Bay have been called not untruly "the dreariest strip of earth traversed by any English high road." There is hardly more cultivation on the higher ground west of Mount's Bay, or in the Meneage or "rocky country," the old Cornish name for the promontory which ends in the Lizard. Long combs and valleys, however, descend from this upper moorland towards the coast on both sides. These are in general well wooded, and, in the luxuriance of their vegetation, strongly characteristic. The small rivers traversing them in several cases enter fine estuaries, which ramify deeply into the land. Such are, on the south coast, the great estuary of the Tamar, and other streams, on which the port of Plymouth is situated (but only the western shore is Cornish), the Looe and Fowey rivers, Falmouth Harbour, the most important of the purely Cornish inlets and accessible for the largest vessels, and

the Helford river. On the north are the estuaries of the Camel and the Hayle, debouching into Padstow Bay and St Ives Bay respectively. The Fowey and Camel valleys almost completely break the continuation of the central high ground, and the uplands west of Mount's Bay are similarly parted from the main mass by the low tract between Hayle and Marazion. Except at the mouth of a stream or estuary the coast is almost wholly rock-bound, and the cliff scenery is unsurpassed in England. Three different types are found. On the north coast, from Tintagel Head and Boscastle northward to Hartland Point in Devonshire, the dark slate cliffs, with their narrow and distorted strata, are remarkably rugged of outline, owing to the ease with which the waves fret the loosely-bound rock. On the south, in the beautiful little bays in the neighbourhood of the Lizard Point, the serpentine rock is noted for its exquisite colouring. Between Treryn and Land's End, at the south-west, a majestic barrier of granite is presented to the sea. The beautiful Scilly Isles continue the line of the granite, and the intervening sea is said to have submerged a tract of land named Lyonesse, containing, according to tradition, 140 parish churches, and intimately connected with the Arthurian romances.

**Geology.**—One of the most striking features of Cornwall is the presence of the four great masses of granite which rise up and form as many elevated areas out of a lower-lying region occupied by rocks almost entirely slaty in character, generally known as "Killas." The granite is not the oldest of the Cornish rocks; these are found in the Lizard peninsula and are represented by serpentine, gabbro and metamorphic schists. With the exception of a small tract about Veryan and Gorran, of Ordovician age, all the sedimentary rocks, as far as a line joining Boscastle and South Petherwin, were formerly classed as Devonian; to the north of the line are the Culm measures—slates, grits and limestones—of Carboniferous age. The extensive spread of Killas is not, however, entirely Devonian, as it is shown on most maps. In the northern portion, Lower, Middle and Upper Devonian can be distinguished; the lower beds at Polperro, Looe and Watergate, the higher beds along the line indicated above. Farther south it has been shown that an older set of Palaeozoic rocks constitutes at least a part of the Killas; the Veryan series, with Caradoc fossils, is succeeded in descending order by the Portscatho series, the Falmouth series and the Mylor series; the lowest Devonian beds represented here by the Menaccan series, rest unconformably upon these Ordovician beds. Upper Silurian fossils have been found near Veryan. All these rocks have been subjected to severe thrusting from the south, consequently they are much contorted and folded. After this thrusting and folding had taken place, intrusions of diabase, &c., penetrated the sedimentary strata in numerous places, but it was not until post-Carboniferous times that the granite masses were intruded. The principal granite masses are those of St Just and Land's End, Penryn, St Austell and Bodmin Moor. To the granite Cornwall owes much of its prosperity; it has altered the Killas for some distance around each mass, and the veins of tin and copper ore, though richest in the Killas, are evidently genetically related to the granite. The principal metalliferous districts, Camborne, Redruth, St Just, &c., all lie near the granite margins. The china clay and china stone industry is dependent on the fact that the granite was itself altered in patches during the later phases of eruptive activity by the agency of boric and fluoric vapours which kaolinized the felspar of the granite. Later eruptions produced dykes of quartz-porphry and other varieties, all locally called "elvans," which penetrate both the granite and the Killas. Small patches of Pliocene strata are found at St Erth and St Agnes Beacon. Blown sand is an important feature at St Pirran, Lelant, Gwythian and elsewhere, and raised beaches are frequent round the coast. A characteristic Cornish deposit is the "Head," an old consolidated scree or talus. Many rare minerals have been obtained from the mines and much tin ore has been taken from the river gravels. The river gravel at Carnon has yielded native gold.

**Climate.**—The climate of Cornwall is peculiar. Snow seldom lies for more than a few days, and the winters are less severe than in any other part of England, the average temperature for January being 34° F. at Bude and 43·7° at Falmouth. The sea-winds, except in a few sheltered places, prevent timber trees from attaining to any great size, but the air is mild, and the lower vegetation, especially in the Penzance district, is almost southern in its luxuriance. Geraniums, fuchsias, myrtles, hydrangeas and camellias grow to a considerable size, and flourish through the winter at Penzance and round Falmouth; and in the Scilly Isles a great variety of exotics may be seen flourishing in the open air. Stone fruit, and even apples and pears, do not attain the same full flavour as in the neighbouring county, owing to the want of dry heat. The pinaster, the *Pinus*

*austriaca*, *Pinus insignis* and other firs succeed well in the western part of the county. All native plants display a perfection of beauty hardly to be seen elsewhere, and the furze, including the double-blossomed variety, and the heaths, among which *Erica vagans* and *ciliaris* are characteristic, cover the moorland and the cliff summits with a blaze of the richest colour. On the whole the climate is healthy, though the prevalent westerly and south-westerly winds, bringing with them great bodies of cloud from the Atlantic, render it damp; the mean annual rainfall, though only 32·85 in. at Bude, reaches 44·41 at Falmouth, and 50·57 at Bodmin.

**Agriculture.**—About seven-tenths of the total area is under cultivation, but oats form the only important grain-crop. Turnips, swedes and mangolds make up the bulk of the green crops. The number of cattle (chiefly of the Devonshire breed) is large, and many sheep are kept; nearly 60,000 acres of hill pasture being recorded. As regards agricultural produce, however, Cornwall is chiefly famous for the market-gardening carried on in the neighbourhood of Penzance, where the climate is specially suitable for the growth of early potatoes, broccoli and asparagus. These are despatched in large quantities to the London market; the Scilly Isles sharing in the industry. Fruit and flowers are also grown for the market. In the valleys the soil is frequently rich and deep; there are good arable and pasture farms, and the natural oak-wood of these coombes has been preserved and increased by plantation.

**Mining.**—The wealth of Cornwall, however, lies not so much in the soil, as underground and in the surrounding seas. Hence the favourite Cornish toast, "fish, tin and copper." The tin of Cornwall has been known and worked from a period anterior to certain history. There is no direct proof that the Phoenician traders came to Cornwall for tin; though it has been sought to identify the Cassiterides (*q.v.*) or Tin Islands with the county or the Scilly Isles. By ancient charters the "tanners" were exempt from all jurisdiction (save in cases affecting land, life and limb) other than that of the Stannary Courts, and peculiar laws were enacted in the Stannary parliaments (see STANNARIES). For many centuries a tax on the tin, after smelting, was paid to the earls and dukes of Cornwall. The smelted blocks were carried to certain towns to be coined, that is, stamped with the duchy seal before they could be sold. By an act of 1838 the dues payable on the coinage of tin were abolished, and a compensation was awarded to the duchy instead of them. The Cornish miners are an intelligent and independent body, and the assistance of a Cornishman has been found necessary to the successful development of mining in many parts of the world, while many miners have emigrated from Cornwall to more remunerative fields abroad. The industry has suffered from periods of depression, as before the accession of Queen Elizabeth, who introduced miners from Germany to resuscitate it; and in modern times the shallow workings, from which tin could be easily "streamed," have become practically exhausted. The deeper workings to which the miners must needs have recourse naturally render production more costly, and the competition of foreign mines has been detrimental. The result is that the industry is comparatively less prosperous than formerly, and employs far fewer of the inhabitants. However, in the district of Camborne, Carn Brea, Illogan and Redruth, and near St Just in the extreme west, the mines are still active, while there are others of less importance elsewhere, as near Callington in the south-east. And when, as in 1906, circumstances affecting the production of foreign mines cause a rise in the price of tin, the Cornish mines enjoy a period of greater prosperity; the result being the recent reopening of many of the mines which had been closed for twenty years. The largest tin-mine is that of Dolcoath near Camborne. Copper is extracted at St Just and at Carn Brea; but the output has decreased much further than that of tin. As it lies deeper in the earth, and consequently could not be "streamed" for, it was almost unnoticed in the county until the end of the 15th century, and little attention was paid to it until the last years of the 17th. No mine seems to have been worked exclusively for copper before the year 1770; and up to that time the casual produce had been

bought by Bristol merchants, to their great gain, at rates from £2:10s. to £4 per ton. In 1718 John Coster gave a great impulse to the trade by draining some of the deeper mines, and instructing the men in an improved method of dressing the ore. The trade thereafter progressively increased, and in 1851 the mines of Devon and Cornwall together were estimated to furnish one-third of the copper raised throughout Europe, including the British Isles. Antimony ores and manganese are found, and some lead occurs, being worked without great result. Iron in lodes, as brown haematite, has been worked near Lostwithiel and elsewhere. In the St Austell district the place of tin and copper mining has been taken by that of the raising and preparation of china clay. Granite is largely quarried in various districts, as at Luxulian (between St Austell and Lostwithiel), and in the neighbourhood of Penryn. This is the material of London and Waterloo Bridges, the Chatham docks, and many other great works. It is for the most part coarse-grained, though differing greatly in different places in this respect. Fine slate is quarried and largely exported, as from the Delabole quarries near Tintagel. These slates were in great repute in the 16th century and earlier. Serpentine is quarried in the Lizard district, and is worked there into small ornamental objects for sale to visitors; it is in favour as a decorative stone. Pitchblende also occurs, and is mined for the extraction of radium.

**Fisheries.**—The fisheries of Cornwall and Devon are the most important on the south-west coasts. The pilchard is in great measure confined to Cornwall, living habitually in deep water not far west of the Scilly Isles, and visiting the coast in great shoals, —one of which is described as having extended from Mevagissey to the Land's End, a distance, including the windings of the coast, of nearly 100 m. In summer and autumn pilchards are caught by drift nets; later in the year they are taken off the northern coast by seine nets. Forty thousand hogsheads, or 120 million fish, have been taken in the course of a single season, requiring 20,000 tons of salt to cure them. Twelve millions have been taken in a single day; and the sight of this great army of fish passing the Land's End, and pursued by hordes of dog-fish, hake, and cod, besides vast flocks of sea-birds, is most striking. The principal fishing stations are on Mount's Bay and at St Ives, but boats are employed all along the coast. When brought to shore the pilchards are carried to the cellars to be cured. They are then packed in hogsheads, each containing about 2400 fish. These casks are largely exported to Naples and other Italian ports —whence the fisherman's toast, "Long life to the pope, and death to thousands." Besides pilchards, mackerel and herring are taken in great numbers, and conger eels of great size; mullet and John Dory may be mentioned. There is also a trade in "sardines," young pilchards taking the place of the real Mediterranean fish.

**Communications.**—The principal ports are Falmouth and Penzance, but that of Hayle is of some importance, and there are large engineering works here. It lies on the estuary of the Hayle river, which opens into St Ives Bay, the township of Phillack adjoining on the north-east. A brisk coasting trade is maintained at many small ports along the coast. Communications are provided chiefly by the Great Western railway, the main line of which passes through the county and terminates at Penzance. Fowey, Penryn and Falmouth, and Helston on the south, and Bodmin and Wadebridge, Newquay and St Ives, are served by branch lines. A light railway runs from Liskeard to Looe. The north-eastern parts of the county (Launceston, Bude, Wadebridge) are served by the London & South-Western railway. Coaches are run in several districts during the summer, and in some parts, as in the neighbourhood of Penzance, and between Helston and the Lizard, the Great Western company provides a motor-car service to places beyond the reach of the railway. Many of the small seaside towns have become favourite holiday resorts, such as Bude, Newquay and St Ives, and the south-coast ports.

**Population and Administration.**—The area of the ancient county is 868,220 acres, with a population in 1891 of 322,571, and in 1901 of 322,334. In 1861 the population was 369,390, and had shown an increase up to that census. The area of the adminis-

trative county is 886,384 acres. The county contains 9 hundreds. The municipal boroughs are Bodmin (pop. 5353), the county town; Falmouth (11,789), Helston (3088), Launceston (4053), Liskeard (4010), Lostwithiel (1331), Penryn (3190), Penzance (13,136), St Ives (6699), Saltash (3357), Truro (11,562), an episcopal city. The other urban districts are Callington (1714), Camborne (14,726), Hayle (1084), Looe (2548), Ludgvan (2274), Madron (3486), Newquay (3115), Padstow (1566), Paul (6332), Phillack (3881), Redruth (10,451), St Austell (3340), St Just (5646), Stratton and Bude (2308), Torpoint (4200), Wadebridge (2186). Small market and other towns, beyond those in the above lists, are numerous. Such are Calstock in the east, St Germans in the south-east near Saltash, St Blazey near St Austell, Camelford, St Columb Major, and Perranzabuloe in the north, with the mining towns of Gwennap and Illogan in the Redruth district and Wendron near Helston, all inland towns; while on the south coast may be mentioned Fowey and Mevagissey, on either side of St Austell Bay, and Marazion on Mount's Bay, close by St Michael's Mount. Cornwall is in the western circuit, and assizes are held at Bodmin. It has one court of quarter sessions, and is divided into 17 petty sessional divisions. The boroughs of Bodmin, Falmouth, Helston, Launceston, Liskeard, Penryn, Penzance, St Ives and Truro have separate commissions of the peace, and Penzance has a separate court of quarter sessions. The Scilly Isles are administered by a separate council, and form one of the petty sessional divisions. There are 239 civil parishes, of which 5 are in the Scilly Isles. Cornwall is in the diocese of Truro, and there are 227 ecclesiastical parishes or districts wholly or in part within the county. The parliamentary divisions are the North-Eastern or Launceston, South-Eastern or Bodmin, Mid or St Austell, Truro, North-Western or Camborne, and Western or St Ives, each returning one member; while the parliamentary borough of Penryn and Falmouth returns one member.

**Language.**—The old Cornish language survives in a few words still in use in the fishing and mining communities, as well as in the names of persons and places, but the last persons who spoke it died towards the end of the 18th century. It belonged to the Cymric division of Celtic, in which Welsh and Armorican are also included. The most important relics of the language known to exist are three dramas or miracle plays, edited and translated by Edwin Norris, Oxford, 1859. A sketch of Cornish grammar is added, and a Cornish vocabulary from a MS. of the 13th century (Cotton MSS. Vespasian A. 14, p. 7a). (See *CELT: Language and Literature*.) It may be mentioned that the great numbers of saints whose names survive in the topography of the county are largely accounted for by the fact that here, as in Wales, it was the practice to canonize the founder of a church. The natives have many traits in common with the Welsh, such as their love of oratory and their strong tribal attachment to the county.

**History.**—Cornwall was the last portion of British territory in the south to submit to the Saxon invader. Viewed from its eastern boundary it doubtless appeared less attractive than the rich, well-wooded lands of Wessex, while it unquestionably afforded greater obstacles in the way of conquest. In 815 Ecgbert directed his efforts towards the subjugation of the West-Welsh of Cornwall, and after eight years' fighting compelled the whole of Dyvnaint to acknowledge his supremacy. Assisted by the Danes the Cornish revolted but were again defeated, probably in 836, at the battle of Hengestesdun, Hingston Down in Stoke-Climsland. Ninety years later Aethelstan banished the West-Welsh from Exeter and made the Tamar the boundary of their territory. The thoroughness of the Saxon conquest is evident from the fact that in the days of the Confessor nearly the whole of the land in Cornwall was held by men bearing English names. As the result of the Norman conquest less than one-twelfth of the land (exclusive of that held by the Church) remained in English hands. Six-sevenths of the manors were assigned to Robert, count of Mortain, and became the foundation of the territorial possessions and revenues of the earldom which was held until 1337, usually by special grant, by the sons or



near relatives of the kings of England. On the death of John of Eltham the last earl, in 1337, Edward the Black Prince was created duke of Cornwall. By the terms of the statute under which the dukedom was created the succession was restricted to the eldest son of the king, but in 1613, on the death of Prince Henry, an extended interpretation, given by the king's advisers, enabled his brother Charles (afterwards Charles I.) to succeed as son of the king and next heir to the realm of England.

Traces of jurisdictional differentiation anterior to Domesday survive in the names of at least five of the hundreds, although these names do not appear in the Survey itself. The hundreds into which the county was divided at the time of the *Inquisitio Geldi* were as follows:—Straton, which embraced the present hundreds of Stratton, Lesnewth and Trigg; Fawiton, approximately coterminous with West; Panton, now included in Pycasr, Tibeste, Wineton, Conarditon and Rileston, very nearly identical with Powder, Kerrier, Penwith and East. The shire court was held at Launceston except from about 1260 to 1386, when it was held at Lostwithiel. In 1716 the summer assize was transferred to Bodmin. Since 1836 both assizes have been held at Bodmin. The jurisdiction of the hundred courts became early attached to various manors, and their bailiwicks and bedellaries descended with the real estate of their owners. There is much obscurity concerning the early ecclesiastical organization. It is certain, however, that Cornwall had its own bishops from the middle of the 9th century until the year 1018, when the see was removed to Crediton. During the interval the see had been placed sometimes at Bodmin and sometimes at St Germans. In 1049 the see of the united dioceses of Devon and Cornwall was fixed at Exeter. Cornwall was formed into an archdeaconry soon after, and, as such, continued until 1876, when it was reconstituted a diocese with its see at Truro. The parishes of St Giles-on-the-Heath, North Petherwin and Werrington, wholly in Devon, and Boyton, partly in Devon and partly in Cornwall, which were portions of the ancient archdeaconry, and also the parishes of Broadwoodwidge and Virginstowe, both in Devon, which had been added to it in 1875, thus came to be included in the Truro diocese. The present archdeaconries of Bodmin embracing the eastern, and of Cornwall embracing the western portion of the newly constituted diocese were formed, by order in council, in 1878. Aethelstan's enactment had doubtless roughly determined the civil boundary of the Celtic-speaking county. In 1386 disputes having arisen, a commission was appointed to determine the Cornish border between North Tamerton and Hornacot.

For the first four centuries after the Norman conquest the part played by Cornwall in England's political history was comparatively unimportant. In her final attempt in 1471 to restore the fortunes of the house of Lancaster, Queen Margaret received the active support of the Cornish, who, under Sir Hugh Courtenay and Sir John Arundell, accompanied her to the fatal field of Tewkesbury, and in 1473 John de Vere, earl of Oxford, held St Michael's Mount in her behalf until the following February, when he surrendered to John Fortescue. A rising of considerable magnitude in 1497 at the instigation of Thomas Flamank, occasioned by the levy of a tax for the Scottish war, was only repelled after the arrival of the insurgents at Blackheath in Kent. Perkin Warbeck, who landed at Whitsand Bay in the parish of Sennen, obtained general support in the same year. The imposition of the Book of Common Prayer and the abrogation of various religious ceremonies led to a rebellion in 1549 under Sir Humphry Arundell of Lanherne, the rebels, who knew little English, demanding the restoration of the Latin service, but a fatal delay under the walls of Exeter led to their early defeat and the execution of their leaders. During the Civil War of the 17th century Cornwall won much glory in the royal cause. In 1643 Sir Ralph Hopton, who commanded the king's Cornish troops, defeated General Ruthen on Bradoc Down, while General Chudleigh, another parliamentary general, was repulsed near Launceston, and the earl of Stamford at Stratton. The whole county was thereby secured to the king. Led by Sir Beville Grenville of Stow the Cornish troops now marched into Somerset-

shire, where in the indecisive battle of Lansdowne they greatly distinguished themselves, but lost their brave leader. In July 1644 the earl of Essex marched into Cornwall and was followed soon afterwards by the king's troops in pursuit. Numerous engagements were fought, in which the latter were uniformly successful. The troops of Essex were surrounded and their leader escaped in a boat from Fowey to Plymouth. In 1646, owing to dissensions amongst the king's officers, and in particular to the refusal of Sir Richard Grenville to serve under Lord Hopton, and to the defection of Colonel Edgcumbe, the royal cause declined and became desperate. On the 16th of August 1646 articles of capitulation were signed by the defenders of Pendennis Castle.

Two members for the county were summoned by Edward I. to the parliament of 1295, and two continued to be the number of county members until 1832. Six boroughs—Launceston, Liskeard, Lostwithiel, Bodmin, Truro and Helston—were granted the like privilege by the same sovereign. To strengthen and augment the power of the crown as against the House of Commons, between 1547 and 1584, fifteen additional towns and villages received the franchise, with the result that, between the latter date and 1821, Cornwall sent no less than forty-four members to parliament. In 1821 Grampond lost both its members, and by the Reform Act in 1832 fourteen other Cornish boroughs shared the same fate. Cornwall was, in fact, notorious for the number of its rotten boroughs. In the vicinity of Liskeard "within an area, which since 1885 . . . is represented by only one member, there were until 1832 nine parliamentary boroughs returning eighteen members. In this area, on the eve of the Reform Act, there was a population of only 14,224" (Porrit, *Unreformed House of Commons*, vol. i. p. 92). Bossiney, a village near Camelford, Camelford itself, Lostwithiel, East Looe, West Looe, Fowey and several others were disfranchised in 1832, but even until the act of 1885 Bodmin, Helston, Launceston, Liskeard and St Ives were separately represented, whereas Penzance was not. Until this act was passed Truro, and Penryn with Falmouth, returned two members each.

*Antiquities.*—No part of England is so rich as Cornwall in prehistoric antiquities. These chiefly abound in the district between Penzance and the Land's End, but they occur in all the wilder parts of the county. They may be classed as follows. (1) *Cromlechs*. These in the west of Cornwall are called "quoits," with reference to their broad and flat covering stones. The largest and most important are those known as Lanyon, Mulfra, Chûn and Zennor quoits, all in the Land's End district. Of these Chûn is the only one which has not been thrown down. Zennor is said to be the largest in Europe, while Lanyon, when perfect, was of sufficient height for a man on horseback to ride under. Of those in the eastern part of Cornwall, Trevethy near Liskeard and Pawton in the parish of St Breock are the finest. (2) Rude uninscribed *monoliths* are common to all parts of Cornwall. Those at Boleigh or Boleit, in the parish of St Buryan, S.W. of Penzance, called the Pipers, are the most important. (3) *Circles*, none of which is of great dimensions. The principal are the Hurlers, near Liskeard; the Boskednan, Boscawen-ûn, and Tregeseal circles; and that called the Dawns-ûn, or Merry Maidens, at Boleigh. All of these, except the Hurlers, are in the Land's End district. Other circles that may be mentioned are the Trippet Stones, in the parish of Blisland, near Bodmin, and one at Duloe, near Liskeard. (4) Long *alignments* or *avenues* of stones, resembling those on Dartmoor, but not so perfect, are to be found on the moors near Rough Tor and Brown Willy. A very remarkable monument of this kind exists in the neighbourhood of St Columb Major, called the Nine Maidens. It consists of nine rude pillars placed in a line, but now imperfect, while near them is a single stone known as the Old Man. (5) *Hut dwellings*. Of these there are at least two kinds, those in the eastern part of the county resembling the beehive structures and enclosures of Dartmoor, and those in the west comprising "hut-clusters," having a central court, and a surrounding wall sometimes of considerable height and thickness. The beehive masonry is also found in connexion with these, as are also (6) *Caves*, or

subterranean structures, resembling those of Scotland and Ireland. (7) *Cliff castles* are a characteristic feature of the Cornish coast, especially in the west, such as Treryn, Mên, Kenedjack, Bosigran and others. These are all fortified on the landward side. At Treryn Castle is the Logan Stone, a mass of granite so balanced as to rock upon its support. (8) *Hill castles*, or camps, are very numerous. Castelan-Dinas, near St Columb, is the best example of the earthwork camp, and Chûn Castle, near Penzance, of the stone.

Early Christian remains in Cornwall include crosses, which occur all over the country and are of various dates from the 6th century onward; inscribed sepulchral stones, generally of the 7th and 8th centuries; and oratories. These last have their parallels in Ireland, which is natural, since from that country and Wales Cornwall was christianized. The buildings (also called baptisteries) are very small and rude, a simple parallelogram in form, always placed near a spring. The best example is St Piran's near Perranzabuloe, which long lay buried in sand dunes. St Piran was one of the missionaries sent from Ireland by St Patrick in the 5th century, and became the patron saint of the tin-miners.

The individuality of Cornwall is reflected in its ecclesiastical architecture. The churches are generally massive, plain structures of granite, built as it were to resist the storms which sweep up from the sea, low in the body, but with high unadorned towers. Within, a common feature is the absence of a chancel arch. In a few cases, of which Gwennap church is an illustration, where the body of the church lies low in a valley, there is a detached campanile at a higher level. The prevalent style is Perpendicular, much rebuilding having taken place in this period, but there are fine examples of the earlier styles. The west front and part of the towers of the church of St Germanus of Auxerre at St Germans form the best survival of Norman work in the county; there are good Norman doorways at Manaccan and Kilkhampton churches, and the church of Morwenstow, near the coast north of Bude, is a remarkable illustration of the same style. This church has the further interest of having had as its rector the Cornish poet Robert Stephen Hawker (1803-1875). The Early English style is not commonly seen, but the small church of St Anthony in Roseland, near the east shore of Falmouth harbour (with an ornate Norman door), and portions of the churches of Camelford and Manaccan, are instances of this period. Decorated work is similarly scanty, but the churches of Sheviock, in the south-east, and St Columb Major have much that is good, and that of St Bartholomew, Lostwithiel, has a beautiful and rich lantern and spire in this style surmounting an Early English tower, while the body of the church is also largely Decorated. Perpendicular churches are so numerous that it is only needful to mention those possessing some peculiar characteristic. Thus, the high ornamentation of Launceston and St Austell churches is unusual in Cornwall, as is the rich and graceful tower of Probus church. St Neot's church, near Liskeard, has magnificent stained glass of the 15th and 16th centuries.

The ruined castles of Launceston, Trematon near Saltash, Restormel near Lostwithiel, and Tintagel, date, at least in part, from Norman times. St Michael's Mount was at once a fortress and an ecclesiastical foundation. Pendennis Castle, Falmouth, is of the time of Henry VIII. The mansions of Cornwall are generally remarkable rather for their position than for architectural interest, but Trelawne, partly of the 15th century, near Looe, and Place House, a Tudor building, at Fowey, may be noted.

**AUTHORITIES.**—See Richard Carew, *Survey of Cornwall* (London, 1602); W. Borlase, *Antiquities of Cornwall* (Oxford, 1754 and 1769); D. Gilbert, *Parochial History of Cornwall* (London, 1837-1838), incorporating collections of W. Hals and Tonkin; J. T. Blight, *Ancient Crosses in the East of Cornwall* (London, 1858), and *Churches of West Cornwall* (London, 1865); G. C. Boase and W. P. Courtney, *Bibliotheca Cornubiensis*, a catalogue of the writings, both MS. and printed, of Cornishmen, and of works relating to Cornwall (Truro and London, 1864-1881); R. Hunt, *Popular Romances and Drolls of the West of England* (London, 1865); W. Bottrell, *Traditions and Hearthside Stories of West Cornwall* (Penzance, 1870-1873); J. H. Collins, *Handbook to the Mineralogy of Cornwall and Devon* (Truro,

1871); W. C. Borlase, *Naenia Cornubiae* (1872); *Early Christianity in Cornwall* (London, 1893); J. Bannister, *Glossary of Cornish Names* (London, 1878); W. P. Courtney, *Parliamentary Representation of Cornwall to 1832* (London, 1889); G. C. Boase, *Collectanea Cornubiensis* (Truro, 1890); J. R. Allen, *Old Cornish Crosses* (Truro, 1896); A. H. Norway, *Highways and Byways in Cornwall* (1904); Lewis Hind, *Days in Cornwall* (1907); *Victoria County History, Cornwall*.

**CORNWALLIS, CHARLES CORNWALLIS, 1st MARQUESS** (1738-1805), eldest son of Charles, 1st earl of Cornwallis (1700-1762), was born on the 31st of December 1738. Having been educated at Eton and St John's College, Cambridge, he entered the army. For some time he was member of parliament for Eye; in 1761 he served a campaign in Germany, and was gazetted to a lieutenant-colonelcy in the 12th Foot. In 1762 he succeeded to the earldom and estates of his father; in 1765 he was made aide-de-camp to the king and gentleman of the bedchamber; in 1766 he obtained a colonelcy in the 33rd Foot; and in 1770 he was appointed governor of the Tower. In public life he was distinguished by independence of character and inflexible integrity; he voted without regard to party, and opposed the ministerial action against Wilkes and in the case of the American colonies. But when the American War of Independence broke out, he accompanied his regiment across the Atlantic, and served not without success as major-general. In 1780 he was appointed to command the British forces in South Carolina, and in the same year he routed Gates at Camden. In 1781 he defeated Greene at Guilford Court House, and made a destructive raid into Virginia; but he was besieged at Yorktown by French and American armies and a French fleet, and was forced to capitulate on the 19th of October 1781. With him fell the English cause in the United States. He not only escaped censure, however, but in 1786 received a vacant Garter, and was appointed governor-general of India and commander-in-chief in Bengal. As an administrator he projected many reforms, but he was interrupted in his work by the quarrel with Tippoo Sahib. In 1791 he assumed in person the conduct of the war and captured Bangalore; and in 1792 he laid siege to Seringapatam, and concluded a treaty with Tippoo Sahib, which stripped the latter of half his realm, and placed his two sons as hostages in the hands of the English. For the permanent settlement of the land revenue under his administration, see BENGAL. He returned to England in 1793, received a marquessate and a seat in the privy council, and was made master-general of the ordnance with a place in the Cabinet. In June 1798 he was appointed to the viceroyalty of Ireland, and the zeal with which he strove to pacify the country gained him the respect and good-will of both Roman Catholics and Orangemen. On the 17th of July a general amnesty was proclaimed, and a few weeks afterwards the French army under Humbert was surrounded and forced to surrender. In 1801 Cornwallis was replaced by Lord Hardwicke, and soon after he was appointed plenipotentiary to negotiate the treaty of Amiens (1802). In 1805 he was again sent to India as governor-general, to replace Lord Wellesley, whose policy was too advanced for the directors of the East India Company. He was in ill-health when he arrived at Calcutta, and while hastening up the country to assume command of the troops, he died at Ghazipur, in the district of Benares, on the 5th of October 1805. He was succeeded as 2nd marquess by his only son, Charles (1774-1823). On his death the marquessate became extinct, but the title of Earl Cornwallis passed to his uncle, James (1743-1824), who was bishop of Lichfield from 1781 until his death. His son and successor, James, the 5th earl, whose son predeceased him in 1835, died in May 1852, when the Cornwallis titles became extinct.

See W. S. Seton-Karr, *The Marquess Cornwallis, "Rulers of India"* series (1890).

**CORNWALLIS, SIR WILLIAM** (1744-1819), British admiral, was the brother of the 1st Marquess Cornwallis, governor-general of India. He was born on the 20th of February 1744, and entered the navy in 1755. His promotion was naturally rapid, and in 1766 he had reached post-rank. Until 1779 he held various commands doing the regular work of the navy in convoy. In that year he commanded the "Lion" (64) in the fleet of Admiral Byron. The "Lion" was very roughly handled in the battle

off Grenada on the 6th of July 1779, and had to make her way alone to Jamaica. In March 1780 he fought an action in company with two other vessels against a much superior French force off Monti Cristi, and had another encounter with them near Bermuda in June. The force he engaged was the fleet carrying the troops of Rochambeau to North America, and was too strong for his squadron of two small liners, two fifty-gun ships and a frigate. After taking part in the second relief of Gibraltar, he returned to North America, and served with Hood in the actions at the Basse Terre of St Kitts, and with Rodney in the battle of Dominica on the 12th of April 1782. Some very rough verses which he wrote on the action have been printed in Leyland's "*Brest-Papers*," published for the Navy Record Society, which show that he thought very ill of Rodney's conduct of the battle. In 1788 he went to the East Indies as commodore, where he remained till 1794. He had some share in the war with Tippoo Sahib, and helped to reduce Pondicherry. His promotion to rear-admiral dates from the 1st of February 1793, and on the 4th of July 1794 he became vice-admiral.

In the Revolutionary War his services were in the Channel. The most signal of them was performed on the 16th of June 1795, when he carried out what was always spoken of with respect as "the retreat of Cornwallis." He was cruising near Brest with four sail of the line and two frigates, when he was sighted by a French fleet of twelve sail of the line, and many large frigates commanded by Villaret Joyeuse. The odds being very great he was compelled to make off. But two of his ships were heavy sailers and fell behind. He was consequently overtaken, and attacked on both sides. The rearmost ship, the "*Mars*" (74), suffered severely in her rigging and was in danger of being surrounded by the French. Cornwallis turned to support her, and the enemy, impressed by a conviction that he must be relying on help within easy reach, gave up the pursuit. The action affords a remarkable proof of the moral superiority which the victory of the 1st of June, and the known efficiency of the crews, had given to the British navy. The reputation of Cornwallis was immensely raised, and the praise given him was no doubt the greater because he was personally very popular with officers and men. In 1796 he incurred a court-martial in consequence of a misunderstanding and apparently some temper on both sides, on the charge of refusing to obey an order from the Admiralty. He was practically acquitted. The substance of the case was that he demurred on the ground of health at being called upon to go to the West Indies, in a small frigate, and without "comfort." He became full admiral in 1799, and held the Channel command for a short interval in 1801 and from 1803 to 1806, but saw no further service. He was made a G.C.B. in 1815, and died on the 5th of July 1819. His various nicknames among the sailors, "*Billy go tight*," given on account of his rubicund complexion, "*Billy Blue*," "*Coachee*," and "*Mr Whip*," seem to show that he was regarded with more of affection than reverence.

See also Ralfe, *Nav. Biog.* i. 387; *Naval Chronicle*, vii. 1; Char-nock, *Biogr. Nav.* vi. 523.

**CORO**, a small city and the capital of the state of Falcón, Venezuela, 7 m. W. of La Vela de Coro (its port on the Caribbean coast), with which it is connected by rail, and 199 m. W.N.W. of Carácas. Pop. (1904, estimate) 9500. Coro stands on a sandy plain between the Caribbean and the Gulf of Venezuela, and near the isthmus connecting the peninsula of Paraguaná with the mainland. Its elevation above sea-level is only 105 ft., and its climate is hot but not unhealthy. The city is badly built, its streets are unpaved, and it has no public buildings of note except two old churches. Its water-supply is derived from springs some distance away. Coro is the commercial centre for an extensive district on the E. side of Lake Maracaibo and the Gulf of Venezuela, which exports large quantities of goat-skins, an excellent quality of tobacco, and some coffee, cacao, castor beans, timber and dyewoods. It was founded in 1527 by Juan de Ampués, who gave to it the name of Santa Ana de Coriana (afterwards corrupted to Santa Ana de Coro) in honour of the day and of the tribe of Indians inhabiting this locality. It was

also called Venezuela (little Venice) because of an Indian village on the gulf coast built on piles over the shallow water; this name was afterwards bestowed upon the province of which Coro was the capital. Coro was also made the chief factory of the Welsers, the German banking house to which Charles V. mortgaged this part of his colonial possessions, and it was the starting-point for many exploring and colonizing expeditions into the interior. It was made a bishopric in 1536, and for a time Coro was one of the three most important towns on the northern coast. The seat of government was removed to Carácas in 1578 and the bishopric five years later. Coro is celebrated in Venezuelan history as the scene of Miranda's first attempt to free his country from Spanish rule. It suffered greatly in the war which followed.

**COROMANDEL COAST**, a name formerly applied officially to the eastern seaboard of India approximately between Cape Calimere, in 10° 17' N., 79° 56' E., and the mouths of the Kistna river. The shore, which is low, is without a single good natural harbour, and is at all times beaten by a heavy sea. Communication with ships can be effected only by catamarans and flat-bottomed surf-boats. The north-east monsoon, which lasts from October till April, is exceedingly violent for three months after its commencement. From April till October hot southerly winds blow by day; at night the heat is tempered by sea-breezes. The principal places frequented by shipping are Pulicat, Madras, Sadras, Pondicherry, Cuddalore, Tranquebar, Nagore, and Negapatam. The name Coromandel is said to be derived from *Cholamandal*, the mandal or region of the ancient dynasty of the Chola. Its official use has lapsed.

**CORONA** (Lat. for "crown"), in astronomy, the exterior envelope of the sun, being beyond the photosphere and chromosphere, invisible in the telescope and unrecognized by the spectroscopist, except during a total eclipse (see SUN; ECLIPSE).

*Corona Borealis*, also known as the *Corona septentrionalis*, and the Northern Crown or Garland, is a constellation of the Northern hemisphere, mentioned by Eudoxus (4th cent. B.C.) and Aratus (3rd cent. B.C.). In the catalogues of Ptolemy, Tycho Brahe, and Hevelius, eight stars are mentioned; but recent uranographic surveys have greatly increased this number. The most interesting members are: *σ Coronae*, a binary consisting of a yellow star of the 6th magnitude, and a bluish star of the 7th magnitude; *R Coronae*, an irregular variable star; and *T Coronae* or *Nova Coronae*, a temporary or new star, first observed in 1866. *Corona Australis*, also known as *Corona meridionalis*, or the Southern Crown, is a constellation of the Southern hemisphere, mentioned by Eudoxus and Aratus. In Ptolemy's catalogue thirteen stars are described.

In physical science, coronae (or "glories") are the coloured rings frequently seen closely encircling the sun or moon. Formerly classified by the ancient Greeks with halos, rainbows, &c., under the general group of "meteors," they came to receive considerable attention at the hands of Descartes, Christiaan Huygens, and Sir Isaac Newton; but the correct explanation of coronae was reserved until the beginning of the 19th century, when Thomas Young applied the theories of the diffraction and interference of light to this phenomenon. Prior to Young, halos and coronae had not been clearly differentiated; they were both regarded as caused by the refraction of light by atmospheric moisture and ice, although observation had shown that important distinctions existed between these phenomena. Thus, while halos have certain definite radii, viz. 22° and 46°, the radii of coronae vary very considerably; also, halos are coloured red on the *inside*, whereas coronae are coloured red on the *outside* (see HALO).

It has now been firmly established, both experimentally and mathematically, that coronae are due to diffraction by the minute particles of moisture and dust suspended in the atmosphere, and the radii of the rings depend on the size of the diffracting particles. (See DIFFRACTION OF LIGHT.)

Other meteorological phenomena caused by the diffraction of light include the *antheia*, and the chromatic rings seen encircling shadows thrown on a bank of clouds, mist or fog. These appear-

ances differ from halos and coronae inasmuch as their centres are at the anti-solar point; they thus resemble the rainbow. The anthelia (from the Greek *ἀντι*, opposite, and *ἥλιος*, the sun) are coloured red on the inside, the outside being generally colourless owing to the continued overlapping of many spectra. The diameter increases with the size of the globules making up the mist. The chromatic rings seen encircling the "spectre of the Brocken" are similarly explained.

The blue colour of the sky (*q.v.*), supernumerary rainbows, and the gorgeous sunsets observed after intense volcanic disturbances, when the atmosphere is charged with large quantities of extremely minute dust particles (*e.g.* Krakatoa), are also explicable by the diffraction of light. (See DUST.)

See E. Mascart, *Traité d'optique* (1899-1903); J. Pernter, *Meteorologische Optik* (1902-1905).

In architecture, the term "corona" is used of that part of a cornice which projects over the bed mould and constitutes the chief protection to the wall from rain; it is always throated, and its soffit rises towards the wall. The term is also given to the apse or semicircular termination of the choir; as at Canterbury in the part called "Becket's crown." The large circular chandelier suspended in churches, of which the finest example is that given by Barbarossa at Aix-la-Chapelle, is often called a corona. The term is also used in botany of the crown-like appendage at the top of compound flowers, the diminutive being *coronule*.

**CORONACH** (a Gaelic word, from *comh*, with, and *ranach*, wailing), the lamentation or dirge for the dead which accompanied funerals in the Highlands of Scotland and in Ireland. The more usual term in Ireland is "keen" or "keening."

**CORONADO, FRANCISCO VASQUEZ DE** (c. 1500-c. 1545), Spanish explorer of the south-western part of the United States of America. He accompanied Antonio de Mendoza to New Spain in 1535; by a brilliant marriage, became a leading grandee, and in 1539 was appointed governor of the province of New Galicia. The report presented by Fray Marcos de Niza concerning the "Seven cities of Cibola" (now identified almost certainly with the Zuni pueblos of New Mexico) aroused great interest in Mexico; Melchior Diaz was sent late in 1539 to retrace Fray Marcos's route and report on his story; and an expedition under Coronado left Compostela for the "Seven Cities" in February 1540. This expedition consisted of a provision train and droves of live-stock; several hundred friendly Indians, Spanish footmen, and more than 250 horsemen. Coronado, with a part of this force, captured the "Seven Cities." The fabled wealth, however, was not there. In the autumn (1540) Coronado was joined by the rest of his army. Meanwhile exploring parties were sent out: Tusayan, the Hopi or Moki (Moqui) country of north-eastern Arizona, was visited; Garcia Lopez de Cardenas discovered and described the Grand Canyon of the Colorado; and expeditions were sent along the Rio Grande (Tuguez), where the army wintered. The Indians revolted but were put down. The army, reinspired by the tales of a plains-Indian slave<sup>1</sup> about vast herds of cows (bison) on the plains, and about an Eldorado called "Quivira" far to the N.E., started thither in April 1541, and, with a few horsemen, penetrated at least to what is now central Kansas. Here Coronado found a few permanent settlements of Indians; in October he was again on the Rio Grande; and in the spring of 1542 he led his followers home. Thereafter he practically disappears from history. The first description of the bison and the prairie plains, the first trustworthy account of the Zuni pueblos, the discovery of the Grand Canyon, a vast increase of the nominal dominion of Spain and Christianity (the priests did not return from Cibola), and a notable addition to geographical knowledge, which, however, was long forgotten, were the results of this expedition; which is, besides, for its duration and the vast distance covered, over mountains, desert and plains, one of the most remarkable expeditions in the history of American discovery. In connexion with it, in 1540, Hernando de Alarcon ascended the Gulf of California to its head and the Colorado river for a long distance above its mouth.

<sup>1</sup> He was later killed for deception, and confessed that the Pecos Indians induced him to lure Coronado to destruction.

All the essential sources with a critical narrative are available in G. P. Winship's *The Coronado Expedition* (in the 14th Report of the United States Bureau of Ethnology, for 1892-1893, Washington, 1896), except the *Tratado del descubrimiento de las Yndias y su conquista* of Juan Suarez de Peralta (written in the last third of the 16th century, republished at Madrid, 1878). See also especially Justo Zaragoza, *Noticias historicas de la Nueva España* (Madrid, 1878), the various writings of A. F. A. Bandelier (*q.v.*); General J. H. Simpson in Smithsonian Institution Report (Washington, 1869), with an excellent map; and Winship for a full bibliography. H. H. Bancroft's account in his *Pacific States* (vols. 5, 10, 12) is less authoritative.

**CORONATION** (Lat. *corona*, crown), a solemnity whereby sovereigns are inaugurated in office. In pre-Christian times in Europe the king or ruler, upon his election, was raised on a shield, and, standing upon it, was borne on the shoulders of certain of the chief men of the tribe, or nation, round the assembled people. This was called the *gyratio*, and it was usually performed three times. At its conclusion a spear was placed in the king's hand, and the diadem, a richly wrought band of silk or linen, which must not be confused with the crown (see CROWN AND CORONET), was bound round his forehead, as a token of regal authority. When Europe became Christian, a religious service of benediction was added to the older form, which, however, was not abandoned. Derived from the Teutons, the Franks continued the *gyratio*, and Clovis, Sigebert, Pippin and others were thus elevated to the royal estate. From a combination of the old custom with the religious service, the later coronation ceremonies were gradually developed. In the ceremonial procession of the English king from the Tower to Westminster (first abandoned at the coronation of James II.), in the subsequent elevation of the king into what was known as the marble chair in Westminster Hall, and in the showing of the king of France to the people, as also in the universal practice of delivering a sceptre to the new ruler, traces, it is thought, may be detected of the influence of the original function.

The added religious service was naturally derived from the Bible, where mention is frequently made, in the Old Testament, of the anointing and crowning of kings. The anointing of the king soon came to be regarded as the most important, if not essential, feature of the service. By virtue of the unction which he received, the sovereign was regarded, in the middle ages, as a *mixta persona*, in part a priest, and in part a layman. It was a strange theory, and Lyndwode, the great English canonist, is cautious as to it, and was content to say that it was the opinion of some people. It gained very wide acceptance, and the anointed sovereign was generally regarded as, in some degree, possessed of the priestly character. By virtue of the unction he had received, the emperor was made a canon of St John Lateran and of St Peter at Rome, and also of the collegiate church of Aachen, while the king of France was *premier chanoine* of the primatial church of Lyons, and held canonries at Embrun, Le Mans, Montpellier, St Pol-de-Léon, Lodève, and other cathedral churches in France. There are, moreover, trustworthy records that, on more than one occasion, a king of France, habited in a surplice and choir robes, took part with the clergy in the services of some of those churches. Martène quotes an order, which directs that at the imperial coronation at Rome, the pope ought to sing the mass, the emperor read the gospel, and the king of Sicily, or if present the king of France, the epistle. Nothing like this was known in England, and a theory, which has prevailed of late, that the English sovereign is, in a personal sense, canon of St David's, is based on a misconception. The canonry in question was attached to St Mary's College at St David's before the Reformation, and, at the dissolution of the college, became crown property, which it has remained ever since; but the king of England is not, and never was personally, a canon of St David's, nor did he ever perform any quasi-clerical function.

At first a single anointing on the head was the practice, but afterwards other parts of the body, as the breast, arms, shoulders and hands received the unction. From a very early period in the West three kinds of oil have been blessed each year on Maundy Thursday, the oil of the catechumens, the oil of the sick, and the chrism. The last, a compound of olive oil and

balsam, is only used for the most sacred purposes, and the oil of the catechumens was that used for the unction of kings. In France, however, a legend gained credence that, as a special sign of divine favour, the Holy Dove had miraculously descended from heaven, bearing a vessel (afterwards called the Sainte Ampoule), containing holy oil, and had placed it on the altar for the coronation of Clovis. A drop of oil from the Sainte Ampoule mixed with chrism was afterwards used for anointing the kings of France. Similarly the chrism was introduced into English coronations, for the first time probably at the coronation of Edward II. To rival the French story another miracle was related that the Virgin Mary had appeared to Thomas Becket, and had given him a vessel with holy oil, which at some future period was to be used for the sacring of the English king. A full account of this miracle, and the subsequent finding of the vessel, is contained in a letter written in 1318 by Pope John XXII. to Edward II. The chrism was used in addition to the holy oil. The king was first anointed with the oil, and then signed on the head with the chrism. In all other countries the oil of the catechumens was alone used. In consequence of the use of chrism the kings of England and France were thought to be able to cure scrofula by the imposition of their hands, and hence arose the practice in those countries of touching for the king's evil, as it was called. In England the chrism disappeared at the Reformation, but touching for the evil was continued till the accession of the house of Hanover in 1714.

The oldest of all existing rituals for the coronation of a king is contained in what is known as the Pontifical of Egbert, who was archbishop of York in the middle of the 8th century. The coronation service in it is entitled *Missa pro rege in die benedictionis ejus*, and the coronation ceremony is interpolated in the middle of the mass. After the Gospel the officiant recites some prayers of benediction, and then pours oil from a horn on the king's head, while the anthem "Zadok the priest," &c., is sung. After this the assembled bishops and nobles place a sceptre in the king's hands, while a form of intercessory benediction is recited. Then the staff (*baculus*) is delivered to him, and finally a helmet (*galea*) is set upon his head, the whole assembly repeating thrice "May King N. live for ever. Amen. Amen." The enthronement follows, with the kisses of homage and of fealty, and the mass, with special prayers, is concluded.

Another coronation service of Anglo-Saxon date bearing, but with no good reason, the name of Æthelred II., has also been preserved, and is of importance as it spread from England to the continent, and was used for the coronations of the kings of France. It differs from the Egbert form as the coronation precedes the mass, while the use of a ring, and the definite allusion to a crown (*corona* not *galea*) occur in it. Joined to it is the form for the coronation of a queen consort. It may have been used for the crowning of Harold and of William the Conqueror.

A third English coronation form, of the 12th century, bears the name of Henry I., but also without good reason. The ceremonial is more fully developed, and the king is anointed on the head, breast, shoulders and elbows. The royal mantle appears for the first time, as does the sceptre. The queen consort is to be crowned *secundum ordinem Romanum*, and the whole function precedes the mass.

The fourth and most important of all English coronation services is that of the *Liber Regalis*, a manuscript still in the keeping of the dean of Westminster. It was introduced in 1307, and continued in use till the Reformation, and, in an English translation and with the Communion service substituted for the Latin mass, it was used for the coronation of James I. In it the English coronation ceremonies reached their fullest development. The following is a bare outline of its main features:—

The ceremonies began the day before the coronation, the king being ceremonially conducted in a procession from the Tower of London to Westminster. There he reposed for the night, and was instructed by the abbot as to the solemn obligations of the kingly office. Early next morning he went to Westminster

Hall, and there, among other ceremonies, as *rex regnatorius* was elevated into a richly adorned seat on the king's bench, called the Marble Chair. Then a procession with the regalia was marshalled, and led into the abbey church, the king wearing a cap of estate on his head, and supported by the bishops of Bath and Durham. A platform with thrones, &c., having been previously prepared under the crossing, the king ascended it, and all being in order, the archbishop of Canterbury called for the Recognition, after which the king, approaching the high altar, offered a pall to cover it, and a pound of gold. Then a sermon appropriate to the occasion was preached by one of the bishops, the oath was administered by the archbishop, and the *Veni Creator* and a litany were sung. Then the king was anointed with oil on his hands, breast, between the shoulders, on the shoulders, on the elbows, and on the head; finally he was anointed with the chrism on his head. Thus blessed and anointed, the king was vested, first with a silk dalmatic, called the *colobium sindonis*, then a long tunic, reaching to the ankles and woven with great golden images before and behind, was put upon him. He then received the buskins (*caligae*), the sandals (*sandalia*), and spurs (*calcaria*), then the sword and its girdle; after this the stole, and finally the royal mantle, four-square in shape and woven throughout with golden eagles. Thus vested, the crown of St Edward was set on his head, the ring placed on his wedding finger, the gloves drawn over his hands, and the golden sceptre, in form of an orb and cross, delivered to him. Lastly, the golden rod with the dove at the top was placed in the king's left hand. Thus consecrated, vested and crowned, the king kissed the bishops who, assisted by the nobles, enthroned him, while the *Te Deum* was sung. When a queen consort was also crowned, that ceremony immediately followed, and the mass with special collect, epistle, gospel and preface was said, and during it both king and queen received the sacrament in one kind. At the conclusion the king retired to a convenient place, surrounded with curtains, where the great chamberlain took off certain of the robes, and substituted others for them, and the archbishop, still wearing his mass vestments, set other crowns on the heads of the king and queen, and with these they left the church.

This service, in English, was used at the coronation of James I., Elizabeth having been crowned with the Latin service. Little change was made till 1685, when it was considerably altered for the coronation of James II. The Communion was necessarily omitted in the case of a Roman Catholic, but other changes were introduced quite needlessly by Archbishop Sancroft, and four years later the old order was still more seriously changed, with the result that the revisions of 1685 and 1689 have grievously mutilated the service, by confusing the order of its different sections, while the meaning of the prayers has been completely changed for no apparent reason. Alterations since then have been verbal rather than essential, but at each subsequent coronation some feature has disappeared, the proper preface having been abandoned at the coronation of Edward VII.

In connexion with the English coronation a number of claims to do certain services have sprung up, and before each coronation a court of claims in constituted, which investigates and adjudicates on the claims that are made. The most striking of all these services is that of the challenge made by the king's champion, an office which has been hereditary in the Dymoke family for many centuries. Immediately following the service in the church a banquet was held in Westminster Hall, during the first course of which the champion entered the hall on horseback, armed *cap-à-pie*, with red, white and blue feathers in his helmet. He was supported by the high constable on his right, and the earl marshal on his left, both of whom were also mounted. On his appearance in the hall a herald in front of him read the challenge, the words of which have not materially varied at any period, as follows: "If any person, of what degree soever, high or low, shall deny or gainsay our sovereign lord . . . , king of the United Kingdom of Great Britain and Ireland, defender of the faith (son and), next heir unto our sovereign lord the last king deceased, to be the right heir to the imperial crown of this realm of Great Britain and Ireland, or that he ought not to enjoy the same; here is his



champion, who saith that he lieth, and is a false traitor, being ready in person to combat with him; and in this quarrel will adventure his life against him, on what day soever he shall be appointed." The champion then threw down the gauntlet. The challenge was again made in the centre of the hall, and a third time before the high table, at which the king was seated. The king then drank to the champion out of a silver-gilt cup, with a cover, which he handed to him as his fee. The banquet was last held, and the challenge made, at the coronation of George IV. in 1821. The champion's claim was admitted in 1902, but as there was no banquet the duty of bearing the standard of England was assigned to him. There is no record of the challenge having been ever accepted.

The revival of the western empire under Charlemagne was marked by his coronation by the pope at Rome in the year 800. His successors, for several centuries, went to Rome, where they received the imperial crown in St Peter's from the pope, the crown of Lombardy being conferred in the church of St Ambrose (Sant' Ambrogio) at Milan, that of Burgundy at Arles, and the German crown, which came to be the most important of all, most commonly at Aix-la-Chapelle. It must suffice to speak of the coronations at Rome and Aix-la-Chapelle. From Martène we learn the early form of the ceremony at Rome. The emperor was met at the silver door of St Peter's, where the first coronation prayer was recited over him by the bishop of Albano. He was then conducted within the church, where *in medio rotæ majoris*, the bishop of Porto said the second prayer. Thence the emperor went to the confessio of St Peter, where the litany was said, and there, or before the altar of St Maurice, the bishop of Ostia anointed him on the right arm and between the shoulders. Then he ascended to the high altar, where the pope delivered the naked sword to him. This he flourished, and then sheathed in its scabbard. The pope then delivered the sceptre to the emperor, and placed the crown on his head. The ceremony was concluded by the coronation mass said by the pope. The custom of the emperors going to Rome to be crowned was last observed by Frederick III. in 1440, and after that the German coronation was alone celebrated. The form followed was mainly thus: the electors first met at Frankfurt, under the presidency of the elector-archbishop of Mainz, and, the election having been made, the emperor was led to the high altar of the cathedral and seated at it. He was then conducted to a gallery over the entrance to the choir, where, seating himself with the electors, proclamation was made of the election, and on a subsequent day the coronation took place. If the coronation was performed, as it most commonly was, at Aix-la-Chapelle, then the archbishop of Cologne, as diocesan, was the chief officiant, and the emperor was presented to him by the two other clerical electors, the archbishops of Mainz and Trier. The emperor was anointed on the head, the nape of the neck, the breast, the right arm between the wrist and the elbow, and on the palms of both hands. After this, he was vested in what were called the imperial and pontifical robes, which included the buskins, a long alb, the stole crossed priest-wise over the breast, and the mantle. The regalia were then delivered to him, and the crown was set on his head conjointly by the three archbishop-electors. Mass was then said, during which the emperor communicated in one kind. When the coronation was performed at Aix-la-Chapelle, the emperor was at once made, at its conclusion, a canon of the church.

The coronation form in France bore much resemblance, in its general features, to the English coronation, and was, it is believed originally based on the English form. The unction was given, first on the top of the head in the form of a cross, on the breast, between the shoulders, and at the bending and joints of both arms. Then, standing up, the king was vested in the dalmatic, tunic and royal robe, all of purple velvet sprinkled with fleurs-de-lys of gold, and representing, it was said, the three orders of subdeacon, deacon and priest. Then, kneeling again, he was anointed in the palms of the hands, after which the gloves, ring and sceptre were delivered. Then the peers were summoned by name to come near and assist, and the archbishop of Reims, taking the crown of Charlemagne from the altar, set it on the king's head. After

which the enthronement, and showing of the king to the people, took place. All the unctions were made with the chrism, mixed with a drop of oil from the Sainte Ampoule. After the enthronement, mass was said, and at its conclusion the king communicated in both kinds. The third day after the coronation, the king touched for the evil.

On the "11 Frimaire an 13" Napoleon and Josephine were jointly crowned at Paris, by the pope. Napoleon entered Notre-Dame wearing a crown, and before him were carried the imperial ornaments, to wit: "*la couronne de l'empereur, l'épée, la main de justice, le sceptre, le manteau de l'empereur, son anneau, son collier, le globe impérial, la couronne de l'impératrice, son manteau, son anneau.*" Each of these was blessed, and delivered with a benediction to the emperor and empress, kneeling, side by side, to receive them, both having previously received the unction on the head and on each hand. Napoleon placed the crown on his head himself. Mass with special prayers followed.

In Spain the coronation ceremony never assumed the fullness, or magnificence, that might have been expected. It was usually performed at Toledo, or in the church of St Jerome at Madrid, the king being anointed by the archbishop of Toledo. The royal ornaments were the sword, sceptre, crown of gold and the apple of gold, which the king himself assumed after the unction. In recent years the unction and coronation have been disused.

In Sweden the king was anointed and crowned at Upsala by the archbishop. The ceremony is now performed in the Storkyrka, at Stockholm, where the archbishop of Upsala anoints the king on the breast, temples, forehead and palms of both hands. The crown is placed on the king's head by the archbishop and the minister of justice jointly, whereupon the state marshal proclaims: "Now is crowned king of the Swedes, Goths and Wends, he and no other." When there is a queen consort, she is then anointed, crowned and proclaimed, in the same manner.

In Norway, according to the law of 1814, the coronation is performed in the cathedral at Trondhjem, when the Lutheran superintendent, or bishop, anoints the king. The crown is placed on the king's head jointly by the bishop and the prime minister.

In Russia the coronation is celebrated at Moscow, and is full of religious significance. The tsar is anointed by the metropolitan, but places the crown on his head himself. He receives the sacrament among the clergy, the priestly theory of his office being recognized. In some other European countries the coronation ceremony, as in Austria and Hungary, is also performed with much significant ritual. In other countries, as Prussia, it is retained in a modified form; but in the remaining states such as Denmark, Belgium, Italy, &c., it has been abandoned, or never introduced.

**AUTHORITIES.**—L. G. Wickham Legg, *English Coronation Records*; Roxburgh Club—*Liber Regalis*; Anon., *A Complete Account of the Ceremonies observed in the Coronations of the Kings and Queens of England* (London, 1727); F. Sandford, *Description of the Coronation of James II.* (1687); Menin, *The Form, Order and Ceremonies of Coronations*, trans. from the French (1727); Martène, *De Antiquis Ecclesiae Ritibus*, lib. ii. (T. M. F.)

**CORONER**, an ancient officer of the English common law, so called, according to Coke, because he was a *keeper* of the pleas of the crown (*custos placitorum coronae*). At what period the office of coroner was instituted is a matter of considerable doubt; some modern authorities (Stubbs, *Select Charters*, 260; Pollock and Maitland, *Hist. Eng. Law*, i. 519) date its origin from 1194, but C. Gross (*Political Science Quarterly*, vol. vii.) has shown that it must have existed before that date. The office was always elective, the appointment being made by the freeholders of the county assembled in county court. By the Statute of Westminster the First it was ordered that none but lawful and discreet knights should be chosen as coroners, and in one instance a person was actually removed from office for insufficiency of estate. Lands to the value of £20 per annum (the qualification for knighthood) were afterwards deemed sufficient to satisfy the requirements as to estate which ought to be insisted on in the case of a coroner. The complaint of Blackstone shows the transition of the office from its original dignified and honorary

character to a paid appointment in the public service. "Now, indeed, through the culpable neglect of gentlemen of property, this office has been suffered to fall into disrepute, and get into low and indigent hands; so that, although formerly no coroners would condescend to be paid for serving their country, and they were by the aforesaid Statute of Westminster expressly forbidden to take a reward, under pain of a great forfeiture to the king; yet for many years past they have only desired to be chosen for their perquisites; being allowed fees for their attendance by the statute 3 Henry VII. c. 1, which Sir Edward Coke complains of heavily; though since his time those fees have been much enlarged." The mercenary character of the office, thus deprecated by Coke and Blackstone, is now firmly established, without, however (it need hardly be said), affording the slightest ground for such reflections as the above. The coroner is in fact a public officer, and like other public officers receives payment for his services. The person appointed is almost invariably a qualified legal or medical practitioner; how far one is a more "fit person" than another has frequently been a matter of dispute—a Bill of 1879, which, however, failed to pass, decided in favour of the legal profession. The property qualification for a county coroner ("having land in fee sufficient in the same county whereof he may answer to all manner of people," 14 Ed. III. st. 1, c. 8), although re-enacted in the Coroners Act 1887, is now virtually dispensed with. The appointment is for life, but is vacated by the holder being made sheriff. A coroner may be removed by the writ *de coronatore exonerando*, for sufficient cause assigned, or the lord chancellor may, if he thinks fit, remove any coroner from his office for inability or misbehaviour in the discharge of his duty.

Coroners are of three kinds: (1) coroners by virtue of their office, *e.g.* the lord chief justice of the king's bench is the principal coroner of England; the puisne judges of the king's bench are sovereign coroners—they may exercise their jurisdiction within any part of the realm, even in the verge<sup>1</sup> or other exempt liberties or franchises; (2) coroners by charter or commission, *e.g.* in certain liberties and franchises coroners are appointed by the crown or by lords holding a charter from the crown; (3) coroners by virtue of election, *e.g.* county and borough coroners. County coroners in England were, until 1888, elected by the freeholders, but by the Local Government Act 1888 the appointment was given to the county council, who may appoint any fit person, not being a county alderman or county councillor, to fill the office. By an act of 1860 the system of payment by fees, established by an act of 1843, was abolished and payment made by salary calculated on the average amount of the fees, mileage, and allowances usually received by the coroner for a period of five years, and the calculation revised every five years. In boroughs having a separate court of quarter sessions, and whose population exceeds 10,000, the coroner is appointed by the town council and is paid by fees. A county coroner must reside within his district or not more than two miles out of it. Deputy coroners are also appointed in both counties and boroughs, and the law relating to their appointment is contained in the Coroners Act 1892. The duties of a coroner were ascertained by 4 Edward I. st. 2:—"A coroner of our Lord the king ought to inquire of these things, first, when coroners are commanded by the king's bailiffs or by the honest men of the county, they shall go to the places where any be slain, or suddenly dead or wounded, or where houses are broken, or where treasure is said to be found, and shall forthwith command four of the next towns, or five, or six, to appear before him in such a place; and when they are come thither, the coroner upon the oath of them shall inquire in this manner, that is, to wit, if it concerns a man slain, if they know when the person was slain, whether it were in any house, field, bed, tavern, or company, and if any, and

<sup>1</sup> *Coroner of the Verge*.—The verge comprised a circuit of 12 m. round the king's court, and the coroner of the king's house, called the coroner of the verge, has jurisdiction within this radius. By the Coroners Act 1887 the jurisdiction of the verge was abolished and became absorbed in that of the county, but the appointment of the king's coroner was left with the lord steward, while his jurisdiction was limited to the precincts of the palace.

who, were there, &c. It shall also be inquired if the dead person were known, or else a stranger, and where he lay the night before. And if any person is said to be guilty of the murder, the coroner shall go to their house and inquire what goods they have, &c." Similar directions were given for cases of persons found drowned or suddenly dead, for attachment of criminals in cases of violence, &c. His functions are now, by the Coroners Act 1887, limited to an inquiry upon "the dead body of a person lying within his jurisdiction, where there is reasonable cause to suspect that such person has died either a violent or an unnatural death, or has died a sudden death of which the cause is unknown, or that such person has died in prison, or in such place or under such circumstances as to require an inquest in pursuance of any act" (s. 3), and upon treasure-trove (s. 36). The inquisition must be *super visum corporis* (that is, after "viewing the body"); the evidence is taken on oath; and any party suspected may tender evidence. The Coroners Act 1887, s. 21, gives power to the coroner to summon medical witnesses and to direct the performance of a post-mortem examination. The verdict must be that of twelve at least of the jury. If any person is found guilty of murder or other homicide, the coroner shall commit him to prison for trial; he shall also certify the material evidence to the court, and bind over the proper persons to prosecute or to give evidence at the trial. He may in his discretion accept bail for a person found guilty of manslaughter. Since the abolition of public executions, the coroner is required to hold an inquest on the body of any criminal on whom sentence of death has been carried into effect. The duty of coroners to inquire into treasure-trove (*q.v.*) is still preserved by the Coroners Act 1887, which, however, repealed certain other jurisdictions, as,—inquests of royal fish (whale, sturgeon) thrown ashore or caught near the coast; inquest of wrecks, and of felonies, except felonies on inquisitions of death. By the City of London Fire Inquests Act 1888 the duty is imposed upon the coroner for the city to hold inquests in cases of loss or injury by fire in the city of London and the liberties thereof situated in the county of Middlesex. This is a practice which exists in several European countries.

In Scotland the duties of a coroner are performed by an officer called a procurator-fiscal.

In the United States and in most of the colonies of Great Britain the duties of a coroner are substantially the same. In some cases his duties are more enlarged, his inquisition embracing the origin of fires; in others they are confined to holding inquests in cases of suspicious deaths. Unlike a coroner in England, he is elected generally only for a specified period.

**AUTHORITIES.**—Jervis, *Office and Duties of Coroners* (6th ed., 1898); R. H. Wellington, *The King's Coroner* (2 vols., 1905–1906). In 1908 a committee was appointed to inquire into the law relating to coroners and coroners' inquests and into the practice in coroners' courts. (T. A. I.)

**CORONIUM**, that constituent (otherwise unknown) of the sun's corona, which emits the characteristic green coronal ray, of which the wave-length is 5303.

**COROT, JEAN-BAPTISTE CAMILLE** (1796–1875), French landscape painter, was born in Paris, in a house on the Quai by the rue du Bac, now demolished, on the 26th of July 1796. His family were well-to-do bourgeois people, and whatever may have been the experience of some of his artistic colleagues, he never, throughout his life, felt the want of money. He was educated at Rouen and was afterwards apprenticed to a draper, but hated commercial life and despised what he called its "business tricks," yet he faithfully remained in it until he was twenty-six, when his father at last consented to his adopting the profession of art. Corot learned little from his masters. He visited Italy on three occasions: two of his Roman studies are now in the Louvre. He was a regular contributor to the Salon during his lifetime, and in 1846 was "decorated" with the cross of the Legion of Honour. He was promoted to be officer in 1867. His many friends considered nevertheless that he was officially neglected, and in 1874, only a short time before his death, they presented him with a gold medal. He died in Paris, on the 22nd of February 1875, and was buried at Père Lachaise.

Of the painters classed in the Barbizon school it is probable

that Corot will live the longest, and will continue to occupy the highest position. His art is more individual than Rousseau's, whose works are more strictly traditional; more poetic than that of Daubigny, who is, however, Corot's greatest contemporary rival; and in every sense more beautiful than J. F. Millet, who thought more of stern truth than of aesthetic feeling.

Corot's works are somewhat arbitrarily divided into periods, but the point of division is never certain, as he often completed a picture years after it had been begun. In his first style he painted traditionally and "tight"—that is to say, with minute exactness, clear outlines, and with absolute definition of objects throughout. After his fiftieth year his methods changed to breadth of tone and an approach to poetic power, and about twenty years later, say from 1865 onwards, his manner of painting became full of "mystery" and poetry. In the last ten years of his work he became the Père Corot of the artistic circles of Paris, in which he was regarded with personal affection, and he was acknowledged as one of the five or six greatest landscape painters the world has ever seen, along with Hobbema, Claude, Turner and Constable. During the last few years of his life he earned large sums by his pictures, which became greatly sought after. In 1871 he gave £2000 for the poor of Paris (where he remained during the siege), and his continued charity was long the subject of remark. Besides landscapes, of which he painted several hundred, Corot produced a number of figure pictures which are much prized. These were mostly studio pieces, executed probably with a view to keep his hand in with severe drawing, rather than with the intention of producing pictures. Yet many of them are fine in composition, and in all cases the colour is remarkable for its strength and purity. Corot also executed a few etchings and pencil sketches. In his landscape pictures Corot was more traditional in his method of work than is usually believed. If even his latest tree-painting and arrangement are compared with such a Claude as that which hangs in the Bridgewater gallery, it will be observed how similar is Corot's method and also how masterly are his results.

The works of Corot are scattered over France and the Netherlands, Great Britain and America. The following may be considered as the first half-dozen: "Une Matinée" (1850), now in the Louvre; "Macbeth" (1859), in the Wallace collection; "Le Lac" (1861); "L'Arbre brisé" (1865); "Pastorale—Souvenir d'Italie" (1873), in the Glasgow Corporation Art Gallery; "Bibliis" (1875). Corot had a number of followers who called themselves his pupils. The best known are Boudin, Lepine, Chintreuil, Français and Le Roux.

**AUTHORITIES.**—H. Dumesnil, *Souvenirs intimes* (Paris, 1875); Roger-Milès, *Les Artistes célèbres: Corot* (Paris, 1891); Roger-Milès, *Album classique des chefs-d'œuvres de Corot* (Paris, 1895); J. Rousseau, *Bibliothèque d'art moderne: Camille Corot* (Paris, 1884); J. Claretie, *Peintres et sculpteurs contemporains: Corot* (Paris, 1884); Ch. Bigot, *Peintres français contemporains: Corot* (Paris, 1888); Geo. Moore, *Ingres and Corot in Modern Painting* (London, 1893); David Croal Thomson, *Corot* (4to, London, 1892); Mrs Schuyler van Rensselaer, "Corot," *Century Magazine* (June 1889); Corot, *The Portfolio* (1870), p. 60, (1875) p. 146; R. A. M. Stevenson, "Corot as an Example of Style in Painting," *Scottish Art Review* (Aug. 1888); Ethel Birnstigl and Alice Pollard, *Corot* (London, 1904); Alfred Robaut, *L'Œuvre de Corot, catalogue raisonné et illustré, précédé de l'histoire de Corot et de ses œuvres par Étienne Morceau-Nélaton* (Paris, 1905). (D. C. T.)

**CORPORAL.** 1. (From Lat. *corporalis*, belonging to the *corpus* or body), an adjective appearing in several expressions, such as "corporal punishment" (see below), or in "corporal works of mercy," for those acts confined to the succouring of the bodily needs, such as feeding the hungry, visiting the sick, rescuing captives. A "corporal oath" was sworn with the body in contact with a sacred object (see OATH).

2. (From Lat. *corporalis*, sc. *palla*, or *corporale*, sc. *pallium*), in the Roman Catholic Church, a small square linen cloth, which at the service of the Mass is placed on the altar under the chalice and paten. It was originally large enough to cover the whole surface of the altar, and was folded over so as to cover the chalice—a custom still observed by the Carthusians. The chalice is now, however, covered by another small square of linen, stiffened with

cardboard, &c., known as the pall (*palla*). When not in use both corporal and pall are carried in a square silken pocket called the burse. The corporal must be blessed by the bishop, or by a priest with special faculties, the ritual prayers invoking the divine blessing that the linen may be worthy to cover and enwrap the body and blood of the Lord. It represents the winding-sheet in which Joseph of Arimathea wrapped the body of the dead Christ.

3. (Of uncertain derivation; the French form *caporal*, and Ital. *caporale*, point to an origin from *capo*, Italian for head; the *New English Dictionary*, however, favours the derivation from Lat. *corpus*, Ital. *corpo*, body), a non-commissioned officer of infantry, cavalry and artillery, ranking below a sergeant. This rank is almost universal in armies. In the 16th and 17th centuries there were corporals but no sergeants in the cavalry, and this custom is preserved in the three regiments of British household cavalry, the rank of sergeant being replaced by that of "corporal of horse," and that of sergeant-major by "corporal-major." In the 16th and early 17th centuries the title "corporal of the field" was often given to a superior officer who acted as a staff-officer to the sergeant-major-general. In the navy the "ship's corporal," formerly a semi-military instructor to the crew, is now a petty officer charged with assisting the master-at-arms in police duties on board ship.

**CORPORAL PUNISHMENT**, chastisement inflicted by one person on the body (*corpus*) of another. By the common law of England, Scotland and Ireland, the infliction of corporal punishment is illegal unless it is done in self-defence or in defence of others, or is done either by some person having punitive authority over the person chastised or under the authority of a competent court of justice. Corporal punishment in defence of self or others needs no comment, except that, like all other acts done in defence, its justification depends on whether or not it was reasonably necessary for the protection of the person attacked. Among persons invested with punitive authority, mention must first be made of parents and guardians, and of teachers, who have, by implied delegation from the parents, and as incidental to the relation of master and pupil, powers of reasonable corporal punishment. Such powers are not limited to offences committed by the pupil upon the premises of the school, but extend to acts done on the way to and from school and during what may be properly regarded as school hours (*Cleary v. Booth*, 1893, 1 Q.B. 465). The rights of parents, guardians and teachers, in regard to the chastisement of children, were expressly recognized in English law by the Prevention of Cruelty to Children Act 1904 (§ 28). Poor law authorities and managers of reformatories are in the same position in this respect as teachers. The punitive authority of elementary school teachers is subject to the regulations of the education authority: that of poor law authorities to the regulation of the Home Office and the Local Government Board. A master has a right to inflict moderate chastisement upon his apprentice for neglect or other misbehaviour, provided that he does so himself, and that the apprentice is under age (*Archbold, Cr. Pl.*, 23rd ed., 795). Where a legal right of chastisement is exercised immoderately, the person so exercising it incurs both civil and criminal liability.

In some of the older English legal authorities (e.g. Bacon, *Abridg. tit. "Baron and Feme," B*), it was stated that a husband might inflict moderate corporal punishment on his wife in order to keep her "within the bounds of duty." But these authorities were definitely discredited in 1891 in the case of *R. v. Jackson* (1 Q.B. 671). By the unmodified Mahomedan law, a husband may administer moderate corporal punishment to his wife; but it is doubtful whether this right could be legally exercised in British India (*Wilson, Digest of Anglo-Mahomedan Law*, 2nd ed., pp. 153, 154). In Hawkins's *Pleas of the Crown* (Bk. 1, c. 63, § 29) it is laid down that "churchwardens, and perhaps private persons, may whip boys playing in church" during divine service. But while the right to remove such offenders is undoubted, the right of castigation could not now safely be exercised. At common law the master of a ship is entitled to inflict reasonable chastisement on a seaman for gross breach of

duty. But such offences are now specially provided for by the Merchant Shipping Act 1894 (§§ 220-238); and where the provisions of that statute are available, corporal punishment would probably be illegal.

As to corporal punishment in the army and navy, see articles MILITARY LAW; NAVY. In civil prisons, whether they are convict prisons or local prisons, corporal punishment may not be inflicted except under sentence of a competent court, or except in the case of prisoners under sentence of penal servitude, or convicted of felony, or sentenced to hard labour, who have been guilty of mutiny or incitement to mutiny, or of gross personal violence to an officer or servant of the prison (Act of 1898, § 5). Flogging for these offences in prison may not be inflicted except by order of the board of visitors or visiting committee of the prison, made at a meeting specially constituted, and confirmed by a secretary of state (Prison Act of 1898, § 5; Convict Prison Rules 1899; Stat. R. and O. 1899, No. 321, rr. 77-79; Local Prison Rules 1899; Stat. R. and O. 1899, No. 322, rr. 84, 85). The mode of inflicting the punishment is prescribed by the Convict Prison Rules (rr. 82-85) and the Local Prison Rules (rr. 88-91), which limit the number of strokes and prescribe the instrument to be used for inflicting them, the cat or birch for prisoners over 18, and the birch for prisoners under 18.

Corporal punishment for breaches of prison discipline in Scottish prisons is not authorized by any statute nor under the Scottish Prison Rules (see *Stat. R. and O. Revised*, ed. 1904, vol. x. tit. "Prison, Scotland," p. 60). In Irish convict prisons corporal punishment may be inflicted by order of justices specially appointed by the lord-lieutenant under § 3 of the Penal Servitude Act 1864, but the Irish Prison Rules of 1902 (Stat. R. and O. 1902, No. 590) contain no reference to this power.

At common law, courts of justice had jurisdiction to impose a sentence of whipping on persons convicted on indictment for petty larceny or misdemeanours of the meaner kind (see 1 Bishop, *Amer. Cr. Law*, 8th ed., § 942). But they do not now impose such sentence except under statutory authority. The whipping of women was absolutely prohibited in 1820 by the Whipping of Female Offenders Abolition Act of that year. But there are numerous statutes authorizing the imposition of a sentence of whipping on male offenders. The following cases may be noted. 1. *Adults*: (a) who are incorrigible rogues (Vagrancy Act 1824, § 10); (b) who discharge fire-arms, &c., with intent to injure or alarm the sovereign (Treason Act 1842, § 2, and see 8 St. Tr. N.S. 1, and *O'Connor's Case*, 1872, *ib.* p. 3 n.); (c) who are guilty of robbery with violence (Larceny Act 1861, § 43), or offences against § 21 of the Offences against the Person Act of 1861; there has been much controversy as to whether the Garrotters Act of 1861, which authorized the ordering of more than one whipping in the case of an offender over 16 years of age, was the effective cause of the diminution of the offences against which it was directed, but the best judicial opinion is in the affirmative. 2. *Males under sixteen*: (a) in any of the cases above noted; (b) for many statutory offences, e.g. larceny (Larceny Act 1861), malicious damage (Malicious Damage Act 1861, § 75; Criminal Law Amendment Act 1885, § 4); (c) by courts of summary jurisdiction (Summary Jurisdiction Act 1879, §§ 10, 11, and 1899; First Offenders Act 1887); if a boy is over 7 and under 12, not more than 6 strokes, if he is over 12, but under 14, not more than 12 strokes may be inflicted; the birch-rod is to be used, and the punishment is to be given by a police constable in the presence of a superior officer, and of the parent or guardian if he desire it.

In Scotland the whipping of male offenders under 14 is regulated by the Prisons (Scotland) Act 1860, § 74, the Whipping Act 1862, and § 514 of the Burgh Police (Scotland) Act 1892; and offenders over 16 may not be whipped for offences against person or property (Whipping Act 1862, § 2).

In Ireland the law is in substance the same as in England; for special statutes see official *Index to Statutes* (ed. 1905), p. 985, art. Punishment, 6.

The flogging of women is prohibited throughout British India (Code of Criminal Procedure, Act v. of 1898, § 393) and the British colonies, where the infliction of corporal punishment by judicial order is in the main regulated on the lines of modern English legislation. In some British colonies the list of offences punishable by whipping is larger than in England (see Queensland Criminal Code 1899, arts. 212, 213, 216).

In the United States whipping is not a legal punishment under the Federal Law (Revised Stats. U.S. § 5327). But in some of the states of the Union whipping is inflicted under statute, and is not held cruel or unusual within the Federal Constitution (1 Bishop,

*Amer. Crim. Law*, 8th ed., § 947). In Delaware wife-beating and certain offences against property by males are punishable with flogging; and in Maryland the same punishment is applicable for wife-beating. Flogging is in force as a disciplinary measure in some penal institutions.

It has been suggested by Laurent (*Principes de droit civil français* (1870), vol. iv. § 275) that the express definition in the French Code Civil (arts. 371 et seq.) of parental rights over children excludes the power of corporal punishment. But this view is not generally accepted. The parental right of moderate chastisement is expressly reserved in the Civil Code of Spain (art. 155, 2). Flogging is not recognized as a legal punishment by the French Code Pénal, nor by the Penal Codes of Germany, Italy, Spain or Portugal. (See also WHIPPING OR FLOGGING.)

(A. W. R.)

**CORPORATION** (from Lat. *corporare*, to form into a body, *corpus*, *corporis*), in English law, an association of persons which is treated in many respects as if it were itself a person. It has rights and duties of its own which are not the rights and duties of the individual members thereof. Thus a corporation may own land, but the individual members of the corporation have no rights therein. A corporation may owe money, but the corporators as individuals are under no obligation to pay the debt. The rights and duties descend to the successive members of the corporation. This capacity of perpetual succession is regarded as the distinguishing feature of corporations as compared with other societies. One of the phrases most commonly met with in law-books describes a corporation as a society with perpetual succession and a common seal. The latter point, however, is not conclusive of the corporate character.

The legal attributes of a corporation have been worked out with great fulness and ingenuity in English law, but the conception has been taken full-grown from the law of Rome. The term in Roman law corresponding to the modern corporation is *collegium*; a more general term is *universitas*. A *collegium* or *corpus* must have consisted of at least three persons, who were said to be *corporati—habere corpus*. They could hold property in common and had a common chest. They might sue and be sued by their agent (*syndicus* or *actor*). There was a complete separation in law between the rights of the *collegium* as a body and those of its individual members. The *collegium* remained in existence although all its original members were changed. It was governed by its own by-laws, provided these were not contrary to the common law. The power of forming *collegia* was restrained, and societies pretending to act as corporations were often suppressed. In all these points the *collegia* of Roman law closely resemble the corporations of English law. There is a similar parallel between the purposes for which the formation of such societies is authorized in English and in Roman law. Thus among the Roman *collegia* the following classes are distinguished:—(1) Public governing bodies, or municipalities, *civitates*; (2) religious societies, such as the *collegia* of priests and Vestal Virgins; (3) official societies, e.g. the *scribae*, employed in the administration of the state; (4) trade societies, e.g. *fabri*, *pictores*, *navicularii*, &c. This class shades down into the *societates* not incorporated, just as our own trading corporations partake largely of the character of ordinary partnerships. In the later Roman law the distinction of corporations into civil and ecclesiastical, into lay and eleemosynary, is recognized. The latter could not alienate without just cause, nor take land without a licence—a restriction which may be compared with modern statutes of mortmain. All these privileged societies are what we should call *corporations aggregate*. The *corporation sole* (i.e. consisting of only a single person) is a later refinement, for although Roman law held that the corporation subsisted in full force, notwithstanding that only one member survived, it did not impute to the successive holders of a public office the character of a corporation. When a public officer in English law is said to be a corporation sole, the meaning is that the rights acquired by him in that capacity descend to his successor in office, and not (as the case is where a public officer is not a corporation) to his ordinary legal representative. The best known instances of

corporation sole are the king and the parson of a parish. The conception of the king as a corporation is the key to many of his paradoxical attributes in constitutional theory—his invisibility, immortality, &c.

The term *quasi-corporation* is applied to holders for the time being of certain official positions, though not incorporated, as the churchwardens of a parish, guardians of the poor, &c.

The Roman conception of a corporation was kept alive by ecclesiastical and municipal bodies. When English lawyers came to deal with such societies, the corporation law of Rome admitted of easy application. Accordingly, in no department has English law borrowed so copiously and so directly from the civil law. The corporations known to the earlier English law were mainly the municipal, the ecclesiastical, and the educational and eleemosynary. To all of these the same principles, borrowed from Roman jurisprudence, were applied. The different purposes of these institutions brought about in course of time differences in the rules of the law applicable to each. In particular, the great development of trading companies under special statutes has produced a new class of corporations, differing widely from those formerly known to the law. The reform of municipal corporations has also restricted the operation of the principles of the older corporation law. These principles, however, still apply when special statutes have not intervened.

The legal origin of corporation is ascribed by J. Grant (*Treatise on the Law of Corporations*, 1850) to five sources, viz. common law, prescription, act of parliament, charter and implication. Prescription in legal theory implies a grant, so that corporations by prescription would be reducible to the class of chartered or statutory corporations. A corporation is said to exist by implication when the purposes of a legally constituted society cannot be carried out without corporate powers. Corporations are thus ultimately traceable to the authority of charters and acts of parliament. The power of creating corporations by charter is an important prerogative of the crown, but in the present state of the constitution, when all the powers of the crown are practically exercised by parliament, there is no room for any jealousy as to the manner in which it may be exercised. The power of chartering corporations belonged also to subjects who had *jura regalia*, e.g. the bishops of Durham granted a charter of incorporation to the city of Durham in 1565, 1602 and 1780. The charter of a corporation is regarded as being of the nature of a contract between the king and the corporation. It will be construed more favourably for the crown, and more strictly as against the grantee. It cannot alter the law of the land, and it may be surrendered, so that, if the surrender is accepted by the crown and enrolled in chancery, the corporation is thereby dissolved. Great use was made of this power of the crown in the reigns of Charles II. and James II.

Every corporation, it is said, must have a name, and it may have more names than one, but two corporations cannot have the same name. And corporations cannot change their name save by charter or some equivalent authority.

The possession of a common seal, though, as already stated, not conclusive of the corporate character, is an incident of every corporation aggregate. The inns of courts have common seals, but they are only voluntary societies, not corporations. Generally speaking, all corporate acts affecting strangers must be performed under the common seal; acts of internal administration affecting only the corporators, need not be under seal. The rule has been defended as following necessarily from the impersonal character of a corporation; either a seal or something equivalent must be fixed upon so that the act of the corporation may be recognized by all.

A corporation may be abolished by statute, but not by the mere authority of the crown. It may also become extinct by the disappearance of all its members or of any integral part, by surrender of charter if it is a chartered society, by process of law, or by forfeiture of privileges.

The power of the majority to bind the society is one of the first principles of corporation law, even in cases where the corporation has a head. It is even said that only by an

act of parliament can this rule be avoided. The binding majority is that of the number present at a corporate meeting duly summoned.

In corporations which have a head (as colleges), although the head cannot veto the resolution of the majority, he is still considered an integral part of the society, and his death suspends its existence, so that a head cannot devise or bequeath to the corporation, nor can a grant be made to a corporation during vacancy of the headship.

A corporation has power to make such regulations (by-laws) as are necessary for carrying out its purposes, and these are binding on its members and on persons within its local jurisdiction if it has any.

The power to acquire and hold land was incident to a corporation at common law, but its restriction by the statutes of mortmain dates from a very early period. The English law against mortmain was dictated by the jealousy of the feudal lords, who lost the services they would otherwise have been entitled to, when their land passed into the hands of a perpetual corporation. The vast increase in the estates of ecclesiastical corporations constituted by itself a danger which might well justify the operation of the restricting statutes.

The Mortmain Acts applied only to cases of alienation *inter vivos*. There was no power to devise lands by will until 32 Henry VIII. c. 1 (1540), and when the power was granted corporations were expressly excluded from its benefits. No devise to a corporation, whether for its own use or in trust, was allowed to be good; land so devised went to the heir, either absolutely or charged with the trusts imposed upon it in the abortive devise. A modification, however, was gradually wrought by the judicial interpretations of the Charitable Trusts Act 1601, and it was held that a devise to a corporation for a charitable purpose might be a good devise, and would stand unless voided by the Mortmain Acts; so that no corporation could take land, without a licence, for any purpose or in any way; and no localised corporation could take lands by devise, save for charitable purposes. Then came the act of 1736, commonly but improperly called the Mortmain Act. Its effect was generally to make it impossible for land to be left by will for charitable uses, whether through a corporation or a natural person.<sup>1</sup> The Wills Act 1837 did not renew the old provision against devises to corporations, which therefore fell under the general law of mortmain. The law was consolidated by the Mortmain and Charitable Uses Act 1888, and the result is simply that corporations cannot take land for any purpose without a licence, and no licence in mortmain is granted by the crown, except in certain statutory cases in the interests of religion, charity or other definite public object.

The power of corporations at common law to alienate their property is usually restricted, as is their power to lease it for more than a certain number of years, except by sanction of a public authority. The more important classes of corporations, however, are now governed by special statutes which exclude or modify the operation of the common law principles. The most considerable class of societies still unaffected by such special legislation are the Livery Companies (*q.v.*). Under COMPANY will be found an account of the important enactments regulating joint-stock companies.

The question to what extent the common law incidents of a corporation have been interfered with by special legislation has become one of much importance, especially under the acts relating to joint-stock companies. The most important case on this subject is that of *Riche v. The Ashbury Railway Carriage Company*, 1875 (L.R. 9 Ex. 224; L.R. 7 H.L. 653), in which, the judges of the exchequer chamber being equally divided, the decision of the court below was affirmed. The view taken by the affirming judges, viz. that the common law incidents of a corporation adhere unless expressly removed by the legislature, may be

<sup>1</sup> Devises to colleges are excepted from the operation of the act, but such devises must be for purposes identical with or closely resembling the original purposes of the college; and the exception from this act does not supersede the necessity for a licence in mortmain.



illustrated by a short extract from the judgment of Mr Justice Blackburn:—

"If I thought it was at common law an incident to a corporation that its capacity should be limited by the instrument creating it, I should agree that the capacity of a company incorporated under the act of 1862 was limited to the object in the memorandum of association. But if I am right in the opinion which I have already expressed, that the general power of contracting is an incident to a corporation which it requires an indication of intention in the legislature to take away, I see no such indication here. If the question was whether the legislature had conferred on a corporation, created under this act, capacity to enter into contracts beyond the provisions of the deed, there could be only one answer. The legislature did not confer such capacity. But if the question be, as I apprehend it is, whether the legislature have indicated an intention to take away the power of contracting which at common law would be incident to a body corporate, and not merely to limit the authority of the managing body and the majority of the shareholders to bind the minority, but also to prohibit and make illegal contracts made by the body corporate, in such a manner that they would be binding on the body if incorporated at common law, I think the answer should be the other way."

On the other hand, the House of Lords, agreeing with the three dissentient judges in the exchequer chamber, pronounced the effect of the Companies Act to be the opposite of that indicated by Mr Justice Blackburn. "It was the intention of the legislature, not implied, but actually expressed, that the corporations, should not enter, having regard to this memorandum of association, into a contract of this description. The contract in my judgment could not have been ratified by the unanimous assent of the whole corporation." In such companies, therefore, objects beyond the scope of the memorandum of association are *ultra vires* of the corporation. The doctrine of *ultra vires*, as it is called, is almost wholly of modern and judicial creation. The first emphatic recognition of it appears to have been in the case of companies created for special purposes with extraordinary powers, by act of parliament, and, more particularly, railway companies. The funds of such companies, it was held, must be applied to the purposes for which they were created, and no other. Whether this doctrine is applicable to the older or, as they are sometimes called, ordinary corporations, appears to be doubtful. S. Brice (*Ultra Vires*) writes:—

"Take, as a strong instance, a university or a London guild. Either can undoubtedly manage, invest, transform and expend the corporate property in almost any way it pleases, but if they proposed to exhaust the same on the private pleasures of existing members, or to abandon the promotion, the one of education, the other of their art and mystery, it is very probable, if not absolutely certain, that the court of chancery would restrain the same, as being *ultra vires*."

**CORPS** (pronounced as in French, from which it is taken, being a late spelling of *cors*, from Lat. *corpus*, a body; cf. "corpse"), a word in very general use since the 17th century to denote a body of troops, varying from a few hundred to the greater part of an army. In a special sense "corps" is used as synonymous with "army corps" (*corps d'armée*). The word is applied to any organized body, as in *corps diplomatique*, the general body of foreign diplomatic agents accredited to any government (see DIPLOMACY), or *corps de ballet*, the members of a troop of dancers at a theatre; so in *esprit de corps*, the common spirit of loyalty which animates any body of associated persons.

**CORPSE** (Lat. *corpus*, the body), a dead human body. By the common law of England a corpse is not the subject of property nor capable of holding property. It is not therefore larceny to steal a corpse, but any removal of the coffin or grave-cloths is otherwise, such remaining the property of the persons who buried the body. It is a misdemeanour to expose a naked corpse to public view, to prevent the burial of a dead body, or to disinter it without authority; also to bury or otherwise dispose of a dead body on which an inquest ought to be held, without giving notice to a coroner. Anyone who, having the means, neglects to bury a dead body which he is legally bound to bury, is guilty of a misdemeanour, but no one is bound to incur a debt for such a purpose. It is incumbent on the relatives and friends of a deceased person to provide Christian burial for him; failing relatives and friends, the duty devolves upon the parish. No corpse can be attached, taken in execution, arrested or detained

for debt. See further BODY-SNATCHING, and BURIAL AND BURIAL ACTS.

**CORPULENCE** (Lat. *corpus*, body), or OBESITY (Lat. *ob*, against, and *edere*, to eat), a condition of the animal body characterized by the over-accumulation of fat under the skin and around certain of the internal organs. In all healthy persons a greater or less amount of fat is present in these parts, and serves important physiological ends, besides contributing to the proper configuration of the body (see NUTRITION). Even a considerable measure of fatness, however inconvenient, is not inconsistent with a high degree of health and activity, and it is only when in great excess or rapidly increasing that it can be regarded as a pathological state (see METABOLIC DISEASES). The extent to which excess of fat may proceed is illustrated by numerous well-authenticated examples recorded in medical works, of which only a few can be here mentioned. Thus Bright, a grocer of Maldon, in Essex, who died in 1750, in his twenty-ninth year, weighed 616 lb. Dr F. Dancel (*Traité de l'obésité*, Paris, 1863) records the case of a young man of twenty-two, who died from excessive obesity, weighing 643 lb. In the *Philosophical Transactions* for 1813 a case is recorded of a girl of four years of age who weighed 256 lb. But the most celebrated case is that of Daniel Lambert (*q.v.*) of Leicester, who died in 1809 in his fortieth year. He is said to have been the heaviest man that ever lived, his weight being 739 lb (52 st. 11 lb). Health cannot be long maintained under excessive obesity, for the increase in bulk of the body, rendering exercise more difficult, leads to relaxation and defective nutrition of muscle, while the accumulations of fat in the chest and abdomen occasion serious embarrassment to the functions of the various organs in those cavities. In general the mental activity of the highly corpulent becomes impaired, although there have always been many notable exceptions to this rule.

Various causes are assigned for the production of corpulence (see METABOLIC DISEASES). In some families there exists an hereditary predisposition to an obese habit of body, the manifestation of which no precautions as to living appear capable of averting. But it is unquestionable that certain habits favour the occurrence of corpulence. A luxurious, inactive, or sedentary life, with over-indulgence in sleep and absence of mental occupation, are well recognized predisposing causes. The more immediate exciting causes are over-feeding and the large use of fluids of any kind, but especially alcoholic liquors. Fat persons are not always great eaters, though many of them are, while leanness and inordinate appetite are not infrequently associated. Still, it may be stated generally that indulgence in food, beyond what is requisite to repair daily waste, goes towards the increase of flesh, particularly of fat. This is more especially the case when the non-nitrogenous (the fatty, saccharine and starchy) elements of the food are in excess. The want of adequate bodily exercise will in a similar manner produce a like effect, and it is probable that many cases of corpulence are to be ascribed to this cause alone, from the well-known facts that many persons of sedentary occupation become stout, although of most abstemious habits, and that obesity frequently comes on in the middle-aged and old, who take relatively less exercise than the young, in whom it is comparatively rare. Women are more prone to become corpulent than men, and appear to take on this condition more readily after the cessation of the function of menstruation.

For the prevention of corpulence and the reduction of superfluous fat many expedients have been resorted to, and numerous remedies recommended. These have included bleeding, blistering, purging, starving (see FASTING), the use of different kinds of baths, and of drugs innumerable. The drinking of vinegar was long popularly, but erroneously, supposed to be a remedy for obesity. It is related of the marquis of Cortona, a noted general of the duke of Alva, that by drinking vinegar he so reduced his body from a condition of enormous obesity that he could fold his skin about him like a garment.

In 1863 a pamphlet entitled "Letter on Corpulence, Addressed to the Public by William Banting," in which was narrated the remarkable experience of the writer in accomplishing the reduction of his own weight in a short space of time by the adoption of a

particular kind of diet, started the modern dietetic treatment, at first called "Banting" after the author. After trying almost every known remedy without effect, Banting was induced, on the suggestion of Mr Harvey, a London aurist, to place himself upon an entirely new form of diet, which consisted chiefly in the removal, as far as possible, of all saccharine, starchy and fat food, the reduction of liquids, and the substitution of meat or fish and fruit in moderate quantity at each meal, together with the daily use of an antacid draught. Under this regimen his weight was reduced 46 lb in the course of a few weeks, while his health underwent a marked improvement. His experience, as might have been expected, induced many to follow his example; and since then various regimens have been propounded, all aiming at treating corpulence on modern physiological principles (see also DIETETICS, METABOLIC DISEASES and NUTRITION). It is important, however, to bear in mind that the treatment should be followed under medical advice and observation; for, however desirable it be to get rid of superabundant fat, it would be manifestly no gain were this to be achieved by the sacrifice of the general health.

**CORPUS CHRISTI**, a city and the county-seat of Nueces county, Texas, U.S.A., situated on Corpus Christi Bay opposite the mouth of the Nueces river, 192 m. W.S.W. of Galveston and about 150 m. S.S.E. of San Antonio. Pop. (1890) 4387; (1900) 4703, including 963 foreign-born and 460 negroes; (1910) 8299. It is served by the National of Mexico, the St Louis, Brownsville & Mexico, and the San Antonio & Aransas Pass railways. In 1908 the Federal government began work on a project to connect Corpus Christi harbour with Aransas Pass by a channel 8½ ft. deep at low water and 75 ft. wide at the bottom, following a natural depression between the two bays. Corpus Christi is a summer and winter resort, with a very dry equable climate (average annual mean, 70·2° F.) and good bathing on the horse-shoe beach of Corpus Christi Bay. The city has an extensive coasting trade, and exports fruit, early vegetables, fish and oysters. There was a small Spanish settlement here at an early date, but no American settlement was made until after the Mexican War. Corpus Christi was the base from which General Zachary Taylor made his forward movement to the Rio Grande in 1846. It was chartered as a city in 1876.

**CORPUS CHRISTI, FEAST OF** (Lat. *festum corporis Christi*, i.e. festival of the Body of Christ, Fr. *fête-Dieu* or *fête du sacrement*, Ger. *Frohnleichnamfest*), a festival of the Roman Catholic Church in honour of the Real Presence of Christ in the sacrament of the altar, observed on the first Thursday after Trinity Sunday. The doctrine of transubstantiation was defined by the Lateran Council in 1215, and shortly afterwards the elevation and adoration of the Host were formally enjoined. This naturally stimulated the popular devotion to the Blessed Sacrament, which had been already widespread before the definition of the dogma. The movement was especially strong in the diocese of Liège, and when Julienne, prioress of Mont-Cornillon near Liège (1222-1258), had a vision in which the need for the establishment of a festival in honour of the Sacrament was revealed to her, the matter was taken up with enthusiasm by the clergy, and in 1246 Robert de Torote, bishop of Liège, instituted such a festival for his diocese. The idea, however, did not spread until, in 1261, Jacob Pantaleon, archdeacon of Liège, ascended the papal throne as Urban IV. By a bull of 1264 Urban made the festival, hitherto practically confined to the diocese of Liège, obligatory on the whole Church,<sup>1</sup> and a new office for the festival was written by Thomas Aquinas himself. As yet the stress was laid on reverence for the Holy Sacrament as a whole; there is no mention in Urban's bull of the solemn procession and exposition of the Host for the adoration of the faithful, which are the main features of the festival as at present celebrated. Urban's bull was once more promulgated, at the council of Vienne in 1311, by

<sup>1</sup> The pope's decision, so the story goes, was hastened by a miracle. A priest, saying mass at the church of Santa Catarina at Bologna, was troubled, after the consecration, with grave doubts as to the truth of the doctrine of transubstantiation. His temptation was removed by the Host beginning to bleed, the blood soaking through the corporal *into* the marble of the altar.

Pope Clement V.; and the procession of the Host in connexion with the festival was instituted, if the accounts we possess are trustworthy, by Pope John XXII.

From this time onwards the festival increased in popularity and in splendour. It became in effect the principal feast of the Church, the procession of the Sacrament a gorgeous pageant, in which not only the members of the trade and craft guilds, with the magistrates of the cities, took part, but princes and sovereigns. It thus became in a high degree symbolical of the exaltation of the sacerdotal power.<sup>2</sup> In the 15th century the custom became almost universal of following the procession with the performance of miracle-plays and mysteries, generally arranged and acted by members of the guilds who had formed part of the pageant.

The rejection of the doctrine of transubstantiation at the Reformation naturally involved the suppression of the festival of Corpus Christi in the reformed Churches. Luther, in spite of his belief in the Real Presence, regarded it as the most harmful of all the mediæval festivals and, though he fully realized its popularity, it was the first that he abolished. This attitude of the reformers towards the festival, however, intensified by their abhorrence of the traffic in indulgences with which it had become closely associated, only tended to establish it more firmly among the adherents of the "old religion." The procession of the Host on Corpus Christi day became, as it were, a public demonstration of Catholic orthodoxy against Protestantism and later against religious Liberalism. In most countries where religious opinion is sharply divided the procession of Corpus Christi is therefore now forbidden, even when Catholicism is the dominant religion. In England occasional breaches of the law in this respect have been for some time tolerated, as in the case of the Corpus Christi procession annually held by the Italian community in London. An attempt to hold a public procession of the Host in connexion with the Eucharistic Congress at Westminster in 1908, however, was the signal for the outburst of a considerable amount of opposition, and was eventually abandoned owing to the personal intervention of the prime minister.

**CORRAL** (Span. from *corro*, a circle), a word used chiefly in Spanish America and the United States for an enclosure for cattle and horses, and also for a defensive circle formed of wagons against attacks from Indians. It is also used as a verb, meaning to drive into a corral, and so figuratively to enclose, hem in. The word is probably connected with the South African Dutch word *kraal* (q.v.). In Ceylon it is especially used for an enclosure meant for the capture of wild elephants. In this last sense of the word the corresponding term in India is *keddah* (q.v.).

**CORREA**, a genus of Australian plants belonging to the natural order Rutaceae, named after the Portuguese botanist José Francisco Correa da Serra. The plants are evergreen shrubs and extremely useful for winter flowering. They are increased by cuttings, and grown in a cool greenhouse in rough peaty soil, with a slight addition of loam and sand. After the plants have done flowering, they should all get a little artificial warmth, plenty of moisture, and a slight shade, while they are making their growth, during which period the tips of the young shoots should be nipped out when 6 or 8 in. long. When the growth is complete, a half-shady place outdoors during August and September will be suitable, with protection from parching winds and hot sunshine.

**CORREA DA SERRA, JOSÉ FRANCISCO** (1750-1823), Portuguese politician and man of science, was born at Serpa, in Alemtejo, in 1750. Educated at Rome, he took orders under the protection of the duke of Alafões, uncle of Mary I. of Portugal. In 1777 he returned to Lisbon, where he resided with his patron, with whose assistance he founded the Portuguese Academy of Sciences. Of this institution he was named perpetual secretary, and he received the privilege of publishing its transactions without reference to any censor whatever. His use of this right brought him into conflict with the Holy Office; and

<sup>2</sup> Nothing caused more offence to Liberal sentiment in France after the Restoration than the spectacle of King Louis XVIII. walking and carrying a candle in the procession through the streets of Paris.

consequently in 1786 he fled to France, and remained there till the death of Pedro III., when he again took up his residence with Alafoès. But having given a lodging in the palace to a French Girondist, he was forced to flee to England, where he found a protector in Sir Joseph Banks, and became a member of the Royal Society. In 1797 he was appointed secretary to the Portuguese embassy, but a quarrel with the ambassador drove him once more to Paris (1802), and in that city he resided till 1813, when he crossed over to New York. In 1816 he was made Portuguese minister-plenipotentiary at Washington, and in 1820 he was recalled home, appointed a member of the financial council, and elected to a seat in the Cortes. Three years after, and in the same year with the fall of the constitutional government, he died. Correa da Serra ranks high as a botanist, though he published no great special work. His principal claim to renown is the *Colecção de livros inéditos da historia Portugueza*, (4 vols., 1790-1816), an invaluable selection of documents, exceedingly well edited.

**CORREGGIO**, or **COREGGIO**, the name ordinarily given to Antonio Allegri (1494-1534), the celebrated Italian painter, one of the most vivid and impulsive inventors in expression and pose and the most consummate executants. The external circumstances of his life have been very diversely stated by different writers, and the whole of what has been narrated regarding him, even waiving the question of its authenticity, is but meagre.

The first controversy is as to his origin. Some say that he was born of poor and lowly parents; others, that his family was noble and rich. Neither account is accurate. His father was Pellegrino Allegri, a tradesman in comfortable circumstances, living at Correggio, a small city in the territory of Modena; his mother Bernardina Piazzoli degli Aromani, also of a creditable family of moderate means. Antonio was born at Correggio, and was carefully educated. He was not (as has been often alleged) strictly self-taught in his art—a supposition which the internal evidence of his pictures must of itself refute. They show a knowledge of optics, perspective, architecture, sculpture and anatomy. The last-named science he studied under Dr Giovanni Battista Lombardi, whom he is believed to have represented in the portrait currently named "Il Medico del Correggio" (Correggio's physician). It is concluded that he learned the first elements of design from his uncle, Lorenzo Allegri, a painter of moderate ability at Correggio, and from Antonio Bartolotti, named Tognino, and that he afterwards went to the school of Francesco Ferrari Bianchi (named Frarè), and perhaps to that of the successors of Andrea Mantegna in Mantua. He is said to have learned modelling along with the celebrated Begarelli at Parma; and it has even been suggested that, in the "Pietà" executed by Begarelli for the church of Santa Margherita, the three finest figures are the work of Correggio, but, as the group appears to have been completed three years after the painter's death, there is very little plausibility in this story. Another statement connecting Begarelli with Correggio is probably true, namely, that the sculptor executed models in relief for the figures which the painter had to design on the cupolas of the churches in Parma. This was necessarily an expensive item, and it has been cited as showing that Correggio must have been at least tolerably well off,—an inference further supported by the fact that he used the most precious and costly colours, and generally painted on fine canvases or sometimes on sheets of copper.

The few certain early works of Correggio show a rapid progression towards the attainment of his own original style. Though he never achieved any large measure of reputation during his brief lifetime, and was perhaps totally unknown beyond his own district of country, he found a sufficiency of employers, and this from a very youthful age. One of his early pictures, painted in 1514 when he was nineteen or twenty years old, is a large altar-piece commissioned for the Franciscan convent at Carpi, representing the Virgin enthroned, with Saints; it indicates a predilection for the style of Leonardo da Vinci, and has certainly even greater freedom than similarly early works of Raphael. This picture is now in the Dresden gallery. Another painting of Correggio's youth is the "Arrest of

Christ." A third is an Ancona (or triple altar-piece—the "Repose in Egypt, with Sts Bartholomew and John") in the church of the Conventuali at Correggio, showing the transition from the painter's first to his second style. Between 1514 and 1520 Correggio worked much, both in oil and in fresco, for churches and convents. In 1521 he began his famous fresco of the "Ascension of Christ," on the cupola of the Benedictine church of San Giovanni in Parma; here the Redeemer is surrounded by the twelve apostles and the four doctors of the church, supported by a host of wingless cherub boys amid the clouds. This he finished in 1524, and soon afterwards undertook his still vaster work on another cupola, that of the cathedral of the same city, presenting the "Assumption of the Virgin," amid an unnumbered host of saints and angels rapt in celestial joy. It occupied him up to 1530. The astounding boldness of scheme in these works, especially as regards their incessant and audacious foreshortenings—the whole mass of figures being portrayed as in the clouds, and as seen from below—becomes all the more startling when we recall to mind the three facts—that Correggio had apparently never seen any of the masterpieces of Raphael or his other great predecessors and contemporaries, in Rome, Florence, or other chief centres of art; that he was the first artist who ever undertook the painting of a large cupola; and that he not only went at once to the extreme of what can be adventured in foreshortening, but even forestalled in this attempt the mightiest geniuses of an elder generation—the "Last Judgment" of Michelangelo, for instance, not having been begun earlier than 1533 (although the ceiling of the Sistine chapel, in which foreshortening plays a comparatively small part, dates from 1508 to 1512). The cupola of the cathedral has neither skylight nor windows, but only light reflected from below; the frescoes, some portions of which were ultimately supplied by Giorgio Gandini, are now dusky with the smoke of tapers, and parts of them, in the cathedral and in the church of St John, have during many past years been peeling off. The violent foreshortenings were not, in the painter's own time, the object of unmixed admiration; some satirist termed the groups a "guazzetto di rane," or "hash of frogs." This was not exactly the opinion of Titian, who is reported to have said, on seeing the pictures, and finding them lightly esteemed by local dignitaries, "Reverse the cupola, and fill it with gold, and even that will not be its money's worth." Annibale Caracci and the Eclectics generally evinced their zealous admiration quite as ardently. Parma is the only city which contains frescoes by Correggio. For the paintings of the cupola of San Giovanni he received the moderate sum of 472 sequins; for those of the cathedral, much less proportionately, 350. On these amounts he had to subsist, himself and his family, and to provide the colours, for about ten years, having little time for further work meanwhile. Parma was in an exceedingly unsettled and turbulent condition during some of the years covered by Correggio's labours there, veering between the governmental ascendancy of the French and of the Pope, with wars and rumours of wars, alarms, tumults and pestilence.

Other leading works by Correggio are the following:—The frescoes in the Camera di San Paolo (the abbess's saloon) in the monastery of S. Lodovico at Parma, painted towards 1519 in fresco,—"Diana returning from the Chase," with auxiliary groups of lovely and vivacious boys of more than life size, in sixteen oval compartments. In the National Gallery, London, the "Ecce Homo," painted probably towards 1520 (authenticity not unquestioned); and "Cupid, Mercury and Venus," the latter more especially a fine example. The oil-painting of the Nativity named "Night" ("La Notte"), for which 40 ducats and 208 livres of old Reggio coin were paid, the nocturnal scene partially lit up by the splendour proceeding from the divine Infant. This work was undertaken at Reggio in 1522 for Alberto Pratoneri, and is now in the Dresden gallery. The oil-painting of St Jerome, termed also "Day" ("Il Giorno"), as contrasting with the above-named "Night." Jerome is here with the Madonna and Child, the Magdalene, and two Angels, of whom one points out to the Infant a passage in the book held by the

Saint. This was painted for Briseida Bergonzi from 1527 onwards, and was remunerated by 400 gold imperials, some cartloads of faggots and measures of wheat, and a fat pig. It is now in the gallery at Parma. The "Magdalene lying at the entrance of her Cavern": this small picture (only 18 in. wide) was bought by Augustus III. of Saxony for 6000 louis d'or, and is in Dresden. In the same gallery, the two works designated "St George" (painted towards 1532) and "St Sebastian." In the Parma gallery, the Madonna named "della Scala," a fresco which was originally in a recess of the Porta Romana, Parma; also the Madonna "della Scodella" (of the bowl, which is held by the Virgin—the subject being the Repose in Egypt): it was executed for the church of San Sepolcro. Both these works date towards 1526. In the church of the Annunciation, "Parma," a fresco of the Annunciation, now all but perished. Five celebrated pictures painted or begun in 1532,—"Venus," "Leda," "Danaë," "Vice," and "Virtue": the "Leda," with figures of charming girls bathing, is now in the Berlin gallery, and is a singularly delightful specimen of the master. In Vienna, "Jupiter and Io." In the Louvre, "Jupiter and Antiope," and the "Mystic Marriage of St Catharine." In the Naples Museum, the "Madonna Reposing," commonly named "La Zingarella," or the "Madonna del Coniglio" (Gipsy-girl, or Madonna of the Rabbit). On some of his pictures Correggio signed "Lieto," as a synonym of "Allegri." About forty works can be confidently assigned to him, apart from a multitude of others probably or manifestly spurious.

The famous story that this great but isolated artist was once, after long expectancy, gratified by seeing a picture of Raphael's, and closed an intense scrutiny of it by exclaiming "Anch' io son pittore" (I too am a painter), cannot be traced to any certain source. It has nevertheless a great internal air of probability; and the most enthusiastic devotee of the Umbrian will admit that in technical *bravura*, in enterprising, gifted, and consummated execution, not Raphael himself could have assumed to lord it over Correggio.

In 1520 Correggio married Girolama Merlino, a young lady of Mantua, who brought him a good dowry. She was but sixteen years of age, very lovely, and is said by tradition to have been the model of his Zingarella. They lived in great harmony together, and had a family of four children. She died in 1529. Correggio himself expired at his native place on the 5th of March 1534. His illness was a short one, and has by some authors been termed pleurisy. Others, following Vasari, allege that it was brought on by his having had to carry home a sum of money, 50 scudi, which had been paid to him for one of his pictures, and paid in copper coin to humiliate and annoy him; he carried the money himself, to save expense, from Parma to Correggio on a hot day, and his fatigue and exhaustion led to the mortal illness. In this curious tale there is no symptom of authenticity, unless its very singularity, and the unlikelihood of its being invented without any foundation at all, may be allowed to count for something. He is said to have died with Christian piety; and his eulogists (speaking apparently from intuition rather than record) affirm that he was a good citizen, an affectionate son and father, fond and observant of children, a sincere and obliging friend, pacific, beneficent, grateful, unassuming, without meanness, free from envy and tolerant of criticism. He was buried with some pomp in the Arrivabene chapel, in the cloister of the Franciscan church at Correggio.

Regarding the art of Correggio from an intellectual or emotional point of view, his supreme gift may be defined as suavity,—a vivid, spontaneous, lambent play of the affections, a heartfelt inner grace which fashions the forms and features, and beams like soft and glancing sunshine in the expressions. We see lovely or lovable souls clothed in bodies or corresponding loveliness, which are not only physically charming, but are so informed with the spirit within as to become one with that in movement and gesture. In these qualities of graceful naturalness, not heightened into the sacred or severe, and of joyous animation, in momentary smiles and casual living turns of head or limb, Correggio undoubtedly carried the art some steps beyond any-

thing it had previously attained, and he remains to this day the unsurpassed or unequalled model of pre-eminence. From a technical point of view, his supreme gift—even exceeding his prodigious faculty in foreshortening and the like—is chiaroscuro, the power of modifying every tone, from bright light to depth of darkness, with the sweetest and most subtle gradations, all being combined into harmonious unity. In this again he far distanced all predecessors, and defied subsequent competition. His colour also is luminous and precious, perfectly understood and blended; it does not rival the superb richness or deep intense glow of the Venetians, but on its own showing is a perfect achievement, in exact keeping with his powers in chiaroscuro and in vital expression. When we come, however, to estimate painters according to their dramatic faculty, their power of telling a story or impressing a majestic truth, their range and strength of mind, we find the merits of Correggio very feeble in comparison with those of the highest masters, and even of many who without being altogether great have excelled in these particular qualities. Correggio never *means* much, and often, in subjects where fulness of significance is demanded, he means provokingly little. He expressed his own miraculous faculty by saying that he always had his thoughts at the end of his pencil; in truth, they were often thoughts rather of the pencil and its controlling hand than of the teeming brain. He has the faults of his excellences—sweetness lapsing into mawkishness and affectation, empty in elevated themes and lasciviously voluptuous in those of a sensuous type, rapid and forceful action lapsing into posturing and self-display, fineness and sinuosity of contour lapsing into exaggeration and mannerism, daring design lapsing into incorrectness. No great master is more dangerous than Correggio to his enthusiasts; round him the misdeeds of conventionalists and the follies of connoisseurs cluster with peculiar virulence, and almost tend to blind to his real and astonishing excellences those practitioners or lovers of painting who, while they can acknowledge the value of *technique*, are still more devoted to greatness of soul, and grave or elevated invention, as expressed in the form of art.

Correggio was the head of the school of painting of Parma, which forms one main division of the Lombardic school. He had more imitators than pupils. Of the latter one can name with certainty only his son Pomponio, who was born in 1521 and died at an advanced age; Francesco Capelli; Giovanni Giarola; Antonio Bernieri (who, being also a native of the town of Correggio, has sometimes been confounded with Allegri); and Bernardo Gatti, who ranks as the best of all. The Parmigiani (Mazzuoli) were his most highly distinguished imitators.

A large number of books have been written concerning Correggio. The principal modern authority is Conrado Ricci, *Life and Times of Correggio* (1896); see also Pungileoni, *Memorie storiche di Antonio Allegri* (1817); Julius Meyer, *Antonio Allegri* (1870, English translation, 1876); H. Thode, *Correggio* (1898); Bigi, *Vita ed opere* (1881); Colnaghi, *Correggio Frescoes at Parma* (1845); Fagan, *Works of Correggio* (1873); and T. Sturge Moore, *Correggio* (1906) (a work which includes some adverse criticism on the views of Bernhard Berenson, in his *Study of Italian Art*, 1901, and elsewhere). (W. M. R.)

**CORRENTI, CESARE** (1815–1888), Italian revolutionist and politician, was born on the 3rd of January 1815, at Milan, of a poor but noble family. While employed in the public debt administration, he flooded Lombardy with revolutionary pamphlets designed to excite hatred against the Austrians, and in 1848 proposed the general abstention of the Milanese from smoking, which gave rise to the insurrection known as the Five Days. During the revolt he was one of the leading spirits of the operations of the insurgents. Until the reoccupation of Milan by the Austrians he was secretary-general of the provisional government, but afterwards he fled to Piedmont, whence he again distributed his revolutionary pamphlets throughout Lombardy, earning a precarious livelihood by journalism. Elected deputy in 1849, he worked strenuously for the national cause, supporting Cavour in his Crimean policy, although he belonged to the Left. After the annexation of Lombardy he was made commissioner for the liquidation of the Lombardo-Venetian debt, in 1860 was

appointed councillor of state, and received various other public positions, especially in connexion with the railway and financial administration. He veered round to the Right, and in 1867 and again in 1869 he held the portfolio of education; he played an important part in the events consequent upon the occupation of Rome, and helped to draft the Law of Guarantees. As minister of education he suppressed the theological faculties in the Italian universities, but eventually resigned office and allied himself with the Left again on account of conservative opposition to his reforms. His defection from the Right ultimately assured the advent of the Left to power in 1876; and while declining office, he remained chief adviser of Agostino Depretis until the latter's death. On several occasions—notably in connexion with the redemption of the Italian railways, and with the Paris exhibition of 1878—he acted as representative of the government. In 1877 he was given the lucrative appointment of secretary of the order of Saints Maurice and Lazarus by Depretis, and in 1886 was created senator. He died at Rome on the 4th of October 1888. He left a considerable body of writings on a variety of subjects, none of which is of exceptional merit.

See E. Massarani, *Cesare Correnti nella vita e nelle opere* (1890); and L. Carpi, *Il Risorgimento italiano*, vol. iv. (Milan, 1888). (L. V.)\*

**CORRESPONDENCE** (from med. scholastic Lat. *correspondentia*, *correspondere*, compounded of Lat. *cum*, with, and *respondere*, to answer; cf. Fr. *correspondance*), strictly a mutual agreement or fitness of parts or character, that which fits or answers to a requirement in another, or more generally a similarity or parallelism. In the 17th and 18th centuries the word was frequently applied to relations and communications between states. It is now, outside special applications, chiefly applied to the interchange of communications by letter, or to the letters themselves, between private individuals, states, business houses, or from individuals to the press. The "doctrine of correspondence or correspondences," one of the leading tenets of Swedenborgianism, is that every natural object corresponds to and typifies some spiritual principle or truth, this being the only key to the true interpretation of Scripture. In mathematics, the term "correspondence" implies the existence of some relation between the members of two groups of objects. If each object of one group corresponds to one and only one object of the second, and vice versa, then a one-to-one correspondence exists between the groups. If each object of the first group corresponds to  $\beta$  objects of the second group, and each object of the second group corresponds to  $\alpha$  objects of the first group, then an  $\alpha$  to  $\beta$  correspondence exists between the two groups. For examples of the application of this notion see CURVE.

**CORRÈZE**, a department of south-central France, formed from the southern portion of the old province of Limousin, bounded N. by the departments of Haute-Vienne and Creuse, E. by Puy-de-Dôme, S.E. by Cantal, S. by Lot, and W. by Dordogne. Area, 2273 sq. m. Pop. (1906) 317,430. Corrèze is situated on the western fringe of the central plateau of France. It forms a hilly tableland elevated in the east and north, and intersected by numerous fertile river valleys, trending for the most part to the south and south-west. The highest points, many of which exceed 3000 ft., are found in the north, where the Plateau de Millevaches separates the basins of the Loire and the Garonne. Except for a small district in the extreme north, which is watered by the Vienne, Corrèze belongs to the basin of the Garonne. The Dordogne waters its south-eastern region. The Corrèze, from which the department takes its name, and the Vézère, of which the Corrèze is the chief tributary, rise in the Plateau de Millevaches, flow south-west, and unite to the west of Brive. The climate of Corrèze is, in general, cold, damp and variable, except in the south-west, where it is mild and agreeable. The majority of the inhabitants live by agriculture. About one-third of the department is arable land, most of which is found in the south-west. Rye, buckwheat and wheat (in the order named) are the most abundant cereals. Hemp, flax and tobacco are also grown. The more elevated regions of the north and east are given over to pasture, sheep being specially numerous on the Plateau de

Millevaches. Pigs and goats are reared to a considerable extent; and poultry-farming and cheese-making are much practised. The vineyards of the neighbourhood of Brive produce wine of medium quality. Chestnuts, largely used as an article of food, walnuts and cider-apples are the chief fruits. Coal in small quantities, slate, building-stone and other stone are the mineral products, and clay, used in potteries and tile-works, is also worked. The most important industrial establishment is the government manufactory of fire-arms at Tulle. There are flour-mills, breweries, oil-works, saw-mills and dye-works; and hats (Bort), coarse woollens, silk, preserved foods, wooden shoes, chairs, paper and leather are manufactured. Coal and raw materials for textile industries are leading imports; live stock and agricultural products are the chief exports. The department is served by the Orléans railway, and the Dordogne is navigable. The department is divided into the arrondissements of Tulle, Brive and Ussel, containing 29 cantons and 289 communes. It belongs to the archdiocese of Bourges, the region of the XII. army corps, and the *Académie* (educational division) of Clermont-Ferrand. Its court of appeal is at Limoges. Tulle, the capital, and Brive are the principal towns of the department. Uzerche is a picturesque old town on the Vézère, with a Romanesque church, old houses, a gate and other remains of medieval fortifications. At Aubazine (or Obazine) there is a Romanesque church of the 12th century, formerly belonging to the celebrated Cistercian abbey, of which Étienne "of Obazine" (d. 1159 and subsequently beatified) was the founder and first abbot. It contains the fine sculptured tomb of the founder. To the same style belong the abbey church of Beaulieu, the south portal of which is elaborately carved, the abbey church of Meymac, and the abbey church of Vigeois. Treignac, with its church, bridge and ramparts of the 15th century, and Turenne, dominated by the ruins of the castle of the famous family of that name, are ancient and interesting towns. The dolmen at Espartignac and the cromlech of Aubazine are the chief megalithic remains in the department. A Roman eagle and other antiquities have been found close to Ussel, which at the end of the 16th century became the centre of the duchy of Ventadour.

**CORRIB, LOUGH**, a lake of western Ireland, in the counties Galway and Mayo. It lies N.W. and S.E., and is 27 m. long, including a long projecting arm at the north-west. The extreme breadth is 7 m., but the outline is extremely irregular, and the lough narrows near the centre to a few hundred yards. Lough Corrib is very shallow, hardly exceeding 30 ft. in depth at any point, and it is covered with islands, of which there are some 300. It lies 29 ft. above sea-level, and drains by the short river Corrib to Galway Bay. The large Lough Mask lies to its north and is connected with it by a partly subterranean channel. The scenery is pleasant, but the shores are low, except at the north-west, where the wild foothills of Joyce's Country rise.

**CORRIDOR** (Fr. *corridor*, from Ital. *corridore*, Med. Lat. *corridorium*, a "running-place," from *currere*, to run), a main passage in a large building, on which various apartments open. In public offices, prisons, workhouses, hospitals, &c., the corridors are usually of severe simplicity; but in mansions and palaces large corridors (galleries) are often adorned with works of art, whence comes the term "picture gallery" applied to many collections. The term "corridor carriage" is applied to the modern style of railway carriage in which a narrow passage connects the separate compartments, the object being to combine a certain degree of privacy for the traveller with access from one compartment to another whilst the train is in motion.

**CORRIE** (Gaelic *coire*, cauldron; hence whirlpool, or circular hollow), a term used in the Highlands of Scotland for a steep-sided, rounded hollow in a mountain-side, from the lower part of which a stream usually issues as the outlet of a small lake ponded by glacial debris. Corrie-lakes are common in all glaciated mountain regions. (See CIRQUE.)

**CORRIENTES**, a north-eastern province of the Argentine Republic, and part of a region known as the Argentine Mesopotamia, bounded N. by Paraguay, N.E. by Misiones (territory), E. by Brazil, S. by Entre Rios, and W. by Santa Fé and the



Chaco. Pop. (1895) 239,618; (1904 estimate) 299,479; area, 32,580 sq. m. Nearly one-third of the province is covered by swamps and lagoons, or is so little above their level as to be practically unfit for permanent settlement unless drained. The Iberá lagoon (c. 8500 sq. m., according to the *Argentine Year Book* for 1905-1906) includes a large part of the central and north-eastern departments, and the Maloya lagoon covers a large part of the north-western departments. Several streams flowing into the Paraná and Uruguay have their sources in these lagoons, the Iberá sending its waters in both directions. The southern districts of the province, however, are high and rolling, similar to the neighbouring departments of Entre Ríos, and are admirably adapted to grazing and agriculture. The north-eastern corner is also high, but it is broken by ranges of hills and is heavily forested, like the adjacent territory of Misiones. The climate on the higher plains is sub-tropical, but in the northern swamps it is essentially tropical. Corrientes is the hottest province of Argentina, notwithstanding its large area of water and forest. The exports include cattle and horses, jerked beef, hides, timber and firewood, cereals and fruit. The principal towns are Corrientes, the capital; Goya, a flourishing agricultural town (1906 estimate, 7000) on a side channel of the Paraná, 150 m. S. of Corrientes, the seat of a modern normal school and the market-town of a prosperous district; Bella Vista (pop. 1906 estimate, 3000), prettily situated on the Paraná, 80 m. S. of Corrientes, the commercial centre of a large district; Esquina (pop. 1906 estimate, 3000) on the Paraná at the mouth of the Corrientes river, 86 m. S. of Goya, which exports timber and firewood from the neighbouring forest of Payubre; Monte Caseros (pop. 1906 estimate, 4000) on the Uruguay river, from which cattle are shipped to Brazil, the eastern terminus of the Argentine North-Eastern railway (which crosses the province in a N.W. direction to Corrientes), and a station on the East Argentine railway (which runs northward to Paso de Los Libres, opposite Uruguayana, Brazil and to San Tomé, and southward to a junction with the Entre Ríos railways). A considerable district on the upper Uruguay was once occupied by prosperous Jesuit missions, all of which fell into decay and ruins after the expulsion of that order from the Spanish possessions in 1767. The population of the province is composed very largely of Indian and mixed races, and Guarani is still the language of the country people.

**CORRIENTES** (*San Juan de Corrientes*), a city and river port, and the capital of the above province, in the north of the Argentine Republic, on the left bank of the Paraná river, 20 m. below the junction of the Upper Paraná and Paraguay, and 832 m. N. of Buenos Aires. The name is derived from the *siete corrientes* (seven currents) caused by rocks in the bed of the river just above the town. Pop. (1895) 16,129; (1907 local estimate) 30,172, largely Indian and of mixed descent. The appearance of Corrientes is not equal to its commercial and political importance, the buildings both public and private being generally poor and antiquated. There are four churches, the more conspicuous of which are the Matriz and San Francisco. The government house, originally a Jesuit college, is an antiquated structure surrounding an open court (*patio*). There is a national college. The commercial importance of Corrientes results from its unusually favourable situation near the confluence of the Upper Paraná and Paraguay, and a short distance below the mouth of the Bermejo. The navigation of the Upper Paraná and Bermejo rivers begins here, and freight for the Upper Paraná and Chaco rivers is transhipped at Corrientes, which practically controls the trade of the extensive regions tributary to them. Corrientes is the western terminus of the Argentine North-Eastern railway, which crosses the province S.E. to Monte Caseros, where it connects with the East Argentine line running S. to Concordia and N. to San Tomé. The principal exports are timber, cereals, maté, sugar, tobacco, hides, jerked beef, fruit and quebracho.

**CORRIGAN, MICHAEL AUGUSTINE** (1839-1902), third archbishop of the Roman Catholic archdiocese of New York, in the United States, was born in Newark, New Jersey, on the

13th of August 1839. In 1859 he graduated at Mount St Mary's College, Emmitsburg, Maryland, and began his studies for the priesthood as the first of the twelve students with whom the American College at Rome was opened. On the 19th of September 1863 he was ordained priest, and in 1864 obtained the degree of D.D. Returning to America, he was appointed professor of Dogmatic Theology and Sacred Scripture, and director of the ecclesiastical seminary of Seton Hall College at South Orange, New Jersey; soon afterwards he was made vice-president of the institution; and in 1868 became president, succeeding Rev. Bernard J. M'Quaid (b. 1823), the first Roman Catholic bishop of Rochester. In October 1868 Corrigan became vicar-general of Newark, a diocese then including all the state of New Jersey. When Archbishop Bayley was transferred to the see of Baltimore in 1873, Pius IX. appointed Corrigan bishop of Newark. In 1876 he resigned the presidency of Seton Hall College. In 1880 Bishop Corrigan was made coadjutor, with the right of succession, to Cardinal McCloskey, archbishop of New York, under the title of archbishop of Petra; and thereafter nearly all the practical work of the archdiocese fell to his hands. He was at the time the youngest archbishop in the Catholic Church in America. On the death of Cardinal McCloskey in 1885 Archbishop Corrigan became metropolitan of the diocese of New York. He died on the 5th of May 1902. He was a scholar of much erudition, with great power of administrative organization, simple, generous and kindly in character. The earlier years of his archiepiscopate were disturbed by his controversy with Edward McGlynn (1839-1900), a New York priest (and a fellow-student with Corrigan at Rome), who disapproved of parochial schools, refused to go to Rome for examination, and was excommunicated in July 1887, but returned to the church five years later.

See *Michael Augustine Corrigan: A Memorial*, with biographical sketch by John A. Mooney (New York, 1902).

**CORROSIVE SUBLIMATE**, MERCURIC CHLORIDE, PERCHLORIDE OF MERCURY ( $\text{HgCl}_2$ ), a white solid obtained by the action of chlorine on mercury or calomel, by the addition of hydrochloric acid to a hot, strong solution of mercurous nitrate,  $\text{Hg}_2(\text{NO}_3)_2 + 4\text{HCl} = 2\text{HgCl}_2 + 2\text{H}_2\text{O} + 2\text{NO}_2$ , and, commercially, by heating a mixture of mercuric sulphate and common salt, the mercuric chloride subliming and being condensed in the form of small rhombic crystals. It melts at  $288^\circ$ , and boils at  $303^\circ$ ; it is sparingly soluble in cold water, more so in hot; it is very soluble in alcohol and ether. It is soluble in hydrochloric acid forming compounds such as  $\text{HgCl}_2 \cdot 2\text{HCl}$ ,  $3\text{HgCl}_2 \cdot 4\text{HCl}$ ,  $2\text{HgCl}_2 \cdot \text{HCl}$ , according to the temperature and concentration; it also forms double salts with many chlorides; *sal alembroth*,  $2\text{NH}_4\text{Cl} \cdot \text{HgCl}_2 \cdot \text{H}_2\text{O}$ , is the compound with ammonium chloride. It absorbs ammonia to form  $\text{HgCl}_2 \cdot \text{NH}_3$ , which may be distilled without decomposition. Various oxychlorides are formed by digesting corrosive sublimate with mercuric oxide. Corrosive sublimate has important applications in medicine—as an astringent, stimulant, caustic and antiseptic (see MERCURY).

**CORRUPT PRACTICES**, a term used in English election law, as defined by the Corrupt and Illegal Practices Prevention Act 1883, to include bribery, treating, undue influence, personation, and aiding, abetting, counselling and procuring personation. Bribery and corruption at elections have been the subject of much legislation, statutes for their prevention have been passed in 1729, 1809, 1827, 1842, 1854, 1868 and 1883.

By the Corrupt and Illegal Practices Prevention Act 1883 (which incorporated the Corrupt Practices Prevention Act 1854, an act that repealed all former legislation) the following persons are to be deemed guilty of *bribery*:—

1. Every person who shall directly or indirectly, by himself or by any other person on his behalf, give, lend, &c., or offer, promise, or promise to procure, &c., any money or valuable consideration to or for any voter or any other person in order to induce any voter to vote or refrain from voting, or shall corruptly do any such act on account of such voter having voted or refrained from voting at any election.

2. Every person who shall similarly give or procure or promise,

&c., any office, place or employment to or for any voter or other person in order to induce him to vote, &c.

3. Every person who shall make any gift, loan, promise, &c., as aforesaid to any person to induce such person to procure the return of any person to serve in parliament or the vote of any voter.

4. Every person who shall, in consequence of such gift, procure or engage, promise or endeavour to procure the return of any person or the vote of any voter.

5. Every person who shall pay any money with the intent that it should be spent in bribery, or who shall pay money in repayment of any money wholly or in part expended in bribery.

6. Every person who before or during an election shall receive or contract for any money, &c., for voting, or refraining, or agreeing to vote or to refrain from voting.

7. Every person who, after the election, receives money, &c., on account of any person having voted or refrained, &c.

*Treating.*—Any person who corruptly by himself or by any other person either before, during or after an election, directly or indirectly gives or provides, or pays wholly or in part the expense of giving or providing any meat, drink or entertainment, or provision to or for any person in order to be elected, or for being elected, or for the purpose of corruptly influencing such person to give or refrain from giving his vote at an election, &c., shall be deemed guilty of treating, and every elector corruptly accepting such meat, drink, &c., shall also be guilty of treating.

*Undue Influence.*—Every person who shall directly or indirectly make use of or threaten to make use of any force, violence, &c., or inflict or threaten to inflict any temporal or spiritual injury, &c., upon any person to induce or compel such person to vote or refrain from voting, or who shall by abduction, duress, or any fraudulent device or contrivance impede or prevent the exercise of the franchise of any elector, or shall thereby compel, induce, &c., any elector to give or refrain from giving his vote, shall be guilty of undue influence.

Illegal, as distinguished from "corrupt," practices are certain acts and omissions in regard to an election which are now prohibited, whether done or omitted, honestly or dishonestly. They may be classified under the following heads:—(1) Acts which are illegal practices by whomsoever committed. These are as follows: Payment or receipt or contracts to pay or receive money for conveyance of voters to or from the poll, on account of any committee room beyond the number allowed by the act, or to an elector for use of house or land to exhibit addresses, &c., or for exhibition by him (otherwise than in the ordinary course of his business of advertising agent) of such addresses, &c.; payment of election expenses otherwise than by or through the election agent, and payment otherwise than to a candidate or election agent of money provided by any other person for election expenses; voting or procuring to vote of any person prohibited from voting, if the person offending knows of the prohibition; knowingly publishing a false statement that a candidate has withdrawn, or publishing with a view to affect the return of a candidate a false statement as to his character or conduct. (2) Acts and omissions which are illegal practices in the case of candidates and agents only, being breaches of duties specially imposed on them. These are the payment or incurring expenses in excess of the maximum authorized by the legislature, the omitting without lawful excuse to make a return and declaration of expenses in due time, and the payment by an election agent of any election expense amounting to 40s. not vouched by bill of particulars and receipt, of any claim for expenses not sent in in due time, or of any such claim after the time allowed for payment thereof. (3) Acts which are illegal practices when done by a candidate or agent, and are a minor offence when done by any one else. These are illegal payments, employment and hiring, and printing, publishing or posting a bill, placard or poster not bearing on its face the name of the printer or publisher. Illegal payments are knowingly providing money for prohibited payments or expenses in excess of the maximum, corruptly inducing a candidate to withdraw by payment or promise of payment (the candidate so induced being guilty of the like offence), paying or

agreeing to pay for torches, flags, banners, cockades, ribbons and other marks of distinction (the receiver being guilty of the like offence if he is aware of the illegality). Illegal employment is the employment for payment or promise of payment of persons beyond the number allowed by the legislature or for purposes not authorized. The employé is guilty of the like offence if he knows of the illegality. Illegal hiring is the letting or lending, or the employing, hiring, borrowing or using to carry voters to the poll of stage, or hackney carriages, or horses, or of carriages or horses ordinarily let for hire, and the hiring of committee rooms in premises licensed for the sale of intoxicants, in a club (not being a permanent political club) where intoxicants are sold, in premises where refreshments are ordinarily sold, or in a public elementary school in receipt of a parliamentary grant. Personation and aiding, abetting, &c., of personation are felonies punishable with two years' imprisonment with hard labour. All other corrupt practices are indictable misdemeanours (in Scotland, crimes and offences) punishable with one year's imprisonment, with or without hard labour, or a fine not exceeding £200. Conviction of any corrupt practice also renders the offender incapable for seven years of being registered as an elector, or voting at any election, parliamentary or other, in the United Kingdom, or of holding any public or judicial office, or of being elected to or sitting in the House of Commons; and any such office or seat held by him at the time is vacated. In the case of a parliamentary candidate, if an election court finds that there has been treating or undue influence by him, or any other corrupt practice with his knowledge or consent, he becomes incapable of ever being elected for the same constituency, and incurs the like incapacities as if he had been convicted on indictment; if it is found by the election court that he has been guilty by his agents of a corrupt practice, he becomes incapable for seven years of being elected for the same constituency. Illegal practices are offences punishable on summary conviction with a fine not exceeding £100, and with five years' incapacity for being registered or voting as a parliamentary elector, or an elector to public office within the county or borough where the offence was committed. Illegal payments, employment and hiring, and printing and publishing of bills, &c., not bearing the printer's or publisher's name, are, when committed by any one who is not a candidate or agent, offences punishable on summary conviction with a fine not exceeding £100, but carry with them no incapacities. Where an election court finds that any illegal practice has been committed with the knowledge or consent of a parliamentary candidate, he becomes incapable for seven years of being elected to or sitting in the House of Commons for the same constituency. He incurs the like incapacity, limited to the duration of the parliament for which the election was held, if the election court finds that he was guilty by his agents of an illegal practice. A prosecution for any of the above offences cannot be instituted more than a year after the offence was committed, unless an inquiry by election commissioners takes place, in which case it may be instituted at any time within two years from the commission of the offence, not being more than three months after the date of the commissioners' report.

The law as to corrupt and illegal practices, as above stated, applies equally to parliamentary, municipal, county and parish council elections. Incapacities corresponding to those incurred by parliamentary candidates found guilty by an election court are incurred by municipal and other candidates in the like case, e.g. a municipal candidate found personally guilty of a corrupt practice is incapacitated forever, and a candidate found guilty by his agents is incapacitated for three years from holding corporate office in the borough.

See Rogers, *On Elections*, 3 vols.; Fraser, *Law of Parliamentary Elections*.

**CORRY**, a city of Erie county, Pennsylvania, U.S.A., 37 m. S.E. of Erie, in the N.W. part of the state, at an elevation of about 1430 ft. Pop. (1890) 5677; (1900) 5369 (671 foreign-born); (1910) 5991. It is served by the Erie and the Pennsylvania railways. Corry is situated in the midst of a fine farming region, which is rich in petroleum and natural gas, and

is widely known for its mineral springs. One mile W. of the city is a state fish hatchery, and there are fine trout streams in the neighbourhood. Among the city's manufactures are steel, engines, locomotives, radiators, shovels, bricks, flour, furniture and leather. Corry was settled in 1860, and was incorporated as a borough in 1863 and as a city in 1866.

**CORSAIR** (through the Fr. from the Med. Lat. *corsarius*, a pirate; *corsus*, or *curso*, from *currere*, to run, being Late Latin for a plundering foray), the name given by the Mediterranean peoples to the privateers of the Barbary coast who plundered the shipping of Christian nations; they were not strictly pirates, as they were commissioned by their respective governments, but the word came to be synonymous, in English, with "pirate." The French word *corsaire* is still used for "privateer," and *guerre de course* is applied to the use in naval warfare of "commerce-destroyers." (See PIRATE, BARBARY PIRATES and PRIVATEER.)

**CORSICA** (Fr. *Corse*), a large island of the Mediterranean, forming a department of France. It is situated immediately to the north of Sardinia (from which it is separated by the narrow strait of Bonifacio), between 41° 21' and 43° N. and 8° 30' and 9° 30' E. Area, 3367 sq.m. Pop. (1906) 291,160. Corsica lies within 54 m. W. of the coast of Tuscany, 98 m. S. of Genoa and 106 m. S.E. of the French coast at Nice. The extreme length of the island is 114 m. and its breadth 52 m. The greater part of the surface of Corsica is occupied by forest-clad mountains, whose central ridge describes a curve from N.W. to S.W., presenting its convexity towards the E. Secondary chains diverge in all directions from this main range, enclosing small basins both geographically and socially isolated; on the west and south of the island they either terminate abruptly on the shore or run out to a great distance into the sea, forming picturesque bays and gulfs, some of which afford excellent harbours. The highest peaks are the Monts Cinto (8881 ft.), Rotondo (8612), Paglia Orba (8284), Padro (7851) and d'Oro (7845). On the eastern side of the island, between Bastia and Porto Vecchio, there intervenes between the mountains and the sea a considerable tract of low and unhealthy, but fertile country, and the coast is fringed in places by lagoons.

*Geology.*—Corsica may be divided into two parts, which are geologically distinct, by a line drawn from Belgodere through Corte to the east coast near Favone. West of this line the island is composed chiefly of granite, with a large mass of granophyres, quartz porphyries and similar rocks forming the high mountains around Mt. Cinto; but between the Gulfs of Porto and Galeria, schists, limestones and anthracite, containing fossils of Upper Carboniferous age, occur. The famous orbicular diorite of Corsica is found near Sta. Lucia-di-Tallano in the arrondissement of Sartène. In the eastern part of the island the predominant rocks are schists of unknown age, with intrusive masses of serpentine and euphotide. Folded amongst the schists are strips of Upper Carboniferous beds similar to those of the west coast. Overlying these more ancient rocks are limestones with Rhaetic and Liassic fossils, occurring in small patches at Oletta, Morosaglia, &c. Nummulitic limestone of Eocene age is found near St Florent, and occupies several large basins near the boundary between the granite and the schist. Miocene molasse with *Clypeaster*, &c., forms the plain of Aleria on the east coast, and occurs also at St Florent in the north and Bonifacio in the south. A small patch of Pliocene has been found near Aleria. The caves of Corsica, especially in the neighbourhood of Bastia, contain numerous mammalian remains, the commonest of which belong to *Lagomys corsicanus*, Cuv.

See Hollande, "Géologie de la Corse," *Ann. sci. géol.*, vol. ix. (1877); Nentien, "Études sur les gîtes minéraux de la Corse," *Ann. Mines Paris*, ser. 9, vol. xii. pp. 231-296, pl. v. (1897).

Corsica is well watered by rivers and torrents, which, though short in their course, bring down large volumes of water from the mountains. The longest is the Golo, which rises in the pastoral region of Niolo, isolated among the mountains to the west of Corte and inhabited by a distinct population of obscure origin. It enters the sea on the east coast to the south of the salt-water lake of Biguglia; farther south, on the same side of the island, is the Tavignano, while on the west there are the Liamone, the Gravone and the Taravo. The other streams are all comparatively small. Owing to the rugged and indented outline of the western coast there are an unusual number of bays and harbours. Of the bays the most important are

Porto, Sagone, Ajaccio and Valinco; of the ports, St Florent (San Fiorenzo), Ile Rousse (Isola Rossa), Calvi, Ajaccio and Propriano. On the eastern side, which is much less rugged and broken, the only harbours worth mentioning are those of Bastia and Porto Vecchio (the *Portus Syracusanus* of the ancients), and the only gulfs those of Porto Vecchio and Santa Manza. At the extreme south are the harbour and town of Bonifacio, giving name to the strait which separates Corsica from Sardinia.

The climate of the island ranges from warmth in the lowlands to extreme rigour in the mountains. The intermediate region is the most temperate and healthy. The mean annual temperature at Ajaccio is 63° F. The dominant winds are those from the south-west and south-east.

There are mines of anthracite, antimony and copper; the island produces granite, building stone, marble, and amianthus, and there are salt marshes. Among other places Guagno, Pardina Guitera, and Orezza have mineral springs.

The agriculture of Corsica suffers from scarcity of labour, due partly to the apathy of the inhabitants, and from scarcity of capital. The cultivation of cereals, despite the fertility of the soil, is neglected; wheat is grown to some extent, but in this respect, the population is dependent to a large degree on outside supplies. The culture of fruit, especially of the vine, cedrates, citrons and olives (for which the Balagne region, in the north-west, is noted), of vegetables and of tobacco, and sheep and goat rearing are the main rural industries, to which may be added the rearing of silk-worms. The exploitation of the fine forests, which contain the well-known Corsican pine, beeches, oaks and chestnuts, is also an important resource, but tends to proceed too rapidly. Chestnuts are exported, and, ground into flour, are used as food by the mountaineers. Most of the inhabitants are proprietors of land, but often the properties are so split up that many hours, or even a whole day, are spent in going from the vineyard or olive plantation to the arable land in the plain or the chestnut-wood in the mountain. A great part of the agricultural labour is performed by labourers from Tuscany and Lucca, who periodically visit the island for that purpose. Sheep of a peculiar breed, resembling chamois and known as *mouflons*, inhabit the more inaccessible parts of the mountains. The uncultivated districts are generally overgrown with a thick tangled underwood, consisting of arbutus, myrtle, thorn, laurel broom and other fragrant shrubs, and known as the *maquis*, the fragrance of which can be distinguished even from the sea.

Fishing and shooting are allowed almost everywhere to the possessor of a government licence; special permission, where it is necessary, is easily obtained. Wild boars, stags, in the eastern districts, and hares as well as the *mouflon* are found, while partridges, quail, woodcock, wild duck and water-fowl are abundant. Trout and eels are the chief fish. The flesh of the Corsican blackbird is considered a delicacy. The fisheries of tunny, pilchard and anchovy are extensively prosecuted for the supply of the Italian markets; but comparatively few of the natives are engaged in this industry.

The Corsican is simple and sober but unenterprising; dignified and proud, he is possessed of a native courtesy, manifested in his hospitality to strangers, the refusal of which is much resented. He is, however, implacable towards his own countrymen when his enmity is once aroused, and the practice of the blood-feud or *vendetta* has not died out. Each individual is attached to some powerful family, and the influence of this usage is specially marked in politics, the individual voting with his clan on pain of arousing the vindictiveness of his fellow-members. Another dominant factor in social life in Corsica is the almost universal ambition on the part of the natives towards an official career, a tendency from which commerce and agriculture inevitably suffer.

The manufactures of the island are of small importance. They include the extraction of gallic acid from chestnut-bark, the preparation of preserved citrons and other delicacies, and of macaroni and similar foods and the manufacture of fancy goods and cigars.

The chief ports are Bastia, Ajaccio and Ile Rousse. A railway

runs from Bastia to Ajaccio with branches to Calvi and Ghisonaccia, but, in general, lack of means of communication as well as of capital are a barrier to commercial activity. In 1905 imports reached a value of £113,000. The chief were tobacco, furniture and wooden goods, wine, cereals, coal, cheese and bran. Exports were valued at £336,000, and included chestnut-extract, charcoal, timber, citrons and other fruits, seeds, casks, skins, chestnuts and tanning bark.

Corsica is divided into five arrondissements (chief towns—Ajaccio, Bastia, Calvi, Corte and Sartène), with 62 cantons and 364 communes. It forms part of the *académie* (educational circumscription) and archiepiscopal province of Aix (Bouches-du-Rhône) and of the region of the XV. army corps. The principal towns are Ajaccio, the capital and the seat of the bishop of the island and of the prefect; Bastia, the seat of the court of appeal and of the military commander; Calvi, Corte and Bonifacio. Other places of interest are St Florent, near which stand the ruins of the cathedral (12th century) of the vanished town of Nebbio; Murato, which has a church (12th or 13th century) of Pisan architecture, which is exemplified in other Corsican churches; and Cargese, where there is a Greek colony, dating from the 17th century. Near Lucciana are the ruins of a fine Romanesque church called *La Canonica*. Megalithic monuments are numerous, chief among them being the dolmen of Fontanaccia in the arrondissement of Sartène.

*History.*—The earliest inhabitants of Corsica were probably Ligurian. The Phocaeans of Ionia were the first civilized people to establish settlements there. About 560 B.C. they landed in the island and founded the town of Alalia. By the end of the 6th century, however, their power had dwindled before that of the Etruscans, who were in their turn driven out by the Carthaginians. The latter were followed by the Romans, who gained a footing in the island at the time of the First Punic War, but did not establish themselves there till the middle of the 2nd century B.C. Both Marius and Sulla founded colonies—the one at Mariana (near Lucciana) in 104, the second at Aleria in 88. In the early centuries of the Christian era Corsica formed one of the senatorial provinces of the Empire, but though it was in continuous commercial communication with Italy, it was better known as a place of banishment for political offenders. One of the most distinguished of those was the younger Seneca, who spent in exile there the eight years ending A.D. 49.

During the break-up of the Roman empire in the West the possession of Corsica was for a while disputed between the Vandals and the Gothic allies of the Roman emperors, until in 469 Genseric finally made himself master of the island. For 65 years the Vandals maintained their domination, the Corsican forests supplying the wood for the fleets with which they terrorized the Mediterranean. After the destruction of the Vandal power in Africa by Belisarius, his lieutenant Cyril conquered Corsica (534) which now, under the exarchate of Africa, became part of the East Roman empire. The succeeding period was one of great misery. Goths and Lombards in turn ravaged the island, which in spite of the prayers of Pope Gregory the Great the exarch of Africa did nothing to defend; the rule of the Byzantines was effective only in grinding excessive taxes out of the wretched population; and, to crown all, in 713 the Mussulmans from the northern coast of Africa made their first descent upon the island. Corsica remained nominally attached to the East Roman empire until Charlemagne, having overthrown the Lombard power in Italy (774), proceeded to the conquest of the island, which now passed into the hands of the Franks. In 806, however, occurred the first of a series of Moorish incursions from Spain. Several times defeated by the emperor's lieutenants, the Moors continually returned, and in 810 gained temporary possession of the island. They were crushed and exterminated by an expedition under the emperor's son Charles, but none the less returned again and again. In 828 the defence of Corsica was entrusted to Boniface II., count of the Tuscan march, who conducted a successful expedition against the African Mussulmans, and returning to Corsica built a fortress in the south of the island which formed the nucleus of the town (Bonifacio) that

bears his name. Boniface's war against the Saracens was continued by his son Adalbert, after he had been restored to his father's dignities in 846; but, in spite of all efforts, the Mussulmans seem to have remained in possession of part of the island until about 930. Corsica, of which Berengar II., king of Italy, had made himself master, became in 962, after his dethronement by Otto the Great, a place of refuge for his son Adalbert, who succeeded in holding the island and in passing it on to his son, another Adalbert. This latter was, however, defeated by the forces of Otto II., and Corsica was once more attached to the marquisate of Tuscany, of which Adalbert was allowed to hold part of the island in fee.

The period of feudal anarchy now began, a general mella of petty lords each eager to expand his domain. The counts of Cinarca, especially, said to be descended from Adalbert, aimed at establishing their supremacy over the whole island. To counteract this and similar ambitions, in the 11th century, a sort of national diet was held, and Sambucuccio, lord of Alando, put himself at the head of a movement which resulted in confining the feudal lords to less than half of the island to the south, and in establishing in the rest, henceforth known as the *Terra di Comune*, a sort of republic composed of autonomous parishes. This system, which survived till the Revolution, is thus described by Jacobi (tom. i. p. 137). "Each parish or commune nominated a certain number of councillors who, under the name of 'fathers of the commune,' were charged with the administration of justice under the direction of a *podestà*, who was as it were their president. The *podestas* of each of the states or enfranchised districts chose a member of the supreme council charged with the making of laws and regulations for the *Terra di Comune*. This council or magistracy was called the Twelve, from the number of districts taking a share in its nomination. Finally, in each district the fathers of the commune elected a magistrate who, under the name of *caporale*, was entrusted with the defence of the interests of the poor and weak, with seeing that justice was done to them, and that they were not made the victims of the powerful and rich."

Meanwhile the south remained under the sway of the counts of Cinarca, while in the north feudal barons maintained their independence in the promontory of Cape Corso. Internal feuds continued; William, marquis of Massa, of the family known later as the Malaspina, was called in by the communes (1020), drove out the count of Cinarca, reduced the barons to order, and in harmony with the communes established a dominion which he was able to hand on to his son. Towards the end of the 11th century, however, the popes laid claim to the island in virtue of the donation of Charlemagne, though the Frankish conqueror had promised at most the reversion of the lands of the Church. The Corsican clergy supported the claim, and in 1077 the Corsicans declared themselves subjects of the Holy See in the presence of the apostolic legate Landolfo, bishop of Pisa. Pope Gregory VII. thereupon invested the bishop and his successors with the island, an investiture confirmed by Urban II. in 1190 and extended into a concession of the full sovereignty. The Pisans now took solemn possession of the island and their "grand judges" (*judices*) took the place of the papal legates. Corsica, valued by the Pisans as by the Vandals as an inexhaustible storehouse of materials for their fleet, flourished exceedingly under the enlightened rule of the great commercial republic. Causes of dissension remained, however, abundant. The Corsican bishops repented their subjection to the Pisan archbishop; the Genoese intrigued at Rome to obtain a reversal of the papal gift to the rivals with whom they were disputing the supremacy of the seas. Successive popes followed conflicting policies in this respect; until in 1138 Innocent II., by way of compromise, divided the ecclesiastical jurisdiction of the island between the archbishops of Pisa and Genoa. This gave the Genoese great influence in Corsica, and the contest between the Pisans and Genoese began to distract the island. It was not, however, till 1195 that the Genoese, by capturing Bonifacio—a nest of pirates preying on the

*The Terra di Comune.*

*Papal sovereignty.*

*Rule of Pisa.*

commerce of both republics—actually gained a footing in the country. For twenty years the Pisans fought to recover the fortress for themselves, until in 1217 the pope settled the matter by taking it into his own hands.

Throughout the 13th century the struggle between Pisans and Genoese continued, reproducing in the island the feud of Ghibellines and Guelphs that was desolating Italy. In order to put a stop to the ruinous anarchy the chiefs of the Terra di Comune called in the marquis Isnard Malaspina; the Pisans set up the count of Cinarca once more; and the war between the marquis, the Pisans and Genoese dragged on with varying fortunes, neither succeeding in gaining the mastery. Then, in 1298, Pope Boniface VIII. added to the complication by investing King James of Aragon with the sovereignty of Corsica and of Sardinia. In 1325, after long delay, the Aragonese attacked and reduced Sardinia, with the result that the Pisans, their sea-power shattered, were unable to hold their own in Corsica. A fresh period of anarchy followed until, in 1347, a great assembly of *caporali* and barons decided to offer the sovereignty of the island to Genoa. A regular tribute was to be paid to the republic; the Corsicans were to preserve their laws and customs, under the council of Twelve in the north and a council of Six in the south; Corsican interests were to be represented at Genoa by an *orator*.

The Genoese domination, which began under evil auspices—for the Black Death killed off some two-thirds of the population—was not destined to bring peace to the island. The feudal barons of the south and the hereditary *caporali* of the north alike resisted the authority of the Genoese governors; and King Peter of Aragon took advantage of their feuds to reassert his claims. In 1372 Arrigo, count of La Rocca, with the assistance of Aragonese troops, made himself master of the island; but his very success stirred up against him the barons of Cape Corso, who once more appealed to Genoa. The republic, busied with other affairs, hit upon the luckless expedient of investing with the governorship of the island a sort of chartered company, consisting of five persons, known as the *Maona*. They attempted to restore order by taking Arrigo della Rocca into partnership, with disastrous results. In 1380 four of the "governors of the Maona" resigned their rights to the Genoese republic, and Leonello Lomellino was left as sole governor. It was he who, in 1383, built Bastia on the north coast, which became the bulwark of the Genoese power in the island. It was not till 1401, after the death of Count Arrigo, that the Genoese domination was temporarily re-established.

Meanwhile Genoa itself had fallen into the hands of the French, and in 1407 Leonello Lomellino returned as governor with the title of count of Corsica bestowed on him by Charles VI. of France. But Vincentello d' Istria, who had gained distinction in the service of the king of Aragon, had captured Cinarca, rallied round him all the communes of the Terra di Comune, proclaimed himself count of Corsica at Biguglia and even seized Bastia. Lomellino was unable to make headway against him, and by 1410 all Corsica, with the exception of Bonifacio and Calvi, was lost to Genoa, now once more independent of France. A feud of Vincentello with the bishop of Mariana, however, led to the loss of his authority in the Terra di Comune; he was compelled to go to Spain in search of assistance, and in his absence the Genoese reconquered the island. Not, however, for long. The Great Schism was too obvious an opportunity for quarrelling for the Corsicans to neglect; and the Corsican bishops and clergy were more ready with the carnal than with spiritual weapons. The suffragans of Genoa fought for Benedict XIII., those of Pisa for John XXIII.; and when Vincentello returned with an Aragonese force he was able to fish profitably in troubled waters. He easily captured Cinarca and Ajaccio, came to terms with the Pisan bishops, mastered the Terra di Comune and built a strong castle at Corte; by 1419 the Genoese possessions in Corsica were again reduced to Calvi and Bonifacio.

At this juncture Alphonso of Aragon arrived, with a large fleet, to take possession of the island. Calvi fell to him; but Bonifacio held out, and its resistance gave time for the

Corsicans, aroused by the tyranny and exactions of the Aragonese, to organize revolt. In the end the siege of Bonifacio was raised, and the town, confirmed in its privileges, became practically an independent republic under Genoese protection. As for Vincentello he managed to hold his own for a while; but ultimately the country rose against him, and in 1435 he was executed as a rebel by the Genoese, who had captured him by surprise in the port of Bastia.

*Aragonese  
inter-  
vention.*

The anarchy continued, while rival factions, nominal adherents of the Aragonese and Genoese, contended for the mastery. Profiting by the disturbed situation, the Genoese doge, Janus da Fregoso, succeeded in reducing the island, his artillery securing him an easy victory over the forces of Count Paolo della Rocca (1441). To secure his authority he built and fortified the new city of San Fiorenzo, near the ruins of Nebbio. But again the Aragonese intervened, and the anarchy reached its height. An appeal to Pope Eugenius IV. resulted in the despatch of a pontifical army of 14,000 men (1444), which was destroyed in detail by a league of some of the *caporali* and most of the barons under the bold leadership of Rinuccio da Leca. A second expedition was more fortunate, and Rinuccio was killed before Biguglia. In 1447 Eugenius was succeeded on the papal throne by Nicholas V., a Genoese, who promptly made over his rights in Corsica, with all the strong places held by his troops, to Genoa. The island was now, in effect, divided between the Genoese republic; the lords of Cinarca, who held their lands in the south under the nominal suzerainty of Aragon; and Galeazzo da Campo Fregoso, who was supreme in the Terra di Comune.

An assembly of the chiefs of the Terra di Comune now decided to offer the government of the island to the Company or Bank of San Giorgio, a powerful commercial corporation established at Genoa in the 14th century.<sup>1</sup> The bank accepted; the Spaniards were driven from the country; and a government was organized. But the bank soon fell foul of the barons, and began a war of extermination against them. Their resistance was finally broken in 1460, when the survivors took refuge in Tuscany. But order had scarcely been established when the Genoese Tommasinoda Campo Fregoso, whose mother was a Corsican, revived the claims of his family and succeeded in mastering the interior of the island (1462). Two years later the duke of Milan, Francesco Sforza, overthrew the power of the Fregoso family at Genoa, and promptly proceeded to lay claim to Corsica. His lieutenant had no difficulty in making the island accept the overlordship of the duke of Milan; but when, in 1466, Francesco Sforza died, a quarrel broke out, and Milanese suzerainty became purely nominal save in the coast towns. Finally, in 1484, Tommasino da Campo Fregoso persuaded the duke to grant him the government of the island. The strong places were handed over to him; he entered into marriage relations with Gian Paolo da Leca, the most powerful of the barons, and was soon supreme in the island.

*The bank  
of San  
Giorgio.*

*Milanese  
inter-  
vention.*

Within three years the Corsicans were up in arms again. A descendant of the Malaspinas who had once ruled in Corsica, Jacopo IV. (d'Appiano), was now prince of Piombino, and to him the malcontents applied. His brother Gherardo, count of Montagnano, accepted the call, proclaimed himself count of Corsica, and, landing in the island, captured Biguglia and San Fiorenzo; whereupon Tommasino da Campo Fregoso discreetly sold his rights to the bank of San Giorgio. No sooner, however, had the bank—with the assistance of the count of Leca—beaten Count Gherardo than the Fregoso family tried to repudiate their bargain. Their claims were supported by the count of Leca, and it cost the agents of the bank some hard fighting before the turbulent baron was beaten and exiled to Sardinia. Twice he returned, and he was not finally expelled from the country till 1501; it was not till 1511 that the other barons were crushed and

<sup>1</sup> See "Conventions entre quelques seigneurs Corses et l'office de St Georges (1453)," in *Bulletin soc. scientif. Corse* (1881-1882), pp. 286, 305, 413, 501, 549 and (1883) 147; also the report of the deputies sent by the bank to Pope Nicholas V. in 1453, *ib.* p. 141.



that the bank could consider itself in secure possession of the island.

If the character of the Corsicans has been distinguished in modern times for a certain wild intractableness and ferocity, the cause lies in their unhappy past, and not least in the character of the rule established by the bank of San Giorgio. The power which the bank had won by ruthless cruelty, it exercised in the spirit of the narrowest and most short-sighted selfishness. Only a shadow of the native institutions was suffered to survive, and no adequate system of administration was set up in the place of that which had been suppressed. In the absence of justice the blood-feud or *vendetta* grew and took root in Corsica just at the time when, elsewhere in Europe, the progress of civilization was making an end of private war. The agents of the bank, so far from discouraging these internecine quarrels, looked on them as the surest means for preventing a general rising. Concerned, moreover, only with squeezing taxes out of a recalcitrant population, they neglected the defence of the coast, along which the Barbary pirates harried and looted at will; and to all these woes were added, in the 16th century, pestilences and disastrous floods, which tended still further to impoverish and barbarize the country.

In these circumstances King Henry II. of France conceived the project of conquering the island. From Corsican mercenaries in

*First  
French  
Interven-  
tion, 1553.*

French service, men embittered by wrongs suffered at the hands of the Genoese, he obtained all the necessary information; by a treaty of alliance concluded at Constantinople (February 1, 1553) with Sultan Suleiman the Magnificent he secured the co-operation of the Turkish fleet. The combined forces attacked the island the same year; the citadel of Bastia fell almost without a blow, and siege was at once laid simultaneously to all the other fortresses. The capitulation of Bonifacio to the Turks, after an obstinate resistance, was followed by the treacherous massacre of the garrison; soon, of all the strong places, the Genoese held Calvi alone. At this juncture the emperor Charles V. intervened; a strong force of imperial troops and Genoese was poured into the island, and the tide of war turned. The details of the struggle that followed, in which the Corsican national hero Sampiero da Bastelica gained his first laurels, are of little general importance. Fortresses were captured and recaptured; and for three years French, Germans, Spaniards, Genoese and Corsicans indulged in a carnival of mutual slaughter and outrage. The outcome of all this was a futile reversion to the *status quo*. In 1556, indeed, the conclusion of a truce left Corsica—with the exception of Bastia—in the hands of the French, who proceeded to set up a tolerable government; but in 1559, by the treaty of Cateau-Cambrésis, the island was restored to the bank of San Giorgio, from which it was at once taken over by the Genoese republic.

Trouble at once began again. The Genoese attempted to levy a tax which the Corsicans refused to pay; in violation of the terms of the treaty, which had stipulated for a universal amnesty, they confiscated the property of Sampiero da Bastelica. Hereupon Sampiero again put himself at the head of the national movement. The suzerainty of the Turk seemed preferable to that of Genoa, and, armed with letters from the king of France, he went to Constantinople to ask the aid of a fleet for the purpose of reducing Corsica to the status of an Ottoman province.<sup>1</sup> All his efforts to secure foreign help were, however, vain; he determined to act alone, and in June 1564 landed at Valinco with only fifty followers. His success was at first extraordinary, and he was soon at the head of 8000 men; but ultimate victory was rendered impossible by the indiscipline among the Corsicans and by the internecine feuds of which the Genoese well knew how to take advantage. For over two years a war was waged in which quarter was given on neither side; but after the assassination of Sampiero in 1567 the spirit of the insurgents was broken. In 1568 an honourable peace, including a general amnesty, was arranged with the Genoese commander Giorgio Doria by Sampiero's son Alphonso

<sup>1</sup> Hammer-Purgstall, *Gesch. des Osmanischen Reichs* (Pest. 1840), ii. 288.

d'Ornano, who with 300 of his friends emigrated to France, where he rose to be a marshal under Henry IV.

From this time until 1729 Corsica remained at peace under the government of Genoa. It was, however, a peace due to lassitude and despair rather than contentment. The settlement of 1568 had reserved a large measure of autonomy to the Corsicans; during the years that followed this was withdrawn piecemeal, until, disarmed and powerless, they were excluded from every office in the administration. Nor did the Genoese substitute any efficient system for that which they had destroyed. In the absence of an effective judiciary the *vendetta* increased; in the absence of effective protection the sea-board was exposed to the ravages of the Barbary pirates, so that the coast villages and towns were abandoned and the inhabitants withdrew into the interior, leaving the most fertile part of the country to fall into the condition of a malarious waste. To add to all this, in 1576 the population had been decimated by a pestilence. Emigration *en masse* continued, and an attempt to remedy this by introducing a colony of Greeks in 1688 only added one more element of discord to the luckless island. To the Genoese Corsica continued to be merely an area to be exploited for their profit; they monopolized its trade; they taxed it up to and beyond its capacity; they made the issue of licences to carry firearms a source of revenue, and studiously avoided interfering with the custom of the *vendetta* which made their fiscal expedient so profitable.<sup>2</sup>

In 1729 the Corsicans, irritated by a new hearth-tax known as the *due seini*, rose in revolt, their leaders being Andrea Colonna Ceccaldi and Luigi Giafferi. As usual, the Genoese were soon confined to a few coast towns; but the intervention of the emperor Charles VI. and the despatch of a large force of German mercenaries turned the tide of war, and in 1732 the authority of Genoa was re-established. Two years later, however, Giacinto Paoli once more raised the standard of revolt; and in 1735 an assembly at Corte proclaimed the independence of Corsica, set up a constitution, and entrusted the supreme leadership to Giafferi, Paoli and Ceccaldi. Though the Genoese were again driven into the fortresses, lack of arms and provisions made any decisive success of the insurgents impossible, and when, on the 12th of March 1736, the German adventurer Baron Theodor von Neuhof arrived with a shipload of muskets and stores and the assurance of further help to come, leaders and people were glad to accept his aid on his own conditions, namely that he should be acknowledged as king of Corsica. On the 15th of April, at Alesani, an assembly of clergy and of representatives of the communes, solemnly proclaimed Corsica an independent kingdom under the sovereignty of Theodore "I." and his heirs. The new king's reign was not fated to last long. The *opéra bouffe* nature of his entry on the stage—he was clad in a scarlet caftan, Turkish trousers and a Spanish hat and feather, and girt with a scimitar—did not, indeed, offend the unsophisticated islanders; they were even ready to take seriously his lavish bestowal of titles and his knightly order "della Liberazione"; they appreciated his personal bravery; and the fact that the Genoese government denounced him as an impostor and set a price on his head could only confirm him in their affection. But it was otherwise when the European help that he had promised failed to arrive, and, still worse, the governments with which he had boasted his influence disclaimed him. In November he thought it expedient to proceed to the continent, ostensibly in search of aid, leaving Giafferi, Paoli and Luca d'Ornano as regents. In spite of several attempts, he never succeeded in returning to the island. The Corsicans, weary of the war, opened negotiations with the Genoese; but the refusal of the latter to regard the islanders as other than rebels made a mutual agreement impossible. Finally the republic decided to seek the aid of France, and in July 1737 a treaty was signed by which the French king bound himself to reduce the Corsicans to order.

<sup>2</sup> Father Cancellotti, who visited every part of the island, estimated the number of murders committed in 20 years at 28,000 (quoted in the article on Corsica in *La Grande Encyclopédie*).

*Revolt  
of 1729.*

*King  
Theodor  
of  
Corsica.*

The object of the French in assisting the Genoese was not the acquisition of the island for themselves so much as to obviate the danger, of which they had long been aware, of its falling into the hands of another power, notably Great Britain. The Corsicans, on the other hand, though ready enough to come to terms with the French king, refused to acknowledge the sovereignty of Genoa even when backed by the power of France. A powerful French force, under the comte de Boissieux, arrived in the spring of 1738, and for some months negotiations proceeded. But the effect of the French guarantee of Corsican liberties was nullified by the demand that the islanders should surrender their arms, and the attempt of Boissieux to enforce the order for disarmament was followed, in the winter of 1738-39, by his defeat at the hands of the Corsicans and by the cutting up of several isolated French detachments. In February 1739 Boissieux died. His successor, the marquis de Maillebois, arrived in March with strong reinforcements, and by a combination of severity and conciliation soon reduced the island to order. Its maintenance, however, depended on the presence of the French troops, and in October 1740 the death of the emperor Charles VI. and the outbreak of the War of the Austrian Succession necessitated their withdrawal. Genoese and Corsicans were once more left face to face, and the perennial struggle began anew.

In 1743 "King Theodore," supported by a British squadron, made a descent on the island, but finding that he no longer possessed a following, departed never to return. The Corsicans, assembled in diet at Casinca, now elected Giampietro Gaffori and Alerio Matra as generals and "protectors of the fatherland" (*protettori della patria*), and began a vigorous onslaught on the Genoese strongholds. They were helped now by the sympathy and active aid of European powers, and in 1746 Count Domenico Rivarola, a Corsican in Sardinian service, succeeded in capturing Bastia and San Fiorenzo with the aid of a British squadron and Sardinian troops. The factious spirit of the Corsicans themselves was, however, their worst enemy. The British commander judged it inexpedient to intervene in the affairs of a country of which the leaders were at loggerheads; Rivarola, left to himself, was unable to hold Bastia—a place of Genoese sympathies—and in spite of the collapse of Genoa itself, now in Austrian hands, the Genoese governor succeeded in maintaining himself in the island. By the time of the signature of the peace of Aix-la-Chapelle, in 1748, the situation of the island had again changed. Rivarola and Matra had departed, and Gaffori was left nominally supreme over a people torn by intestine feuds. Genoa, too, had expelled the Austrians with French aid, and, owing to a report that the king of Sardinia was meditating a fresh attempt to conquer the island, a strong French expedition under the marquis de Cursay had, at the request of the republic, occupied Calvi, Bonifacio, Ajaccio and Bastia. By the terms of the treaty of Aix-la-Chapelle,

Corsica was once more assigned to Genoa, but the French garrison remained, pending a settlement between the republic and the islanders. In view of the intractable temper of the two parties no agreement could be reached; but Cursay's personal popularity served to preserve the peace for a while. His withdrawal in 1752, however, was the signal for a general rising, and once more, at a diet held at Orezza, Gaffori was elected general and protector. In October of the following year, however, he fell victim to a *vendetta* and the nation was once more leaderless. His place was taken for a while by Clemente Paoli, son of Giacinto, who for a year or two succeeded, with the aid of other lieutenants of Gaffori, in holding the Genoese at bay. He was, however, by temperament unfitted to lead a turbulent and undisciplined people in time of stress, and in 1755, at his suggestion, his brother Pasquale was invited to come from Naples and assume the command.

The first task of Pasquale Paoli, elected general in April at an assembly at San Antonio della Casabianca, was to suppress the rival faction led by Emanuele Matra, son of Gaffori's former colleague. By the spring of 1756 this was done, and the Corsicans were able to turn a united front against the Genoese. At

this juncture the French, alarmed by a supposed understanding between Paoli and the British, once more intervened, and occupied Calvi, Ajaccio and San Fiorenzo until 1757, when their forces were once more called away by the wars on the continent. In 1758 Paoli renewed the attack on the Genoese, founding the new port of Isola Rossa as a centre whence the Corsican ships could attack the trading vessels of Genoa. The republic, indeed, was now too weak to attempt seriously to reassert its sway over the island, which, with the exception of the coast towns, Paoli ruled with absolute authority and with conspicuous wisdom. In the intervals of fighting he was occupied in reducing Corsican anarchy into some sort of civilized order. The *vendetta* was put down, partly by religious influence, partly with a stern hand; the surviving oppressive rights of the feudal *signori* were abolished; and the traditional institutions of the Terra di Comune were made the basis of a democratic constitution for the whole island.

As regarded the relations of Corsica all now depended on the attitude of France to which both Paoli and the republic made overtures. In 1764 a French expedition under the comte de Marbeuf arrived, and, by agreement with Genoa, garrisoned three of the Genoese fortresses. Though Genoese sovereignty had been expressly recognized in the agreement authorizing this, it was in effect non-existent. French and Corsicans remained on amicable terms, and the inhabitants of the nominally Genoese towns actually sent representatives to the national *consulta* or parliament. The climax came early in 1767 when the Corsicans captured the Genoese island of Capraja, and occupied Ajaccio and other places, evacuated by the French as a protest against the asylum given to the Jesuits exiled from France. Genoa now recognized that she had been worsted in the long contest, and on the 15th of May 1768 signed a treaty selling the sovereignty of the island to France.

The Corsicans, intent on independence, were now faced with a more formidable enemy than the decrepit republic of Genoa. A section of the people indeed, were in favour of submission; but Paoli himself declared for resistance; and among those who supported him at the *consulta* summoned to discuss the question was his secretary Carlo Buonaparte, father of Napoleon Bonaparte, the future emperor of the French. Into the details of the war that followed, it is impossible to enter here; in the absence of the hoped-for help from Great Britain its issue could not be doubtful; and, though the task of the French was a hard one, by the summer of 1769 they were masters of the island. On the 16th of June Pasquale and Clemente Paoli, with some 400 of their followers, embarked on a British ship for Leghorn. On the 15th of September 1770, a general assembly of the Corsicans was summoned and the deputies swore allegiance to King Louis XV.

For twenty years Corsica, while preserving many of its old institutions, remained a dependency of the French crown. Then came the Revolution, and the island, conformed to the new model, was incorporated in France as a separate department (see Renucci, ii. p. 271 seq.). Paoli, recalled from exile by the National Assembly on the motion of Mirabeau, after a visit to Paris, where he was acclaimed as "the hero and martyr of liberty" by the National Assembly and the Jacobin Club, returned in 1790 to Corsica, where he was received with immense enthusiasm and acclaimed as "father of the country." With the new order in the island, however, he was little in sympathy. In the towns branches of the Jacobin Club had been established, and these tended, as elsewhere, to usurp the functions of the regular organs of government and to introduce a new element of discord into a country which it had been Paoli's life's work to unify. Suspicions of his loyalty to revolutionary principles had already been spread at Paris by Bartolomeo Arena, a Corsican deputy and ardent Jacobin, so early as 1791; yet in 1792, after the fall of the monarchy, the French government, in its anxiety to secure Corsica, was rash enough to appoint him lieutenant-general of the forces and governor (*capo comandante*) of the island. Paoli accepted an office which he had refused two years before at the

Pasquale Paoli.

Corsica sold to France.

French conquest.

Corsica and the revolution of 1789.

Inter-vention of France, 1738.

Sardinian and British Intervention, 1746.

Renewed French Intervention.

hands of Louis XVI. With the men and methods of the Terror, however, he was wholly out of sympathy. Suspected of throwing obstacles in the way of the expedition despatched in 1793 against Sardinia, he was summoned, with the procurator-general Pozzo di Borgo, to the bar of the Convention. Paoli now openly defied the Convention by summoning the representatives of the communes to meet in diet at Corte on the 27th of May.

**Revolt under Paoli.** To the remonstrances of Saliceti, who attended the meeting, he replied that he was rebelling, not against France, but against the dominant faction of whose actions the majority of Frenchmen disapproved. Saliceti thereupon hurried to Paris, and on his motion Paoli and his sympathizers were declared by the Convention *hors la loi* (June 26).

Paoli had already made up his mind to raise the standard of revolt against France. But though the *consulta* at Corte elected him president, Corsican opinion was by no means united. Napoleon Bonaparte, whom Paoli had expected to win over to his views, indignantly rejected the idea of a breach with France, and the Bonapartes were henceforth ranked with his enemies. Paoli now appealed for assistance to the British government, which despatched a considerable force. By the summer of 1794, after hard fighting, the island was reduced, and in June the Corsican assembly formally offered the sovereignty to King George III. The British occupation lasted two years, the island being administered by Sir Gilbert Elliot. Paoli, whose presence was considered inexpedient, was invited to return to England, where he remained till his death. In 1796 Bonaparte, after his victorious Italian campaign, sent an expedition against Corsica. The British, weary of a somewhat thankless task, made no great resistance, and in October the island was once more in French hands. It was again occupied by Great Britain for a short time in 1814, but in the settlement of 1815 was restored to the French crown. Its history henceforth is part of that of France.

See F. Girolami-Cortona, *Géographie générale de la Corse* (Ajaccio, 1893); A. Andrei, *À travers la Corse* (Paris, 1893); Forcioli-Conti, *Notre Corse* (Ajaccio, 1897); R. Le Joindre, *La Corse et les Corses* (Paris, 1904); F. O. Renucci, *Storia di Corsica* (2 vols., Bastia, 1833), fervidly Corsican, but useful; Antonio Pietro Filippini, *Istoria di Corsica* (1st ed., 1594; 2nd ed., corrected and illustrated with unpublished documents by G. C. Gregori, 5 vols., Pisa, 1827-1832); J. M. Jacobi, *Hist. gén. de la Corse*, 2 vols., Paris, 1833-1835), with many unpublished documents; L. H. Caird, *History of Corsica* (London, 1899). Further works and references to articles in reviews, &c., are given in Ulysse Chevalier's *Répertoire des sources, &c., Topo-bibliographie*, t. ii. s.v.

**CORSICANA**, a city and the county-seat of Navarro county, Texas, U.S.A., situated in the N.E. part of the state, about 55 m. S. of Dallas. Pop. (1890) 6285; (1900) 9313, of whom 2399 were of negro descent; (estimated 1906), 12,275. It is served by the Houston & Texas Central, the St Louis South Western, and the Trinity & Brazos Valley railways. It is the centre of a large and productive wheat- and cotton-growing region, which has also numerous oil wells (with a total production in 1907 of 226,311 barrels). The city has two oil refineries, a large cotton gin and a cotton compress, and among its manufactures are cotton-seed oil, cotton-cloth, flour and ice. The total value of the factory product in 1905 was \$1,796,805, being an increase of 50.3% since 1900. Natural gas is extensively used for fuel and for lighting. Corsicana is the seat of the Texas state orphan home and of an Odd Fellows widows' and orphans' home, and has a Carnegie library. Corsicana was named in honour of the wife of a Mexican, Navarro, who owned a large tract of land in the county and from whom the county was named. The first permanent settlement here was made in 1848, and Corsicana was incorporated as a village in 1850 and chartered as a city in 1871.

**CORSINI**, the name of a Florentine princely family, of which the founder is said to be Neri Corsini, who flourished about the year 1170. Like other Florentine nobles the Corsini had at first no titles, but in more recent times they received many from foreign potentates and from the later grand dukes of Tuscany. The emperor Charles IV. created the head of the house a count palatine in 1371; the marquisate of Sismano was conferred on

them in 1620, those of Casigliano and Civitella in 1629, of Lajatico and Orciatice in 1644, of Giovagallo and Tresana in 1652; in 1730 Lorenzo Corsini was elected pope as Clement XII., and conferred the rank of Roman prince and the duchy of Casigliano on his family, and in 1732 they were created grandees of Spain. They own two palaces in Florence, one of which on the Lung' Arno Corsini contains the finest private picture gallery in the city, and many villas and estates in various parts of Italy.

See L. Passerini, *Genealogia e storia della famiglia Corsini* (Florence, 1858); A. von Reumont, *Geschichte der Stadt Rom* (Berlin, 1868); *Almanach de Gotha*. (L. V.)\*

**CORSON, HIRAM** (1828- ), American scholar, was born on the 6th of November 1828, in Philadelphia, Pennsylvania. He held a position in the library of the Smithsonian Institution, Washington D.C. (1849-1856), was a lecturer on English literature in Philadelphia (1859-1865), and was professor of English at Girard College, Philadelphia (1865-1866), and in St John's College, Annapolis, Maryland (1866-1870). In 1870-1871 he was professor of rhetoric and oratory at Cornell University, where he was professor of Anglo-Saxon and English literature (1872-1886), of English literature and rhetoric (1886-1890), and from 1890 to 1903 (when he became professor emeritus) of English literature, a chair formed for him. He edited Chaucer's *Legende of Goode Women* (1863) and *Selections from Chaucer's Canterbury Tales* (1896), and wrote a *Hand-Book of Anglo-Saxon and Early English* (1871), and, among other text-books, *An Elocutionary Manual* (1864), *A Primer of English Verse* (1892), and *Introductions to the study of Browning* (1886, 1889), of Shakespeare (1889) and of Milton (1899). The volume on Shakespeare and the *Jottings on the Text of Macbeth* (1874) contain some excellent Shakespearean criticism. He also published *The University of the Future* (1875), *The Aims of Literary Study* (1895), and *The Voice and Spiritual Education* (1896). He translated the *Satires of Juvenal* (1868) and edited a translation by his wife, Caroline Rollin (d. 1901), of Pierre Janet's *Mental State of Hystericals* (1901).

**CORSEN, WILHELM PAUL** (1820-1875), German philologist, was born at Bremen on the 20th of January 1820, and received his school education in the Prussian town of Schwedt, to which his father, a merchant, had removed. After spending some time at the Joachimsthal Gymnasium in Berlin, where his interest in philological pursuits was awakened by the rector, Meinike, he proceeded to the university, and there came especially under the influence of Böckh and Lachmann. His first important appearance in literature was as the author of *Origines poesis romanae*, by which he had obtained the prize offered by the "philosophical" or "arts" faculty of the university. In 1846 he was called from Stettin, where he had for nearly two years held a post in the gymnasium, to occupy the position of lecturer in the royal academy at Pforta (commonly called Schulpforta), and there he continued to labour for the next twenty years. In 1854 he won a prize offered by the Royal Prussian Academy of Sciences for the best work on the pronunciation and accent of Latin, a treatise which at once took rank, on its publication under the title of *Über Aussprache, Vocalismus, und Betonung der lateinischen Sprache* (1858-1859), as one of the most erudite and masterly works in its department. This was followed in 1863 by his *Kritische Beiträge zur lat. Formenlehre*, which were supplemented in 1866 by *Kritische Nachträge zur lat. Formenlehre*. In the discussion of the pronunciation of Latin he was naturally led to consider the various old Italian dialects, and the results of his investigations appeared in miscellaneous communications to Kuhn's *Zeitschrift für vergleichende Schriftforschung*. Ill-health obliged him to give up his professorship at Pforta, and return to Berlin, in 1866; but it produced almost no diminution of his literary activity. In 1867 he published an elaborate archaeological study entitled the *Alterthümer und Kunstdenkmale des Cistercienserklosters St Marien und der Landesschule Pforta*, in which he gathers together all that can be discovered about the history of the Pforta academy, the German "Eton," and in 1868-1869 he brought out a new edition of his

work on Latin pronunciation. From a very early period he had been attracted to the special study of Etruscan remains, and had at various times given occasional expression to his opinions on individual points; but it was not till 1870 that he had the opportunity of visiting Italy and completing his equipment for a formal treatment of the whole subject by personal inspection of the monuments. In 1874 appeared the first volume of *Über die Sprache der Etrusker*, in which with great ingenuity and erudition he endeavoured to prove that the Etruscan language was cognate with that of the Romans. Before the second volume (published posthumously under the editorship of Kuhn) had received the last touches of his hand, he was cut off in 1875 by a comparatively early death.

**CORT, CORNELIS** (1536–1578), Dutch engraver, was born at Horn in Holland, and studied engraving under Hieronymus Cockx of Antwerp. About 1565 he went to Venice, where Titian employed him to execute the well-known copperplates of St Jerome in the Desert, the Magdalen, Prometheus, Diana and Actaeon, and Diana and Calisto. From Italy he wandered back to the Netherlands, but he returned to Venice soon after 1567, proceeding thence to Bologna and Rome, where he produced engravings from all the great masters of the time. At Rome he founded the well-known school in which, as Bartsch tells us, the simple line of Marcantonio was modified by a brilliant touch of the burin, afterwards imitated and perfected by Agostino Caracci in Italy and Nicolas de Bruyn in the Netherlands. Before visiting Italy, Cort had been content to copy Michael Coxie, F. Floris, Heemskerck, G. Mostaert, Bartholomäus Spranger and Stradan. In Italy he gave circulation to the works of Raphael, Titian, Polidoro da Caravaggio, Baroccio, Giulio Clovio, Muziano and the Zuccari. His connexion with Cockx and Titian is pleasantly illustrated in a letter addressed to the latter by Dominick Lampson of Liège in 1567. Cort is said to have engraved upwards of one hundred and fifty-one plates. In Italy he was known as Cornelio Fiammingo.

**CORTE**, a town of central Corsica, 52 m. N.E. of Ajaccio by the railway between that town and Bastia. Pop. (1906) 4839. The upper town is situated on a precipitous rock overhanging the confluence of the Tavignano and Restonica, the rest of the town lying below it on both banks of the rivers. On the summit of the rock stands a citadel built by Vincentello d'Istria (see CORSICA). Other interesting buildings are the house in which Pasquale Paoli lived while Corte was the seat of his government (1755 to 1769), and the house of another patriot, Giampietro Gaffori, whose wife defended it from the Genoese in 1750. There are statues of Paoli, of General Gaffori, and of General Arrighi di Casanova, duke of Padua (d. 1853). Corte is capital of an arrondissement of the island, has a subprefecture, a tribunal of first instance and a communal college, and manufactures alimentary paste. There are marble quarries in the vicinity, and the town has trade in wine and timber. In the 18th century Corte was the centre of the resistance to the Genoese, and it was the seat of a university erected by Paoli.

**CORTE-REAL, JERONYMO** (1533–1588), Portuguese epic poet, came of a noble Portuguese stock. Of the same family were Gaspar Corte-Real, who in 1500 and 1501 sailed to Labrador and the Arctic seas; and his brothers Miguel and Vasco. Their voyages opened the way for important Portuguese fisheries on the Newfoundland coast (see Henry Harrisse, *Les Corte-Real et leurs voyages au Nouveau-Monde*, and *Gaspar Corte-Real: la date exacte de sa dernière expédition au Nouveau-Monde*, Paris, 1883). In his youth Jeronymo fought in Africa and Asia according to the custom of noblemen in that age. There is a tradition that he was present at the affair of Tangier on the 18th of May 1553, when D. Pedro de Menezes met his death. Returning home, it is supposed about 1570, he spent the rest of his days in retirement. In 1578 he placed his sword at the disposal of King Sebastian for the fatal expedition to Africa, but the monarch dispensed him from the journey (it is said) on account of his age, and in 1586 we find him acting as *provedor* of the *Misericórdia* of Evora. He married D. Luiza da Silva, but left no legitimate issue. Corte-Real was painter as well as soldier and

poet, and one of his pictures is still preserved in the church of S. Antão at Evora. His poetical works are believed to have been composed in his old age at the mansion on his estate near Evora, known as "Valle de Palma." *O Segundo cerco de Diu*, an epic in 21 cantos, deals with the historic siege of that Indian island-fortress of the Portuguese. First printed in 1574, it had a second edition in 1783, while a Spanish version appeared at Alcalá in 1597. *Ausriada*, an epic in 15 cantos celebrating the victory of Don John of Austria over the Turks at Lepanto, was written in Spanish and published in 1578. King Philip II. accepted the dedication in flattering terms and visited the poet when he came to Portugal. *Naufragio de Sepulveda*, an epic in 17 cantos, describes the tragic shipwreck on the South African coast and the death of D. Manoel de Sepulveda with his beautiful wife and young children, a disaster which drew some feeling stanzas from Camoens (*Lusiads*, v. 46). The poem was published four years after the death of Corte-Real by his heirs, and had two later editions, while a Spanish version appeared in Madrid in 1624 and a French in Paris in 1844. *Auto dos quatro novissimos do homem* is a short poem printed in 1768. Except the *Naufragio de Sepulveda*, which is highly considered in Portugal, Corte-Real's poetry has hardly stood the test of time, and critics of later generations have refused to ratify the estimate formed by contemporaries, who considered him the equal, if not the superior, of Camoens. His lengthy epics suffer from a want of sustained inspiration, and are marred by an abuse of epithet, though they contain episodes of considerable merit, vigorous and well-coloured descriptive passages, and exhibit a pure diction.

See *Subsidios para a biographia do poeta Jeronymo Corte-Real* (Evora, 1899); also Ernesto do Canto's Memoir on the family in Nos. 23 and 24 of the *Archivo dos Azores*, and Dr Sousa Viterbo's *Trabalhos nauticos dos Portuguezes*, ii. 153 et seq. (E. PR.)

**CORTES, HERNAN** or **HERNANDO** (1485–1547), Spanish soldier, the conqueror of Mexico, was born at Medellin, a small town of Estremadura, in 1485. He belonged to a noble family of decayed fortune, and, being destined for the law, was sent, at fourteen years of age, to the university of Salamanca; but study was distasteful to him, and he returned home in 1501, resolved to enter upon a life of adventure. He arranged to accompany Ovando, who had been appointed to the command of San Domingo, but was prevented from joining the expedition by an accident that happened to him in a love adventure. He next sought military service under the celebrated Gonsalvo de Córdoba, but a serious illness frustrated his purpose. At last, in 1504, he set out, according to his first plan, for San Domingo, where he was kindly received by Ovando. He was then only nineteen, and remarkable for a graceful physiognomy and amiable manners, as well as for skill and address in all military exercises. He remained in San Domingo, where Ovando had successively conferred upon him several lucrative and honourable employments, until 1511, when he accompanied Diego Velazquez in his expedition to the island of Cuba. Here he became alcalde de Santiago, and displayed great ability on several trying occasions.

An opportunity was soon afforded him of showing his powers as a military leader. Juan Grijalva, lieutenant of Velazquez, had just discovered Mexico, but had not attempted to effect a settlement. This displeased the governor of Cuba, who superseded Grijalva, and entrusted the conquest of the newly discovered country to Cortes. The latter hastened his preparations, and, on the 18th of November 1518, he set out from Santiago, with 10 vessels, 600 or 700 Spaniards, 18 horsemen and some pieces of cannon. Scarcely had he set sail, however, when Velazquez recalled the commission which he had granted to Cortes, and even ordered him to be put under arrest; but the attachment of the troops, by whom he was greatly beloved, enabled him to persevere in spite of the governor; and on the 4th of March 1519 he landed on the coast of Mexico. Advancing along the gulf, sometimes taking measures to conciliate the natives, and sometimes spreading terror by his arms, he took possession of the town of Tobasco. The noise of the artillery, the appearance of the floating fortresses which had transported the Spaniards over the ocean, and the horses on which they fought, all new objects to the

natives, inspired them with astonishment mingled with terror and admiration; they regarded the Spaniards as gods, and sent them ambassadors with presents. Cortes here learned that the native sovereign was called Montezuma; that he reigned over an extensive empire, which had lasted for three centuries; that thirty vassals, called caciques, obeyed him; and that his riches were immense and his power absolute. No more was necessary to inflame the ambition of the invader, who did not hesitate to undertake the conquest of this great empire, which could only be effected by combining stratagem and address with force and courage. He laid the foundation of the town of Vera Cruz, caused himself to be elected captain-general of the new colony, and burned his vessels to cut off the possibility of retreat and show his soldiers that they must either conquer or perish. He then penetrated into the interior of the country, drew to his camp several caciques hostile to Montezuma, and induced these native princes to facilitate his progress. The republic of Tlaxcala, which was hostile to Montezuma, opposed him; but he routed its army, which had resisted all the forces of the Mexican empire, dictated peace on moderate terms and converted the people into powerful auxiliaries. His farther advance was in vain attempted to be checked by an ambuscade laid by the inhabitants of Cholula, on whom he took signal vengeance.

Surmounting all other obstacles he arrived, with 6000 natives and a handful of Spaniards, in sight of the immense lake on which was built the city of Mexico, the capital of the empire. Montezuma received him with great pomp, and his subjects, believing Cortes to be a descendant of the sun, prostrated themselves before him. The first care of Cortes was to fortify himself in one of the beautiful palaces of the prince, and he was planning how to possess himself of the riches of so opulent an empire, when intelligence reached him that a general of the emperor, who had received secret orders, had just attacked the garrison of Vera Cruz and killed several of his soldiers. The head of one of the Spaniards was sent to the capital. This event undeceived the Mexicans, who had hitherto believed the Spaniards to be immortal, and necessarily altered the whole policy of Cortes. Struck with the greatness of the danger, surrounded by enemies, and having only a handful of soldiers, he conceived and instantly executed a most daring project. Having repaired with his officers to the palace of the emperor, he announced to Montezuma that he must either accompany him or perish. Being thus master of the person of the monarch, he next demanded that the Mexican general and his officers who had attacked the Spaniards should be delivered into his hands; and when this had been done he caused these unfortunate men, who had only obeyed the orders of their sovereign, to be burned alive before the gates of the imperial palace. During this cruel execution Cortes entered the apartment of Montezuma, and caused him to be loaded with irons, in order to force him to acknowledge himself a vassal of Charles V. The unhappy prince yielded, and was restored to a semblance of liberty on presenting the fierce conqueror with 600,000 marks of pure gold, and a prodigious quantity of precious stones. Scarcely had he reaped the fruits of his audacity, however, when he was informed of the landing of a Spanish army, under Narvaez, which had been sent by Velazquez to compel him to renounce his command. In this emergency Cortes acted with his usual decision and courage. Leaving 200 men at Mexico, under the orders of his lieutenant (Alvarado), he marched against Narvaez, whom he defeated and made prisoner, and he then enlisted under his standard the Spanish soldiers who had been sent to attack him. On his return to the capital, however, he found that the Mexicans had revolted against the emperor and the Spaniards, and that dangers thickened around him. Montezuma perished in attempting to address his revolted subjects; the latter, having chosen a new emperor, attacked the headquarters of Cortes with the utmost fury, and, in spite of the advantage of firearms, forced the Spaniards to retire, as the only means of escaping destruction. Their rear-guard, however, was cut in pieces, and they suffered severely during the retreat, which was continued during six days. Elated with their success, the Mexicans offered battle in the plain of Otumba. This was what Cortes desired, and

it proved their destruction. Cortes gave the signal for battle, and, on the 7th of July 1520, gained a victory which decided the fate of Mexico. Immediately afterwards he proceeded to Tlaxcala, assembled an auxiliary army of natives, subjected the neighbouring provinces, and then marched a second time against Mexico, which, after a gallant defence of several months, was retaken on the 13th of August 1521.

These successes were entirely owing to the genius, valour and profound but unscrupulous policy of Cortes; and the account of them which he transmitted to Spain excited the admiration of his countrymen. The extent of his conquests, and the ability he had displayed, effaced the censure which he had incurred by the irregularity of his operations; and public opinion having declared in his favour, Charles V., disregarding the pretensions of Velazquez, appointed him governor and captain-general of Mexico, at the same time conferring on him the valley of Oaxaca, which was erected (1529) into a marquisate, with a considerable revenue. But although his power was thus confirmed by royal authority, and although he exerted himself to consolidate Spanish domination throughout all Mexico, the means he employed were such that the natives, reduced to despair, took arms against the Spaniards. This revolt, however, was speedily subdued, and the Mexicans were everywhere forced to yield to the ascendancy of European discipline and valour. Guatemotzin, who had been recognized as emperor, and a great number of caciques, accused of having conspired against the conquerors, were publicly executed, with circumstances of great cruelty, by order of Cortes. Meanwhile the court of Madrid, dreading the ambition and popularity of the victorious chief, sent commissioners to watch his conduct and thwart his proceedings; and whilst he was completing the conquest of New Spain his goods were seized by the fiscal of the Council of the Indies, and his retainers imprisoned and put into irons. Indignant at the ingratitude of his sovereign, Cortes returned in person to Spain to appeal to the justice of the emperor, and appeared there with great splendour. The emperor received him with every mark of distinction, and decorated him with the order of St Iago. Cortes returned to Mexico with new titles but diminished authority, a viceroy having been entrusted with the administration of civil affairs, whilst the military department, with permission to push his conquests, was all that remained to Cortes. This division of powers became a source of continual dissension, and caused the failure of the last enterprises in which he engaged. Nevertheless, in 1536, he discovered the peninsula of Lower California, and surveyed a part of the gulf which separates it from Mexico.

At length, tired of struggling with adversaries unworthy of him, whom the court took care to multiply, he returned to Europe, hoping to confound his enemies. But Charles V. received him coldly. Cortes dissembled, redoubled the assiduity of his attendance on the emperor, accompanied him in the disastrous expedition to Algiers in 1541, served as a volunteer, and had a horse killed under him. This was his last appearance in the field, and if his advice had been followed the Spanish arms would have been saved from disgrace, and Europe delivered nearly three centuries earlier from the scourge of organized piracy. Soon afterwards he fell into neglect, and could scarcely obtain an audience. The story goes that, having forced his way through the crowd which surrounded the emperor's carriage, and mounted on the doorstep, Charles, astonished at an act of such audacity, demanded to know who he was. "I am a man," replied the conqueror of Mexico proudly, "who has given you more provinces than your ancestors left you cities." So haughty a declaration of important services ill-requited could scarcely fail to offend a monarch on whom fortune had lavished her choicest favours. Cortes, overwhelmed with disgust, withdrew from court, passed the remainder of his days in solitude, and died, near Seville, on the 2nd of December 1547.

The only writings of Cortes are five letters on the subject of his conquests, which he addressed to Charles V. The best edition of them is that of Don Francisco Antonio Lorenzana, archbishop of Mexico, entitled *Historia de Nueva-España escrita por su esclarecido conquistador, Hernan Cortes, aumentada con otros documentos y notas* (Mexico, 1770, 4to), a work the noble simplicity of which attests



the truth of the recital it contains. An English translation of the letters, edited by Francis A. MacNutt, was published in 1908. The conquests of Cortes have been described with pompous elegance by Antonio de Solis in his *Historia de la conquista de Mexico* (1684), and with more truth and simplicity by Bernardo Diaz del Castillo in his work under the same title (1632). See also Sir Arthur Helps's *Life of Hernando Cortes* (2 vols., London, 1871), F. A. MacNutt's *Fernando Cortes* ("Heroes of the Nations" Series, 1909), and the bibliography to MEXICO.

**CORTES**, a Spanish term literally signifying the "courts," and applied to the states, or assembly of the states, of the kingdom. (See SPAIN and PORTUGAL.)

**CORTI, LODOVICO**, COUNT (1823-1888), Italian diplomatist, was born at Gambarano on the 28th of October 1823. Early involved with Benedetto Cairoli in anti-Austrian conspiracies, he was exiled to Turin, where he entered the Piedmontese foreign office. After serving as artillery officer through the campaign of 1848, he was in 1850 appointed secretary of legation in London, whence he was promoted minister to various capitals, and in 1875 ambassador to Constantinople. Called by Cairoli to the direction of foreign affairs in 1878, he took part in the congress of Berlin, but unwisely declined Lord Derby's offer for an Anglo-Italian agreement in defence of common interests. At Berlin he sustained the cause of Greek independence, but in all other respects remained isolated, and excited the wrath of his countrymen by returning to Italy with "clean hands." For a time he withdrew from public life, but in 1881 was again sent to Constantinople by Cairoli, where he presided over the futile conference of ambassadors upon the Egyptian question. In 1886 he was transferred to the London embassy, but was recalled by Crispi in the following year through a misunderstanding. He died in Rome on the 9th of April 1888.

**CORTLAND**, a city and the county-seat of Cortland county, New York, U.S.A., in the central part of the state, on Tioughnioga river, at the junction of its E. and W. branches. Pop. (1890) 8590; (1900) 9014, of whom 682 were foreign born; (1905) 11,272; (1910) 11,504. It is served by the Delaware, Lackawanna & Western and the Lehigh Valley railways. The Franklin Hatch library and a state normal and training school (opened in 1869) are in Cortland. The city has important manufactories of wire, and wire-cloth and netting (one of the largest in America), cabs, carriages and waggons, iron and steel, wall-paper, dairy supplies, corundum wheels, and clothing. The value of the city's factory products increased from \$3,063,828 in 1900 to \$4,574,191 in 1905 or 49.3%. The town of Cortlandville, which formed a part of the Phelps and Gorham Purchase, was first settled in 1792, and until 1829 was a part of the town of Homer; from which in the latter year it was separated, and made the county-seat. In 1900 the village of Cortland in the town of Cortlandville was chartered as a city.

See H. C. Goodwin, *Cortland County and the Border Wars of New York* (New York, 1859).

**CORTONA**, a town and episcopal see of Italy, in the province of Arezzo, 18 m. S. by E. from the town of Arezzo by rail. The ancient and modern names are identical. Pop. (1901) of town, 3579; commune, 29,296. The highest point of Cortona, a medieval castle (Fortezza), is situated 2130 ft. above sea-level on a hill commanding a splendid view, and is approached by a winding road. It is surrounded by its ancient Etruscan walls, which for the greater part of the circuit are fairly well preserved. They are constructed of parallelepipedal blocks of limestone, finely jointed (though the jointing has often been spoilt by weathering), and arranged in regular courses which vary in size in different parts of the enceinte. Near the N.W. angle some of the blocks are 7 to 8½ ft. long and 2½ ft. high, while on the W. side they are a good deal smaller—sometimes only 1 ft. high (see F. Noack in *Römische Mitteilungen*, 1897, 184). Within the town are two subterranean vaulted buildings in good masonry, of uncertain nature, some other remains under modern buildings, and a concrete ruin known as the "Bagni di Bacco." The museum of the Accademia Etrusca, a learned body founded by Ridolfino Venuti in 1726, is situated in the Palazzo Pretorio; it contains some Etruscan objects, among which may be specially noted a magnificent bronze lamp with 16 lights, of remarkably

fine workmanship, found in 1740, at the foot of the hill, two votive hands and a few other bronzes, and a little gold jewellery. The library has a good MS. of Dante. The cathedral, originally a Tuscan Romanesque building of the 11th-12th centuries, is now a fine Renaissance basilica restored in the 18th century, containing some paintings by Luca Signorelli, a native of the place. Opposite is the baptistery, with three fine pictures by Fra Angelico. S. Margherita, just below the Fortezza, is an ugly modern building occupying the site of a Gothic church of 1294, and containing a fine original rose window and reliefs from the tomb of the saint by Angelo e Francesco di maestro Pietro d'Assisi. Other works by Signorelli are to be seen elsewhere in the town, especially in S. Domenico; Pietro Beretini (Pietro da Cortona, 1596-1669) is hardly represented here at all. Below the town is the massive tomb chamber (originally subterranean, but now lacking the mound of the earth which covered it) known as the Grotta di Pitagora (grotto of Pythagoras). To the E. is the church of S. Maria del Calcinajo, a fine early Renaissance building by Francesco di Giorgio Martini of Siena, with fine stained glass windows.

The foundation of Cortona belongs to the legendary period of Italy. It appears in history as one of the strongholds of the Etruscan power; but in Roman times it is hardly mentioned. Dionysius's statement that it was a colony (i. 26) is probably due to confusion.

See G. Dennis, *Cities and Cemeteries of Etruria* (London, 1883), ii. 394 seq.; A. Della Cella, *Cortona Antica* (Cortona, 1900). (T. As.)

**CORUMBÁ**, a town and river port of Brazil on the W. bank of the Paraguay river, 1986 m. above Buenos Aires and 486 m. above the Paraguayan frontier. Pop. (1890) 8414. Corumbá is a fortified military post, has the large Ladario naval arsenal, where small river boats are built and repaired, and is the commercial entrepôt of the state of Matto Grosso. It is near the Bolivian frontier and is strongly garrisoned. Although the climate is extremely hot, the neighbouring country has many large cattle farms. Corumbá is one of the most important places in the interior of Brazil.

**CORUNDUM**, a mineral composed of native alumina ( $Al_2O_3$ ), remarkable for its hardness, and forming in its finer varieties a valuable gem-stone. Specimens were sent from India to England in the 18th century, and were described in 1798 by the Hon. C. Greville under the name of corundum—a word which he believed to be the native name of the stone (Hindi, *kurund*; Tamil, *kurundam*; Sanskrit, *kuruvinda*, "ruby"). The finely coloured, transparent varieties include such gem-stones as the ruby and sapphire, whilst the impure granular and massive forms are known as emery. The term corundum is often restricted to the remaining kinds, i.e. those crystallized and crystalline varieties which are not sufficiently transparent and brilliant for ornamental purposes, and which were known to the older mineralogists as "imperfect corundum." Such varieties were termed by J. Black, in consequence of their hardness, adamantine spar, but this name is now usually restricted to a hair-brown corundum, remarkable for a pearly sheen on the basal plane.

Corundum crystallizes in the hexagonal system. In fig. 1, which is a form of ruby, the prism *a* is combined with a hexagonal pyramid *n*, a rhombohedron *R*, and the basal pinacoid *C*. In fig. 2, which represents a typical crystal of sapphire, the prism *s* is associated with the acute pyramids *b*, *r*, and a rhombohedron *a*. Other crystals show a tabular habit, consisting usually of the basal pinacoid with a rhombohedron, and it is notable that this habit is said to be characteristic of corundum which has consolidated from a fused magma. Corundum has no true

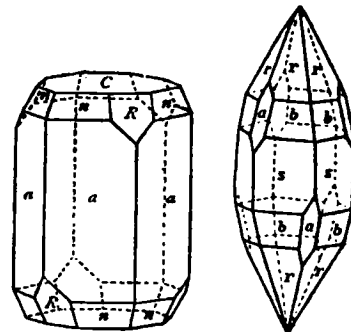

FIG. 1.

FIG. 2.

cleavage, but presents parting planes due to the structure of the crystal, which have been studied by Prof. J. W. Judd.

Next to diamond, corundum is the hardest known mineral. Its hardness is generally given as 9, but there are slight variations in different stones, sapphire being rather harder than ruby, and ruby than common corundum. The colours are very varied, and it is probable that iron is responsible for many of the tints, though chromium is a possible agent in certain cases. The transparent varieties are often distinguished as "Oriental" stones. (See RUBY and SAPPHIRE.) Corundum is used largely for watch-jewels, and for bearings in electrical apparatus.

The coloured corundums fit for gem-stones come chiefly from Ceylon, Burma, Siam and Montana. Coarse dull corundum is found in many localities, and usually has higher commercial value as an abrasive agent than emery, which is less pure. The coarse corundum, however, is often partially hydrated or otherwise altered, whereby its hardness is diminished. In India, where the native lapidaries use corundum-sticks and rubbers formed of the powdered mineral cemented with lac, it occurs in the Salem district, Madras, in Mysore and in Rewa. Large deposits of corundum exist in the United States, especially in N. Carolina and Georgia, where they are associated with peridotites, often near contact with gneiss. The mineral has been extensively worked, as at Corundum Hill, Macon county, N.C., near which, in 1871, were discovered numerous rubies, sapphires and pebbles of coarse corundum in the bed of a river. Corundum occurs also at many localities in Montana, where the crystals are often of gem quality. They are found mostly as loose crystals in gravel, but are known also in igneous rocks like andesite and lamprophyre. Prof. J. H. Pratt, who has studied the occurrence both in Montana and in N. Carolina, considers that the alumina was dissolved in a molten magma, from which it separated at an early period of consolidation, as illustrated by the experiments of J. Morozewicz. Corundum occurs also in Canada in an igneous rock, a nepheline-syenite, associated with Laurentian gneiss. Important deposits were discovered by the Geological Survey in 1896, in Hastings county, Ontario; and corundum is now worked there and in Renfrew county. New South Wales, Queensland and Victoria are other localities for corundum. The mineral is found also in the Urals and the Ilmen Mountains, in the Alps (in dolomite), in the basalts of the Rhine, and indeed as a subordinate rock-constituent corundum seems to enjoy a wide distribution, being found even in the British Isles.

See Joseph Hyde Pratt, "Corundum and its Occurrence and Distribution in the United States," *Bulletin U.S. Geol. Surv.*, No. 269 (1906); T. H. Holland, *Economic Geology of India* (2nd ed.), part I. (1898). (F. W. R.\*)

**CORUNNA**, a maritime province in the extreme north-west of Spain; forming part of Galicia, and bounded on the E. by Lugo, S. by Pontevedra, W. and N. by the Atlantic Ocean. Pop. (1900) 653,556; area, 3051 sq. m. The coast of Corunna is exposed to the full force of the Atlantic; it forms one succession of fantastically shaped promontories, divided by bays and estuaries which often extend for many miles inland, with reefs and small islands in their midst. Though well lighted, this coast is very dangerous to navigation, gales and fogs being frequent in winter and spring. The most conspicuous headlands are Cape Ortegal and Cape de Vares, the most northerly points of the Spanish seaboard, and Capes Finisterre and Toriñana in the extreme west. The principal bays are those of Santa Marta, Ferrol and Corunna, on the north; Corcubion, Muros y Noya and Arosa, on the west. Wild and rugged though this region appears to travellers at sea, the mountains which overspread the interior are covered with forests and pastures, and watered by an abundance of small rivers and streams. The climate is mild and singularly equable, but the rainfall is very heavy. All the fruits and vegetables of northern Europe thrive in the sheltered valleys, and the cultivation of cherries, strawberries, peas and onions, for export, ranks among the most profitable local industries. Heavy crops of wheat, rye, maize and sugar-beet are raised. The wines of Corunna are heady and of inferior flavour. Cattle-breeding, once a flourishing industry, had greatly declined by the beginning

of the 20th century, owing to foreign competition. All along the coast there are valuable fisheries of sardines, lobsters, cod, hake and other fish. Copper, tin and gold are procured in small quantities, and other minerals undoubtedly exist. The exports consist chiefly of farm produce and fish; the imports, of coal and textiles from England, petroleum from the United States, marble from Italy, salt fish from Norway and Newfoundland, and hides. The principal towns are Corunna, the capital and chief port (pop. 1900, 43,971); Ferrol (25,281), another seaport; Santiago de Compostela (24,120), famous as a place of pilgrimage; Carballo (13,032); Ortigueira (18,426) and Ribeira (12,218). These are described under separate headings. Along the coast there are numerous trading and fishing stations of minor importance. Railway communication is very defective. From Corunna a line passes south-eastward to Lugo and Madrid, and from Santiago another line goes southward to Vigo and Oporto; but the centre and the north-west of the province are, to a great extent, inaccessible except by road; and many, even of the main highways, are ill-constructed and ill-kept. Very few Spanish provinces have so high a birthrate, but the population increases very slowly owing to emigration. For a description of the peasantry, who are distinguished in many respects from those inhabiting other parts of Spain, see GALICIA.

**CORUNNA** (Span. *La Coruña*; Fr. *La Corogne*; Eng. formerly often *The Groyne*), the capital of the province described above; in 43° 22' N., and 8° 22' W.; on the bay of Corunna, an inlet of the Atlantic Ocean. Pop. (1900) 43,971. The principal railways of north-western Spain converge on Corunna, and afford direct communication with Madrid and Oporto. Corunna consists of an upper and a lower town, built respectively on the eastern side of a small peninsula, and on the isthmus connecting the peninsula with the mainland. The upper town is the more ancient, and is still surrounded by walls and bastions, and defended by a citadel; but it has been gradually outgrown by the lower, which, though at first a mere fishing village, as its name of *Pescaderia* implies, is now comparatively well built, and has many broad and handsome streets. There is little remarkable in the public buildings, although the churches of Santiago and the Colegiata date respectively from the 12th and 13th centuries, and there are several convents, two hospitals, a palace for the captain-general of Galicia, a theatre, a school of navigation, an arsenal and barracks. The harbour is on the east. Though difficult to approach in stormy weather, it is completely sheltered, and accommodates vessels drawing 22 ft. It is defended by several forts, of which the most important are San Diego, on the east, and San Antonio, on the west. These fortifications are of little practical value on the landward side, as they are commanded by a hill which overlooks the town. The so-called Tower of Hercules, on the north, has been increased by modern additions to a height of nearly 400 ft., and is surmounted by a fine revolving light. Many foreign steamers call here, for emigrants or mails, on their way to South America. Upwards of 1200 merchant ships, mostly British, entered the port in 1905. The exports are chiefly agricultural produce, wine and fish; the imports are coal, colonial products, and manufactured goods. Chief among the industrial establishments is a state tobacco factory; the sardine and herring fisheries also employ a large number of the inhabitants.

Corunna, possibly at first a Phoenician settlement, is usually identified with the ancient *Ardobrica*, a seaport mentioned by the 1st-century historian, Pomponius Mela, as in the country of the *Artabri*, from whom the name of *Portus Artabrorum* was given to the bay on which the city is situated. In the middle ages, and probably at an earlier period, it was called *Caronium*; and this name is much more probably the origin of the present designation than the Latin *Columna* which is sometimes put forward. The harbour has always been of considerable importance, but it is only in comparatively modern times that it has made a figure in history. In 1588 it gave shelter to the Invincible Armada; in 1598 the town was captured and burned by the British under Drake and Norris. In 1747, and again in 1805, the bay was the scene of a naval victory of the British over the French; and on the 16th of January 1809 a battle took place

in the neighbourhood, which is celebrated in British military annals (see PENINSULAR WAR). The French under Marshal Soult attempted to prevent the embarkation of the English under Sir John Moore, but were successfully repulsed in spite of their superior numbers. Moore was mortally wounded and died shortly afterwards. He was hastily buried in the ramparts near the sea; a monument in the Jardin de San Carlos raised by the British government commemorates his death. The town joined the revolutionary movement of 1820, but in 1823 it was forced to capitulate by French troops. In 1836 it was captured by the Carlists. Corunna suffered heavily when Spain was deprived of Cuba and Porto Rico by the Spanish-American War of 1898, for it had hitherto had a thriving trade with these colonies.

**CORVÉE**, in feudal law, the term used to designate the unpaid labour due from tenants, whether free or unfree, to their lord; hence any forced labour, especially that exacted by the state, the word being applied both to each particular service and to the system generally. Though the corvée formed a characteristic feature of the feudal system, it was, as an institution, much older than feudalism, and was already developed in its main features under the Roman Empire. Thus, under the Roman system, personal services (*operae*) were due from certain classes of the population not only to the state but to private proprietors. Apart from the obligations (*operae officiales*) imposed on freedmen as a condition of their enfranchisement, which in the country usually took the form of unpaid work on the landlord's domain, the semi-servile *coloni* were bound, besides paying rent in money or kind, to do a certain number of days' unremunerated labour on that part of the estate reserved by the landed proprietor. The state also exacted personal labour (*operae publicae*), in lieu of taxes, from certain classes for such purposes as the upkeep of roads, bridges and dykes; while the inhabitants of the various regions were responsible for the maintenance of the posting system (*cursus publicus*), for which horses, carts or labour would be requisitioned.

Under the Frankish kings, who in their administration followed the Roman tradition, this system was preserved. Thus for the repair of roads, or other public works, within their jurisdiction the counts were empowered to requisition the labour of the inhabitants of the *pagus*, while the *missi* and other public functionaries on their travels were entitled to demand from the population *en route* entertainment and the means of transport for themselves and their belongings. It was, however, the economic revolution which between the 6th and 10th centuries converted the Gallo-Roman estates into the feudal model, and the political conditions under which the officials of the Frankish empire developed into hereditary feudal nobles, that evolved the system of the corvée as it existed throughout the middle ages and, in some countries, survived far into the 19th century. The Roman estate had been cultivated by free farmers, by *coloni*, and by slave labour. Under Frankish rule the farmers became *coloni* or *hospites*, the slaves, serfs. The estate was now habitually divided into the lord's domain (*terra indominicata, dominicum*) and a series of allotments (*mansi*), parcels of land distributed by lot to the cultivators of the domain, who held them, partly by payment of rent in money or kind, partly by personal service and labour on the domain, these obligations both as to their nature and amount being very rigorously defined and permanently fixed in the case of each *mansus* and passing with the land to each new tenant. They varied, of course, very greatly according to the size of the holding and the needs of the particular estate, but they possessed certain common characteristics which are everywhere found. Luchaire (*Manuel*, p. 346) divides all corvées into two broad categories, (1) corvées properly so called, (2) military services. The second of these, so far as the obligation to serve in the host (*Hostis et equitatus*) is concerned, was common to all classes of feudal society; though the obligation of villeins to keep watch and ward (*gueta, warda*) and to labour at the building or strengthening of fortifications (*muragium, munitio castris*) are special corvées. We are, however, mainly concerned with the first category, which may again be subdivided

into two main groups, (1) personal service of men and women (*manoperae, manuum operae*, Fr. *manœuvres*, manual labour), (2) carriage (*carroperae, carragia, carrata*, &c., Fr. *charrois*), *i.e.* service rendered by means of carts, barrows or draught animals. These again were divided into fixed services (*operae rigae*) and exceptional services, demanded when the others proved insufficient. To these latter was given in the 8th century the name of *operae corrogatae* (*i.e.* requisitioned works, from *rogare*, to request). From this term (corrupted into *corvatae, curvadae, corveiae*, &c.) is derived the word corvée, which was gradually applied as a general term for all the various services.

As to the nature of these corvées it must be noted that in the middle ages the feudal lords had replaced the centralized state for all administrative purposes, and the services due to them by their tenants and serfs, were partly in the nature of rent in the form of labour, partly those which under the Roman and Frankish monarchs had been exacted in lieu of taxes, and which the feudal lords continued to impose as sovereigns of their domains. To the former class belonged the service of personal labour in the fields, of repairing buildings, felling trees, threshing corn, and the like, as well as the hauling of corn, wine or wood; to the latter belonged that of labouring on the roads, of building and repairing bridges, castles and churches, and of carrying letters and despatches. Corvées were further distinguished as *real*, *i.e.* attached to certain parcels of land, and *personal*, *i.e.* due from certain persons.

In spite of the fact that the corvées were usually strictly defined by local custom and by the contracts of tenancy, and that, in an age when currency was rare, payment in personal labour was a convenience to the poor, the system was open to obvious abuses. With the growth of communal life in the towns the townsmen early managed to rid themselves of these burdensome obligations either by purchase, or by exchanging the obligation of personal work for that of supplying carts, draught animals and the like. In the country, however, the system survived all but intact; and, so far as it was modified, was modified for the worse. Whatever safeguards the free cultivators may have possessed, the serfs were almost everywhere—especially in the 10th and 11th centuries—actually as well as nominally in this respect at the mercy of their lords (*corvéables à merci*), there being no limit to the amount of money or work that could be demanded of them. The system was oppressive even when the nobles to whom these services were paid gave something in return, namely, protection to the cultivator, his family and his land; they became intolerable when the development of the modern state deprived the land-owners of their duties, but not of their rights. In the case of France, in the 17th century the so-called *corvée royale* was added to the burden of the peasants, *i.e.* the obligation to do unpaid labour on the public roads, an obligation made general in 1738; and this, together with the natural resentment of men at the fact that the land which their ancestors had bought was still subject to burdensome personal obligations in favour of people whom they rarely saw and from whom they derived no benefit, was one of the most potent causes of the Revolution. By the Constituent Assembly personal corvées were abolished altogether, while owners of land were allowed the choice of continuing real corvées or commuting them for money. The corvée as an incident of land tenure has thus disappeared in France. The *corvée royale* of repairing the roads, however, abolished in 1789, was revived, under the name of *prestation*, under the Consulate, by the law of 4 Thermidor an X., modified by subsequent legislation in 1824, 1836 and 1871. Under these laws the duty of keeping the roads in repair is still vested in the local communities, and all able-bodied men are called upon either to give three days' work or its equivalent in money to this purpose. It is precisely the same system as that in force under the Roman Empire, and if it differ from the corvée it is mainly in the fact that the burden is equitably distributed, and that the work done is of actual value to those who do it.

As regards other countries, the corvée was everywhere, sooner or later, abolished with the serfdom of which it was the principal

incident (see SERFDOM). Though so early as 1772 Maria Theresa had endeavoured to mitigate its hardships in her dominions (in Hungary unpaid labour was only to be demanded of the serfs on 52 days in the year!) it survived longest in the Austrian empire, being finally abolished by the revolution of 1848. The duty of personal labour on the public roads is, however, still maintained in other countries besides France. This was formerly the case in England also, where the occupiers of each parish who, by the common law, had access to the roads were responsible also for their upkeep. An act of 1555 imposed four days of forced labour for the repair of roads, and an act of Elizabeth (5 Eliz. c. 13) raised the number of days to six, or the payment of a composition instead. This system of turnpikes, dating from 1663, which gradually extended over the whole of England, lessened the burden of this system of taxation, so far as main roads were concerned, but the greater number of the local roads were subject to repair by statutory labour until the Highways Act 1835, by which highways were put under the direction of a parish surveyor, and the necessary expenses met by a rate levied on the occupiers of land. In Scotland, statutory labour on highways was created by an act of 1719, and abolished in 1883.

In Egypt, the *corvée* has been employed from time immemorial, more especially for the purpose of cleaning out the irrigation canals. In the days when only one harvest a year was reaped, this forced labour was not a very great burden, but the introduction of cotton and the sugar-cane under Mehemet Ali changed the conditions. These latter are crops which require watering at various seasons of the year, and very often the fellah was called away for work in the canals at times when his own crops required the utmost attention. Moreover, the inequality of the *corvée* added to the evil. In some districts it was possible to purchase exemption, and the more wealthy paid no more for the privilege than the humblest fellah, consequently the *corvée* fell with undue hardship on the poorer classes. Under the premiership of Riaz Pasha the *corvée* was gradually abolished in Egypt between the years 1888 and 1891, and a small rate on the land substituted to provide the labour necessary for cleaning the canals. The *corvée* is now employed only to a limited extent to guard the banks of the Nile during flood.

See Du Cange, *Glossarium inf. et med. Lat. s.v.* "Corvatae"; A. Luchaire, *Manuel des institutions françaises* (Paris, 1892), pp. 346-349; *La Grande Encyclopédie, s.v.*, with bibliography. For further works see the bibliography to the article SERFDOM.

**CORVEY**, a place in the Prussian province of Westphalia, on the Weser, a mile north of the town of Höxter, with which it communicates by an avenue of lime trees. During the middle ages it was famous for its great Benedictine abbey, which was founded and endowed by the emperor Louis the Pious about 820, and received its name from having been first occupied by a body of monks coming from Corbie in Picardy. The bones of St Vitus, the patron saint of Saxony, were removed thither according to legend in 836, but apart from this attraction, Corvey became the centre of Christianity in Saxony and a nursery of classical studies. The abbot was a prince of the Empire, and Corvey was made a bishopric in 1783. In 1803 the abbey was secularized, in 1815 its lands were given to Prussia, and in 1822 they were bestowed on Victor Amadeus, landgrave of Hesse-Rotenburg, by whom they were bequeathed, in 1834, to Prince Victor of Hohenlohe-Schillingsfürst, duke of Ratibor. The abbey, which is now used as a residence, possesses a magnificent library of 150,000 volumes especially rich in old illustrated works, though the ancient collection due to the literary enthusiasm of the Benedictines is no longer extant. Here in 1517 the manuscript of the five first books of the *Annals* of Tacitus was discovered. Here Widukind wrote his *Res gestae Saxonicae*. Here, also, the librarian and poet Hoffmann von Fallersleben lived and worked. The *Annales Corbejenses 648-1148* of the monks can be read in the *Monumenta Germaniae historica*, Band iii. The *Chronicon Corbejense*, published by A. C. Wedekind in 1823, has been declared by S. Hirsch and Waitz (*Kritische Prüfung*, Berlin, 1839) to be a forgery.

See P. Wigand, *Geschichte der Abtei Korvey* (Höxter, 1819); and M. Meyer, *Zur ältern Geschichte Corveys und Höxters* (Paderborn, 1893).

**CORVINUS, JÁNOS [JOHN]** (1473-1504), illegitimate son of Matthias Hunyadi, king of Hungary, and one Barbara, supposed to be the daughter of a burgher of Breslau. He took his name from the raven (*corvus*) in his father's escutcheon. Matthias originally intended him for the Church, but on losing all hope of offspring from his consort Queen Beatrice, determined, towards the end of his life, to make the youth his successor on the throne. He loaded him with honours and riches, till he was by far the wealthiest magnate in the land. He publicly declared him his successor, created him a prince with vast apanages in Silesia, made the commandants of all the fortresses in the kingdom take an oath of allegiance to him, and tried to arrange a marriage for him with Bianca Maria Sforza of Milan, a project which was frustrated by the intrigues of Queen Beatrice. Matthias also intended to make the recognition of János as prince royal of Hungary by the emperor Frederick a condition precedent of relinquishing all or part of the conquered hereditary domains of the house of Habsburg; but his sudden death left the matter still pending, and the young prince suddenly found himself alone in the midst of enemies. The inexperienced and irresolute youth speedily became the victim of the most shameful chicanery. He was first induced formally to resign his claims to the throne, on the understanding that he was to be compensated with the crown of Bosnia. He was then persuaded to retire southwards with the royal treasures which Matthias had confided to him, whereupon an army immediately started in pursuit, scattered his forces, and robbed him of everything. Meanwhile the diet had elected Vladislav of Bohemia king (July 15, 1490), to whom János hastened to do homage, in order to save something from the wreck of his fortunes. He was also recognized as prince of Slavonia and duke of Troppau, but compelled to relinquish both titles five years later. On the invasion of Hungary by Maximilian, he shewed his loyalty to the crown by relinquishing into the hands of Vladislav the three important fortresses of Pressburg, Komárom and Tata, which had been entrusted to him by his father. But now, encouraged by his complacency, the chief dignitaries, headed by the palatine Stephen Zapolya, laid claim to nearly all his remaining estates and involved him in a whole series of costly processes. This they could do with perfect impunity, as they had poisoned the mind of the indolent and suspicious king against their victim. In 1496 Corvinus married Beatrice, the daughter of Bernard Frangepán. His prospects now improved, and in 1498 he was created perpetual ban of Croatia and Slavonia. From 1499 to 1502 he successfully defended Bosnia against the Turks, and in the following year aspired to the dignity of palatine, but was defeated by a combination of Queen Beatrice and his other enemies. He died on the 12th of October 1504, leaving one son, Prince Christopher, who died on the 17th of March 1505.

See Gyula Schönherr, *János Corvinus Hunyadi* (Hung.) (Budapest, 1894). (R. A. B.)

**CORVUS, MARCUS VALERIUS** (c. 370-270 B.C.), Roman general of the early republican period. According to the legend a raven settled on his helmet during his combat with a gigantic Gaul, and distracted the enemy's attention by flying in his face. He was twice dictator and six times consul, and occupied the curule chair twenty-one times. In his various campaigns he defeated successively the Gauls, the Volscians, the Samnites, the Etruscans and the Marsians. His most important victory (343) was over the Samnites at Mount Gaurus.

See Livy vii. 26-42, x. 2-11.

**CORWEN** ("the white choir"), a market town of Merionethshire, Wales, on branches of the London & North Western and the Great Western railways; 10 m. from Llangollen, through the Glyn Dyfrdwy (Dee Vale). Pop. (1901) 2680. Telford's road, raised on the lower Berwyn range side and overlooking the Dee, opens up the picturesqueness of Corwen, historically interesting from the reminiscences of Wales's last struggle for independence under Owen Glendower. In the old parish church was traditionally Owen's pew; his knife, fork and dagger, are at the neighbouring Rûg (Rhûg); his palace, 3 m. distant at Sychnant (dry stream). Here is the church dedicated to St

Julian, archbishop of St David's (d. 1009), with "the college," an almshouse endowed by William Eyton of Plas Warren, Shropshire. The old British fort, Caer Drewyn, one of a chain of forts from Dyserth to Canwyd, is the supposed scene of Glendower's retreat under Henry IV., and here Owen Gwynedd is said to have prepared to repulse Henry II. To the N.E. are the Clwyd hills; to the S. the Berwyn range, to the S.W. Arran Mawddy and Cadair (Cader) Idris; to the W. the two Arenigs; to the N.W. Snowdon. Corwen is a favourite station for artists and anglers. Besides the Dee, there are several streamlets, such as the Trystion, which forms the Rhaiadr Cynwyd (waterfall), the Ceudiog, and the Alwen.

**CORWIN, THOMAS** (1794-1865), American statesman and orator, was born in Bourbon county, Kentucky, on the 29th of July 1794. In 1798 his father, Matthias Corwin (1761-1829), removed to what later became Lebanon, Ohio, where the son worked on a farm, read much, and in 1817 was admitted to the bar. As an advocate he was at once successful, but after 1831 he devoted his attention chiefly to politics, identifying himself first with the Whig and after 1858 with the Republican party. He was a member of the lower house of the Ohio legislature in 1821, 1822 and 1829, and of the national House of Representatives from 1831 to 1840; was governor of Ohio in 1840-1842; served in the United States Senate from 1845 to 1850; was secretary of the treasury in the cabinet of President Fillmore in 1850-1853; was again a member of the national House of Representatives from 1859 to 1861; and from 1861 to 1864 was minister of the United States to Mexico—a position of peculiar difficulty at that time. As a legislator he spoke seldom, but always with great ability, his most famous speech being that of the 11th of February 1847 opposing the Mexican War. In 1860 he was chairman of the House "Committee of Thirty-three," consisting of one member from each state, and appointed to consider the condition of the nation and, if possible, to devise some scheme for reconciling the North and the South. He is remembered chiefly as an orator. Many anecdotes have been told to illustrate his kindness, his inimitable humour, and his remarkable eloquence. He died at Washington, D.C., on the 18th of December 1865.

See the *Life and Speeches of Thomas Corwin* (Cincinnati, 1896), edited by Josiah Morrow; and an excellent character sketch, *Thomas Corwin* (Cincinnati, 1881), by A. P. Russell.

**CORY, WILLIAM JOHNSON** (1823-1892), English schoolmaster and author, son of Charles Johnson of Torrington, Devonshire, was born on the 9th of January 1823. He was educated at Eton and King's College, Cambridge. At Cambridge he gained the chancellor's medal for an English poem on Plato in 1843, and the Craven Scholarship in 1844. In 1845, after graduating at the university, he was made an assistant master at Eton, where he remained for some twenty-six years. He has been called "the most brilliant Eton tutor of his day." He had a great influence on his pupils, and he defended the Etonian system against the criticism of Matthew James Higgins. In 1872, having inherited an estate at Halsdon and assumed the name of Cory, he left Eton. He married late in life, and after four years spent in Madeira he settled in 1882 at Hampstead. He died on the 11th of June 1892. He proved his genuine lyrical power in *Ionica* (1858), which was republished with some additional poems in 1891. He also produced *Lucretilla* (1871), a work on the writing of Latin verses; *Iophon* (1873), on Greek Iambics; and *Guide to Modern History from 1815 to 1835* (1882). Extracts from the *Letters and Journals of William Cory*, which contains much paradoxical and suggestive criticism, were edited by F.W. Cornish and published by private subscription in 1897.

His elder brother, Charles Wellington Johnson Furse (1821-1900), who, on the death of his father in 1854, took the name of Furse, was canon and archdeacon of Westminster from 1894 till his death. The artist Charles Wellington Furse, A.R.A. (1868-1904), was a son of Archdeacon Furse.

**CORYATE, THOMAS** (1577?-1617), English traveller and writer, was born at Odcombe, Somersetshire, where his father, the Rev. George Coryate, prebendary of York Cathedral, was

rector. Educated at Westminster school and at Oxford, he became a kind of court fool, eventually entering the household of Prince Henry, the eldest son of James I. In 1611 he published a curious account of a prolonged walking tour undertaken in 1608, under the title of *Coryate's Crudities hastily gobbled up in Five Months Travels in France, Italy, &c.* At the command of Prince Henry, verses in mock praise of the author, and intended originally to persuade some bookseller to undertake the publication of the *Crudities*, were added to the volume. These commendatory verses, written in a number of languages, and some in a mixture of languages, by Ben Jonson, Donne, Chapman, Drayton and others, were afterwards published (1611) by themselves as the *Odcombian Banquet*. The book contains a clear and interesting account of Coryate's travels, and, being the first of its kind, was extremely popular. It is now very rare, and the copy in the Chetham library is said to be the only perfect one. In the same year was published a second volume of a similar kind, *Coryats Crambe, or his Coleworte twice Sodden*. In 1612 he set out on another journey, which also was mostly performed on foot. He visited Greece, the Holy Land, Persia and India; from Agra and Ajmere he sent home an account of his adventures. Some of his letters were published in 1616 under the title of *Letters from Asmere, the Court of the Great Mogul, to several Persons of Quality in England*, and some fragments of his writings were included in *Purchas his Pilgrimes* in 1625. Coryate was a curious and observant traveller; he gives accounts of inscriptions he had copied, of the antiquities of the towns he passed through, and of manners and customs, from the Italian pronunciation of Latin to the new-fangled use of forks. He acquired a knowledge of Turkish, Persian and Hindustani in the course of his travels, and on being presented by the English ambassador, Sir Thomas Roe, to the Great Mogul, he delivered a speech in Persian. His journeys were performed at small expense, for he says that he spent only three pounds between Aleppo and Agra, and often lived "competently" for a penny a day. Coryate died at Surat in 1617.

*Coryate's Crudities*, with his letters from India, was reprinted from the edition of 1611 in 1776, and at the Glasgow University Press (2 vols., 1905). The *Odcombian Banquet* was ridiculed by John Taylor, the Water Poet, in his *Laugh and be Fat, or a Commentary on the Odcombian Banquet* (1613) and two other satires.

**CORYBANTES** (Gr. Κορυβάντες), in Greek mythology, half divine, half demonic beings, bearing the same relation to the Asiatic Great Mother of the Gods that the Curetes bear to Rhea. From their first appearance in literature, they are already often identified or confused with them, and are distinguished only by their Asiatic origin and by the more pronounced orgiastic nature of their rites. Various accounts of their origin are given: they were earth-born, sons of Cronus, sons of Zeus and Calliope, sons of Rhea, of Ops, of the Great Mother and a mystic father, of Apollo and Thalia, of Athena and Helios. Their names and number were as indistinct even to the ancients as those of the Curetes and Idaean Dactyli. Like the Curetes, Dactyli, Telchines and Cabeiri (*q.v.*), however, they represent primitive gods of procreative significance, who survived in the historic period as subordinate deities associated with a form of the Great Mother goddess, their relation to the Great Mother of the Gods, Cybele, being comparable with that of Attis (*q.v.*). They may have been represented or impersonated by priests in her rites as Attis was, but they were also, like him, not actual priests in the first instance, but objects of worship in which a frenzied dance, with accompaniment of flute music, the beating of tambourines, the clashing of cymbals and castanets, wild cries and self-infliction of wounds—the whole culminating in a state of ecstasy and exhaustion—were the most prominent features. The dance of the Corybantic priests, like that of the priests who represented the Curetes, may have originated in a primitive faith in the power of noise to avert evil. Its psychic effect, both upon the dancer and upon the mystic about whom he danced during the initiation of the Cybele-Attis mysteries, made it a widely known and popular feature of the cult.

In art the Corybantes appear, usually not more than two or three in number, fully armed and executing their orgiastic



dance in the presence of the Great Mother, her lions and Attis. They sometimes appear with the child Dionysus, between whose cult and that of the Mother there was a close affinity. (G. Sn.)

**CORYDON**, a town and the county-seat of Harrison county, Indiana, U.S.A., on Indian Creek, about 21 m. W. by S. of Louisville, Kentucky. Pop. (1890) 880; (1900) 1610. Corydon is served by the Louisville, New Albany & Corydon railway, which connects at Corydon Junction, 8 m. N., with the Southern railway. There are sulphur springs here, and the town is a summer and health resort. Wyandotte Cave is several miles W. of Corydon. Corydon is in an agricultural region, and there are valuable quarries in the neighbourhood; among the town's manufactures are waggons, and building and lithographic stone. Corydon was settled about 1805, and was the capital of Indiana Territory from 1813 to 1816, and of the state until 1824. The convention which framed the first state constitution met here in June 1816. The original state house, an unpretentious two-storey stone building, is still standing. Corydon was captured by the Confederates during Gen. Morgan's raid on the 9th of July 1863.

**CORYPHEUS** (from Gr. *κορυφή*, the top of the head), in Attic drama, the leader of the chorus. Hence the term (sometimes in an Anglicized form "coryphe") is used for the chief or leader of any company or movement. In 1856 in the university of Oxford there was founded the office of Coryphaeus or Praecentor, whose duty it was to lead the musical performances directed by the Choragus (*q.v.*). The office ceased to exist in 1899.

**COS**, or **STANKO** (Ital. *Stanchio*, Turk. *Istan-keui*, by corruption from *Ἰὸς τὰν Κῶν*), an island in that part of the Turkish archipelago which was anciently known as the Myrtoan Sea, not far from the south-western corner of Asia Minor, at the mouth of the Gulf of Halicarnassus, or Bay of Budrum. Its total length is about 25 m. and its circumference about 74. Its population is estimated at about 10,000, of whom nearly all are Greeks.

A considerable chain of mountains, known to the ancients as Oromedon, or Prion, extends along the southern coast with hardly a break except near the island of Nisyros; so that the greatest versant and most important streams turn towards the north. The whole island is little more than a mass of limestone, and consequently unites great aridity in the drier mountain regions with the richest fertility in the alluvial districts. As the attention of the islanders is mainly directed to the culture of their vineyards, which yield the famous sultana raisins, a considerable proportion of the arable land is left untouched, though wheat, barley and maize are sown in some quarters, and melons and sesamum seed appear among the exports. The Cos lettuce is well known. Fruit, especially grapes, is exported in large quantities to Egypt, mostly in local sailing boats. The wild olive is abundant enough, but neglected; and cotton, though it thrives well, is grown only in small quantities. As the principal harbour, in spite of dredging operations, is fit only for smaller vessels, the island is not of so much commercial importance as it would otherwise be; but since 1868 it has been regularly visited by steamers. The only town in the island is Cos, or Stanko, at the eastern extremity, remarkable for its fortress, founded by the knights of Rhodes, and for the gigantic plane-tree in the public square. The fortress preserves in its walls a number of interesting architectural fragments. The plane-tree has a circumference of about 30 ft., and its huge and heavy branches have to be supported by pillars; of its age there is no certain knowledge, but the popular tradition connects it with Hippocrates. The town is supplied by an aqueduct, about 4 m. in length, with water from a hot chalybeate spring, which is likewise named after the great physician of the island. The villages of Pyli and Kephala are interesting, the former for the Greek tomb of a certain Charmylos, and the latter for a castle of the knights of St John and the numerous inscriptions that prove that it occupies the site of the chief town of the ancient deme of Isthmos. The most interesting site on the island is the precinct of Asclepius, which was excavated in 1900-1904 on the slope of Mount Prion, about 2 m. from the town of Cos. It consists of three terraces, the uppermost containing a temple, a cypress

grove and porticoes; the middle, which is the earliest portion, two or three temples, an altar, and other buildings; and the lower a kind of sacred agora enclosed by porticoes. The precinct had been enlarged and reconstructed at various times. The earliest buildings on the middle terrace probably date from the 6th century B.C. The temple on the upper terrace, with the imposing flight of steps by which it is approached, seems to belong to the 2nd century B.C. when the whole precinct was enlarged and reconstructed. After a destructive earthquake, the whole appears to have been rebuilt by Xenophon, the physician and poisoner of the emperor Claudius. The final destruction was brought about by the earthquake of A.D. 554. Among other things the precinct contains a fountain of water with medicinal properties. It is doubtful whether this water is brought from Burinna, the famous fountain of Hippocrates in the mountain above.

*History.*—Cos was a Dorian colony with a large contingent of settlers from Epidaurus who took with them their Asclepius cult and made their new home famous for its sanatoria. The other chief sources of the island's wealth lay in its wines, and in later days, in its silk manufacture. Its early history is obscure. During the Persian wars it was ruled by tyrants, but as a rule it seems to have been under an oligarchic government. In the 5th century it joined the Delian League, and after the revolt of Rhodes served as the chief Athenian station in the south-eastern Aegean (411-407). In 366 a democracy was instituted. After helping, in the Social War (357-355), to weaken Athenian power it fell for a few years to the Carian prince Maussollus. In the Hellenistic age Cos attained the zenith of its prosperity. Its alliance was valued by the kings of Egypt, who used it as an outpost for their navy to watch the Aegean. As a seat of learning it rose to be a kind of provincial branch of the museum of Alexandria, and became a favourite resort for the education of the princes of the Ptolemaic dynasty; among its most famous sons were the physician Hippocrates, the painter Apelles, the poets Philetas and, perhaps, Theocritus (*q.v.*). Following the lead of its great neighbour, Rhodes, Cos generally displayed a friendly attitude towards the Romans; in A.D. 53 it was made a free city. In A.D. 1315 it was occupied by the Knights of St John; in 1523 it passed under Ottoman sway. Except for occasional incursions by corsairs and some severe earthquakes the island has rarely had its peace disturbed.

*AUTHORITIES.*—L. Ross, *Reisen nach Kos, &c.* (Halle, 1852), pp. 11-29, and *Reisen auf den griechischen Inseln* (Stuttgart, 1840-1845), ii. 86 ff.; O. Rayet, *Mémoire sur l'île de Cos* (Paris, 1876); M. Dubois, *De Co Insula* (Paris and Nancy, 1884); W. Paton and E. Hicks, *The Inscriptions of Cos* (Oxford, 1891); B. V. Head, *Historia Numorum* (Oxford, 1887), pp. 535-537; *Archäol. Anzeiger*, 1905, i.; for coins see also *NUMISMATICS: Greek*, § "Calymna and Cos." (E. Gr.; M. O. B. C.)

**COSA**, an ancient city of Etruria, on the S.W. coast of Italy, close to the Via Aurelia, 4½ m. E.S.E. of the modern town of Orbetello. Apparently it was not an independent Etruscan town, but was founded as a colony by the Romans in the territory of the Volceientes, whom they had recently conquered, in 273 B.C. The town was strongly fortified, and the walls, about a mile in circuit, with three gates, and seventeen projecting rectangular towers at intervals, are in places preserved to a height of over 30 ft. on the outside, and 15 on the inside. The lower part is built of polygonal, the upper of rectangular, blocks, and the masonry is of equal fineness all through, so that a difference of date cannot be assumed; such a change of technique is not without parallel in Greece (F. Noack in *Römische Mitteilungen*, 1897, 194). Within the city no remains are visible. The place was of importance as a fortress; it was approached by a branch road which diverged from the Via Aurelia at the post station of Succosa, at the foot of the hill on which the town stood. The harbour, too, was of some importance. In the 5th century we hear of it as deserted, and in the 9th a town called Ansedonia took its place for a short time, but itself soon perished, though it has left its name to the ruins.

See G. Dennis, *Cities and Cemeteries of Etruria* (London, 1883), ii. 245. (T. As.)

**COSEL**, or **KOSEL**, a town of Germany, in the Prussian province of Silesia, at the junction of the Klodnitz and the Oder, 29 m. S.E. of Oppeln by rail. Pop. (1905) 7085. It has an Evangelical and a Roman Catholic church, an old château and a grammar-school (Progymnasium). Its industries are of some importance, including a manufactory of cellulose (employing 1200 hands), steam saw- and flour-mills and a petroleum refinery. There is a lively trade by river.

The first record of Cosel dates from 1286. From 1306 to 1359 it was the seat of an independent duchy held by a cadet line of the dukes of Teschen. In 1532 it fell to the emperor, was several times besieged during the Thirty Years' War, and came into Prussian possession by the treaty of Breslau in 1742. Frederick II. converted it into a fortress, which was besieged in vain by the Austrians in 1758, 1759, 1760 and 1762. In 1807 it withstood another siege, by the Bavarian allies of Napoleon. The fortifications were razed and their site converted into promenades in 1874.

**COSENZ, ENRICO** (1812-1898), Italian soldier, was born at Gaeta, on the 12th of January 1812. As captain of artillery in the Neapolitan army he took part in the expedition sent by Ferdinand II. against the Austrians in 1848; but after the *coup d'état* at Naples he followed General Guglielmo Pepe in disobeying Ferdinand's order for the withdrawal of the troops, and proceeded to Venice to aid in defending that city. As commandant of the fort of Marghera, Cosenz displayed distinguished valour, and after the fall of the fort assumed the defence of the Piazzale, where he was twice wounded. Upon the fall of Venice he fled to Piedmont, where he remained until, in 1859, he assumed the command of a Garibaldian regiment. In 1860 he conducted the third Garibaldian expedition to Sicily, defeated two Neapolitan brigades at Piale (August 23), and marched victoriously upon Naples, where he was appointed minister of war, and took part in organizing the *plébiscite*. During the war of 1866 his division saw but little active service. After the war he repeatedly declined the portfolio of war. In 1881, however, he became chief of the general staff, and held that position until a short time before his death at Rome on the 7th of August 1898.

**COSENZA** (anc. *Consentia*), a town and archiepiscopal see of Calabria, Italy, the capital of the province of Cosenza, 755 ft. above sea-level, 43 m. by rail S. by W. of Sibari, which is a station on the E. coast railway between Metaponto and Reggio. Pop. (1901) town, 13,841; commune, 20,857. It is situated on the slope of a hill between the Crati and Busento, just above the junction, and is commanded by a castle (1250 ft.). The Gothic cathedral, consecrated in 1222, on the site of another ruined by an earthquake in 1184, goes back to French models in Champagne, and is indeed unique in Italy. It contains the Gothic tomb of Isabella of Aragon, wife of Philip III. of France, and also the tomb of Louis III., duke of Anjou; but it has been spoilt by restoration both inside and out. S. Domenico has a fine rose window. The Palazzo del Tribunale (law courts) is a fine building, and the upper town contains several good houses of rich proprietors of the province; while the lower portion is unhealthy. Earthquakes, and a fire in 1901, have done considerable damage to the town.

The ancient *Consentia* is first named as the burial place of Alexander of Epirus in about 330 B.C. In 204 it became Roman, though it was more under the influence of Greek culture. It is mentioned by Strabo as the chief town of the Bruttii, and frequently spoken of in classical authors as an important place. It lay on the Via Popillia. Varro speaks of its apple trees which gave fruit twice in the year and Pliny praises its wine also. It is the more surprising that in the whole of its territory no inscriptions, either Greek or Latin, have ever been found, those that are recorded by some writers being fabrications. In A.D. 410 Alaric fell in battle here and was buried, it is said, in the bed of the Busento, which was temporarily diverted and then allowed to resume its natural course. Cosenza became an archbishopric in the 11th century. In 1461 it was taken by Roberto Orsini, and suffered severely. It was the home of a scientific academy founded by the philosopher Bernardino Telesio (1509-1588).

In 1555-1561 it was the centre of the persecution by the Inquisition of the Waldenses who had settled there towards the end of the 14th century. (T. As.)

**COSHOCTON**, a city and the county-seat of Coshocton county, Ohio, U.S.A., at the confluence of the Tuscarawas and the Walhonding rivers, with the Muskingum river, and about 70 m. E.N.E. of Columbus. Pop. (1890) 3672; (1900) 6473 (364 foreign-born); (1910) 9603. It is served by the Pennsylvania, the Pittsburgh, Cincinnati, Chicago & St Louis (controlled by the Pennsylvania), and the Wheeling & Lake Erie railways. The city is built on a series of four broad terraces, the upper one of which has an elevation of 824 ft. above sea-level, and commands pleasant views of the river and the valley. It has a public library. Coshocton is the commercial centre of an extensive agricultural district and has manufactories of paper, glass, flour, china-ware, cast-iron pipes and especially of advertising specialties. The municipality owns and operates its water-works. Coshocton occupies the site of a former Indian village of the same name—the chief village of the Turtle tribe of the Delawares. This village was destroyed by the whites in 1781. The first settlement by whites was begun in 1801; and in 1802 the place was laid out as a town and named Tuscarawas. In 1811, when it was made the county-seat, the present name was adopted. Coshocton was first incorporated in 1833.

**COSIN, JOHN** (1594-1672), English divine, was born at Norwich on the 30th of November 1594. He was educated at Norwich grammar school and at Caius College, Cambridge, where he was scholar and afterwards fellow. On taking orders he was appointed secretary to Bishop Overall of Lichfield, and then domestic chaplain to Bishop Neile of Durham. In December 1624 he was made a prebendary of Durham, and in the following year archdeacon of the East Riding of Yorkshire. In 1628 he took his degree of D.D. He first became known as an author in 1627, when he published his *Collection of Private Devotions*, a manual stated to have been prepared by command of Charles I., for the use of the queen's maids of honour.<sup>1</sup> This book, together with his insistence on points of ritual in his cathedral church and his friendship with Laud, exposed him to the suspicions and hostility of the Puritans; and the book was rudely handled by William Prynne and Henry Burton. In 1628 Cosin took part in the prosecution of a brother prebendary, Peter Smart, for a sermon against high church practices; and the prebendary was deprived. In 1634 Cosin was appointed master of Peterhouse, Cambridge; and in 1640 he became vice-chancellor of the university. In October of this year he was promoted to the deanery of Peterborough. A few days before his installation the Long Parliament had met; and among the complainants who hastened to appeal to it for redress was the ex-prebendary, Smart. His petition against the new dean was considered; and early in 1641 Cosin was sequestered from his benefices. Articles of impeachment, were, two months later, presented against him, but he was dismissed on bail, and was not again called for. For sending the university plate to the king, he was deprived of the mastership of Peterhouse (1642). He thereupon withdrew to France, preached at Paris, and served as chaplain to some members of the household of the exiled royal family. At the Restoration he returned to England, was reinstated in the mastership, restored to all his benefices, and in a few months raised to the see of Durham (December 1660). At the convocation in 1661 he played a prominent part in the revision of the prayer-book, and endeavoured with some success to bring both prayers and rubrics into completer agreement with ancient liturgies. He administered his diocese with conspicuous ability and success for about eleven years; and applied a large share of his revenues to the promotion of the interests of the Church, of schools and of charitable institutions. He died in London on the 15th of January 1672.

Cosin occupies an interesting and peculiar position among the churchmen of his time. Though a ritualist and a rigorous enforcer of outward conformity, he was uncompromisingly hostile to Roman Catholicism, and most of his writings illustrate this antagonism. In France he was on friendly terms with

<sup>1</sup> See John Evelyn's *Diary* (Oct. 12, 1651).

Huguenots, justifying himself on the ground that their non-episcopal ordination had not been of their own seeking, and at the Savoy conference in 1661 he tried hard to effect a reconciliation with the Presbyterians. He differed from the majority of his colleagues in his strict attitude towards Sunday observance and in favouring, in the case of adultery, both divorce and the re-marriage of the innocent party. He was a genial companion, frank and outspoken, and a good man of business.

Among his writings (most of which were published posthumously) are a *Historia Transubstantiationis Papalis* (1675), *Notes and Collections on the Book of Common Prayer* (1710) and *A Scholastic History of the Canon of Holy Scripture* (1657). A collected edition of his works, forming 5 vols. of the *Oxford Library of Anglo-Catholic Theology*, was published between 1843 and 1855; and his *Correspondence* (2 vols.) was edited by Canon Ormsby for the Surtees Society (1868-1870).

**COSMAS**, of Alexandria, surnamed from his maritime experiences *Indicopleustes*, merchant and traveller, flourished during the 6th century A.D. The surname is inaccurate, since he never reached India proper; further, it is doubtful whether Cosmas is a family name, or merely refers to his reputation as a cosmographer. In his earlier days he had sailed on the Red Sea and the Indian Ocean, visiting Abyssinia and Socotra and apparently also the Persian Gulf, western India and Ceylon. He subsequently became a monk, and about 548, in the retirement of a Sinai cloister, wrote a work called *Topographia Christiana*. Its chief object is to denounce the false and heathen doctrine of the rotundity of the earth, and to vindicate the scriptural account of the world. Photius, who had read it, calls it a "commentary on the Octateuch" (meaning the eight books of Ptolemy's great geographical work; according to some, the first eight books of the Old Testament). According to Cosmas the earth is a rectangular plane, covered by the vaulted roof of the firmament, above which lies heaven. In the centre of the plane is the inhabited earth, surrounded by ocean, beyond which lies the paradise of Adam. The sun revolves round a conical mountain to the north—round the summit in summer, round the base in winter, which accounts for the difference in the length of the day. Cosmas is supposed by some to have been a Nestorian. Although not to be commended from a theological standpoint, the *Topographia* contains some curious information. Especially to be noticed is the description of a marble seat discovered by him at Adulis (Zula) in Abyssinia, with two inscriptions recounting the heroic deeds and military successes of Ptolemy Euergetes and an Axumitic king. It also contains in all probability the oldest Christian maps. From allusions in the *Topographia* Cosmas seems to have been the author of a larger cosmography, a treatise on the motions of the stars, and commentaries on the Psalms and Canticles. Photius (*Cod.* 36) speaks contemptuously of the style and language of Cosmas, and throws doubt upon his truthfulness. But the author himself expressly disclaims any claims to literary elegance, which in fact he considers unsuited to a Christian circle of readers, and the accuracy of his statements has been confirmed by later travellers.

The *Topographia* will be found in Migne, *Patrologia Graeca*, lxxxviii.; an edition by G. Siefert is promised in the Teubner series. See H. Gelzer, "Kosmas der Indienfahrer," in *Jahrbücher für protestantische Theologie*, ix. (1883) and C. R. Beazley, *The Dawn of Modern Geography*, i. (1897). There is an English translation, with introduction and notes, by J. W. McCrindle (1897), published by the Hakluyt society.

**COSMAS**, of Prague (1045-1125), dean of the cathedral and the earliest Bohemian historian. His *Chronicae Bohemorum libri iii.*, which contains the history and traditions of Bohemia up to nearly the time of his death, has earned him the title of the Herodotus of his country. This work, which his continuators brought down to the year 1283, is of the highest value to historians in spite of the fact that its reputation for disingenuousness and credibility has been greatly affected by the critical attacks of J. Loserth (*Studien zu Cosmas von Prag*, Vienna, 1880, &c.).

The work was first published at Hanover in 1602, from the imperfect Strassburg codex. A perfected edition was brought out at the same place in 1607; this was reprinted, with notes by C. G. Schwarz in I. B. Menckenius, *Scriptores rer. Germ.* (3 vols., Lips.,

1728-1730). It is included in Pelzel and Dobrowsky, *Script. rer. Bohem.* i. pp. 1-282, after collation with Dresden MS., edited very fully by R. Köpke in *Mon. Germ. Hist. Scrip.* ix. 1-132, and repeated in Migne, *Patrol. lat.* clxvi. pp. 55-388, and in *Fontes rer. Bohem.* ii. (1874), 1-370 (Latin and Czech), by W. Wl. Tomek. See A. Potthast, *Bibliotheca Hist. Med. Aevi.*

**COSMATI**, the name of a Roman family, seven members of which, for four generations, were skilful architects, sculptors and workers in mosaic. The following are the names and dates known from existing inscriptions:—

Lorenzo (born in the second half of the 12th century).

Jacopo (dated works 1205 and 1210).

Cosimo ( " " 1210-1235).

Luca (1231 and 1235). Jacopo (1231-1293). Adeodato (1294). Giovanni (1296 and 1303).

Their principal works in Rome are: ambones of S. Maria in Ara Coeli (Lorenzo); door of S. Saba, 1205, and door with mosaics of S. Tommaso in Formis (Jacopo); chapel of the Sancta Sanctorum, by the Lateran (Cosimo); pavement of S. Jacopo alla Lungara, and (probably) the magnificent episcopal throne and choir-screen in S. Lorenzo fuori le Mura, of 1254 (Jacopo the younger); baldacchino of the Lateran and of S. Maria in Cosmedin, c. 1294 (Adeodato); tombs in S. Maria sopra Minerva (c. 1296), in S. Maria Maggiore, and in S. Balbina (Giovanni). The chief signed works by Jacopo the younger and his brother Luca are at Anagni and Subiaco. A large number of other works by members and pupils of the same family, but unsigned, exist in Rome. These are mainly altars and baldacchini, choir-screens, paschal candlesticks, ambones, tombs and the like, all enriched with sculpture and glass mosaic of great brilliance and decorative effect.

Besides the more mechanical sort of work, such as mosaic patterns and architectural decoration, they also produced mosaic pictures and sculpture of very high merit, especially the recumbent effigies, with angels standing at the head and foot, in the tombs of Ara Coeli, S. Maria Maggiore and elsewhere. One of their finest works is in S. Cesareo; this is a marble altar richly decorated with mosaic in sculptured panels, and (below) two angels drawing back a curtain (all in marble) so as to expose the open grating of the confessio. The magnificent cloisters of S. Paolo fuori le Mura, built about 1285 by Giovanni, the youngest of the Cosmati, are one of the most beautiful works of this school. The baldacchino of the same basilica is a signed work of the Florentine Arnolfo del Cambio, 1285, "cum suo socio Petro," probably a pupil of the Cosmati. Other works of Arnolfo, such as the Braye tomb at Orvieto (*q.v.*), show an intimate artistic alliance between him and the Cosmati. The equally magnificent cloisters of the Lateran, of about the same date, are very similar in design; both these triumphs of the sculptor-architect's and mosaicist's work have slender marble columns, twisted or straight, richly inlaid with bands of glass mosaic in delicate and brilliant patterns. The shrine of the Confessor at Westminster is a work of this school, executed about 1268. The general style of works of the Cosmati school is Gothic in its main lines, especially in the elaborate altar-canopies, with their pierced geometrical tracery. In detail, however, they differ widely from the purer Gothic of northern countries. The richness of effect which the English or French architect obtained by elaborate and carefully worked mouldings was produced in Italy by the beauty of polished marbles and jewel-like mosaics—the details being mostly rather coarse and often carelessly executed.

An excellent account of the Cosmati is given by Boito, *Architettura del medio evo* (Milan, 1880), pp. 117-182.

**COSMIC** (from Gr. *κόσμος*, order or universe), pertaining to the universe, universal or orderly. In ancient astronomy, the word "cosmical" means occurring at sunrise, and designates especially the rising or setting of the stars at that time. "Cosmical physics" is a term broadly applied to the totality of those branches of science which treat of cosmical phenomena

and their explanation by the laws of physics. It includes terrestrial magnetism, the tides, meteorology as related to cosmical causes, the aurora, meteoric phenomena, and the physical constitution of the heavenly bodies generally. It differs from astrophysics only in dealing principally with phenomena in their wider aspects, and as the products of physical causes, while astrophysics is more concerned with minute details of observation.

**COSMOGONY** (from Gr. *κόσμος*, world and *γίγνεσθαι*, to be born), a theory, however incomplete, of the origin of heaven and earth, such as is produced by primitive races in the myth-making age, and is afterwards expanded and systematized by priests, poets or philosophers. Such a theory must be mythical in form, and, after gods have arisen, is likely to be a theogony (*θεός*, god) as well as a cosmogony (Babylonia, Egypt, Phoenicia, Polynesia).

1. To many the interest of such stories will depend on their parallelism to the Biblical account in Genesis i.; the anthropologist, however, will be attracted by them in proportion as they illustrate the more primitive phases of human culture. In spite of the frequent overgrowth of a luxuriant imagination, the leading ideas of really primitive cosmogonies are extremely simple. Creation out of nothing is nowhere thought of, for this is not at all a simple idea. The pre-existence of world-matter is assumed; sometimes too that of heaven, as the seat of the earth-maker, and that of preternatural animals, his coadjutors. The earth-making process may, among the less advanced races, be begun by a bird, or some other animal (whence the term "theriomorphism"), for the high idea of a god is impossible, till man has fully realized his own humanity. Of course, the earth-forming animal is a preternaturally gifted one, and is on the line of development towards that magnified man who, in a later stage, becomes the demiurge.<sup>1</sup> Between the two comes the animal—man, *i.e.* a being who has not yet shed the slough of an animal shape, but combines the powers—natural and preternatural—of some animal with those of a man. Let us now collect specimens of the evidence for different varieties of cosmogony, ranging from those of the Red Indian tribes to that of the people of Israel.

2. *North American Stories.*—Theriomorphic creators are most fully attested for the Red Indian tribes, whose very backwardness renders them so valuable to an anthropologist. There is a painted image from Alaska, now in the museum of the university of Pennsylvania, which represents such an one. We see a black crow tightly holding a human mask which he is in the act of incubating. Let us pass on to the Thlinkit Indians of the N.W. coast. A cycle of tales is devoted to a strange humorous being called Yehl or Yelch, *i.e.* the Raven, miraculously born, not to be wounded, and at once a semi-developed creator and a culture hero.<sup>2</sup> His bitter foe is his uncle; the germs of dualism appear early. Like some other culture-heroes, he steals sun, moon and stars out of a box, so enlightening the dark earth. These people are at any rate above the Greenlanders, but are surpassed by the Algonkians described by Nicholas Perrot in 1700, and by the Iroquois, whom the heroic Father Brébeuf (1593–1649) learned to know so well.<sup>3</sup> The earth-maker of the former was called Michabo, *i.e.* the Great Hare.<sup>4</sup> He is the leader of some animals on a raft on a shoreless sea. Three of these in succession are sent to dive for a little earth. A grain of sand is brought; out of it he makes an island (America?). Of the carcasses of the dead animals he makes the present men (N. Americans?). There is also a Flood-story, an episode in which has a bearing on the

<sup>1</sup> Cf. Miss Harrison, *Prolegomena to the Study of Greek Religion*, chaps. vi., vii., "The Making of a Goddess and of a God."

<sup>2</sup> See Ratzel, *Hist. of Mankind*, ii. 147–148; Breysig, *Die Entstehung des Gottesgedankens* (1905), pp. 10–12.

<sup>3</sup> See Chamberlain, *Journ. of American Folklore*, iv. 208–209 (analysis of Perrot's account); Brinton, *Myths of the New World*, pp. 176–179; Breysig, *op. cit.*, pp. 15–20.

<sup>4</sup> On Michabo see Brinton, *op. cit.* (1876), pp. 176 ff., *Essays of an Americanist* (1890), p. 132. This scholar holds that "Michabo" has properly nothing to do with "Great Hare," but should be translated "the Great White One," *i.e.* the light of the dawn. The Algonkians, however, thought otherwise, and the myth itself suggests a theriomorphic earth-maker.

great dragon-myth<sup>5</sup> (see DELUGE). The Iroquois are in advance of the Algonkians; their creator-hero has no touch of the animal in him. Above the waters there existed a heaven, or a heavenly earth (cf. Mexico, Babylonia, Egypt), through a hole in which Aataentsic fell to the water. The broad back of a tortoise (cf. § 6) on which a diving animal had placed some mud, received her. Here, being already pregnant, she gave birth to a daughter, who in turn bore the twins Joskeha and Tawiscara (myth of hostile brothers). By his violence (cf. Gen. xxv. 22) the latter killed his mother, out of whose corpse grew plants. Tawiscara fled to the west, where he rules over the dead. Joskeha made the beasts and also men. After acting as culture-giver he disappeared to the east, where he is said to dwell with his grandmother as her husband.<sup>6</sup>

3. *Mexican.*—The most interesting feature in the Mexican cosmology is the theory of the ages of the world. Greece, Persia and probably Babylon, knew of four such ages.<sup>7</sup> The Priestly Writer in the Pentateuch also appears to be acquainted with this doctrine; it is the first of four ages which begins with the Creation and ends with the Deluge. The Mexicans, however, are said to have assumed five ages called "suns." The first was the sun of earth; the second, of fire; the third, of air; the fourth, of water; the fifth (which is the present) was unnamed. Each of these closed with a physical catastrophe.<sup>8</sup> The speculations which underlie the Mexican theory have not come down to us. For the Iranian parallel, see § 8, and on the Hebrew Priestly Writer, Gunkel, *Genesis*<sup>2</sup>, pp. 233 ff.

4. *Peruvian.*—In Peru, as in Egypt, the sun-god obtained universal homage. But there were creator-gods in the background. A theoretical supremacy was accorded by the Incas to Pachacamac, whose worship, like that of Viracocha, they appear to have already found when they conquered the land. Pachacamac means, in Quichua, "world-animator."<sup>9</sup> The "philosophers" of Peru declared that he desired no temples or sacrifices, no worship but that of the heart. This is conceivable; Maui, too, in New Zealand had no temple or priests. But most probably this deity had another less abstract name, and the horrible worship offered in the one temple which he really had under the Incas, accorded with his true cosmic significance as the god of the subterranean fire. Viracocha too had a cosmic position; an old Peruvian hymn calls him "world-former, world-animator."<sup>10</sup> He was connected with water. A third creator was Manco Capac ("the mighty man"), whose sister and wife is called Mama Oello, "the mother-egg." Afterwards, the creator and the mother-egg became respectively the sun and the moon, represented by the Inca priest-king and his wife, the supposed descendants of Manco Capac.<sup>11</sup> Dualistic tendencies were also developed. Las Casas<sup>12</sup> reports a story that before creation the creator-god had a bad son who sought, after creation, to undo all that his father had done. Angered at this, his father hurled him into the sea. We need not suspect Christian influences, but the parallelism of Rev. xx. 3, Isa. xiv. 12, 15, Ezek. xxviii. 16 is obvious.

5. *Polynesian.*—Polynesia, that classic land of mythology, is specially rich in myths of creation. The Maori story, told by Grey and others, of the rending apart of Rangi (= Langi, heaven)

<sup>5</sup> See Schoolcraft, *Myth of Hiawatha* (1856), pp. 35–39; and cf. the myth of Manabush, analysed in *Journ. of Amer. Folklore*, iv. 210–213.

<sup>6</sup> The latest explanation of Joskeha is "dear little sprout," and of Tawiscara, "the ice-one," while Aataentsic becomes "she of the swarthy body." Hewitt, *Journ. of Amer. Folklore*, x. 68. Brébeuf (1635) says that Iouskeha gives growth and fair weather (Tylor, *Prim. Cult.* i. 294).

<sup>7</sup> See Jeremias, *Das Alte Testament im Lichte des Alten Orients*, p. 121, i; Winckler, *Die Keilinschriften und das Alte Testament*<sup>2</sup>, p. 333.

<sup>8</sup> Réville, *Religions of Mexico and Peru*, p. 129.

<sup>9</sup> Garcilasso el Inca, *Comment. de los Incas*, lib. ii. c. 2; cf. Lang, *The Making of Religion*, pp. 262–270.

<sup>10</sup> Réville, p. 187.

<sup>11</sup> Réville, p. 158. Garcilasso (lib. i. c. 18) says that Manco Capac "taught the subject nations to be men," and also founded the imperial city of Cuzco (= navel).

<sup>12</sup> *De las antiguas gentes del Peru* (ed. 1892), pp. 55, 56.

and Papa (earth) can be paralleled in China, India and Greece, and more remotely in Egypt and Babylonia. The son of Rangi and Papa was Tangaloa (also called Tangaraoa and Taaraoa), the sea-god and the father of fishes and reptiles.<sup>1</sup> In other parts of Polynesia he is the Heaven God, to whom there is no like, no second. In Samoa he is even called Tangaloa-Langi (Tangaloa = heaven). And if he is the sea-god, we must remember that there is a heavenly as well as an earthly ocean; hence the clouds are sometimes called Tangaloa's ships. It is true, the popular imagery is unworthy of such a god. Sometimes he is said to live in a shell, by throwing off which from time to time he increases the world; or in an egg, which at last he breaks in pieces; the pieces are the islands. We also hear that long ago he hovered as an enormous bird over the waters, and there deposited an egg. The egg may be either the earth with the overarching vault of heaven or (as in Egypt—but this is a later view) the sun. The latter received mythical representation in that most interesting god (but originally rather culture-hero) Maui, who, in New Zealand practically supplants Tangaloa, and becomes the god of the air and of the heaven, the creator and the causer of the flood.<sup>2</sup> Speculation opened the usual deep problem; whence came the gods? It was answered that Po, *i.e.* darkness, was the begetter of all things, even of Tangaloa.

6. *Indian*.—India, however, is the natural home of a mythology recast by speculation. The classical specimen of an advanced cosmogony is to be found in the Rig Veda (x. 129); it is the hymn which begins, "There then was neither Aught nor Naught!"<sup>3</sup> Another such cosmogony is given in Manu. It is "the self-existent Lord," who, "with a thought, created the waters, and deposited in them a seed which became a golden egg, in which egg he himself is born as Brahmā, the progenitor of the worlds."<sup>4</sup> The doctrine of creation by a thought is characteristically Indian. In the śatapatha Brahmana (cf. DELUGE), we meet again with the primeval waters and the world-egg, and with the famous mythological tortoise-theory,<sup>5</sup> also found among the Algonkians (§ 2)—antique beliefs gathered up by the framers of philosophic systems, who felt the importance of maintaining such links with the distant past.

7. *Egyptian*.—In Egypt too the systematizers were busily engaged in the co-ordination of myths. They retained the belief that the germs of all things slept for ages within the dark flood, personified as Nūn or Nū. How they were drawn forth was variously told.<sup>6</sup> In some districts the demiurge was called Khnumu; it was he who modelled the egg (of the world?) and also man.<sup>7</sup> Elsewhere he was the artizan-god Ptaḥ, who with his hammer broke the egg; sometimes Thoth, the moon-god and principle of intelligence, who spoke the world into existence.<sup>8</sup> A strange episode in the legend of the destruction of man by the gods tells how Ra (or Re), the first king of the world, finding in his old age that mankind ceased to respect him, first tried the remedy of massacre, and then ascended the heavenly cow, and organized a new world—that of heaven.<sup>9</sup>

8. *Iranian*.—The Iranian account of creation<sup>10</sup> is specially interesting because its religious spirit is akin to that of Genesis i. From a literary point of view, indeed, it cannot compare with the dignified Hebrew narrative, but considering the misfortunes which have befallen the collection of Zoroastrian traditions now represented by the Bundahish (the Parsee Genesis) we cannot reasonably be surprised. The work referred to begins by

<sup>1</sup> See especially Wäitz-Gerland, *Anthropologie der Naturvölker*, vi. 229-302; Gill, *Myths and Songs of the South Pacific*; Schirren, *Wandersagen der Neuseeländer*; also an older work (Sir George) Grey's *Polynesian Mythology*.

<sup>2</sup> See Schirren, *op. cit.*, pp. 64-89.

<sup>3</sup> J. Muir, *Metric Translations*, pp. 188-189.

<sup>4</sup> J. Muir, *Sanskrit Texts*, iv. 26.

<sup>5</sup> See Tylor, *Early History of Mankind*, p. 340; *Primitive Culture*, i. 329; Oldenberg, *Religion des Veda*, pp. 85 f.

<sup>6</sup> See Maspero, *Dawn of Civilization*, p. 127; also Brugoch, *Religion und Mythologie der alten Ägypter*.

<sup>7</sup> See illustration in Maspero, p. 157.

<sup>8</sup> See Maspero, pp. 146-147.

<sup>9</sup> Maspero, pp. 160-169.

<sup>10</sup> See ZOROASTER, and cf. *Ency. Bib.*, "Creation," § 9; "Zoroastrianism," §§ 20, 21.

describing the state of things in the beginning; the good spirit in endless light and omniscient, and the evil spirit in endless darkness and with limited knowledge. Both produced their own creatures, which remained apart, in a spiritual or ideal state, for 3000 years, after which the evil spirit began his opposition to the good creation under an agreement that his power was not to last more than 9000 years, of which only the middle 3000 were to see him successful. By uttering a sacred formula the good spirit throws the evil one into a state of confusion for a second 3000 years, while he produces the archangels and the material creation, including the sun, moon and stars. At the end of that period the evil spirit, encouraged by the demons he had produced, once more rushes upon the good creation to destroy it. The demons carry on conflicts with each of the six classes of creation, namely, the sky, water, earth, plants, animals represented by the primeval ox, and mankind represented by Gāyōmard or Kayumarth (the "first man" of the *Avesta*).<sup>11</sup> Four points to be noticed here: (1) the belief in the four periods of the world, each of 3000 years (cf. § 3); (2) the comparative success for a time of Angra Mainyu (the evil principle personified); (3) the absence of any recognition of pre-existent matter; (4) the mention of six classes of good creatures. Each of these deserves a comment which we cannot, however, here give, and the third may seem to suggest direct influence of the Iranian upon the Jewish cosmogony. But though there are in Gen. i. six days of creative activity, and the creative works are not six, but eight, if not ten in number, and indirect Babylonian influence is more strongly indicated. Jewish thinkers would have been attracted by the emphatic assertion of the creatorship of the One God in the royal Persian inscriptions more than by the traditional cosmogony. See further *Ency. Bib.*, "Creation," § 9.

9. *Phoenician and Greek*.—Phoenician cosmogonies would appear, from the notices which have come down to us,<sup>12</sup> to have been composite. The traditions are pale and obscure. It is clear, however, that the primeval flood and the world-egg (out of which came heaven and earth) are referred to. See *Ency. Bib.*, "Creation" § 7; "Phoenicia" § 15; Lagrange, *Religions sémitiques*, pp. 351 ff. Greek cosmogonies (the orientalism of which is clear) will be found in Hesiod, *Theog.* 116 ff.; Aristophanes, *Birds*, 692 ff.; cf. Clem. Rom., *Homil.* vi. 4. See Miss Harrison, *Prolegomena to the Study of Greek Religion*, chap. xii. "Orphic Cosmogony."

10. *Babylonian and Israelitish*.—Of the Babylonian and Israelitish cosmogonies we have several more or less complete records. For details as to the former, see BABYLONIAN AND ASSYRIAN RELIGION. With regard to the latter, we may notice that in Gen. ii. 4b-25 we have an account of creation which, though in its present form very incomplete, is highly attractive, because it is pervaded by a breath from primitive times. It has, however, been interwoven with an account of the Garden of Eden from some other source (see EDEN; PARADISE), and perhaps in order to concentrate the attention of the reader, the description of the origin of "earth and heaven" as well as of the plants and of the rain, appears to have been omitted. In fact, both the creation-stories at the opening of Genesis must have undergone much editorial manipulation. Originally, for instance, Gen. i. 26 must have said that man was made out of earth; this point of contact between the two cosmogonic traditions has, however, been effaced.

The other narrative, Gen. i. 1-ii. 4a, is a much more complete cosmogony, and since the theory of P. A. Lagarde (1887), which ascribes it to Iranian influence (see § 8), has no very solid ground, whereas the theory which explains it as largely Babylonian is in a high degree plausible, we must now consider the relations between the Israelitish and Babylonian cosmogonies. The short account of creation first translated in 1890 by T. G. Pinches is distinguished by its non-mythical character; in particular, the

<sup>11</sup> West, *Pahlavi Texts* (S.B.E.), vol. i., introd. p. xxiii. We need not deny that, late as the Bundahish may be as a whole, the traditions which it contains are often old.

<sup>12</sup> Fragments of older works are cited by Philo of Byblus (in Eusebius, *Praep. Evang.* i. 10) and Mochus and Endemus (in Damascus, *De primis principiis*, c. 125).



dragon of chaos and darkness is conspicuous by her absence. This may illustrate the fact that the dragon is also unmentioned in the Hebrew cosmogony; to some writers the dragon-element may have seemed grotesque and inappropriate. We must, however, study this element in the most important Babylonian tradition, even if only for its relation to non-Semitic myths and especially to some striking passages in the Bible (Isa. xxvii. 1, li. 9b; Ps. lxxiv. 14, lxxxix. 10, 11; Job iii. 8, ix. 13, xxvi. 12, 13; Rev. xii. 3, 4, xx. 1-3). One may also be permitted to hold that the mythic figure of the dragon, if used poetically, is a highly serviceable one, and consider that "in the beginning God fought with the dragon, and slew him" would have formed an admirable illustration of the passages just now referred to, especially to those in the Apocalypse.

The student should, however, notice that the dragon-element is not entirely unrepresented even in the priestly Hebrew cosmogony. It is said in Gen. i. 9, 10, 14, 15, that God divided the primeval waters into two parts by an intervening "firmament" or "platform," on which the sun, moon and stars (planets) were placed to mark times and to give light. This division (cp. Ps. lxxiv. 13) is really a pale version of the old mythic statement respecting the cleaving of the carcass of Tiamat (the Dragon) into two parts, one of which kept the upper waters from coming down.<sup>1</sup> And we must affirm that the technical term *te hom* (rendered in the English Bible "the deep"), which evidently signifies the enveloping primeval flood, and which closely resembles Tiamat, the name given to the dragon or serpent in the epic (cf. *tiamtu* and *tamtu*, Babylonian words for "the ocean"), can only be due to the influence—probably the very early influence—of Babylonia.

But we are far from having exhausted the evidence of Babylonian influence on the Hebrew cosmogony. The description of chaos in v. 2 not only mentions the great water (*te hom*), but the earth, *i.e.* the earth-matter, out of which the earth and (potentially) its varied products (vv. 9-11), and (as we know from the Babylonian epic) the "firmament" or "platform" of the heaven were to appear. This earth-matter is called "*ishu* and *bahu*"; there is nothing like this phrase in the epic, but we may infer from Jer. iv. 23, where the same phrase occurs, that it means "devoid of living things." For a commentary on this see the opening of the Babylonian account referred to above, which refers to the period of chaos as one in which there were neither reeds nor trees, and where "the lands altogether were sea." As to the creative acts, we may admit that the creation of light does not form one of them in the epic (cf. Gen. i. 3), but the existence of light apart from the sun is presupposed; Marduk the creator is in fact a god of light. Nor ought we to find a discrepancy between the Babylonian and the Hebrew accounts in the creation of the heavenly bodies after the plants, related in Gen. i. 14-18. For the position of this creative act is due to the necessity of bringing all the divine acts into the framework of six working days. On the whole, the Hebrew statement of the successive stages of creation corresponds so nearly to that in the Babylonian epic that we are bound to assume that one has been influenced by the other. And if we are asked, "Which is the more original?" we answer by appealing to the well-established fact of the profound influence of Babylonian culture upon Canaan in remote times (see CANAAN). An important element in this culture would be mythic representations of the origin of things, such as the Babylonian Creation and Deluge-stories in various forms. Indeed, not only Canaan but all the neighbouring regions must have been pervaded by Babylonian views of the universe and its origin. Myths of origins there must indeed have been in those countries before Babylonian influence became so overpowering, but, if so, these myths must have become recast when the great Teacher of the Nations half-attracted and half-compelled attention. More than this we need not assert. Zimmern's somewhat different treatment of the subject in *Ency. Biblica*, "Creation," § 4, may be compared.

Popular writers are in some danger of misrepresenting this important result. It is tempting, but incorrect, to suppose that

<sup>1</sup> See Jastrow, *Religion of Babylonia and Assyria*, p. 428.

a docile Israelitish writer accepted one of the chief forms of the Babylonian cosmogony, merely omitting its polytheism and substituting "Yahweh" for "Marduk." As we have seen, various myths of Creation may have been current both in N. Arabia (whence the Israelites may have come) and in Canaan prior to the great extension of Babylonian influence. These myths doubtless had peculiarities of their own. From one of them may have come that remarkable statement in Gen. i. 2b, "and the spirit of God (Elohim) was hovering over the face of the waters," which, until we find some similar myth nearer home, is best illustrated and explained by a Polynesian myth (see Cheyne, *Traditions and Beliefs of Ancient Israel*, ad loc.). It is also probably to a non-Babylonian source that we owe the prescription of vegetarian or herb diet in Gen. i. 29, 30, which has a Zoroastrian parallel<sup>2</sup> and is evidently based on a myth of the Golden Age, independent of the Babylonian cosmogony. Gen. i., therefore, has not, as it stands, been directly borrowed from Babylonia, and yet the infused Babylonian element is so considerable that the story is, in a purely formal aspect, much more Babylonian than either Israelitish or Canaanitish or N. Arabian. We say "in a purely formal aspect," because the strictness with which Babylonian mythic elements have been adapted in Gen. i. to the wants of a virtually monotheistic community is in the highest degree remarkable.

On the literary scheme of the Creation-story in Gen. i. see the commentaries (*e.g.* Dillman's and Driver's). On the other Old Testament references to creation, and on the prophetic doctrine of creation, see *Ency. Bib.*, "Creation," §§ 27-29. On the traces of dragon and serpent myths in the Old Testament and their significance, see Gunkel, *Schöpfung und Chaos* (1895)—a pioneering work of the highest merit—and *Ency. Bib.*, "Behemoth," "Dragon," "Rahab," "Serpent." On the connexion of the Creation and the Deluge-stories, see DELUGE. Cf. also the article on BABYLONIAN AND ASSYRIAN RELIGION; and Cheyne, *Traditions and Beliefs of Ancient Israel* (1907). (T. K. C.)

**COSMOPOLITAN** (Gr. *κόσμος*, world, and *πολίτης*, citizen), of or belonging to a "citizen of the world," *i.e.* one whose sympathies, interests, whether commercial, political or social, and culture are not confined to the nation or race to which he may belong, opposed therefore to "national" or "insular." As an attribute the word may be applied to a cultured man of the world, who has travelled widely and is at home in many forms of civilization, to such races as the Jewish, scattered through the civilized world, yet keeping beneath their cosmopolitanism the racial type pure, and also to mark a profound line of cleavage in economic and political thought.

**COSNE**, a town of central France, capital of an arrondissement in the department of Nièvre, on the right bank of the Loire at its junction with the Nohain, 37 m. N.N.W. of Nevers by the Paris-Lyon railway. Pop. (1906) town, 5750; commune, 8437. Two suspension bridges unite it to the left bank of the Loire. The church of St Aignan is a building of the 12th century, restored in the 16th and 18th centuries; the only portions in the Romanesque style are the apse and the north-west portal. It formerly belonged to a Benedictine priory depending on the abbey of La Charité (Nièvre). The manufacture of files, flour-milling and tanning are carried on in the town which has a subprefecture, a tribunal of first instance and a communal college. Cosne is mentioned in the Antonine Itinerary under the name of *Condane*, but it was not till the middle ages that it rose into importance as a military post. In the 12th century the bishop of Auxerre and the count of Nevers agreed to a division of the supremacy over the town and its territory.

**COSSA, LUIGI** (1831-1896), Italian economist, was born at Milan on the 27th of May 1831. Educated at the universities of Pavia, Vienna and Leipzig, he was appointed professor of political economy at Pavia in 1858. He died at Pavia on the 10th of May 1896. Cossa was the author of several works which established for him a high reputation; including *Scienza delle finanze* (1875, English translation 1888 under title *Taxation, its Principles and Methods*); *Guida allo studio dell' economia politica* (1876, English translation 1880), an admirable compendium of the theoretical preliminaries of economics, with a

<sup>2</sup> See *Bundahish*, xv. 2 (*S.B.E.*, v. 53).

brief critical history of the science and an excellent bibliography; *Introduzione allo studio dell' economia politica* (1876, English translation by L. Dyer, 1893); and *Saggi di economia politica*, 1878.

**COSSA, PIETRO** (1830–1880), Italian dramatist, was born at Rome in 1830, and claimed descent from the family of Pope John XXIII., deposed by the council of Constance. He manifested an independent spirit from his youth, and was expelled from a Jesuit school on the double charge of indocility and patriotism. After fighting for the Roman republic in 1849, he emigrated to South America, but failing to establish himself returned to Italy, and lived precariously as a literary man until 1870, when his reputation was established by the unexpected success of his first acted tragedy, *Nero*. From this time to his death in 1880 Cossa continued to produce a play a year, usually upon some classical subject. *Cleopatra*, *Messalina*, *Julian*, enjoyed great popularity, and his dramas on subjects derived from Italian history, *Rienzi* and *The Borgias*, were also successful. *Plautus*, a comedy, was preferred by the author himself, and is more original. Cossa had neither the divination which would have enabled him to reconstruct the ancient world, nor the imagination which would have enabled him to idealize it. But he was an energetic writer, never tame or languid, and at the same time able to command the attention of an audience without recourse to melodramatic artifice; while his sonorous verse, if scarcely able to support the ordeal of the closet, is sufficiently near to poetry for the purposes of the stage.

His collected *Teatro poetico* was published in 1887.

**COSSACKS** (Russ. *Kazak*; plural, *Kazaki*, from the Turki *quzzāq*, "adventurer, free-booter"), the name given to considerable portions of the population of the Russian empire, endowed with certain special privileges, and bound in return to give military service, all at a certain age, under special conditions. They constitute ten separate *voiskos*, settled along the frontiers: Don, Kuban, Terek, Astrakhan, Ural, Orenburg, Siberian, Semiryechensk, Amur and Usuri. The primary unit of this organization is the *stanitsa*, or village, which holds its land as a commune, and may allow persons who are not Cossacks (excepting Jews) to settle on this land for payment of a certain rent. The assembly of all householders in villages of less than 30 households, and of 30 elected men in villages having from 30 to 300 households (one from each 10 households in the more populous ones), constitutes the village assembly, similar to the *mir*, but having wider attributes, which assesses the taxes, divides the land, takes measures for the opening and support of schools, village grain-stores, communal cultivation, and so on, and elects its *ataman* (elder) and its judges, who settle all disputes up to £10 (or above that sum with the consent of both sides). Military service is obligatory for all men, for 20 years, beginning with the age of 18. The first 3 years are passed in the preliminary division, the next 12 in active service, and the last 5 years in the reserve. Every Cossack is bound to procure his own uniform, equipment and horse (if mounted)—the government supplying only the arms. Those on active service are divided into three equal parts according to age, and the first third only is in real service, while the two others stay at home, but are bound to march out as soon as an order is given. The officers are supplied in the usual way by the military schools, in which all Cossack *voiskos* have their own vacancies, or are non-commissioned Cossack officers, with officers' grades. In return for this service the Cossacks have received from the state considerable grants of land for each *voisko* separately.

The total Cossack population in 1893 was 2,648,049 (1,331,470 women), and they owned nearly 146,500,000 acres of land, of which 105,000,000 acres were arable and 9,400,000 under forests. This land was divided between the *stanitsas*, at the rate of 81 acres per each soul, with special grants to officers (personal to some of them, *in lieu* of pensions), and leaving about one-third of the land as a reserve for the future. The income which the Cossack *voiskos* receive from the lands which they rent to different persons, also from various sources (trade patents, rents of shops, fisheries, permits of gold-digging, &c.), as also from the subsidies

they receive from the government (about £712,500 in 1893), is used to cover all the expenses of state and local administration. They have besides a special reserve capital of about £2,600,000. The expenditure of the village administration is covered by village taxes. The general administration is kept separately for each *voisko*, and differs with the different *voiskos*. The central administration, at the Ministry of War, is composed of representatives of each *voisko*, who discuss the proposals of all new laws affecting the Cossacks. In time of war the ten Cossack *voiskos* are bound to supply 890 mounted *sotnias* or squadrons (of 125 men each), 108 infantry *sotnias* or companies (same number), and 236 guns, representing 4267 officers and 177,100 men, with 170,695 horses. In time of peace they keep 314 squadrons, 54 infantry *sotnias*, and 20 batteries containing 108 guns (2574 officers, 60,532 men, 50,054 horses). Altogether, the Cossacks have 328,705 men ready to take arms in case of need. As a rule, popular education amongst the Cossacks stands at a higher level than in the remainder of Russia. They have more schools and a greater proportion of their children go to school. In addition to agriculture, which (with the exception of the Usuri Cossacks) is sufficient to supply their needs and usually to leave a certain surplus, they carry on extensive cattle and horse breeding, vine culture in Caucasia, fishing on the Don, the Ural, and the Caspian, hunting, bee-culture, &c. The extraction of coal, gold and other minerals which are found on their territories is mostly rented to strangers, who also own most factories.

A military organization similar to that of the Cossacks has been introduced into certain districts, which supply a number of mounted infantry *sotnias*. Their peace-footing is as follows:—Daghestan, 6 regular squadrons and 3 of militia; Kuban Circassians, 1 *sotnia*; Terek, 8 *sotnias*; Kars, 3 *sotnias*; Batum, 2 infantry and 1 mounted *sotnia*; Turkomans, 3 *sotnias*; total, 25 squadrons and 2 companies.

For the origin and history of the Cossacks see **POLAND**: *History*, and the biographies of Razin, Chmielnicki and Mazepa. (P. A. K.)

**COSSIMBAZAR**, or **KASIMBAZAR**, a decayed town on the river Bhagirathi in the Murshidabad district of Bengal, India, now included in the Berhampur municipality. Pop. (1901) 1262. Though the history of the place cannot be traced back earlier than the 17th century, it was of great importance long before the foundation of Murshidabad. From the first European traders set up factories here, and after the ruin of Satgaon by the silting up of the mouth of the Saraswati it gained a position, as the great trading centre of Bengal, which was not challenged until after the foundation of Calcutta. In 1658 the first English agent was established at Cossimbazar, and in 1667 the chief of the factory there became an *ex-officio* member of council. In English documents of this period, and till the early 19th century, the Bhagirathi was described as the Cossimbazar river, and the triangular piece of land between the Bhagirathi, Padma and Jalangi, on which the city stands, as the island of Cossimbazar. The proximity of the factory to Murshidabad, the Mahomedan capital, while it was the main source of its wealth and of its political importance, exposed it to constant danger. Thus in 1757 it was the first to be taken by Suraj-ud-dowlah, the nawab; and the resident with his assistant (Warren Hastings) were taken as prisoners to Murshidabad.

At the beginning of the 19th century the city still flourished; so late as 1811 it was described as famous for its silks, hosiery, *koras* and beautiful ivory work. But an insidious change in its once healthy climate had begun to work its decay; the area of cultivated land round it had shrunk to vanishing point, jungle haunted by wild beasts taking its place; and in 1813 its ruin was completed by a sudden change in the course of the Bhagirathi, which formed a new channel 3 m. from the old town, leaving an evil-smelling swamp around the ancient wharves. Of its splendid buildings the fine palace of the maharaja of Cossimbazar alone remains, the rest being in ruins or represented only by great mounds of earth. The first wife of Warren Hastings was buried at Cossimbazar, where her tomb with its inscription still remains.

See *Imp. Gaz. of India* (Oxford, 1908), s.v.

**COSTA, GIOVANNI** (1826–1903), Italian painter, was born in Rome. He fought under Garibaldi in 1848, and served as a volunteer in the war of 1859; and his enthusiasm for Italian unity was actively shown again in 1870, when he was the first to mount the breach in the assault of Rome near the Porta Pia. He had settled meanwhile at Florence, where his fight for the independence of art from worn-out traditions was no less strenuous, and he became known as a landscape-painter of remarkable originality, and of great influence in the return to minute observation of nature. He had many English friends and followers, notably Matthew Ridley Corbet (1850–1902), and Lord Carlisle, and was closely associated with Corot and the Barbizon school. In later years he lived and worked mainly in Rome, where his studio was an important centre. An exhibition of his pictures was held in London in 1904, and he is represented in the Tate Gallery. He died at Rome in 1903.

See also Madame Agresti's *Giovanni Costa* (1904).

**COSTA, LORENZO** (1460–1535), Italian painter, was born at Ferrara, but went in early life to Bologna and ranks with the Bolognese school. In 1438 he painted his famous "Madonna and Child with the Bentivoglio family," and other frescoes, on the walls of the Bentivoglio chapel in San Giacomo Maggiore, and he followed this with many other works. He was a great friend of Francia, who was much influenced by him. In 1509 he went to Mantua, where his patron was the Marquis Francesco Gonzaga, and he eventually died there. His "Madonna and Child enthroned" is in the National Gallery, London, but his chief works are at Bologna. His sons, Ippolito (1506–1561) and Girolamo, were also painters, and so was Girolamo's son Lorenzo the younger (1537–1583).

**COSTA, SIR MICHAEL ANDREW AGNUS** (1808–1884), British musical conductor and composer, the son of Cavalière Pasquale Costa, a Spaniard, was born at Naples on the 14th of February 1808. Here he became at an early age a scholar at the Royal College of Music. His cantata *L'Immagine* was composed when he was fifteen. In 1826 he wrote his first opera *Il Delitto Punito*; in 1827 another opera *Il sospetto funesto*. To this period belong also his oratorio *La Passione*, a grand Mass for four voices, a *Dixit Dominus*, and three symphonies. The opera *Il Carcere d'Ildegonda* was composed in 1828 for the Teatro Nuovo, and in 1829 Costa wrote his *Malvina* for Barbaja, the impresario of San Carlo. In this latter year he visited Birmingham to conduct Zingarelli's *Cantata Sacra*, a setting of some verses from Isaiah ch. xii. Instead, however, of conducting, he sang the tenor part. In 1830 he settled in London, having a connexion with the King's theatre. His ballet *Kenilworth* was written in 1831, the ballet *Une Heure à Naples* in 1832, and the ballet *Sir Huon* (composed for Taglioni) in 1833. In this latter year he wrote his famous quartet *Ecco quel fiero istante. Malek Adhel*, an opera, was produced in Paris in 1837. In 1842 he wrote the ballet music of *Alma* for Cerito, and in 1844 his opera *Don Carlos* was produced in London. Costa became a naturalized Englishman and received the honour of knighthood in 1869. He conducted the opera at Her Majesty's from 1832 till 1846, when he seceded to the Italian Opera at Covent Garden; he was conductor of the Philharmonic Society from 1846 to 1854, of the Sacred Harmonic Society from 1848, and of the Birmingham festival from 1849. In 1855 Costa wrote *Eli*, and in 1864 *Naaman*, both for Birmingham. Meanwhile he had conducted the Bradford (1853) and Handel festivals (1857–1880), and the Leeds festivals from 1874 to 1880. On the 29th of April 1884 he died at Brighton. Costa was the great conductor of his day, but both his musical and his human sympathies were somewhat limited; his compositions have passed into oblivion, with the exception of the least admirable of them—his arrangement of the national anthem.

**COSTAKI, ANTHOPOULOS** (1835–1902), Turkish pasha, was born in 1835. He became a professor at the Turkish naval college; then entered the legal branch of the Turkish service, rising to the post of *procureur impérial* at the court of cassation. He was governor-general of Crete; and in 1895 was appointed Ottoman ambassador in London, a post which he continued to

hold until his death at Constantinople in 1902. He bore throughout his career the reputation of an intelligent and upright public servant.

**COSTANZO, ANGELO DI** (c. 1507–1591), Italian historian and poet, was born at Naples about 1507. He lived in a literary circle, and fell in love with the beautiful Vittoria Colonna. His great work, *Le Istorie del regno di Napoli dal 1250 fino al 1408*, first appeared at Naples in 1572, and was the fruit of thirty or forty years' labour; but nine more years were devoted to the task before it was issued in its final form at Aquila (1581). It is still one of the best histories of Naples, and the style is distinguished by clearness, simplicity and elegance. The *Rime* of di Costanzo are remarkable for finical taste, for polish and frequent beauty of expression, and for strict obedience to the poetical canons of his time.

See G. Tiraboschi, *Storia della letteratura italiana*, vol. vii. (Florence, 1812).

**COSTA RICA**, a republic of Central America, bounded on the N. by Nicaragua, E. by the Caribbean Sea, S.E. and S. by Panama, S.W., W. and N.W. by the Pacific Ocean. (For map, see CENTRAL AMERICA.) The territory thus enclosed has an area of about 18,500 sq. m., and may be roughly described as an elevated tableland, intersected by lofty mountain ranges, with their main axis trending from N.W. to S.E. It is fringed, along the coasts, by low-lying marshes and lagoons, alternating with tracts of rich soil and wastes of sand.

*Physical Description.*—The northern frontier, drawn 2 m. S. of the southern shores of the river San Juan and of Lake Nicaragua, terminates at Salinas Bay on the Pacific; its southern frontier skirts the valley of the Sixola or Tiliro, strikes south-east along the crests of the Talamanca Mountains as far as 9° N., and then turns sharply south, ending in Burica Point. The monotonous Atlantic littoral is unbroken by any large inlet or estuary, and thus contrasts in a striking manner with the varied outlines of the Pacific coast, which includes the three bold promontories of Nicoya, Golfo Dulce and Burica, besides the broad sweep of Coronada Bay and several small harbours. The Gulf of Nicoya, a shallow landlocked inlet, containing a whole archipelago of richly-wooded islets, derives its name from Nicoya, an Indian chief who, with his tribe, was here converted to Christianity in the 16th century. It is famous for its purple-yielding murex, pearls and mother-of-pearl. The Golfo Dulce has an average depth of 100 fathoms and contains no islands. Two volcanic *Cordilleras* or mountain chains, separated from one another by the central plateau of San José and Cartago, traverse the interior of Costa Rica, and form a single watershed, often precipitous on its Pacific slope, but descending more gradually towards the Atlantic, where there is a broad expanse of plain in the north-east. The more northerly range, in which volcanic disturbances on a great scale have been comparatively recent, extends transversely across the country, from a point a little south of Salinas Bay, to the headland of Carreta, the southern extremity of the Atlantic seaboard, also known as Monkey Point. Its direction changes from south-east to east-south-east opposite to the entrance into the Gulf of Nicoya, where it is cut into two sections by a depression some 20 m. wide. At first it is rather a succession of isolated volcanic cones than a continuous ridge, the most conspicuous peaks being Orosi (5185 ft.), the four-crested Rincon de la Vieja (4500), Miravalles (4698) and Tenorio (6800). In this region it is known as the Sierra de Tilaran. Then succeed the Cerros de los Guatusos, a highland stretching for more than 50 m. without a single volcano. Poas (8895), the scene of a violent eruption in 1834, begins a fresh series of igneous peaks, some with flooded craters, some with a constant escape of smoke and vapour. From Irazú (11,200), the culminating point of the range, both oceans and the whole of Costa Rica are visible; its altitude exceeds that of Aneto, the highest point in the Pyrenees, but so gradual is its acclivity that the summit can easily be reached by a man on horseback. Turrialba (10,910), adjoining Irazú on the east, was in eruption in 1866. Its name, though probably of Indian origin, is sometimes written Turrialba, and connected with the Latin *Turris Alba*, "White Tower." The more southerly of

the two Costa Rican ranges, known as the Cordillera de Talamanca, rises south of the Gulf of Nicoya, and extends midway between the two oceans towards the south-east. It follows exactly the curve of the mainland, and is continued into Panama, under the name of the Cordillera de Chiriqui. Its chief summits are Chirripo Grande (11,485), the loftiest in the whole country, Buena Vista (10,820), Ujum (8695), Pico Blanco (9645) and Rovalo (7050), on the borders of Panama. Throughout the volcanic area earthquakes and landslides are of frequent occurrence.

The narrowness of the level ground between the mountains and the sea renders almost impossible the formation of any navigable river. The most important streams are those of the Atlantic seaboard, notably the San Juan, which drains Lake Nicaragua. Issuing from the lakewithin Nicaraguan territory, the San Juan has a course of 95 m., mostly along the frontier, to the Colorado Mouth, which is its main outfall, and belongs wholly to Costa Rica. Its chief right-hand tributaries are the San Carlos and Sarapiquí. The Reventazon, or Parismina, flows from the central plateau to the Caribbean Sea; despite the shortness of its valley, its volume is considerable, owing to the prevalence of moist trade-winds near its sources. Six small streams and one large river, the Rio Frio, flow across the northern frontier into Lake Nicaragua. On the Pacific coast all the rivers are rapid and liable to sudden floods. None is large, although three bear the prefix *Rio Grande*, "great river." The Tempisque enters the Pacific at the head of the Gulf of Nicoya, and tends to silt up that already shallow inlet (5-10 fathoms) with its alluvial deposits. The Rio Grande de Tarcoles also enters the gulf, and the Rio Grande de Pirris and Rio Grande de Terrabis or Diquis flow into Coronada Bay. The Rio Grande de Tarcoles rises close to the Ochomogo Pass and the sources of the Reventazon, at the base of Irazú; and the headwaters of these two streams indicate precisely the depression in the central plateau which severs the northern from the southern mountains.

Costa Rica is not differentiated from the neighbouring lands by any very marked peculiarities of geological formation, or of plant and animal life. Its geology, flora and fauna are therefore described under CENTRAL AMERICA (*q.v.*).

*Climate.*—Owing to the proximity of two oceans, and the varied configuration of the surface of Costa Rica, an area of a few square miles may exhibit the most striking extremes of climate; but, over the entire country, it is possible to distinguish three climatic zones—tropical, temperate and cold. These generally succeed one another as the altitude increases, although the heat is greater at the same elevation on the Pacific than on the Atlantic coast. It is, however, less oppressive, as cool breezes prevail and damp is comparatively rare. The tropical zone comprises the coast and the foothills, and ranges, in its mean annual temperature, from 72° F. to 82°. In the San José plateau (3000-5000 ft.), which is the most densely populated portion of the temperate zone, the average is 68°, with an average variation for all seasons of only 5°. Above 7500 ft. frosts are frequent, but snow rarely falls. The wet season, lasting during the prevalence of the south-west monsoon, from April to December, is clearly defined on the Pacific slope. It is curiously interrupted by a fortnight of dry weather, known as the *Veranillo de San Juan*, in June. Towards the Atlantic the trade-winds may bring rain in any month. Winter lasts from December to February. The normal rainfall is about 80 in., but as cloud-bursts are common, it may rise to 150 in. or even more. Rheumatism on the Atlantic seaboard, and malaria on both coasts, are the commonest forms of disease; but, as a whole, Costa Rica is one of the healthiest of tropical lands.

*Population.*—In 1904, according to the official returns, the total population numbered 331,340; having increased by more than one-fourth in a decade. Spanish, with various modifications of dialect, and the introduction of many Indian words, is the principal language; and the majority of the inhabitants claim descent from the Spanish colonists—chiefly Galicians—who came hither during the 16th and subsequent centuries. The percentage of Spanish blood is greater than in the other Central

American republics; but there is also a large population of half-castes (*ladinos* or *mestizos*) due to intermarriage with native Indians. The resident foreigners, who are mostly Spaniards, Italians, Germans and British subjects, numbered less than 8000 in 1904; immigration is, however, encouraged by the easy terms on which land can be purchased from the state. The native Indians, though exterminated in many districts, and civilized in others, remain in a condition of complete savagery along parts of the Nicaraguan border, where they are known as Prazos or Guatusos, in the Talamanca country and elsewhere. Their numbers may be estimated at 4000. They are a quiet and in-offensive folk, who dwell in stockaded encampments, and preserve their ancestral language and customs. For an account of early Indian civilization in Costa Rica, see CENTRAL AMERICA: *Archaeology*. The Mosquito Indians come every summer to fish for turtle off the Atlantic coast. As only 200 negroes were settled in Costa Rica when slavery was abolished in 1824, and no important increase ever took place through immigration, the black population is remarkably small, amounting only to some 1200.

*Chief Towns and Communications.*—The whites are congregated in or near the chief towns, which include the capital, San José (pop. 1904 about 24,500), the four provincial capitals of Alajuela (4860), Cartago (4536), Heredia (7151) and Liberia or Guanacaste (2831), with the seaports of Puntarenas (3569), on the Pacific, and Limon (3171) on the Atlantic. These, with the exception of Heredia and Liberia, are described in separate articles. The transcontinental railway from Limon to Puntarenas was begun in 1871, and forms the nucleus of a system intended ultimately to connect all the fertile parts of the country, and to join the railways of Nicaragua and Panama. It skirts the Atlantic coast as far as the small port of Matina; thence it passes inland to Reventazon, and bifurcates to cross the northern mountains; one branch going north of Irazú, while the other traverses the Ochomogo Pass. At San José these lines reunite, and the railway is continued to Alajuela, the small Pacific port of Tivives, and Puntarenas. The railways are owned partly by the state, partly by the Costa Rica railway company, which, in 1904, arranged to build several branch lines through the banana districts of the Atlantic littoral. Apart from the main lines of communication the roads are very rough, often mere tracks; and the principal means of transport are ox-carts or pack-mules. The postal and telegraphic services are also somewhat inadequate.

*Agriculture and Industries.*—The name "Costa Rica," meaning "rich coast," is well deserved; for, owing to the combination of ample sunshine and moisture with a wonderfully fertile soil, almost any kind of fruit or flower can be successfully cultivated; while the vast tracts of virgin forest, which remain along the Atlantic slopes, contain an abundance of cedar, mahogany, rosewood, rubber and ebony, with fustic and other precious dye-woods. The country is essentially agricultural, and owes its political stability to the presence of a large class of peasant proprietors, who number more than two-thirds of the population. Coffee, first planted in 1838, is grown chiefly on the plateau of San José. The special adaptability of this region to its growth is attributed to the nature of the soil, which consists of layers of black or dark-brown volcanic ash, varying in depth from 1 to 6 yds. Bananas are grown over a large and increasing area; rice, maize, barley, potatoes and beans are cultivated to some extent in the interior; cocoa, vanilla, sugar-cane, cotton and indigo are products of the warm coast-lands, but are hardly raised in sufficient quantities to meet the local demand. Stock-farming, a relatively undeveloped industry, tends to become more important, owing to the assistance which the state renders by the importation of horses, cattle, sheep and swine, from Europe and the United States, in order to improve the native breeds. In the south-east farmers are often compelled to retire with their flocks and herds before the thousands of huge, migratory vampires, which descend suddenly on the pastures and are able in one night to bleed the strongest animal to death. The manufactures are insignificant; and although silver, copper, iron, zinc, lead and marble are said to exist in considerable

quantities, the only ores that have been worked are gold, silver and copper. At the beginning of the 20th century the silver and copper mines had been abandoned. The goldfields are exploited with American capital, and yield a fair return.

**Commerce.**—The exports, which comprise coffee, bananas, cocoa, cabinet-woods and dye-woods, with hides and skins, mother-of-pearl, tortoiseshell and gold, were officially valued at £1,398,000 in 1904; and in the same year the imports, including foodstuffs, dry goods and hardware, were valued at £1,229,000. Over £1,250,000 worth of the exports consisted of coffee and bananas, and these commodities were of almost equal value. Nearly 85 % of the coffee, or more than 20,000,000 lb, were sent to Great Britain. The development of the banana trade dates from 1881, when 3500 bunches of fruit were exported to New Orleans. This total increased very rapidly, and in 1902 a monthly service of steamers was established from Limon to Bristol and Manchester. The service to England soon became a weekly one, while there are at least three weekly sailings to the United States. In 1904 the number of bunches sent abroad exceeded 6,000,000. So important is this crop that the rate of wages to labourers in the banana districts is nearly 3s. daily, as compared with an average of 1s. 8d. in the coffee plantations. The bulk of the imports comes from the United States (52 % in 1904), Great Britain (19 %) and Germany (13 %). Almost the whole foreign trade passes through Limon and Puntarenas. In 1904, exclusive of banana steamers, there were regular steamship services weekly from Limon to the United States and Germany, fortnightly to Great Britain, and monthly to France, Italy and Spain; while at Puntarenas four American liners called monthly on the voyage between San Francisco and Panama.

**Finance.**—The valuable resources of the republic, and its comparative immunity from revolution, formerly attracted the attention of European and American investors, who supplied the capital for internal development. In 1871 the government contracted a loan of £1,000,000 in London, and in 1872 it borrowed an additional £2,400,000 for railway construction. The outstanding foreign debt amounted in 1887 to £2,691,300, while the arrears of interest were no less than £2,119,500. An arrangement with the creditors was concluded in 1888; but in 1895 the republic again became bankrupt, and a fresh arrangement was sanctioned in March 1897, by which the interest on £1,475,000 was reduced to 2½ % and that on £525,000 to 3 %. It was provided that amortization, at £10,000 yearly, should begin in 1917. In 1904 the service of the external debt, which then amounted to £2,500,000, including £500,000 arrears of interest, was again suspended; the total of the internal debt was £815,000. About one-half of the national revenue is derived from customs, the remainder being principally furnished by railways, stamps, and the salt and tobacco monopolies. In the financial year 1904-1905 the revenue was £503,000, the expenditure £390,000. Education, internal development and the service of the internal debt were the chief sources of expenditure.

**Money and Credit.**—There are three important banks, the Anglo-Costa Rican Bank, with a capital of £120,000, the Bank of Costa Rica (£200,000), and the Commercial Bank of Costa Rica (£100,000), founded in 1905. On the 25th of April 1900 a law was enacted for the regulation of the constitution, capital, note emission and metallic reserves of banks. On the 24th of October 1896 an act was passed for the adoption of a gold coinage, and the execution of this act was decreed on the 17th of April 1900. The monetary unit is the gold colon weighing .778 gramme, .900 fine, and thus worth about 23d. It is legally equivalent to the silver peso, which continues in circulation. The gold coins of the United States, Great Britain, France and Germany are legally current. The metric system of weights and measures was introduced by law in 1884, but the old Spanish system is still in use.

**Constitution and Government.**—Costa Rica is governed under a constitution of 1870, which, however, only came into force in 1882, and has often been modified. The legislative power resides in a House of Representatives, consisting of about 30 to 40 deputies, or one for every 8000 inhabitants. The deputies are chosen for a

term of four years by local electoral colleges, whose members are returned by the votes of all self-supporting citizens. One-half of the chamber retires automatically every two years. The president and three vice-presidents constitute the executive. They are assisted by a cabinet of four ministers, representing the departments of the interior, police and public works; foreign affairs, justice, religion and education; finance and commerce; war and marine. For purposes of local administration the state is divided into five provinces, Alajuela, Cartago, Guanacaste, Heredia and San José, and two maritime districts (*comarcas*), Limon and Puntarenas. All these divisions except Guanacaste—which takes its name from a variety of mimosa very common in the province—are synonymous with their chief towns; and each is controlled by a governor or prefect appointed by the president. Justice is administered by a supreme court, two courts of appeal, and the court of cassation, which sit in San José, and are supplemented by various inferior tribunals.

**Religion and Education.**—The Roman Catholic Church is supported by the state, and the vast majority of the people accept its doctrines; but complete religious liberty is guaranteed by the constitution. The Jesuits, who formerly exercised widespread influence, were expelled in 1884. Of the other religious communities, the most important are the Protestants, numbering 3000, and the Buddhists, about 250. Primary education is free and compulsory; the standard of attendance is high and the instruction fair, but a large proportion of the older inhabitants were illiterate at the beginning of the 20th century. In the matter of secondary education considerable neglect has been shown. In 1904 there were only six secondary schools, including the institute of law and medicine and the training-school for teachers at San José. The state grants scholarships tenable at European universities to promising pupils, and there are three important public libraries.

**Defence.**—Military service in time of war is compulsory for all able-bodied citizens aged 18-50. There are a permanent army, of about 600; a militia, comprising an active service branch to which all under 40 belong, with a reserve for those between 40 and 50; and a national guard, including all males under 18 and over 50 who are capable of bearing arms. On a war footing these forces would number about 36,000. A gunboat and a torpedo boat constitute the navy, which, however, requires the services of an admiral, subordinate to the ministry of marine.

**History.**—The origin of the name *Costa Rica* (Spanish for "Rich Coast") has been much disputed. It is often stated that the territories to which the name is now applied were first known as *Nueva Cartago*, while *Costa Rica* was used in a wider sense to designate the whole south-western coast of the Caribbean Sea, from the supposed mineral wealth of this region. Then, in 1540, the name was restricted to an area approximately equal to that of modern Costa Rica. In such a case it must have been bestowed ironically, for the country proved very unprofitable to the gold-seekers, who were its earliest European settlers. Col. Church, in the paper cited below, derives it from *Costa de Oreja*, "Earring Coast," in allusion to the earrings worn by the Indians and remarked by their conquerors. He quotes evidence to show that this name was known to 16th-century cartographers.

With the rest of Central America, Costa Rica remained a province of the Spanish captaincy-general of Guatemala until 1821. Its conquest was completed by 1530, and ten years later it was made a separate province, the limits of which were fixed, by order of Philip II., between 1560 and 1573. This task was principally executed by Juan Vazquez de Coronado (or Vasquez de Coronada), an able and humane governor appointed in 1562, whose civilizing work was undone by the almost uninterrupted maladministration of his fifty-eight successors. The Indians were enslaved, and their welfare was wholly subordinated to the quest for gold. From 1666 onwards both coasts were ravaged by pirates, who completed the ruin of the country. Diego de la Haya y Fernandez, governor in 1718, reported to the crown that no province of Spanish America was in so wretched a condition. Cocoa-beans were the current coinage. Tomás de Acosta, governor from 1797 to 1809, confirmed this report, and stated



that the Indians were clothed in bark, and compelled in many cases to borrow even this primitive attire when the law required their attendance at church.

On the 15th of September 1821 Costa Rica, with the other Central American provinces, revolted and joined the Mexican empire under the dynasty of Iturbide; but this subjection never became popular, and, on the establishment of a Mexican republic in 1823, hostilities broke out between the Conservatives, who desired to maintain the union, and the Liberals, who wished to set up an independent republic. The opposing factions met near the Ochoмого Pass; the republicans were victorious, and the seat of government was transferred from Cartago, the old capital, to San José, the Liberal headquarters. From 1824 to 1839 Costa Rica joined the newly formed Republic of the United States of Central America; but the authority of the central government proved little more than nominal, and the Costa Ricans busied themselves with trade and abstained from politics. The exact political status of the country was not, however, definitely assured until 1848, when an independent republic was again proclaimed. In 1856-60 the state was involved in war with the adventurer William Walker (see CENTRAL AMERICA); but its subsequent history has been one of immunity from political disturbances, other than boundary disputes, and occasional threats of revolution, due chiefly to unsatisfactory economic conditions. The attempt of J. R. Barrios, president of Guatemala, to restore federal unity to Central America failed in 1885, and had little influence on Costa Rican affairs. In 1897 the state joined the Greater Republic of Central America, established in 1895 by Honduras, Nicaragua and Salvador, but dissolved in 1898. The boundary question between Costa Rica and Nicaragua was referred to the arbitration of the president of the United States, who gave his award in 1888, confirming a treaty of 1858; further difficulties arising from the work of demarcation were settled by treaty in 1896. The boundary between Costa Rica and Panama (then a province of Colombia) was fixed by the arbitration of the French president, who gave his award on the 15th of September 1900. The frontiers delimited in accordance with these awards have already been described.

**BIBLIOGRAPHY.**—In addition to the works on Central America cited under that heading, the following give much general information: G. Niederlein, *The Republic of Costa Rica* (Philadelphia, 1898); R. Villafranca, *Costa Rica* (New York, 1895); L. Z. Baron, *Compendio geográfico y estadístico de la República de Costa Rica* (San José, 1894); H. Pittier, *Apuntaciones sobre el clima y geographia de la República de Costa Rica* (San José, 1890); P. Biolley, *Costa Rica and her Future* (Washington, 1889); M. M. de Peralta, *Costa Rica* (London, 1873). For an account of immigration, commerce and other mainly statistical matters, see J. Schroeder, *Costa Rica State Immigration* (San José, 1894); *Bulletins* of the Bureau of American Republics (Washington); *British Diplomatic and Consular Reports* (London); U.S.A. *Consular Reports* (Washington); *Reports of the Ministries* (San José). For the history of Costa Rica, see L. Z. Baron, *Compendio de la historia de Costa Rica* (San José, 1894); F. M. Barrantes, *Elementos de historia de Costa Rica* (San José, 1892); J. B. Calvo, *The Republic of Costa Rica* (Chicago, 1890), gives a partisan account of local politics, trade and finance, authorized by the government. Frontier questions are discussed fully in Col. G. E. Church's "Costa Rica," a very valuable paper in vol. x. of the *Journal of the Royal Geographical Society* (London, 1897); and, by Dr E. Seler, in "Der Grenzstreit zwischen den Republiken Costa Rica und Colombia," in *Petermann's Mittheilungen*, vol. xlv. (1900). For a detailed bibliography see D. J. Maluquer, *Republica de Costa Rica* (Madrid, 1890). The best maps are that of the Bureau of American Republics (1903), and, for physical features, that of Col. Church, published by the R.G.S. (London, 1897).

**COSTELLO, DUDLEY** (1803-1865), English journalist and novelist, son of Colonel J. F. Costello, was born in Ireland in 1803. He was educated for the army at Sandhurst, and served for a short time in India, Canada and the West Indies. His literary and artistic tastes led him to quit the army in 1828, and he then passed some years in Paris. He was introduced to Baron Cuvier, who employed him as draughtsman in the preparation of his *Règne animal*. He next occupied himself in copying illuminated manuscripts in the Bibliothèque Royale; and to him and his sister belongs the merit of being the first to draw general attention to this beautiful forgotten art, and of

thus leading to its revival. About 1838 Costello became foreign correspondent to the *Morning Herald*; in 1846 he became foreign correspondent of the *Daily News*; and during the last twenty years of his life he held the post of sub-editor of the *Examiner*. He wrote *A Tour through the Valley of the Meuse* (1845) and *Piedmont and Italy, from the Alps to the Tiber* (1859-1861). Among his novels are *Stories from a Screen* (1855), *The Millionaire* (1858), *Faint Heart never won Fair Lady* (1859) and *Holidays with Hobgoblins* (1860). He died on the 30th of September 1865.

His elder sister, LOUISA STUART COSTELLO (1799-1870), author and miniature painter, was born in Ireland in 1799. Her father died while she was young, and Louisa, who removed to Paris with her mother in 1814, helped to support her mother and brother by her skill as an artist. At the age of sixteen she published a volume of verse entitled *The Maid of the Cyprus Isle, and other poems*. This was followed in 1825 by *Songs of a Stranger*, dedicated to W. L. Bowles. Ten years later appeared her *Specimens of the Early Poetry of France*, illustrated by beautifully executed illuminations, the work of her brother and herself. It was dedicated to Moore, and procured her his friendship as well as that of Sir Walter Scott. Her principal works are—*A Summer among the Bocages and Vines* (1840); *The Queen's Poisoner* (or *The Queen-Mother*), a historical romance (1841); *Bearn and the Pyrenees* (1844); *Memoirs of Eminent Englishwomen* (1844); *The Rose Garden of Persia* (1845), a series of translations from Persian poets, with illuminations by herself and her brother; *The Falls, Lakes and Mountains of North Wales* (1845); *Clara Fane* (1848), a novel; *Memoirs of Mary of Burgundy* (1853); and *Memoirs of Anne of Brittany* (1855). She died at Boulogne on the 24th of April 1870.

**COSTER-MONGER** (originally COSTARD-MONGER, a seller of costards, a species of large ribbed apple). The word "monger" is common, in various forms, in Teutonic languages in the sense of trader or dealer, and appears in "iron-monger" or "fish-monger," and with a derogatory significance of petty or under-hand dealing in such words as "scandal-monger." A "costermonger," or "coster," originally, therefore, one who sold apples and fruit in the street, is now an itinerant dealer in fruit, vegetables or fish, but more particularly, as distinguished from a "hawker" on the one hand, and "general dealer" on the other, is a street trader in the above commodities who uses a barrow. The coster-monger's trade in London, so far as it falls under clause 6 of the Metropolitan Streets Act 1867, which deals with obstruction by goods to footways and streets is subject to regulations of the commissioner of police. So long as these are carried out, coster-mongers, street hawkers and itinerant traders are exempted, by an amending act, from the liabilities imposed by clause 6 of the above act.

**COSTS**, a term used in English law to denote the expenses incurred (1) in employing a lawyer in his professional capacity for purposes other than litigation; (2) in instituting and carrying on litigation whether with or without the aid of a lawyer.

**Solicitor and Client.**—The retainer of a solicitor implies a contract to pay to him his proper charges and disbursements with respect to the work done by him as a solicitor. In cases of conveyancing his remuneration is now for the most part regulated by scales *ad valorem* on the value of the property dealt with (Solicitors' Remuneration Order 1882), and clients are free to make written agreements for the conduct of any class of non-litigious business, fixing the costs by a percentage on the value of the amount involved. So far as litigious business is concerned, the arrangement known as "no cure no pay" is objected to by the courts and the profession as leading to speculative actions, and stipulations as to a share of the proceeds of a successful action are champertous and illegal. An English solicitor's bill drawn in the old form is a voluminous itemized narrative of every act done by him in the cause or matter with a charge set against each entry and often against each letter written. Before the solicitor can recover from his client the amount of his charges, he must deliver a signed bill of costs and wait a month before suing.

The High Court has a threefold jurisdiction to deal with solicitors' costs:—(1) by virtue of its jurisdiction over them

as its officers; (2) statutory, under the Solicitors Act 1843 and other legislation; (3) ordinary, to ascertain the reasonableness of charges made the subject of a claim.

The client can, as a matter of course, get an order for taxation within a month of the delivery of the solicitor's bill, and either client or solicitor can get such an order as of course within twelve months of delivery. After expiry of that time the court may order taxation if the special circumstances call for it, and even so late as twelve months after actual payment.

Costs as between solicitor and client are taxed in the same office as litigious costs, and objections to the decisions of the taxing officer, if properly made, can be taken for review to a judge of the High Court and to the Court of Appeal.

*Litigious Costs.*—The expenses of litigation fall in the first instance on the person who undertakes the proceedings or retains and employs the lawyer. It is in accordance with the ordinary ideas of justice that the expenses of the successful party to litigation should be defrayed by the unsuccessful party, a notion expressed in the phrase that "costs follow the event." But there are many special circumstances which interfere to modify the application of this rule. The action, though successful, may be in its nature frivolous or vexatious, or it may have been brought in a higher court where a lower court would have been competent to deal with it. On the other hand the defendant, although he has escaped a judgment against him, may by his conduct have rendered the action necessary or otherwise justifiable. In such cases the rule that costs should follow the event would be felt to work an injustice, and exceptions to its operation have therefore been devised. In the law of England the provisions as to litigious costs, though now simpler than of old, are still elaborate and complicated, and the costs themselves are on a higher scale than is known in most other countries.

Except as regards appeals to the House of Lords and suits in equity, the right to recover costs from the opposite party in litigation has always depended on statute law or on rules made under statutory authority. "Costs are the creature of statute." The House of Lords has declared its competence to grant costs on appeals independently of statute.

In the judicial committee of the privy council the power to award, in its discretion, costs on appeals from the colonies or other matters referred to it, is given by § 15 of the Judicial Committee Act 1833; and the costs are taxed by the registrar of the council.

Courts of equity have always claimed a discretion independently of statute to give or refuse costs, but as a general rule the maxim of the civil law, *victus victori in expensis condemnatus est*, was followed. The successful party was recognized to have a prima facie claim to costs, but the court might, on sufficient cause shown, not only deprive him of his costs, but even in some rare cases order him to pay the costs of his unsuccessful opponent. There was a class of cases in which the court generally gave costs to parties sustaining a certain character, whatever might be the result of the suit (*e.g.* trustees, executors and mortgagees).

In the courts of common law, costs were not given either to plaintiff or defendant, although the damages given to a successful plaintiff might suffice to cover not only the loss sustained by the wrong done, but also the expense he had been put to in taking proceedings. The defendant in a baseless or vexatious action could not even recover his costs thus indirectly, and the indirect costs given to a plaintiff under the name of damages were often inadequate and uncertain. Costs were first given under the Statute of Gloucester (1277, 6 Edward I. c. 1), which enacted that "the demandant shall recover damages in an assize of novel disseisin and in writs of mort d'ancestor, cosinage, aiel and beziel, and further that the demandant may recover against the tenant the costs of his writ purchased together with the damages above said. And this act shall hold in all cases when the party is to recover damages." The words "costs of his writ" were extended to mean all the legal costs in the suit. The statute gave costs, wherever damages were recovered, and no matter what the amount of the damages may be. Costs were first given to a defendant by the Statute of Marlbridge (1267) in a case relating

to wardship in chivalry (52 Henry III. c. 6); but costs were not given generally to successful defendants until 1531 (23 Henry VIII. c. 15), when it was enacted that "if in the actions therein mentioned the plaintiff after appearance of the defendant be nonsuited, or any verdict happen to pass by lawful trial against the plaintiff, the defendant shall have judgment to recover his costs against the plaintiff, to be assessed and taxed at the discretion of the court, and shall have such process and execution for the recovery and paying his costs against the plaintiff, as the plaintiff should or might have had against the defendant, in case the judgment had been given for the plaintiff." In 1606 by 4 James I. c. 3, this "good and profitable law" was extended to other actions not originally specified, although within the mischief of the act, so that in any action wherein the plaintiff might have costs if judgment were given for him, the defendant if successful should have costs against the plaintiff. The policy of these enactments is expressed to be the discouragement of frivolous and unjust suits. This policy was carried out by other and later acts. The Limitations Act 1623, § 6, ordered that if the plaintiff in an action of slander recovered less than 40s. damages, the plaintiff should be allowed no more as costs than he got as damages. By 43 Elizabeth c. 6 it was enacted that in any personal action not being for any title or interest in land, nor concerning the freehold or inheritance of lands nor for battery, where the damages did not amount to 40s. no more costs than damages could be allowed. By 3 & 4 Vict. c. 24 (Lord Denman's Act 1840), where the plaintiff in an action of tort recovered less than 40s., he was not allowed costs unless the judge certified that the action was really brought to try a right besides the right to recover damages, or that the injury was wilful or malicious.

All these enactments have been superseded by the Judicature Acts, but in the case of slander on women the provisions of the act of 1623 were re-enacted in the Slander of Women Act 1891.

*Supreme Court.*—The general rule now in force in the Supreme Court of Judicature is as follows:—"Subject to the provisions of the Judicature Acts and the rules of the court made thereunder, and to the express provision of any statute whether passed before or after the 14th of August 1890, the costs of and incident to all proceedings in the Supreme Court, including the administration of estates and trusts, shall be in the discretion of the court or judge, and the court or judge shall have full power to determine by whom and to what extent such costs are to be paid. Provided (1) that nothing herein contained shall deprive an executor, administrator, trustee or mortgagee who has not unreasonably carried on or resisted any proceedings of any right to costs out of a particular estate or fund to which he would be entitled under the rules hitherto (*i.e.* before 1883) acted upon in the chancery division as successor of the court of chancery; (2) that where an action, cause, matter or issue is tried with a jury, the costs shall follow the event unless the judge who tried the case or the court shall for good cause otherwise order." (R.S.C., O. 65, r. 1.)

The rule above stated applies to civil proceedings on the crown side of the king's bench division, including mandamus, prohibition *quo warranto*, and certiorari (*R. v. Woodhouse*, 1906, 2 K.B. 502, 540); and to proceedings on the revenue side of that division (O. 68, r. 1); but it does not apply to criminal proceedings in the High Court, which are regulated by the crown office rules of 1906, or by statutes dealing with particular breaches of the law, and as to procedure in taxing costs by O. 65, r. 27, of the Rules of the Supreme Court.

The rule is also subject to specific provision empowering the courts to limit the costs to be adjudged against the unsuccessful party in proceedings in the High Court, which could and should have been instituted in a county court, *e.g.* actions of contract under £100, or actions of tort in which less than £10 is recovered (County Courts Act 1888, §§ 65, 66, 116; County Courts Act 1903, § 3).

For instance, in actions falling within the Public Authorities Protection Act 1893 against public bodies or officials, the defendant, if successful, is entitled to recover costs as between solicitor and client unless a special order to the contrary is made

by the court; and under some statutes still unrepealed, double or treble costs are to be allowed. Besides the rules above stated, there is also a provision, adopted from the practice of courts of equity, that if tender was made before action of a sum sufficient to satisfy the plaintiff's just demand and is followed by payment into court in the action of the sum tendered, the court will make the plaintiff pay the costs of action as having been unnecessarily brought.

Costs of interlocutory proceedings in the course of a litigation are sometimes said to be "costs in the cause," that is, they abide the result of the principal issue. A party succeeding in interlocutory proceedings, and paying the costs therein made "costs in the cause," would recover the amount of such costs if he had a judgment for costs on the result of the whole trial, but not otherwise. But it is usual now not to tax the costs of interlocutory proceedings till after final judgment.

**Taxation.**—When an order to pay the costs of litigation is made the costs are taxed in the central office of the High Court, unless the court when making the order fixes the amount to be paid (R.S.C., O. 65, r. 23). Recent changes in the organization for taxing have tended to create a uniformity of system and method which had long been needed.

The taxation is effected, under an elaborate set of regulations, by reference to the prescribed scales, and on what is known as the lower scale, unless the court has specially ordered taxation on the higher scale (R.S.C., O. 65, rr. 8, 9, appendix N).

In the taxation of litigious costs two methods are still adopted, known as "between party and party" and "between solicitor and client." Unless a special order is made the first of the two methods is adopted. Until very recently "party and party" costs were found to be a very imperfect indemnity to the successful litigant; because many items which his solicitor would be entitled to charge against him for the purposes of the litigation were not recoverable from his unsuccessful opponent. The High Court can now, in exercise of the equitable jurisdiction derived from the court of chancery, make orders on the losing party to pay the costs of the winner as between solicitor and client. These orders are not often made except in the chancery division. But even where party and party costs only are ordered to be paid under the present practice (dating from 1902), the taxing office allows against the unsuccessful party all costs, charges and expenses necessary or proper for the attainment of justice or defending the rights of the successful party, but not costs incurred through over-caution, negligence, or by paying special fees to counsel or special fees to witnesses or other persons, or by any other unusual expenses (R.S.C., O. 65, rr. 27, 29). This practice tends to give an approximate indemnity, while preventing oppression of the losing party by making him pay for lavish expenditure by his opponent. The taxation is subject to review by a judge on formal objections carried on, and an appeal lies to the Court of Appeal.

**County Courts.**—The costs of all proceedings in county courts follow the event, unless the judge in his discretion otherwise orders. The amount allowed is regulated by scales included in the county court rules, and is ascertained by the registrar of the court subject to any special direction by the judge, and to review by him. The costs are allowed as between party and party, but the registrar on the application of solicitor or party, and subject to the like review, taxes costs as between solicitor and client. Nothing is allowed which is not sanctioned by the scales, unless it is proved that the client has agreed in writing to pay (County Courts Act 1888, § 118).

**Costs in Criminal Cases.**—In criminal cases the right to recover the expenses of prosecution or defence from public funds or the opposite party depends wholly on statute. According to the common law rule the crown neither pays nor receives costs, but the rule is in some cases altered by statute (*Thomas v. Pritchard*, 1903, 1 K.B. 209).

Courts of summary jurisdiction may order costs to be paid by the unsuccessful to the successful party (Summary Jurisdiction Act 1848, § 18).

On prosecutions for treason or felony the court may order the

accused person, if convicted, to pay the costs of his prosecution (Forfeiture Act 1870); and the like power exists as to persons convicted of offences indictable under the Criminal Law Amendment Act 1885 (see § 18), and as to persons convicted on indictment of assault, corrupt practices at elections, offences against the Merchandise Marks Acts, or of defamatory libel, if they have unsuccessfully pleaded jurisdiction.

Provision is also made for the payment out of the local rate of the district of the costs of prosecuting all felonies (except treason-felony) and a number of misdemeanours. A list of these offences will be found in Archbold, *Criminal Pleading*, 23rd ed., 246. The legislation on this subject authorizes the payment of the expenses of witnesses and of the prosecutor, both at a preliminary inquiry before justices and at the trial, and in the case of summary conviction for any of the indictable offences in question. It has been extended so as to include the expenses of witnesses for the defence in any indictable case if they have given evidence at the preliminary inquiry, and the costs of the defence of poor prisoners in every indictable case in which the committing justices or the court of trial certify for legal aid (Poor Prisoners' Defence Act 1903). The costs are taxed by the proper officer of the court of assize or the clerk of the peace in accordance with scales issued by the Home Office in 1903 and 1904. These scales do not fix the fees to be allowed to counsel or solicitor for the prosecution. The costs, when taxed, are paid by the treasurer of the county or borough on whom the order for payment is made.

Where a prosecution or indictment fails, the prosecutor cannot as a rule be made to pay the costs of the defence: except in cases within the Vexatious Indictments Act 1850 and its amendments (*i.e.* where he has, after a refusal by justices to commit for trial, insisted on continuing the prosecution); or where a defamatory libel is successfully justified, or where prosecutions in respect of merchandise marks or corrupt practices at elections have failed. (W. F. C.)

**COSTUME** (through the Fr. *costume*, from Ital. *costume*, Late Lat. *costuma*, a contracted form of Lat. *consuetudinem*, acc. of *consuetudo*, custom, habit, manner, &c.), dress or clothing, especially the distinctive clothing worn at different periods by different peoples or different classes of people. The word appears in English in the 18th century, and was first applied to the correct representation, in literature and art, of the manners, dress, furniture and general surroundings of the scene represented. By the early part of the 19th century it became restricted to the fashion or style of personal apparel, including the head-dresses, jewelry and the like.

The subject of clothing is far wider than appears at first sight. To the average man there is a distinction between clothing and ornament, the first being regarded as that covering which satisfies the claims of modesty, the second as those appendages which satisfy the aesthetic sense. This distinction, however, does not exist for science, and indeed the first definition involves a fallacy of which it will be as well to dispose forthwith.

Modesty is not innate in man, and its conventional nature is easily seen from a consideration of the different ideas held by different races on this subject. With Mahomedan peoples it is sufficient for a woman to cover her face; the Chinese women would think it extremely indecent to show their artificially compressed feet, and it is even improper to mention them to a woman; in Sumatra and Celebes the wild tribes consider the exposure of the knee immodest; in central Asia the finger-tips, and in Samoa the navel are similarly regarded. In Tahiti and Tonga clothing might be discarded without offence, provided the individual were tattooed; and among the Caribs a woman might leave the hut without her girdle but not unpainted. Similarly, in Alaska, women felt great shame when seen without the plugs they carried in their lips. Europeans are considered indelicate in many ways by other races, and a remark of Peschel<sup>1</sup> is to the point: "Were a pious Mussulman of Ferghana to be present at our balls and see the bare shoulders of our wives and daughters, and the semi-embraces of our round dances, he would silently wonder at the long-suffering of Allah who had not long

<sup>1</sup> *The Races of Man.*

ago poured fire and brimstone on this sinful and shameless generation." Another point of interest lies in the difference of outlook with which nudity is regarded by the English and Japanese. Among the latter it has been common for the sexes to take baths together without clothing, while in England mixed bathing, even in full costume, is even now by no means universal. Yet in England the representation of the nude in art meets with no reproach, though considered improper by the Japanese. Even more striking is the fact that in civilized countries what is permitted at certain times is forbidden at others; a woman will expose far more of her person at night, in the ballroom or theatre, than would be considered seemly by day in the street; and a bathing costume which would be thought modest on the beach would meet with reprobation in a town.

Modesty therefore is highly conventional, and to discover its origin the most primitive tribes must be observed. Among these, in Africa, South America, Australia and so forth, where clothing is at a minimum, the men are always more elaborately ornamented than the women. At the same time it is noticeable that no cases of spinsterhood are found; celibacy, rare as it is, is confined to the male sex. It is reasonable, therefore, to conclude that ornament is a stimulus to sexual selection, and this conclusion is enforced by the fact that among many comparatively nude peoples clothing is assumed at certain dances which have as their confessed object the excitation of the passions of the opposite sex. Many forms of clothing, moreover, seem to call attention to those parts of the body of which, under the conditions of Western civilization at the present day, it aims at the concealment; certain articles of dress worn by the New Hebrideans, the Zulu-Xosa tribes, certain tribes of Brazil and others, are cases in point. Clothing, moreover—and this is true also of the present day—almost always tends to accentuate rather than to conceal the difference between the sexes. Looking at the question then from the point of view of sexual selection it would seem that a stage in the progress of human society is marked by the discovery that concealment affords a greater stimulus than revelation; that the fact is true is obvious,—even to modern eyes a figure partially clad appears far more indecent than a nude. That the stimulus is real is seen in the fact that among nude races flagrant immorality is far less common than among the more clothed; the contrast between the Polynesians and Melanesians, living as neighbours under similar conditions, is striking evidence on this point. Later, when the novelty of clothing has spent its force, the stimulus is supplied by nudity complete or partial.

One more point must be considered: there is the evidence of competent observers to show that members of a tribe accustomed to nudity, when made to assume clothing for the first time, exhibit as much confusion as would a European compelled to strip in public. This fact, considered together with what has been said above, compels the conclusion that modesty is a feeling merely of acute self-consciousness due to appearing unusual, and is the result of clothing rather than the cause. In the words of Westermarck: "The facts appear to prove that the feeling of shame, far from being the cause of man's covering his body, is, on the contrary, a result of this custom; and that the covering, if not used as a protection from the climate, owes its origin, at least in a great many cases, to the desire of men and women to make themselves mutually attractive."

Primitive adornment in its earliest stages may be divided into three classes; first the moulding of the body itself to certain local standards of beauty. In this category may be placed head-deformation, which reached its extreme development among the Indians of North-West America and the ancient Peruvians; foot-constriction as practised by the Chinese; tooth-chipping among many African tribes; and waist-compression common in Europe at the present day. Many forms of deformation, it may be remarked in passing, emphasize some natural physical characteristic of the people who practise them. Secondly, the application of extraneous matter to the body, as painting and tattooing, and the raising of ornamental scars often by the introduction of foreign matter into flesh-wounds

(this practice belongs partly to the first category also). Thirdly, the suspension of foreign bodies from, or their attachment to, convenient portions of the body. This category, by far the largest, includes ear-, nose- and lip-ornaments, head-dresses, necklets, armlets, wristlets, leglets, anklets, finger- and toe-rings and girdles. The last are important, as it is from the waist-ornaments chiefly that what is commonly considered clothing at the present day has been developed.

Setting aside for the moment the less important, historically, of these, nearly all of which exist in Western civilization of the present day, it will be as well to consider that form of dress which is marked by the greatest evolution. It is generally supposed that man originated in tropical or subtropical latitudes, and spread gradually towards the poles. Naturally, as the temperature became lower, a new function was gradually acquired by his clothing, that of protecting the body of the wearer. Climate then is one of the forces which play an important part in the evolution of dress; at the same time care must be taken not to attribute too much influence to it. It must be remembered that the Arabs, who inhabit an extremely hot country, are very fully clothed, while the Fuegians at the extremity of Cape Horn, exposed to all the rigours of an antarctic climate, have, as sole protection, a skin attached to the body by cords, so that it can be shifted to either side according to the direction of the wind.

Dr. C. H. Stratz divides clothing climatically into two classes: tropical, which is based on the girdle (or, when the attachment is fastened round the neck, the cloak), and the arctic, based on the trouser. This classification is ingenious and convenient as far as it goes, but it seems probable that the trouser, which also has the waist as its point of attachment, may itself be a further development of the girdle. Certainly, however, in historical times the division holds good, and it is worthy of remark that one of the points about the northern barbarians which struck the ancient Greeks and Romans most forcibly was the fact that they wore trousers. Amongst the most northerly races the latter garb is worn by both sexes alike; farther south by the men, the women retaining the tropical form; farther south still the latter reigns supreme. No distinct latitude can be assigned as a boundary between the two forms, from the simple fact that where migration in comparatively recent times has taken place a natural conservatism has prevented the more familiar garb from being discarded; at the same time the two forms can often be seen within the limits of the same country; as, for instance, in China, where the women of Shanghai commonly wear trousers, those of Hong-Kong skirts. The retention by women in Europe of the tropical garb can be explained by the fact that her sphere has been mainly confined to the house, and her life has been less active than that of man; consequently the adoption of the arctic dress has been in her case less necessary. But it is noticeable that where women engage in occupations of a more than usually strenuous nature, they frequently don male costume while at their work; as, for instance, women who work in mines (Belgium) and who tend cattle (Switzerland, Tirol). The retention of the tropical pattern by the Highlanders is due directly to environment, since the kilt is better suited than trousers for walking over wet heather.

Another factor besides climate which has exerted a powerful influence on dress—more perhaps on what is commonly regarded as "jewelry" as distinct from "clothing"—is superstition. Doubtless many of the smaller objects with which primitive man adorned himself, especially trophies from the animal world, were supposed to exert some beneficial or protective influence on the wearer, or to produce in him the distinguishing characteristics attributed to the object, or to the whole of which the object was a part. Such objects might be imitated in other materials and by successive copying lose their identity, or their first meaning might be otherwise forgotten, and they would ultimately exercise a purely decorative function. Though this factor may be responsible for much, or even the greater part, of primitive "jewelry," yet it does not seem likely that it is the cause of all forms of ornament; much must be attributed to the desire to satisfy an innate aesthetic sense, which is seen in children

and of which some glimmerings appear among the lower animals also.

See Ed. Westermarck, *The History of Human Marriage* (London, 1901); Racinet, *Le Costume historique* (Paris, 1888); C. H. Stratz, *Frauenkleidung* (Stuttgart). (T. A. J.)

### I. ANCIENT COSTUME

i. *Ancient Oriental*.—Although the numerous discoveries of monuments, sculptures, wall-paintings, seals, gems, &c., combine with the evidence from inscriptions and from biblical and classical writers to furnish a considerable accumulation of material, the methodical study of costume (in its widest sense) in the ancient oriental world (western Asia and Egypt) has several difficulties of its own. It is often difficult to obtain quite accurate or even adequate reproductions of scenes and subjects, and, when this is done, it is obviously necessary to refrain from treating the work of the old artists and sculptors as equivalent to photographic representations. Art tended to become schematic, artists were bound by certain limitations and conventions (Egypt under Amenophis IV. is a notable exception), and their work was apt to be stilted. In Egypt, too, the spirit of caricature occasionally shows itself. But when every allowance is made for the imperfections or the cunning of the workman, one need only examine any collection of antiquities to see that there was a distinct appreciation of foreign physical types (not so much for personal portraiture), costumes, toilet, armour and decoration, often markedly different from native forms, and that a single scene (e.g. war, tribute-bearers, captives) will represent varieties of dress which are consistently observed in other scenes or which can be substantiated from native sources.<sup>1</sup> Important evidence can thus be obtained on ethnological relations, foreign influences and the like. Speaking generally, it has been found that the East as opposed to the West has undergone relatively little alteration in the principal constituents of dress among the bulk of the population, and, although it is often difficult to interpret or explain some of the details as represented (one may contrast, for example, worn sculptures or seals with the vivid Egyptian paintings), comparison with later descriptions and even with modern usage is frequently suggestive. The vocabulary of old oriental costume is surprisingly large, and some perplexity is caused by the independent evolution both of the technical terms (where they are intelligible) and of the articles of dress themselves. In reality there were numerous minor variations in the cut and colour of ancient dress even as there are in the present day in or around Palestine. These differences have depended upon climate, occupation, occasion (e.g. marriage, worship, feasts), and especially upon individual status and taste. Rank has accounted for much, and ceremonial dress—the apparel

Romans, naturally left its mark, and there have been ages of increasing luxury followed by periods of reaction, with a general levelling and nationalization on religious grounds (Judaism, Islam). All in all the study of oriental costume down to the days of Hellenism proves to be something more than that of mere apparel, and any close survey of the evidence speedily raises questions which concern old oriental history and thought.

The simplest of all coverings is the loin-cloth characteristic of warm climates, and a necessary protection where there are trying extremes of temperature. Clothing did not originate in ideas of decency (Gen. ii. 25, iii. 7). Children ran and still run about naked, the industrious workman upon the Egyptian monuments is often nude, and the worshipper would even appear before his deity in a state of absolute innocence.<sup>2</sup> The Hebrews held that the leaves of the fig-tree (the largest available tree in Palestine) served primitive man and that the Deity gave them skins for a covering—evidently after he had slain the animals (Gen. iii. 21). With this one may compare the Phoenician myth (now in a late source) which ascribed the novelty of the use of skins to the hero Usōos (cf. the biblical Esau, *q.v.*). The loin- or waist-cloth prevailed under a very great variety of minor differentiated forms. In Egypt it was the plain short linen cloth wrapped around the loins and tied in front (see fig. 1). It was the usual garb of scribes, servants and peasants, and in the earlier dynasties was worn even by men of rank. Sometimes, however, it was of matting or was seated with leather, or it would take the form of a narrow fringed girdle resembling that of many African tribes. The Semites who visited Egypt wore a larger and coloured cloth, ornamented with parallel stripes of patterns similar to those found upon some early specimens of Palestinian pottery. The border was fringed or was ornamented with bunches of tassels. But a close-fitting skirt or tunic was more usual, and the Semites on the famous Beni-Hasan tombs (about the 20th or 19th century B.C.) wear richly decorated cloth (pattern similar to the above), while the leader is arrayed in a magnificent wrapper in blue, red and white, with fringed edges, and a neck-ribbon to keep

Body-covering.



FIG. 1.—Egyptian Loin-cloth.



FIG. 2.—Asiatics visiting Egypt (Beni-Hasan Tombs).

of the gods, their representatives and their ministers—opens out several interesting lines of inquiry. The result of intercourse, whether with other Orientals, or (in later times) with Greeks and

<sup>1</sup> The comprehensive description by Herodotus (vii. 61 sqq.) of the costumes of the mercenaries of Xerxes is classical (see Rawlinson's edition, iv. 56 sqq.). For archaeological parallels one may compare the tombs of Rekhmire (15th cent. B.C.) and Harmhab (14th cent.) in Egypt, the "Black Obelisk" of the Assyrian king Salmanser II. (9th cent.) or his famous gates at Balawat (ed. W. Birch and T. G. Pinches, and with critical description and plates by A. Billerbeck and F. Delitzsch, *Beiträge z. Assyriologie*, vi. 1; Leipzig, 1908).

it in position (see fig. 2).<sup>3</sup> In harmony with prevailing custom the women's dress is rather longer than that of the men, but both sexes have the arms free and the right shoulder is exposed. Returning to Egypt we find that the loin-cloth developed downwards into a skirt falling below the knees. Among the upper classes it was unusually broad and was made to stand out in

<sup>2</sup> Old Babylonian sculptors who represent the enemy as naked (Meyer [see bibliography below], pp. 12, 70 seq., 116), conventionally anticipate the usual treatment of the slain and wounded warriors.

<sup>3</sup> Edited P. C. Newberry (*Archaeol. Survey of Egypt*, 1893). Cf. also the Palestinian short coloured skirt with black tassels of the 14th century (*Zeit. f. Ägypt. Sprache*, 1898, pp. 126 sqq.).



front in triangular form. In the Middle Kingdom an outer fine light skirt was worn over the loin-cloth; ordinary people, however, used thicker material. Egyptian women had a tight foldless tunic which exposed the breasts; it was generally kept up by means of braces over the shoulders. This plain diaphanous garment, without distinction of colour (white, red or yellow), and with perhaps only an embroidered hem at the top, was worn by the whole nation, princess and peasant, from the IVth to the XVIIIth Dynasties (Erman, *Life in Ancient Egypt*, p. 212). Variation, such as it was, consisted of a sleeveless dress covering



From Hilprecht's *Explorations in Bible Lands*, by permission of A. J. Holman & Co. and T. & T. Clark.

FIG. 3.—Old Babylonian Costume.

the shoulders, the neck being cut in the shape of a V. Female servants and peasants when engaged at work, however, had a short skirt which left the legs free and the upper part of the body bare; a like simplicity was probably customary among female servants or captives throughout (cf. Isa. xlvii. 2). Even at the present day the wardrobe of the Sinaitic Bedouin is much more complicated than that of their female folk.

The earliest dress of Babylonia also covered only the lower half of the body. As worn by gods and men it was a long and rather loose kind of skirt suspended from a girdle. It is sometimes smooth; but sometimes it is a shaggy skin (or woollen) skirt with horizontal rows of vertically furrowed stuff. It allowed a certain freedom to the legs, but often it is not clear whether it was joined down the middle. An instructive development shows the upper part of the skirt hanging over the girdle so that an elementary mantle would be obtained by drawing the loose end up over the shoulders (Meyer, p. 93, cf. pp. 55, 76). The characteristic skirt is sometimes supplemented by a coarse cloth, perhaps a fleece, thrown over the shoulders; and in later times it is seen fastened outside a tunic by means of a girdle (see fig. 3).



FIG. 4.—Naram-Sin on the Stele of Victory.

The favourite attitude, one leg planted firmly before the other, shows the right leg fully exposed. A tunic or skirt is found as early as the time of Naram-Sin, son of the great Sargon; it reaches to his knees and appears to be held up by ornamental shoulder-

times there is a peculiar design at the neck resembling a cross (Müller, *Asien und Europa*, pp. 298 seq.). The Hittite warriors upon north Syrian sculptures (Zenjirli, perhaps 11th to 9th centuries) have a short-sleeved tunic which ends above the knees, and this type of garment recurs over a large area with numerous small variations (with or without girdle, slits at the neck, or bordering). An interesting example of the long plain variety is afforded by the prisoners of Lachish before Sennacherib (701 B.C.); the circumstances and a comparison of the details would point to its being essentially a simple dress indicative of mourning and humiliation. It may be compared in its general form with the woollen *jubba* of Arabia, which reached to the knees and was sewn down the front (except at the top and bottom). A modern Bedouin equivalent has long sleeves; it is common to both sexes, the chief difference lying in the colour—white for men, dyed with indigo for women.

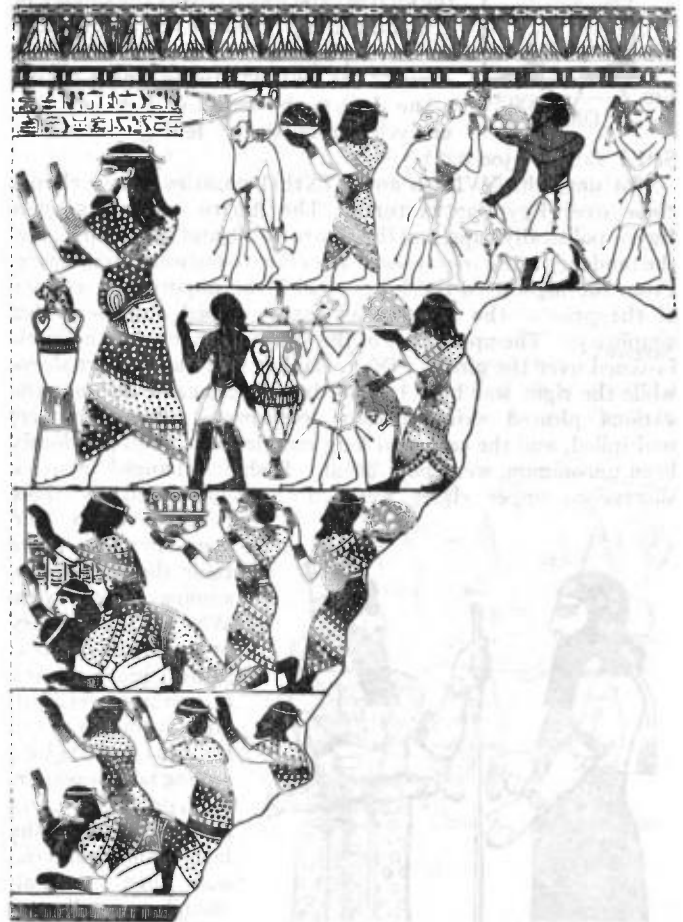

FIG. 5.—Asiatic Envoys in Egypt.

Another very characteristic garment suggests an original loin-cloth considerably longer: than the elementary article which was noticed above. The Arab *izār*, though now a large outer wrapper, was once a loin-cloth (like the Hebrew *ezōr*), which, however, was long enough to be trodden upon. At the present day male and female pilgrims at Mecca wear such a cloth (the *ihrām*); it covers the knees and one end of it may be cast over the shoulder. In Egyptian tombs have been found linen bands no less than 30 ft. in length and 3 ft. in width. The distinctive feature is the spiral arrangement of the garment, the body being wrapped to a greater or less extent with a bandage of varying length in more or less parallel stripes. In old Babylonia both the arms and the whole of the right shoulder were originally uncovered, and one end of the garment was allowed to hang loose over the left arm. It is frequently found upon deities, kings and magnates, and appears to have been composed of some thick furrowed or fluted material, sometimes of bright and variegated design. Not seldom it is difficult to distinguish between the true spiral garment and a dress with parallel horizontal stripes, and

one could sometimes suppose that the flounced dress with volants, well known in the Aegean area, had its parallel in Babylonia.<sup>1</sup> Egypt furnishes admirable painted and sculptured representations of the forms taken by the Semitic spiral dress in the XVIIIth and XIXth Dynasties; the highly-coloured and gay apparel of Palestine and Syria standing in the strongest

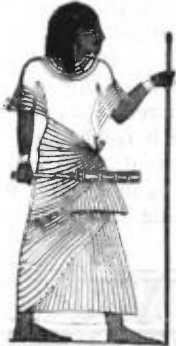

FIG. 6.—An Egyptian Officer.

contrast to the plain, simple and often scanty garments of the Egyptians (fig. 5). While the common Semite wore a short skirt, often with tassels and sometimes with an upper tunic, the more important had an elaborate scarf (extending from waist to knee) wound over the long tunic, or a longer and close-fitting variety coloured blue and red and generally adorned with rich embroidery. A significant feature is the kind of cape which covers the shoulders; it would not and no doubt was not intended to leave play for the arms; it was the dress of the leisured classes, and a typical scene depicts the chiefs of Lebanon thus arrayed submissively felling cedars for

Seti I. (about 1300 B.C.).

Not until the XVIIIth and XIXth Dynasties does a change come over Egyptian costume. The Asiatic conquests made Egypt politically supreme, the centre of life and intercourse, and the tendency arose to pay some attention to outward appearance. From the highest to the lowest—with the important exception of the priests—the new age of luxury wiped out the earlier simplicity. The upper part of the body was covered with a tunic fastened over the girdle. Often the left arm had a short sleeve while the right was bare, but flowing sleeves came into use and various pleated skirts became customary. Garments were multiplied, and the cape and long mantle, which had previously been uncommon, were now usual. Fashions changed in quick succession; upper classes were successively copied by those

beneath them and were forced to ensure their dignity by assuming new styles. Whether for ordinary or for special occasions a great variety of costume prevailed, and several types can be distinguished among both sexes (Erman, pp. 207 seq., 213 sqq.; see fig. 6). The fashionable material was linen, and although, according to Herodotus (ii. 81), a woollen mantle was worn over the fringed linen skirt, wool was forbidden to the priests in the temple. The preference for fine white linen, quite in keeping with the exaggerated Egyptian ideas of cleanliness, brought the art of spinning and weaving to a singularly high level; in embroidery, as in tapestry, however, it is probable that western Asia more than held its own (see figs. 7 and 8).

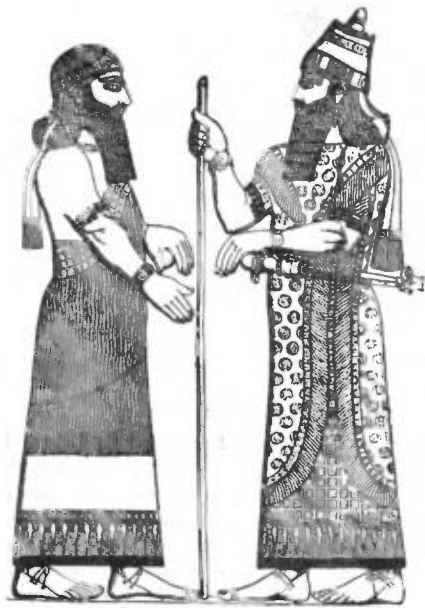

Drawn from a photo by Giraudon.

FIG. 7. Sargon and his Commander-in-Chief.

Quite distinct from the spiral is the old Babylonian cloak, which was thrown over the left shoulder, passed under the right

<sup>1</sup> See e.g. Ball, *Light from the East*, p. 36. On the Aegean dress (whether a development from spiral swathes or perhaps rather from a series of skirts one above the other), see the discussion of the Aegean loin-cloth by D. Mackenzie, *Annual of the British School at Athens*, xii. 233-249 (esp. 242 seq.).

armpit, and hung down, leaving sufficient freedom for the legs. It is often decorated with a fringed border from top to bottom. In time this mantle covered both shoulders and assumed sleeves, and in one form or another it is frequently represented. So



FIG. 8.—Assyrian Officers.

Jehu's tribute-bearers wear short sleeves, trimmed border, and the general effect could even suggest an Assyrian dress (see fig. 9). Not unlike this is the style on the bilingual Hittite boss of Tarkudimme, where the skirt ends in a point nearly to the ground and one leg stands out bare to the front—the very favourite attitude. Long fringed robes were worn by Hittites of both sexes, and the women represented at Mar'ash and Zenjirli wear

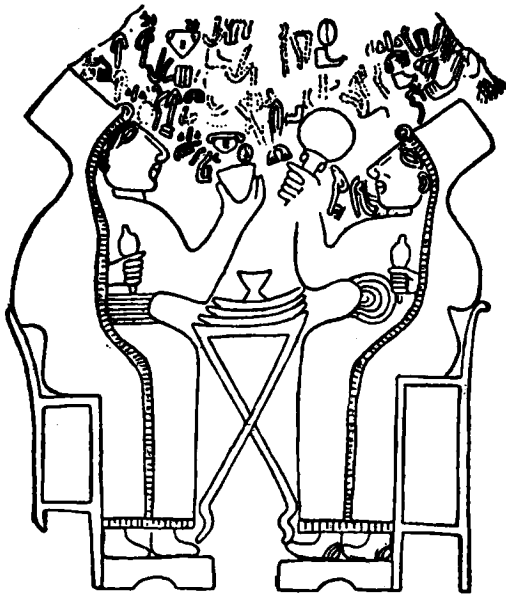

FIG. 9.—Israelite Tribute-bearers introduced by two Assyrian Officers.

it hung over the characteristic Hittite cylindrical head-dress (fig. 10). On the other hand, the unhappy females of Lachish have a long plain mantle which covers the head and forehead (fig. 11), and the same principle recurs in modern usage, where the tunic will be supplemented by a veil or shawl (generally bound to the head by a band) frames the face and falls back to the waist. A large mantle could thus serve as a veil, and Rebekah covered her face with her square or oblong wrapper on meeting Isaac (Gen. xxiv. 65). Veiling was ceremonial (1 Cor. xi. 5), and customary on meeting a future bridegroom or at marriage (see Gen. xxix. 23-25). Nevertheless veils were not usually worn out of doors, the countrywoman of to-day is not veiled, and it is uncertain whether there is any early parallel for the *yashmak*, the narrow strip which covers the face below the eyes and hangs down to the feet.

Before passing to the special covering for the feet and head some further reference to the Old Testament usage may be made. Among the Hebrews the outer garment, as distinct from the inner loin wrapper (*ezôr*) or tunic, evidently took many forms.

The tunic (*kuttōnesh*, cf. *χιτών*, *tunica*), like its Greek counterpart, was apparently of two kinds, for, although essentially a simple and probably sleeveless garment, there was a special variety worn by royal maidens and men of distinction, explicitly described as a tunic of palms or soles (*passim*), that is, one presumably reaching to the hands and feet (Gen. xxxvii. 3; 2 Sam. xiii. 18 sq.)<sup>1</sup> The *kuttōnesh* could be removed at night (Cant. v. 3). For the outer garments the most distinctive term



From *Der alte Orient*, by permission of J. C. Hinrichs'sche Buchhandlung.  
FIG. 10.—Hittite Women.

is the *simlah*. This was worn by both sexes, though obviously there was some difference as regards length, &c. (Deut. xxii. 5). Ruth put one on before going out of doors, and its folds could be used for carrying small loads (Ruth iii. 9; Ex. xii. 34). The law forbade the creditor to retain it over-night as a pledge (Ex. xxii. 26 sq.), and consequently we may assume that it was a large outer wrapper which could be dispensed with out of doors by men, or indoors by women. The *simlah* of the warrior (Isa. ix. 5) can be illustrated from the Assyrian sculptures (*Ency. Bib.*, art. "Siege"); according to Herodotus (vii. 69) the Arabs under Xerxes wore a long cloak fastened by a girdle. The outer girdle (Heb. *ḡōrah*; the Arabic equivalent term is a kilt from thigh to knee) varied, as the monuments show, in richness and design, and could be used as a sword-belt or



FIG. 11.—Prisoners of Lachish.

pocket much in the same way as the modern native uses the long cloth twined twice or thrice around his body. The more ornate variety, called *abnēt*, was worn by prominent officials (Isa. xxii. 21) and by the high priest. The modern oriental open waistcoat finds its fellow in the jacket or bolero from ancient Crete, and seems to have been distinctively Aegean. The same may also be true of breeches. The pantaloons worn by modern females, with short tunic and waistcoat, are not found among the Bedouin (e.g. of Sinai), trousers being considered undignified even for men. But a baggy kind of knickerbockers is represented in old

<sup>1</sup> Joseph's familiar "coat of many colours," which we owe to the Septuagint, can perhaps be justified: R. Eisler, *Orient. Lit. Zeitung*, August, 1908

Aegean scenes, and it is noteworthy that the Arab *mī'zar* (drawers such as were worn by wrestlers or sailors) takes its name from the *isār* or loin-cloth (*Ency. Bib.* 1734). Such a cloth may once have passed between the legs, being kept in position by the waistband (examples in Perrot and Chipiez, *Greece*, ii. 198 sq., 456). On the other hand, among the Africans of Punt the waistcloth passes from each knee to the opposite thigh, and two sashes hang down to conceal the parts where they intersect (Müller, 108). The people of Keft (Aegeans) wore a similar arrangement which is a step in the direction of the proper drawers. The latter are found exceptionally upon Semitic Bedouin with an upper covering of bands wound round the body (Müller, 140). However, the woven decorated drawers in Cyprus do not appear to be of Semitic origin (J. L. Myres, *Classical Review*, x. 355), and it is not until later that they were prescribed to the Israelite priests (Ezek. xlv. 18). But the garment as explained by Josephus (*Ant.* iii. 7. 1) was properly a lion-cloth (cf. the examples from Punt), and the reason given for its use (Ex. xxviii. 42) points to a later date than the law which enforced the same regard for decency by forbidding the priests to ascend altars with steps (*ib.* xx. 26). As trousers were distinctively Persian—though the Persians had the reputation for borrowing Median and foreign dress (Herod. i. 71, vii. 61)—they were no doubt familiar in Palestine in the post-exilic age, and in the Roman period the *braccae* and *feminalia* were certainly known. On supposed references to breeches in Dan. iii. 21, see *Journ. of Philology*, xxvi. 307-313.

Special protection for the feet was chiefly necessary in rocky districts or upon long journeys. In early Egypt men of rank would be followed by a servant carrying a pair of sandals in case of need; but in the New Kingdom they were in common use, although a typical difference is observed when princes appear unshod in the presence of the Pharaoh, who wears sandals himself.

The simplest kind was a pad or sole of leather or papyrus bound to the foot by two straps, one passing over the instep, the other between the toes.<sup>2</sup> A third was sometimes fastened behind the heel, and the front is often turned up to protect the toe (Egypt and elsewhere). The Semites of the XIIth Dynasty wore on their journeys sandals of black leather, those of the women and children being more serviceable, and, in the case of women, parti-



FIG. 12. Assyrian Warriors with captured Idols.

coloured. Practically the same simple sandal came into use everywhere when required. But the warrior had something stouter, and the Hittites wore a turned-up shoe bound round the legs with thongs. Among the latter is also found a piece of protecting leather reaching halfway up the shin, and similar developments with tight-fitting bandages, buskins or laced garters were worn in Assyria and Asia Minor (see fig. 12). Such coverings find their analogies among the peasants of modern Cilicia and Cappadocia. Stockings, it may be added, do not appear, and are quite exceptional at the present day.

The treatment of the hair, moustache and beard is extremely interesting in the study of oriental archaeology (see Müller, Meyer, *opp. cit.*). A special covering for the head was not indispensable. The Semites often bound their bushy locks with a fillet, which varies from a single band (so often, e.g. Palestinian captives, 10th century) to a fourfold

<sup>2</sup> Erman, 226 sqq., cf. the modern Bedouin shoe, Jennings-Bramley, *Quart. Stat. of Palest. Explor. Fund* (1908), p. 115 sq. (on dress of Sinaitic Bedouin generally).

one, from a plain band to highly decorated diadems. The Ethiopians of Tirhakah's army (7th cent.) stuck a single feather in the front of their fillet, and a feathered ornament recurs from the old Babylonian goddess with two large feathers on her head to the feathered crown common from Assur-bani-pal's Arabians to Ararat, and is familiar from the later distinctive Persian head-dress.<sup>1</sup> But the ordinary Semitic head covering was a cloth which sometimes appears with two ends tied in front, the third falling behind. Or it falls over the nape of the neck and is kept in position with a band; or again as a cloth cap has lappets



From Palestine Exploration Fund *Quarterly Statement*, Oct., 1907.

FIG. 13.—Sacrificial Scene on a Seal from Gezer.

to protect the ears. Sometimes it has a more bulky appearance. In general, the use of a square or rectangular cloth (whether folded diagonally or not) corresponds to the modern *keffiyeh* woven with long fringes which are plaited into cords knitted at the ends or worked into little balls sewn over with coloured silks and golden threads.<sup>2</sup> The *keffiyeh* covering cheek, neck and throat, is worn over a small skull-cap and will be accompanied with the relatively modern fez (*tarbūsh*) and a woollen cloth. Probably the oldest head-dress is the circular close-fitting cap (plain or braided), which, according to Meyer, is of Sumerian (non-Semitic) origin. But it has a long history. Palestinian captives in the Assyrian age wear it with a plain close-fitting tunic, and it appears upon the god Hadad in north Syria (cf. also the Gezer seal, fig. 13). With some deities (e.g. the moon-god Sin) it has a kind of straight brim which gives it a certain resemblance to a low-crowned "bowler." Very characteristic is the conical cap which, like the Persian hat (Gr. *kurbasia*), resembled a cock's comb. It is worn by gods and men, and with the latter sometimes has ear-flaps (at Lachish, with other varieties, Ball, 190) or is surmounted by a feather or crest. It was probably made of plaited leather or felt. Veritable helmets

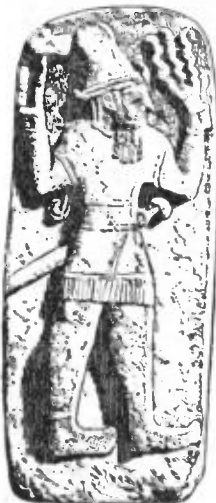

FIG. 14.—Hittite Weather-god.

of metal, such as Herodotus ascribes to Assyrians and Chalybians (vii. 63, 76), and metal armour, though known farther west, scarcely appear in old oriental costume, and the passage which attributes bronze helmets and coats of mail to the Philistine Goliath and the Israelite Saul cannot be held (on other grounds) to be necessarily reliable for the middle or close of the 11th century (1 Sam. xvii.). A loftier head-covering was sometimes spherical at the top and narrowed in the middle; with a brim or border turned up back and front it is worn by Hittite warriors of Zenjirli and by their god of storm and war (fig. 14). Elongated and more pointed it is the archaic crown of the Pharaohs (symbolical of upper Egypt), is worn by a Hittite god of the 14th century, and finds parallels upon old cultus images from Asia Minor, Crete and Cyprus. Later, Herodotus describes it as distinctively Scythian (vii. 64). Finally the cylindrical hat of Hittite kings and queens reappears with lappets in Phoenicia (Perrot and Chipiez, *Phoen.* ii. 77); without the brim it resembles the crown of the Babylonian Merodach-nadin-akhi, with a feathered top it distinguishes Adad (god of storm, &c.) at Babylonia. Narrower at the top and surmounted by a spike it distinguishes the Assyrian kings.

<sup>1</sup> Meyer, 97, see F. Hommel, *Aufsätze u. Abhandlungen* (Munich, 1900), 160 sqq., 214 sqq. For other feathered head-dresses in western Asia, see Müller, 361 sqq.

<sup>2</sup> Such tasselled or fringed caps were used by the Syrians in the Christian era, see W. Budge, *Book of Governors*, ii. 339, 367.

When the deities were regarded as anthropomorphic they naturally wore clothing which, on the whole, was less subject to change of fashion and was apt to be symbolical of their attributes. The old Babylonian hero Gilgamesh and the Egyptian Bes (perhaps of foreign extraction) are nude, and so in general are the figurines of the Ishtar-Astarte type. Numerous bronze images of a kneeling god at Telloh give him only a loin-cloth, and often the deity, like the monarch, has only a skirt. In course of time various plaids or mantles are assumed, and in Babylonia the goddesses were the first to have both shoulders covered. Distinctive features are found in the head-dress, e.g. crowns (cf. the Ammonite god, 2 Sam. xii. 30) or horns (a single pair or an arrangement of four pairs), and in Babylonia symbolical emblems are attached to the shoulders (e.g. the rays of the sun-god, stalks, running water). Long garments ornamented with symbolical designs (stars, &c.) are worn by Marduk and Adad. The custom of clothing images is well known in the ancient world, and at the restoration of an Egyptian temple care was taken to anoint the divine limbs and to prepare the royal linen for the god. The ceremonial clothing of the god on the occasion of festal processions, undertaken in Egypt by the "master of secret things," may be compared with the well-known Babylonian representations of such promenades. The Babylonian temples received garments as payment in kind, and the Egyptian lists in the Papyrus Harris (Rameses III.) enumerate an enormous number of skirts, tunics and mantles, dyed and undyed, for the various deities. A priest, "master of the wardrobe," is named as early as the VIth Dynasty, and later texts refer to the weavers and laundry servants of the temple. It is probable that 2 Kings xxiii. 7 originally referred to the women who wove garments for the goddess in the temple at Jerusalem.

Costume  
of the  
gods.

In Egypt the king was regarded as the incarnation of the deity, his son and earthly likeness. The underlying conception shows itself under differing though not unrelated forms over western Asia, and in their light the question of religious and ceremonial dress is of great interest. Throughout Egyptian history the official costume was conventionalized, and the latest kings and even the Roman emperors are arrayed like their predecessors of the IVth Dynasty. The crook which figures among royal and divine insignia may go back to the boomerang-like object which was a prominent weapon in antiquity (Müller, 123 sq.). It appears in old Babylonia as a curved stick, and, like the club, is a distinctive symbol of god and king. It resembles the sceptre curved at the end, which was carried by old Hittite gods. The Pharaoh's characteristic crown (or crowns) symbolized his royal domains, the sacred uraeus marked his divine ancestry, and he sometimes appeared in the costume of the gods with their fillets adorned with double feathers and horns. In Babylonia Naram-Sin in the guise of a god wears the pointed helmet and two great horns distinctive of the deities.<sup>3</sup> This relationship between the gods and their human representatives is variously expressed. Khammurabi and the sun-god Shamash, on the former's famous code of laws, have the same features and almost the same frizzled beard, and, according to Meyer, the king in claiming supremacy over Sumer and Akkad wears the costume of the lands.<sup>4</sup> Ordinary folk could not claim these honours, and in Egypt, where shaving was practically universal, artificial beards were worn upon solemn occasions as a peculiar duty. But the appendage of the official was shorter than that of the king, and the gods had a distinctive shape for themselves; if it appears upon the dead it is because they in their death had become identified with the god Osiris (Erman, 59, 225 sq.). Young Egyptian princes and youthful kings had

Royal  
costume.

<sup>3</sup> Comp. the horns of Bau ("mother of the gods"), Samas (Shamash), (H)adad, and (in Egypt) of the Asiatic god assimilated to Set (so, too, Rameses III. is styled "strong-horned" like Baal). With the band dependent from the conical hat of Marduk-bal-iddin II. (Meyer, 8) and other kings, cf. the tail on the head-dress of this foreign Set (e.g. *Proc. Soc. of Bibl. Arch.* xvi. 87 sq.). The consort of the Pharaoh, in turn, wore the sacred vulture head-dress.

<sup>4</sup> On the resemblance between divine and royal figures in costume, &c., see further Meyer, 9, 14 sq., 17, 23, 53 sq., 67, 79, 102, 105 sq.



a long plaited lock (or later a lappet) on the side of their head in imitation of the youthful Horus, and the peculiar tonsure adopted by the later Arabs of Sinai was inspired by the desire to copy their god Orotal-Dionysus.<sup>1</sup> Thus we perceive that ancient costume and toilet involves the relations between the gods and men, and also, what is extremely important, the political conditions among the latter. When the king symbolizes both the god and the extent of his kingdom, ceremonies which could appear commonplace often acquire a new significance, any discussion of which belongs to the intricacies of the history of religion and pre-monarchical society. It must suffice, therefore, to record the Pharaoh's simple girdle (with or without a tunic) from which hangs the lion's tail, or the tail-like band suspended from the extremity of his head-dress (above), or the panther or leopard skin worn over the shoulders by the high priest at Memphis, subsequently a ceremonial dress of men of rank. That the Pharaoh's skirt, sometimes decorated with a pleated golden material, should become an honorific garment, the right of wearing which was proudly recorded among the bearer's titles, is quite intelligible, but many difficulties arise when one attempts to identify the individuals represented, or to trace the evolution of ideas.<sup>2</sup>

The well-known conservatism of religious practice manifests itself in ceremonial festivals (where there is a tendency for the original religious meaning to be obscured) and among the priests, and it is interesting to observe that despite the great changes in Egyptian costume in the New Kingdom the priests still kept to the simple linen skirt of earlier days (Erman, 206). Religious dress (whether of priests or worshippers) was regulated by certain fundamental ideas concerning access to the deity and its consequences. That it was proper to wear special garments (or at least to rearrange one's weekday clothes) on the Jewish sabbath was recognized in the Talmud, and Mahomedans, after discussing at length the most suitable raiment for prayer, favoured the use of a single simple garment (Bukhāri, viii.). It was a deep-seated belief that those who took part in religious functions were liable to communicate this "holiness" to others (compare the complex ideas associated with the Polynesian taboo). Hence priests would remove their ceremonial dress before leaving the sanctuary "that they sanctify not the people with their garments" (Ezek. xlv. 19; cf. xlii. 14), and every precaution was taken on religious occasions to ensure purity by special ablutions and by cleansing the clothes.<sup>3</sup> In the old ritual at Mecca, the man who wore his own garments must leave them in the sanctuary, as they had become "taboo"; hence the sacred circumambulation of the Ka'ba was performed naked (prohibited by Mahomet), or in clothes provided for the occasion. The old archaic waist-cloth was used, and at the present day both male and female pilgrims enter bare-footed and clad in the scanty *ihram* (C. M. Doughty, *Arabia Deserta*, ii. 479, 481, 537). In several old Babylonian representations the priests or worshippers appear before the deity in a state of nature.<sup>4</sup> It is known that laymen were required to wear special garments, and the priests (who wore dark-red or purple) were sometimes called upon to change their garments in the course of a ceremony. Thus the temples required clothing not merely for the gods but also for the attendants (so at Samaria, 2 Kings x. 22).

In the late usage at Harran the worshipper, after purifying his garments and his heart, was advised to put on the clothing of the particular god he addressed (de Goeje, *Oriental Congress*, Leiden,

<sup>1</sup> Herod. iii. 8. If the bald Sumerians wore wigs in time of war (Meyer, 81, 86), war itself from beginning to end was essentially a religious rite; see W. R. Smith, *Rel. of Semites*, pp. 401 sqq., 491 sq.; F. Schwally, *Semitische Kriegsaltertümer*, i. On the importance attached to the beard, see *Ency. Bib.*, s.v.

<sup>2</sup> A typical example is afforded by the solitary representation of a Moabite (Perrot and Chipiez, *Phoen.* ii. 45) whose helmet and dress suggest a god or king. Equally perplexing is the Egyptian style on the Phoenician statue, *ib.* 28.

<sup>3</sup> Cf. Lev. xvi. 23 sq.; Ex. xix. 10; Herod. ii. 37 (ed. Wiedemann); Lagrange, *Études sur les relig. sémit.* 239.

<sup>4</sup> M. Jastrow, *Relig. of Bab. and Ass.* p. 666; cf. *Rev. biblique*, 1908, p. 466 sq., and Meyer, 59, 86, 97, 101. According to the latter Sumerian priests served naked (p. 112).

1883, pp. 341 sqq.). The reason is obvious, and the principle could be variously expressed. But we are not told whether the prophetess who wore bands on her arm and drew a mantle over her head (so read in Ezek. xiii. 17-23) actually used the clothing peculiar to some deity, nor is it quite clear what is meant when a Babylonian ritual text refers to the magical use of the linen garment of Eridu (seat of the cult of Ea). The Bishop Gregentius denounced as heathenish the rites in which the Arabs wore masks (W. R. Smith, 438), and one is tempted to compare the use of masks elsewhere in animal worship. Next, one may observe upon old Babylonian seals, eagle-headed deities with short feathered skirts attended by human beings similarly arrayed (Ball, 151) or figures draped in a fish skin (Menant, *Rev. de l'hist. des relig.* xi. 295-301) or a worshipper arrayed somewhat like a cock (Meyer, 63; cf. Lucian's *De Dea Syria*, § 48; for "bees," &c., as titles of sacred attendants, see J. G. Frazer, *Pausanias*, iv. 223, v. 621). Although there is much that is obscure in this line of research, it is a natural assumption that, in those ritual functions where the gods were supposed to participate, the rôle was taken by men, and the general idea of assimilating oneself to the god (and the reverse process) manifests itself in too many ways to be ignored (cf. W. R. Smith, 293, 437 sq., 474; C. J. Ball, *Ency. Bib.*, art. "Cuttings"). But the deities were not originally anthropomorphic, and it is with the earlier stages in their development that some of the more remarkable costumes are apparently concerned.

Of all priestly costumes<sup>5</sup> the most interesting is undoubtedly that of the Jewish Levitical high-priest. In addition to a tunic (*kuttōneth*) and a seamless mantle or robe (*mē'īl*), he wore the breastplate (*hōshēn*), the ephod, and a rich outer girdle. Breeches were assumed on the Day of Atonement. His head-dress was as distinctive as that of the high priest at Hierapolis, who wore a golden tiara and a purple dress, while the ordinary priests had a *pilos* (conical cap, also worn in Israel, Ex. xxviii. 40) and white garments. But the various descriptions cannot be easily reconciled.<sup>6</sup> The robe had pomegranates and golden bells that the sound might give warning as he went in and out of the sanctuary, and "that he died not" (Ex. xxviii. 35). According to Josephus they symbolized the lightning and thunder respectively. The "ephod of prophecy" (so *Test. of Levi*, viii. 2) was essentially once an object of divination (see ΕΡΦΟΔ). The "breastplate of judgment" was set with twelve jewels engraved with the names of the tribes; the foreordained covering of the semi-divine being in the garden of the gods bore the same number of stones (Ezek. xxviii. 13, Septuagint). This breast ornament finds analogies in the royal and high priestly dress of Egypt, and in the six jewels of the Babylonian king.<sup>7</sup> The sacred lots which gave "judgment" in accordance with the divine oracle (Num. xxvii. 21) have been plausibly compared with the Babylonian tablets of destiny worn by the gods and the mystic lots upon the bosom of Noah.<sup>8</sup> The two jewels also engraved with the names of the tribes in a suitable setting, worn upon the *shoulder* (see p. 102, c.), served, like the twelve mentioned, for a memorial before the Deity, effectively bringing them to remembrance, without any action on the part of the bearer, and thus tacitly involving supernatural intervention as amulets are regularly expected to do. The golden plate inscribed "holy to Yahweh" placed over the head (the details are discrepant) had a mystic atoning force (Ex. xxviii. 38), and in general writers recognized the peculiar efficacy of the costume and its symbolical meaning (Philo, *Vita Mosis*, iii. 14; Jos. *Ant.* iii. 7. 7; Talm. *Zeb.* 88b). Although Jewish tradition ascribed this gorgeous and significant array to the Mosaic age (if not to the pre-Mosaic days of Levi, so the *Test. of Levi*), its very character, in common with the high priest's status, combines kingly and priestly powers in a manner which is impossible for the period (about 15th-13th cent.). Where the king is the human representative of the Deity he is theoretically and officially the priesthood, although the priests carry on the ordinary subordinate functions. The Hebrew

<sup>5</sup> For the conspicuous dress of Syrian and Phrygian priests in Rome and for other incidental references, see D. Chwolsohn, *Die Ssabier* (1856), ii. 655, 712 sq.

<sup>6</sup> Ex. xxviii., xxix. 5; Lev. viii. 6-9, xvi.; Ecclus. xlv.; Joseph. *Ant.* iii. 7, Wars, v. 5. 7; see commentaries and special dictionaries of the Bible.

<sup>7</sup> Zimmermann, *Keilinschrift. u. Alte Test.* 629, n. 5; cf. the Bab. priests' pectoral; Lagrange, *op. cit.*, 236, n. 1.

<sup>8</sup> Jubilees, viii. 11, see W. Muss-Arnolt, *Amer. Journ. of Semit. Lang.*, 1900, pp. 207-212.



kings, at all events, undertook priestly duties, and not until after the fall of Jerusalem does the history allow that usurpation of monarchical rights upon which the prophet Ezekiel (*q.v.*) encroaches. The embodiment of political and religious supremacy displayed in the high priest's authority, clothing and symbols can only reflect exilic or rather post-exilic conditions.<sup>1</sup> (See further PRIEST.) In the Maccabaeian age the high priest Jonathan received the purple robe and crown and the buckle of gold worn on the shoulder as a sign of priestly and secular rank (1 Macc. x. 20, 38, 89, xi. 58). His brother Simon received similar honours (xiv. 48 sq.), and Hyrcanus, the "second David," was supposed to have had two crowns, one royal and the other priestly (Talm. *Kidd.* 66a). The later Rabbis wore most sumptuous apparel, and were crowned until the death of Eliezer ben Azarya.

Thus there was a real significance in ceremonial investiture (cf. Num. xx. 26, 28) and in the transference of clothes (cf. Elisha and Elijah's mantle, 2 Kings ii. 13). Further the exchange of garments was not meaningless, and the prohibition in Deut. xxiii. 5 points to religious or superstitious beliefs, on which see J. G. Frazer, *Adonis, Attis and Osiris* (2nd ed.), pp. 428-435. On the claim involved by the act of throwing a garment over another (Ruth iii. 9; cf. 1 Kings xix. 19), see W. R. Smith, *Kinship and Marriage*<sup>2</sup>, 105 sq.; J. Wellhausen, *Archiv f. Religionswiss.* (1907), pp. 40 sqq.; and on some interesting ideas associated with sandals, see *Ency. Bib., s.v.* "Shoes." As a sign of grief, or on any occasion when the individual felt himself brought into closer contact with his deity, the garments were rent (subsequently a conventional slit at the breast sufficed) and he donned the *sak*, a loin-cloth or wrapper which appears to be a survival of older and more primitive dress.<sup>3</sup> Later tradition (Mish., *Kil.* ix. 1) does not endorse Ezekiel's prohibition of woollen garments among the priests in the sanctuary (xliv. 17 sq.). Why the layman was forbidden a mixture of wool and linen (*sha'atnez*, Deut. xxiii. 11) is difficult to explain, though Maimonides perhaps correctly regarded the law as a protest against heathenism (on the magical use of representatives of the animal and vegetable kingdom, in conjunction with a metal ring, see I. Goldziher, *Zeit. f. alltest. Wissens.* xx. 36 sq.).

Ancient oriental costume then cannot be severed from the history and development of thought. On the one side we may see the increase of rich apparel and the profusion of clothes by which people of rank indicated their position. On the other are such figures as the Hebrew prophets, distinguished by their hairy garment and by their denunciation of the luxury of both sexes.<sup>4</sup> Superfluous clothing was both weakening and deteriorating; this formed the point of the advice of Croesus to Cyrus (Herod. i. 155). But "foreign apparel" was only too apt to involve ideas of foreign worship (Zeph. i. 8 sq.), and the recognition that national costume, custom and morality were inseparable underlay the objection to the Greek cap (the *περάσος*) introduced among the Jews under Antiochus Epiphanes (2 Macc. iv. 10-17, with the parallel 1 Macc. i. 11-15). The Israelite distinctive costume and toilet as part of a distinctive national religion was in harmony with oriental thought, and, as a people chosen and possessed by Yahweh, "a kingdom of priests and an holy nation" (Ex. xix. 5 sq.; cf. Is. lxi. 6), certain outward signs assumed a new significance and continued to be cherished by orthodox Jews as tokens of their faith. The tassels attached by blue threads to the four corners of the outer garment were unique only as regards the special meaning attached to them (Num. xv. 37-41; Deut. xxii. 12), and when in the middle ages they marked out the Jew for persecution they were transferred to a small under-garment (the little *tālūth*), the proper *tālūth* being worn over the head in the synagogue. Similarly, sentences bound on the left arm or placed upon the forehead (Deut. xi.

<sup>1</sup> The relations between sacerdotal and civic authority may be seen in the vestments of the church (chasuble, alb, stole), which probably were once the official garments of magistrates.

<sup>2</sup> See articles on mourning customs in the *Bible Dictionaries*, and, for special studies, Büchler, *Zeit. f. alltest. Wissens.*, 1901, pp. 81-92; M. Jastrow, *ib.*, 1907, 117 sqq.; and in *Journ. Amer. Or. Soc.* xx. 133 sqq., xxi. 23-39. For the Babylonian evidence see Zimmern, *op. cit.*, 603. The sculptures of Sennacherib show the bare-headed and bare-footed suppliants of Lachish meanly clad before Sennacherib (Ball, p. 192, contrast the warriors with caps and helmets, *ib.* p. 190, and on the simple dress, cf. above).

<sup>3</sup> Ezek. xvi. xxiii.; Isa. iii. 16-iv. 1. For the hairy garb, cf. John the Baptist (Matt. iii. 4); it became the ascete's dress. The founder of the Jacobite Church in Asia owed his surname (*Burde'ānā*) to his rough horse-cloth. Here may be mentioned the archaic revival in Egypt in the 8th century B.C., which also extended to the costume.

18, cf. the high priest's plate) find analogies in the means taken elsewhere to ensure the protection of or to manifest one's adherence to a deity; the novelty lies in the part these sentences took in the religion (see PHYLACTERY). While the particular prohibition regarding the beard and hair in Lev. xix. 27 (cf. Ezek. xliv. 20) was for the avoidance of heathen customs, the *pēyōth* or long curls which became typical in the middle ages are reminiscent of the Horus-curl of Egypt and the Mahomedan "heaven lock" and evidently served as positive distinctive marks. Apart from these details later Jewish dress does not belong to this section. In the Greek and Roman period foreign influence shows itself very strongly in the introduction of novelties of costume and of classical terms, and the subject belongs rather to the Greek and Roman dress of the age.<sup>4</sup> Two conflicting tendencies were constantly at work, and reached their climax in the middle ages. There was an anxiety to avoid articles of dress peculiar to other religions, especially when these were associated with religious practices; and there was a willingness to refrain from costume contrary to the customs of an unsympathetic land. On the one hand, there was a conservatism which is exemplified when the Jews in course of immigration took with them the characteristic dress of their former adopted home, or when they remained unmoved by the changes of the Renaissance. On the other hand, the prominent badge enforced by Pope Innocent III. in 1215 was intended to prevent Jews from being mistaken for Christians, and similarly in Mahomedan lands they were compelled to wear some distinctive indication of their sect. Thus the many quaint and interesting features of later Jewish costume have arisen from certain specific causes, any consideration of which concerns later and medieval costume generally. See I. Abrahams, *Jewish Life in the Middle Ages* (1896), chap. xv. sq.; and especially the *Jew. Encyc., s.v.* "Dress" (with numerous illustrations).

**AUTHORITIES.**—Much useful material will be found in popular illustrated books (especially C. J. Ball, *Light from the East*, London, 1899) and in the magnificent volumes on the history of ancient art by G. Perrot and C. Chipiez. On Egyptian costume see especially J. G. Wilkinson, *Manners and Customs of the Ancient Egyptians* (ed. by S. Birch, 1878), and A. Erman *Life in Ancient Egypt* (1894, especially pp. 200-233); for Egyptian evidence, see W. M. Müller, *Asien und Europa nach Aegypten. Denkmäler* (Leipzig, 1893), *Mitteil. d. vorderasiat. Gesellschaft* (1904), ii. (and elsewhere). The most important study on old Babylonian dress is that of E. Meyer, "Sumerier und Semiten in Babylonien," in the *Abhandlungen* of the Berlin University (1906). For Hittite material, see the collection by L. Messerschmidt, *Mitteil. d. vorderas. Ges.* (1900 and 1902). For special discussions, see H. Weiss, *Kostümkunde*, i. (Stuttgart, 1881), articles in *Dict. Bible* (Hastings), *Ency. Biblica*, and *Jewish Encyc.*, and I. Benzinger, *Hebr. Archäologie* (Tübingen, 1907), pp. 73 sqq. See also the general bibliography at the end. (S. A. C.)

ii. *Aegean Costume.*—The discoveries made at Mycenae and other centres of "Mycenaean" civilization, and those of more recent date due to the excavations of Dr A. J. Evans and others in Crete, have shown that Hellenic culture was preceded in the Aegean by a civilization differing from it in many respects (see AEGEAN CIVILIZATION), and not least in costume. The essential feature both of male and female dress during the "Minoan" and "Mycenaean" periods was the loin-cloth, which is best represented by the votive terra-cotta statuettes from Petsofá in Crete discovered by Professor J. L. Myres and published in the ninth volume of the *Annual of the British School at Athens* (fig. 15). J. L. Myres shows that the costume consists of three parts—the loin-cloth itself, a white wrapper or kilt worn over it, and a knotted girdle which secured the whole and perhaps played its part in producing and maintaining the wasp waists characteristic of the Aegean race. The loin-cloth was the only costume (except for high boots, probably made of pale leather, since they are represented



From Petsofá (*Annual of the Brit. School at Athens*).

FIG. 15.—Terra-cotta Statuette.

<sup>4</sup> See for details, A. Brüll, *Trachten d. Juden* (1873).

with white paint) regularly worn by the male sex, though we sometimes find a hood or wrapper, as on a lead statuette found in Laconia (fig. 16), but the Aegean women developed it into a bodice-and-skirt costume, well represented by the

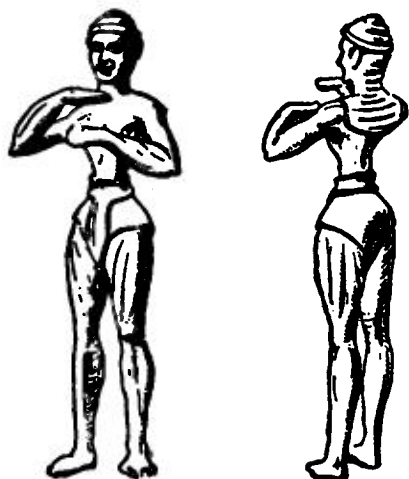

Perrot et Chipiez's *Art in Primitive Greece*, by permission of Chapman & Hall.  
FIG. 16.—Lead Statuette from Kampos.

frescoes of Cnossus and the statuettes of the snake-goddess and her votaries there discovered. This transformation of the loin-cloth has been illustrated by Mr D. Mackenzie (see below) from Cretan seal-impressions. In place of the belted kilt of the men we find a belted panier or polonaise, considerably elongated in front, worn by Aegean women; and Mackenzie shows that this was repeated several times until it formed the compound skirt with a number of flounces which is represented on many Mycenaean gems. On a fresco discovered at Phaestus (Hagia Triada) (fig. 17) and a sealing from the same place this multiple skirt is clearly shown as divided; but this does not seem to have been the general rule. On other sealings we find a single overskirt with a pleated underskirt. The skirts were held in place by a thick rolled belt, and the upper part of the body remained quite nude in the earliest times; but from the middle Minoan period onward we often find an important addition in the shape of a low-cut bodice, which sometimes has sleeves, either tight-fitting or puffed, and ultimately develops into a laced corsage. A figurine from Petsofá (fig. 18) shows the bodice-and-skirt costume, together with a high pointed head-dress, in one of its most



From *Monumenti antichi* (Acad. Lincei).  
FIG. 17.—Part of a Fresco discovered at Phaestus.



From *Annual of the Brit. School at Athens*.  
FIG. 18.—Terra-cotta Statuette from Petsofá.

elaborate forms. The bodice has a high peaked collar at the back. Other forms of head-dress are seen on the great signet from Mycenae. The fact that both male and female costume amongst the primitive Aegean peoples is derivable from the simple loin-cloth with additions is rightly used by Mackenzie as a proof that their original home is not to be sought in the colder regions of central Europe, but in a warm climate such as that of North Africa. It is not until the latest Mycenaean period that we find brooches, such as were used in historical Greece, to fasten woollen garments, and their presence in the tombs of the lower city of Mycenae indicates the coming of a northern race.

See *Annual of the British School at Athens*, ix. 356 sqq. (Myres); xii. 233 sqq. (Mackenzie); Tsountas and Manatt, *The Mycenaean Age*, ch. vii.

iii. *Greek Costume*.—All articles of Greek costume belong either to the class of *ἐνδύματα*, more or less close-fitting, sewn garments, or of *περιβλήματα*, loose pieces of stuff draped round the body in various ways and fastened with pins or brooches. For the former class the generic name is *χιτών*, a word of Semitic origin, which denotes the Eastern origin of the garment; for the latter we find in Homer and early poetry *πέπλος*, in later times *ἱμάτιον*. The *πέπλος* (also called *ἐάνος* and *φᾶρος* in Homer) was the sole indispensable article of dress in early Greece, and, as it was always retained as such by the women in Dorian states, is often called the "Doric dress" (*ἑσθῆς Δωρῆς*). It was a square piece of woollen stuff about a foot longer than the height of the wearer, and equal in breadth to twice the span of the arms measured from wrist to wrist. The upper edge was folded over for a distance equal to the space from neck to waist—this folded portion was called *ἀπόπτυγμα* or *διπλοῖς*,—and the whole garment was then doubled and wrapped round the body below the armpits, the left side being closed and the right open. The back and front were then pulled up over the shoulders and fastened together with brooches like safety-pins (*περόναι*). This was the Doric costume, which left the right side of the body exposed and provoked the censure of Euripides (*Andr.* 598). It was usual, however, to hold the front and back of the *πέπλος* together by a girdle (*ζώνη*), passed round the waist below the *ἀπόπτυγμα*; the superfluous length of the garment was pulled up through the girdle and allowed to fall over in a baggy fold (*κόλπος*) (see GREEK ART, fig. 75). Sometimes the *ἀπόπτυγμα* was made long enough to fall below the waist, and the girdle passed outside it (cf. the figure of Artemis on the vase shown in GREEK ART, fig. 29); this was the fashion in which the Athena Parthenos of Pheidias was draped. The "Attic" or "Corinthian" *πέπλος* was sewn together on the right side from below the arm, and thus became an *ἐνδυμα*. The *πέπλος* was worn in a variety of colours and often decorated with bands of ornament, both horizontal and vertical; Homer uses the epithets *κροκόπεπλος* and *κνανόπεπλος*, which show that yellow and dark blue *πέπλοι* were worn, and speaks of embroidered *πέπλοι* (*ποικίλοι*). Such embroideries are indicated by painting on the statues from the Acropolis and are often shown on vase paintings.

The chiton, *χιτών*, was formed by sewing together at the sides two pieces of linen, or a double piece folded together, leaving spaces at the top for the arms and neck, and fastening the top edges together over the shoulders and upper arm with buttons or brooches; more rarely we find a plain sleeveless chiton. The length of the garment varied considerably. The *χιτωνίσκος*, worn in active exercise, as by the so-called "Atalanta" of the Vatican, or the well-known Amazon statues (GREEK ART, fig. 40), reached only to the knee; the *χιτών ποδήρης* covered the feet. This long, trailing garment was especially characteristic of Ionia; in the Homeric poems (*Il.* xiii. 685) we read of the *Ἰάβρες ἑλκεχιτώνες*. If worn without a girdle it went by the name of *χιτών ὀρθοστάδιος*. The long chiton was regularly used by musicians (e.g. Apollo the lyre-player) and charioteers. In ordinary life it was generally pulled up through the girdle and formed a *κόλπος* (GREEK ART, fig. 2).

Herodotus (v. 82-88) tells a story (cf. AEGINA), the details of which are to all appearance legendary, in order to account for a change in the fashion of female dress which took place at Athens in the course of the 6th century B.C. Up to that time the "Dorian dress" had been universal, but the Athenians now gave up the use of garments fastened with pins or brooches, and adopted the linen chiton of the Ionians. The statement of Herodotus is illustrated both by Attic vase-paintings and also by the series of archaic female statues from the Acropolis of Athens, which (with the exception of one clothed in the Doric *πέπλος*) wear the Ionic chiton, together with an outer garment, sometimes laid over both shoulders like a cloak (GREEK ART, fig. 3), but more usually fastened on the right shoulder only, and passed diagonally across the body so as to leave the left arm

free. The garment (which resembles the Doric πέπλος, but seems to have been rectangular rather than square) is folded over at the top, and the central part is drawn up towards the right shoulder to produce an elaborate system of zigzag folds (GREEK ART, fig. 22). The borders of the garment are painted with geometrical patterns in vivid colours; a broad stripe of ornament runs down the centre of the skirt.<sup>1</sup>

This fashion of dress was only temporary. Thucydides (i. 6) tells us that in his own time the linen chiton of Ionia had again been discarded in favour of the Doric dress, and the monuments show that after the Persian wars a reaction against Orientalism showed itself in a return to simpler fashions. The long linen chiton, which had been worn by men as well as women, was now only retained by the male sex on religious and festival occasions; a short chiton was, however, worn at work or in active exercise (GREEK ART, fig. 3) and often fastened on the left shoulder only, when it was called χιτών ἐτερομάσχαλος or ἐξωμίς. But the garment usually worn by men of mature age was the ἱμάτιον, which was (like the πέπλος) a plain square of woollen stuff. One corner of this was pulled over the left shoulder from the back and tucked in under the left arm; the rest of the garment was brought round the right side of the body and either carried under the right shoulder, across the chest and over the left shoulder, if it was desired that the right arm should be free, or wrapped round the right arm as well as the body, leaving the right hand in a fold like a sling (GREEK ART, fig. 2). The ἱμάτιον was also worn by women over the linen chiton, and draped in a great variety of ways, which may be illustrated by the terracotta figurines from Tanagra (4th-3rd cent. B.C.) and the numerous types of female statues, largely represented by copies of Roman date, made to serve as grave-monuments. The upper part of the ἱμάτιον was often drawn over the head as in the example here shown (Plate, fig. 21), a statue formerly in the duke of Sutherland's collection at Trentham and now in the British Museum.

A lighter garment was the χλαμῖς, *chlamys*, a mantle worn by young men, usually over a short chiton girt at the waist, and fastened on the right shoulder (cf. the figure of Hermes in GREEK ART, fig. 2). The χλαίνα was a heavy woollen cloak worn in cold weather. Peasants wore sheepskins or garments of hide called βαίτη or σίσυρα; slaves, who were required by custom to conceal their limbs as much as possible, wore a sleeved chiton and long hose.

A woman's head was usually covered by drawing up the ἱμάτιον (see above), but sometimes instead of this, a separate piece of cloth was made to perform this service, the end of it falling over the *himation*. This was the καλύπτρα, or veil called κρήδεμνον in Homer. A cap merely intended to cover in the hair and hold it together was called κεκρύφαλος. When the object was only to hold up the hair from the neck, the σφενδόνη was used, which, as its name implies, was in the form of a sling; but in this case it was called more particularly ὀπισθοσφενδόνη, as a distinction from the σφενδονῆ when worn in front of the head. The head ornaments include the διάδημα, a narrow band bound round the hair a little way back from the brow and temples, and fastened in the knot of the hair behind; the ἀμπύξ, a variety of the diadem; the στεφάνη, a crown worn over the forehead, its highest point being in the centre, and narrowing at each side into a thin band which is tied at the back of the head. It is doubtful whether this should be distinguished from the στέφανος, a crown of the same breadth and design all round, as on the coins of Argos with the head of Hera, who is expressly said by Pausanias to wear a *stephanos*. This word is also employed for crowns of laurel, olive or other plant. High crowns made of wicker-work (πόλοι, κάλαθοι) were also worn (see Gerhard, *Antike Bildwerke*, pls. 303-305). When the hair, as was most usual, was gathered back from the temples and fastened in a knot behind, hair-pins were required, and these were mostly of bone or ivory, mounted with gold or plain; so also when the hair was

tied in a large knot above the forehead, as in the case of Artemis, or of Apollo as leader of the Muses. The early Athenians wore their hair in the fashion termed κρώβυλος, with fastenings called "grasshoppers" (τέττιγες), in allusion to their claim of having originally sprung from the soil (Thuc. i. 6). The τέττιγες have been identified by Helbig with small spirals of gold wire, such as are found in early Etruscan tombs lying near the head of the skeleton. Such spirals were used in early Athens to confine the back hair, and this fashion may therefore be identified as the κρώβυλος. In archaic figures the hair is most frequently arranged over the brow and temples in parallel rows of small curls which must have been kept in their places by artificial means. Ear-rings (ἐνώτια, ἑλλόβια, ἐλικτήρες) of gold, silver, or bronze plated with gold, and frequently ornamented with pearls, precious stones, or enamel, were worn attached to the lobes of the ear. For necklaces (ὄρμοι), bracelets (ὄφεις), brooches (περόναι), and finger-rings (δακτύλιοι or σφραγίδες) the same variety and preciousness of material was employed. For the feet the sandal (σάνδαλον, πέδιλον) was the usual wear; for hunting and travelling high boots were worn. The hunting-boot (ἐνδρομίς) was laced up the front, and reached to the calves; the κόθορνος (cothurnus) was a high boot reaching to the middle of the leg, and as worn by tragic actors had high soles. Slippers (περσικαί) were adopted from the East by women; shoes (ἐμβάδες) were worn by the poorer classes. Gloves (χειροῖδες) were worn by the Persians, but apparently never by the Greeks unless to protect the hands when working (*Odyssey*, xxiv. 230). Hats, which were as a rule worn only by youths, workmen and slaves, were of circular shape, and either of some stiff material, as the Boeotian hat observed in terra-cottas from Tanagra, or of pliant material which could be bent down at the sides like the πέτασος worn by Hermes and sometimes even by women. The καυσία, or Macedonian hat, seems to have been similar to this. The κυρβασία, or κίδαρις, was a high-pointed hat of Persian origin, as was also the τιάρα, which served the double purpose of an ornament and a covering for the head. Workmen wore a close-fitting felt cap (πίλος).

See F. Studniczka, "Beiträge zur Geschichte der altgriechischen Tracht" (*Abhandlungen des arch.-epigr. Seminars in Wien*, vii. 1886); Lady Evans, *Chapters on Greek Dress* (1893); W. Kalkmann, "Zur Tracht archaischer Gewandfiguren" (*Jahrb. des k. deutschen arch. Instituts*, 1896, pp. 19 ff.); S. Cybulska, *Tabulae quibus antiquitates Graecae et Romanae illustrantur*, Nos. 16-18 (1903), with text by W. Amelung; Ethel B. Abrahams, *Greek Dress* (1908).

iv. *Etruscan Costume*.—The female dress of the Etruscans did not differ in any important respect from that of the Greeks; it consisted of the *chiton* and *himation*, which was in earlier times usually worn as a shawl, not after the fashion of the Doric πέπλος. Two articles of costume, however, were peculiar to the Etruscans

—the high conical hat known as the *tutulus*,<sup>2</sup> and the shoes with turned-up points (Latin *calcei repandi*). These have oriental analogies, and lend support to the tradition that the Etruscans came from Asia. Both are represented on a small bronze figure in the British Museum (fig. 19). On a celebrated terracotta sarcophagus in the British Museum of much later date (fig. 20), the female figure reclining on the lid wears a Greek chiton of a thin white material, with short sleeves fastened on the outside of the arm, by means of buttons and loops; a *himation* of dark purple thick stuff is wrapped round her hips and legs; on her feet are sandals, consisting of a sole apparently of leather, and attached to the foot and leg with leather straps; under the straps are thin socks which do not cover the toes; she wears a necklace of heavy pendants; her ears are pierced for ear-rings; her hair is partly gathered together with a ribbon at the roots behind, and partly hangs in long tresses before and behind; a flat diadem is bound round her head a little way back from the brow and

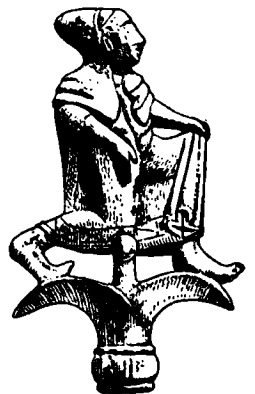

FIG. 19.

<sup>2</sup> The *tutulus* was worn at Rome by the *flaminica*.

<sup>1</sup> These ornamental bands are carefully described and reproduced in colour by A. Lermann, *Altgriechische Plastik* (1907), pp. 85 ff., pls. i.-xx. Some authorities hold that the skirt forms part of the over-garment, but it seems clear that it belongs to the χιτών.

temples. Purple, pale green and white, richly embroidered, are favourite colours in the dresses represented on the painted tombs.

The chief article of male dress was called the *tebenna*. We are told by ancient writers that the *toga praetexta*, with its purple border (*περιπόρφυρος τήβεννα*), as worn by Roman magistrates and priests, had been derived from the Etruscans (Pliny, *N.H.* ix. 63, "praetextae apud Etruscos originem invenerunt"); and the famous statue of the orator in Florence (Plate, fig. 22), an Etruscan work of the 3rd century B.C., represents a man clothed in this garment, which will be described below. Under the *tebenna*, or *toga*, which was necessary only for public appearance, the Etruscans wore a short tunic similar to the Greek chiton. For workmen and others of inferior occupation this appears to have been the only dress. Youths, when engaged in horsemanship and other exercises, wore a *chlamys* round the shoulders, which, however, was semicircular in cut, and was fastened on the breast by buttons and a loop, or tied in a knot, whereas the Greek *chlamys* was oblong and fastened on the shoulder by a brooch. On public or festal occasions the Etruscan noble wore, besides the *tebenna*, a *bullae*, or necklace of *bullae*, and a wreath, *corona Etrusca*. The *bullae* was a circular gold locket containing a charm of some kind against evil.<sup>1</sup> On the later sarcophagi the



Redrawn from photo (Mansell).

FIG. 20.

male figures wear not only a wreath or *corona* proper, but also a garland of flowers hung round the neck. The male head-dress was the *galerus*, a hat of leather, said to have been worn by the Lucumones in early times, or the *apex*, a pointed hat corresponding to the *tutulus* worn by females. The fashion of shoes worn by Roman senators was said to have been derived from Etruria. Etruscan shoes were prized both in Greece and in Rome.

Helbig's articles, referred to at the close of the next section, should be consulted. J. Martha, *L'Art étrusque*, gives reproductions of the most important monuments. See also the works on Etruscan civilization named in the art. ETRURIA.

v. *Roman Costume*.—We are told that the *toga*, the national garment of the Romans, was originally worn both by men and by women; and though the female dress of the Romans was in historical times essentially the same as that of the Greeks, young girls still wore the *toga* on festal occasions, as we see from the reliefs of the Ara Pacis Augustae. In early times no undergarment was worn save a loin-cloth (*subligaculum*), which seems to be a survival of early Mediterranean fashions (see above, sect. *Aegean Costume*), and candidates for office in historical times appeared in the *toga* and *subligaculum* only. In this period, however, the *tunica*, corresponding to the Greek chiton, was universally worn in ordinary life, and the *toga* gradually became a full-dress garment which was only worn over the *tunica* on important social occasions; Juvenal (iii. 171) tells us that in a great part of Italy no one wore the *toga* except at his burial!

The *toga* was a piece of woollen cloth in the form of a segment of a circle,<sup>2</sup> the chord of the arc being about three times the height of the wearer, and the height a little less than one-half of this length. One end of this garment was thrown over the left shoulder and allowed to hang down in front; the remainder

<sup>1</sup> It was also worn by Roman children.

<sup>2</sup> This seems more likely than the alternative view that it was of elliptical shape and was folded before being put on. Quintilian (xi. 3. 139, a *locus classicus* for the *toga*) speaks of it as "rotunda"; but this need not be taken literally.

was drawn round the body and disposed in various ways. In the *cinctus Gabinus*, which was the fashion adopted in early times when fighting was in prospect, the end of the *toga* was drawn tightly round the waist and formed a kind of girdle; this was retained in certain official functions, such as the opening of the temple of Janus in historical times.<sup>3</sup> In time of peace the *toga* was wrapped round the right arm, leaving the hand only free, much after the fashion of the Greek *himation*, and thrown over the left shoulder so as to fall down behind (see ROMAN ART, Plate II., fig. 11, male figure to r.); or, if greater freedom were desired, it was passed under the right arm-pit. In religious ceremonies, the magistrate presiding at the sacrifice drew the back of the *toga* over his head; see in the same illustration the priest with veiled head, *ritu Gabino*, who also wears his *toga* with the *cinctus Gabinus*. Towards the end of the republic a new fashion was generally adopted. A considerable length of the *toga* was allowed to hang from the left shoulder; the remainder was passed round the body so as to rise like a baldric (*balleus*) from the right hip to the left shoulder, being folded over in front (the fold was called *sinus*), then brought round the back of the neck so that the end fell over the right shoulder; the hanging portion on the left side was drawn up through the *sinus*, and bulged out in an *umbo* (Plate, fig. 24). Later still, this portion, instead of forming a bundle of folds in the centre, was carefully folded over and carried up over the left shoulder, and in course of time these folds were carefully arranged in several thicknesses resembling boards, *tabulae*, hence called *contabulatio* (Plate, fig. 23). Yet another fashion was that adopted by the flamens, who passed the right-hand portion of the *toga* over the right shoulder and arm and back over the left shoulder, so that it hung down in a curve over the front of the body; the upper edge was folded over. The flamens are thus represented on the Ara Pacis Augustae.

The plain white *toga* (*toga pura*) was the ordinary dress of the citizen, but the *toga praetexta*, which had a border of purple, was worn by boys till the age of sixteen, when they assumed the plain *toga virilis*, and also by curule magistrates and some priests. A purple *toga* with embroidery (*toga picta*) was worn together with a gold-embroidered tunic (*tunica palmata*) by generals while celebrating a triumph and by magistrates presiding at games; it represented the traditional dress of the kings and was adopted by Julius Caesar as a permanent costume. The emperors wore it on occasions of special importance. The *trabea*, which in historical times was worn by the consuls when opening the temple of Janus, by the *equites* at their yearly inspection and on some other occasions, and by the *Salii* at their ritual dances, and had (according to tradition) formed the original costume of the augurs and flamens (who afterwards adopted the *toga praetexta*), was apparently a *toga* smaller in size than the ordinary civil dress, decorated with scarlet stripes (*trabes*). It was fastened with brooches (*fibulae*) and appears to have been worn by the *equites*, e.g. at the funeral ceremony of Antoninus Pius.

The *tunica* was precisely like the Greek chiton; that of the senator had two broad stripes of purple (*latus clavus*) down the centre, that of the knight two narrow stripes (*angustus clavus*). A woollen undergarment (*subucula*) was often worn by men; the women's under-tunic was of linen (*indusium*). When women gave up the use of the *toga*, they adopted the *stola*, a long tunic with a border of a darker colour (*instila*) along the lower edge; the neck also sometimes had a border (*patagium*). The tunic with long sleeves (*tunica manicata*) was a later fashion. Over this the *ricinium* or *rica*, a shawl covering the head and shoulders, was worn in early times, and retained by certain priestesses as an official costume;<sup>4</sup> but it gave place to the *palla*, the equivalent of the Greek *himation*, and the dress of the Roman women henceforward differed in no essential particular from that of the Greek.

<sup>3</sup> The Lares are thus represented in art.

<sup>4</sup> The *suffibulum* of the vestals, which was fastened on the breast by a brooch (*fibula*), was a garment of this sort. The marriage-veil (*flammeum*) derived its name from its bright orange colour. The *palliolum* was a kind of mantilla.

A variety of cloaks were worn by men during inclement weather; in general they resembled the Greek chlamys, but often had a hood (*cucullus*) which could be drawn over the head. Such were the *birrus* (so-called from its red colour), *abolla* and *lacerna*. The *paenula*, which was the garment most commonly worn, especially by soldiers when engaged on peace duties, was an oblong piece of cloth with a hole in the centre for the neck; a hood was usually attached to the back. It survives in the ritual chasuble of the Western Church. The Greek military chlamys appears in two forms—the *paludamentum* of the general (e.g. Trajan as represented on the Arch of Constantine, ROMAN ART, Plate III., fig. 16), and the *sagum* worn by the common soldier (e.g. by some of the horsemen on the base of the Antonine column, ROMAN ART, Plate V., fig. 21). When the *toga* went out of use as an article of everyday wear, the *pallium*, i.e. the Greek *himation*, was at first worn only by Romans addicted to Greek fashions, but from the time of Tiberius, who wore it in daily life, its use became general. Long robes bearing Greek names (*synthesis*, *syрма*, &c.) were worn at dinner-parties.

The Romans often wore sandals (*soleae*) or light shoes (*socci*), but in full dress (i.e. with the *toga*) it was necessary to wear the *calceus*, which had various forms by which classes were distinguished, e.g. the *calceus patricius*, *mulleus* (of red leather) and *senatorius* (of black leather). This was a shoe with slits at the sides and straps knotted in front; its forms may be seen on the relief from the Ara Pacis. The senators' *calceus* had four such straps (*quattuor corrigiae*), which were wound round the ankle (cf. the *stamen* on the Ara Pacis), and was also adorned with an ivory crescent (*lunula*). A leathern tongue (*lingula*) is often seen to project from beneath the straps. The soldier's boot (*caliga*, from which the emperor Gaius derived his nickname, Caligula) was in reality a heavy hobnailed sandal with a number of straps wound round the ankle and lower leg. A high hunting boot was called *compagus*. Women at times wore the *calceus*, but are generally represented in art with soft shoes or sandals.

Hats were seldom worn except by those who affected Greek fashions, but the close-fitting leather *pileus* seems to have been an article of early wear in Italy, since its use survived in the ceremony of manumission, and the head-dress of the pontifices and flamines (cf. the relief of the Ara Pacis already referred to) consisted in such a cap (*galerus*) with an *apex*, or spike, of olive wood inserted in the crown.

For personal ornament finger-rings of great variety in the material and design were worn by men, sometimes to the extent of one or more on each finger, many persons possessing small cabinets of them. But at first the Roman citizen wore only an iron signet ring, and this continued to be used at marriages. The *jus annuli aurei*, or right of wearing a gold ring, originally a military distinction, became a senatorial privilege, which was afterwards extended to the knights and gradually to other classes. Women's ornaments consisted of brooches (*fibulae*), bracelets (*armillae*), armlets (*armillae*, *bracchialia*), ear-rings (*inaures*), necklaces (*monilia*), wreaths (*coronae*) and hair-pins (*crinales*). The torc (*torques*), or cord of gold worn round the neck, was introduced from Gaul. A profusion of precious stones, and absence of skill or refinement in workmanship, distinguish Roman from Greek or Etruscan jewelry; but in the character of the designs there is no real difference.

See Marquardt-Mau, *Privatleben der Römer*, pp. 550 seq. (gives a full collection of literary references); Cyburski, *op. cit.*, pls. xix., xx., with Amelung's text; articles by W. Helbig, especially *Sitzungsberichte der bayrischen Akademie* (1880), pp. 487 seq. (on headgear); *Hermes* xxxix. 161 seq. (on *toga* and *trabea*), and *Mémoires de l'Académie des inscriptions*, xxxvii. (1905) (on the costume of the Salii); articles by L. Heuzey in Daremberg and Saglio's *Dictionnaire des antiquités*, also in *Revue de l'art*, i. 98 seq., 204 seq., ii. 193 seq., 295 seq. (on the *toga*). See also the general bibliography at the end. (H. S. J.)

## II. COSTUME IN MEDIEVAL AND MODERN EUROPE

i. *Pre-Roman and Roman Britain*.—Men who had found better clothing than the skins of beasts were in Britain when Caesar landed. Little as we know of England before the English, we have at least the knowledge that Britons, other than the poorer and wilder sort of the north and the fens, wore cloaks and

hats, sleeved coats whose skirts were cut above the knee and loose trousers after the fashion of the Gauls. They were not an armoured race, for they would commonly fight naked to the waist, dreadful with tattooing and woad staining, but Pliny describes their close-woven felts as all but sword-proof. Dyers as well as weavers, their cloaks, squares of cloth like a Highland plaid, were of black or blue, rough on the one side, while coats and trousers were bright coloured, striped and checkered, red being the favourite hue. For ornament the British chiefs wore golden torques about their necks and golden arm-rings with brooches and pins of metal or ivory, beads of brass, of jet and amber from their own coasts, and of glass bought of the Southern merchants. Their women had gowns to the ankle, with shorter tunics above them. The Druid bards had their vestments of blue, while the star-gazers and leeches went in green.

Agricola's Romanizing work must have made great changes in dress as in policy. The British chief with the Latin tongue in his mouth, living in a Roman villa and taking his bath as did the Romans, wore the white woollen *toga* and the linen tunic, his wife having the *stole*, the *pall* and the veil.

ii. *Old English Dress*.—The skill of their artists gives us many accurate pictures of the dress of the English before the Norman Conquest, the simple dress of a nation whose men fight, hunt and plough. The man's chief garment is a sleeved tunic hanging to the knee, generally open at the side from hip to hem and in front from the throat to the breast. Sleeves cut loosely above the elbow are close at the



FIG. 25.—Old English Dress. From the Benedictional of St Æthelwold (c. 963-984).



FIG. 26.—The Blessed Virgin. From the Benedictional of St Æthelwold (c. 963-984).

forearm. The legs are in hose like a Highlander's or in long breeches bandaged or cross-gartered below the knee. A short mantle to the calf is brooched at the shoulder or breast (fig. 25). There are long gowns and toga-like cloaks, but these as a rule seem garments for the old man of rank. In the open air the cloak is often pulled over the head, for hats and caps are rare, the Phrygian bonnet being the commonest form. Girdles of folded cloth gather the loose tunic at the waist. Most paintings show the ankle shoe as black, cut with a pointed tab before and behind, the soles being sometimes of wood like the sole of the Lancashire clog of our own days. A nobleman will have his shoes embroidered with silks or coloured yarns, and the like decoration for the hem and collar of his tunic. Poor men wear little but the tunic, often going barelegged, although the hinds in the well-known pictures of the twelve months have shoes, and the shepherd as he watches his flock covers himself with a cloak. In every graveyard of the old English we find the brooches, armlets, rings and pins of a people loving jewelry. Women wore a long gown covering the feet, the loose sleeves sometimes hanging over the hands to the knee. Over this there is often a shorter tunic with short sleeves. Their mantles were short or long, the hood or





*Photo, Walker.*

FIG. 21.—GRAVE-STATUE.



*Photo, Alinari.*

FIG. 22.—THE ORATOR (R. ARCH. MUS., FLORENCE).

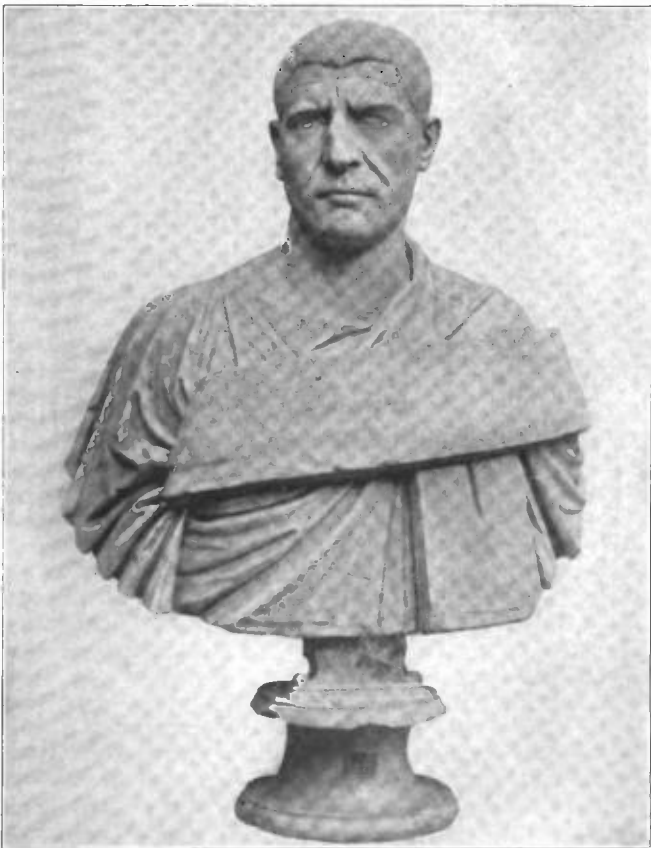

*Photo, Anderson.*

FIG. 23.—BUST OF PHILIP THE ARABIAN (VATICAN).

VII. 236.



*Photo, Mosconi.*

FIG. 24.—TITUS (VATICAN).



head rail wrapped round the chin (fig. 26). In broidery and ornament the women's dress matched that of the men. The Danes, warriors of the sea, soon took the English habit, becoming notable for their many changes of gay clothing.

The Norman Conquest is marked by no great change in English clothing, the conquerors inclining towards the island fashions, as we may see by the fact that they gave up their curious habit of shaving the back of the head. But with the reign of the second William came the taste for the luxury of clothing and that taste for flowing hair and shoes with sharp points which is lamented by William of Malmesbury. In this reign we have the story of the Red King refusing to put on boots that cost but three shillings—the price of an ox—and wearing the same gladly when his chamberlain told him that they were a new pair worth a mark. Even more than the fashion of long cloaks and trailing gowns whose sleeves hang far below the hands, the fantastic boot and shoe toes bring the curses of the clergy and the moralizings of chroniclers. Fulk Rechin of Anjou is said by Orderic to have invented such gear to hide the monstrous bunions upon his toes, but a worthless Robert, a hanger-on of the court of William II., distinguishes himself and gains the surname of Cornard by stuffing his shoe tips with tow and twisting them like the horns of the ram.

There are many illuminations which give us in plenty the details of all costumes of the 12th century. Thus the devil in a well-known MS. wears the gown of a lady of rank, the bodice tightly laced, the hanging sleeve knotted to keep it out of the mud. A MS. at Corpus Christi College, Oxford, shows in a picture of the vision of Henry I. that the men who reap and dig are simply clad in loose skirted tunics with close sleeves, that they have hats with brims, and cloaks caught by a brooch at the shoulder. Hats and caps are common in all classes and take many shapes—the Phrygian cap, the flat bonnet, the brimmed hat and the skull-cap.

With the coming of the house of Anjou English dress clears itself of the more fantastic features of an earlier generation. Henry II. brought in the short Angevin mantle and from it had his name of Curtmantle, but it was not a mastering fashion and the long cloak holds its own. Rich stuffs, cloth of gold or silk woven with gold, webs of damask wrought with stripes or rays and figured with patterns are brought in from the ports. Rare furs are eagerly sought. But the simplicity of line is remarkable. The drawings made for Matthew Paris's lives of the two Offas show people of all ranks clad without a trace of the tailor's fantasy. Kings and lords, churchmen and men of substance go in long gowns to the feet, the great folk having an orphrey or band of embroidery at the somewhat low-cut neck (fig. 27). Some of the sleeves have wide ends cut off at the mid-forearm, showing the tight sleeve of a shirt or smock below. Fashion, however, tends to lengthen sleeves to a tight wrist, the upper halves being cut wide and loose with the large armholes characteristic of most ancient tailoring. Over this gown is worn an ample cloak fastened at the neck with a brooch or clasp, and sometimes fitted with a hood. The dress of the common folk and of men of rank when actively employed is a tunic which is but the gown shortened to the knee, a short cloak to the knee being worn with it (fig. 28). Belts and girdles are narrow and plain, the thongs without enrichment, showing no beginnings of the rich buckles and heavy bosses of a later fashion. Shoes and low-cut boots are slightly pointed, and hats, caps, hoods and coifs of many types cover the head. The women are like to the men in their long gown, but the head is wrapped in a coverchef hanging over the shoulder and bound with a fillet round the brow.

12th and 13th centuries.



FIG. 27.—A Lady and a King (temp. Hen. III.). (From Cotton MS. Nero, D. i.)

actively employed is a tunic which is but the gown shortened to the knee, a short cloak to the knee being worn with it (fig. 28). Belts and girdles are narrow and plain, the thongs without enrichment, showing no beginnings of the rich buckles and heavy bosses of a later fashion. Shoes and low-cut boots are slightly pointed, and hats, caps, hoods and coifs of many types cover the head. The women are like to the men in their long gown, but the head is wrapped in a coverchef hanging over the shoulder and bound with a fillet round the brow.

Gloves are common in this age; "scraps of the cloth or the skin," says a poet, "do not want for a use: of them gloves are made."



FIG. 28.—Labourers (temp. Hen. III.). (From Cotton MS. Nero, D. i.)

At the court of Edward II., son of a king who went simply clad, Piers Gaveston and his like began to set the fashions for a century which to the curious antiquary is a garden of delights. For the history of the 14th-century clothing illuminations are supplemented by a number of effigies upon which the carver has wrought out the last details, by monumental brasses, and by contemporary literature and records (fig. 29). Garments take many shapes; sleeves, skirts and head-dresses run through many fashions; while personal ornaments are rich and beautiful to a degree never yet surpassed. With the beginning of the century there is seen a tendency to shorten the long gown, which had been the best wear of a man of good estate, to a more convenient length, although the knees are still well covered. Loose sleeves falling below the elbow leave to view the sleeve of an under-garment, buttoned tightly to the arm. In winter time a man's gown will have long sleeves that cover the hands when the arms are at length. The full cloak, although still found, is somewhat rare among a people that has, perhaps, learned to wear more clothes and warmer upon the body.

14th century.



FIG. 29.—A Group of Clerks (early to wear more clothes and 14th century). (From Royal MS. 19 B. xv.)

Hoods are worn in many fashions, to be cast back upon the shoulders like a monk's cowl, the part at the back of the head being drawn out into a "liripipe" long enough at times, when



FIG. 30.—English Ploughmen of the 14th century.

the hood is drawn up, to be knotted round the brow turban-fashion (fig. 30). Long hose are drawn up the legs to join the

short breech, and the toes of the ankle-shoes are pointed so long that holy men see visions of little devils using them as chariots. The women love trailing gowns. They have under-skirts and loose over-garments, sometimes sleeveless. Their hair at least would not shock those earlier prelates who cursed the long plaits, for it is caught up in a caul or braided at the sides of the head. In the second half of the century men of rank borrow from Germany the fashion of the *cote-hardie*. In its plainest form this short tunic, covering the fork of the leg, is cut closely to the body and arms (fig. 31). Sometimes the sleeve ends at the elbow and then another streamer is added to the one which falls from the hood, a strip of stuff continuing the elbow-sleeve as low as the coat edge. This strip and the hem of the skirt are



FIG. 31.—Sons and Daughters of Edward III. (From his tomb in Westminster Abbey.)

often "slittered" with fanciful jags, a fashion which soon draws down the satirist's anger. Parti-coloured garments were an added offence; a gentleman would have his coat parted down the middle in red and white, with hose of white and red to match. Men and women of rank wear a twisted garland of rich stuff, crown-wise on the head, set with pearls and precious stones, a fashion which is followed on the great helm of the knights, being the "wreath" or "torce" of heraldry. The dames of such as wear the *cote-hardie* imitate its tightness in the sleeves and bodices of their long gown. A curious fashion which now begins is the sleeveless upper gown whose sides are cut away in curved sweeps from the shoulder to below the waist, the edges of the opening being deeply furred. The strange head-dress with a steeple-horn draped with lawn kerchiefs makes its appearance to shock the moralists. Although it was probably a rare sight in this century, the horn could easily fulfil its mission of drawing notice to all its wearers.

Of the *cote-hardie* it might at least be said that it was the symbol of a knightly age in arms, the garment of a man who must have hand and limbs free, and, save for its sleeves, it faithfully copied the coat-armour of the armed knight. The softer days of Richard II. are remarkable for a dress which has also its significance, men of high rank taking to themselves gowns of such fulness that the satirists may be justified who declare that men so clad may be hardly known from women. The close collar of these gowns rises high as the neckcloth of a French *incroyable*, the upper edge turned slightly over and jagged. The full skirts sweep on the ground, which is touched by the last jags of the vast sleeves, whose openings, wide as a woman's skirts, are dagged like the edges of vine or oak leaves. "And but if the slevis," says the satirist, "slide on the erthe, thei wolle be wroth as the wynde." Sometimes this gown is slit at the sides that the gallant may the better show his coloured hose and tips of shoes that pike out two feet from heel to toe. When not wearing the gown such a lord would have a high-necked coat, shorter even than the *cote-hardie*, but looser in the skirt, the sleeves ending full and loose with dagged edges turned over at

the cuff. Hats are more commonly worn in this century, and in its latter half take many shapes, a notable one being that of a shortened sugar-loaf or thimble with a brim turned up, either all round, or, more frequently, behind or before. The long shoes, as their name of *crackowes* or *poleynes* implies, were a fashion which, by repute, came from Poland, a land ruled by the grandfather of Richard's first queen. When medieval fashions were past, they were remembered as a type of the old time, and a certain French *conteur* begins a tale of old days, not with *jadis*, but with "In the time when they wore poleynes." Even parish priests, whose preaching should "dryve out the daggis and alle the Duché cotis," went, in this age of fine apparel, gaily clad in gowns of scarlet and green, "shape of the newe," in "cutted clothes" with "long pikes on her shone." More than this, they made scandal by ruffling with weapons—"bucklers brode and swerdes long, bandrike with baselardes keene." The skill of goldsmiths and craftsmen decorates all the appurtenances of the dress of this 14th century. Buttons, which appear in the first Edward's time as a scandalous ornament on men of low degree, have now become common, and, cunningly wrought, are used as much for *queintise* as for service. A close row of them will run from wrist to elbow of tight sleeve. A row of buttons goes from the neck of a woman's gown, and the *cote-hardie* may be fastened down the front with a dozen and a half of rich buttons. A purse or gipciere hung by a ring to the girdle gives more room for ornament in the silver or brass bar on which the bag depends. Above all the girdle, which—in harness or in silk—rich men wear broad and bossed with jewels across the thigh below the waist, makes work for the jeweller's craftsman. Such a girdle is for great folk alone; but lesser men, wearing a strap about their waists, will yet have a handsome buckle and a fanciful pendant of metal guarding the loose end of the strap.

However fantastic the fashions of this or any other ages, folk of the middling sort will avoid the extremes. From the Knight to the Reve, no man of Chaucer's company calls to us by the fantasy of his clothing. The Knight himself rides in his fustian *gipoun*, the grime of his habergeon upon it, although his son's short gown, the gayest garment at the Tabard, had long and wide sleeves and is embroidered with flowers like any mead. A coat and hood of green mark the Yeoman, who has a silver Christopher brooch for ornament. The Merchant is in motley stuff, his beaver hat from Flanders and his clasped boots taking Chaucer's eye, as do the *anlas* and silken *gipses* which hang at the rich Franklin's belt. As for the London burgesses, their knife-chapes, girdles and pouches are in clean silver. The Shipman wears his knife in a lanyard about his neck, as his fellows do to this day, and his coat is of



FIG. 32.—Henry, Prince of Wales, and Occeleve the Poet (c. 1410). (From Arundel MS. 38.)

coarse falding to the knee. The Wife of Bath has the wimple below her broad hat and rides in a foot mantle about her hips. Poorer men's dress is on the Reve and the Ploughman, the one in a long *surcote* of sky-blue and the other in the *tabard* which we may recognize as that smock-frock which goes down the ages with little change.

In the 15th century the middle ages run out. Fashions in this period become, if not more fantastic, more various. Its earlier years see men of rank still inclined to the rich modes of the last age: Harry of Monmouth, drawn about 1410 by an artist who shows him as Occeleve's patron, wears a blue gown which might have passed muster at the

15th  
century.

court of Richard II. for its trailing skirts and its long sleeves, their slittered edges turned back (fig. 32). A strange fancy at this time was the hanging of silver bells on the dress. One William Staunton, in 1409, seeing in a vision at St Patrick's Purgatory the fate of earth's proud ones, is exact to note that in the place of torment the jags in men's clothes turn to adders, that women's trailing skirts are burnt over their heads, and that those men whose garments are overset with silver gingles and bells have burning nails of fire driven through each gingle. As for the chaplets of gold, of pearls and precious stones, they turn into nails of iron on which the fiends hammer.

The common habit of a well-clad man in the first half of this century is a loose tunic, lined with fur, or edged with fur at neck,



FIG. 33.—The Squire. (From the Ellesmere MS. of the *Canterbury Tales*.)



FIG. 34.—An English Squire and his Wife. (From a brass of 1409.)

wrist and skirt. At first the sleeves are long and bag-like, like to the Richard II. sleeve but drawn in to the wrist, where early examples are fastened with a button. A shorter tunic is worn below, whose tight sleeves are seen beyond the furred edge of the upper garment, mittens being sometimes attached to them. Over the shoulders the hood is thrown, or, in foul weather, a hood and cloak. The gown is girdled at the waist with a girdle from which hangs the anelace or baselard (fig. 34). Shoes are pointed. Hats and caps are seen in many shapes, but the most remarkable is the developed form of that head-dress which the 14th-century man seems to have achieved by putting his pate into the face-hole of his hood and twisting its liripipe round his brows. In the 15th century the effect is produced with a thick, turban-like roll of stuff from the top of which hung down on one side folds of



FIG. 35.—English Dress, c. 1433. (From Harl. MS. 2278.)

cloth coming nigh to the shoulder, and on the other the liripipe broadened and lengthened to 4 or 5 ft. of a narrower folded cloth. As the century advances the bagpipe sleeves shrink in size and the tunic skirts are shortened (fig. 35). The old habit of going armed with anelace or baselard dies away in spite of troublous times. In the middle of the century the tunic is often no longer than a modern frock-coat,

its sleeves little wider than those of a modern overcoat. Dress, indeed, becomes at this time convenient and attractive to our modern eyes. The last quarter of the century sees a new and important change. The tunic or gown, which was the garment of ceremony answering at once to our dress coats and frock coats, runs down to the feet. An act of 1463 ordered that coats should at least cover the buttocks, but fashion achieved

suddenly what law failed to enforce. Men who had polled their hair short allowed it to grow and hang over the shoulders. The belt carries the purse or gipciere more commonly, although weapons are rarely seen, and it is notable that, as the Reformation approaches, the fashion of wearing a large "pair of beads" in the belt becomes a very common one. Last of all, the shoes change their shape. The reign of Edward IV. had seen the pointed toes as iniquitously long as ever the 14th century saw them. Even the long riding boot has the curving point, although otherwise much resembling the jack-boot of the 18th century. But after Bosworth Field the soles broaden, the point shrinks back and then disappears, and the footprint becomes shovel-shaped.

Women's dress in the 15th century often follows the man's fashion of the furred gown, the skirts being lengthened for all difference. But the close-bodied and close-sleeved gown, with skirts broadening into many folds below the hips, is often seen with the long and plain



FIG. 36.—A Gentleman and his Wife. (From a brass of 1435.)

cloak drawn with a cord at the breast, widows wearing this dress with the *barbe*, a crimped cloth of linen drawn up under the chin and ears and covering the collar-bone. With the *barbe* went the kerchief, draping head and shoulders. The bossed cauls of the earlier head-dress, drawn high on either side of the head until face and head-dress took the shape of a heart are characteristic of the age (fig. 36). In some cases the cauls are drawn out at the sides to the form of a pair of bulls' horns or of a mitre set sideways. In the time of Edward IV. we have a popular head-dress to which has been given the name of the butterfly. The hair in its caul is pulled backward, and wires set in it allow the ends of a cambric veil to float behind like the wings of a butterfly settled on a flower.

The new England of the 16th century breaks with the past in most of its fashions. Never again does an Englishman return to the piked shoes. High fashion under Henry VIII. is all for broad toes, so broad that the sumptuary laws, from The 16th century. banning long toes, swing about to condemn excess in the new guise. Under Henry VII. the medieval influence is still strong in the body-clothing. A bravely dressed man will go in

long hose, cut close to the body, and a short vest under which the skirt is seen at waist and wrist. Over this he will wear the open gown, lined with fur, and cut short as a jacket but having the sleeves hanging below the knee. Such sleeves are commonly slashed open at the sides to allow the forearm to pass through. Shorter false sleeves of this pattern had become popular in the age of Edward IV. Graver men will wear, in place of this short gown, a long one dropping to the broad shoe-toes, the sleeves wide-mouthed (fig. 37).



FIG. 37.—A Gentleman and his Wife. (From a brass of 1508.)

Sometimes it hangs loosely; sometimes it has the girdle with purse and beads. Notaries and scriveners add to the girdle a penner, or pen-case, and a stoppered ink-bottle. Wide hats are found, crowned with huge plumes of feathers, but the characteristic headgear is that made familiar by



portraits of Henry VII., a low-crowned cap whose upturned brim is nicked at one side. A few sober men wear coats differing little from the short gown of forty years before. Among ladies the butterfly head-dress and the steeple cap passed out of fashion, and a grave headgear comes in which has been compared with a dog-kennel, a hood-cap thrown over head and shoulders, the front being edged with a broad band which was often enriched with needlework, the ends falling in lappets to the breast. This band is stiffened until the face looks out as from the open gable-end of a house. The gown is simple in form, close-fitting to the body, the cuffs turned up with fur and the skirts long. A girdle is worn loosely drawn below the waist, its long strap letting the metal pendant fall nearly to the feet. Long cloaks, plainly cut, are gathered at the neck with a pair of long cords, like tasselled bell-pulls. While Henry VIII. is spending his father's hoards we have a splendid court, gallantly dressed in new fashions. His own broad figure, in cloth of gold, velvet and damask, plaits, puffs and slashes, stiff with jewels, is well known through scores of portraits, and may stand for the high-water mark of the modes of his age. The Hampton Court picture of the



Drawn from a photo by Mansell.

FIG. 38.—The Earl of Surrey (late in reign of Henry VIII.).

earl of Surrey is characteristic of a great lord's dress of a somewhat soberer style (see fig. 38). The king, proud of his own broad shoulders, set the fashion to accent this breadth, and it will be seen that the earl's figure, leaving out the head and hose, all but fills a perfect square. Such men have the air of playing-card knaves. Surrey's cap is flat, with a rich brooch and a small side-feather. His short doublet of the new style is open in front to show a white shirt covered with black embroidery whose ruffles cover his wrists. His over-garment or jerkin has vast sleeves, rounded, puffed and slashed. Under the doublet are seen wide trunk-breeches. He goes all in scarlet, even to the shoes, which are of moderate size. The girdle carries a sword with the new guard and a dagger of the Renaissance art, graced with a vast tassel. All is in the new fashion, nothing recalling the earlier century save the hose and the immodest *braguellette* which, seen in the latter half of the fourteen-hundreds, is defiantly displayed in the dress and armour of this age of Henry VIII. Even the hair follows the new French mode and is cropped close. Other fashionable suits of the time give us the tight doublets, loose upper sleeves and trunk hose as a mass of small slashes and puffs, a fashion which came in from the Germans and Switzers whom Henry saw in the imperial service. Such clothing goes with the shoes whose broad toes are slashed with silk, and the wide and flat caps with slashed edges, bushed with feathers, which headgear was often allowed to hang upon the shoulders by a pair of knotted bonnet-strings, while a skull-cap covered the head. With all this fantasy the dress of simpler folk has little concern, and a man in a plain, short-skirted doublet, with a flat cap, trunk breeches, long hose and plain shoes, has nothing grotesque or unserviceable in his attire. The new sumptuary laws, which were not allowed to become a dead letter, had their influence in restraining middle-class extravagance. No man under a knight's degree was to wear a neck-chain of gold or gilded, or a "garded or pinched shirte." Brooches of goldsmith's work were for none below a gentleman. Women whose husbands could not afford to maintain a light horse for the king's service had no business with gowns or petticoats of silk, chains of gold, French hoods, or bonnets of velvet. This French hood is the small bonnet, two of whose many forms may be seen in the best-known portraits of Mary of England and Mary, queen of Scots—a cap stiffened with wires.

With its introduction the fashionable skirt began to lose its graceful folds and to spread stiffly outward in straight lines from the tight-laced waist, the front being open to show a petticoat as stiff and enriched as the skirt. The neck of the gown, cut low and square, showed the *parlet* of fine linen pleated to the neck. In the days of Edward VI. and Queen Mary the dress of most men and women loses the fantastic detail of the earlier Tudor age. In the dress of both sexes the joining of the sleeve to the shoulder has, as a rule, that large puff which stage dressmakers bestow so lavishly upon all old English costumes, but otherwise the woman's gown and hood and the man's doublet, jerkin and trunk hose are plain enough, even the shoes losing all the fanciful width. Mary, indeed, added to the statute book more stringent laws against display of rich apparel, laws that would fine even a gentleman of under £20 a year if silk were found in his cap or shoe. Small ruffs, however, begin to appear at the neck, and most wrists are ruffled. The ruff, which began simply enough in the first half of this century as a little cambric collar with a goffered edge, is for all of us the distinguishing note of Elizabethan dress. It grew wide and flapping, therefore it was stiffened upon wires and spread from a concealed frame, row on row of ruffs being added one above the other until the wearer, man or woman, seemed to carry the head in a cambric charger. Starch, cursed as a devilish liquor by the new Puritan, gave it help, and English dress acquired a deformity which can only be compared with the great farthingale or with the last follies of the wig. The skirt of a woman of fashion, which had already begun to jut from the waist, was drawn out before the end of Elizabeth's reign at right angles from the waist until the dame had that air of standing within a great drum which Sir Roger de Coverley remarked in the portrait of an ancestress. Elizabeth herself, long-waisted and of meagre body, set the fashions of her court, other women pinching their waists into the long and straight stomacher ending in a peak before. She herself followed her father's taste in ornament, and on great days was set about like the Madonna of a popular shrine with decorations of all kinds, patterns in pearl, quiltings, slashings, puffings and broidery, tassels and rich buttons. Among men the important change is the disappearance of the last of the long hose, all men taking to trunk-hose and nether-stocks or stockings, while their doublets tend to follow the same long-waisted fashion as the bodices of the women, whose doublets and jenkins, buttoned up the breast, bring the Puritan satirists against them. Of these satirists Philip Stubbes is the best-known, his *Anatomie of Abuses*, published in 1583, being a very wardrobe of Elizabethan fashions, although false or dyed hair, the ruff and its starch, and the ear-rings worn by some women and many men draw his hottest anger. William Harrison sings on a like note about the same time, declaiming especially against the mutability of fashion, declaring that the imported Spanish, French and German guises made it easier to inveigh against such enormities than to describe the English attire with any certainty. For him women were become men, and men transformed into monsters. "Neither was it ever merrier with England than when an Englishman was known abroad by his own cloth and contented himself at home with his fine carsey hosen and a mean slop; his coat, gown and cloak of brown, blue or puke, with some pretty furniture of velvet or fur and a doublet of sad tawny or black velvet or other comely silk, without such cuts and garish colours as are worn in these days, and never brought in but by the consent of the French, who think themselves the gayest men when they have most diversities of jags and change of colours about them." He adds that "certes of all estates our merchants do least alter their attire . . . for albeit that which they wear be very fine and costly, yet in form and colour it representeth a great piece of the ancient gravity appertaining to citizens and burgesses." But as for the "younger sort" of citizens' wives, Harrison finds in their attire "all kind of curiosity . . . in far greater measure than in women of a higher calling."

The coming of King James is not marked by any sudden change of attire, most of the Elizabethan fashions running on into his reign. The tight doublet has stiff wings at the shoulders, close sleeves and short skirt. The many fashions of breeches are still

popular, most of them padded or stuffed. There are trunk hose that have the air of petticoats rolled inward half way up the thigh. There is the "great round abominable breech,"  
 17th century. pegtop shaped from below the knee to waist, as it appears in the well-known print of James himself with hawk on fist. Among women of fashion obtained a remarkable mode of exposing the breast, when the ruff and bodice were cut away; and the wheel fardingale was still worn, an order against



FIG. 39.—An English Lady. From a brass of 1605.



FIG. 40.—An English Lady of rank in 1643. After Hollar.

it in 1613 rather increasing than diminishing its size. But simpler fashions were setting in, and with the reign of Charles I. the extravagances of padding and slashing disappear. The ruff gives place at last to the falling band, a wide collar of lace or plain linen. The belt or girdle ceases to be common wear, save for those who hang a sword from it. Parties in the state come to be known by their dress, and we have the Puritan, his crop head covered by a wide-brimmed, high-crowned felt, without hatband or feather, and his plain falling band over a staidly-cut coat.



FIG. 41.—The English Countrywoman of 1643. After Hollar.

Those who were in power favoured a sober habit, although we find General Harrison in scarlet and clinquant matching with Colonel Hutchinson in courtly apparel, and before the Restoration the tract-writers find matter of condemnation, especially in the items of patches, hair-powder and face paints.

So far as the court was concerned, King Charles II. brought in the extravagant fashions of the courtiers of Louis XIV. The

short-waisted doublets with loose sleeves slashed open at the sides, the short and wide petticoat breeches, their lining lower than the petticoat edge and tied below the knee, and the hose whose tops bagged over the garter, were in England before King Charles returned. He added to the breeches the rows of looped ribbons, gave falling ruffles to the knees of the hose and many feathers to the hat. The long, narrow-bladed rapier hung in a broad, embroidered belt, passed over the right shoulder, and the high-heeled shoes and knots of ribbons. Lely painted the women of this court in a studied negligence, but many pictures show us the loose sleeves turned up to the elbow with bows of ribbon, the close bodice ending in a loose gown worn over a full skirted petticoat, a wide collar covering the shoulders.

Pepys is our chief authority for the remarkable resolution of Charles to change the fashion of his dress to one which he would never alter, a decision which the king communicated to his council in October 1666. On the 15th of that month the diarist noted that "this day the king begins to put on his vest, and I did see several persons of the House of Lords and Commons too, great courtiers, who are in it; being a long cassocke close to the body, of black cloth and pinked with white silk under it, and a coat over it, and the legs ruffled with black riband like a pigeon's leg . . . a very fine and handsome garment."

Rugge's diary records the same change to "a close coat of cloth pinkt, with a white taffety under the cutts. This in length reached the calf of the leg, and upon that a sercoatt cutt at the breast, which hung loose and shorter than the vest six inches. The breeches the Spanish cut, and buskins, some of cloth, some of leather, but of the same colour as the vest or garment." Says Evelyn, "a comely and manly habit, too good to hold." Later in the same month Pepys saw the court "all full of vests, only my Lord St Albans not pinked, but plain black; and they say the king says the pinking upon whites makes them look too much like magpies, and therefore hath bespoken one of plain velvet." The change, although the court was fickle, is of the first importance in the history of costume, for we have here the coat and waistcoat in a form from which our own coats and waistcoats derive without a break. Another important change affects dress for a century and a half. Just as costume begins to take the modern path we have the wig or peruke, strangest of all the fantasies of fashion, introduced as the wear for all men of standing. Pepys, the son of a tailor and a man with a shy affection for fine clothing, may again here be quoted. On a Sunday in February 1661 he "began to go forth in my coat and sword, as the manner now among gentlemen is." In November 1663 he takes another step with fashion, going to the perwig-maker to have his hair cut off and to put on his first perwig, for which he paid 3', another to be made up of the hair with which he had parted. The next day he wore the perwig to his office, and "no great matter was made of it." Two days later my Lord Sandwich "wondered at first to see me in my peruque," but even in church Pepys found that he drew little attention in the new guise. The same month the duke of York announced that he would wear the perwig, "and they say the king also will." Thus began this costly and inconvenient mode. At home and at their ease men commonly replaced the wig with a soft silk or velvet "night-cap," and the coat with a "morning gown" like our modern dressing gown.



FIG. 42.—A Squire of a Knight of the Bath at the Crowning of Charles II.

Powder, which had been dusted about the hair by a few courtiers and fashionable folk since the reign of Elizabeth, was used by most wearers of the wig. Hair "dressed with a powder" was often seen in London under the Commonwealth, and now the great periwig brought powder into frequent use.

Before the end of the 17th century the periwig reached its greatest height and breadth, the curls of a fine gentleman towering in a mass above the brow and flowing far down over the shoulders or nigh to the waist. Guardsmen wore them tossing over their corsets, although a smaller variety, the campaign wig, had been introduced for war or travel. Many portraits of this age show its locks contrasting strangely with the soldier's steel breastplate and pauldrons, but it must be remembered that martial gentlemen would often choose to be painted in armour although such harness was disappearing from actual use.

Under James II. the coat adopted in the late reign was firmly established as the principal garment of a well-dressed man. Gowns remained but to make a ceremonial dress for the great officers of state, for the judges and the London liverymen, for such, indeed, as those who wear them in our own days. As for

"the comely cloak, altogether used in the beginning of my time," Randle Holme notes that it was "now scarce used but by old and grave persons." The coat was sometimes buttoned down the front but was more often thrown open to display the waistcoat, a lesser coat with skirts. The great turned over cuffs were now below the elbow, although there was good space for the display of the ruffle, and at the neck was the large cravat with laced ends. After the battle of Steinkirk, in 1692, to which the young French nobles hastened with disarranged neckcloths, the cravat was sometimes worn twisted, the ends passed through a ring, although the word Steinkirk was in later years often carelessly given to the neckcloth worn in any style. For riding, the big jack-boot of earlier days, with spurs and broad spur-leathers, remained in fashion, although the bell-shaped tops were turned up and not down. Boots, however, were



FIG. 44.—The Herbwoman and her Maids at the Crowning of James II.

riding-gear. Gondomar, the Spanish ambassador to James I., had laughed over the citizens of London "all booted and ready to go out of town," but this custom died away, and a man in boots showed that he was for the road. William III.'s grave court was not one in which new fashions flourished, but it is remarkable that feminine modes take curious variety before the century end. Long-waisted and straitly cut stays were worn, the gown sleeve is short as the coat-sleeve of a Charles II. courtier. The gown itself has the skirts gathered to show the petticoat,

and small aprons fringed with lace are often seen. The simple head-dresses of the Restoration are changed for caps with long lace lappets, or for a cap whose top-knot or commode stood up stiff and fan-shaped like a section cut out of an old ruff. When no commode was worn, a loose hood, thrown gracefully over the head and gathered at the shoulders, sometimes took its place. As a riding or walking dress, ladies of quality often wore coats, waistcoats, hats and cravats, not to be distinguished from those of their lords.

For a distinguishing note of the 18th century, we may take the three-cornered cocked hat. Even in the Elizabethan age we have the gallant cocking up one side of his broad-brimmed, high-crowned felt or beaver and securing it with a jewel. Brims were as wide at the end of the 17th century, but the crown was lower. From the French court came the fashion of cocking up three sides, one at least being fastened with a loop of ribbon from which developed the cockade. A black cockade became the sign of a military man in England before 1750, and the same ornament, highly conventionalized, is now at the side of the tall hats worn by the grooms and coachmen of military and naval officers. Following varying fashions, the 18th-century cocked hat was laced with gold and silver or edged with feathers. It was cocked in a hundred forms, from that which has three sides slightly curled upward to the great Khevenhueller cock, wherewith a very wide-brimmed hat was flapped up at the front and rear, a military or martial hat. Wigs, worn by all the upper- and middle-class men, were generally powdered, but the lesser or Ramillie wig soon drove out the huge and costly full-bottomed periwig, even for ceremonial occasions. Of Lord Bolingbroke it is told that he once attended Queen Anne in haste with a tie or Ramillie wig on his head. Her Majesty showed her displeasure by remarking that his lordship would next come to court in a night-cap. Nevertheless, the tie-wig soon became court wear, secured at the back with a huge bow of ribbon below which hung the plaited pigtail, worn waist-long about 1740. But by that time young bloods were leaving campaign-wigs for the bob-wig which sat yet more closely to the head, the curls leaving the neck uncovered. Bag-wigs, found early in the century, covered the looped up pigtail in a black silk bag. Clergymen and grave physicians affected the full-bottomed wig after it became old fashioned. Subject to slight changes, eagerly followed by the beaux and mocked by the satirists, the habit of well-dressed men shows no great variety—the large-cuffed, collarless coats whose full skirts are now shortened, now lengthened, the long waistcoat to match, the closely fitting breeches, the stockings, the shoes and jack-boots. The coat tends to be thrown open to show the waistcoat, upon which brocade and embroideries were lavished. Stockings, until the middle of the century, were commonly drawn over the ends of the breeches and gartered below the knee. By 1740 the long cravat with hanging ends grows old fashioned. Young men take to the solitaire, a black cravat which became a mere loop of ribbon passed loosely round the neck and secured to the black tie of the wig.

George III.'s long reign begins with men's fashions little changed from those of his great-grandfather's time, although his sixty years carry us to the beginning of all the modern modes. The small wig long holds its own. The coat begins to show the broad skirts cut away diagonally from the waist to the skirt edge, and stockings are no longer rolled over the knee. Perhaps the most remarkable fashion was that which distinguished the Macaronis, travelled exquisites with whom the wig or long hair was dragged high above the forehead in a tall



FIG. 45.—An English Gentleman (c. 1730).

The 18th century.

"toupee" with two large rows of curls at the side. This head-dress, clubbed into a heavy knot behind, was surmounted by a very little hat. The coat with small cuffs was much cut away before, the skimped skirts reaching midway down the thigh. Waistcoat flaps were but little below the waist. Breeches, striped or spotted like those of a Dresden china shepherd, were fastened at the knee with a bunch of ribbon ends; a watch-guard hung from each fob. The shirt-front was frilled and a white cravat was tied in a great bow at the chin. Macaronis wore a little curved hanger, or replaced the sword with a long, heavily tasselled cane, which served to lift the little hat off the topmost peak of the toupee. The woman-Macaroni wore no hoop but in full dress. Her gown was a loose wrapper, the sleeves short and wide with many ruffles, the skirt pulled aside to show a petticoat laced and embroidered with flowers. But her distinguishing mark was her head-dress, which exaggerated the male fashion, towering upward until the flowers and feathers at the top threatened the candelabra of the assembly room. The Macaronis appear about 1772 and stay but a short while, for the revolutionary fashions tread upon their heels.

Women's dress in this 18th century is dominated by the hoop-petticoat which Sir Roger de Coverley recognizes in 1711 as a



FIG. 46.—An English Lady  
(c. 1730).

new fashion and an old one revived. A stiff bodice laced in front, a gown, with short and wide-ended sleeves, gathered up in folds above the petticoat, a laced apron and a lace cap with hanging lappets, is the dress of the century's beginning. So the women of fashion are compared with children in go-carts, their tight-laced waists rising from vast bells of petticoats over which the gown is looped up like a drawn curtain. By 1750 the hoop-petticoat ringed with whalebone is so vast that architects begin to allow for its passage up London stairways by curving the balusters outward. Great variety of women's dress appears under George II., but those in the height of the mode affected a shepherdess simplicity in their walking clothes, wearing the flat-crowned or high-crowned hats and long aprons of the dairymaid. At this time a new fashion comes in, the *sacque*, a gown, sometimes sleeveless, open to the waist, hanging loosely from the shoulders to near the edge of the hoop-petticoat. George III.'s reign saw women's head-dressings reach an extravagance of folly passing all that had come before it. Hair kneaded with pomatum and flour was drawn up over a cushion or pad of wool, and twisted into curls and knots and decorated with artificial flowers and bows of ribbon. As this could not be achieved without the aid of a skilled barber, the "head" sometimes remained unopened for several weeks. At the end of that time sublimate powder was needed to kill off the tenantry which had multiplied within. At the beginning of the last quarter of the century the feathers grew larger, chains of beads looped about the curls, while ships in full sail, coaches and horses, and butterflies in blown glass, rocked upon the upper heights. Loose mob-caps or close "Joans" were worn in undress, often as simple as the full dress was fantastic. Varieties of the gown and *sacque* remained in fashion, the petticoat being still much in evidence, flounced or quilted, or festooned with ribbons. Before the 'eighties of this century were over, a new taste, encouraged by the painters of the school of Reynolds, began to sweep away many follies, and the revolutionary fashions of France, breaking with all that spoke of the old régime, expelled many more. The age of powder and gold lace, of peach-bloom brocade coats with

muff-shaped cuffs, of bag-wigs and three-cornered hats drew suddenly to an end. Mr Pitt killed hair-powder by his tax of 1795, but before that time fashionable men, who since the beginning of George III's reign had been somewhat inconstant to the wig, were wearing their own hair unpowdered and tied in a club at the back of the coat collar. Before the century end the roughly cropped "Brutus" head was seen. The wig remained here and there on some old-fashioned pates. Bishops wore it until far into the Victorian age, and it may still be seen in the Houses of Parliament and in the courts of law. Even breeches were passing, tight pantaloons showing themselves in the streets. The coat, cut away over the hips, began to take a high collar and the beginnings of the lappel. Its cuffs were of the modern shape, showing a narrow ruffle. The waistcoat ended at the waist. Loose neck-cloths were worn above a frilled shirt-front. Great jack-boots were given to postillions, and men of fashion walked the streets in short top-boots of soft black leather. Most remarkable of the revolutionary changes, the round hat came back, sometimes in a form which recalled the earlier 17th century, and at last took shape as the predecessor of our modern silk hat. Court dresses kept something of their magnificence, but men at home or in the streets were giving up in this time of change their ancient right to wear rich and figured stuffs. Laces and embroideries were henceforward but for military and civil uniforms.

Before 1790 women had begun to dismantle their high head-gear, returning to nature by way of a frizzled bush, like a bishop's wig, with a few curls hanging over the shoulders. Over such heads would be seen towering mob-caps tied with ribbon and edged deeply with lace. Skirts took a moderate size and even court hoops were but panniers hung on either side of the hips. Short jackets with close half-sleeves were worn with the neck and breast covered with a cambric *buffant* that borrowed a mode from the pouter pigeon. A riding habit follows as far as the short waist the new fashions for men's coats, the wide-brimmed hat being to match. Short waists came in soon after 1790, the bodice ending under the arm pits, "a petticoat tied round the neck: the arms put through the pocket-holes." With these French gowns came small coal-scuttle-shaped bonnets of straw, hung with many ribbons and decorated with feathers. At last the woman of fashion, dressed by a Parisian modiste after the orders of David the painter, gathered her hair in a fillet and clothed herself in little more than a diaphanous tunic gown over a light shift and close, flesh-coloured drawers. Her shoes became sandals: her jewels followed the patterns of old Rome. Yet the same woman, shivering half-clad in something that wrapped her less than a modern bathing-dress, appeared at court in the ancient hoop-skirt, tasselled, ribboned and garlanded, hung with heavy swags of coloured silk, and this until George IV. at last broke the antique order by a special command.

The 19th century soon made an end of 18th century fashions already discredited by the revolutionary spirit. The three-cornered hat had gone, the heavy coat cuff and the cravat with hanging ends. Civilians had given up the ancient custom of going armed with a sword. The wig and even the pigtail tied with black shalloon were abandoned by all but a few old folk. Soldiers cut off their pigtails in 1808. But judges and lawyers wear their wigs in court in the 20th century, state coachmen wear them on the box, and physicians and the higher clergy wore them even in the street long after laymen had given them up. George IV. refused to receive a bishop of London who appeared at court without a wig, and Sumner, archbishop of Canterbury, wore one until his death in 1862. A few powdered heads were seen as late as the 'forties. M. de Ste Aulaire, the ambassador, made, as Lord Palmerston writes, a very deep and general impression in London society of 1841, not because he wore hair-powder but because he used so much of it. It is now used only by a few lacqueys. In the early Victorian period the cropped "Brutus" head was out of fashion, many men wearing their hair rather long and so freely oiled that the "anti-macassar" came in to protect drawing-room chair-backs.

With powdered hair and the pigtail passed away the 18th century cloth breeches. Here again some old-fashioned people made a stand against the change, the opposition of the clergy being commemorated in the black breeches still worn by bishops and other dignitaries of the church. But in the regent's time pantaloons of closely fitting and elastic cloth were worn with low shoes or Hessians, and pantaloons and Hessians did not utterly disappear from the streets until the end of the 'fifties. Squires and sportsmen put on buckskins of an amazing tightness and walked the street in top-boots. But the loose Cossack trousers soon made their appearance. The regent's influence made the blue coat with a very high velvet collar, a high-waisted Marcella waistcoat and white duck trousers strapped under the instep, a mode in which men even ventured to appear at evening receptions, although, in the year before Waterloo, the duke of Wellington was refused admittance to Almack's when thus clad. Long skirted overcoats, fur-collared and tight in the waist, completed this costume. Coats were blue, claret, buff and brown. "Pea-green Hayne" was known among clubmen by a brighter coloured garment. Civilians, like Jos Sedley, would sometimes affect a frock frogged and braided in semi-military fashion. The shirt collar turned upward, the points showing above vast



From *Fraser's Magazine*, Dec. 1834.

FIG. 47.—Count D'Orsay. Dress of a man of Fashion in Early Victorian Period.

cravats whose careful arrangement was maintained by one or two scarf-pins. Brummel the master dandy of his age, may be called the first dandy of the modern school. Dressing, as a rule, in black, he distinguished himself, not as the bucks of an earlier age by bright colours, rich materials or jewellery, but by his extravagant neatness and by the superb fit of garments which set the fashion for lesser men. To him, according to Grantley Berkeley, we owe the modern dress-coat. An idle phrase in Bulwer-Lytton's *Pelham* (1828), that "people must be very distinguished in appearance" to look well in black, made black henceforward the colour of evening coats and frock coats. With the perfection of the silk hat in the 'thirties, English costume enters on its last phase. The coat cut away squarely in front was then out of the mode;

it remains but in the evening-dress coat now always worn unbuttoned, and in the dress of the hunting field. The rest is a record of such slight changes as tailors may cautiously introduce among customers, no one of whom will dare to lead a new fashion boldly. For many decades the fashionably dressed man has been eager to conform to the last authorized vogue and to lose himself among others as shyly obedient. The tubular lines of 20th-century clothing advantage the tailor by the tendency of new clothing to crease at the elbow and bag at the knee. In preserving the necessary straight lines of his garments, in following the season's fashions in details which only an expert eye would mark, and in providing himself with clothes specialized for every hour of the day, for a score of sports and for the gradations of social ceremonial—in these things only can the modern dandy rival his magnificent predecessors. For ornament, other than plain shirt studs, a plain seal ring, a simple watch guard and a rarely-worn scarf pin, is denied him.

Women at the beginning of the 19th century were clad in those fashions which revolutionary France borrowed from the antique. The simplicity of this style gave it a certain grace; it was at the other pole from the absurdity of the court dress which, until George IV. ordered otherwise, perpetuated the bunched draperies, the flounces and furbelows and even the hoop of the worst period of the 18th century. The gown, lightly girdled near the arm-pits with a tasselled cord, fell in straight clinging folds. Soft muslin was the favourite material, and in muslin fashionable

women faced the winter winds, protected only by the long pelisses which in summer were replaced by short spencers. Turbans, varying from a light headscarf of lace or muslin to a velvet confection like that of a Turk on a signboard, were the favourite headgear, although bonnets, hats and caps are found in a hundred shapes. Muslin handkerchiefs or small ruffs were worn about the neck in the morning dress. About the Waterloo period the elegance of the classical gown disappeared. The waist was still high at first but the gown was shorter and wider at the skirt. For evening dress these skirts were stiffened with buckram and trimmed with much tasteless trumpery. Large bonnets were common, and the hair was dragged stiffly to the back of the head, to be secured by a large comb. From 1830 begins a period of singular ugliness. Tight stays came back again, the skirt swept the pavements, a generation of over-clad matrons seemed to have followed a generation of nymphs. The 'fifties showed even more barbarous devices, and about 1854 came in from France the crinoline, that strange revival of the ancient hoop. Plaids, checks and bars, bright blues, crude violets and hideous crimsons, were seen in French merinos, Irish poplins and English alpacas. Women in short jackets, hooped skirts, hideous bonnets and shawls seemed to have banished their youth. The empress Eugénie, a leader of European fashion, decreed that white muslin should be the evening mode, and at balls, where the steels and whalebones of the crinoline were impossible, the women swelled their skirts by wearing a dozen or fourteen muslin petticoats at once. Towards the end of the 'sixties the crinolines disappeared as suddenly as they came, and by 1875 skirts were so tight at the knees that walking upstairs in them was an affair of deliberation. Before 1880 dress-reformers and aesthetes had attacked on two sides the fashions which had halted at the "Princesse" robe, draped and kilted. Both movements failed, but left marked effects. From that time fashion has been less blindly followed, and women have enjoyed some limited individual freedom in designing their costumes. Of 20th-century fashions it is most notable that they change year by year with mechanical regularity. The clothes of smart women can no longer be said to express any tendency of an age. Year by year the modes are deliberately altered by a conclave of the great *modistes* whose desire is less to produce rich or beautiful garments than to make that radical alteration from loose sleeve to tight sleeve, from draped skirt to plain skirt, which will force every woman to cast aside the last season's garments and buy those of the newer device. But of modern dress it may at least be said that cheaper materials, the sewing machine and the popular fashion papers allow women of the humbler classes to dress more decently and tastefully. Their dress is no longer that frowsy parody of richer women's frippery which shocked observant foreigners a generation ago.

*Underclothing.*—Of the underclothing worn next the skin something may be said apart from the general history of costume. Linen shirts were worn by both men and women in the age before the Conquest, and even in the 10th century it was a penance to wear a woollen one. After that time we soon hear of embroidery and ornament applied to them, presumably at the collar which would be visible above gown or tunic. Men added short drawers, or breeches, a word which does not secure its modern value until the end of the 16th century. "Drawers" signified various descriptions of overall, Cotgrave explaining the word as coarse stockings drawn over others although Randle Holme gives it in its later sense. Isaac of Cyprus is named by Robert of Brunne as escaping "bare in his serke and breke." Henry Christall, who brought four Irish kings to London, told Froissart how, finding that they wore no breeches, he bought linen cloth for them. Medieval romances and the like give us the choice of shirts of linen, of fine Holland, of cloth of Rennes and even of silk, and Chaucer speaks of women's smocks wrought with silk, embroidered behind and before. Poorer folk went, like Thynne's poor countryman, in shirts of "canvas hard and tough," or of coarse Breton dowlas. Under the first Tudors, shirts are decorated with gold, silk and black thread embroideries, the latter being seen in the ruffled shirt worn by the earl of Surrey



in our illustration (see fig. 38). Stubbes, in his often-quoted *Anatomie of Abuses* (1583) declaims against the extravagant sums spent in shirts, the meanest of which would cost a crown or



FIG. 48.—A Man-at-arms and a Man in a Shirt (early 14th century). From Royal MS. 19 B. xv.

a noble, while the most curiously stitched were valued at ten pounds a piece, "which is horrible to hear." The Puritans, many of whom, like the later Clapham sect, were careful of intimate luxuries, had a curious fashion of wearing shirts and smocks worked with "holy embroideries," Biblical sentences or figures, which recall a similar custom among the early Christians. At this time underclothing had increased in quantity, for there are many indications that the men and women of the middle ages were often content with a bare change of linen at the best. The *Book of Courtesy* (temp. Hen. VII.) orders the servant to provide "clene sherte and breche" against his master's uprising, but the laundering of the linen of the Percy household, a hundred and

seventy people, costs but forty shillings a year in the reign of Henry VIII.

With that modern period of dress which may be said to begin with the Restoration, shirts increased in number. Women shifted their smocks when coming in from field sports, fine gentlemen became proud of the number of their shirts, as was that 18th-century lord who boasted to Casanova of his changing a shirt several times in the day, his chin being shaved on each occasion. A valuable document concerning the underclothing worn by a citizen in the reign of Charles II. is afforded by the evidence of the man who helped to strip the body of the suicide Sir Edmond Berry Godfrey. "I pulled off his shoes," says Fisher, "three pairs of stockings and a pair of socks, his black breeches and his drawers." His coat and waistcoat, his shirt and his flannel shirt are also named. The knight came by his end on an October day. He was therefore warmly clad. His three pair of stockings will be noted: two pair are worn at the present day by most men in court dress. The socks are a rarely named addition, and the flannel shirt may be remarked. Loose ruffles of lace were attached to shirt cuffs until during the great part of the 18th century, and the ruffled or goffered shirt-front, which became common under George III., continued in use in the early Victorian period, the stiffly starched shirt-front taking its place at last even in evening dress. The last quarter of the 19th century, breaking through the strange mock-modesty which spoke of breeches as "inexpressibles," saw the question of hygienic underclothing a subject much in debate, and now most men other than the poorer sort wear, besides the shirt, a light woollen vest and short drawers or long pantaloons of wool or wool's counterfeit. Woollen shirts are worn by bicyclists, cricketers and tennis players. In morning dress the inconvenience of the starched shirt-front is commonly avoided. A goffered shirt-front worn with evening dress is the mark of a foreigner in London, but some few men venture to clothe themselves for the evening in a shirt whose front is pleated and but slightly starched. Loose collars, formerly known as false collars, descendants of the Puritan's "plain band," have been attached to the shirt by studs at least for the last fifty years. Their fashions often change, but the older type turned down at the edge is not often seen. To women's underclothing drawers have been added in the 19th century. Brantôme, writing in the 16th, speaks of this garment as then lately introduced since the time of Henri II., but the fashion, apparently, did not long endure in France. In England they are noted as in occasional use at the Restoration. After 1820 a sort of trouser

with a frilled edge was worn for a time by fashionable women in England. The pantalette which afterwards appears in pictures of young girls was a mere legging fastened by tapes above the knees. Many women of the better class only adopted drawers at the end of the 'forties, and it may be presumed that the fashion reached the humble sort at a much later date. Towards the end of the 19th century both drawers and smock or "chemise" were commonly exchanged for a more convenient "combination garment."

*European Fashions.*—Race, climate, poverty and wealth have all had their part in the fashion of clothing. A mountaineer is not clad as a lowlander; the Tirolese in his short breeches, the Highlanders of Scotland and Albania in their tartan or white linen kilts go with uncovered knees. The Russian moujik in winter has his frowsy sheepskin coat, and the Russian prince imitates it in costly furs. While the rich man's clothing alters with every fancy of the tailors, the poor man's garments, fewer and cheaper, change slowly in the ages. An old Lincolnshire peasant wearing his smock frock and leathern gaiters might pass unnoted in a peasant crowd of centuries ago. Here and there in Europe we find in the 20th century a peasantry in whose clothing fashion seems to have been suddenly stayed. A Breton peasant in his holiday dress gives us a man of the late 17th century, even as an Irish peasant may keep the breeches, shoes and tailed coat of the early 19th. But the old fashions are passing from Europe: the sewing machine and the railway sweep before them the pleasant provincialisms of dress. A shirt with the bosom heavily embroidered, a skirt with a year's stitching in the hem are not to be imitated by the dealer in ready-made clothing, who offers, instead, cheapness and the brisk variety of the town. Old writers, each in turn, set up their wail that the time was come when you could not tell Jack from his master, the burgess from the knight. And now that time has come in some sort, for the town dress of the richer classes of London or Paris is imitated by all peoples



From Hottenroth, *Trachten der Völker*, by permission of Gustav Weise Verlag. FIG. 49.—German Dress (early 16th century).



From Hottenroth, *Trachten der Völker*. FIG. 50.—A French Nobleman (c. 1660).



From Hottenroth, *Trachten der Völker*. FIG. 51.—A Spanish Nobleman (latter half of 16th century).

and by rich and poor. Especially is this the case in England where the clean and honourable blouse of the French workman is not, a journeyman painter or labourer often going to his work

in a frayed and greasy morning coat after the cut of that in which a rich man will pay a London morning call. English fashions for men are followed in Paris. London women follow the modes of the rue de la Paix. Berlin tailors and dressmakers laboriously misapprehend both styles. To those who do not understand the international trafficking of the middle ages and the age of renaissance it is strange to note how little the fashions varied in European lands. All kinds of folks, crusaders and merchants, diplomatists and religious, carried between nation and nation the news of the latest cut of the shears.

Nevertheless, national character touched each nation's dress—the Venetian loving the stateliness of flowing line, the Germans grotesque slashings and jaggings. Frenchmen, says Randle Holme in the 17th century, keep warm and muff themselves in cold weather, "but in summer through fantastical dresses go almost naked." For the same writer the Spaniard was noted as a man in a high-crowned hat with narrow brim, a ruff about his neck, a doublet with short and narrow skirts and broad wings at the shoulders, ruff-cuffs at his hands, breeches narrow and close to his thighs, hose gartered, shoes with rounded toes, a short cloak and a long sword. In all of those points we may take it that the Spaniard differed from the Englishman as observed by this observant one. Even in our own days we may catch something of those national fashions. The Spaniard may no longer walk with his long sword, his ruff and gartered hose, but he keeps his fancy for sombre blacks, and so do the citizens of those Netherlands which he once ruled. (O. BA.)

### III. NATIONAL AND CLASS COSTUME

Costume, as readers of Carlyle's *Sartor Resartus* know, always has a significance deeper than the mere whims of fashion. In the cosmopolitan society of modern times dress everywhere tends to become assimilated to a common model, and this assimilation, however regrettable from the picturesque point of view, is one of the most potent forces in the break-down of the traditional social distinctions. In the middle ages in Europe, and indeed down to the French Revolution, the various classes of the community were clearly differentiated by their dress. Everywhere, of course, it happened that occasionally jackdaws strutted in peacock's feathers; but even in England, where class distinctions were early less clearly marked than on the continent of Europe, the assumption of a laced coat and a sword marked the development of a citizen into a "gentleman" (*q.v.*). Nothing has more powerfully contributed to the social amalgamation of the "upper-middle" and the "upper" classes in England than the fashion, introduced in the 19th century, of extreme simplicity in the costume of men. But, apart from the properties of richness in material or decoration as a symbol of class distinction—at one time enforced by sumptuary laws—there have been, and still are, innumerable varieties of costume more or less traditional as proper to certain nationalities or certain classes within those nationalities. Of national costumes properly so called the best known to the English-speaking world is that of the Highlands of Scotland. This is, indeed, no longer generally worn, being usually confined to gentlemen of birth and their dependents, but it remains a national dress and is officially recognized as such by the English court and in the uniforms of the Highland regiments in the British army. The chief peculiarity of this costume, distinguishing it from any others, is the tartan, an arrangement of a prevailing colour with more or less narrow checks of other colours, by which the various clans or septes of the same race can be distinguished, while a certain general uniformity symbolizes the union of the clans in a common nationality. Thus, *e.g.* the tartan of the clan McDonell is green with narrow checks of red, that of the clan Gregarach red with narrow checks of black. The costume consists of a short tunic, vest, a kilt—heavily pleated—fastened round the waist, and reaching not quite to the knees (like a short petticoat), stockings gartered below the bare knee, and shoes. In front of the person, hanging from a belt round the waist, is the "sporrán" or "spleuchan," a pocket-purse covered with fur; and a large "plaid" or scarf, usually wrapped round the body, the ends hanging down from a

brooch fastened on the left shoulder, but sometimes gathered up and hanging from the brooch behind, completes the costume. The head-gear is a cloth cap or "bonnet," in which a sprig of heather is stuck, or an eagle's feather in the case of chiefs. A dirk is worn thrust into the right stocking. Up to the end of the 16th century the tunic and "philibeg" or kilt formed a single garment; but otherwise the costume has come down the ages without sensible modification. Kilt and plaid are of tartan; and sometimes tartan "trews," *i.e.* trousers, are substituted for the former.

Among other national costumes still surviving in Europe may be mentioned the Albanian-Greek dress (characterized by the spreading, pleated white kilt, or *fustanella*), and the splendid full-dress of a Hungarian gentleman, the prototype of the well-known hussar uniform; to which may be added the Tirolese costume, which, so far as the men are concerned, is characterized by short trousers, cut off above the knee, and a short jacket, the colour varying in different districts. This latter trait illustrates the fact that most of the still surviving "national" costumes in Europe are in fact local and distinctive of class, though they conform to a national type. These "folk-costumes" (*Volks-trachten*), as the Germans call them, survive most strongly in the most conservative of all classes, that of the peasants, and naturally mainly in those districts least accessible to modern "enterprise." These peasant costumes, often of astonishing richness and beauty, vary more or less in every village, each community having its own traditional type; and, since this type does not vary, they can be handed down as valuable heirlooms from father to son and from mother to daughter. But they are fast disappearing. In the British islands, where there were no free peasant cultivators to maintain the pride of class, they vanished long since; the white caps and steeple-crowned hats of Welsh women were the last to go; and even the becoming and convenient "sun bonnet," which survives in the United States, has given place almost everywhere to the hideous "cloth cap" of commerce; while the ancient smocked frock, the equivalent of the French peasant's workmanlike *blouse*, has become a curiosity. The same process is proceeding elsewhere; for the simple peasant women cannot resist the blandishments of the commercial traveller and the temptation of change and cheap finery. The transition is at once painful and amusing, and not without interest as illustrating the force of tradition in its struggle with fashion; for it is no uncommon thing, *e.g.* in France or Holland, to see a "Paris model" perched lamentably on the top of the beautiful traditional head-dress. Similarly in the richer Turkish families women are rapidly acquiring a taste for Parisian costumes, frequently worn in absurd combination with their ordinary garments.

The same process has extended far beyond the limits of Europe. Improved communication and industrial enterprise have combined with the prestige of European civilization to commend the European type of costume to peoples for whom it is eminently unsuited. Even the peoples of the East, whose costume has remained unchanged for untold centuries, and for whom the type has been (as in India) often determined by religious considerations, are showing an increasing tendency to yield to the world-fashion. Turkey, as being most closely in touch with Europe, was the first to feel the influence; the introduction of the fez and the frock-coat, in place of the large turban and flowing caftan of the old Turk, was the most conspicuous of the reforms of Sultan Mahmud II.; and when, in 1909, the first Turkish parliament met, only a small minority of its members wore their traditional costumes. The introduction of Japan into the comity of nations was followed by the adoption of European costume by the court and the upper classes, at least in public and on ceremonial occasions; in private the wide-sleeved, loose, comfortable *kimono* continues to be worn. China, on the other hand, has been more conservative, even her envoys in Europe preserving intact (except sometimes in the matter of boots) the traditional costume of their nation and class, while those of Japan, Corea and Siam appear in the conventional diplomatic or "evening" dress in Europe. In the Mussulman East, even when

European dress has been adopted, an exception has usually been made in favour of head-gear, which has a special religious significance. In Turkey, for instance, the hat has not succeeded in displacing the *fez*; and in India, though the Parsis had by the beginning of the 20th century begun to modify their traditional high turban-like hat into a modified "bowler," and Hindus—abroad at least—were affecting the head-gear of the West, those Mussulman princes who had adopted, wholly or partially, European dress continued to wear the turban. On the other hand, the amir of Afghanistan, when he visited India, had—out of doors at least—discarded the turban for the ugly "solar topee." In spite of the natural conservatism, strengthened by religious conventions, of the Eastern races, there is a growing danger that the spread of European enlightenment will more or less rapidly destroy that picturesque variety of costume which is the delight of the traveller and the artist. For Indian costumes see INDIA: *Costume*; for Chinese see CHINA; &c.

#### IV. OFFICIAL COSTUME

Official costumes, in so far as they are not, like the crowns and tabards of heralds, the coronets of peers, or the gold keys tacked to the coat-tails of royal chamberlains—consciously symbolical, are for the most part ceremonious survivals of bygone general fashions. This is as true of the official costume of the past as of the present; as may be illustrated from ancient Rome, where the toga, once the general costume of Roman citizens, in the 3rd and 4th centuries was the official robe of senators and officials (see also under VESTMENTS). Thus, at the present time, the lay chamberlains of the pope and the members of his Swiss guard wear costumes of the 16th century, and the same is true of the king's yeomen of the guard in England. In general, however (apart from robes, which are much older in their origin), official costumes in Europe, or in countries of European origin, are based on the fashions of the 18th and early 19th centuries. Knee-breeches, however, which survive in the full-dress of many British officials, as in ordinary court dress, had practically disappeared on the continent of Europe, surviving only in certain peasant costumes, when the emperor William II. reintroduced them at the court of Berlin. The tendency in the modern democratic communities of Anglo-Saxon race has been to dispense with official costumes. In the United States the judges of the Supreme Court alone wear robes; the president of the Republic wears on all occasions the dress of an ordinary citizen, unrelieved by order or decoration, and thus symbolizes his pride of place as *primus inter pares*; an American ambassador appears on state occasions among his colleagues, gorgeous in bullion-covered coats, in the ordinary black "evening dress" of a modern gentleman. The principle, which tends to assert itself also in the autonomous "British dominions beyond the seas," is not the result of that native dislike of "dressing up" which characterizes many Englishmen of the upper and middle classes; for modern democracy shares to the full the taste of past ages for official or quasi-official finery, as is proved by the costumes and insignia of the multitudinous popular orders, Knights Templars, Foresters, Oddfellows and the like. It is rather cherished as the outward and visible sign of that doctrine of the equality of all men which remains the most generally gratifying of the gifts of French 18th-century philosophy to the world. In Great Britain, where equality has ever been less valued than liberty, official costumes have tended to increase rather than to fall into disuse; mayors of new boroughs, for instance, are not considered properly equipped until they have their gown and chain of office. In France, on the other hand, the taste of the people for pomp and display, and, it may be added, their innate artistic sense, have combined with their passion for equality to produce a somewhat anomalous situation as regards official costume. Lawyers have their robes, judges their scarlet gowns, diplomatists their gold-laced uniforms; but the state costume of the president of the Republic is "evening dress," relieved only by the red riband and star of the Legion of Honour. In the Latin states of South America, which tend to be disguised despotisms rather than democracies, the actual rather than the theoretical state of things is symbolized

by the gorgeous official uniforms which are among the rewards of those who help the dictator for the time being to power. See also ROBES; for military costume see UNIFORMS; for ecclesiastical costume see VESTMENTS and subsidiary articles. (W. A. P.)

BIBLIOGRAPHY.—Apart from the enormous number of books especially devoted to costume, innumerable illustrated works exist which are, in various degrees, useful for the study of the history of this subject. It may be noted here, e.g. that the illuminators and painters of the middle ages did not affect historical accuracy in their presentation of biblical or secular subjects, but clothed their patriarchs, apostles or Roman warriors in the dress of their own ages, their pictures thus becoming invaluable records of the costume of their time. In this respect the knowledge of classical antiquity revived during the Renaissance introduced a certain confusion. Artists began to realize the incongruity of representing antique figures in modern garb, but, in the absence of exact knowledge, fancy began to play a greater part than research in the dressing of their characters. Portraits and representations of contemporary scenes (e.g. Rembrandt's "Night Watch") continue to be first-hand authorities for the costume of the period in which they were produced; but representations of biblical or historical scenes have little or no value from this point of view. Thus in Rubens's famous picture of St Ambrose repelling Theodosius from the door of his cathedral, the bishop is vested in the mitre and cope which only came into vogue centuries later, while the emperor wears a military costume modelled on that of Roman imperators of an earlier day. Even in portraiture, however, a certain conservatism tends to make the record untrustworthy; thus, great men continued to be painted in full armour long after it had in fact ceased to be worn.

Of authorities for English costume the following may be selected as especially useful: J. C. Bruce, *The Bayeux Tapestry Flucidated* (London, 1856), with 17 plates; F. W. Fairholt, *Costume in England to the end of the 18th Century* (2nd ed., *ib.*, 1860); William Fowler, *Examples of Medieval Art* (1796–1829), 116 plates; Froissart's *Chronicles*, translated by T. Johnes (4 vols., 1844), 72 plates and many woodcuts; R. N. Humphrey, *Illuminated Books of the Middle Ages* (*ib.*, 1849); *Facsimiles of Original Drawings by Holbein, in the Collection of His Majesty, for Portraits of Persons of the Court of Henry VIII.*, engraved by F. Bartolozzi, &c. (London, 1884); John Nichols, *Progresses, Pageants, &c., of Queen Elizabeth* (3 vols., 1823), and of James I. (4 vols., 1828), with numerous plates; Hogarth's *Works*, engraved by himself, with descriptions by J. Nichols (1822), 153 plates; Edmund Lodge, *Portraits of Illustrious Personages of Great Britain* (12 vols., 1823–1835), 240 plates; J. R. Planché, *Hist. of British Costume* (3rd ed., Bohn, 1874), and *Cyclopaedia of Costume* (2 vols., 1876–1877); Henry Shaw, *Dresses and Decorations of the Middle Ages* (2 vols., 1840–1843), 94 plates and many woodcuts; Joseph Strutt, engraver, *Dress and Habits of the People of England* (2 vols., 1796–1799), and *Regal and Ecclesiastical Antiquities of Great Britain*, new edition with notes by J. R. Planché (1842), 153 plates; Westwood, *Miniatures of Anglo-Saxon and Irish Manuscripts* (1868), 54 plates; C. A. Stothard, *The Monumental Effigies of Great Britain* (1817–1832; ed. Hewitt, 1876); Herbert Haines, *Manual of Monumental Brasses* (Oxford, 1861), with many woodcuts; J. G. and L. A. B. Waller, *A Series of Monumental Brasses* (London, 1864); H. Druitt, *Costume on Brasses* (London, 1906). Of foreign works on costume the most important are Hefner-Alteneck, *Trachten, &c., vom frühesten Mittelalter bis Ende des 18. Jahrhunderts* (2nd ed., Frankfurt, 1879–1890); Viollet-le-Duc, *Dictionnaire raisonné du mobilier français* (6 vols., Paris, 1858–1875), the first four volumes devoted to armour and costume; Friedrich Hottenroth, *Trachten der Völker alter und neuer Zeit* (2nd ed., Stuttgart, 1882–1890), with excellent plates, Fr. transl. by J. Bernhoff, *Les Costumes chez les peuples, &c.* (Paris, 1885), and *Handbuch der deutschen Tracht* (1898); Bonnard et Mercuri, *Costumes historiques des XII<sup>e</sup>, XIII<sup>e</sup>, XIV<sup>e</sup> et XV<sup>e</sup> siècles* (2 vols., Paris, 1867), 200 plates; Burgmair, *Triomphe de l'empereur Maximilien I.* (Vienna, 1796), 135 plates; Chapuy, *Le Moyen Âge pittoresque* (2 vols., 1837), 180 plates; Cheygnard et Duplessis, *Costumes historiques des XVI<sup>e</sup>, XVII<sup>e</sup> et XVIII<sup>e</sup> siècles* (2 vols., Paris, 1867), 150 plates; du Sommerard, *Les Arts au moyen âge* (10 vols., Paris, 1838–1848), 510 plates; Duflos, *Recueil d'estampes, représentant les grades, les rangs, et les dignités, suivant le costume de toutes les nations existantes* (Paris, 1779–1780), 240 plates; *España artística y monumental* (3 vols., Paris, 1842–1859), 145 plates; Fabri, *Raccolta di vari vestimenti ed arti del regno di Napoli* (Naples, 1773), 27 plates; Jaquemin, *Icomographie méthodique du costume du V<sup>e</sup> au XIX<sup>e</sup> siècle* (Paris), 200 plates; Lacombe, *Galerie de Florence et du palais Pitti* (4 vols., Paris, 1789–1807), 192 plates; Paul Lacroix, *Manners, Customs and Dress during the Middle Ages and the Renaissance*, Eng. trans. (London, 1874), *Military and Religious Life in the Middle Ages and the Renaissance* (London, 1874), and *The 18th Century, its Institutions, Customs, Costumes* (London, 1875–1876); L. M. Lanté, *Galerie française de femmes célèbres*, atlas (Paris, 1841), 70 plates; Malliot et Martin, *Recherches sur les costumes, les mœurs, les usages religieux, civils et militaires des anciens peuples* (3 vols., Paris, 1809), 228 plates; Pauly, *Description ethnographique des peuples* (St Petersburg, 1862); Pauquet Frères, *Modes et costumes historiques et étrangers*

(2 vols., Paris, 1873), 196 plates; Auguste Racinet, *Le Costume historique*, in two forms, large and small (Paris, 1876, another ed. in 6 vols., with 500 plates, 1888); G. M. Straub, *Trachten oder Stammbuch* (1600), several hundreds of curious woodcuts of costumes; Vecellio, *Habiti antichi et moderni di tutto il mondo* (3 vols., Venice, 1859-1863).

Examples and illustrations of early costume of great interest and value may be found in the *Archæologia*, M. Didron's *Annales archéologiques*, the *Journals* of the Archaeological Societies, the various county histories, the *Monumenta Vetusta of the London Society of Antiquaries*, and other kindred works.

Besides works on costume generally, there are a large number devoted specially to national or "folk" costumes. Of these may be mentioned: F. Hottenroth, *Deutsche Volkstrachten, städtische und ländliche, vom XVI. Jahrhundert bis zum Anfange des XIX. Jahrhunderts* (Frankfort, 1898, 1900, 1902, &c.), including German, Bohemian, Swiss and Dutch local costumes, with references to further works; L. M. Lanté, *Costume de divers pays* (undated, c. 1825), 177 coloured plates of female costumes, mainly French, some Spanish, German, &c.; A. Hård, *Swedish Costumes* (Stockholm, 1858), 10 coloured plates; Félix Benoist, *La Normandie illustrée* (2 vols. fol., Nantes, 1854), with excellent coloured lithographs of costumes by Hyppolite Lalaine; E. H. T. Pingret, *Galerie royale de costumes* (Paris, undated), beautiful lithographs of costumes, principally Italian with some Spanish and Swiss, lithographed from paintings by Pingret by various artists; Edward Harding, *Costume of the Russian Empire* (London, 1811), with 70 hand-coloured plates, including costumes of many of the semi-barbaric tribes of central Asia; for Turkish costume in the 18th century see *Recueil de cent estampes représentant différentes nations du Levant*, engraved by Le Hay (Paris, 1714); for Greek costume at the time of the War of Independence see Baron O. M. von Stackelberg, *Costumes et usages des peuples de la Grèce moderne* (Rome, 1825), with 30 beautiful plates. For Highland costume see R. R. Macfan, *Costumes of the Clans* (Glasgow, 1899), with letterpress by J. Logan.

**COSWAY, RICHARD** (c. 1742-1821), English miniature painter, was baptized in 1742; his father was master of Blundell's school, Tiverton, where Cosway was educated, and his uncle mayor of that town. He it was who, in conjunction with the boy's godfather, persuaded the father to allow Richard to proceed to London before he was twelve years old, to take lessons in drawing, and undertook to support him there. On his arrival, the youthful artist won the first prize given by the newly founded Society of Arts, of the money value of five guineas. He went to Thomas Hudson for his earliest instruction, but remained with him only a few months, and then attended William Shipley's drawing class, where he remained until he began to work on his own account in 1760. He was one of the earliest members of the Royal Academy, Associate in 1770 and Royal Academician in 1771. His success in miniature painting is said to have been started by his clever portrait of Mrs Fitzherbert, which gave great satisfaction to the prince of Wales, and brought Cosway his earliest great patron. He speedily became one of the most popular artists of the day, and his residence at Schomberg House, Pall Mall, was a well-known aristocratic rendezvous. In 1791 he removed to Stratford Place, where he lived in a state of great magnificence till 1821, when after selling most of the treasures he had accumulated he went to reside in Edgware Road. He died on the 4th of July 1821, when driving in a carriage with his friend Miss Udney. He was buried in Marylebone New church.

He married in 1781 Maria Hadfield, who survived him many years, and died in Italy in January 1838, in a school for girls which she had founded, and which she had attached to an important religious order devoted to the cause of female education, known as the Dame Inglesi. She had been created a baroness of the Empire on account of her devotion to female education by the emperor Francis I. in 1834. Her college still exists, and in it are preserved many of the things which had belonged to her and her husband.

Cosway had one child who died young. She is the subject of one of his most celebrated engravings. He painted miniatures of very many members of the royal family, and of the leading persons who formed the court of the prince regent. Perhaps his most beautiful work is his miniature of Madame du Barry, painted in 1791, when that lady was residing in Bruton Street, Berkeley Square. This portrait, together with many other splendid works by Cosway, came into the collection of Mr J. Pierpont Morgan. There are many miniatures by this artist in

the royal collection at Windsor Castle, at Belvoir Castle and in other important collections. His work is of great charm and of remarkable purity, and he is certainly the most brilliant miniature painter of the 18th century.

For a full account of the artist and his wife, see *Richard Cosway, R.A.*, by G. C. Williamson (1905). (G. C. W.)

**COTA DE MAGUAQUE, RODRIGO** (d. c. 1498), Spanish poet, who flourished towards the end of the 15th century, was born at Toledo. Little is known of him save that he was of Jewish origin. The *Coplas de Mingo Revulgo*, the *Coplas del Provincial*, and the first act of the *Celestina* have been ascribed to him on insufficient grounds. He is undoubtedly the author of the *Dialogo entre el amor y un viejo*, a striking dramatic poem first printed in the *Cancionero general* of 1511, and of a burlesque epithalamium written in 1472 or later. He abjured Judaism about the year 1497, and is believed to have died shortly afterwards.

See "Épithalame burlesque," edited by R. Foulché-Delbosc, in the *Revue hispanique* (Paris, 1894), i. 69-72; A. Bonilla y San Martín, *Anales de la literatura española* (Madrid, 1904), pp. 164-167.

**CÔTE-D'OR**, a department of eastern France, formed of the northern region of the old province of Burgundy, bounded N. by the department of Aube, N.E. by Haute-Marne, E. by Haute-Saône and Jura, S. by Saône-et-Loire, and W. by Nièvre and Yonne. Area, 3392 sq. m. Pop. (1906) 357,959. A chain of hills named the Plateau de Langres runs from north-east to south-west through the centre of the department, separating the basin of the Seine from that of the Saône, and forming a connecting-link between the Cévennes and the Vosges mountains. Extending southward from Dijon is a portion of this range which, on account of the excellence of its vineyards, bears the name of Côte-d'Or, whence that of the department. The north-west portion of the department is occupied by the calcareous and densely-wooded district of Châtillonais, the south-west by spurs of the granitic chain of Morvan, while a wide plain traversed by the Saône extends over the eastern region. The Châtillonais is watered by the Seine, which there takes its rise, and by the Ource, both fed largely by the *doux* or abundant springs characteristic of Burgundy. The Armançon and other affluents of the Yonne, and the Arroux, a tributary of the Loire, water the south-west.

The climate of Côte-d'Or is temperate and healthy; the rainfall is abundant west of the central range, but moderate, and, in places, scarce, in the eastern plain. Husbandry flourishes, the wealth of the department lying chiefly in its vineyards, especially those of the Côte-d'Or, which comprise the three main groups of Beaune, Nuits and Dijon, the latter the least renowned of the three. The chief cereals are wheat, oats and barley; potatoes, hops, beetroot, rape-seed, colza and a small quantity of tobacco are also produced. Sheep and cattle-raising is carried on chiefly in the western districts. The department has anthracite mines and produces freestone, lime and cement. The manufactures include iron, steel, nails, tools, machinery and other iron goods, paper, earthenware, tiles and bricks, morocco leather goods, biscuits and mustard, and there are flour-mills, distilleries, oil and vinegar works and breweries. The imports of the department are inconsiderable, coal alone being of any importance; there is an active export trade in wine, brandy, cereals and live stock and in manufactured goods. The Paris-Lyon-Méditerranée railway serves the department, its main line passing through Dijon. The canal of Burgundy, connecting the Saône with the Yonne, has a length of 94 m. in the department, while that from the Marne to the Saône has a length of 24 m.

Côte-d'Or is divided into the arrondissements of Dijon, Beaune, Châtillon and Semur, with 36 cantons and 717 communes. It forms the diocese of the bishop of Dijon, and part of the archiepiscopal province of Lyons and of the 8th military region. Dijon is the seat of the educational circumscription (*académie*) and court of appeal to which the department is assigned. The more noteworthy places are Dijon, the capital, Beaune, Châtillon, Semur, Auxonne, Flavigny and Cîteaux, all separately treated. St Jean de Losne, at the extremity of the Burgundy canal, is famous for its brave and successful resistance in 1636 to an immense force of Imperialists. Châteauneuf has a château of the

15th century, St Seine-l'Abbaye, a fine Gothic abbey church, and Saulieu, a Romanesque abbey church of the 11th century. The château of Bussy Rabutin (at Bussy-le-Grand), founded in the 12th century, has an interesting collection of pictures made by Roger de Rabutin, comte de Bussy, who also rebuilt the château. Montbard, the birthplace of the naturalist Buffon, has a keep of the 14th century and other remains of a castle of the dukes of Burgundy. The remarkable Renaissance chapel (1536) of Pagny-le-Château, belonging to the château destroyed in 1768, contains the tomb of Jean de Vienne (d. 1455) and that of Jean de Longwy (d. 1460) and Jeanne de Vienne (d. 1472), with alabaster effigies. At Fontenay, near Marmagne, a paper-works occupies the buildings of a well-preserved Cistercian abbey of the 12th century. At Vertault there are remains of a theatre and other buildings marking the site of the Gallo-Roman town of Vertilium.

**COTES, ROGER** (1682-1716), English mathematician and philosopher, was born on the 10th of July 1682 at Burbage, Leicestershire, of which place his father, the Rev. Robert Cotes, was rector. He was educated at Leicester school, and afterward at St Paul's school, London. Proceeding to Trinity College, Cambridge, in 1699, he obtained a fellowship in 1705, and in the following year was appointed Plumian professor of astronomy and experimental philosophy in the university of Cambridge. He took orders in 1713; and the same year, at the request of Dr Richard Bentley, he published the second edition of Newton's *Principia* with an original preface. He died on the 5th of June 1716, leaving unfinished a series of elaborate researches on optics, and a large amount of unpublished manuscript. He contributed two memoirs to the *Philosophical Transactions*, one, "Logometria," which discusses the calculation of logarithms and certain applications of the infinitesimal calculus, the other, a "Description of the great fiery meteor seen on March 6th, 1716." After his death his papers were collected and published by his cousin and successor in the Plumian chair, Dr Robert Smith, under the title *Harmonia Mensurarum* (1722). This work included the "Logometria," the trigonometrical theorem known as "Cotes' Theorem on the Circle" (see TRIGONOMETRY), his theorem on harmonic means, subsequently developed by Colin Maclaurin, and a discussion of the curves known as "Cotes' Spirals," which occur as the path of a particle described under the influence of a central force varying inversely as the cube of the distance. In 1738 Dr Robert Smith published Cotes' *Hydrostatical and Pneumatical Lectures*, a work which was held in great estimation. The exceptional genius of Cotes earned encomiums from both his contemporaries and successors; Sir Isaac Newton said, "If Mr Cotes had lived, we should have known something."

**CÔTES-DU-NORD**, a maritime department of the north-west of France, formed in 1790 from the northern part of the province of Brittany, and bounded N. by the English Channel, E. by the department of Ille-et-Vilaine, S. by Morbihan, and W. by Finistère. Pop. (1906) 611,506. Area, 2786 sq. m. In general conformation, Côtes-du-Nord is an undulating plateau including in its more southerly portion three well-marked ranges of hills. A granitic chain, the Monts du Méné, starting in the south-east of the department runs in a north-westerly direction, forming the watershed between the rivers running respectively to the Channel and the Atlantic Ocean. Towards its western extremity this chain bifurcates to form the Montagnes Noires in the south-west and the Montagne d'Arrée in the west of the department. The rivers of the Channel slope are the Rance, Arguenon, Gouessant, Gouet, Trieux, Tréguier and Léguer, while the Blavet, Meu, Oust and Aulne belong to the southern slope. Off the coast, which is steep, rocky and much indented, are the Sept-Iles, Bréhat and other small islands. The principal bays are those of St Malo and St Briec.

The climate is mild and not subject to extremes; in the west it is especially humid. Agriculture is more successful on the coast, where seaweed can be used as a fertilizer, than in the interior. Cereals are largely grown, wheat, oats and buck-wheat being the chief crops. Potatoes, flax, mangels, apples, plums, cherries and honey are also produced. Pasture and various kinds of forage are abundant, and there is a large output of milk and butter.

The horses of the department are in repute. It produces slate, building-stone, lime and china-clay. Flour-mills, saw-mills, sardine factories, tanneries, iron-works, manufactories of polish, boat-building yards, and rope-works employ many of the inhabitants, and cloth, agricultural implements and nails are manufactured. The chief imports are coal, wood and salt. Exports include agricultural products (eggs, butter, vegetables, &c.), horses, flax and fish. The chief commercial ports are Le Légué and Paimpol; and Paimpol also equips a large fleet for the Icelandic fisheries. The coast fishing is important and large quantities of sardines are preserved. The department is served by the Ouest-État railway; its chief waterway is the canal from Nantes to Brest which traverses it for 73 m.

Côtes-du-Nord is divided into the five arrondissements of St Briec, Dinan, Guingamp, Lannion and Loudéac, which contain 48 cantons and 390 communes. Bas Breton is spoken in the arrondissements of Guingamp and Lannion, and in part of those of Loudéac and St Briec. The department belongs to the ecclesiastical province, the académie (educational division), and the appeal court of Rennes, and in the region of the X. army corps. St Briec, Dinan, Guingamp, Lamballe, Paimpol and Tréguier, the more noteworthy towns, are separately treated. Extensive remains of an abbey of the Premonstratensian order, dating chiefly from the 13th century, exist at Kerity; and Lehon has remains of a priory, which dates from the same period. The department is rich in interesting churches, among which those of Ploubezre (12th, 14th and 16th centuries), Perros-Guirec (12th century), Plestin-les-Grèves (16th century) and Lanleff (12th century) may be mentioned. The church of St Mathurin at Moncontour, which is a celebrated place of pilgrimage, contains fine stained glass of the 16th century, and the mural paintings of the chapel of Kermaria-an-Isquit near Plouha, which belongs to the 13th and 14th centuries, are celebrated. Near Lannion (pop. 5336), itself a picturesque old town, is the ruined castle of Tonquédec, built in the 14th century and sometimes known as "the Pierrefonds of Brittany," owing to its resemblance to the more famous castle. At Corseul are a temple and other Roman remains.

**COTGRAVE, RANDLE** (?-1634), English lexicographer, came of a Cheshire family, and was educated at Cambridge, entering St John's College in 1587. He became secretary to Lord Burghley, and in 1611 published his French-English dictionary (2nd ed., 1632), a work of real historical importance in lexicography, and still valuable in spite of such errors as were due to contemporary want of exact scholarship.

**CÖTHEN**, or KÖTHEN, a town of Germany, in the duchy of Anhalt on the Ziethe, at the junction of several railway lines, 42 m. N.W. of Leipzig by rail. Pop. (1905) 22,978. It consists of an old and a new town with four suburbs. The former palace of the dukes of Anhalt-Cöthen, in the old town, has fine gardens and contains collections of pictures and coins, the famous ornithological collection of Johann Friedrich Naumann (1780-1857), and a library of some 20,000 volumes. Of the churches the Lutheran Jakobskirche (called the cathedral), a Gothic building with some fine old stained glass, is noteworthy. Besides the usual classical and modern schools (Gymnasium and Realschule) Cöthen possesses a technical institute, a school of gardening and a school of forestry. The industries include iron-founding and the manufacture of agricultural and other machinery, malt, beet-root sugar, leather, spirits, &c.; a tolerably active trade is carried on in grain, wool, potatoes and vegetables. Among others, there is a monument to Sebastian Bach, who was music director here from 1717 to 1723.

In the 10th century Cöthen was a Slav settlement, which was captured and destroyed by the German king Henry I. in 927. By the 12th century it had secured town rights and become a considerable centre of trade in agricultural produce. In 1300 it was burned by the margrave of Meissen. In 1547 the town was taken from its prince, Wolfgang (a cadet of the house of Anhalt), who had joined the league of Schmalkalden, and given by the emperor Charles V., with the rest of the prince's possessions, to the Spanish general and painter, Felipe Ladron y Guevara



(1510-1563), from whom it was, however, soon repurchased. Hahnemann, the founder of homoeopathy, lived and worked in Cöthen. From 1603 to 1847 Cöthen was the capital of the principality, later duchy, of Anhalt-Cöthen.

**COTMAN, JOHN SELL** (1782-1842), English landscape-painter and etcher, son of a well-to-do silk mercer, was born at Norwich on the 16th of May 1782. He showed a talent for art and was sent to London to study, where he became the friend of Turner, T. Girtin and other artists. He first exhibited at the Royal Academy in 1800. In 1807 he went back to Norwich and joined the Norwich Society of Artists, of which in 1811 he became president. In 1825 he was made an associate of the Society of Painters in Water-colours; in 1834 he was appointed drawing-master at King's College, London; and in 1836 he was elected a member of the Institute of British Architects. He died in London on the 24th of July 1842. Cotman's work was not considered of much importance in his own day, and his pictures only procured small prices; but he now ranks as one of the great figures of the Norwich school. He was a fine draughtsman, and a remarkable painter both in oil and water-colour. One of his paintings is in the National Gallery. His fine architectural etchings, published in a series of volumes, the result of tours in Norfolk and Normandy, are valuable records of his interest in archaeology. He married early in life, and had five children, his sons, Miles Edmund (1810-1858) and Joseph John (1814-1878), both becoming landscape-painters of merit; and his younger brother Henry's son, Frederic George Cotman (b. 1850), the water-colour artist, continued the family reputation.

**COTONEASTER**, a genus of the rose family (Rosaceae), containing about twenty species of shrubs and small trees, natives of Europe, North Africa and temperate Asia. *C. vulgaris* is native on the limestone cliffs of the Great Orme in North Wales. Several species are grown in shrubberies and borders, or as wall plants, mainly for their clusters of bright red or yellow berry-like fruits. Plants are easily raised by seeds, cuttings or layers, and grow well in ordinary soil.

**COTOPAXI**, a mountain of the Andes, in Ecuador, South America, 35 m. S.S.E. of Quito, remarkable as the loftiest active volcano in the world. The earliest outbursts on record took place in 1532 and 1533; and since then the eruptions have been both numerous and destructive. Among the most important are those of 1744, 1746, 1766, 1768 and 1803. In 1744 the thunderings of the volcano were heard at Honda on the Rio Magdalena, about 500 m. distant; in 1768 the quantity of ashes ejected was so great that it covered all the lesser vegetation as far as Riobamba; and in 1803 Humboldt reports that at the port of Guayaquil, 160 m. from the crater, he heard the noise day and night like continued discharges of a battery. There were considerable outbursts in 1851, 1855, 1856, 1864 and 1877. In 1802 Humboldt made a vain attempt to scale the cone, and pronounced the enterprise impossible; and the failure of Jean Baptiste Boussingault in 1831, and the double failure of M. Wagner in 1858, seemed to confirm his opinion. In 1872, however, Dr Wilhelm Reiss succeeded on the 27th and 28th of November in reaching the top; in the May of the following year the same feat was accomplished by Dr A. Stübel, and he was followed by T. Wolf in 1877, M. von Thielmann in 1878 and Edward Whympfer in 1880.

Cotopaxi is frequently described as one of the most beautiful mountain masses of the world, rivalling the celebrated Fujiyama of Japan in its symmetry of outline, but overtopping it by more than 7000 ft. It is more than 15,000 ft. higher than Vesuvius, over 7000 ft. higher than Teneriffe, and nearly 2000 ft. higher than Popocatepetl. Its slope, according to Orton, is 30°, according to Wagner 29°, the north-western side being slightly steeper than the south-eastern. The apical angle is 122° 30'. The snowfall is heavier on the eastern side of the cone which is permanently covered, while the western side is usually left bare, a phenomenon occasioned by the action of the moist trade winds from the Atlantic. Its height according to Whympfer is 19,613 ft., and its crater is 2300 ft. in diameter from N. to S., 1650 ft. from E. to W., and has an approximate depth of 1200 ft.

It is bordered by a rim of trachytic rock, forming a black coronet above the greyish volcanic dust and sand which covers its sides to a great depth. Whympfer found snow and ice under this sand. On the southern slope, at a height of 15,059 ft., is a bare cone of porphyritic andesite called *El Picacho*, "the beak," or *Cabeza del Inca*, "the Inca's head," with dark cliffs rising fully 1000 ft., which according to tradition is the original summit of the volcano blown off at the first-known eruption of 1532. The summit of Cotopaxi is usually enveloped in clouds; and even in the clearest month of the year it is rarely visible for more than eight or ten days. Its eruptions produce enormous quantities of pumice, and deep layers of mud, volcanic sand and pumice surround it on the plateau. Of the air currents about and above Cotopaxi, Wagner says (*Naturw. Reisen im trop. Amerika*, p. 514): "On the Tacunga Plateau, at a height of 8000 Paris feet, the prevailing direction of the wind is meridional, usually from the south in the morning, and frequently from the north in the evening; but over the summit of Cotopaxi, at a height of 18,000 ft., the north-west wind always prevails throughout the day. The gradually-widening volcanic cloud continually takes a south-eastern direction over the rim of the crater; at a height, however, of about 21,000 ft. it suddenly turns to the north-west, and maintains that direction till it reaches a height of at least 28,000 ft. There are thus from the foot of the volcano to the highest level attained by its smoke-cloud three quite distinct regular currents of wind."

**COTRONE** (anc. *Croto*, *Crotona*), a seaport and episcopal see on the E. coast of Calabria, Italy, in the province of Catanzaro, 37 m. E.N.E. of Catanzaro Marina by rail, 143 ft. above sea-level. Pop. (1901) town, 7917; commune, 9545. It has a castle erected by the emperor Charles V. and a small harbour, which even in ancient times was not good, but important as the only one between Taranto and Reggio. It exports a considerable quantity of oranges, olives and liquorice.

**COTTA**, the name of a family of German publishers, intimately connected with the history of German literature. The Cottas were of noble Italian descent, and at the time of the Reformation the family was settled in Eisenach in Thuringia.

JOHANN GEORG COTTA (1) (1631-1692), the founder of the publishing house of J. G. Cotta, married in 1659 the widow of the university bookseller, Philipp Braun, in Tübingen, and took over the management of his business, thus establishing the firm which was subsequently associated with Cotta's name. On his death, in 1692, the undertaking passed to his only son, Johann Georg (2); and on his death in 1712, to the latter's eldest son, also named Johann Georg (3), while the second son, Johann Friedrich (see below), became the distinguished theologian.

Although the eldest son of Johann Georg (3), Christoph Friedrich Cotta (1730-1807), established a printing-house to the court at Stuttgart, the business languished, and it was reserved to his youngest son, JOHANN FRIEDRICH, FREIHERR COTTA VON COTTENDORF (1764-1832), who was born at Stuttgart on the 27th of April 1764, to restore the fortunes of the firm. He attended the gymnasium of his native place, and was originally intended to study theology. He, however, entered the university of Tübingen as a student of mathematics and law, and after graduating spent a considerable time in Paris, studying French and natural science, and mixing with distinguished literary men. After practising as an advocate in one of the higher courts, Cotta, in compliance with his father's earnest desire, took over the publishing business at Tübingen. He began in December 1787, and laboured incessantly to acquire familiarity with all the details. The house connexions rapidly extended; and, in 1794, the *Allgemeine Zeitung*, of which Schiller was to be editor, was planned. Schiller was compelled to withdraw on account of his health; but his friendship with Cotta deepened every year, and was a great advantage to the poet and his family. Cotta awakened in Schiller so warm an attachment that, as Heinrich Döring tells us in his life of Schiller (1824), when a bookseller offered him a higher price than Cotta for the copyright of *Wallenstein*, the poet firmly declined it, replying "Cotta deals honestly with me, and I with him." In 1795 Schiller and Cotta founded

the *Horen*, a periodical very important to the student of German literature. The poet intended, by means of this work, to infuse higher ideas into the common lives of men, by giving them a nobler human culture, and "to reunite the divided political world under the banner of truth and beauty." The *Horen* brought Goethe and Schiller into intimate relations with each other and with Cotta; and Goethe, while regretting that he had already promised *Wilhelm Meister* to another publisher, contributed the *Unterhaltung deutscher Ausgewanderten*, the *Roman Elegies* and a paper on Literary Sansculottism. Fichte sent essays from the first, and the other brilliant German authors of the time were also represented. In 1798 the *Allgemeine Zeitung* appeared at Tübingen, being edited first by Posselt and then by Huber. Soon the editorial office of the newspaper was transferred to Stuttgart, in 1803 to Ulm, and in 1810 to Augsburg; it is now in Munich. In 1799 Cotta entered on his political career, being sent to Paris by the Württemberg estates as their representative. Here he made friendships which proved very advantageous for the *Allgemeine Zeitung*. In 1801 he paid another visit to Paris, also in a political capacity, when he carefully studied Napoleon's policy, and treasured up many hints which were useful to him in his literary undertakings. He still, however, devoted most of his attention to his own business, and, for many years, made all the entries into the ledger with his own hand. He relieved the tedium of almost ceaseless toil by pleasant intercourse with literary men. With Schiller, Huber, and Gottlieb Konrad Pfeffel (1736-1809) he was on terms of the warmest friendship; and he was also intimate with Herder, Schelling, Fichte, Richter, Voss, Hebel, Tieck, Therese Huber, Matthiesson, the brothers Humboldt, Johann Müller, Spittler and others, whose works he published in whole or in part. In the correspondence of Alexander von Humboldt with Varnhagen von Ense we see the familiar relations in which the former stood to the Cotta family. In 1795 he published the *Politischen Annalen* and the *Jahrbücher der Baukunde*, and in 1798 the *Damenalmanach*, along with some works of less importance. In 1807 he issued the *Morgenblatt*, to which Schorn's *Kunstblatt* and Menzel's *Literaturblatt* were afterwards added. In 1810 he removed to Stuttgart; and from that time till his death he was loaded with honours. State affairs and an honourable commission from the German booksellers took him to the Vienna congress; and in 1815 he was deputy-elect at the Württemberg diet. In 1819 he became representative of the nobility; then he succeeded to the offices of member of committee and (1824) vice-president of the Württemberg second chamber. He was also appointed Prussian *Geheimrat*, and knight of the order of the Württemberg crown; King William I. of Württemberg having already revived the ancient nobility in his family by granting him the patent of Freiherr (Baron) Cotta von Cottendorf. Meanwhile such publications as the *Polytechnische Journal*, the *Hesperus*, the *Württembergische Jahrbücher*, the *Hertha*, the *Ausland*, and the *Inland* issued from the press. In 1828-1829 appeared the famous correspondence between Schiller and Goethe. Cotta was an unflinching friend of young struggling men of talent. In addition to his high standing as a publisher, he was a man of great practical energy, which flowed into various fields of activity. He was a scientific agriculturist, and promoted many reforms in farming. He was the first Württemberg landholder to abolish serfdom on his estates. In politics he was throughout his life a moderate liberal. In 1824 he set up a steam printing press in Augsburg, and, about the same time, founded a literary institute at Munich. In 1825 he started steamboats, for the first time, on Lake Constance, and introduced them in the following year on the Rhine. In 1828 he was sent to Berlin, on an important commission, by Bavaria and Württemberg, and was there rewarded with orders of distinction at the hands of the three kings. He died on the 29th of December 1832 leaving a son and a daughter as coheirs.

His son, JOHANN GEORG (4), FREIHERR COTTA VON COTTENDORF (1796-1863), succeeded to the management of the business on the death of his father, and was materially assisted by his sister's husband, Freiherr Hermann von Reischach. He greatly extended the connexions of the firm by the purchase, in 1839, of

the publishing business of G. J. Göschen in Leipzig, and in 1845 of that of Vogel in Landshut; while, in 1845, "Bible" branches were established at Stuttgart and Munich. He was succeeded by his younger son, Karl, and by his nephew (the son of his sister), Hermann Albert von Reischach. Under their joint partnership, the before-mentioned firms in Leipzig and Landshut, and an artistic establishment in Munich passed into other hands, leaving on the death of Hermann Albert von Reischach, in 1876, Karl von Cotta the sole representative of the firm, until his death in 1888. In 1889 the firm of J. G. Cotta passed by purchase into the hands of Adolf and Paul Kröner, who took others into partnership. In 1899 the business was converted into a limited liability company.

See Albert Schäffle, *Cotta* (1895); *Verlags-Katalog der J. G. Cotta'schen Buchhandlung, Nachfolger* (1900); and Lord Goschen's *Life and Times of G. J. Göschen* (1903).

JOHANN FRIEDRICH COTTA (1701-1779), the theologian, was born on the 12th of March 1701, the son of Johann Georg Cotta (2). After studying theology at Tübingen he began his public career as lecturer in Jena University. He then travelled in Germany, France and Holland, and, after residing several years in London, became professor at Tübingen in 1733. In 1736 he removed to the chair of theology in the university of Göttingen, which had been instituted as a seat of learning, two years before, by George II. of England, in his capacity as elector of Hanover. In 1739, however, he returned, as extraordinary professor of theology, to his Alma Mater, and, after successively filling the chairs of history, poetry and oratory, was appointed ordinary professor of theology in 1741. Finally he died, as chancellor of Tübingen University, on the 31st of December 1779. His learning was at once wide and accurate; his theological views were orthodox, although he did not believe in strict verbal inspiration. He was a voluminous writer. His chief works are his edition of Johann Gerhard's *Loci Theologici* (1762-1777), and the *Kirchenhistorie des Neuen Testaments* (1768-1773).

COTTA, BERNHARD VON (1808-1879), German geologist, was born in a forester's lodge near Eisenach, on the 24th of October 1808. He was educated at Freiberg and Heidelberg, and from 1842 to 1874 he held the professorship of geology in the Bergakademie of Freiberg. Botany at first attracted him, and he was one of the earliest to use the microscope in determining the structure of fossil plants. Later on he gave his attention to practical geology, to the study of ore-deposits, of rocks and metamorphism; and he was regarded as an excellent teacher. His *Rocks classified and described: a Treatise on Lithology* (translated by P. H. Lawrence, 1866) was the first comprehensive work on the subject issued in the English language, and it gave great impetus to the study of rocks in Britain. He died at Freiberg on the 14th of September 1879.

PUBLICATIONS.—*Geognostische Wanderungen* (1836-1838); *Grundriss der Geognosie und Geologie* (1846); *Geologische Briefe aus den Alpen* (1850); *Praktische Geologie* (1852); *Geologische Bilder* (1852, ed. 4, 1861); *Die Gesteinslehre* (1855, ed. 2, 1862).

COTTA, GAIUS AURELIUS (c. 124-73 B.C.), Roman statesman and orator. In 92 he defended his uncle P. Rutilius Rufus, who had been unjustly accused of extortion in Asia. He was on intimate terms with the tribune M. Livius Drusus, who was murdered in 91, and in the same year was an unsuccessful candidate for the tribunate. Shortly afterwards he was prosecuted under the *lex Varia*, directed against all who had in any way supported the Italians against Rome, and, in order to avoid condemnation, went into voluntary exile. He did not return till 82, during the dictatorship of Sulla. In 75 he was consul, and excited the hostility of the optimates by carrying a law that abolished the Sullan disqualification of the tribunes from holding higher magistracies; another law *de judiciis privatis*, of which nothing is known, was abrogated by his brother. In 74 Cotta obtained the province of Gaul, and was granted a triumph for some victory of which we possess no details; but on the very day before its celebration an old wound broke out, and he died suddenly. According to Cicero, P. Sulpicius Rufus and Cotta were the best speakers of the young men of their time. Physically incapable of rising to passionate heights of oratory, Cotta's

successes were chiefly due to his searching investigation of facts; he kept strictly to the essentials of the case and avoided all irrelevant digressions. His style was pure and simple. He is introduced by Cicero as an interlocutor in the *De oratore* and *De natura deorum* (iii.), as a supporter of the principles of the New Academy. The fragments of Sallust contain the substance of a speech delivered by Cotta in order to calm the popular anger at a deficient corn-supply.

See Cicero, *De oratore*, iii. 3, *Brutus*, 49, 55, 90, 92; Sallust, *Hist. Frag.*; Appian, *Bell. Civ.* i. 37.

His brother, LUCIUS AURELIUS COTTA, when praetor in 70 B.C. brought in a law for the reform of the jury lists, by which the judices were to be eligible, not from the senators exclusively as limited by Sulla, but from senators, equites and *tribuni aerarii*. One-third were to be senators, and two-thirds men of equestrian census, one-half of whom must have been *tribuni aerarii*, a body as to whose functions there is no certain evidence, although in Cicero's time they were reckoned by courtesy amongst the equites. In 66 Cotta and L. Manlius Torquatus accused the consuls-elect for the following year of bribery in connexion with the elections; they were condemned, and Cotta and Torquatus chosen in their places. After the suppression of the Catilinarian conspiracy, Cotta proposed a public thanksgiving for Cicero's services, and after the latter had gone into exile, supported the view that there was no need of a law for his recall, since the law of Clodius was legally worthless. He subsequently attached himself to Caesar, and it was currently reported that Cotta (who was then quindecimvir) intended to propose that Caesar should receive the title of king, it being written in the books of fate that the Parthians could only be defeated by a king. Cotta's intention was not carried out in consequence of the murder of Caesar, after which he retired from public life.

See Cicero, Orelli's *Onomasticon*; Sallust, *Catiline*, 18; Suetonius, *Caesar*, 79; Livy, *Epit.* 97; Vell. Pat. ii. 32; Dio Cassius xxxvi. 44, xxxvii. 1.

**COTTABUS** (Gr. *κότταβος*), a game of skill for a long time in great vogue at ancient Greek drinking parties, especially in the 4th and 5th centuries B.C. It is frequently alluded to by the classical writers of the period, and not seldom depicted on ancient vases. The object of the player was to cast a portion of wine left in his drinking cup in such a way that, without breaking bulk in its passage through the air, it should reach a certain object set up as a mark, and there produce a distinct noise by its impact. Both the wine thrown and the noise made were called *λάταξ*. The thrower, in the ordinary form of the game, was expected to retain the recumbent position that was usual at table, and, in flinging the cottabus, to make use of his right hand only. To succeed in the aim no small amount of dexterity was required, and unusual ability in the game was rated as high as corresponding excellence in throwing the javelin. Not only was the cottabus the ordinary accompaniment of the festal assembly, but at least in Sicily a special building of a circular form was sometimes erected so that the players might be easily arranged round the basin, and follow each other in rapid succession. Like all games in which the element of chance found a place, it was regarded as more or less ominous of the future success of the players, especially in matters of love; and the excitement was sometimes further augmented by some object of value being staked on the event.

Various modifications of the original principle of the game were gradually introduced, but for practical purposes we may reckon two varieties. (1) In the *Κότταβος δι δξυβάφων* shallow saucers (*δέξυβαφα*) were floated in a basin or mixing-bowl filled with water; the object was to sink the saucers by throwing the wine into them, and the competitor who sank the greatest number was considered victorious, and received the prize, which consisted of cakes or sweetmeats. (2) *Κότταβος κατακτός*,<sup>1</sup> is not so easy to understand, although there is little doubt as to the apparatus. This consisted of a *ράβδος* or bronze rod; a *πλάστιγγξ*, a small disk or basin, resembling a scale-pan; a larger disk (*λεκανίς*); and (in-

<sup>1</sup>The epithet *κατακτός* (let down) may refer to the rod, which might be raised or lowered as required; to the lower disk, which might be moved up and down the stem; to the moving up and down of the scales, in the supposed variety of the game mentioned below.

most cases) a small bronze figure called *μάρις*. The discovery (by Professor Helbig in 1886) of two sets of actual apparatus near Perugia and various representations on vases help to elucidate the somewhat obscure accounts of the method of playing the game contained in the scholia and certain ancient authors who, it must not be forgotten, wrote at a time when the game itself had become obsolete, and cannot therefore be looked to for a trustworthy description of it.

The first specimen of the apparatus found at Perugia resembles a candelabrum on a base, tapering towards the top, with a blunt end, on which the small disk (found near the rod), which has a hole near the edge and is slightly hollow in the middle, could be balanced. At about a third of the height of the rod is a large disk with a hole in the centre through which the rod runs; in a socket at the top is a small bronze figure, with right arm and right leg uplifted. In the second specimen there is no large disk, and the figure is holding up what is apparently a rhyton or drinking-horn.

According to Prof. Helbig in *Mittheilungen des deutschen archäologischen Instituts* (Römische Abtheilung i., 1886) three games were played with this apparatus. In the first the smaller disk was placed on the top of the rod, and the object of the player was to dislodge it with a cast of the wine, so that it would fall with a clatter on the larger disk below. In the second (as in the third) the bronze figure was used; the smaller disk was placed above the figure, upon which it fell when hit, and thence on to the larger disk below. In the third, there was no smaller disk; the wine was thrown at the figure, and fell on to the larger disk underneath. Another supposed variety, in which two scales were balanced in such a manner that the weight of the liquid cast into either scale caused it to dip down and touch the top of an image placed under each, probably had no real existence, but is due to a confusion of the *πλάστιγγξ* with a scale-pan by reason of its shape. The game appears to have been of Sicilian origin, but it spread through Greece from Thessaly to Rhodes, and was especially fashionable at Athens. Dionysius, Alcaeus, Anacreon, Pindar, Bacchylides, Aeschylus, Sophocles, Euripides, Aristophanes, Antiphanes, make frequent and familiar allusion to the *κότταβος*; but in the writers of the Roman and Alexandrian period such reference as occurs shows that the fashion had died out. In Latin literature it is almost entirely unknown.

The most complete treatise on the subject is C. Sartori's *Das Kottabos-Spiel der alten Griechen* (1893), in which a full bibliography of ancient and modern authorities is given. English readers may be referred to an article by A. Higgins on "Recent Discoveries of the Apparatus used in playing the Game of Kottabos" (*Archaeologia*, li. 1888); see also "Kottabos" in Daremberg and Saglio's *Dictionnaire des antiquités*, and L. Becq de Fouquières, *Les Jeux des anciens* (1873).

**COTTBUS**, a town of Germany, in the kingdom of Prussia, on the Spree, 72 m. S.E. of Berlin by the main railway to Görlitz, and at the intersection of the lines Halle-Sagan and Grossenhain-Frankfort-on-Oder. Pop. (1905) 46,269. It has four Protestant churches, a Roman Catholic church and a synagogue. The chief industry of the town is the manufacture of cloth, which has flourished here for centuries and now employs more than 6000 hands. Wool-spinning, cotton-spinning and the manufacture of tobacco, machinery, beer, brandy, &c., are also carried on. The town is also a considerable trading centre, and is the seat of a chamber of commerce and of a branch of the Imperial Bank (*Reichsbank*). In the Stadtwald, close to the town, is a women's hospital for diseases of the lungs, a government institution in connexion with the state system of insurance against incapacity and old age. At Branitz, a neighbouring village, are the magnificent château and park of Prince Pückler-Muskau.

At one time Cottbus formed an independent lordship of the Empire, but in 1462 it passed by the treaty of Guben to Brandenburg. From 1807 to 1813 it belonged to the kingdom of Saxony.

**COTTENHAM**, CHARLES CHRISTOPHER PEPYS, 1ST EARL OF (1781-1851), lord chancellor of England, was born in London on the 29th of April 1781. He was the second son of Sir William W. Pepys, a master in chancery, who was descended from John Pepys, of Cottenham, Cambridgeshire, a great-uncle of Samuel Pepys, the diarist. Educated at Harrow and Trinity College,

Cambridge, Pepys was called to the bar at Lincoln's Inn in 1804. Practising at the chancery bar, his progress was extremely slow, and it was not till twenty-two years after his call that he was made a king's counsel. He sat in parliament, successively, for Higham Ferrars and Malton, was appointed solicitor-general in 1834, and in the same year became master of the rolls. On the formation of Lord Melbourne's second administration in April 1835, the great seal was for a time in commission, but eventually Pepys, who had been one of the commissioners, was appointed lord chancellor (January 1836) with the title of Baron Cottenham. He held office until the defeat of the ministry in 1841. In 1846 he again became lord chancellor in Lord John Russell's administration. His health, however, had been gradually failing, and he resigned in 1850. Shortly before his retirement he had been created Viscount Crowhurst and earl of Cottenham. He died at Pietra Santa, in the duchy of Lucca, on the 29th of April 1851.

Both as a lawyer and as a judge, Lord Cottenham was remarkable for his mastery of the principles of equity. An indifferent speaker, he nevertheless adorned the bench by the soundness of his law and the excellence of his judgments. As a politician he was somewhat of a failure, while his only important contribution to the statute-book was the Judgments Act 1838, which amended the law for the relief of insolvent debtors.

The title of earl of Cottenham descended in turn to two of the earl's sons, Charles Edward (1824-1863), and William John (1825-1881), and then to the latter's son, Kenelm Charles Edward (b. 1874).

**AUTHORITIES.**—Campbell, *Lives of the Lord Chancellors* (1869); E. Foss, *The Judges of England* (1848-1864); E. Manson, *Builders of our Law* (1904); J. B. Atlay, *The Victorian Chancellors* (1906).

**COTTER, COTTAR, or COTTIER**, a word derived from the Latin *cota*, a cot or cottage, and used to describe a man who occupies a cottage and cultivates a small plot of land. This word is often employed to translate the *colarius* of Domesday Book, a class whose exact status has been the subject of some discussion, and is still a matter of doubt. According to Domesday the *colarii* were comparatively few, numbering less than seven thousand, and were scattered unevenly throughout England, being principally in the southern counties; they were occupied either in cultivating a small plot of land, or in working on the holdings of the *villani*. Like the *villani*, among whom they were frequently classed, their economic condition may be described as "free in relation to every one except their lord."

See F. W. Maitland, *Domesday Book and Beyond* (Cambridge, 1897); and P. Vinogradoff, *Villainage in England* (Oxford, 1892).

**COTTESWOLD HILLS, or COTSWOLDS**, a range of hills in the western midlands of England. The greater part lies in Gloucestershire, but the system covered by the name also extends into Worcestershire, Warwickshire, Oxfordshire, Wiltshire and Somersetshire. It extends on a line from N.E. to S.W., forming a part of the great Oolitic belt extending through the English midlands. On the west the hills overlook the vales of Evesham, Gloucester and Berkeley (valleys of the Worcestershire Avon and the Severn), with a bold escarpment broken only by a few abrupt spurs, such as Bredon hill, between Tewkesbury and Evesham. On the east they slope more gently towards the basins of the upper Thames and the Bristol Avon. The watershed lies close to the western line, except where the Stroud valley, with the Frome, draining to the Severn, strikes deep into the heart of the hills. The principal valleys are those of the Windrush, Lech, Coln and Churn, feeders of the Thames, the Thames itself, and the Bristol Avon. The last, wherein lie Bath and Bristol, forms the southern boundary of the Cotswolds; the northern is formed by the valleys of the Evenlode (draining to the Thames) and the Stour (to the Worcestershire Avon), with the low divide between them. The crest-line from Bath to the south to Meon Hill at the north measures 57 m. The breadth varies from 6 m. in the south to 28 towards the north, and the area is some 300 sq. m. The features are those of a pleasant sequestered pastoral region, rolling plateaus or wolds and bare uplands alternating with deep narrow valleys, well wooded and traversed by shallow, rapid streams. The average elevation is about 600 ft., but Cleeve

Cloud above Cheltenham in the Vale of Gloucester reaches 1134 ft., and Broadway Hill, in the north, 1086 ft. These heights command splendid views over the rich vales towards the distant hills of Herefordshire and the Forest of Dean. The picturesque village of Broadway at the foot of the hill of that name is much in favour with artists.

In the soil of the hill country is so much lime that a liberal supply of manure is required. With this good crops of barley and oats are obtained, and even of wheat, if the soil is mixed with clay. But the poorest land of the hill country affords excellent pasturage for sheep, the staple commodity of the district; and the sainfoin, which grows wild, yields abundantly under cultivation. The Cotswolds have been famous for the breed of sheep named from them since the early part of the 15th century, a breed hardy and prolific, with lambs that quickly put on fleece, and become hardened to the bracing cold of the hills, where vegetation is a month later than in the vales. Improved by judicious crossing with the Leicester sheep, the modern Cotswold has attained high perfection of weight, shape, fleece and quality. An impulse was given to Cotswold farming by the chartering in 1845 of the Royal Agricultural College at Cirencester.

A number of small market-towns or large villages lie on the outskirts of the hills, but in the inner parts of the district villages are few. The "capital of the Cotswolds" is Cirencester, in the east. In the north is Chipping Campden, its great Perpendicular church and the picturesque houses of its wide street commemorating the wealth of its wool-merchants between the 14th and 17th centuries. Near this town, in the parish of Weston-sub-Edge, Robert Dover, an attorney, founded the once famous Cotswold games early in the 17th century. Horse-racing and coursing were included with every sort of athletic exercise from quoits and skittles to wrestling, cudgels and singlestick. The games were suppressed by act of parliament in 1851.

See *Proceedings of the Cotswold Naturalists' Field Club, passim*; W. H. Hutton, *By Thames and Cotswold* (London, 1903).

**COTTET, CHARLES** (1863- ), French painter, was born at Puy. He studied at the École des Beaux-Arts, and under Puvis de Chavannes and Roll. He travelled and painted in Egypt, Italy, and on the Lake of Geneva, but he made his name with his sombre and gloomy, firmly designed, severe and impressive scenes of life on the Brittany coast. His signal success was achieved by his painting of the triptych, "*Au pays de la mer*," now at the Luxembourg museum. The Lille gallery has his "Burial in Brittany."

**COTTII REGNUM**, a district in the north of Liguria, including a considerable part of the important road which led over the pass (6119 ft.) of the Alpis Cottia (Mont Genève) into Gaul. Whether Hannibal crossed the Alps by this route is disputed, but it was certainly in use about 100 B.C. (see PUNIC WARS). In 58 B.C. Caesar met with some resistance on crossing it, but seems afterwards to have entered into friendly relations with Donnus, the king of the district; he must have used it frequently, and refers to it as the shortest route. Donnus's son Cottius erected the triumphal arch at his capital Segusio, the modern Susa, in honour of Augustus. Under Nero, after the death of the last Cottius, it became a province under the title of "Alpes Cottiae," being governed by a *procurator Augusti*, though it still kept its old name also.

**COTTIN, MARIE** [called SOPHIE] (1770-1807), French novelist, née Risteau (not Ristaud), was born in Paris in 1770. At seventeen she married a Bordeaux banker, who died three years after, when she retired to a house in the country at Champlan, where she spent the rest of her life. In 1799 she published anonymously her *Claire d'Albe*. *Malvina* (1801) was also anonymous; but the success of *Amélie Mansfield* (1803) induced her to reveal her identity. In 1805 appeared *Mathilde*, an extravagant crusading story, and in 1806 she produced her last tale, the famous *Élisabeth, ou les exilés de Sibérie*, the subject of which was treated later with an admirable simplicity by Xavier de Maistre. Sainte-Beuve asserted that she committed suicide on account of an unfortunate attachment. This story is, however,

unauthenticated. She died at Champlan (Seine et Oise) on the 25th of April 1807.

A complete edition of her works, with a notice by A. Petitot, was published, in five volumes, in 1817.

**COTTINGTON, FRANCIS COTTINGTON, BARON** (1578–1652), English lord treasurer and ambassador, was the fourth son of Philip Cottington of Godmonston in Somersetshire. According to Hoare, his mother was Jane, daughter of Thomas Biflete, but according to Clarendon "a Stafford nearly allied to Sir Edward Stafford," through whom he was recommended to Sir Charles Cornwallis, ambassador to Spain, becoming a member of his suite and acting as English agent on the latter's recall, from 1609 to 1611. In 1612 he was appointed English consul at Seville. Returning to England, he was made a clerk of the council in September 1613. His Spanish experience rendered him useful to the king, and his bias in favour of Spain was always marked. He seems to have promoted the Spanish policy from the first, and pressed on Gondomar, the Spanish ambassador, the proposal for the Spanish in opposition to the French marriage for Prince Charles. He was a Roman Catholic at least at heart, becoming a member of that communion in 1623, returning to Protestantism, and again declaring himself a Roman Catholic in 1636, and supporting the cause of the Roman Catholics in England. In 1616 he went as ambassador to Spain, making in 1618 James's proposal of mediation in the dispute with the elector palatine. After his return he was appointed secretary to the prince of Wales in October 1622, and was knighted and made a baronet in 1623. He strongly disapproved of the prince's expedition to Spain, as an adventure likely to upset the whole policy of marriage and alliance, but was overruled and chosen to accompany him. His opposition greatly incensed Buckingham, and still more his perseverance in the Spanish policy after the failure of the expedition, and on Charles's accession Cottington was through his means dismissed from all his employments and forbidden to appear at court. The duke's assassination, however, enabled him to return. On the 12th of November 1628 he was made a privy councillor, and in March 1629 appointed chancellor of the exchequer. In the autumn he was again sent ambassador to Spain; he signed the treaty of peace of the 5th of November 1630, and subsequently a secret agreement arranging for the partition of Holland between Spain and England in return for the restoration of the Palatinate. On the 10th of July 1631 he was created Baron Cottington of Hanworth in Middlesex.

In March 1635 he was appointed master of the court of wards, and his exactions in this office were a principal cause of the unpopularity of the government. He was also appointed a commissioner for the treasury, together with Laud. Between Cottington and the latter there sprang up a fierce rivalry. In these personal encounters Cottington had nearly always the advantage, for he practised great reserve and possessed great powers of self-command, an extraordinary talent for dissembling and a fund of humour. Laud completely lacked these qualities, and though really possessing much greater influence with Charles, he was often embarrassed and sometimes exposed to ridicule by his opponent. The aim of Cottington's ambition was the place of lord treasurer, but Laud finally triumphed and secured it for his own nominee, Bishop Juxon, when Cottington became "no more a leader but meddled with his particular duties only."<sup>1</sup> He continued, however, to take a large share in public business and served on the committees for foreign, Irish and Scottish affairs. In the last, appointed in July 1638, he supported the war, and in May 1640, after the dismissal of the Short Parliament, he declared it his opinion that at such a crisis the king might levy money without the Parliament. His attempts to get funds from the city were unsuccessful, and he had recourse instead to a speculation in pepper. He had been appointed constable of the Tower, and he now prepared the fortress for a siege. In the trial of Strafford in 1641 Cottington denied on oath that he had heard him use the incriminating words about "reducing this kingdom." When the parliamentary opposition became too strong to be any longer defied, Cottington, as one of those who had chiefly incurred their

<sup>1</sup> Strafford's *Letters*, ii. 52.

hostility, hastened to retire from the administration, giving up the court of wards in May 1641 and the chancellorship of the exchequer in January 1642. He rejoined the king in 1643, took part in the proceedings of the Oxford parliament, and was made lord treasurer on the 3rd of October 1643. He signed the surrender of Oxford in July 1646, and being excepted from the indemnity retired abroad. He joined Prince Charles at the Hague in 1648, and became one of his counsellors. In 1649, together with Hyde, Cottington went on a mission to Spain to obtain help for the royal cause, having an interview with Mazarin at Paris on the way. They met, however, with an extremely ill reception, and Cottington found he had completely lost his popularity at the Spanish court, one cause being his shortcomings and waverings in the matter of religion. He now announced his intention of remaining in Spain and of keeping faithful to Roman Catholicism, and took up his residence at Valladolid, where he was maintained by the Jesuits. He died there on the 19th of June 1652, his body being subsequently buried in Westminster Abbey. He had amassed a large fortune and built two magnificent houses at Hanworth and Founthill. Cottington was evidently a man of considerable ability, but the foreign policy pursued by him was opposed to the national interests and futile in itself. According to Clarendon's verdict "he left behind him a greater esteem of his parts than love of his person." He married in 1623 Anne, daughter of Sir William Meredith and widow of Sir Robert Brett. All his children predeceased him, and his title became extinct at his death.

**BIBLIOGRAPHY.**—Article in the *Dict. of Nat. Biography* and authorities there quoted; Clarendon's *Hist. of the Rebellion*, *passim*, and esp. xiii. 30 (his character), and xii., xiii. (account of the Spanish mission in 1649); Clarendon's *State Papers and Life*; Strafford's *Letters*; Gardiner's *Hist. of England and of the Commonwealth*; Hoare's *Wiltshire*; Laud's *Works*, vols. iii.-vii.; Winwood's *Memorials: A Refutation of a False and Impious Aspersation cast on the late Lord Cottington*; Dart, *Westminsterium*, i. 181 (epitaph and monument). (P. C. Y.)

**COTTON**, the name of a well-known family of Anglo-Indian administrators, of whom the following are the most notable.

**SIR ARTHUR THOMAS COTTON** (1803–1899), English engineer, tenth son of Henry Calveley Cotton, was born on the 15th of May 1803, and was educated at Addiscombe. He entered the Madras engineers in 1819, served in the first Burmese war (1824–26), and in 1828 began his life-work on the irrigation works of southern India. He constructed works on the Cauvery, Coleroon, Godavari and Kistna rivers, making anicuts (dams) on the Coleroon (1836–1838) for the irrigation of the Tanjore, Trichinopoly and South Arcot districts; and on the Godavari (1847–1852) for the irrigation of the Godavari district. He also projected the anicut on the Kistna (Krishna), which was carried out by other officers. Before the beginning of his work Tanjore and the adjoining districts were threatened with ruin from lack of water; on its completion they became the richest part of Madras, and Tanjore returned the largest revenue of any district in India. He was the founder of the school of Indian hydraulic engineering, and carried out much of his work in the face of opposition and discouragement from the Madras government; though, in the minute of the 15th of May 1858, that government paid an ample tribute to the genius of Cotton's "master mind." He was knighted in 1861. Sir Arthur Cotton believed in the possibility of constructing a complete system of irrigation and navigation canals throughout India, and devoted the whole of a long life to the partial realization of this project. He died on the 24th of July 1899.

See Lady Hope, *General Sir Arthur Cotton* (1900).

**SIR HENRY JOHN STEDMAN COTTON** (1845– ), Anglo-Indian administrator, son of J. J. Cotton of the Madras Civil Service, was born on the 13th of September 1845, and was educated at Magdalen College school and King's College, London. He entered the Bengal Civil Service in 1867, and held various appointments of increasing importance until he became chief secretary to the Bengal government (1891–1896), acting home secretary to the government of India (1896), and chief commissioner of Assam (1896–1902). He retired in 1902, and soon became known as the leading English champion of the Indian



nationalists. In 1906 he entered parliament as Liberal member for East Nottingham. He was the author of *New India* (1885; revised 1904-1907).

His brother, JAMES SUTHERLAND COTTON (1847- ), was born in India on the 17th of July 1847, and was educated at Magdalen College school and Trinity College, Oxford. For many years he was editor of the *Academy*; he published various works on Indian subjects, and was the English editor of the revised edition of the *Imperial Gazetteer of India* (1908).

**COTTON, CHARLES** (1630-1687), English poet, the translator of Montaigne, was born at Beresford in Staffordshire on the 28th of April 1630. His father, Charles Cotton, was a man of marked ability, and counted among his friends Ben Jonson, John Selden, Sir Henry Wotton and Izaak Walton. The son was apparently not sent to the university, but he had as tutor Ralph Rawson, one of the fellows ejected from Brasenose College, Oxford, in 1648. Cotton travelled in France and perhaps in Italy, and at the age of twenty-eight he succeeded to an estate greatly encumbered by lawsuits during his father's lifetime. The rest of his life was spent chiefly in country pursuits, but from his *Voyage to Ireland in Burlesque* (1670) we know that he held a captain's commission and was ordered to that country. His friendship with Izaak Walton began about 1655, and the fact of this intimacy seems a sufficient answer to the charges sometimes brought against Cotton's character, based chiefly on his coarse burlesques of Virgil and Lucian. Walton's initials made into a cipher with his own were placed over the door of his fishing cottage on the Dove; and to the *Compleat Angler* he added "Instructions how to angle for a trout or grayling in a clear stream." He married in 1656 his cousin Isabella, who was a sister of Colonel Hutchinson. It was for his wife's sister, Miss Stanhope Hutchinson, that he undertook the translation of Corneille's *Horace* (1671). His wife died in 1670 and five years later he married the dowager countess of Ardglass; she had a jointure of £1500 a year, but it was secured from his extravagance, and at his death in 1687 he was insolvent. He was buried in St James's church, Piccadilly, on the 16th of February 1687. Cotton's reputation as a burlesque writer may account for the neglect with which the rest of his poems have been treated. Their excellence was not, however, overlooked by good critics. Coleridge praises the purity and unaffectedness of his style in *Biographia Literaria*, and Wordsworth (*Preface*, 1815) gave a copious quotation from the "Ode to Winter." The "Retirement" is printed by Walton in the second part of the *Compleat Angler*. His masterpiece in translation, the *Essays of M. de Montaigne* (1685-1686, 1693, 1700, &c.), has often been reprinted, and still maintains its reputation; his other works include *The Scarronides, or Virgil Travestie* (1664-1670), a gross burlesque of the first and fourth books of the *Aeneid*, which ran through fifteen editions; *Burlesque upon Burlesque, . . . being some of Lucian's Dialogues newly put into English justian* (1675); *The Moral Philosophy of the Stoicks* (1667), from the French of Guillaume du Vair; *The History of the Life of the Duke d'Espernon* (1670), from the French of G. Girard; the *Commentaries* (1674) of Blaise de Montluc; the *Planter's Manual* (1675), a practical book on arboriculture, in which he was an expert; *The Wonders of the Peake* (1681); the *Compleat Gamester* and *The Fair one of Tunis*, both dated 1674, are also assigned to Cotton.

William Oldys contributed a life of Cotton to Hawkins's edition (1760) of the *Compleat Angler*. His *Lyrical Poems* were edited by J. R. Tutin in 1903, from an unsatisfactory edition of 1689. His translation of Montaigne was edited in 1892, and in a more elaborate form in 1902, by W. C. Hazlitt, who omitted or relegated to the notes the passages in which Cotton interpolates his own matter, and supplied his omissions.

**COTTON, GEORGE EDWARD LYNCH** (1813-1866), English educationist and divine, was born at Chester on the 29th of October 1813. He received his education at Westminster school, and at Trinity College, Cambridge. Here he joined the Low Church party, and was also the intimate friend of several disciples of Thomas Arnold, among whom were C. J. Vaughan and W. J. Conybeare. The influence of Arnold determined the character and course of his life. He graduated B.A. in 1836, and

became an assistant-master at Rugby. Here he worked devotedly for fifteen years, inspired with Arnold's spirit, and heartily entering into his plans and methods. He became master of the fifth form about 1840 and was singularly successful with the boys. In 1852 he accepted the appointment of headmaster at Marlborough College, then in a state of almost hopeless disorganization, and in his six years of rule raised it to a high position. In 1858 Cotton was offered the see of Calcutta, which, after much hesitation about quitting Marlborough, he accepted. For its peculiar duties and responsibilities he was remarkably fitted by the simplicity and strength of his character, by his large tolerance, and by the experience which he had gained as teacher and ruler at Rugby and Marlborough. The government of India had just been transferred from the East India Company to the crown, and questions of education were eagerly discussed. Cotton gave himself energetically to the work of establishing schools for British and Eurasian children, classes which had been hitherto much neglected. He did much also to improve the position of the chaplains, and was unwearied in missionary visitation. His sudden death was widely mourned. On the 6th of October 1866 he had consecrated a cemetery at Kushtea on the Ganges, and was crossing a plank leading from the bank to the steamer when he slipped and fell into the river. He was carried away by the current and never seen again.

A memoir of his life with selections from his journals and correspondence, edited by his widow, was published in 1871.

**COTTON, JOHN** (1585-1652), English and American Puritan divine, sometimes called "The Patriarch of New England," born in Derby, England, on the 4th of December 1585. He was educated at Trinity College, Cambridge, graduating B.A. in 1603 and M.A. in 1606, and became a fellow in Emmanuel College, Cambridge, then a stronghold of Puritanism, where, during the next six years, according to his friend and biographer, Rev. Samuel Whiting, he was "head lecturer and dean, and Catechist," and "a diligent tutor to many pupils." In June 1612 he became vicar of the parish church of St Botolphs in Boston, Lincolnshire, where he remained for twenty-one years and was extremely popular. Becoming more and more a Puritan in spirit, he ceased, about 1615, to observe certain ceremonies prescribed by the legally authorized ritual, and in 1632 action was begun against him in the High Commission Court. He thereupon escaped, disguised, to London, lay in concealment there for several months, and, having been deeply interested from its beginning in the colonization of New England, he eluded the watch set for him at the various English ports, and in July 1633 emigrated to the colony of Massachusetts Bay, arriving at Boston early in September. On the 10th of October he was chosen "teacher" of the First Church of Boston, of which John Wilson (1588-1667) was pastor, and here he remained until his death on the 23rd of December 1652. In the newer, as in the older Boston, his popularity was almost unbounded, and his influence, both in ecclesiastical and in civil affairs, was probably greater than that of any other minister in theocratic New England. According to the contemporary historian, William Hubbard, "Whatever he delivered in the pulpit was soon put into an order of court, if of a civil, or set up as a practice in the church, if of an ecclesiastical concernment." His influence, too, was generally beneficent, though it was never used to further the cause of religious freedom, or of democracy, his theory of government being given in an oft-quoted passage: "Democracy, I do not conceive that ever God did ordeyne as a fitt government eyther for church or commonwealth. . . . As for Monarchy and aristocracy they are both for them clearly approved, and directed in Scripture yet so as (God) referreth the sovereigntie to himselfe, and setteth up Theocracy in both, as the best form of government." He naturally took an active part in most, if not all, of the political and theological controversies of his time, the two principal of which were those concerning Antinomianism and the expulsion of Roger Williams. In the former his position was somewhat equivocal—he first supported and then violently opposed Anne Hutchinson,—in the latter he approved Williams's expulsion as "righteous in the eyes of God," and subsequently in a pamphlet discussion with

Williams, particularly in his *Bloudy Tenent, Washed and made White in the Bloud of the Lamb* (1647), vigorously opposed religious freedom. He was a man of great learning and was a prolific writer. His writings include: *The Keyes to the Kingdom of Heaven and the Power thereof* (1644), *The Way of the Churches of Christ in New England* (1645), and *The Way of Congregational Churches Cleared* (1648), these works constituting an invaluable exposition of New England Congregationalism; and *Milk for Babes, Drawn out of the Breasts of Both Testaments, Chiefly for the Spirituall Nourishment of Boston Babes in either England, but may be of like Use for any Children* (1646), widely used for many years, in New England, for the religious instruction of children.

See the quaint sketch by Cotton Mather, John Cotton's grandson, in *Magnalia* (London, 1702), and a sketch by Cotton's contemporary and friend, Rev. Samuel Whiting, printed in Alexander Young's *Chronicles of the First Planters of the Colony of Massachusetts Bay from 1623 to 1636* (Boston, 1846); also A. W. McClure's *The Life of John Cotton* (Boston, 1846), a chapter in Arthur B. Ellis's *History of the First Church in Boston* (Boston, 1881), and a chapter in Williston Walker's *Ten New England Leaders* (New York, 1901). (W. Wr.)

**COTTON, SIR ROBERT BRUCE**, Bart. (1571-1631), English antiquary, the founder of the Cottonian library, born at Denton in Huntingdonshire on the 22nd of January 1571, was a descendant, as he delighted to boast, of Robert Bruce. He was educated at Westminster school under William Camden the antiquary, and at Jesus College, Cambridge. His antiquarian tastes were early displayed in the collection of ancient records, charters and other manuscripts, which had been dispersed from the monastic libraries in the reign of Henry VIII.; and throughout the whole of his life he was an energetic collector of antiquities from all parts of England and the continent. His house at Westminster had a garden going down to the river and occupied part of the site of the present House of Lords. It was the meeting-place in the last years of Elizabeth's reign of the antiquarian society founded by Archbishop Parker. In 1600 Cotton visited the north of England with Camden in search of Pictish and Roman monuments and inscriptions. His reputation as an expert in heraldry led to his being asked by Queen Elizabeth to discuss the question of precedence between the English ambassador and the envoy of Spain, then in treaty at Calais. He drew up an elaborate paper establishing the precedence of the English ambassador. On the accession of James I. he was knighted, and in 1608 he wrote a *Memorial on Abuses in the Navy*, that resulted in a navy commission, of which he was made a member. He also presented to the king an historical *Inquiry into the Crown Revenues*, in which he speaks freely about the expenses of the royal household, and asserts that tonnage and poundage are only to be levied in war time, and to "proceed out of good will, not of duty." In this paper he supported the creation of the order of baronets, each of whom was to pay the crown £1000; and in 1611 he himself received the title.

Cotton helped John Speed in the compilation of his *History of England* (1611), and was regarded by contemporaries as the compiler of Camden's *History of Elizabeth*. It seems more likely that it was executed by Camden, but that Cotton exercised a general supervision, especially with regard to the story of Mary queen of Scots. The presentation of his mother's history was naturally important to James I., and Cotton himself took a keen interest in the matter. He had had the room in Fotheringay where Mary was executed transferred to his family seat at Connington. Meanwhile he was enlarging his collection of documents. In 1614 Arthur Agarde (*q.v.*) left his papers to him, and Camden's manuscripts came to him in 1623. In 1615 Cotton, as the intimate of the earl of Somerset, whose innocence he always maintained, was placed in confinement on the charge of being implicated in the murder of Sir Thomas Overbury; he confessed that he had acted as intermediary between Sarmiento, the Spanish ambassador, and Somerset, and had altered the dates of Somerset's correspondence. He was released after about eight months' imprisonment without formal trial, and obtained a pardon on payment of £500. His friendship with Gondomar, Spanish ambassador in England from 1613 to 1621,

brought further suspicion, probably undeserved, upon Cotton, of unduly favouring the Catholic party. From Charles I. and Buckingham Cotton received no favour; his attitude towards the court had begun to change, and he became the intimate friend of Sir John Eliot, Sir Simonds d'Ewes and John Selden. He had entered parliament in 1604 as member for Huntingdon; in 1624 he sat for Old Sarum; in 1625 for Thetford; and in 1628 for Castle Rising, Norfolk. In the debate on supply in 1625 Cotton provided Eliot with full notes defending the action of the opposition in parliament, and in 1628 the leaders of the party met at Cotton's house to decide on their policy. In 1626 he gave advice before the council against debasing the standard of the coinage; and in January 1628 he was again before the council, urging the summons of a parliament. His arguments on the latter occasion are contained in his tract entitled *The Danger in which the Kingdom now standeth and the Remedy*. In October of the next year he was arrested, together with the earls of Bedford, Somerset, and Clare, for having circulated, with ironical purpose, a tract known as the *Proposition to bridle Parliament*, which had been addressed some fifteen years before by Sir Robert Dudley to James I., advising him to govern by force; the circulation of this by Parliamentarians was regarded as intended to insinuate that Charles's government was arbitrary and unconstitutional. Cotton denied knowledge of the matter, but the original was discovered in his house, and the copies had been put in circulation by a young man who lived after him and was said to be his natural son. Cotton was himself released the next month; but the proceedings in the star chamber continued, and, to his intense vexation, his library was sealed up by the king. He died on the 6th of May 1631, and was buried in Connington church, Huntingdonshire, where there is a monument to his memory.

Many of Cotton's pamphlets were widely read in manuscript during his lifetime, but only two of his works were printed, *The Reign of Henry III.* (1627) and *The Danger in which the Kingdom now Standeth* (1628). His son, Sir Thomas (1594-1662), added considerably to the Cottonian library; and Sir John, the fourth baronet, presented it to the nation in 1700. In 1731 the collection, which had in the interval been removed to the Strand, and thence to Ashburnham House, was seriously damaged by fire. In 1753 it was transferred to the British Museum.

See the article LIBRARIES, and Edwards's *Lives of the Founders of the British Museum*, vol. i. Several of Cotton's papers have been printed under the title *Cottoni Posthuma*; others were published by Thomas Hearne.

**COTTON** (Fr. *coton*; from Arab. *qutun*), the most important of the vegetable fibres of the world, consisting of unicellular hairs which occur attached to the seeds of various species of plants of the genus *Gossypium*, belonging to the Mallow order (Malvaceae). Each fibre is formed by the outgrowth of a single epidermal cell of the testa or outer coat of the seed.

*Botany and Cultivation.*—The genus *Gossypium* includes herbs and shrubs, which have been cultivated from time immemorial, and are now found widely distributed throughout the tropical and subtropical regions of both hemispheres. South America, the West Indies, tropical Africa and Southern Asia are the homes of the various members, but the plants have been introduced with success into other lands, as is well indicated by the fact that although no species of *Gossypium* is native to the United States of America, that country now produces over two-thirds of the world's supply of cotton. Under normal conditions in warm climates many of the species are perennials, but, in the United States for example, climatic conditions necessitate the plants being renewed annually, and even in the tropics it is often found advisable to treat them as annuals to ensure the production of cotton of the best quality, to facilitate cultural operations, and to keep insect and fungoid pests in check.

Microscopic examination of a specimen of mature cotton shows that the hairs are flattened and twisted, resembling somewhat in general appearance an empty and twisted fire hose. This characteristic is of great economic importance, the natural twist facilitating the operation of spinning the fibres into thread or yarn. It also distinguishes the true cotton from the silk cottons or flosses, the fibres of which have no twist, and do not readily

spin into thread, and for this reason, amongst others, are very considerably less important as textile fibres. The chief of these silk cottons is kapok, consisting of the hairs borne on the interior of the pods (but not attached to the seeds) of *Eriodendron anfractuosum*, the silk cotton tree, a member of the Bombacaceae, an order very closely allied to the Malvaceae.

**Classification.**—Considerable difficulty is encountered in attempting to draw up a botanical classification of the species of *Gossypium*. Several are only known in cultivation, and we have but little knowledge of the wild parent forms from which they have descended. During the periods the cottons have been cultivated, selection, conscious or unconscious, has been carried on, resulting in the raising, from the same stock probably, in different places, of well-marked forms, which, in the absence of the history of their origin, might be regarded as different species. Then again, during at least the last four centuries, cotton plants have been distributed from one country to another, only to render

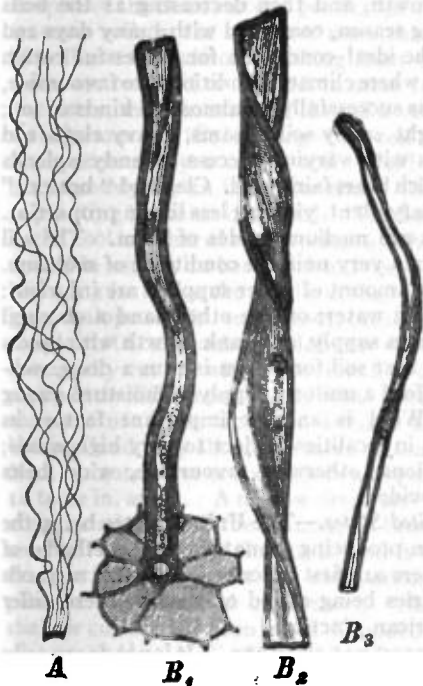

From Strasburger's *Lehrbuch der Botanik*, by permission of Gustav Fischer.

FIG. 1.—Seed-hairs of the Cotton, *Gossypium herbaceum*. A, Part of seed-coat with hairs ( $\times 3$ ); B<sub>1</sub>, insertion and lower part; B<sub>2</sub>, middle part; and B<sub>3</sub>, upper part of a hair ( $\times 300$ ).

commercially important plants into five species, placing these in two groups according to the character of the hairs borne on the seeds. Sir G. Watt's exhaustive work on *Wild and Cultivated Cotton Plants of the World* (1907) is the latest authority on the subject; and his views on some debated points have been incorporated in the following account.

A seed of "Sea Island cotton" is covered with long hairs only, which are readily pulled off, leaving the comparatively small black seed quite clean or with only a slight fuzz at the end, whereas a seed of "Upland" or ordinary American cotton bears both long and short hairs; the former are fairly easily detached (less easily, however, than in Sea Island cotton), whilst the latter adhere very firmly, so that when the long hairs are pulled off the seed remains completely covered with a short fuzz. This is also the case with the ordinary Indian and African cottons. There remains one other important group, the so-called "kidney" cottons in which there are only long hairs, and the seed easily comes away clean as with "Sea Island," but, instead of each seed being separate, the whole group in each of the three compartments of the capsule is firmly united together in a more or less kidney-shaped mass. Starting with this as the basis of classifica-

tion, we can construct the following key, the remaining principal points of difference being indicated in their proper places:—

- i. Seeds covered with long hairs only, flowers yellow, turning to red.
  - A. Seeds separate. Country of origin, Tropical America—(1) *G. barbadense*, L.
  - B. Seeds of each loculus united. Country of origin, S. America—(2) *G. brasiliense*, Macf.
- ii. Seeds covered with long and short hairs.
  - A. Flowers yellow or white, turning to red.
    - a. Leaves 3 to 5 lobed, often large. Flowers white. Country of origin, Mexico—(3) *G. hirsutum*, L.
    - b. Leaves 3 to 5, seldom 7 lobed. Small. Flowers yellow. Country of origin, India—(4) *G. herbaceum*, L.
  - B. Flowers purple or red. Leaves 3 to 7 lobed. Place of origin, Old World—(5) *G. arboreum*, L.

1. *G. barbadense*, Linn. This plant, known only in cultivation, is usually regarded as native to the West Indies. Watt regards it as closely allied to *G. vitifolium*, and considers the modern stock a hybrid, and probably not indigenous to the West Indies. He classifies the modern high-class Sea Island cottons as *G. barbadense*, var. *marilima*. Whatever may be its true botanical name it is the plant known in commerce as "Sea Island" cotton, owing to its introduction and successful cultivation in the Sea Islands and the coastal districts of South Carolina, Georgia and Florida. It yields the most valuable of all cottons, the hairs being long, fine and silky, and ranging in length from  $\frac{3}{8}$  to  $2\frac{1}{2}$  in. By careful selection (the methods of which are described below) in the United States, the quality of the product was much improved, and on the recent revival of the cotton industry in the West Indies American "Sea Island" seed was introduced back again to the original home of the species.

Egyptian cotton is usually regarded as being derived from the same species. Watt considers many of the Egyptian cottons to be races or hybrids of *G. peruvianum*, Cav. Egyptian cotton in length of staple is intermediate between average Sea Island and average Upland. It has, however, certain characteristics which cause it to be in demand even in the United States, where during recent years Egyptian cotton has comprised about 80% of all the "foreign" cottons imported. These special qualities are its fineness, strength, elasticity and great natural twist, which combined enable it to make very fine, strong yarns, suited to the manufacture of the better qualities of hosiery, for mixing with silk and wool, for making lace, &c. It also mercerizes very well. The principal varieties of Egyptian cotton are: *Mitafifi*, the best-known and most extensively grown, hardy and but little affected by climatic variation. It is usually regarded as the standard Egyptian cotton; the lint is yellowish brown, the seeds black and almost smooth, usually with a little tuft of short green hairs at the ends. *Abassi*, a variety comparatively recently obtained by selection. The lint is pure white, very fine and silky, but not so strong as Mitafifi cotton. *Yannovitch*, a variety known since about 1897, yields the finest and most silky lint of the white Egyptian cottons. *Bamia*, yielding a brown lint, very similar to Mitafifi, but slightly less valuable. *Ashmouni*, a variety principally cultivated in Upper Egypt. The lint is brown and generally resembles Mitafifi but is less valuable.

Other varieties are *Zifri*, *Hamouli* and *Gallini*, all of minor importance.

2. *G. brasiliense*, Macf. (*G. peruvianum*, Engler), or kidney cotton. Amongst the varieties of cotton which are derived from this species appear to be Pernambuco, Maranhão, Ceara, Aracaty and Maceio cottons. The fibre is generally white, somewhat harsh and wiry, and especially adapted for mixing with wool. The staple varies in length from 1 to about  $1\frac{1}{2}$  in.

3. *G. hirsutum*, Linn. Although *G. barbadense* yields the most valuable cotton, *G. hirsutum* is the most important cotton-yielding plant, being the source of American cotton, i.e. Upland, Georgia, New Orleans and Texas varieties. The staple varies usually in length between  $\frac{3}{8}$  and  $1\frac{1}{2}$  in. According to Watt there are many hybrids in American cottons between *G. hirsutum* and *G. mexicanum*.

4. *G. herbaceum*, Linn. Levant cotton is derived from this species. The majority of the races of cotton cultivated in India are often referred to this species, which is closely allied to *G. hirsutum* and has been regarded as identical with it. Amongst the cottons of this source are Hinganghat, Tinnevely, Dharwar, Broach, Amraoti (Oomras or Oomrawattee), Kumta, Westerns, Dholera, Verawal, Bengals, Sind and Bhaunagar. Watt dissents from this view and classes these Indian cottons as *G. obtusifolium* and *G. Nanking* with their varieties. The Indian cottons are usually of short staple (about  $\frac{3}{4}$  in.), but are probably capable of improvement.

5. *G. arboreum*, Linn. This species is often considered as indigenous to India, but Dr Engler has pointed out that it is found wild in Upper Guinea, Abyssinia, Senegal, etc. It is the "tree cotton" of India and Africa, being typically a large shrub or small tree. The fibre is fine and silky, of about an inch in length. In India it is known as Nurma or Deo cotton, and is usually stated to be employed for making thread for the turbans of the priests. Commercially it is of comparatively minor importance.

The following table, summarized from the *Handbook to the Imperial Institute Cotton Exhibition, 1905*, giving the length of staple and value on one date (January 16, 1905), will serve to indicate the comparative values of some of the principal commercial cottons. The actual value, of course, fluctuates greatly.

	Length of Staple. Inches.	Value Per lb.
Sea Island Cotton—		s. d.
Carolina Sea Island . . . . .	1.8	1 3
Florida " " . . . . .	1.8	1 0
Georgia " " . . . . .	1.7	1 1½
Barbados " " . . . . .	2.0	1 3
Egyptian Cottons—		
Yannovitch . . . . .	1.5	9½
Abassi . . . . .	1.5	8½
Good Brown Egyptian (Mitafifi) . . . . .	1.2	7½
American Cotton—		
Good middling Memphis . . . . .	1.3	4½
Good middling Texas . . . . .	1.0	4½
Good middling Upland . . . . .	1.0	4
Indian Cottons—		
Fine Tinnevely . . . . .	0.8	4½
Fine Bhaunagar . . . . .	1.0	3½
Fine Amraoti . . . . .	1.0	3½
Fine Broach . . . . .	0.9	3½
Fine Bengal . . . . .	0.9	3½
Fine ginned Sind . . . . .	0.8	3½
Good ginned Kumta . . . . .	1.0	3½

The close relationship between the length of the staple and the market price will be at once apparent.

*Cultivation.*—Cotton is very widely cultivated throughout the world, being grown on a greater or less scale as a commercial crop in almost every country included in the broad belt between latitudes 43° N. and 33° S., or approximately within the isothermal lines of 60° F.

The cotton plant requires certain conditions for its successful cultivation; but, given these, it is very little affected by seasonal vicissitudes. Thus, for example, in the United States the worst season rarely diminishes the crop by more than about a quarter or one-third; such a thing as a "half-crop" is unknown. Various climatic factors may cause temporary checks, but the growing and maturing period is sufficiently long to allow the plants to overcome these disturbances.

Cotton requires for its development from six to seven months of favourable weather. It thrives in a warm atmosphere, even in a very hot one, provided that it is moist and that the transpiration is not in excess of the supply of water. An idea of the requirements of the plant will perhaps be afforded by summarizing the conditions which have been found to give the best results in the United States.

During April (when the seed is usually sown) and May frequent light showers, which keep the ground sufficiently moist to assist germination and the growth of the young plants, are desired. Three to four inches of rain per month is the average. The active growing period is from early June to about the middle of August. During June and the first fortnight in July plenty of

sunshine is necessary, accompanied by sufficient rain to promote healthy, but not excessive, growth; the normal rainfall in the cotton belt for this period is about 4½ in. per month. During the second portion of July and the first of August a slightly higher rainfall is beneficial, and even heavy rains do little harm, provided the subsequent months are dry and warm. The first flowers usually appear in June, and the bolls ripen from early in August. Picking takes place normally during September and October, and during these months dry weather is essential. Flowering and fruiting go on continually, although in diminishing degree, until the advent of frost, which kills the flowers and young bolls and so puts an end to the production of cotton for the season.

In the tropics the essential requirements are very similar, but there the dry season checks production in much the same way as do the frosts in temperate climates. In either case an adequate but not excessive rainfall, increasing from the time of sowing to the period of active growth, and then decreasing as the bolls ripen, with a dry picking season, combined with sunny days and warm nights, provide the ideal conditions for successful cotton cultivation. In regions where climatic conditions are favourable, cotton grows more or less successfully on almost all kinds of soil; it can be grown on light sandy soils, loams, heavy clays and sandy "bottom" lands with varying success. Sandy uplands produce a short stalk which bears fairly well. Clay and "bottom" lands produce a large, leafy plant, yielding less lint in proportion. The most suitable soils are medium grades of loam. The soil should be able to maintain very uniform conditions of moisture. Sudden variations in the amount of water supplied are injurious: a sandy soil cannot retain water; on the other hand a clay soil often maintains too great a supply, and rank growth with excess of foliage ensues. The best soil for cotton is thus a deep, well-drained loam, able to afford a uniform supply of moisture during the growing period. Wind is another important factor, as cotton does not do well in localities subject to very high winds; and in exposed situations, otherwise favourable, wind belts have at times to be provided.

*Cultivation in the United States.*—The United States being the most important cotton-producing country, the methods of cultivation practised there are first described, notes on methods adopted in other countries being added only when these differ considerably from American practice.

The culture of cotton must be a clean one. It is not necessarily deep culture, and during the growing season the cultivation is preferably very shallow. The result is a great destruction of the humus of the soil, and great leaching and washing, especially in the light loams of the hill country of the United States. The main object, therefore, of the American cotton-planter is to prevent erosion. Wherever the planters have failed to guard their fields by hillside ploughing and terracing, these have been extensively denuded of soil, rendering them barren, and devastating other fields lying at a lower level, which are covered by the wash. The hillsides have gradually to be terraced with the plough, upon almost an exact level. On the better farms this is done with a spirit-level or compass from time to time and hillside ditches put in at the proper places. In the moist bottom-lands along the rivers it is the custom to throw the soil up in high beds with the plough, and then to cultivate them deep. This is the more common method of drainage, but it is expensive, as it has to be renewed every few years. More intelligent planters drain their bottom-lands with underground or open drains. In the case of small plantations the difficulties of adjusting a right-of-way for outlet ditches have interfered seriously with this plan. Many planters question the wisdom of deepbreaking and subsoiling. There can be no question that a deep soil is better for the cotton-plant; but the expense of obtaining it, the risk of injuring the soil through leaching, and the danger of bringing poor soil to the surface, have led many planters to oppose this plan. Sandy soils are made thereby too dry and leachy, and it is a questionable proceeding to turn the heavy clays upon the top. Planters are, as a result, divided in opinion as to the wisdom of subsoiling. Nothing definite can be said with regard to a rotation of crops

upon the cotton plantation. Planters appreciate generally the value of broad-leaved and narrow-leaved plants and root crops, but there is an absence of exact knowledge, with the result that their practices are very varied. It is believed that the rotation must differ with every variety of soil, with the result that each planter has his own method, and little can be said in general. A more careful study of the physical as well as the chemical properties of a soil must precede intelligent experimentation in rotation. This knowledge is still lacking with regard to most of the cotton soils. The only uniform practice is to let the fields "rest" when they have become exhausted. Nature then restores them very rapidly. The exhaustion of the soil under cotton culture is chiefly due to the loss of humus, and nature soon puts this back in the excellent climate of the cotton-growing belt. Fields considered utterly used up, and allowed to "rest" for years, when cultivated again have produced better crops than those which had been under a more or less thoughtful rotation. In spite of the clean culture, good crops of cotton have been grown on some soils in the south for more than forty successive years. The fibre takes almost nothing from the land, and where the seeds are restored to the soil in some form, even without other fertilizers, the exhaustion of the soil is very slow. If the burning-up of humus and the leaching of the soil could be prevented, there is no reason why a cotton soil should not produce good crops continuously for an indefinite time. Bedding up land previous to planting is almost universal. The bed forms a warm seed-bed in the cool weather of early spring, and holds the manure which is drilled in usually to better advantage. The plants are generally left 2 or 3 in. above the middle of the row, which in four-foot rows gives a slope of 1 in. to the foot, causing the plough to lean from the plants in cultivating, and thus to cut fewer roots. The plants are usually cut out with a hoe from 8 to 14 in. apart. It seems to make little difference exactly what distance they are, so long as they are not wider apart on average land than 1 ft. On rich bottom-land they should be more distant. The seed is dropped from a planter, five or six seeds in a single line, at regular intervals 10 to 12 in. apart. A narrow deep furrow is usually run immediately in advance of the planter, to break up the soil under the seed. The only time the hoe is used is to thin out the cotton in the row; all the rest of the cultivation is by various forms of ploughs and so-called cultivators. The question of deep and shallow culture has been much discussed among planters without any conclusion applicable to all soils being reached. All grass and weeds must be kept down, and the crust must be broken after every rain, but these seem to be the only principles upon which all agree. The most effective tool against the weeds is a broad sharp "sweep," as it is called, which takes everything it meets, while going shallower than most ploughs. Harrows and cultivators are used where there are few weeds, and the mulching process is the one desired.

The date of cotton-planting varies from March 1 to June 1, according to situation. Planting begins early in March in Southern Texas, and the first blooms will appear there about May 15. Planting may be done as late as April 15 in the Piedmont region of North Carolina, and continue as late as the end of May. The first blooms will appear in this region about July 15. Picking may begin on July 10 in Southern Texas, and continue late into the winter, or until the rare frost kills the plants. It may not begin until September 10 in Piedmont, North Carolina. It is a peculiarity of the cotton-plant to lose a great many of its blooms and bolls. When the weather is not favourable at the fruiting stage, the otherwise hardy cotton plant displays its great weakness in this way. It sheds its "forms" (as the buds are called), blooms, and even half-grown bolls in great numbers. It has frequently been noted that even well-fertilized plants upon good soil will mature only 15 or 20% of the bolls produced. No means are known so far for preventing this great waste. Experts are at an entire loss to form a correct idea of the cause, or to apply any effective remedy.

Cotton-picking is at once the most difficult and most expensive operation in cotton production. It is paid for at the rate of from 45 to 50 cents per cwt. of seed cotton. The work is light, and

is effectually performed by women and even children, as well as men; but it is tedious and requires care. The picking season will average 100 days. It is difficult to get the hands to work until the cotton is fully opened, and it is hard to induce them to pick over 100 lb a day, though some expert hands are found in every cotton plantation who can pick twice as much. The loss resulting from careless work is very serious. The cotton falls out easily or is dropped. The careless gathering of dead leaves and twigs, and the soiling of the cotton by earth or by the natural colouring matter from the bolls, injure the quality. It has been commonly thought that the production of cotton in the south is limited by the amount that can be picked, but this limit is evidently very remote. The negro population of the towns and villages of the cotton country is usually available for a considerable share in cotton-picking. There is in the cotton states a rural population of over 7,000,000, more or less occupied in cotton-growing, and capable, at the low average of 100 lb a day, of picking daily nearly 500,000 bales. It is evident, therefore, that if this number could work through the whole season of 100 days, they could pick three or four times as much cotton as the largest crop ever made. Great efforts have been made to devise cotton-picking machines, but, as yet, complete success has not been attained. Lowne's machine is useful in specially wide-planted fields and when the ground is sufficiently hard.

*Cotton Ginning.*—The crop having been picked, it has to be prepared for purpose of manufacture. This comprises separating the fibre or lint from the seeds, the operation being known as "ginning." When this has been accomplished the weight of the crop is reduced to about one-third, each 100 lb of seed cotton as picked yielding after ginning some 33 lb of lint and 66 lb of cotton seed. The actual amounts differ with different varieties, conditions of cultivation, methods of ginning, &c.; a recent estimate in the United States gives 35% of lint for Upland cotton and 25% for Sea Island cotton as more accurate.

The separation of lint from seed is accomplished in various ways. The most primitive is hand-picking, the fibre being laboriously pulled from off each seed, as still practised in parts of Africa. In modern commercial cotton production ginning machines are always used. Very simple machines are used in some parts of Africa. The simplest cotton gin in extensive use is the "churka," used from early times, and still largely employed in India and China. It consists essentially of two rollers either both of wood, or one of wood and one of iron, geared to revolve in contact in opposite directions; the seed cotton is fed to the rollers, the lint is drawn through, and the seed being unable to pass between the rollers is rejected. With this primitive machine, worked by hand, about 5 lb of lint is the daily output. In the Macarthy roller gin, the lint, drawn by a roller covered with leather (preferably walrus hide), is drawn between a metal plate called the "doctor" (fixed tangentially to the roller and very close to it) and a blade called the "beater" or knife, which rapidly moves up and down immediately behind, and parallel to, the fixed plate. The lint is held by the roughness of the roller, and the blade of the knife or beater readily detaches the seed from the lint; the seed falls through a grid, while the lint passes over the roller to the other side of the machine. A hand Macarthy roller gin worked by two men will clean about 4 to 6 lb of lint per hour. A similar, but larger machine, requiring about 1½ horse-power to run it, will turn out 50 to 60 lb of Egyptian or 60 to 80 lb of Sea Island cleaned cotton per hour. By simple modifications the Macarthy gin can be used for all kinds of cotton. Various attempts have been made to substitute a comb for the knife or beater, and one of the latest productions is the "Universal fibre gin," in which a series of blunt combs working horizontally replace the solid beater and so-called knife of the Macarthy gin.

Opposed to the various types of roller gins is the "saw gin," invented by Eli Whitney, an American, in 1792. This machine, under various modifications, is employed for ginning the greater portion of the cotton grown in the Southern States of America. It consists essentially of a series of circular notched disks, the so-called saws, revolving between the interstices of an iron bed



upon which the cotton is placed: the teeth of the "saws" catch the lint and pull it off from the seeds, then a revolving brush removes the detached lint from the saws, and creates sufficient draught to carry the lint out of the machine to some distance. Saw gins do considerable damage to the fibre, but for short-stapled cotton they are largely used, owing to their great capacity. The average yield of lint per "saw" in the United States, when working under perfect conditions, is about 6 lb per hour. Some of the American ginneries are very large indeed, a number (*Bulletin of the Bureau of the Census on Cotton Production*) being reported as containing on the average 1156 saws with an average production of 4120 bales of cotton. Saw gins are not adapted to long-stapled cottons, such as Sea Island and Egyptian, which are generally ginned by machines of the Macarthy type.

The machine which will gin the largest quantity in the shortest time is naturally preferred, unless such injury is occasioned as materially to diminish the market value of the cotton. This has sometimes been to the extent of 1d. or 2d. per lb and even more as regards Sea Island and other long-stapled cottons. The production, therefore, of the most perfect and efficient cotton-cleaning machinery is of importance alike to the planter and manufacturer.

**Baling.**—The cotton leaves the ginning machine in a very loose condition, and has to be compressed into bales for convenience of transport. Large baling presses are worked by hydraulic power; the operation needs no special description. Bales from different countries vary greatly in size, weight and appearance. The American bale has been described in a standard American book on cotton as "the clumsiest, dirtiest, most expensive and most wasteful package, in which cotton or any other commodity of like value is anywhere put up." Suggestions for its improvement, which if carried out would (it is estimated) result in a monetary saving of £1,000,000 annually, were made by the Lancashire Private Cotton Investigation Commission which visited the Southern States of America in 1906.

The approximate weights of some of the principal bales on the English market are as follows:—

United States . . . . .	500 lb
Indian . . . . .	400 lb
Egyptian . . . . .	700 lb
Peruvian . . . . .	200 lb
Brazilian . . . . .	200 to 300 lb

With baling the work of the producer is concluded.

**Cultivation in Egypt.**—Climatic conditions in Egypt differ radically from those in the United States, the rainfall being so small as to be quite insufficient for the needs of the plant, very little rain indeed falling in the Nile Delta during the whole growing season of the crop: yet Egypt is in order the third cotton-producing country of the world, elaborate irrigation works supplying the crop with the requisite water. The area devoted to cotton in Egypt is about 1,800,000 acres, and nine-tenths of it is in the Nile Delta. The delta soil is typically a heavy, black, alluvial clay, very fertile, but difficult to work; admixture of sand is beneficial, and the localities where this occurs yield the best cotton. Formerly in Egypt the cotton was treated as a perennial, but this practice has been generally abandoned, and fresh plants are raised from seed each year, as in America; one great advantage is that more than one crop can thus be obtained each year. The following rotation is frequently adopted. It should be noted that in Egypt the year is divided into three seasons—winter, summer and "Nili." The two first explain themselves; Nili is the season in which the Nile overflows its banks.

	Winter.	Summer.	Nili.
First year . . . . .	Clover	Cotton	
Second year . . . . .	Beans or wheat		Corn or fallow

For cotton cultivation the land is ploughed, carefully levelled, and then thrown up into ridges about 3 ft. apart. Channels formed at right angles to the cultivation ridges provide for the

access of water to the crop. The seeds, previously soaked, are sown, usually in March, on the sides of the ridges, and the land watered. After the seedlings appear, thinning is completed in usually three successive hoeings, the plants being watered after thinning, and subsequently at intervals of from twelve to fifteen days, until about the end of August when picking commences. The total amount of water given is approximately equivalent to a rainfall of about 35 in. The crop is picked, ginned and baled in the usual way, the Macarthy style action roller gins being almost exclusively employed.

**Cotton Seed.**—The history of no agricultural product contains more of interest and instruction for the student of economics than does that of cotton seed in the United States. The revolution in its treatment is a real romance of industry. Up till 1870 or thereabouts, cotton seed was regarded as a positive nuisance upon the American plantation. It was left to accumulate in vast heaps about ginhouses, to the annoyance of the farmer and the injury of his premises. Cotton seed in those days was the object of so much aversion that the planter burned it or threw it into running streams, as was most convenient. If the seed were allowed to lie about, it rotted, and hogs and other animals, eating it, often died. It was very difficult to burn, and when dumped into rivers and creeks was carried out by flood water to fill the edges of the flats with a decaying and offensive mass of vegetable matter. Although used in the early days to a limited extent as a food for milch cows and other stock, and to a larger extent as a manure, no systematic efforts were made anywhere in the South to manufacture the seed until the later 'fifties, when the first cotton seed mills were established. It is said that there were only seven cotton oil mills in the South in 1860. The cotton-growing industry was interrupted by the Civil War, and the seed-milling business did not begin again until 1868. After that time the number of mills rapidly increased. There were 25 in the South in 1870, 50 in 1880, 120 in 1890, and about 500 in 1901, about one-third being in Texas.

Experience shows that 1000 lb of seed are produced for every 500 lb of cotton brought to market. On the basis, therefore, of a cotton crop of 10,000,000 bales of 500 lb each, there are produced 5,000,000 tons of cotton seed. If about 3,000,000 tons only are pressed, there remain to be utilized on the farm 2,000,000 tons of cotton seed, which, if manufactured, would produce a total of \$100,000,000 from cotton seed. In contrast with the farmers of the 'sixties, the southern planter of the 20th century appreciates the value of his cotton seed, and farmers, too remote from the mills to get it pressed, now feed to their stock all the cotton seed they conveniently can, and use the residue either in compost or directly as manure. The average of a large number of analyses of Upland cotton seed gives the following figures for its fertilizing constituents:—Nitrogen, 3.07%; phosphoric acid, 1.02%; potash, 1.17%; besides small amounts of lime, magnesia and other valuable but less important ingredients. Sea Island cotton seed is rather more valuable than Upland: the corresponding figures for the three principal constituents being nitrogen 3.51, phosphoric acid 1.69, potash 1.59%. Using average prices paid for nitrogen, phosphoric acid and potash when bought in large quantities and in good forms, these ingredients, in a ton of cotton seed, amount to \$9.00 worth of fertilizing material. Compared with the commercial fertilizer which the farmer has to buy, cotton seed possesses, therefore, a distinct value.

The products of cotton seed have become important elements in the national industry of the United States. The main product is the refined oil, which is used for a great number of purposes, such as a substitute for olive oil, mixed with beef products for preparation of compound lard, which is estimated to consume one-third of cotton seed oil produced in the States. The poorer grades are employed in the manufacture of soap, candles and phonograph records. Miners' lamp oil consists of the bleached oil mixed with kerosene. Cotton seed cake or meal (the residue after the oil is extracted) is one of the most valuable of feeding stuffs, as the following simple comparison between it and oats and corn will show:—

Average Analyses.	Proteins or Flesh Formers.	Carbo-hydrates or Fuel and Fat Suppliers.	Fats.	Ash or Bone Makers.
Cotton seed meal	43.26	22.31	13.45	7.02
Corn . . . . .	10.5	70.0	5.5	1.02
Oats . . . . .	17.0	65.0	8.0	1.2

Cotton seed meal, though poor in carbohydrates, the fat- and energy-supplying ingredients, is exceedingly rich in protein, the nerve- and muscle-feeding ingredients. But it still contains a large amount of oil, which forms animal fat and heat, and thus makes up for part of its deficiency in carbohydrates. The meal, in fact, is so rich in protein that it is best utilized as a food for animals when mixed with some coarse fodder, thus furnishing a more evenly-balanced ration. In comparative valuations of feeding stuffs it has been found that cotton seed meal exceeds corn meal by 62%, wheat by 67%, and raw cotton seed by 26%. Cotton seed meal, in the absence of sufficient stock to consume it, is also used extensively as a fertilizer, and for this purpose it is worth, determining the price on the same basis as used above for the seed, from \$19 to \$20 per ton. But it has seldom reached this price, except in some of the northern states, where it is used for feeding purposes. A more rational proceeding would be to feed the meal to animals and apply the resulting manure to the soil. When this is done, from 80 to 90% of the fertilizing material of the meal is recovered in the manure, only 10 to 20% being converted by the animal into meat and milk. The profit derived from the 20% thus removed is a very large one. These facts indicate that we have here an agricultural product the market price of which is still far below its value as compared, on the basis of its chemical composition, either with other feeding stuffs or with other fertilizers. Though it is probably destined to be used even more extensively as a fertilizer before the demand for it as a feeding stuff becomes equal to the supply, practically all the cotton seed meal of the south will ultimately be used for feeding. One explanation of this condition of things is that there is still a large surplus of cotton seed which cannot be manufactured by the mills. Another reason is found in the absence of cattle in the south to eat it.

With the consideration of cotton seed oil and meal we have not, however, exhausted its possibilities. Cotton seed hulls constitute about half the weight of the ginned seed. After the seed of Upland cotton has been passed through a fine gin, which takes off the short-hair or linters left upon it by the farmer, it is passed through what is called a sheller, consisting of a revolving cylinder, armed with numerous knives, which cut the seed in two and force the kernels or meats from the shells. The shells and kernels are then separated in a winnowing machine. This removal of the shell makes a great difference in the oilcake, as the decorticated cake is more nutritious than the undecorticated. For a long time these shells or hulls, as they are called, were burned at oil mills for fuel, 2½ tons being held equal to a cord of wood, and 4½ tons to a ton of coal. The hulls thus burned produced an ash containing an average of 9% of phosphoric acid and 24% of potash—a very valuable fertilizer in itself, and one eagerly sought by growers of tobacco and vegetables. It was not long, however, before the stock-feeder in the South found that cotton seed hulls were an excellent substitute for hay. They are used on a very large scale in the vicinity of oil mills in southern cities like Memphis, New Orleans, Houston, and Little Rock, from 500 to 5000 cattle being often collected in a single yard for this purpose. No other feed is required, the only provision necessary being an adequate supply of water and an occasional allowance of salt. Many thousands of cattle are fattened annually in this way at remarkably low cost.

Careful attention is now given to the employment of the seed in new cotton countries, and oil expression is practised in the West Indies. Hull is the principal seat of the industry in Great Britain, and enormous quantities of Indian and Egyptian cotton seed are imported and worked up.

The following diagram, modified from one by Grimshaw, in

accordance with the results obtained by the better class of modern mills, gives an interesting *résumé* of the products obtained from a ton of cotton seed:—

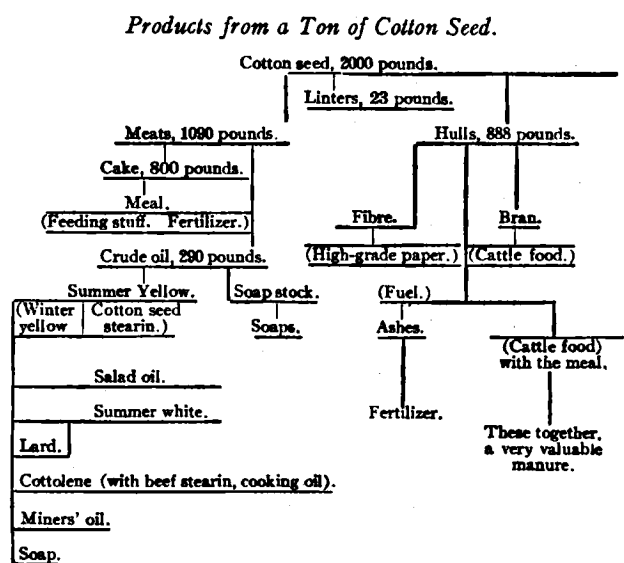

*Pests and Diseases of the Cotton Plant.*

**Insect Pests.**—It is common knowledge that when any plant is cultivated on a large scale various diseases and pests frequently appear. In some cases the pest was already present but of minor importance. As the supply of its favourite food plant is increased, conditions of life for the pest are improved, and it accordingly multiplies also, possibly becoming a serious hindrance to successful cultivation. At other times the pest is introduced, and under congenial conditions (and possibly in the absence of some other organism which keeps it in check in its native country) increases accordingly. Some idea of the enormous damage wrought by the collective attacks of individually small and weak animals may be gathered from the fact that a conservative estimate places the loss due to insect attacks on cotton in the United States at the astounding figure of \$60,000,000 (£12,000,000) annually. Of this total no less than \$40,000,000 (£8,000,000) is credited to a small beetle, the cotton boll weevil, and to two caterpillars. The best means of combating these attacks depends on a knowledge of the life-histories and habits of the pests. The following notes deal only with the practical side of the question, and as the United States produce some seven-tenths of the world's cotton crop attention is especially directed to the principal cotton pests of that country. Those of other regions are only referred to when sufficiently important to demand separate notice.

The cotton boll weevil (*Anthonomus grandis*), a small grey weevil often called the Mexican boll weevil, is the most serious pest of cotton in the United States, where the damage done by it in 1907 was estimated at about £5,000,000. It steadily increased in destructiveness during the preceding eight years. Attention was drawn to it in 1862, when it caused the abandonment of cotton cultivation about Monclova in Mexico. About 1893 it appeared in Texas, and then rapidly spread. It is easily transported from place to place in seed-cotton, and for this reason the Egyptian government in 1904 prohibited the importation of American cotton seed. Not only is the pest carried from place to place, but it also migrates, and in 1907 it crossed from Louisiana, where it first appeared in 1905, to Mississippi. That the insect is likely to prove adaptable is perhaps indicated by the fact that in 1906 it made a northward advance of about 60 m. in a season with no obvious special features favouring the pest. Its eastern progress was also rapid. "The additional territory infested during 1904 aggregates about 15,000,000 sq. m., representing approximately an area devoted to the culture of cotton of 900,000 acres" (*Year-book, U.S. Dept. Agriculture, 1904*). In 1906 the additional area invaded amounted to 1,500,000 acres (*Ibid., 1906*).

The adult weevils puncture the young flower-buds and deposit eggs; and as the grubs from the eggs develop, the bud drops. They also lay eggs later in the year in the young bolls. These do not drop, but as the grubs develop the cotton is ruined and the bolls usually become discoloured and crack, their contents being rendered useless.

No certain remedy is known for the destruction on a commercial scale of the boll weevil, but every effort has been made in the United States to check the advance of the insect, to ascertain and encourage its natural enemies, and to propagate races of cotton which resist its attacks. Special interest attaches to the investigations made by Mr O. F. Cook, of the U.S. Dept. of Agriculture, in Guatemala. The Indians in part of Guatemala raise cotton, although the boll weevil is abundant. Examination showed that although the weevil attacked the young buds these did not drop off, but that a special growth of tissue inside the bud frequently killed the grub. Also, inside the young bolls which had been pierced a similar proliferation or growth of the tissue was set up, which enveloped and killed the pest. Probably by unconscious selection of surviving plants through long ages this type has been evolved in Guatemala, and experiments have been made to develop weevil-resistant races in the United States. Mr Cook also found that the boll weevil was attacked, killed and eaten by an ant-like creature, the "kelep." Attempts have been made to introduce this into the infested area in Texas; but owing to the winter proving fatal to the "kelep" its usefulness may be restricted to tropical and subtropical regions.

The cotton boll worm (*Chloridea obsoleta*, also known as *Heliothis armiger*) is a caterpillar. The parent moth lays eggs, from which the young "worms" hatch out. They bore holes and penetrate into flower-buds and young bolls, causing them to drop. Fortunately the "worms" prefer maize to cotton, and the inter-planting at proper times of maize, to be cut down and destroyed when well infested, is a method commonly employed to keep down this pest. Paris green kills it in its young stages before it has entered the buds or bolls. The boll worm is most destructive in the south-western states, where the damage done is said to vary from 2 to 60% of the crop. Taking a low average of 4%, the annual loss due to the pest is estimated at about £2,500,000, and it occupies second place amongst the serious cotton pests of the U.S.A. The boll worm is widely spread through the tropical and temperate zones. It may occur in a country without being a pest to cotton, e.g. in India it attacks various plants but not cotton. It has not yet been reported as a cotton pest in the West Indies.

The Egyptian boll worm (*Earias insulana*) is the most important insect pest in Egypt and occurs also in other parts of Africa. Indian boll worms include the same species, and the closely related *Earias fabia*, which also occurs in Egypt.

The cotton worm (*Aletia argillacea*)—also called cotton caterpillar, cotton army worm, cotton-leaf worm—is also one stage in the life-history of a moth. It is a voracious creature, and unchecked will often totally destroy a crop. In former years the annual damage done by it in the United States was assessed at £4,000,000 to £6,000,000. Dusting with Paris green is, however, an efficient remedy if promptly applied at the outset of the attack. The annual damage was in 1906 reduced to £1,000,000 to £2,000,000, and this on a larger area devoted to cotton than in the case of the estimate given above. It is the most serious pest of cotton in the West Indies. The Egyptian cotton worm is *Prodenia littoralis*.

The caterpillars ("cut worms") of various species of *Agrotis* and other moths occur in all parts of the world and attack young cotton. They can be killed by spreading about cabbage leaves, &c., poisoned with Paris green.

Locusts, green-fly, leaf-bugs, blister mites, and various other pests also damage cotton, in a similar way to that in which they injure other crops.

The "cotton stainers," various species of *Dysdercus*, are widely distributed, occurring for example in America, the West Indies, Africa, India, &c. The larvae suck the sap from the young bolls and seeds, causing shrivelling and reduction in quantity of fibre. They are called "stainers" because their excrement is yellow

and stains the fibre; also if crushed during the process of ginning they give the cotton a reddish coloration. The Egyptian cotton seed bug or cotton stainer belongs to another genus, being *Oryzocarenum hyalinipennis*. Other species of this genus occur on the west coast of Africa. They do considerable damage to cotton seed.

**Fungoid Diseases.**—"Wilt disease," or "frenching," perhaps the most important of the fungoid disease of cotton in the United States, is due to *Neocosmospora vasinfecta*. Young plants a few inches high are usually attacked; the leaves, beginning with the lower ones, turn yellow, and afterwards become brown and drop. The plants remain very dwarf and generally unhealthy, or die. The roots also are affected, and instead of growing considerably in length, branch repeatedly and give rise to little tufts of rootlets. There is no method known of curing this disease, and all that can be done is to take every precaution to eradicate it, by pulling up and burning diseased plants, isolating the infected area by means of trenches, and avoiding growing cotton, or an allied plant such as the ochro (*Hibiscus esculentus*), in the field. Fortunately the careful work of the U.S. Department of Agriculture and of planters such as Mr E. L. Rivers of James Island, South Carolina, has resulted in the production of disease-resistant races. In one instance Mr Rivers found one healthy plant in a badly affected field. The seed was saved and gave rise to a row of plants all of which grew healthily in an infected field, whereas 95% of ordinary Sea Island cotton plants from seed from a non-infected field planted alongside as a control were killed. The resistance was well maintained in succeeding generations, and races so raised form a practical means of combating this serious disease.

In "Root rot," as the name implies, the roots are attacked, the fungus being a species of *Ozonium*, which envelops the roots in a white covering of mould or mycelium. The roots are prevented from fulfilling their function of taking up water and salts from the soil; the leaves accordingly droop, and the whole plant wilts and in bad attacks dies. It has yearly proved a more serious danger in Texas and other parts of the south-west of the United States, and the damage due to it in Texas during 1905 was estimated at about £750,000. No remedy is known for the disease, and cotton should not be planted on infected land for at least three or four years.

"Boll rot," or "Anthracnose," is a disease which may at times be sufficiently serious to destroy from 10 to 50% of the crop. The fungus which causes it (*Colletotrichum gossypii*) is closely related to one of the fungi attacking sugar-cane in various parts of the world. Small red-brown spots appear on the bolls, gradually enlarge, and develop into irregular black and grey patches. The damage may be only slight, or the entire boll may ripen prematurely and become dry and dead.

Many other diseases occur, but the above are sufficient to indicate some of the principal ones in the most important cotton countries of the world.

#### *Improvement of Cotton by Seed Selection.*

In the cotton belt of the United States it would be possible to put a still greater acreage under this crop, but the tendency is rather towards what is known as "diversified" or mixed farming than to making cotton the sole important crop. Cotton, however, is in increasing demand, and the problem for the American cotton planter is to obtain a better yield of cotton from the same area,—by "better yield" meaning an increase not only in quantity but also in quality of lint. This ideal is before the cotton grower in all parts of the world, but practical steps are not always taken to realize it. Some of the United States planters are alert to take advantage of the application of science to industry, and in many cases even to render active assistance, and very successful results have been attained by the co-operation of the United States Department of Agriculture and planters. With the improvement of cotton the name of Mr Herbert J. Webber is prominently associated, and a full discussion of methods and results will be found in his various papers in the *Year-books* of the U.S. Department of Agriculture. The principle on which the work is based is that plants have their individualities

and tend to transmit them to their progeny. Accordingly a selection of particular plants to breed from, because they possess certain desirable characteristics, is as rational as the selection of particular animals for breeding purposes in order to maintain the character of a herd of cattle or of a flock of sheep.

Inspection of a field of cotton shows that different plants vary as regards productiveness, length, and character of the lint, period of ripening, power of resistance to various pests and of withstanding drought. A simple method of increasing the yield is that practised with success by some growers in the States. Pickers are trained to recognize the best plants, "that is, those most productive, earliest in ripening, and having the largest, best formed and most numerous bolls." These pickers go carefully over the field, usually just before the second picking, and gather ripe cotton from the best plants only; this selected seed cotton is ginned separately, and the seed used for sowing the next year's crop.

A more elaborate method of selection is practised by some of the Sea Island cotton planters in the Sea Islands, famous for the quality of their cotton. A field is gone over carefully, and perhaps some 50 of the best plants selected; a second examination in the field reduces these perhaps to one half, and each plant is numbered. The cotton from each is collected and kept separately, and at the end of the season carefully examined and weighed, and a final selection is then made which reduces the number to perhaps five; the cotton from each of these plants is gained separately and the seed preserved for sowing. The simplest possible case in which only one plant is finally selected is illustrated in the diagram.

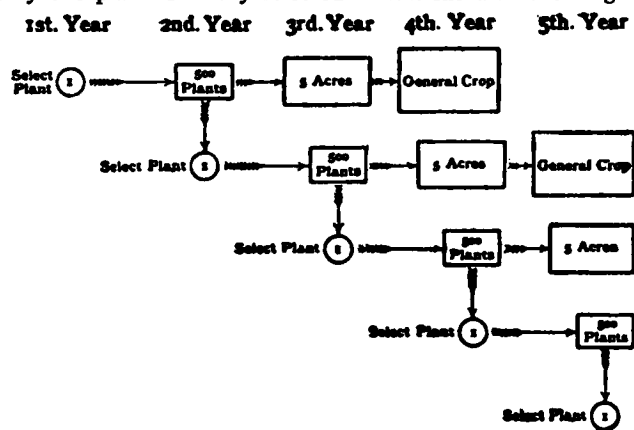

After Webber, *Year-book, U. S. Dept. of Agriculture, 1902.*

#### Improvement of Cotton by Seed Selection.

From the seeds of the selected plant of the 1st year about 500 plants can be raised in the next year. One plant is selected again from these 500, and the general crop of seed is used to sow about five acres for the 3rd year, from which seed is obtained for the general crop in the 4th year. One special plant is selected each year from the 500 raised from the previous season's test plant, and in four years' time the progeny of this plant constitutes the "general crop." The practice may be modified according to the size of estate by selecting more than one plant each year, but the principle remains unaltered. This method is in actual use by growers of Sea Island cotton in America and in the islands off the coast of S. Carolina; the greatest care is taken to enhance the quality of the lint, which has been gradually improved in length, fineness and silkiness. Mr Webber, in summing up, says, "When Sea Island cotton was first introduced into the United States from the West Indies, it was a perennial plant, unsuited to the duration of the season of the latitude of the Sea Islands of S. Carolina; but, through the selection of seed from early maturing individual plants, the cotton has been rendered much earlier, until now it is thoroughly adapted to the existing conditions. The fibre has increased in length from about  $1\frac{1}{4}$  to  $2\frac{1}{2}$  in., and the plants have at the same time been increased in productiveness. The custom of carefully selecting the seed has grown with the industry and may be said to be inseparable from it. It is only by such careful and con-

tinuous selection that the staple of these high-bred strains can be kept up to its present superiority, and if for any reason the selection is interrupted there is a general and rapid decline in quality."

When selection is being made for several characters at the same time, and also in hybridization experiments, where it is important to have full records of the characters of individual plants and their progeny, "score cards," such as are used in judging stock, with a scale of points, are used.

The improvements desired in cotton vary to some degree in different countries, according to the present character of the plants, climatic conditions, the chief pests, special market requirements, and other circumstances. Amongst the more important desiderata are:—

1. Increased Yield.
2. Increase in Length of Lint.—Webber records the case of Stamm Egyptian cotton imported into Columbia, in which by simple selection, as outlined above, during two years plants were obtained uniformly earlier, more productive, and yielding longer and better lint.
3. Uniformity in Length of the Lint.—This is important especially in the long-stapled cottons, unevenness leading to waste in manufacture, and consequently to a lower price for the cotton.
4. Strength of Fibre.—Long-stapled cottons have been produced in the States by crossing Upland and Sea Island cotton. These hybrids produce a lint which is long and silky, but often deficient in strength: selection for strength amongst the hybrids, with due regard to length, may overcome this.
5. Season of Maturing.—Seed should be selected from early and late opening bolls, according to requirements. Earliness is especially important in countries where the season is short.
6. Adaptation to Soil and Climate.—High-class cottons often do not flourish if introduced into a new country. They are adapted to special conditions which are lacking in their new surroundings, but a few will probably do fairly well the first year, and the seeds from these probably rather better the next, and so on, so that in a few years' time a strain may be available which is equal or even superior to the original one introduced.

7. Resistance to Disease.—The method employed is to select, for seed purposes, plants which are resistant to the particular disease. Thus sometimes a field of cotton is attacked by some disease, perhaps "wilt," and a comparatively few plants are but very slightly affected. These are propagated, and there are instances as described above of very successful and commercially important results having been attained. Special interest attaches to experiments made in the United States to endeavour to raise races of cotton resistant to the boll weevil.

8. Resistance to Weather.—Strong winds and heavy rains do much damage to cotton by blowing or beating the lint out of the bolls. In some instances a slight difference in the shape, mode of opening, &c., of the boll prevents this, and accordingly seed is selected from bolls which suffer least under the particular adverse conditions.

Attention has been paid in the West Indies to seed selection, by the officers of the imperial Department of Agriculture, with the object of retaining for West Indian Sea Island cotton its place as the most valuable cotton on the British market.

In India, where conditions are much more diversified and it is more difficult to induce the native cultivator to adopt new methods, attention has also been directed during recent years to the improvement of the existing races. Efforts have been made in the same direction in Egypt, West Africa, &c.

#### *The World's Commercial Cotton Crop.*

It is impossible to give an exact return of the total amount of cotton produced in the world, owing to the fact that in China, India and other eastern countries, in Mexico, Brazil, parts of the Russian empire, tropical Africa, &c., considerable—in some cases very large—quantities of cotton are made up locally into wearing apparel, &c., and escape all statistical record. It is estimated that the amount thus used in India exclusive of the consumption of mills is equivalent to about 400,000 bales. Neglecting, however,

these quantities, which do not affect the world's market, the annual supplies of cotton are approximately as follows:—

Country.	Approximate Production. Bales of 500 lb.	Percentage.
United States of America . . . . .	11,000,000	68.75
India . . . . .	3,000,000	18.75
Egypt . . . . .	1,000,000	6.25
All other countries . . . . .	1,000,000	6.25
<b>Total . . . . .</b>	<b>16,000,000</b>	<b>100.00</b>

In 1905 the world's crop closely approximated to 16,000,000 bales, whilst in 1904 it was nearly 19,000,000 bales and in 1906 nearly 20,000,000 bales. The United States produced very nearly seven-tenths of the total "visible" cotton crops of the world. This, however, is quite a modern development, comparatively speaking. "During the period from 1786 to 1790 the West Indies furnished about 70% of the British supply, the Mediterranean countries 20%, and Brazil 8%; whilst the quantity contributed by the United States and India was less than 1% and Egypt contributed none. In 1906 the United States contributed 65% of the commercial cotton, British India 19%, Egypt 7%, and Russia 3%. Of the countries which were prominent in the production of cotton in 1790, Brazil and Asiatic Turkey alone remain" (*U.S.A. Bureau of the Census, Bulletin No 76*). The actual figures for the chief countries for 1904-1906, taken from the same source, are as follows:—

The World's Commercial Cotton Crop. (In 500 lb Bales.)

Country.	1904.	1905.	1906.
United States . . . . .	13,085,000	10,340,000	13,016,000
British India . . . . .	2,843,000	2,519,000	3,708,000
Egypt . . . . .	1,258,000	1,181,000	1,400,000
Russia . . . . .	554,000	585,000	675,000
China . . . . .	468,000	415,000	418,000
Brazil . . . . .	210,000	258,000	275,000
Mexico . . . . .	114,000	125,000	130,000
Peru . . . . .	40,000	55,000	55,000
Turkey . . . . .	100,000	107,000	107,000
Persia . . . . .	45,000	47,000	47,000
Japan . . . . .	16,000	15,000	11,000
Other countries . . . . .	70,000	100,000	100,000
<b>Total . . . . .</b>	<b>18,803,000</b>	<b>15,747,000</b>	<b>19,942,000</b>

This table serves to indicate the principal countries contributing to the world's supply of cotton. The following notes afford a summary of the position of the industry in the more important countries.

**United States of America.**—The cultivation of cotton as a staple crop in the United States dates from about 1770,<sup>1</sup> although efforts appear to have been made in Virginia as far back as 1621. The supplies continued to be small up to the end of the century. In 1792 the quantity exported from the United States was only

<sup>1</sup> It is related that in the year 1784 William Rathbone, an American merchant resident in Liverpool, received from one of his correspondents in the southern states a consignment of eight bags of cotton, which on its arrival in Liverpool was seized by the custom-house officers, on the allegation that it could not have been grown in the United States, and that it was liable to seizure under the Shipping Acts, as not being imported in a vessel belonging to the country of its growth. When afterwards released, it lay for many months unsold, in consequence of the spinners doubting whether it could be profitably worked up.

equivalent to 275 bales, but by the year 1800 it had increased to nearly 36,000 bales. At the close of the war in 1815 the revival of trade led to an increased demand, and the progress of cotton cultivation in America became rapid and continuous, until at length about 85% of the raw material used by English manufacturers was derived from this one source. With a capacity for the production of cotton almost boundless, the crop which was so insignificant when the century began had in 1860 reached the enormous extent of 4,824,000 bales. This great source of supply, when apparently most abundant and secure, was shortly after suddenly cut off, and thousands were for a time deprived of employment and the means of subsistence. In this period of destitution the cotton-growing resources of every part of the globe were tested to the utmost; and in the exhibition of 1862 the representatives of every country from which supplies might be expected met to concert measures for obtaining all that was wanted without the aid of America. The colonies and dependencies of Great Britain, including India, seemed well able to grow all the cotton that could be required, whilst numerous other countries were ready to afford their co-operation. A powerful stimulus was thus given to the growth of cotton in all directions; a degree of activity and enterprise never witnessed before was seen in India, Egypt, Turkey, Greece, Italy, Africa, the West Indies, Queensland, New South Wales, Peru, Brazil, and in short wherever cotton could be produced; and there seemed no room to doubt that in a short time there would be abundant supplies independently of America. But ten years afterwards, in the exhibition of 1872, which was specially devoted to cotton, a few only of the *thirty-five* countries which had sent their samples in 1862 again appeared, and these for the most part only to bear witness to disappointment and failure. America had re-entered the field of competition, and was rapidly gaining ground so as to be able to bid defiance to the world. True, the supply from India had been more than doubled, the adulteration once so rife had been checked, and the improved quality and value of the cotton had been fully acknowledged, but still the superiority of the produce of the United States was proved beyond all dispute, and American cotton was again king. Slave labour disappeared, and under new and more promising auspices a fresh career of progress began. With rare combination of facilities and advantages, made available with remarkable skill and enterprise, the production of cotton in America seems likely for a long series of years to continue to increase in magnitude and importance. The total area of the cotton-producing region in the States is estimated at 448,000,000 acres, of which in 1906 only about one acre in fifteen was devoted to cotton. The potentialities of the region are thus enormous.

Cotton is now the second crop of the United States, being surpassed in value only by Indian corn (maize). The area devoted to this crop in 1879 was 14,480,019 acres, and the total

States and Territories.	Upland Cotton.		Sea Island Cotton.		Total Value.
	Quantity.	Value.	Quantity.	Value.	
	lb	\$	lb	\$	\$
Alabama . . . . .	603,651,989	60,425,564	..	..	60,425,564
Arkansas . . . . .	450,991,361	45,144,235	..	..	45,144,235
Florida . . . . .	17,876,133	1,789,401	9,031,896	2,587,638	4,377,039
Georgia . . . . .	750,762,910	75,151,367	9,950,634	2,850,857	78,002,224
Indian Territory . . . . .	196,648,765	19,684,542	..	..	19,684,542
Kansas . . . . .	9,844	985	..	..	985
Kentucky . . . . .	1,008,290	100,930	..	..	100,930
Louisiana . . . . .	473,222,310	47,369,553	..	..	47,369,553
Mississippi . . . . .	732,755,978	73,348,874	..	..	73,348,874
Missouri . . . . .	26,040,093	2,606,613	..	..	2,606,613
New Mexico . . . . .	74,340	7,442	..	..	7,442
North Carolina . . . . .	276,215,506	27,649,172	..	..	27,649,172
Oklahoma . . . . .	233,396,905	23,363,030	..	..	23,363,030
South Carolina . . . . .	415,386,362	41,580,175	2,723,859	999,656	42,579,831
Tennessee . . . . .	146,569,434	14,671,600	..	..	14,671,600
Texas . . . . .	2,001,181,289	200,318,247	..	..	200,318,247
Virginia . . . . .	6,609,963	661,657	..	..	661,657
<b>Total—United States</b>	<b>6,332,401,472</b> (=12,644,803 bales)	<b>633,873,387</b>	<b>21,706,389</b> (=43,413 bales)	<b>6,438,151</b>	<b>640,311,538</b>



commercial crop was 5,755,359 bales. In 1899 the acreage had increased to 24,275,101 and the crop to 9,507,786 bales. In 1906 the total area was 28,686,000 acres and the crop 13,305,265 bales.

The preceding table gives the quantity, value and character of the crop for each of the cotton-growing states in 1906, as reported by the Bureau of the Census.

**Mexico.**—Cotton is extensively grown in Mexico, and large quantities are used for home consumption. The cultivation is of very old standing. Cortes in 1519 is said to have received cotton garments as presents from the natives of Yucatan, and to have found the Mexicans using cotton extensively for clothing. From 1900 to 1905 the crop was about 100,000 bales per annum; the whole is consumed in local mills, and cotton is imported also from the United States.

**Brazil.**—The cotton-growing region in Brazil comprises a belt some 200 m. in width, in the north-eastern portion of the country, and a strip along the valley of the San Francisco, where a large amount of the present crop is produced. The cotton is known in commerce under the name of the place of export, e.g. Maceio, Pernambuco or Pernam, Ceära, Rio Grande, &c. The export fluctuates greatly.

	Bales of 500 lb.	Approx. Value.
1901 . . . . .	53,002	£500,000
1902 . . . . .	143,963	1,200,000
1903 . . . . .	126,896	1,300,000
1904 . . . . .	59,413	800,000
1905 . . . . .	107,887	1,000,000
1906 . . . . .	142,972	1,500,000

The total production in 1906 was estimated at about 275,000 bales, but only a portion was available for export, there being an increasing consumption in Brazil itself.

**Peru.**—Cotton is an important crop in Peru, where it has long been cultivated. Most of the crop is grown in the irrigated coastal valleys. With more water available, the output could be considerably increased, e.g. in the Piura district. "Rough Peruvian," the produce of one of the tree cottons, has a special use, as being rather harsh and wiry it is well adapted for mixing with wool. Egyptian cotton is also grown. The annual export is about 30,000 bales.

**British West Indies.**—Cotton was cultivated as a minor crop in parts of the West Indies as long ago as the 17th century, and at the opening of the 18th century the islands supplied about 70% of all the cotton used in Great Britain. Greater profits obtained from sugar caused the industry to be abandoned, except in the small island of Carriacou. In 1900 the Imperial Department of Agriculture and private planters began experiments with the object of reintroducing the cultivation, owing to the decline in value of sugar. The department was actively assisted by the

Cotton Production in the British West Indies: 1905-1906.<sup>1</sup>

Island.	Area in Acres.	Yield = Bales of 500 lb.	Average Price in Pence per lb.	Value of Lint and Seed.
Barbados . . . . .	2,000	959	15·2	£33,557
St Vincent . . . . .	790	330	18·0	13,557
Grenada (mostly <i>Marie galante</i> cotton) . . . . .	3,600	623	5·0	8,400
St Kitts . . . . .	1,000	241	15·0	8,380
Nevis . . . . .	1,700	240	13·0	8,364
Anguilla . . . . .	1,000	161	15·0	5,280
Antigua . . . . .	700	200	14·2	6,522
Montserrat . . . . .	770	196	15·0	6,789
Virgin Islands . . . . .	40	14	..	400
Jamaica . . . . .	1,500	123	..	4,025
Total . . . . .	12,900	3087	..	£95,274

British Cotton Growing Association, and the results have been very successful, as was shown at an exhibition held in Manchester in 1908. A supply of seed of a high grade of Sea Island cotton was obtained from Colonel Rivers's estate in the Sea Islands, S. Carolina, and so successful has the cultivation been that from some of the islands West Indian Sea Island cotton obtains a

<sup>1</sup> Taken with some modifications from the *Agricultural News* (1907), vi. p. 38.

higher price than the corresponding grade of cotton from the Sea Islands themselves.

In 1902 the total area under cotton cultivation in the British West Indies was 500 acres. The industry made rapid progress. In 1903 it was 4000; in 1905-1906 it was 12,900; and for 1906-1907 it was 18,166 acres. The table indicates the chief cotton-producing islands, the acreage in each, yield, average value per pound and total value of the crop in 1905-1906.

The whole of this crop was Sea Island cotton, with the exception of the "Marie galante" grown in Carriacou. Marie galante is a harsh cotton of the Peruvian or Brazilian type. The low yield per acre in this island, and also the low value of the lint per lb compared with the Sea Island cotton, is clearly apparent.

In 1906-1907 the acreage was substantially increased in many of the islands, e.g. Barbados from 2000 to 5000; St Vincent 700 to 1533; St Kitts and Anguilla 1000 to 1500 each; Antigua 700 to 1883. In Jamaica, on the other hand, it was reduced from 1500 to 300 acres.

**Spain.**—Cotton was formerly grown in southern Spain on an extensive scale, and as recently as during the American Civil War a crop of 8000 to 10,000 bales was obtained. It is considered that with facilities for irrigation Andalusia could produce 150,000 bales annually. The former industry was abandoned as other crops became more remunerative. The government is encouraging recent efforts to re-establish the cultivation.

**Malta.**—Cotton has long been cultivated in Malta, but the acreage diminished from 1750 acres in 1899 to 670 acres in 1906. A considerable quantity of the produce is spun and woven locally; e.g. in 1904 the export was equivalent to about 120 bales out of a total production of 330 bales, and in 1905 to 258 out of 333 bales (of 500 lb each).

**Cyprus** has a soil and climate suited to cotton, which was formerly grown here on a large scale. The rainfall is uncertain and low, however, never exceeding 40 in., and on the supply of water by irrigation the future of the industry mainly depends. The exports dwindled from 3600 bales in 1865 to 946 in 1905; great fluctuations occur, the export in 1904, for example, being only 338 bales. The cotton grown is rather short-stapled and goes mainly to Marseilles and Trieste. Some is used locally in the manufacture of cloth.

**Egypt.**—The position of Egypt as the third cotton-producing country of the world has already been pointed out, and the varieties grown and the mode of cultivation described. The introduction of the exotic varieties dates from the beginning of the 19th century. The industry was actively promoted by a Frenchman named Jumel, in the service of Mehemet Ali, from 1820 onwards with great success. The area under cotton is about 1,800,000 acres.

Cotton Production in Egypt.

1850 . . . . .	87,200 bales of 500 lb.
1865 . . . . .	439,000 " "
1890 . . . . .	798,000 " "
1904 . . . . .	1,258,000 " "
1905 . . . . .	1,250,000 " "
1906 . . . . .	1,400,000 " "

**The Egyptian Sudan.**—Egyptian cotton was cultivated in the Sudan to the extent of 21,788 acres in 1906 chiefly on non-irrigated land. The exports, however, are small, almost all the crop being used locally. The chief difficulties are the supply of water, labour and transport facilities. Lord Cromer in his report on the Sudan for 1906 remarks that: "There seems to be some reason for thinking that the future—or at all events the immediate future—of Sudan agriculture lies more in the direction of cultivating wheat and other cereals than in that of cultivating cotton."

**West Africa.**—Cotton has long been grown in the various countries on the west coast of Africa, ginned by hand or by very primitive means, spun into yarn, and woven on simple looms into "country cloths"; these are often only a few inches wide, so that any large cloths have to be made by sewing the narrow strips together. These native cloths are exceedingly durable, and many of them are ornamented by using dyed yarns and in other ways.

Southern Nigeria (Lagos) and northern Nigeria are the most important cotton countries amongst the British possessions on the coast. From the former there has been an export trade for many years which fluctuates remarkably according to the demand. Northern Nigeria is the seat of a very large native cotton industry, to supply the demand for cotton robes for the Mahomedan races inhabiting the country. The province of Zaria alone is estimated to produce annually 30,000 to 40,000 bales, all of which is used locally. Northern Nigeria contributes to the cotton exported from Lagos. The country offers a fairly promising field for development, especially now that arrangements have been made for providing the necessary means of transport by the construction of the new railways. The profits obtained from ground-nuts (*Arachis hypogea*) in Gambia, gold mining in the Gold Coast, and from products of the oil palm (*Elaeis guineensis*) in the palm-oil belt serve to prevent much attention being given to cotton in these districts.

*Exports of Cotton from Lagos.*

1865	.	.	.	868	bales of 500 lb.
1869	.	.	.	1785	" "
1900	.	.	.	48	" "
1901	.	.	.	15	" "
1902	.	.	.	25	" "
1903	.	.	.	582	" "
1904	.	.	.	1725	" "
1905	.	.	.	2578	" "

*Exports of Cotton from British West Africa, 1904, 1905 and 1906.*

	1904.	1905.	1906.
	Bales (500 lb.)	Bales (500 lb.)	Bales (500 lb.)
Gambia . . . . .	120	5	0
Sierra Leone . . . . .	56	139	176
Gold Coast . . . . .	115	50	186
Southern Nigeria and Lagos . . . . .	2296	2771	5392
Northern Nigeria . . . . .	574	250 <sup>1</sup>	712
Total . . . . .	3161	3215	6466

*Nyasaland (British Central Africa).*—The cultivation of cotton on a commercial scale is quite new in Nyasaland, and although general conditions of soil and climate appear favourable the question of transport is serious and labour is not abundant. The exports were equivalent to 2 bales of 500 lb in 1902–1903, 114 bales in 1903–1904, 570 bales in 1904–1905, 1553 bales in 1905–1906 and 1052 bales in 1906–1907. In the lower river lands Egyptian cotton has been the most successful, whilst Upland cotton is more suited to the highlands.

*British East Africa and Uganda.*—In these adjoining protectorates wild cottons occur, and suitable conditions exist in certain localities. Experimental work has been carried on, and in 1904 Uganda exported about 43 bales of cotton, and British East Africa about 177 bales. In 1906 the combined exports had risen to 362 bales, including a little from German East Africa. In 1904–1905 there were some 300 acres under cotton in British East Africa. Lack of direct transport facilities is a difficulty. Some of the native cottons are of fair quality, but Egyptian cotton appears likely to be best suited for growing for export.

*India* is probably the most ancient cotton-growing country. For five centuries before the Christian era cotton was largely used in the domestic manufactures of India; and the clothing of the inhabitants then consisted, as now, chiefly of garments made from this vegetable product. More than two thousand years before Europe or England had conceived the idea of applying modern industry to the manufacture of cotton, India had matured a system of hand-spinning, weaving and dyeing which during that vast period received no recorded improvement. The people, though remarkable for their intelligence whilst Europe was in a state of barbarism, made no approximation to the mechanical operations of modern times, nor was the cultivation of cotton either improved or considerably extended. Possessing soil, climate and apparently all the requisite elements from nature for the production of cotton to an almost boundless extent, and of a

<sup>1</sup> Approximately.

useful and acceptable quality, *India* for a long series of years did but little towards supplying the manufactures of other countries with the raw material which they required. Between the years 1788 and 1850 numerous attempts were made by the East India Company to improve the cultivation and to increase the supply of cotton in India, and botanists and American planters were engaged for the purpose. One great object of their experiments was to introduce and acclimatize exotic cottons. Bourbon, New Orleans, Upland, Georgia, Sea Island, Pernambuco, Egyptian, &c., were tried but with little permanent success. The results of these and similar attempts led to the conclusion that efforts to improve the indigenous cottons were most likely to be rewarded with success. Still more recently, however, experiments have been made to grow Egyptian cotton in Sind with the help of irrigation. Abassi has given the best results, and the experiments have been so successful that in 1904–1905 an out-turn of not less than 100,000 bales " was prophesied in the course of a few years " (Report of Director, Land Records and Agriculture). The average annual production in India approximates to 3,000,000 bales. The area under cotton in all British India is about 20,000,000 acres, the crop being grown in a very primitive manner. The bulk of the cotton is of very short staple, about three-quarters of an inch, and is not well suited to the requirements of the English spinner, but very large mills specially fitted to deal with short-stapled cottons have been erected in India and consume about one-half the total crop, the remainder being exported to Germany and other European countries, Japan and China. In 1906 the United Kingdom took less than 5% of the cotton exported.

*Cotton Production in British India.*<sup>1</sup>

1859	.	.	.	1,316,800	bales of 500 lb.
1904	.	.	.	3,172,800	" "
1905	.	.	.	2,848,800	" "
1906	.	.	.	4,038,400	" "

About 50% of the cotton produced is consumed in Indian mills and the remainder is exported.

*China.*—Cotton has not been cultivated in China from such early times as in India, and although cotton cloths are mentioned in early writings it was not until about A.D. 1300 that the plant was grown on any considerable scale. There are no figures obtainable as to the production, but it must be very large, considering that the crop provides clothing for a large proportion of the population of China. During recent years a considerable quantity of cotton has been exported, but more than a compensating amount of raw cotton, yarns and textiles, is imported. An estimate of the crop puts it at about 1,500,000 bales.

*Korea* is stated to have originally received its cotton plants from China some 500 years ago. Conditions are well adapted to the cultivation of the plant, and since the cessation of the Russo-Japanese War the Japanese have undertaken the development of the industry. Figures are difficult to obtain, but an official report from the Japanese Residency General in 1907 estimated the crop at about 214,000 bales, all being used locally. In the future Korea may become an important source of supply for Japan, especially if, as appears likely, Korea proves suited to the cultivation of American cotton.

*Japan* received cotton from India before China, and the plant is extensively grown, especially in West and Middle Japan. The production is not sufficient to meet the home demand; during the five years of normal trade before the war with Russia Japan imported annually about 800,000 bales of cotton, chiefly from British India, China and the United States, and during the same period exported each year some 2000 bales, mainly to Korea.

*Dutch East Indies.*—In Java and other Dutch possessions in the East cotton is cultivated. A considerable amount is used locally, and during the six years ending in 1907 the surplus exported ranged from about 24,000 to 40,000 bales per annum.

*Russia.*—Some cotton is produced in European Russia in the southern Caucasus, but Turkestan in central Asia is by far the

<sup>1</sup> Cotton Production 1906, U.S.A. Bureau of the Census, Bulletin No. 76.

more important source of Russian-grown cotton. In this region cotton has been cultivated from very early times to supply local demands, and to a minor degree for export. Since about 1875 the Russians have fostered the industry, introducing American Upland varieties, distributing seed free, importing gins, providing instruction, and guaranteeing the purchase of the crops. The Trans-Caspian railway has been an important factor; almost all the cotton exported passes over this line, and the statistics of this trade indicate the progress made. The shipments increased from 250,978 bales in 1896-1897 to 495,962 bales in 1901-1902—part, however, being Persian cotton. The production of cotton in Russia in 1906 was estimated at 675,000 bales of 500 lb each. About one-third of the cotton used in Russian mills is grown on Russian territory, the remainder coming chiefly from the United States.

*Asia Minor.*—Smyrna is the principal centre of cotton cultivation in this region. A native variety known as "Terli," and American cotton, are grown. The general conditions are favourable. According to the Liverpool *Cotton Gazette*, Asiatic Turkey produced in 1906 about 100,000 bales, and Persia about 47,000 bales. Cotton was formerly cultivated profitably in Palestine.

*Australasia.*—The quantity of cotton now produced in Australasia is extremely small. Queensland, New South Wales and South Australia possess suitable climatic conditions, and in the first-named state the cotton has been grown on a commercial scale in past years, the crop in 1897 being about 450 bales. Considerable interest attaches to the "Caravonica" cotton raised in South Australia, which has been experimented with in Australia, Ceylon and elsewhere. It is probably a hybrid between Sea Island and rough Peruvian cotton, but lacks most of the essential features of Sea Island.

In *Fiji* the cotton exported in the 'sixties and 'seventies was worth £93,000 annually; but the cultivation has been practically abandoned. In 1899 about 60 bales, and in 1900 about 6 bales, were exported. During 1901-1903 there were no exports of cotton, and in 1904 only 70 bales were sent out.

Into the *Society Islands* Sea Island cotton was introduced about 1860-1870. Up to the year 1885 there was an average yearly export equivalent to about 2140 bales of 500 lb, after which date the export practically ceased. The industry has, however, been revived, and in 1906 over 100 bales, valued at £1052, were exported. (W. G. F.)

MARKETING AND SUPPLY

In the days of slave-grown cotton, the American planters, being men of wealth farming on a large scale, consigned the bulk of their produce as a rule direct to the ports. Now, however, a large proportion of the crop is sold to local store-keepers who transfer it to exporting firms in neighbouring cities. The cultivators, whether owners of the plantations, as is usual in some districts, or tenants, as is customary in others, are financed as a rule by commission agents. The decline of "spot" sales at the ports, partly but not entirely in consequence of the appearance of the small cultivator, has proceeded steadily. Hammond<sup>1</sup> has constructed a table from information supplied by the secretaries of the cotton exchanges at New York, Charleston, Savannah, Mobile, New Orleans and Galveston, showing the sales of "spot" cotton at those ports for the twenty-two years between 1874-1875 and 1895-1896, and in all cases an absolute decline is evident. The receipts of cotton in the season 1904-1905 at the leading interior towns and ports of the United States are given below.

Receipts of Cotton at 28 Interior Towns.  
(In Thousand Statistical Bales of 500 lb each.)

Brenham, Tex. . . . .	17	Memphis, Tenn. . . . .	984
Dallas, Tex. . . . .	96	Nashville, Tenn. . . . .	19
Shreveport, La. . . . .	256	Selma, Ala. . . . .	126
Little Rock, Ark. . . . .	219	Montgomery, Ala. . . . .	211
Helena, Ark. . . . .	91	Eufaula, Ala. . . . .	29
Vicksburg, Miss. . . . .	100	Columbus, Ga. . . . .	74
Columbus, Miss. . . . .	57	Macon, Ga. . . . .	87
Natchez, Miss. . . . .	76	Albany, Ga. . . . .	35

<sup>1</sup> *Cotton Culture and the Cotton Trade*, p. 298.

Atlanta, Ga. . . . .	134	Houston, Tex. . . . .	2,423
Rome, Ga. . . . .	72	Meridian, Miss. . . . .	133
Augusta, Ga. . . . .	446	Cincinnati, Ohio . . . . .	167
Columbia, S.C. . . . .	68	Yazoo City, Miss. . . . .	65
Newberry, S.C. . . . .	17		
Charlotte, N.C. . . . .	21	Total . . . . .	6712
Raleigh, N.C. . . . .	19		
St Louis, Mo. . . . .	672	Crop. . . . .	13,565

Receipts of Cotton at American Ports.  
(In Thousand Statistical Bales of 500 lb each.)

Galveston, Tex. . . . .	2,879	Boston, Mass. . . . .	84
New Orleans, La. . . . .	2,690	Philadelphia, Pa. . . . .	14
Mobile, Ala. . . . .	330	Brunswick, Ga. . . . .	200
Savannah, Ga. . . . .	1,877	Pensacola, Fla. . . . .	187
Charleston, S.C. . . . .	225	Minor Ports . . . . .	518
Wilmington, N.C. . . . .	375		
Norfolk, Va. . . . .	820	Total . . . . .	10,295
Baltimore, Md. . . . .	62		
New York . . . . .	34	Crop . . . . .	13,565

Galveston and Savannah have risen considerably in relative importance of late years.

Before the Civil War each planter would have his own gin-house. Now, however, ginning is a distinct business, and one gin will serve on an average about thirty farmers. Moveable gins were tried for a time in some places; they were dragged by traction engines from farm to farm, like threshing machines in parts of England, but the plan proved uneconomical because, among other reasons, farmers were not prepared to meet the cost of providing facilities for storing their cotton. In addition to the small country ginneries, large modern ginneries have now been set up in all the leading Southern market towns. The cotton is pressed locally and afterwards "compressed" into a very small compass. The bales are usually square, but cylindrical bales are becoming more common, though their cost is greater. In the latter, the cotton is arranged in the form of a rolled sheet or "lap." Owing to complaints of the careless packing of American cotton, attention has been devoted of late to the improvement of the square bale.

Ginning and packing.

London used to be the chief cotton port of England, but Liverpool had assumed undisputed leadership before the 19th century began. Some arrivals have been diverted to Manchester since the opening of the Manchester ship canal; shipments through the canal from the 1st of September to the 30th of August in each year for the decade 1894-1895 to 1904-1905 are appended—six to eight times as much is still unloaded at Liverpool.

English ports of entry.

A Manchester cotton-importing company was recently formed for increasing deliveries direct to Manchester, and establishing a "spot" market there, an end to which the Manchester Cotton Association had directed its efforts for some time past. The latter association was established at the end of 1894, with a membership of 265, in the interests of those spinners who desired importations direct to Manchester. The objects of the association are officially stated to be: (1) to frame suitable and authoritative forms of contract, and to make rules and regulations for the proper conduct of the trade; (2) to supervise and facilitate the delivery of the importations of cotton at the Manchester docks to the various consignees; (3) to provide and maintain trustworthy standards of classification; (4) to procure and disseminate useful information on all subjects pertaining to the trade; (5) to act in concert with chambers of commerce and other bodies throughout the world for mutual protection; (6) to establish a market for cotton at Manchester. Spinning members preponderate, but almost all the Manchester cotton merchants and cotton brokers have also joined the association. The importance of the original spinners' representation on the association is shown by the fact that they worked over 14,000,000 spindles: in December 1905 the spindles represented by members had risen to nearly 20,000,000. Some 73,000 looms are also represented. As most of the Lancashire cotton mills lie far from Manchester, direct importations to that city do not usually dispense with a "handling," and frequently save little or nothing in freight rates, though in some cases the economy derived from direct importation is considerable. One gain accruing to Lancashire from the

Canal, however, is that its competition has brought down railway rates.

Fundamental alterations have been made in the structure of the leading cotton markets, and in methods of buying and selling cotton, in the last hundred years. We shall not attempt to trace the changes as they appeared in every market of importance, but shall confine our attention to one only, and that perhaps the most important of all, namely, the market at Liverpool. This selection of one market for detailed examination does not rob our sketch of generality, as might at first be thought, since broadly the history of the development of one market is the history of the development of all, and on the whole the economic explanation of the evolution that has taken place may be universalized.

*Cotton market methods.*

with less easy terms for payment than were usual in Manchester, prevented any great numbers from departing from the beaten track. Cotton dealers up to this time had regularly financed the spinners, who were frequently men of little capital, by allowing long credit, and had even employed them to spin on commission. As men of substance increased among the ranks of the spinners, the Manchester cotton dealers found it impossible to retard a movement set on foot by the prospects of such appreciable advantages. Ultimately many of the old Manchester cotton dealers became brokers for their old customers. In 1875 there were said to be upwards of 100 cotton dealers in Manchester, but from that time onward their members steadily declined. It is interesting to observe that a later development of transport between Manchester and Liverpool, namely, the Manchester

*Cotton landed at the Port of Manchester since the Canal was opened.*

(In thousand Bales.)

The season is from the 1st of September to the 31st of August each year.

	Jan. 1894, to Aug. 31, 1894.	Season 1894-1895.	Season 1895-1896.	Season 1896-1897.	Season 1897-1898.	Season 1898-1899.
American . . . . .	21	32	121	211	245	311
Egyptian . . . . .	1.4	34	68	88	98	84
East Indian . . . . .	..	..	..	..	..	..
West African . . . . .	..	..	..	..	..	..
Total . . . . .	22	66	189	299	344	395
Total American Crop <sup>1</sup> . . . . .	7,549	9,901	7,157	8,757	11,199	11,274
Total Egyptian Crop (in bales of 7½ cantars) <sup>2</sup> . . . . .	657	615	703	783	872	745
	Season 1899-1900.	Season 1900-1901.	Season 1901-1902.	Season 1902-1903.	Season 1903-1904.	Season 1904-1905.
American . . . . .	415	442	421	478	365	552
Egyptian . . . . .	136	107	125	145	148	183
East Indian . . . . .	..	..	..	2.5	6	1.3
West African . . . . .	..	..	..	..	..	.1
Total . . . . .	551	549	546	626	519	736
Total American Crop <sup>1</sup> . . . . .	9,436	10,383	10,680	10,727	10,011	13,565
Total Egyptian Crop (in bales of 7½ cantars) <sup>2</sup> . . . . .	868	723	849	778	867	846

Originally cotton was imported by the Liverpool dealer as an agent for American firms or at his own risk, and then sold by private treaty, auction, or through brokers, to Manchester dealers, who retailed it to the spinners. This statement is, of course, only roughly correct.

Some Manchester dealers imported themselves, and some spinners bought direct from Liverpool importers, but the rule was the arrangement first described. Early in the 19th century it became customary for Manchester dealers and Liverpool importers to carry on business with one another through representatives known as "buying" and "selling" brokers. About this time the broker of cotton only began to specialize from the ranks of the brokers who dealt in all kinds of colonial produce. Previously there had not been enough business done in cotton to make it worth any person's while to devote himself to the buying and selling on commission of cotton only. The evolution of the distinct business of cotton broking is readily comprehensible when we remind ourselves that the requirements, as regards raw material, of all spinners are much alike generally, and that no spinner could afford to pay an expert to devote himself entirely to purchasing cotton for his mill.

So far change had been gradual, but the success of the Manchester and Liverpool railway undermined beyond repair the old system of doing business. Spinners could easily run over to Liverpool and buy their cotton from the large stocks displayed at that port. Before the railway was opened some spinners had been in the habit of making their purchases of raw material in Liverpool, but the great inconveniences of the journey, combined

Ship Canal, has drawn back into Manchester a part of the cotton market which was attracted from Manchester into Liverpool by the famous improvement in transport opened to the public three-quarters of a century ago.

The centralization of the cotton market in Liverpool fixed firmly the system of buying through brokers, for the Liverpool importer, or his broker, was in no sense a professional adviser to the spinners, informally pledged to advance the latter's interests, as the old Manchester dealers had been. The system was rendered comparatively inexpensive by the drop in commissions from 1 to ½% which had followed the adoption of selling by sample. This custom of buying and selling through brokers continued unshaken until the laying of the Atlantic cable tempted selling brokers occasionally, and even some buying brokers, to buy direct from American factors by telegraph and thus transform themselves into quasi-importers. The temptation was made the more difficult to resist by the development of "future" dealings. When the agents of the spinners, that is, the buying brokers, by becoming principals in some transactions, had acquired interests diametrically opposed to those of their customers, the consequent feeling of distrust among spinners gave birth to the Cotton Buying Company, which, constituted originally of twenty to thirty limited cotton-spinning companies, represents to-day nearly 6,000,000 spindles distributed among nearly one hundred firms. Its object was to squeeze out some middlemen and economize for its members on brokerage. This company, it is said, helped to attract the brokers back to the spinners, and an informal understanding was arrived at that the buying broker should not figure both as agent and principal in the same transaction.

<sup>1</sup> Commercial crop.

<sup>2</sup> A cantar is 99.05 lb avoirdupois.

By 1876 "forward" operations had become so vast and complicated that a cotton-clearing house had to be established to deal with the confusing networks of debits and credits created by them. Its principle was exactly that of the clearing houses used by the railways and the banks, the cancellation of indebtedness and discharge simply of balances. The final settlement of a "future" contract involved usually a crowd of persons, and the passage of large sums of money backwards and forwards, so that the amount of cash required for circulation on the exchange became unreasonably excessive and an annoying waste of time was entailed. The cotton-clearing house substituted book-keeping for the bulk of these payments. The establishment of the Cotton Bank naturally followed. Now debts are discharged in the first instance by vouchers. Dealers pass their debit and credit vouchers into the Cotton Bank and pay or receive the balances which they owe or are entitled to. In order to protect dealers against the losses due to the insolvency of those with whom they have had transactions, weekly settlements on the exchange have been made compulsory; between brokers and their clients they are also usual. At the settlement, every member of the exchange receives the "differences" owing to him and pays those which he has incurred. Thus if a person holds futures for 10,000 bales which stood at 5.20 on the last settlement day and now stand at 5.30, and in the course of the previous week has sold 5000 bales of "futures" at 5.10, he receives  $10,000 \times \frac{1}{100}$ d. on his old holding, and has to pay  $5000 \times \frac{1}{100}$ d. on his sales, and therefore on balance neither receives nor pays. Differences may be very large sums. The unit of a "future" being 100 bales, an alteration in the price of cotton of .01d. causes a difference on each unit of £2. Periodic settlements are obviously periodic tests of the solvency of dealers. If the test of the settlement were not frequently applied, speculators who were unfortunate would be tempted to plunge deeper until finally some became insolvent for large sums. As it is, the speculator who has incurred losses beyond his means tends to be discovered before his creditors are heavily involved. Settlement days fall on Thursday, and the closing prices on the preceding Monday are taken as the basis of the settlement. From all differences interest at 5% is deducted for the time between settlement day and the tenth day of the second month on which the "future" elapses, since settlement terms mean that money is paid in instalments before it is actually due. To the admission of periodic settlements there was for a time vehement opposition on the ground that the door would be opened to gambling on "differences." Hence at first, in 1882, they were used only by a section of the market constituted of members who had voluntarily agreed to do business with one another upon these terms alone. By 1884, however, the advantages of "settlement terms" became so evident that they were adopted by the Cotton Association, at first for fortnightly periods, with the saving clause originally that they should not be compulsory.

As soon as the clearing house was set up it became evident that "futures" were an impossibility away from it. At the same time "futures" were becoming an increasing necessity to importers, because through "futures" alone could they hedge on their purchases of cotton, or buy when the market seemed favourable, and they were not prepared to assume heavy risks. Now from the clearing house importers were rigorously excluded, and on invoking the aid of "futures," therefore, they were penalized to the extent of double broker's commission, one commission being charged on the sale of the "futures" and one on their purchase back. The importers, therefore, found it necessary to establish a club of their own, the Liverpool Cotton Exchange, which they as rigorously guarded against brokers. The split in the market so caused was so damaging to both parties that a satisfactory arrangement was eventually agreed upon, and both institutions were absorbed in the Liverpool Cotton Association.

A condition of specialist dealers working to the public service is that they should not act in the dark. They must watch demand, be able to form reasonable anticipations of its move-

ments, and at the same time know the existing stocks of cotton, the sales taking place from day to day, and the best forecasts of the coming supplies. A man accustomed to devote the whole of his time to the study of demand and supply in relation to cotton, after some years of experience, will be qualified ordinarily to form fairly accurate judgments of the prices to be expected. His success depends upon his ability to interpret rightly the facts and intangible signs with which he is brought in contact. The information at the disposal of dealers has steadily enlarged in volume and improved in trustworthiness, though some of it is not yet invariably above suspicion, and the time elapsing between an event and the knowledge of it becoming common property has been reduced to a fraction of what it used to be, in consequence chiefly of the telegraph and cables. All sales that take place on the Exchange must be returned. Estimates are published of the area under cotton cultivation, and conditions of the American crop are issued by the American agricultural bureau at the beginning of the months of June, July, August, September and October of each year. To represent the standard of perfect healthiness and exemption from injury due to insects, or drought, or any other causes, one hundred is taken. The estimates for 1901 to 1905 are given, to illustrate their variations:—

Year.	June 1st.	July 1st.	Aug. 1st.	Sept. 1st.	Oct. 1st.
1901	81.5	81.1	77.2	71.4	61.4
1902	95.1	84.7	81.9	64.0	58.3
1903	74.1	77.1	79.7	81.2	65.1
1904	83	88	91.6	84.1	75.8
1905	77.2	77	74.9	72.1	71.2

These estimates are the averages of separate estimates which are published for the states of North Carolina, South Carolina, Georgia, Florida, Alabama, Mississippi, Louisiana, Texas, Arkansas, Tennessee. The official figures are supplemented from time to time by numerous private forecasts, for instance those in "Neill's circular." Ellison, in his work on the cotton trade of Great Britain, traces in detail the increase in the volume of information collected and made public. At the close of the 18th century there was a tacit understanding among brokers to supply one another with information. There were no printed circulars, except the monthly prices current of all kinds of produce, but brokers used to send particulars of business done to their customers in letters. These letters were the origin of circulars. Messrs Ewart and Rutson pioneered in 1805 by issuing a weekly account of the sales and imports of cotton, and three years later three such circulars were on the market, though Hope's alone was confined to cotton. For the first associated circular of any importance, the market had to wait until 1832. The issue of this circular by subscribing firms, on the basis of particulars collected by brokers appointed at a weekly meeting, gave rise in 1841 to the Cotton Brokers' Association, to which the development of the market by the systematizing of procedure is largely due. The rest of the tale may be told in Mr Ellison's own words:—

"Down to 1864 the leading firms continued to issue weekly market reports, but in that year the association commenced the publication of an associated circular. This was followed in the same year by the *Daily Table* of sales and imports, which in 1874 was succeeded by the present more complete *Daily Circular*. To these publications were at various times added the annual report, issued in December, the American crop report, issued in September, and the daily advices by cable from America, issued every morning."<sup>1</sup>

We shall now enter upon a detailed analysis of "forward" operations. The term "futures" is used broadly and narrowly: broadly it is a generic term denoting "futures" in the narrow sense, and also "options" and "straddles"; narrowly it implies merely contracts for future delivery at a price fixed in the present. Again we must distinguish between the "future" contracts for the delivery of a particular kind of cotton, which may be entered into by spinners and their brokers, and are real purchases in the sense that the spinners want delivery of the cotton referred to, and the "futures," which always relate

<sup>1</sup> *The Cotton Trade of Great Britain*, by Thomas Ellison, p. 186.

**Cotton-Clearing house, Cotton Bank and periodic settlement of "differences."**

**Publication of information relating to demand and supply.**

**Origin of Liverpool Cotton Association.**

**Futures.**



to the same grade of cotton, and are drawn up according to certain forms and circulate on the exchange as media for the shifting of risks connected with purchase and sale. The latter are not "real" purchases in the sense given to that term above, but fictitious because delivery of the cotton is not desired. It will no doubt aid the understanding of the functions of the latter if some explanation is offered of the needs met by the former, which are sometimes known technically as "deferred deliveries."

When a spinner is required to quote prices of yarn for delivery in the future he is fixed on the horns of a dilemma. If he does not

**The spinner's risks.**

at once buy cotton, but quotes on the assumption that price will remain steady, he may be involved in serious loss through his estimate being mistaken. If he determines to buy cotton at once, others who risk more, and trust their judgment of the future, may secure the contract. On first thoughts it would seem desirable that all spinners should buy cotton outright to cover their contracts, but on second thoughts the social disadvantage of their doing so becomes apparent. Much buying might take place when stocks were scanty, with the result that prices would be needlessly forced up; and when stocks were plentiful demand might be weak and prices, therefore, be unduly depressed. It is evident that the buying of cotton on the principles suggested would be calculated to cause great unsteadiness of prices, especially as cotton is not continuously forthcoming, but is produced periodically in harvests. Demands for yarn cannot be expected to come always at the most favourable time socially for the distribution of the cotton. One way out of the difficulty is that the spinner should exercise his judgment and buy his raw material at what seems to him the most suitable times. But to this course there are three objections. The first is that spinners would be performing the two functions of industrial management and cotton buying (together with others perhaps), and that in consequence the best industrial men would not necessarily be able to maintain their position in the trade because as buyers of cotton they might be unfortunate. The second is that spinners being required to give attention to two distinct classes of problems would be less likely as a body to become complete masters of either. The third, which is not distinct in principle from the two preceding, is that such limited speculation in cotton buying on the part of spinners worried with other matters would not be likely to steady the cotton market in any high degree. It may be assumed as desirable that the demand for cotton should be so spread as to keep its price as steady as possible—"steadiness" will be defined more exactly later—and that to this end it is essential that specialists should devote themselves to the task of spreading it. Such specialists have appeared in the cotton brokers and dealers who make their living out of bearing the risks connected with anticipating demand and supply in relation to cotton. To-day a spinner who is asked to quote for deliveries of yarn for, say, the next six months, may obtain from a broker quotations for deliveries of the cotton that he needs, in quantities as he needs it, for the next six months, and upon these quotations he may base his own for yarn. If a spinner is pressed by a shipper to make quotations with refusal for two or three days to give time for business to be settled by cable, it is evidently not impossible for the spinner to shift the risk involved by getting in turn from his broker refusal quotations for cotton. But spinners do not try always to take the safest course.

Now it is evident that brokers in turn require some means of passing on the risks that they are bearing, or some portion of them

**Method of distributing risks.**

from one to another, or of sharing them with other market experts, as they find themselves overburdened, and as their judgment of the situation changes. The means have been provided in the "futures" which circulate on the Cotton Exchange. The risks of anticipating are carried by those who create or hold "futures" without a hedge. In order to facilitate business, "futures" are all drawn in the same unit (100 bales), and are all based on the same class of cotton, namely Upland cotton of middling grade of "no staple" (i.e. with a fibre of about  $\frac{3}{4}$  in.) and of the worst growth. American cotton, we may remind the reader, is graded into a number of classes, both on the Liverpool and New York Ex-

changes, and an attempt is made in each market to keep the grades as fixed as possible. But what, it may be inquired, is the value of "futures" relating to "middling" cotton to a broker whose contracts with spinners are not in "middling" cotton? The answer is that though the ratios between the prices of the various grades alter, the prices of all of them move generally together, and that the "futures" of the Exchange at least provide a hedge against the latter movements. Other things being equal, the broker would be better off if he could hedge with equal ease against all his risks. But other things are not equal: the market would be more confusing and quotations would be complicated if "futures" were in use for all grades.

We may now examine the exchange "futures" in minuter detail. They are quoted as a rule for about ten months ahead. Thus in January the futures quoted will be January (technically termed "current," "present month" or "near month," "futures"), January-February, February-March, March-April, April-May, May-June, June-July, July-August, and perhaps two or three more. Each group, it will be observed, except "current futures," culminates in two defined months. The rule is that on the first of the two months the seller of "futures" may, and before the last day of the second month must, deliver cotton against them, or, what comes to the same thing, buy back the "futures" on the basis of the price of "spot" cotton of middling grade. Various grades of cotton are tenderable against "futures": if this were not so "futures" would be in danger of defeating their object, because the price of the grade upon which they were founded would probably at times be thrown widely out of relation to the general level of prices in the cotton market. The lowest grade tenderable used to be "low middling," but since October 1901 "good ordinary" has also been accepted. Arbitrators report on deliveries and award allowances on those of grades above "middling" and deductions of price from those below. A sample is taken from each bale and the "points on or off" are fixed for each bale separately. If either party is dissatisfied with the award, he may appeal to an appeals committee on paying £3:3:0 which is refunded to him by the other party if the appeal be upheld. The detailed arrangements described above are those of the Liverpool market. The great bulk of "futures," however, are bought back and not delivered against.

Beneath are the official Liverpool quotations of "futures," as they appeared on the morning of the 19th of April 1906:—

**Characteristics of "futures."**

**Quotations.**

*American Deliveries, any port, basis of middling, good ordinary clause (the fractions are given in 100ths of a penny).*

	Yesterday's Close.	To-day's Early Sales.	Values 12.15.
April . . . . .	6.05		6.03
April-May . . . . .	6.05		6.03
May-June . . . . .	6.05	6.06, 5, 4, 3, 2, 1, 2, 3	6.03
June-July . . . . .	6.05	6.05, 2, 1, 3	6.03
July-August . . . . .	6.04	6.05, 4, 3, 2	6.03
Aug.-Sept. . . . .	5.98	5.99, 8, 6	5.97
Sept.-Oct. . . . .	5.34	5.85, 4	5.84
Oct.-Nov. . . . .	5.76	5.77, 6	5.76
Nov.-Dec. . . . .	5.75	5.75, 4 <sup>1</sup>	5.75
Dec.-Jan. . . . .	5.74	5.75 <sup>1</sup>	5.75
Jan.-Feb. . . . .	5.75	5.75 <sup>1</sup>	5.75

	Late Business.	Closing Values.
April . . . . .	6.03 <sup>1</sup>	5.98
April-May . . . . .	6.03	5.98
May-June . . . . .	6.03, 4, 3, 2, 1, 2, 0	5.99
June-July . . . . .	6.04, 3, 2	5.99
July-Aug. . . . .	6.03, 4, 3, 2, 1, 0, 1, 2, 1, 0, 5.99, 6.0, 5.99, 8	5.98
Aug.-Sept. . . . .	5.98, 1, 6, 5, 4, 5	5.92
Sept.-Oct. . . . .	5.84, 2 <sup>1</sup>	5.78
Oct.-Nov. . . . .	5.76, 1, 5, 1, 4, 3, 4, 3, 1, 2, 1, 0	5.70
Nov.-Dec. . . . .	5.70 <sup>1</sup>	5.69
Dec.-Jan. . . . .	5.72, 1, 2 <sup>1</sup>	5.69
Jan.-Feb. . . . .		5.69

<sup>1</sup> Transactions of 100 bales only.

Egyptian Deliveries, fully good fair (in 64ths of a penny).

	Yesterday's Close.	Business before Noon.	To-day's Business Afternoon.	Closing Values.
April . . . . .	10-11			10-1
May . . . . .	10-12	9-62, 3, 10-0	10-2 <sup>1</sup>	10-1
June . . . . .	10-11	9-63, 2, 10-0		10-0
July . . . . .	10-9	9-60, 1, 0 <sup>1</sup>	9-63, <sup>1</sup> 10-0, <sup>1</sup> 9-63, 2	9-62
Aug. . . . .	10-0			9-54
Sept. . . . .	9-58			9-48
Oct. . . . .	9-24			9-18
Nov. . . . .	8-58	8-52, <sup>1</sup> 0. 49		8-52
Dec. . . . .	8-50	8-39 <sup>1</sup>		8-42
Jan. . . . .	8-44	8-36		8-35

Egyptian futures, it will be observed, run out in single months. As the cost of dealing in "futures" is only one shilling on each transaction for a member of the Cotton Exchange (the outsider is charged in addition a commission by his broker), it is not surprising that the transactions taking place in "futures" number legion.

The methods of dealing in cotton are very intricate, and it is necessary here to interpolate an explanation of the relations between the prices paid by spinners for cotton and the quoted "spot" prices. We begin by giving the official quotations of "spot," and statement of business done, published on the morning of the 19th of April 1906.

Quotations.

	G.O.	L.M.	Mid.	G.M.	F.G.M.	M.F.
American . . . . .	5-87	6-05	6-21	6-41	6-49	6-71
		Mid Fair.	Fair.	Gd. Fair.		
Pernam . . . . .		5-95		6-35	6-61	
Ceara . . . . .		6-02		6-40	6-62	
Paraiba . . . . .		5-94		6-32	6-56	
Maceio . . . . .		5-96n		6-34n	6-56n	
		Fair.	Gd. Fair.	F.G.F.	Good.	Fine.
Egyptian br'n . . . . .	8 <sup>1</sup> / <sub>2</sub>	9 <sup>1</sup> / <sub>2</sub>	10 <sup>1</sup> / <sub>2</sub>	11	11 <sup>1</sup> / <sub>2</sub>	
" Upper . . . . .	—	9 <sup>1</sup> / <sub>2</sub>	9 <sup>1</sup> / <sub>2</sub>	9 <sup>1</sup> / <sub>2</sub> n	10n	
		Gd. Fr.	F.G.F.	Gd.	G.F.	Fine.
M. G. Broach . . . . .		4 <sup>1</sup> / <sub>2</sub> n	4 <sup>1</sup> / <sub>2</sub> n	4 <sup>1</sup> / <sub>2</sub> n	4 <sup>1</sup> / <sub>2</sub> n	5 <sup>1</sup> / <sub>2</sub> n
Bhownuggar . . . . .		4 <sup>1</sup> / <sub>2</sub> n	4 <sup>1</sup> / <sub>2</sub> n	4 <sup>1</sup> / <sub>2</sub> n	4 <sup>1</sup> / <sub>2</sub> n	5 <sup>1</sup> / <sub>2</sub> n
No. 1 Comra . . . . .		3 <sup>1</sup> / <sub>2</sub> n	3 <sup>1</sup> / <sub>2</sub> n	4 <sup>1</sup> / <sub>2</sub> n	4 <sup>1</sup> / <sub>2</sub> n	4 <sup>1</sup> / <sub>2</sub> n
Bengal . . . . .		5 <sup>1</sup> / <sub>2</sub> n	5 <sup>1</sup> / <sub>2</sub> n	5 <sup>1</sup> / <sub>2</sub> n	5 <sup>1</sup> / <sub>2</sub> n	5 <sup>1</sup> / <sub>2</sub> n
Tinnevely . . . . .		5 <sup>1</sup> / <sub>2</sub> n	5 <sup>1</sup> / <sub>2</sub> n	5 <sup>1</sup> / <sub>2</sub> n	5 <sup>1</sup> / <sub>2</sub> n	5 <sup>1</sup> / <sub>2</sub> n

Cotton Ships arrived.

Boston: Canadian S. Hamburg: Iceland S.

	Sales.		Speculation and Export.		Imports including Hull, &c.	
	To-day.	Previous this Week.	To-day.	Previous this Week.	To-day.	Week's Total.
American . . . . .	6330	18,050	500	1500	17,665	53,684
Pernam, &c. . . . .	150	200	..	..	..	..
Paraiba, &c. . . . .	460	130	..	..	..	2
Ceara and Arac'ty . . . . .	..	30	..	..	..	..
Egyptian . . . . .	500	1200	..	..	321	7,983
Peruvian . . . . .	460	350	..	..	32	32
W. I. and African . . . . .	50	20	..	..	..	..
Surat . . . . .	..	..	..	..	3,664	3,829
Madras . . . . .	50	20	..	..	..	..
Bengal . . . . .	..	..	..	..	608	608
Sundries . . . . .	..	..	..	..	..	..
Total . . . . .	8000	20,000	500	1500	22,290	66,138
Since Wednesday . . . . .		8,000		500		
		28,000		2000		

Purchases for "speculation" remain in the market and therefore figure again in the sales. These official prices are sometimes prices actually paid, and sometimes prices settled by

<sup>1</sup> Transactions of 100 bales only.

a committee according to their notions of the prices that would have been realized at the close of the market had business been done. The work of the committee is by no means simple, as frequently very few transactions take place in the kinds of cotton of which quotations are given. As regards "middling" American, the committee fixes "spot" by allowing so many "points on or off" present month futures. The variations of the gaps between "spot" and "present month futures" are somewhat mysterious, a matter to which we shall recur. "Spot" quotations, the reader will now understand, are partly nominal, and must therefore be taken as affording a general idea only of movements in the prices of cotton. While quoted "spot" remained low, the prices paid by most spinners for the special kinds of cotton that they needed might rise. When the spinner has informed the dealer exactly what quality of cotton he needs, the dealer quotes so many "points on or off" the "future" quotations prevailing in Liverpool at the time of the purchase, which refer to Upland cotton of "middling grade," of "no staple" and of the worst growth. Then, according as the spinner wants immediate delivery or delivery in some future month, he pays the price of current "futures," or of "futures" of the month in which he requires delivery, plus or minus the "points on or off" previously fixed.

The considerations which determine the "points on or off" charged to the spinner may be taken roughly as three:—

1. The grade, i.e. the colour, cleanliness, &c., of the cotton. These are of importance to the spinner owing to the necessity of his cleaning machinery being adapted to the condition of the cotton. The lower the grade the more elaborate and expensive is the machinery required to clean it, and consequently a spinner is willing to pay a certain amount extra for high grade cotton in order to save expenditure on preparatory machinery.
2. The length of the staple. This determines to a large extent the fineness of the yarn which can be spun. Only the very lowest counts can be spun from cotton with "no staple," that is, with a fibre of about three-quarters of an inch. The longer the staple above the minimum the higher the counts that can be spun.
3. The growth. The best American cotton (Sea Island and Florida cotton are always considered quite apart) is grown in the Mississippi valley, the next best in Texas, and the poorest on the Uplands (i.e. in Georgia and Alabama). Considerations of growth determine to a great extent the hardness or softness, and strength or weakness, of the fibre, and thus, indirectly, whether the cotton is suitable for warp or weft.

Some spinners cover their yarn contracts merely by buying "futures," but the cover thus provided is frequently most inadequate owing to variations in the "points on or off" for the particular cotton that they want. For example, after the size of 1904-1905 crops became known, and the Americans attempted to hold back cotton, the "points on" for many qualities rose considerably owing to artificial scarcity, though the price of cotton, as indicated by "spot," remained low. There is a tendency for cautious spinners in England to run no risks and fix the prices of their yarn in accordance with quotations for actual cotton of specified qualities made by their brokers.

We now return to exchange "future" transactions regarded as a genus. In addition to "futures" proper there are "options" and "straddles." Options are single ("puts" or "calls") or double (that is, alternative "puts" or "calls"). The "put" is a right to sell cotton within some specified time in the future at a price fixed in the present, which need not, of course, be exercised. The "call" is similar, but relates to buying. It will be evident that the "put" is a hedge against prices falling, and the "call" a hedge against their rising. The basis of "options" is the same as that of

ordinary "futures," *i.e.* middling American cotton of "no staple," &c. Whether the purchaser of an option gains or loses depends upon the price that he has paid in relation to the gain, if any, that he makes out of his power. The price of options of course varies: that of double options is always highest, but they are little used. A "straddle" is a speculation on the difference between the prices of nearer and more distant futures, which varies from time to time, or on the difference between the prices of different kinds of cotton. An example will make the nature of the straddle clear. Suppose a dealer buys April-May "futures" at 4d. a lb and sells the same quantity of May-June "futures" at  $4\frac{1}{4}$ d. a lb. Then, whether prices rise or fall as a whole, he gains if the difference between the two prices becomes less than  $\frac{1}{4}$ d., but if it becomes more, he loses. On the other hand, had the dealer bought May-June at  $4\frac{1}{4}$ d. and sold April-May at 4d. he would have gained in the event of the difference increasing, and lost in the event of its decreasing.

A question which has met with a good deal of attention is whether the speculation, which has been encouraged by the various arrangements made for facilitating operations in "futures," has steadied or unsteadied prices. Before we are prepared to answer this question we must be furnished with a precise conception of what is meant by "steadiness" in prices. It is sometimes assumed that this is measured perfectly by the standard deviation,<sup>1</sup> which is obtained by taking the squares of the differences between the average and the individual prices, summing them and extracting the square root. But obviously the information given by the standard deviation is limited: the frequency of movement cannot be inferred from it; two series might have quite different average oscillations and yet the same standard deviation; and the range of movement, or spread of the variations from the average price (though allowed for in the standard deviation more than in the average error), is hidden. Now frequency of movement, average daily price variation, and range of price movements are matters of fundamental importance to the public. Hence for practical purposes we require several kinds of measurement of price movements, and it is impossible to weigh exactly the one against the other in respect of importance. Observe that an increase of the frequency of movement, or even of the average daily movement, is not necessarily objectionable, since changes are less harassing when they take place by small increments than when they are brought about by a few big variations. The difference between the highest and lowest price, we may observe, is a very imperfect indication of the range of movement (though, taken in conjunction with the standard deviation, it is the best at our disposal), because either of the extreme prices might be accidental and quite out of relation to all others. An investigator must be on his guard against using quotations of this kind. There is also a difficulty about the frequency of movement, because as a rule many movements take place in one day the total over a period sufficiently lengthy to yield general results is enormous, and many are unrecorded. In one day, for instance, when the net drop was 33 points and the range of variation 59 points (namely, 8.45 to 7.86), 150 price fluctuations were recorded. However, the count of frequency of movement from daily closing prices would probably afford a roughly satisfactory comparative measurement in markets in which prices sometimes remain the same for a day or two together. The points just noted apply also to the average fluctuation and the standard deviation, but it is probable in these cases that daily or even weekly quotations would be sufficient to yield the information sought for with sufficient exactness for purposes of comparison.

Now, supposing dealing to be confined to experts, what effects upon the course of prices would one expect from the specialism of the cotton market and improved facilities for dealing, on the assumption that dealers were governed wholly in their actions by the course of prices and never tried to manipulate them? The frequency of movement ought to increase because the market

**Effect of speculation on steadiness of prices.**

<sup>1</sup> See article on "Dealings in Futures in the Cotton Market," in the *Journal of the Royal Statistical Society*, vol. lxix, p. 325.

would become more sensitive, but, other things being equal, the range of movement ought to diminish, and ultimately the average daily movement also, though at first the latter might not fall appreciably if, indeed, it did not rise, owing to the increased frequency of movement. These results would prove beneficial to the community. May we infer deductively that they have been attained because of the increase of speculative transactions? By no means, and for two reasons. In the first place, the public speculates to a large extent on the cotton exchange, and its speculation (taken as a whole) is sheer gambling. But, it may be replied, the outsiders, being as a whole completely ignorant of the forces at work, so that they cannot form rational anticipations, cannot have any effect either way: by the law of chance their influences would neutralize one another. This would be so if people acted independently and without guidance, but actually they are sometimes misled by published advice and movements in the market intended to deceive them, and, even when they are not, they watch each other's attitudes and tend to act as a crowd. The mass becomes unduly sanguine or weakly surrenders to panic. Hence the law of error does not apply, and speculation by the public may unsteady prices. Again, dealers sometimes try to create corners and form powerful syndicates for that purpose: the dealing syndicate of late years has become a force to be reckoned with. Many large-scale operations are entered into, not because prices are relatively high or low, but to make them high or low for ulterior purposes; *i.e.* the market is deliberately "bullied or beared." In consequence of this tampering with the market no certainty can be felt about the effect even of expert dealing.

What, then, we may profitably inquire next, has actually happened to price movements generally as the market has developed? This question can readily be answered as regards the past forty years or so, for which material has been collected, but the reader must bear in mind that if improvement can be traced it cannot logically be attributed unhesitatingly to the perfecting of the machinery of speculation, whereby a larger use has been made of "futures," since many other economic changes have taken place concomitantly and they may have wrought the major effect. The world may be steadying and steeling its nerves. Now, turning to the actual effects, we discover somewhat remarkable facts. Expressed both absolutely and as percentages of the price averaged from the 1st of October to the 31st of July, the range of movement, standard deviation, and mean weekly movement calculated between the times mentioned above (October 1st to July 31st), after diminishing significantly for some years after the later 'sixties, have risen appreciably on the whole of late years. The figures in the table below are from the *Journal of the Royal Statistical Society*, June 1906: quotations for August and September were omitted to avoid the transition movements between the price levels of two crops.

**Movement of prices.**

In this table measurements of price movements stated both absolutely and as percentages of price levels are given, because authorities have expressed doubts as to whether the former or the latter might be expected to remain constant, other things being equal, when price rose. On the one hand, it is argued that speculators are affected only by the absolute variations in price, while on the other hand it is contended that a movement of one "point," say, is less influential when the price is about 8d. than when it is about 4d. In response to the first view it might be argued that if speculators are influenced only by the differences for which they become liable, a "point" movement would have a somewhat slighter effect on their action, other things being equal, when price was high, because, supplies being relatively short, each of them would tend to be engaged in a smaller volume of transactions measured in quantity of cotton, than when supplies were larger. But the point need not be discussed further here, since both percentage and absolute indices of unsteadiness have risen of late years. The explanation of this change in the direction of indices of steadiness cannot be proved to consist in any peculiarity in the supplies of recent years. But the dealing syndicate has probably been of late more common and more powerful—that is, the syndicate which exists to make profits out

Table calculated from Weekly Prices between the 1st of October and the 31st of July in each Year.

Year.	Average Price.	Lowest Price.	Highest Price.	Range of Movement.	Standard Deviation.	Mean Weekly Movement.	Expressed as Percentage of Average (1st Oct. to 31st July) Weekly Prices.		
							Range of Movement.	Standard Deviation.	Mean Weekly Movement.
1867-1868	9½	7½	12½	5½	1.74	0.31	57.1	18.1	3.22
1868-1869	11½	10½	12½	2½	0.58	0.19	18.5	5.0	1.65
1869-1870	11½	7½	12½	4½	0.92	0.23	41.6	8.3	2.07
1870-1871	8½	7½	9½	2	0.65	0.17	24.6	8.0	2.09
1871-1872	10½	9½	11½	2½	0.75	0.15	19.5	6.9	1.38
1872-1873	9½	8½	10½	1½	0.53	0.10	16.9	5.7	1.08
1873-1874	8½	7½	9½	1½	0.32	0.10	16.5	3.9	1.20
1874-1875	7½	6½	8	1½	0.26	0.07	13.8	3.4	0.89
1875-1876	6½	5½	7½	1½	0.37	0.08	19.2	5.7	1.23
1876-1877	6½	5½	7	1½	0.33	0.11	17.8	5.2	1.74
1877-1878	6½	5½	6½	1½	0.21	0.07	11.0	3.4	1.12
1878-1879	6	4½	7½	2½	0.67	0.13	37.5	11.2	2.17
1879-1880	7	6½	7½	1½	0.24	0.12	10.7	3.4	1.71
1880-1881	6½	5½	6½	1½	0.34	0.08	16.8	5.4	1.27
1881-1882	6½	6	7½	1½	0.15	0.07	10.4	2.3	1.06
1882-1883	5½	5½	6½	1½	0.07	0.07	20.4	5.3	1.20
1883-1884	6½	5½	6½	1½	0.20	0.08	11.3	3.3	1.32
1884-1885	5½	5½	6	1	0.19	0.07	11.8	3.3	1.20
1885-1886	5½	4½	5½	1	0.18	0.07	14.5	3.5	1.35
1886-1887	5½	5	6	1	0.28	0.05	16.1	5.2	0.92
1887-1888	5½	5½	5½	1	0.14	0.05	9.1	2.5	0.91
1888-1889	5½	5½	6½	1	0.23	0.06	15.0	4.0	1.04
1889-1890	6½	5½	6½	1	0.34	0.08	18.4	5.5	1.31
1890-1891	5	4½	5½	1	0.36	0.06	27.5	7.2	1.20
1891-1892	4½	3½	4½	1	0.36	0.07	33.3	8.7	1.70
1892-1893	4½	4½	5½	1	0.37	0.09	25.0	7.8	1.89
1893-1894	4½	3½	4½	1	0.22	0.04	18.4	5.2	0.94
1894-1895	3½	2½	3½	1	0.30	0.06	26.9	8.9	1.79
1895-1896	4½	3½	4½	1	0.28	0.07	25.0	6.4	1.60
1896-1897	4½	3½	4½	1	0.22	0.07	21.6	5.2	1.67
1897-1898	3½	3½	3½	1	0.18	0.05	18.5	5.3	1.47
1898-1899	3½	3	3½	1	0.15	0.04	14.3	4.6	1.22
1899-1900	4½	3½	6½	1	0.03	0.12	43.6	12.8	2.48
1900-1901	5	4½	6½	2	0.53	0.13	42.7	10.3	2.54
1901-1902	4½	4½	5½	1	0.24	0.09	22.4	5.0	1.89
1902-1903	5.35	4.42	7.12	2.70	0.78	0.13	50.5	14.6	2.43
1903-1904	7.04	5.78	8.92	3.14	0.91	0.33	44.4	12.9	4.83
1904-1905	4.86	3.63	6.01	2.38	0.71	0.15	48.9	14.6	3.09

of manipulating the market—and the public has probably been speculating increasingly. It is plausible, then, to suppose that the dealing syndicate primarily, and the speculations of the public secondarily (secondarily, because in all likelihood the effect of its operation would be much less in magnitude), may account for the change.

"Futures" are not used in all markets—for instance, they are not to be found at Bremen; and in those in which they are used they play parts of different prominence—at Havre, for instance, the transactions in "futures" are of incomparably less relative importance than they are at Liverpool. But it is futile to seek the effect of much dealing in "futures" in the differences between price movements in the various markets, because (1) demand expresses itself in different ways—in Germany, for example, spinners buy to hold large stocks—and (2) the markets are in telegraphic communication, so that their price movements are kept parallel. Mr Hooker has shown with reference to the wheat market how close is the correlation between prices in different places,<sup>1</sup> and the same has been observed of the cotton market, though the

Conceivably some indication of the working of "futures" might be gleaned from observation of the relations of near and distant "futures" to one another and of both to "spot." The complete explanation of changes in these relations is still a mystery.<sup>2</sup> Probably an infinitude of subtle influences came into play, and among these there seems reason to include the intentional and unintentional "bulling" or "bearing" of the market. Some examples of the diverse relations to be found, even when all the "futures" fall in the same crop year, may be quoted here—quotations running into the new crop year are obviously affected by anticipations of the new crop.

As we pass from the "future" of the month in which the quotation is made to the most distant "future" it will be observed that in the first and second cases price rises continuously, in the second case even passing "spot," whereas in the third case it falls first and then rises. Instances might be given of its falling unintermittently. It seems a plausible conjecture that if "futures" were "bulling" the market in the first case, they were at least "bulling" it less in the second case *ceteris paribus*, and probably

	Spot.	Jan.-Feb.	Feb.-March	March-April.	April-May.	May-June.	June-July.	July-Aug.	Aug.-Sept.	Sept.-Oct.	Oct.-Nov.	Nov.-Dec.	Dec.-Jan.
Nov. 18th, 1895 . .	4.34	27	28	28½	29½	31	32	33	..	..	..	27	27
Jan. 18th, 1899 . .	3.8	6½	6½	7½	8½	9½	10½	11½	12	12½	..	..	6½
Sept. 14th, 1899 . .	3.36	24½	25	25½	26	27	..	..	30	28	26½	25	24½

correlations have not been worked out.<sup>2</sup> It is worthy of note that Liverpool "futures" are largely used for hedging by continental cotton dealers.

"bearing" it in the last case. A closer examination will reveal further that the magnitude of these gaps varies a great deal; and

<sup>1</sup> *Journal of the Statistical Society*, 1906.

<sup>2</sup> See paper in the *Journal of the Statistical Society* for June 1906.

<sup>2</sup> Attempts to explain them were made in an article in the *Economic Journal* in December 1904, and in the paper already referred to read to the Royal Statistical Society.

if the "futures" do "bear" and "bull," as has been supposed, they probably influence these magnitudes. It might be thought that the "futures" of different months, being substitutes in proportion to their temporal proximity to one another, should vary together exactly; but it would seem to be a sufficient reply that as they are not perfect substitutes they are in some slight degree independent variables. The "spot" market might be judged generally as too high, in view of crops and the probable normal demand of the year, but it might not therefore drop immediately, owing partly to the pressure of demand that must be satisfied instantaneously. "Current futures" would be affected more than "spot" by this impression as to the relation of "spot" to a conceived normal price for the year, and they might therefore be expected to drop more than "spot" when this impression was at all widely entertained. But the fall of "current futures" would be checked by the demands that must be satisfied in the near future. Probably the prices of the more distant "futures" are determined in a higher degree by far-reaching imagination than the prices of nearer futures. This explains what has been called above the unintentional "bearing" of "spot" by "futures." And it is immediately evident that the deliberate "bear" works by selling "futures," and that the effect of his sales is propagated to "spot." These statements are equally true of "bulling." The influence of expectations of the new crop on "futures" running into the new crop is plain on inspection; but owing to the gap between the two crop years it would be astonishing if "futures" against which cotton from a new crop could be delivered were not appreciably independent of "spot" at the time of their quotation. However, it is noticeable that they are still so closely bound up with "futures" culminating in the old crop year that the daily movements of the former are closely correlated with those of the latter. Concluding cautiously, we may admit the probability of the relations between near and distant "futures" and "spot" (even in respect of "futures" running out in the same crop year) indicating sometimes at least the intentional or unintentional "bulling" or "bearing" or "spot" by "futures." But nothing has yet been proved from these facts as to the effect "futures" are having upon the steadiness of prices. In the case of any crop year, if the relations which are suggested as indicating the "bulling" work of "futures" usually corresponded with "spot" prices being below the normal price of the crop year, or of what was left of the crop year, while the relations which are suggested to indicate the "bearing" work of "futures" on the whole corresponded with a relatively abnormal height of "spot," it would be a legitimate inference that "futures" were tending to smooth prices. However, it is made clear as the result of an elaborate examination that the generality of these correspondences cannot be affirmed.<sup>1</sup> The outcome of the whole matter is that the investigator is still baffled in his attempt to discover what effect the use of "futures" is having upon prices to-day. The sole piece of evidence, from which probable conclusions may be drawn, is that three separate measurements of price fluctuations over some forty years reveal a growing unsteadiness of late, whether they be expressed absolutely or as percentages of price.

The uneasiness caused by the excessive dependence of Great Britain upon the United States for cotton, coupled with the belief that shortages of supply are more frequent than they ought to be, and the fear that diminishing returns may operate in America, occasioned the formation in England of the British Cotton Growing Association on the 12th of June 1902. The proportions of England's supplies drawn from different fields is indicated in the table below.

British dependence on American supplies is greater even than that of the continent of Europe, for Russia possesses some internal supplies, and more Indian cotton is used in continental countries than in England.

<sup>1</sup> See the paper already mentioned in the *Journal of the Royal Statistical Society* for June 1906, where the several points noticed briefly above are fully discussed.

*Average Quantities of Raw Cotton imported Annually into the United Kingdom from the following Countries in the Periods 1896-1900 and 1901-1904.*

Country.	1896-1900. Million lb.	1901-1904. Million lb.
United States . . . . .	1436	1424
Brazil . . . . .	13.8	31.5
Peru . . . . .	8.5	8.6
Chile (including the Pacific coast of Patagonia) . . . . .	.8	2.2
Venezuela and Republic of Colombia . . . . .	.5	.5
British West Indies and British Guiana . . . . .	.3	.6
Turkey (European and Asiatic) . . . . .	.5	1.1
Egypt . . . . .	295.7	314.4
British possessions in the East Indies . . . . .	40.7	61.9
Australasia . . . . .	.035	.041
All other countries . . . . .	2.3	3.8
<b>Total</b> . . . . .	<b>1800</b>	<b>1849</b>
<b>Re-exported</b> . . . . .	<b>223</b>	<b>260</b>

The annual average shipments from Bombay to the European continent and to Great Britain in 1900-1904 were as follows:—

To the continent . . . . . 600 bales of 3½ cwt.  
To Great Britain . . . . . 50 " "

At the end of the 18th century the bulk of British cotton was obtained from the West Indies. Approximately the supplies were as follows in million lb:—

British West Indies . . . . . 6.6  
French and Spanish settlements . . . . . 6  
Dutch settlements . . . . . 1.7  
Portuguese " . . . . . 2.5  
East Indies " . . . . . 1  
Smyrna or Turkey . . . . . 5.7

The British Cotton Growing Association works under the sanction of a royal charter and has met with valuable official support. Financial assistance and assurances as to sales and prices have been given liberally by the association where they are needed; ginning and buying centres have been established; experts have been engaged to distribute seed and afford instruction; and some land has been acquired for working under the direct management of the association. The governments of some colonies have aided the efforts of the association. Professor Wyndham Dunstan of the Imperial Institute, on a reference from the government, made favourable reports as to the possibilities of extending cotton cultivation. The results may be seen in the approximate estimates below of cotton grown more or less directly under the auspices of the association.

*Bales of 400 lb.*

	1903.	1904.	1905.	1906.
Gambia . . . . .	50	100	300	..
Sierra Leone . . . . .	50	100	200	250
Gold Coast . . . . .	50	150	200	250
Lagos . . . . .	500	2,000	3,200	6,300
Nigeria . . . . .	100	200	650	1,200
West Africa . . . . .	750	2,550	4,550	8,000
West Indies . . . . .	1,000	2,000	4,000	6,000
East Africa . . . . .	150	850	2,000	3,500
Sind . . . . .	..	..	500	2,000
Sundries . . . . .	..	100	250	500
<b>Total</b> . . . . .	<b>1,900</b>	<b>5,500</b>	<b>11,300</b>	<b>20,000</b>
Approximate value	£29,000	£75,000	£150,000	£270,000

In the West Indies results are most favourable, both as regards quantity and quality of the crops. West Indian grown cotton has realized even higher prices than American grown Sea Island. In West Africa also prospects appear encouraging. In Sierra Leone little success has been met with, but on the Gold Coast some cotton better than middling American has been grown, and the association has concluded an agreement with the government for an extension of its work. In Lagos crops increased rapidly. The cotton is almost entirely grown by natives in small patches round their villages, and generally it



has sold for about the same price as middling American, though some of it realized as much as 25 to 30 "points on." The quality in greatest demand in England, it should be observed, is worth about ¼d. to ¾d. per lb. above middling American. In Southern Nigeria the association has met with only slight success; in Northern Nigeria, a working arrangement was entered into with the Niger Company, and a small ginning establishment was set to work in February 1906. In British Central Africa, the results on the whole have not been satisfactory. Though planters who confined their efforts to the lower lying grounds—of which there is a fairly large tract—succeeded, all the cotton planted on the highlands proved more or less a failure. In Uganda the association took no steps, but activity in cotton-growing is not unknown, and some good cotton is being produced. Arrangements were concluded with the British South Africa Company for the formation of a small syndicate for working in Rhodesia.

The general movement for the extension of cotton cultivation was welcomed by the International Congress of representatives of master cotton spinners and manufacturers' associations at the meeting at Zurich in May 1904. It placed on record "its cordial appreciation of the efforts of those governments and institutions which have already supported cotton-growing in their respective colonies." England is pre-eminent but not alone in the matter. Germany and France, and in a less degree Belgium, Portugal and Italy, have taken some steps. Russia, too, is developing her internal supplies.

The advantages that might accrue from the wider distribution of cotton-growing are mainly fourfold. (1) Greater elasticity of supply might be caused. It is probably easier to extend the area under cotton rapidly when crops are raised from many places in proximity to other crops than when the mass of the cotton is obtained from a few highly specialized districts. Possibly the advantages of specialism might be retained and yet the elasticity of supply be enhanced. (2) Greater stability of crops in proportion to area cultivated is hoped for. The eggs are now too much in one basket, and local disease, or bad weather, or some other misfortune, may diminish by serious percentages the supplies anticipated. Were there numerous important centres the bad fortune of one would be more adequately offset by the good fortune of another. (3) Desirable variations in the raw material might conceivably eventuate from the introduction of cotton to spots in the globe where its growth was previously unknown or little regarded. The results of the enterprise of Mehemet Ali and Jumel in Egypt prove such an idea to be not altogether fanciful, and warn us also against hastily arguing that the plan is too artificial to succeed on a large scale. Without the active intervention of a strong body of interested parties it is sometimes unlikely that new industries will be undertaken even in places well suited for them. (4) Lastly, the countries to which cotton-growing is carried should gain in prosperity.

The general difficulties in the way of the British Cotton Growing Association are many and will be sufficiently evident.

Lessons of value may be learnt from the fate of similar work undertaken by the Cotton Supply Association, which was instituted in April 1857. According to its fifth report, it originated "in the prospective fears of a portion of the trade that some dire calamity must inevitably, sooner or later, overtake the cotton manufacture of Lancashire, whose vast superstructure had so long rested upon the treacherous foundation of restricted slave labour as the main source of supply for its raw material."<sup>1</sup> Its methods were stated to be: "To afford information to every country capable of producing cotton, both by the diffusion of printed directions for its cultivation, and sending competent teachers of cotton planting and cleaning, and by direct communication with Christian missionaries whose aid and co-operation it solicits; to supply, gratuitously, in the first instance, the best seeds to natives in every part of the world who are willing to receive them; to give prizes for the extended cultivation of cotton; and

The Association published a weekly paper known as *The Cotton Supply Reporter*.

to lend gins and improved machines for cleaning and preparing cotton." Though the association brought about an extension and improvement of the Indian crop, in which result it was enormously assisted by the high prices consequent upon the American Civil War, it sank after a few years into obscurity, and soon passed out of existence altogether, while the effects of its work dwindled finally into insignificance. Much the same had been the ultimate outcome of the spasmodic attempt of the British government to bring about the introduction of cotton to new districts, after it had been pressed to take some action a few years prior to the formation of the Cotton Supply Association. A Mr Clegg, who afterwards interested himself keenly in the activities of the Cotton Supply Association reported that in the course of a tour in 1855 through the Eastern countries bordering on the Mediterranean he had found none of the gins presented by the British government at work or workable.

**BIBLIOGRAPHY.**—On the question of cotton supplies, as treated in this article, the reader may be referred to Brook's *Cotton, its Uses, &c.*; Dabney's *Cotton Plant* (Department of Agriculture of the United States); Foaden's *Cotton Culture in Egypt*; Dunstan's *Report on Cotton Cultivation for the British government*; Ooppel's *Die Baumwolle*; Leconte's *Le Coton*; publications of the British Cotton Growing Association; *Report of the Lancashire Commission on the possibility of extending cotton cultivation in the Southern States of North America*; Watt's *Lancashire and the Cotton Famine*; publications of the old Cotton Supply Association (many will be found in the Manchester public library in the volume marked "677 I. C. ii."), including their weekly paper, *The Cotton Supply Reporter*; Hammond's *Cotton Culture and Trade*. On methods of marketing to certain portions of the above must be added: Ellison's *Cotton Trade of Great Britain*; Chapman's *Lancashire Cotton Industry* (ch. vii.); articles by Chapman and Knoop in the *Economic Journal* (December, 1904) and the *Journal of the Royal Statistical Society* (April, 1906); Emery's *Speculation on Stock and Produce Exchanges of the United States* (small portions of which relate to cotton). Many statistics will be found in the works mentioned, and these may be supplemented from the trade publications of different countries. Many valuable figures of cotton imports, &c., in early years will be found in Baines' *History of the Cotton Trade*. Recent statistics bearing upon cotton are collected annually in the two publications, Shepperson's *Cotton Facts* and Jones's *Handbook for Daily Cable Records of Cotton Crop Statistics*. For current information the following may be added: Nield's, Ellison's and Tattersall's circulars; *Cotton* (the publication of the Manchester Cotton Association); and daily reports and articles in the local press. Price curves are published by Messrs Turner, Routledge & Co. (S. J. C.)

#### COTTON GOODS AND YARN

The two great sections of the cotton industry are *yarn* and *cloth*, and in Great Britain the production of both of these is mainly in South Lancashire, though the area extends to parts of Cheshire, Yorkshire and Derbyshire, and there is a Scottish branch, besides certain isolated ventures in other parts of the country. Though there are local rivalries there is nothing in competitive division to compare with the northern and southern sections in America, and the British industry is, for its size, more homogeneous than most of the European industries. Both operatives and employers are highly organized and both parties are able to make articulate contribution to the solution of the various problems connected with the trade.

**Cotton Yarn.**—The yarn trade is mainly in the hands of limited companies, and a private firm is looked upon as something of a survival from the past. The two great centres of production are Oldham, in which American cotton is chiefly, though not exclusively, spun, and Bolton, which spins the finer counts from Egyptian or Sea Island cotton. Spinning mills are established, however, in most of the large Lancashire towns as well as in some parts of Cheshire and in Yorkshire, where there is a considerable industry in doubling yarns. The centre of trade is the Manchester Royal Exchange, and though some companies or firms prefer to do business by means of their own salaried salesmen, managers or directors, most of the yarn is sold by agents. Frequently a single agent has the consignment of the whole of a company's yarn, but many spinners, especially those whose business connexion is not perfectly assured, prefer to have more outlets than can be explored by an individual. At times of bad trade even those who usually depend on their own resources seek the aid of experienced agents, who sometimes find a grievance if their

services are rejected when trade improves and sales are made easily.

Yarn is sold upon various terms, but a regular custom in the home trade is for the spinner to allow 4% discount, for payment in 14 days, of which 2½ goes to the buyer, who is commonly a manufacturer, and 1½ to the agent for sale and guaranteeing the account. In selling yarn for export it is usual to allow the buyer only 1½% for payment in 14 days, or in some cases the discount is at the rate of 5% per annum for 3 months, which is equivalent to 1½%.

The great bulk of the yarn spun in Great Britain ranges between comparatively narrow limits of count, and such staples as 32" to 36" twist and 36" to 46" weft in American, 50" to 60" twist and 42" to 62" weft in Egyptian, make up a large part of the total. It is nevertheless the experience of yarn salesmen that Lancashire produces an increasingly large amount of specialities that indicate a continued differentiation in trade. The tendency to spin finer counts has been to some extent counteracted by the development of the flannelette trade, for which heavy wefts are used, and there has been again a tendency lately to use "condensor" or waste wefts, which has worked to the disadvantage of the spinners of the regular coarse counts spun at Royton and elsewhere. The demand for cloths which require careful handling and regularity in weaving has helped to develop the supply of ring yarns which will stand the strain of the loom better than mule twists. A great amount of doubled and trebled yarn is now sold, though it does not appear that recent expansions have added much to doubling spindles, and considerable developments continue in the use of dyed and mercerized yarns.

Yarns are sold according to their "actual" counts, though when they are woven into cloth they frequently attain nominal or brevet rank. There has been a long-continued discussion, which between buyer and seller sometimes degenerates into a dispute, on the subject of moisture in yarns, and the difficulty is not confined to the Lancashire industry. The amount permissible, according to the recommendation of the Manchester Chamber of Commerce, is 8%, but while it may be assumed that yarns at the time of their sale rarely contain less than this, they frequently contain a good deal more. It is a matter of experience that cotton yarns which when spun contain only a small percentage of moisture will absorb up to about 8% when they are exposed to what may be rather vaguely described as natural conditions. The exigencies of competition prompted the discovery that if yarn were sold by weight fresh from the spindle its comparative dryness made such early sale less profitable than if it were allowed to "condition." Between loss and delay the spinner found an obvious alternative in damping the yarn artificially. As it was often clearly to the advantage of the buyer that he should receive immediate delivery he did not object to water in moderation, but art soon began to run a little ahead of nature. The essentially dishonest practice of deluging yarn with water, which has sometimes even degenerated into the use of weighting materials deleterious to weaving, has been recognized as a great nuisance, but while various attempts have been made to protect the buyer the question seems to have pretty well settled itself on the principles which commonly rule the sales of commodities between those who intend to do business continuously. The spinner who persists in over-weighting his yarn finds it difficult to obtain "repeat" orders.

A remarkable point in the Lancashire yarn trade is the looseness of the contracts between spinner and manufacturer. Doubtless some kind of sale note or acknowledgment usually passes between them, but in the home trade at least it is quite usual to leave the question of delivery an open one. It would not be

correct to say that this system or want of system is satisfactory, but the trade manages to rub along very well with it, although inconveniences and disagreements sometimes arise when prices have advanced or declined considerably. Thus when prices have advanced the manufacturer may find it difficult to obtain delivery of the yarn that he had bought at low rates, for some spinners have a curious, indefensible preference for delivering their higher-priced orders; and, on the other hand, when prices have fallen the manufacturer sometimes ceases to take delivery of the high-priced yarn and actually purchases afresh for his needs. Yet positive repudiation is very rare though compromises are not uncommon, and a good many illogical arrangements are made that imply forbearance and amity. Litigation in the yarn trade is very unusual, and Lancashire traders generally have only vague notions of the bearing of law upon their transactions, and a wholesome dread of the experience that would lead to better knowledge.

The average yearly values of the exports of cotton, yarn and cloth from Great Britain for the decades 1881-1890 and 1891-1900 respectively, are given by Professor Chapman in his *Cotton Industry and Trade*, in million pounds:—

	1881-1890.	1891-1900.
Cloth	£60.4	£57.3
Yarn	12.3	9.3
Total	£72.7	£66.6

During the earlier decade the prices of cotton were comparatively high. The whole of the cloth exports represent, of course, a corresponding home trade in yarns. The following table, taken from the *Manchester Guardian*, gives in thousands of lb the amounts of cotton yarns exported from Great Britain during 1903, 1904 and 1905 respectively, according to the Board of Trade returns, together with the average value per lb for each of the countries:—

	1903.		1904.		1905.	
	lb. <sup>1</sup>	Price per lb.	lb. <sup>1</sup>	Price per lb.	lb. <sup>1</sup>	Price per lb.
		d.		d.		d.
Russia	814	30.22	713	30.71	557	30.66
Sweden	1,526	11.00	1,486	12.55	1,512	11.12
Norway	1,656	9.54	1,511	11.05	1,606	9.73
Denmark	2,429	8.91	2,368	10.18	2,860	9.51
Germany	27,239	16.05	40,295	16.27	39,513	16.38
Netherlands	29,591	9.10	29,384	10.48	37,341	8.93
Belgium	3,970	15.89	5,864	16.59	7,205	16.12
France	3,974	17.59	3,084	20.01	3,518	22.64
Italy	204	21.78	174	24.70	204	22.21
Austria-Hungary	2,662	11.60	3,329	14.36	3,066	13.36
Rumania	4,608	8.55	5,072	10.13	7,856	9.73
Turkey	12,966	8.93	14,253	10.05	17,389	9.37
Egypt	4,590	8.66	4,381	9.83	4,382	8.59
China (including Hong-Kong)	4,660	9.45	2,457	10.24	8,441	8.70
Japan	1,406	12.98	681	11.46	4,071	13.99
British India—						
Bombay	6,286	10.80	8,145	11.88	13,112	10.86
Madras	6,683	11.07	8,288	12.48	10,930	11.91
Bengal	6,777	11.04	6,596	12.82	11,068	11.20
Burma	5,611	12.17	3,388	12.39	4,211	12.31
Straits Settlements	1,945	10.81	1,137	11.57	2,149	10.71
Ceylon	33	11.92	44	16.51	42	13.55
Other countries	21,129	12.39	21,252	13.28	23,970	12.43
Total and average	150,758	11.79	163,901	13.11	205,001	12.08

It should be understood, however, that in some cases the Board of Trade figures represent only an approximation to the ultimate distribution, as the exports are sometimes assigned to the intermediate country, and in particular it is understood that a considerable part of the yarn sent to the Netherlands is destined for Germany or Austria. The large business done in yarns with the continent of Europe is in some respects an extension of the British home trade, though certain countries have their own specialities. A considerable business is done with European countries in doubled yarns and in fine counts of Egyptian, including "gassed" yarns, which are also sent intermittently to Japan. "Extra hard" yarns are sent to Rumania and other Near Eastern markets, and Russia, as the average price indicates, buys sparingly of very fine yarns. The trade with the Far East, which, though not very large for any one market, is important in the aggregate, is a good deal specialized, and since the

<sup>1</sup> 000 omitted.

development of Indian and Japanese cotton mills some of the trade in the coarser counts has been lost. The various Indian markets take largely of 40<sup>s</sup> mule twist and in various proportions of 30<sup>s</sup> mule, water twists, two-folds grey and bleached, fine Egyptian counts and dyed yarns. China also takes 40<sup>s</sup> mule, water twists and two-folds. The general export of yarn varies according to influences such as tariff charges, spinning and manufacturing development in the importing countries and the price of cotton. A particular effect of high-priced piece-goods is seen in various Eastern countries that are still partly dependent on an indigenous hand-loom industry. The big price of imported cloths throws the native consumer to some extent upon the local goods, and so stimulates the imports of yarn. It appears that as the native industries decline the weaving section persists longer than the spinning section.

**Cotton Goods.**—Cotton goods are of an infinite variety, and the titles that experience or fancy have evoked are even more numerous than the kinds. Descriptions of the following fabrics, which are not of course invariably made of cotton, will be found in separate articles: BAIZE, BANDANA, BOMBAZINE, BROCADE, CALICO, CAMBRIC, CANVAS, CHINTZ, CORDUROY, CRAPE, CRETONNE, DENIM, DIMITY, DRILL, DUCK, FLANNELETTE, FUSTIAN, GAUZE, GINGHAM, LONGCLOTH, MOLESKIN, MULL, MUSLIN, NANKEEN, PRINT, REP, TICKING, TWILL, VELVETEEN. The following are notes on other varieties.

*Grey cloth* is a comprehensive term that includes unbleached cotton cloth generally. It may be a nice question whether "yellow" would not have been the more nearly correct description. A very large proportion of the Lancashire export trade is in grey goods and a smaller yet considerable proportion of the home trade.

*Shirting*, which has long since ceased to refer exclusively to shirt cloths, includes a large proportion of Lancashire manufacture. Grey and white shirtings are exported to all the principal Eastern markets and also to Near Eastern, European, South American, &c. markets. Certain staple kinds, such as 30 in. 37½ yd. 8¼ lb. 16×15 (threads to the ¼ in.), largely exported to China and India, are made in various localities and by many manufacturers. The length quoted is to some extent a conventional term, as the pieces in many cases actually measure considerably more. The export shirting trade is done mainly on "repeat" orders for well-known "chops" or marks. These trade marks are sometimes the property of the manufacturer, but more commonly of the exporter. Generally the China markets use rather better qualities than the Indian markets. The principal China market for shirtings and other staple goods is Shanghai, which holds a large stock and distributes to minor markets. A considerable trade is also done through Hong-Kong and other Far Eastern ports. The principal Indian markets are Calcutta, Bombay, Karachi and Madras.

*Shirt-cloth* is the term more commonly applied to what is actually used in the manufacture of shirts, and it may be used for either plain or fancy goods.

*Sheeting* has two meanings in the cotton trade: (1) the ordinary bed sheeting, usually a stout cloth of anything from 45 in. to 120 in. wide (the extremes being used on the one hand for children's cots or ship bunks and on the other for old-fashioned four-posters), which may be either plain or twilled, bleached, unbleached or half-bleached; (2) a grey calico, heavier than a shirting, sent largely to China and other markets, usually 36 in. by 40 yd. and weighing about 12 lb. American sheetings compete with Lancashire goods in the China market. The *Cabot* is a kind of heavy sheeting, and for the Levant markets the name as a trade mark is said to be the exclusive property of an American firm, although the general class is known by the name and supplied by other firms.

*Mexican* is a plain, heavy grey calico, sometimes heavily sized. The origin of the word is doubtful, and it seems to be an arbitrary term. Mexicans are exported to various markets and also used in the home trade. For export the dimensions are commonly 32 or 36 in. by 24 yd., and a usual count is 18×18. In the Mexican the yarns were originally of nearly the same weight and number of threads to the ¼ in., an arrangement which gave the cloth an even appearance, thus differing from the "pin-head" or medium makes. Now, however, Mexicans are

often made with lighter wefts, though the name is usually applied to the better class of cloths of the particular character. *Punjum* is a Mexican, generally 36 yd. in length, sent mainly to the South African market.

*T Cloth* is a plain grey calico, similar in kind to the Mexican and exported to the same markets. There is no absolute distinction between the two cloths, but the T cloth is generally lower in quality than the Mexican. The name seems to have been originally an arbitrary identification or trade mark.

*Domestic*, a name originally used in the sense of "home-made," is applied especially to home-made cotton goods in the United States. In Great Britain it is employed rather loosely, but commonly to describe the kind of cloth which if exported would be called a Mexican. It may be either bleached or unbleached.

*Medium* is a plain calico, grey or bleached, of medium weight, used principally in the home and colonial trade. The word is sometimes particularly applied to cloths with a comparatively heavy weft, the distinction being made between the even "Mexican make" and the "pin-head" or "medium-make."

*Raising-cloths* are of various kinds and may be merely mediums with a heavy weft, or "condensor" weft made from waste yarns. The essence of the raising-cloth is a weft that will provide plenty of nap and yet have sufficient fibre to maintain the strength of the web.

*Wigan* is a name derived from the town Wigan and seems to have been originally applied to a stiff canvas-like cloth used for lining skirts. Now it is commonly applied to medium or heavy makes of calico.

*Double-warp*, as its name implies, is a cloth with a twofold warp. It is usually a strong serviceable material and may be either twilled or plain. Sheetings for home trade are often double-warp, and double-warp twills and Wigans were and are used for the old-fashioned type of men's night-shirts.

*Croydon*, which seems to be an arbitrary trade name, is a heavy, bleached, plain calico, usually stiff and glossy in finish. It used to be sold largely in the Irish trade as well as in the English home trade, but it has been supplanted a good deal by softer finishes.

*Printing-cloth* is a term with a general significance, but it is also particularly applied to a class of plain cloths in which a very large trade is done both for home trade and export. The chief place in Lancashire for the manufacture of printing-cloths is Burnley, and in the United States, Fall River. The Burnley cloths range in width from 29 in. to 40 in., and are usually about 120 yd. in length. The warp is commonly from 36° to 44°, the weft from 36° to 54°, and the threads from 13×13 to 20×20 to the ¼ in. Cheshire printers, which are made at Hyde, Stockport, Glossop and elsewhere, are commonly 34 in. to 36 in. wide, the warp is from 32° to 36°, the weft 32° to 40°, and the counts 16×16 to 19×22.

*Jaconet* is understood to be the corruption of an Indian name, and the first jacconets were probably of Indian origin. They now make one of the principal staple trades of Lancashire with India. The jacconet is a plain cloth, lighter than a shirting and heavier than a mull. When bleached it is usually put into a firm and glossy finish. A *nainsook* is a jacconet bleached and finished soft. It also goes largely to India.

*Dhootie* is a name taken from a Hindu word of similar sound and referred originally to the loin-cloth worn by Hindus. It is a light, narrow cloth made with a coloured border which is often so elaborate as to require a dobbie loom for its manufacture. The finer kinds, made from Egyptian yarns, are called mull-dhooties. The dhootie is one of the principal staples for India and is exported both white and grey.

*Scarf* is a kind of dhootie made usually with a taped or corded border.

*Madapolam* or *Madapollam* is a name derived from a suburb of Narsapur in the Madras presidency where the cloth was first made. It is now exported grey or white to India and other countries. In weight it is lighter than a shirting, and it is usually ornamented with a distinctive coloured heading.

*Baft*, probably of Persian derivation, and originally a fine cloth, is now a coarse and cheap cloth exported especially to Africa.

*Sarong*, the Malay word for a garment wrapped round the lower part of the body and used by both men and women, is now applied to plain or printed cloths exported to the Indian or Eastern Archipelago for this purpose.

*Jean*, said to be derived from Genoa where a kind of fustian with this title was made, is a kind of twilled cloth. The cloth is woven "one end up and two ends down," and as there are more picks of weft per inch than ends of warp the diagonal lines pass from selvage to selvage at an angle of less than 45 degrees. The weft surface is the face or wearing surface of the cloth. Jeans are exported to China and other markets, and are also used in the home trade. *Jeanette* is the converse of jean, being a twill of "two ends up to one down"; the diagonal passes from selvage to selvage at a greater angle than 45 degrees and the warp makes the wearing surface.

*Oxford* is a plain-woven cloth usually with a coloured pattern, and is used for shirts and dresses. The name is comparatively modern, and is, no doubt, arbitrarily selected.

*Harvard* is a twilled cloth similar to the Oxford.

*Regatta* is a stout, coloured shirt cloth similar in make to a jeanette. It was originally made in blue and white stripes and was used largely and is still used for men's shirts.

Fancy cotton goods are of great variety, and many of them have trade names that are used temporarily or occasionally. Apart from the large class of brocaded cloths made in Jacquard looms there are innumerable simpler kinds, including stripes and checks of various descriptions, such as Swiss, Cord, Satin, Doriah stripes, &c. *Mercerized cloths* are of many kinds, as the mercerizing process can be applied to almost anything. *Lace* and *lace curtains* are made largely at Nottingham. Various light goods are made in Scotland, such as *book muslin*, a fine light muslin with an elastic finish, so called from being folded in book-form.

Among the fancy cloths made in cotton may be mentioned: *matting*, which includes various kinds with some similarity in appearance to a matting texture; *matté*, which is in some degree an imitation of French dress goods of that name; *piqué*, also of French origin, woven in stripes in relief, which cross the width of the piece, and usually finished stiff; *Bedford cord*, a cheaper variety of piqué in which the stripes run the length of the piece; *oatmeal cloth*, which has an irregular surface suggesting the grain of oatmeal, commonly dyed cream colour; *crimp cloth*, in which a puckered effect is obtained by uneven shrinkage; *grenadine*, said to be derived from Granada, a light dress material originally made of silk or silk and wool; *brilliant*, a dress material, usually with a small raised pattern; *leno*, possibly a corrupt form of the French *linon* or lawn, a kind of fancy gauze used for veils, curtains, &c.; *lappet*, a light material with a figure or pattern

produced on the surface of the cloth by needles placed in a sliding frame; *lustre*, a light dress material with a lustrous face sometimes made with a cotton warp and woollen weft; *zephyr*, a light, coloured dress material usually in small patterns; *bobbin-net*, a machine-made fabric, originally an imitation of lace made with bobbins on a pillow.

Some fancy cloths have descriptive names such as *herringbone stripe*, and there are many arbitrary trade names, such as *Yosemite stripe*, which may prevail and become the designation of a regular class or die after a few seasons.

Cotton linings include *silesia*, originally a linen cloth made in Silesia and now usually a twilled cotton cloth which is dyed various colours; *Italian cloth*, a kind of jean or sateen produced originally in Italy. Various cotton cloths are imitations of other textures and have modified names which indicate their superficial character, frequently produced by finishing processes. Among these are *sateen*, which, dyed or printed, is largely used for dresses, linings, upholstery, &c.; *linenette*, dyed and finished to imitate coloured linen in the north of Ireland and elsewhere; *hollandette*, usually unbleached or half-bleached and finished to imitate linen holland; and *interlining*, a coarse, plain white calico used as padding for linen collars.

Various cotton imitations share the name of the original, such

Country.	1903.		1904.		1905.	
	Thousands of Yards.	Price per Yard.	Thousands of Yards.	Price per Yard.	Thousands of Yards.	Price per Yard.
Germany . . . . .	60,650	3.77	60,129	4.02	65,842	3.98
Netherlands . . . . .	47,570	3.57	46,187	3.68	56,639	3.47
Belgium . . . . .	52,199	4.34	56,237	4.42	67,509	4.41
France . . . . .	17,552	4.61	17,759	4.39	14,875	4.65
Portugal, Azores and Madeira.	32,824	2.70	29,440	2.92	29,867	3.03
Italy . . . . .	6,363	5.07	7,904	5.19	8,746	5.31
Austria-Hungary . . . . .	2,405	3.44	2,102	3.40	1,905	3.60
Greece . . . . .	40,973	2.64	32,658	3.11	28,190	3.20
Turkey . . . . .	305,611	2.45	379,557	2.53	376,209	2.53
Egypt . . . . .	229,704	2.41	283,521	2.57	272,737	2.53
Algeria . . . . .	709	2.74	438	2.71	455	2.63
Morocco . . . . .	52,368	2.28	51,262	2.44	44,407	2.44
Foreign West Africa . . . . .	64,589	2.92	55,131	3.12	69,163	3.08
Persia . . . . .	34,859	2.46	33,119	2.67	38,647	2.59
Dutch East Indies . . . . .	156,905	2.45	185,196	2.72	226,586	2.57
Philippine Islands . . . . .	25,558	2.59	25,969	2.86	42,876	2.66
China, including Hong-Kong . . . . .	477,691	2.83	548,974	3.34	799,732	3.06
Japan . . . . .	67,315	3.08	42,373	3.34	128,725	2.99
United States of America . . . . .	72,360	6.80	52,391	7.18	65,563	7.40
Foreign West Indies . . . . .	86,349	2.08	98,797	2.21	80,679	2.24
Mexico . . . . .	19,327	3.10	21,679	3.42	21,028	3.31
Central America . . . . .	40,879	1.97	53,018	2.21	49,523	2.29
Colombia and Panama . . . . .	44,299	2.25	44,648	2.54	31,798	2.41
Venezuela . . . . .	52,330	1.87	52,934	2.07	32,717	2.11
Peru . . . . .	28,962	2.66	32,430	2.85	39,035	2.78
Chile . . . . .	84,118	2.50	80,836	2.57	96,996	2.62
Brazil . . . . .	152,402	2.64	134,841	2.89	131,504	2.50
Uruguay . . . . .	44,062	2.79	35,670	2.85	56,770	2.95
Argentine Republic . . . . .	151,003	2.91	186,022	3.04	159,115	3.24
Gibraltar . . . . .	11,961	2.39	10,578	2.47	3,960	2.73
Malta . . . . .	4,065	3.11	3,659	3.45	4,006	3.31
British W. Africa . . . . .	69,795	3.27	69,308	3.43	74,392	3.40
" S. . . . .	61,778	3.61	29,670	4.03	50,592	3.69
British India—						
Bombay . . . . .	678,684	2.07	818,261	2.23	908,619	2.24
Madras . . . . .	132,825	2.48	141,675	2.63	131,145	2.62
Bengal . . . . .	1,122,004	1.97	1,215,607	2.18	1,280,314	2.18
Burma . . . . .	64,654	2.84	79,765	3.10	72,528	3.13
Straits Settlements <sup>1</sup> . . . . .	112,006	2.61	100,230	2.84	121,690	2.71
Ceylon . . . . .	17,395	2.75	19,336	2.95	24,991	2.94
Australia . . . . .	106,000	3.83	128,247	4.01	136,481	3.85
New Zealand . . . . .	38,499	3.58	33,538	3.81	32,315	3.63
Canada . . . . .	47,439	4.15	49,903	4.25	45,189	4.47
British West India Islands, Bahamas and British Guiana . . . . .	49,614	2.49	43,487	2.61	47,173	2.21
Other countries . . . . .	188,662	2.84	197,339	3.14	226,971	3.03
Total . . . . .	5,157,316	2.57	5,591,822	2.75	6,198,200	2.74

as lawn, batiste, serge, huckaback, galloon, and a large number of names are of obvious derivation and use, such as umbrella cloth, apron cloth, sail cloth, book-binding cloth, shroud cloth,

<sup>1</sup> Including Federated Malay States.

butter cloth, mosquito netting, handkerchief, blanket, towelling, bagging.

Among the miscellaneous cloths made or made partly of cotton may be mentioned: *waste cloths*, made from waste yarns and usually coarse in texture; *khaki cloth*, made largely for military clothing in cotton as well as in woollen; *cottonade*, a name given to various coarse low cloths in the United States and elsewhere; *lasting*, which seems to be an abbreviation of "lasting cloth," a stiff, durable texture used in making shoes, &c.; *bolting cloth*, used in bolting or sifting; *brattice cloth*, a stout, tarred cloth made of cotton or wool and used for bratticing or lining the sides of shafts in mines; *sponge cloths*, used for cleaning machinery; *shoddy* and *mungo*, which though mainly woollen have frequently a cotton admixture; and *splits*, either plain or fancy, usually of low quality, which include any cloth woven two or three in the breadth of the loom and "split" into the necessary width. Cotton is used too for many miscellaneous purposes, including the manufacture of lamp wicks and even of billiard balls.

*British Cotton Cloth Exports.*—The main lines of the Lancashire export trade in cotton goods are indicated in the Board of Trade returns. The table on p. 150 compiled from them is taken from the *Manchester Guardian*. It gives in thousands of yards the quantities of cotton goods exported from Great Britain during 1903, 1904 and 1905 respectively, together with average value per yard for each of the countries.

The following table gives, approximately, in thousands of yards the quantities exported of the four main divisions of cotton cloths:—

	1903.	1904.	1905.
	Thousands of Yards.	Thousands of Yards.	Thousands of Yards.
Grey or unbleached	1,880,321	2,033,895	2,336,018
Bleached	1,326,255	1,528,165	1,710,742
Printed	1,027,925	1,036,901	1,053,900
Dyed and coloured	922,735	993,009	1,097,540

In the case of cloth, too, the Board of Trade returns must not be taken as an absolute record of imports to the particular countries, as the ultimate recipient is not always determined. The development of the Eastern trade has been one of the most remarkable features of the cotton trade in the 19th century. Professor Chapman writes in his *Cotton Industry and Trade*: "In 1820 Europe received about half the cotton fabrics which were sent abroad, while the United States received nearly one-tenth and eastern Asia little more than one-twentieth. By 1880 Europe was taking less than one-twelfth, the United States less than one-fiftieth, and eastern Asia more than a half."

Naturally a trade tends to find out the most direct means of distribution, and Manchester merchants are now generally in direct connexion with native dealers in India. Bombay was the pioneer in the custom, followed now by Calcutta and Karachi, by which deliveries of goods from British merchants remained under the control of the banks until the native dealers took them up. Manchester business with India, China, &c., is done under various conditions, however, and a good many firms have branches abroad. The regular "indent" by which most of the Manchester Eastern business is conducted now implies a definite offer for shipment from the dealer abroad, either direct or through the exporter's agents, and commonly includes freight and insurance. The term "commission agent" is now discredited, and buying done by Manchester houses on simple commission terms is unusual though not unknown. This has been so since the famous law case of *Williamson v. Barbour* in 1877, when it was established that whatever might be the custom of the trade a commission agent was not entitled to make a profit over his commission on the various processes, such as handling and packing, which are a necessary part of the exporter's work. A good deal of business is done, however, for South America and other markets in which the goods are bought for delivery in the Manchester warehouse, all charges for packing, &c., and carriage being extra.

Transactions with distant markets are now done almost entirely by cable, and a remarkable development of the telegraphic code has enabled merchants to pack a good deal into a brief message. A cable sent to India in the evening may bring a reply next morning, and in these days of rapid cotton fluctuations mail advices are confined mainly to general discussion, hypothetical inquiry, advice, admonition and complaint. Some Manchester export business is done through London, Glasgow, and continental towns, of which Hamburg is the principal. Glasgow buys largely of yarns and cloth, some considerable part of which is dyed or printed, for India and elsewhere, and has an indigenous manufacture and trade in fine goods such as book-muslins and lappets, a somewhat delicate department of manufacture which necessitates a slower running of machinery than is usual in Lancashire.

Besides the indent business there is, of course, purely merchant business by Manchester exporters, who buy on their own initiative at what they consider to be opportune times or on recommendations from their houses or correspondents abroad. In the Indian trade, especially in the Calcutta trade, a large proportion of the total amount is done by a few houses who buy in this way, and there is some difference of opinion as to whether the method, which had fallen out of fashion, may not further develop. It is more speculative than the indent business, but the dealing with large quantities which it involves gives the opportunity to buy very cheaply. A good many firms venture occasionally to buy in anticipation of their customers' needs, especially when they expect a rising market. During the great trade "boom" of 1905 there was a good deal of buying by exporters in advance of their indents because manufacturers continued to contract engagements which threatened to exclude dilatory buyers. On the whole, however, what may be called the speculative centre of gravity of Great Britain's export business in cotton goods is not in Manchester but abroad.

The terms on which business is conducted are various even in a single market, and it is sometimes a reproach that British firms are old-fashioned in their reluctance to give credit. The so-called enterprising methods of some German traders are, however, condemned by many experienced English traders, and it is said that in China, for instance, the seeming successes of the newcomers are delusive. The Tientsin developments of German business on credit terms are said to have proved unsatisfactory, and heavy losses were suffered in Hong-Kong some years ago by merchants who endeavoured to initiate a bolder system of trading. The very common complaint of British consuls that British firms neglect to send out travellers may have some foundation, but a commercial house naturally follows the line of least resistance to the development of its trade, and cannot be expected to work remote and barren ground when better opportunities are near at hand. On the whole it appears that the British cotton trade continues to increase to a satisfactory degree in fancy and special goods, which require for their production a comparatively high degree of technical skill, and are more lucrative than some of the simpler products in which competitors have been most formidable. Various finishing processes, and particularly the mercerizing of yarn and cloth, have increased the possibilities in cotton materials, and while staples still form the bulk of our foreign trade, it seems that as the stress of competition in these grows acute, more and more of our energy may be transferred to the production of goods which appeal to a growing taste or fancy.

*British Home Trade.*—The home trade in cotton cloths is a great and important section, but it is not comparable in volume to the export trade. It involves more numerous and more elaborate processes, and the qualities for home use are generally finer and more costly than those for export. Of course by far the larger part of the yarn spun in Lancashire is woven in Lancashire, but of the cotton cloth woven in Lancashire it is roughly estimated that about 20% is used in Great Britain. Not only is the average of quality better, but the variety of kinds and designs is greater in the home trade than in the export trade. A good home trade connexion is considered an extremely valuable asset, and as the trade is highly differentiated the profits are usually good. Some manufacturers devote themselves exclusively to the home trade,



and some exclusively to foreign trade, but there is a large class with what may be called a margin of alternation, which serves to redress the balance as business in one or other of the sections is good or bad.

Certain kinds of light goods made for India and other Eastern markets are not used in the home trade, and the typical Eastern staples are not generally used in their particular "sizings," but with these exceptions and various specialities almost every kind of cotton cloth is used to some extent in Great Britain. Grey calicoes for home use, except the lowest kinds, are comparatively pure, and of late years the heavy fillings which used to be common in bleached goods have become discredited. The housewife long persisted in deceiving herself by purchasing filled calicoes, and the movement in favour of purer goods owes a good deal, strangely enough, to the increase in the making-up trade and the consequent inconveniences to workers of sewing machines, whose needles were constantly broken by hard filled calicoes.

This development of the making-up trade has become an important element in the home trade, and it has greatly reduced the retail sale of piece-goods. The purchase of ready-made shirts, underclothing, &c., corresponds to a change in the habits of the people. The factories which have been erected in the north of Ireland, on the outskirts of London and elsewhere turn out millions of garments that would, under the old conditions, have been made at home. It is not necessary here to balance the advantages and disadvantages of the two systems, and it must not be supposed that made-up cotton garments are necessarily cheap and inefficient.

The chief distributing centre of cotton made-up goods is London, though a considerable trade is done through wholesale houses in Manchester and elsewhere. Large warehouses in the city of London carry on the trade and frequently supply Lancashire with her own goods. Of course the partial loss of the piece-goods trade by the shops is not a loss in aggregate trade, as they are the ultimate distributors of the made-up garments, which are probably at least as profitable to retail as calico or flannelette sold in lengths.

The normal course of home trade piece-goods is from manufacturer to bleacher, dyer, printer or finisher, either on account of a merchant to whom the goods are sold or on the manufacturer's own account. By far the majority of Lancashire manufacturers sell their goods as they come from the loom, or, as it is called, in the "grey state," but an increasing number now cultivate the trade in finished goods. Usually the manufacturer sells either directly or through an agent to a merchant who sells again to the shopkeeper, but the last twenty or thirty years have seen a considerable development of more direct dealing. Some manufacturers now go to the shopkeeper, and this has made it difficult for the merchant with a limited capital and therefore a limited assortment to survive. The great general houses such as Rylands's, Philips's and Watt's in Manchester, and Cook's and Pawson's in London, some of which are manufacturers to a minor degree, continue to flourish because under one roof they can supply all that the draper requires, and so enable him to economize in the time spent in buying and to save himself the trouble of attending to many accounts. Some general merchants, indeed, supply what are practically "tied houses," which give all their trade in return for pecuniary assistance or special terms.

The tendency to eliminate the middleman has not only brought a good many manufacturers into direct relation with the shopkeeper, but in some exceptional cases the manufacturer, adopting some system of broadcast advertisement and postal delivery, has dealt with the consumer. Naturally, the merchant resents any developments which exclude him, and some mild forms of boycott have occasionally been instituted. In the United States there has been an arduous struggle over this question, and combinations of merchants have sometimes compelled favourable terms. In England, though the merchant has maintained a great part of the trade with shopkeepers, the developing trade with makers of shirts, underclothing, &c., is mainly done by the manufacturers directly, and perhaps the simplification of relations by direct dealing in the cotton trade has now reached

a point of fairly stable compromise. The tendency to direct trading is naturally controlled by the exigencies of capital. Those manufacturers who act as merchants aim to retain the merchant profit and must employ a merchant capital in stocks. There has been a tendency, indeed, to make the manufacturer the stock-keeper, and some merchants do little more than pass on the goods a stage after taking toll. The great improvement in trade during 1905 and 1906 checked this tendency, and probably the manufacturing extensions owed something to the capital set free by the reductions of stocks.

It must be noted, however, that while most of the spinning concerns are worked by limited companies or individuals with a considerable capital, a good many small manufacturers exist who have little capital and are practically financed by their agents or customers. This is so in both the export and home trades.

The home trade merchant or merchant-manufacturer works largely through agents and travellers, and though railway facilities continue to improve, some shopkeepers rarely visit their markets. The difficulty that is naturally experienced by a traveller in finding sufficient support on a sparsely populated "ground" has brought into vogue the traveller on commission who represents several firms. The traveller with salary and allowances for expenses survives, but the quickening induced by an interest in the amount of sales has caused many firms to adopt the principle of commission, which may, however, be an addition to a minimum salary. Of course, such travellers are not peculiar to the cotton trade, but cotton goods in various forms are an important factor in the home trade.

The profits of manufacturers, merchants and shopkeepers are commonly very much less on the lower classes of cotton goods than on the higher ones. Thus while there may be a difference of 1d. per yd. between the qualities on a manufacturer's list, the difference in cost may not be more than a farthing; and, again, while the shopkeeper sometimes pays 2½d. or even 2¾d. per yd. for a calico to retail at 2¾d., his next selling price may be 3¾d. for one which costs him only 2¾d. or 3d. per yd. It appears, therefore, that if the poorer classes of the community have the discretion to avoid the lowest qualities they may obtain very good value in serviceable goods. In the matter of profits, however, there is a good deal of irregularity.

*The Manchester Royal Exchange.*—There are not many cotton mills or weaving sheds in Manchester, which is, however, the great distributive centre, and its Exchange is the meeting-place of most classes of buyers and sellers in the cotton trade and various trades allied to it. As buyers of finished goods for London and the country do not attend it, certain departments of the home trade are hardly represented, but practically all the spinners and manufacturers and all the export merchants of any importance are subscribers. Transactions between spinners and manufacturers are largely effected on Tuesdays and Fridays, the old "market days," when the manufacturing towns are well represented, but a large amount of business is transacted every day. Besides the persons immediately concerned in the cotton trade and connected with allied trades, a large number of members find it convenient to use this great meeting-place as a means of approach to a body of responsible persons. Thus not only bleachers, carriers, chemical manufacturers, mill furnishers and accountants find their way there, but also tanners, timber merchants, stockbrokers and even wine merchants. Since the Ship Canal made Manchester into a cotton port there has been a steady development of the raw cotton trade in Manchester, and many cotton brokers and merchants have Manchester offices or pay regular visits from Liverpool.

The various expansions and developments have made it difficult to maintain the ratio between accommodation and requirements, and although overcrowding is troublesome only during some three or four hours a week, at "high 'Change" on market days, various complaints and suggestions provoked in 1906 an appeal from the chairman of directors to the Manchester corporation. This took the form of a suggestion that the Exchange should be worked as a municipal institution on a new site, and though such a development met with opposition it was

apparent that Manchester must presently have a new or an enlarged Exchange. The present building is, however, the largest of the kind in the world, and the history of the various exchanges coincides with the expansion of the Lancashire industry.

According to semi-official records "the first building in the nature of an Exchange" was erected in 1729 by Sir Oswald Mosley, and though designed for "chapmen to meet and transact their business" it appears that, as to-day, encroachments were made by other traders until cotton manufacturers and merchants preferred to do their business in the street. In 1792 the building was demolished, and for a period of some eighteen years there was nothing of the kind. In 1809 the new Exchange was opened, and terms of membership were fixed at two guineas for those within 5 m. of the building and one guinea for those outside this radius. In the following year plans for enlargement were submitted to the shareholders, and various extensions followed, particularly in 1830 and 1847. The present building was opened partly in 1871 and partly in 1874. The area of the great room is 4405 sq. yds. The subscription was raised on the 1st of January 1906 from three guineas to four guineas for new members, but the number of members continues to increase and early in 1906 amounted to 8786.

Of course in this great mart a large variety of types is to be found and the members fall into some kind of rough grouping. Export buyers, attended by salesmen, are commonly more or less stationary and prominent; Burnley manufacturers abound in one locality and spinners of Egyptian yarns in another. The importance of the Exchange as a bargaining centre is fairly maintained, though buyers are assiduously cultivated in their own offices, and the telephone has done a good deal to abbreviate negotiation. As to the amount of business transacted on the Exchange there is no record. The market reporters make some attempt to materialize the current gossip, and doubtless catch well enough the great movements in the ebb and flow of demand, but the sum of countless obscure transactions cannot be estimated. Some few years ago an attempt was made to mark more clearly the course of business in Manchester, and a scheme was prepared for the recording of daily transactions. This could only have been a somewhat rough affair, but its originator maintained reasonably that it would be of interest if some indication of the daily movements could be obtained. For some time a memorandum of the total of daily sales reported was posted on 'Change, but the indifference of traders, together with the distrust that makes any innovation difficult, caused the scheme to be abandoned.

It would be difficult in any attempt to estimate the volume of British home trade to distinguish what may be called the effective movements of goods. There is a considerable amount of re-selling both in yarn and cloth, and, though the bulk of cotton goods finds the way through regular and normal channels to the consumer, these channels are not always direct. A good many transactions on the Manchester Exchange are intermediate, without fulfilling any useful function, and could be accomplished by the principals if they were brought together. Agents, of whom there are many, sometimes occupy a precarious position, but they are protected in some degree by law as well as by the custom of the trade and the point of honour. Points of honour in the Manchester business may seem to be arbitrarily selected, but they are an important part of the scheme. An immense amount of business is done without any apparent check against repudiation. It is, of course, the verbal bargain that binds, and large transactions are commonly completed without witnesses, though before the contract or memorandum of sale passes the fluctuations of the market may have made the bargain, to one side or the other, a very bad one. (A. N. M.)

**COTTON MANUFACTURE.** The antiquity of the cotton industry has hitherto proved unfathomable, as can readily be understood from the difficulty of proving a universal negative, especially from such scanty material as we possess of remote ages. That in the 5th century B.C. cotton fabrics were unknown or quite uncommon in Europe may be inferred from Herodotus' mention of the cotton clothing of the Indians. Ultimately the

cotton industry was imported into Europe, and by the middle of the 13th century we find it flourishing in Spain. In the New World it would seem to have originated spontaneously, since on the discovery of America the wearing apparel in use included cotton fabrics. After the collapse of Spanish prosperity before the Moors in the 14th century the Netherlands assumed a leadership in this branch of the textile industries as they did also in other branches. It has been surmised that the cotton manufacture was carried from the Netherlands to England by refugees during the Spanish persecution of the second half of the 16th century; but no absolute proof of this statement has been forthcoming, and although workers in cotton may have been among the Flemish weavers who fled to England about that time, and some of whom are said to have settled in and about Manchester, it is quite conceivable that cotton fabrics were made on an insignificant scale in England years before, and there is some evidence to show that the industry was not noticeable till many years later. If England did derive her cotton manufacture from the Netherlands she was unwillingly compelled to repay the loan with interest more than two hundred years later when the machine industry was conveyed to the continent through the ingenuity of Liévin Bauwens, despite the precautions taken to preserve it for the British Isles. About the same time English colonists transported it to the United States. Since, as transformed in England, the cotton industry, particularly spinning, has spread throughout the civilized and semi-civilized world, though its most important seat still remains the land of its greatest development.

As early as the 13th century cotton-wool was used in England for candle-wicks.<sup>1</sup> The importation of the cotton from the Levant in the 16th century is mentioned by Hakluyt,<sup>2</sup> and according to Macpherson it was brought over from Antwerp in 1560. Reference to the manufacture of cottons in England long before the second half of the 16th century are numerous, but the "cottons" spoken of were not cottons proper as Defoe would seem to have mistakenly imagined. Thus, for example, there is a passage by William Camden (writing in 1590) quoted below, in which Manchester cottons are specifically described as woollens, and there is a notice in the act of 33 Henry VIII. (c. xv.) of the Manchester linen and woollen industries, and of cottons—which are clearly woollens since their "dressyng and frisyng" is noted, and the latter process, which consists in raising and curling the nap, was not applicable to cotton textiles. John Leland, after his visit to Manchester about 1538, used these words—"Bolton-upon-Moore market standeth most by cottons; divers villages in the Moores about Bolton do make cottons." Leland, it is true, might conceivably be referring to manufactures from the vegetable fibre, but it is exceedingly unlikely, since the term "cottons" would seem to have been current with a perfectly definite meaning. The goods were probably an English imitation in wool of continental cotton fustians—which would explain the name. Again we may quote from the act of 5 and 6 Edward VI., "all the cottons called *Manchester*, Lancashire and Cheshire cottons, full wrought to the sale, shall be in length twenty-two yards and contain in breadth three-quarters of a yard in the water and shall weigh thirty pounds in the piece at least"; and from the act 8 Elizabeth c. xi., "every of the said cottons being sufficiently milled or thicked, clean scoured, well-wrought and full-dried, shall weigh 21 lb at the least."<sup>3</sup> These are evidently the weights of woollen goods: further, it may be observed that milling is not applicable to cotton goods. The earliest reference to a cotton manufacture in England which may reasonably be regarded as pointing to the fabrication of textiles from cotton proper, is in the will of James Billston (a not un-English name), who is described as a "cotton manufacturer," proved at Chester in 1578.<sup>4</sup> It may plausibly be contended that James Billston was a worker in the

*Early  
history in  
England.*

<sup>1</sup> See the extract from the books of Bolton Abbey, given by Baines (p. 96) and dated 1298.

<sup>2</sup> Vol. ii. p. 206; Baines, pp. 96-97.

<sup>3</sup> Baines, pp. 93 and 94.

<sup>4</sup> Lancashire and Cheshire Record Society, vol. ii.

vegetable fibre, since otherwise "manufacturer of cottons" would have been a more natural designation. But the proof of the will of one cotton manufacturer establishes very little.

The next earliest known reference to the cotton industry proper occurs in a petition to the earl of Salisbury, made presumably in 1610, asking for the continuance of a grant for reforming frauds committed in the manufacture of "bambazine cotton such as groweth in the land of Persia being no kind of wool."<sup>1</sup> But a far more valuable piece of evidence, discovered by W. H. Price, is a petition of "Merchants and citizens of London that use buying and selling of fustians made in England, as of the makers of the same fustians."<sup>2</sup> Its probable date is 1621, and it contains the following important passages:—

"About twenty years past, divers people in this kingdom, but chiefly in the county of Lancaster, have found out the trade of making of other fustians, made of a kind of bombast or down, being a fruit of the earth growing upon little shrubs or bushes, brought into this kingdom by the Turkey merchants, from Smyrna, Cyprus, Acra and Sydon, but commonly called cotton wool; and also of linen yarn most part brought out of Scotland, and othersome made in England, and no part of the same fustians of any wool at all, for which said bombast and yarn imported, his majesty has a great yearly sum of money for the custom and subsidy thereof.

"There is at the least 40 thousand pieces of fustian of this kind yearly made in England, the subsidy to his majesty of the materials for making of every piece coming to between 8d. and 10d. the piece; and thousands of poor people set on working of these fustians.

"The right honourable duke of Lennox in 11 of Jacobus 1613 procured a patent from his majesty, of alnager of new draperies for 60 years, upon pretence that wool was converted into other sorts of commodities to the loss of customs and subsidies for wool transported beyond seas; and therein is inserted into his patent, searching and sealing; and subsidy for 80 several stuffs; and among the rest these fustians or other stuffs of this kind of cotton wool, and subsidy and a fee for the same, and forfeiture of 20s. for putting any to sale unsealed, the moiety of the same forfeiture to the said duke, and power thereby given to the duke or his deputies, to enter any man's house to search for any such stuffs, and seize them till the forfeiture be paid; and if any resist such search, to forfeit £10 and power thereby given to the lord treasurer or chancellor of the exchequer, to make new ordinances or grant commissions for the aid of the duke and his officers in execution of their office."

Here the date of the appearance of the cotton industry on an appreciable scale—it is questionable whether any importance should be attached to the expression "found out"—is given by those who would be speaking of facts within the memory of themselves or their friends as "about twenty years past" from 1621, and the annual output of the industry in 1621 is mentioned. Moreover, it is established by this document that for a time at least the cotton manufacture was "regulated" like the other textile trades. The date assigned by the petitioners for the first attraction of attention by the English cotton industry may be supported on negative grounds.

Baines assures us that William Camden, who wrote in 1590, devoted not a sentence to the cotton industry, though Manchester figures among his descriptions: "This town," he says, "excels the towns immediately around it in handsomeness, populousness, woollen manufacture, market place, church and college; but did much more excel them in the last age, as well by the glory of its woollen cloths (*lanearum pannorum honore*), which they call Manchester cottons, as by the privilege of sanctuary, which the authority of parliament under Henry VIII. transferred to Chester."<sup>3</sup> It is significant too that in the Elizabethan poorlaw of 1601 (43 Elizabeth), neither cotton-wool nor yarn is included among the fabrics to be provided by the overseers to set the poor to work upon; though, of course, it might be argued that so short-stapled a fibre needed for its working, when machinery was rough, a skill in the operative which would be above that of the average person unable to find employment. However, a proposal was made in 1626 to employ the poor in the spinning of cotton and weaving wool.<sup>4</sup>

<sup>1</sup> *State Papers, Domestic*, lix. 5. See W. H. Price, *Quar. Jour. Econ.*, vol. xx.

<sup>2</sup> London Guildhall Library, vol. Beta, *Petitions and Parliamentary Matters* (1620-1621), No. 16 (old No. 25).

<sup>3</sup> The act referred to is 33 Henry VIII. c. xv., already mentioned.

<sup>4</sup> Cunningham, *Growth of English Industry and Commerce* (1903), vol. ii. p. 623.

Prior to Mr Price's discovery of the petition mentioned above, the earliest known notice of the existence in England of a cotton industry of any magnitude was the oft-quoted passage from Lewes Roberts's *Treasure of Traffic* (1641), which runs: "The town of Manchester, in Lancashire, must be also herein remembered, and worthily for their encouragement commended, who buy the yarne of the Irish in great quantity, and weaving it, return the same again into Ireland to sell: Neither doth their industry rest here, for they buy cotton-wool in London that comes first from Cyprus and Smyrna, and at home work the same, and perfect it into fustians, vermillions, dimities and other such stuffs, and then return it to London, where the same is vented and sold, and not seldom sent into foreign parts."<sup>5</sup>

Despite Lewes Roberts's flattering reference, the trade of Manchester about that time consisted chiefly in woollen frizes, fustians, sackcloths, mingled stuffs, caps, inkles, tapes, points, &c., according to "A Description of the Towns of Manchester and Salford," 1650,<sup>6</sup> and woollens for a long time held the first place. But before another century had run its course cottons proper had pushed into the first rank, though the woollen industry continued to be of unquestionable importance. In 1727 Daniel Defoe could write, "the grand manufacture which has so much raised this town is that of cotton in all its varieties,"<sup>7</sup> and he did not mean the woollen "cottons," as he made plain by other references to the industry in the same connexion; but it was not until some fifty years later that the ousting of the woollen industry from what is now peculiarly the cotton district became unmistakable.<sup>8</sup> As a rule the woollen weavers were driven farther and farther east—Bury lay just outside the cotton area when Defoe wrote—and finally many of them settled in the West Riding. Edwin Butterworth even tells of woollen weavers who migrated from Oldham to the distant town of Bradford in Wiltshire because of the decline of their trade before the victorious cotton industry. Much the same fate was being shared by the linen industry in Lancashire, which was forced out of the county westwards and northwards. The explanation of the three centralizations, namely of the woollen industry, the cotton industry and the linen industry, is not far to seek. The popularity of the fabrics produced by the rising cotton industry enabled it to pay high wages, which, indeed, were essential to bring about its expansion. This a priori diagnosis is supported by contemporary analysis: thus "the rapid progress of that business (cotton spinning) and the higher wages which it afford, have so far distressed the makers of worsted goods in that county (Lancashire), that they have found themselves obliged to offer their few remaining spinners larger premiums than the state of their trade would allow."<sup>9</sup> The best operatives of Lancashire were attracted sooner or later to assist the triumphs of art over the vegetable wool. At the same time the scattered woollen and linen workers of Lancashire were suffering from the competition of rivals enjoying elsewhere the economies of some centralization, and the demand for woollen and linen warps in the cotton industry ceased after the introduction of Arkwright's water-twist. When the factory became common the economies of centralization (which arise from the wide range of specialism laid open to a large local industry) increased; moreover they were reinforced by the diminution of social friction and the intensification of business sensitiveness which marked the development of the 19th century. Once begun, the centralizing movement proceeded naturally with accelerating speed. The contrast beneath is an instructive statistical comment:—

<sup>5</sup> Original edition, pp. 32, 33.

<sup>6</sup> Aikin's *Description of the Country from Thirty to Forty Miles round Manchester*, p. 154.

<sup>7</sup> *Tour*, vol. iii. p. 219.

<sup>8</sup> For instance Radcliffe p. 61. Ogden (author of *A Description of Manchester, &c.*, published in 1783), if Aikin's "accurate and well-informed enquirer" by Ogden, says that the period of rapid extension of the cotton industry began about 1770. See also Butterworth's *History of Oldham* and the passage quoted below in the text.

<sup>9</sup> Account of Society for Promotion of Industry in Lindsey (1789), Brit. Mus. 103, L. 56. Quoted from Cunningham's *English Industry and Commerce*, vol. ii. p. 452, n. ed., 1892.

*Distribution of Cotton Operatives in 1838 and 1898-1899 (from Returns of Factory Inspectors).*

	1838.	1898-1899.
Cheshire . . . . .	36,400	34,300
Cumberland . . . . .	2,000	700
Derbyshire . . . . .	10,500	10,500
Lancashire . . . . .	152,200	398,100
Nottinghamshire . . . . .	1,500	1,600
Staffordshire . . . . .	2,000	2,300
Yorkshire . . . . .	12,400	35,200
England and Wales <sup>1</sup> . . . . .	219,100	496,200
Scotland . . . . .	35,600	29,000
Ireland . . . . .	4,600	800
United Kingdom . . . . .	259,300	526,000

The distribution of the industry has varied greatly in the two periods. If it had remained constant Lancashire would only have contained 300,000 operatives in 1899, instead of the actual 400,000. Scotland, on the other hand, only contained 30,000 instead of 70,000, and in Ireland the numbers were one-tenth of what they should have been. The percentage of operatives in Lancashire in 1838 was 58.5, but this increased to 75.7 in 1898.

Why, we may naturally inquire, did not the cotton industry localize in the West Riding or Cheshire and the woollen industry maintain its position in Lancashire? Accident no doubt partly explains why the cotton industry is carried on where it is in the various parts of the globe, but apart from accident, as regards Lancashire, it is sufficient answer to point to the peculiarly suitable congeries of conditions to be found there. There is firstly the climate, which for the purpose of cotton spinning is unsurpassed elsewhere, and which became of the first order of importance when fine spinning was developed. In the Lancashire atmosphere in certain districts just about the right humidity is contained on a great number of days for spinning to be done with the least degree of difficulty. Some dampness is essential to make the fibres cling, but excessive moisture is a disadvantage. Over the county of Lancashire the prevailing west wind carries comparatively continuous currents of humidified air. These currents vary in temperature according to their elevation. Hot and cold layers mix when they reach the hills, and the mixture of the two is nearer to the saturation point than either of its components. The degree of moisture is measured by the ratio of the actual amount of moisture to the moisture of the saturation point for that particular temperature. Owing to the sudden elevation the air is rarefied, its temperature being thereby lowered, and in consequence condensation tends to be produced. In several places in England and abroad, where there is a scarcity of moisture, artificial humidifiers have been tried, but no cheap and satisfactory one has hitherto been discovered. To the advantages of the Lancashire climate for cotton spinning must be added—especially as regards the early days of the cotton industry—its disadvantages for other callings. The unpleasantness of the weather renders an indoor occupation desirable, and the scanty sunshine, combined with the unfruitful nature of much of the soil, prevents the absorption of the population in agricultural pursuits. In later years the port of Liverpool and the presence of coal supplemented the attractions which were holding the cotton industry in Lancashire. All the raw material must come from abroad, and an enormous proportion of English cotton products figures as exports. The proximity of Liverpool has aided materially in making the cotton industry a great exporting industry.

Before the localization of the separate parts of the industry can be treated the differentiation of the industry must be described. We pass then, at this stage, to consider the manufacture in its earliest form and the lines of its development. First, and somewhat incidentally, we notice the early connexion between the conduct of the cotton manufacture, when it was a domestic

<sup>1</sup>In 1838 the only other county with more than 1000 was Gloucester with 1500. 217,000 of the 219,100 operatives in England and Wales were employed in the counties enumerated. Of the 2000 operatives whose location is not given, about 1000 worked in Flintshire.

industry in its primitive form, and the performance of agricultural operations. A few short extracts will place before us all the evidence that it is here needful to adduce.

First Radcliffe, an eye-witness, writing of the period about 1770, says "the land in our township (Mellor) was occupied by between fifty and sixty farmers . . . and out of these fifty or sixty farmers there were only six or seven who raised their rents directly from the produce of their farms, all the rest got their rent partly in some branch of trade, such as spinning and weaving woollen, linen or cotton. The cottagers were employed entirely in this matter, except for a few weeks in the harvest."<sup>2</sup> Next we may cite Edwin Butterworth who, though not an eye-witness (he was not born till 1812), proved himself by his researches to be a careful and trustworthy investigator. In the parish of Oldham, he recorded, there were "a number of master (cotton-linen fustian)<sup>3</sup> manufacturers, as well as many weavers who worked for manufacturers, and at the same time were holders of land or farmers. . . . The number of fustian farmers who were cottagers working for manufacturers, without holding land, were few; but there were a considerable number of weavers who worked on their own account, and held at the same time small pieces of land."<sup>4</sup> Other passages might be quoted, but these two will suffice. Weaving was not exactly a by-employment of farm labourers, but many weavers made agriculture a by-employment to some extent, (a) by working small parcels of land, which varied from the size of allotments to farms of a very few acres, and (b) by lending aid in gathering in the harvest when their other work enabled them to do so. The association of manufacturing and weaving survived beyond the first quarter of the 19th century. Of the weavers in many districts and "more especially in Lancashire" we read in the report of the committee on emigration, "it appears that persons of this description for many years past, have been occupiers of small farms of a few acres, which they have held at high rents, and combining the business of the hand-loom weaver with that of a working farmer have assisted to raise the rent of their land from the profits of their loom."<sup>5</sup> One of the first lines of specialism to appear was the severing of the connexion described above, and the concentration of the weavers in hamlets and towns. Finer fabrics and more complicated fabrics were introduced, and the weaver soon learnt that such rough work as farming unfitted his hands for the delicate tasks required of them. Again, really to prosper a weaver found it necessary to perfect himself by close application. The days of the rough fabrics that anybody could make with moderate success were closing in. As a consequence the dispersion of the weavers becomes less and less. They no longer wanted allotments or farms; and their looms having become more complicated, the mechanic proved himself a convenient neighbour. Finding spinners too was an easier task in the hamlet or town than in the remote country parts. But there is no reason to suppose that agriculture and the processes of the domestic cotton manufacturer had ever been universally twin callings. There never was a time, probably, when weavers who did nothing but weave were not a significant proportion, if not the major part, of the class of weavers. All again were not independent and all were not employees. Some were simply journeymen in small domestic workshops; others were engaged by fustian masters or Manchester merchants and paid by the piece for what they made out of material supplied them; others again bought their warps and cotton and sold to the merchants their fabrics, which were their own property. The last class was swept away soon after the industry became large, when by the organization of men of capital consumers and producers were more and

<sup>2</sup> W. Radcliffe's *Origin of the New System of Manufacturing*, p. 59.

<sup>3</sup> The term "fustian" had originally been used to designate certain woollen or worsted goods made at Norwich and in Scotland. A reference to Norwich fustians of as early a date as the 14th century is quoted by Baines.

<sup>4</sup> E. Butterworth's *History of Oldham*, p. 101.

<sup>5</sup> *Parliamentary Reports, &c.* (1826-1827), v. p. 5. See for even later examples Gardner's evidence to the committee on hand-loom weavers in 1835.

*Early system of manufacture and organization.*

more kept in touch. In early days most weavers owned their looms, the great part of which they had frequently constructed themselves: later, however, a large number hired looms, and it was as usual in certain quarters for lodgings to be let with a loom as it is to-day for them to be provided with a piano. When it became customary for weavers to undertake a variety of work, the masters usually provided reeds (which had to vary in fineness with the fineness of the warp), healds, and other changeable parts, and sometimes they employed the gaiters to fit the new work in the looms.

Until the success of the water-frame, cotton could not be spun economically of sufficient strength and fineness for warps, and the warps were therefore invariably made of either linen or wool. Some were manufactured locally, others were imported from Germany, Ireland and Scotland. The weaver prepared them for his loom by the system of peg-warping,<sup>1</sup> but after the introduction of the warping-mill he received them as a rule all ready for insertion into the loom from the Manchester merchant or local fustian master.

"It did not pay the individual weaver to keep a warping-mill for occasional use only, and frequently the contracted space of his work-room precluded even the possibility of his doing so. The invention of the warping-mill necessitated specialism in warping, and it was essential that warping should be done to order, since at that time, the state of the industrial world being what it was, no person could ordinarily have been found to adventure capital in producing warps ready made in anticipation of demand for the great variety of fabrics which was even then produced. Moreover, had the weaver himself placed the orders for his warps, any occasional delay in the execution of his commissions might have stopped his work entirely until the warps were ready; for warps cannot be delivered partially, like weft, in quantities sufficient for each day's work. To ensure continuous working in the industry, therefore, it was almost inevitable that the merchant should himself prepare the warps for such fabrics as he required, or possibly have them prepared. To the system of the merchant delegating the preparation of warps there was less objection than to the system of the weaver doing so, since the merchant, dealing in large quantities, was more likely to get pressing orders completed to time. Further, the merchant knew first what kind of warps would be needed. The first solution, however, that of the merchant undertaking the warping himself, was the surer, and there was no doubt as to its being the one destined for selection in a period when a tendency to centralize organization, responsibility and all that could be easily centralized, was steadily gaining in strength."<sup>2</sup>

Guest says the system by which the weaver was supplied with warps and other material was substituted for the purchase of warps and cotton-wool by the weaver about 1740. No doubt the change was very gradual, especially as Aikin mentions the use of warping-mills in the 17th century. The weaver as a rule received his weft material in the form of cotton-wool and was required to arrange himself for its cleaning and spinning. According to Aikin,<sup>3</sup> dealers tried the experiment of giving out weft instead of cotton-wool, but "the custom grew into disuse as there was no detecting the knavery of the spinners till a piece came in woven." As it was impossible to unwrap the yarn and test it throughout its length, defects were hidden until it came to be used, and the complaints of weavers were not conclusive as to the inferiority of the yarn, since their own bad workmanship might have had something to do with its having proved unsatisfactory. It was therefore found best to saddle the weaver with full responsibility for both the spinning and weaving. Women and children cleaned, carded and spun the cotton-wool in their homes. The cotton had to be more thoroughly cleaned after its arrival in this country. The ordinary process of cleaning was known as "willowing," because the cotton was beaten with willow switches after it had been laid out on a tight hammock of cords. The cotton used for fine spinning was also carefully washed; and even when it was not washed it was soaked with water and partially dried so that the fibres might be made to cling together.<sup>4</sup> Most of the weaving was done by men, and until

the invention of the fly-shuttle they cast the shuttle from hand to hand in the manner of their remotest ancestors. For the making of the broader fabrics two weavers were required when the width was greater than the easy stretch of a man's arms. Sometimes cloths were woven wide and then split into two or more: hence the term "splits." This became a common practice when the hand-loom workers were groaning under the pressure of competition from the power-loom.

We now reach the era of the great inventions. In order to ensure clearness it will be desirable to consider separately the branches of spinning and weaving: to pass from the one to the other, and follow the chronological order, might cause confusion. First emphasis must be laid upon the point that it was not mechanical change alone which constituted the industrial revolution. No doubt small hand-loom factories would have become the rule, and more and more control over production would have devolved upon the factory master, and the work to be done would have been increasingly assigned by merchants, had the steam-engine remained but the dream of Watt, and semi-automatic machinery not been invented. The spirit of the times was centralizing management before any mechanical changes of a revolutionizing character had been devised. Loom-shops, in which several journeymen were employed, were not uncommon: thus "in the latter part of the last (18th) and the beginning of the present (19th) century," says Butterworth, describing the state of affairs in Oldham and the neighbourhood, "a large number of weavers . . . possessed spacious loom-shops, where they not only employed many journeymen weavers, but a considerable proportion of apprentice children." It is true that both the fly-shuttle and drop-box had been invented by that time, but the loom was still worked by human power. Specialism, however, was on the increase, the capitalist was assuming more control, and the operative was being transformed more and more into the mere executive agent. Further, as creative of enterprise, an atmosphere of freedom and a general economic restlessness, consequent upon the reaction against mercantilism, were noticeable. Great changes, no doubt, would soon have swept over Lancashire had a new source of power and big factories not been rendered essential by inventions in spinning.

The chief inventors were Lewis Paul and John Wyatt, James Hargreaves and Samuel Crompton. The two first originated the principle of spinning by rollers. Their patent was taken out in 1738, but no good came of it immediately, though many trials were made and moderately large sums of money were lost. Ultimately Richard Arkwright brought forward the same plan improved:<sup>5</sup> his first patent was dated 1769. Over the real authorship of the fundamental idea there has been much controversy, and it has not been absolutely proved that the second inventor, whether Thomas Highs, Arkwright or John Kay (a clockmaker of Warrington who assisted Arkwright to construct his machine and is said by some to have told him of an invention by Highs), did not hit upon the device afresh in ignorance of the work already done. Even as between Paul and Wyatt it is not easy to award due measure of praise. Probably the invention, as a working machine, resulted from real collaboration, each having an appreciable share in it. Robert Cole, in his paper to the British Association in 1858 (reprinted as an appendix to the 1st ed. of French's *Life of Crompton*), championed the claims of Paul, but Mantoux, in his *La Révolution industrielle au XVIII<sup>e</sup> siècle*, after studying the Wyatt MSS., inclines to attribute to Wyatt a far more important position, though he dissents from the view of Baines, who ascribes little or nothing to Paul.

Arkwright's prospects of financial success were much greater than those of his predecessors, because, first, there was more employ her son George shortly after he could walk, as a "dolly-peg" to tread the cotton in the soapy water in which it was placed for washing. See French's *Life of Crompton*, pp. 58-59 (3rd ed.). Rowbotham in his diary gives two accounts of fires which were caused by carelessness in drying cotton.

<sup>5</sup> On the difference between the two machines see Baines's *History*, p. 138 et seq.

<sup>1</sup> This is illustrated in one of the plates to Guest's *History of the Cotton Manufacture*.

<sup>2</sup> Chapman's *Lancashire Cotton Industry*, pp. 15 and 16.

<sup>3</sup> Page 167.

<sup>4</sup> Mrs Crompton, wife of Samuel Crompton, we are told, used to

*The invention of machinery.*

*Spinning and preparatory machinery.*



need in his time of mechanical aids, and secondly, he was highly talented as a business man. In 1775 he followed up his patent of 1769 with another relating to machinery for carding, drawing and roving. The latter patent was widely infringed, and Arkwright was compelled to institute nine actions in 1781 to defend his rights. An association of Lancashire spinners was formed to defend them, and by the one that came to trial the patent was set aside on the ground of obscurity in the specifications. Arkwright again attempted to recover his patent rights in 1785, after the first patent had been in abeyance for two years. Before making this further trial of the courts he had thought of proceeding by petition to parliament, and had actually drawn up his "case," which he was ultimately dissuaded from presenting. In it he prayed not only that the decision of 1781 should be set aside, but that both patents should be continued to him for the unexpired period of the second patent, *i.e.* until 1789. In his "case" (*i.e.* the petition mentioned above) Arkwright stated that he had sold to numbers of adventurers residing in the different counties of Derby, Leicester, Nottingham, Worcester, Stafford, York, Hertford and Lancaster, many of his patent machines, and continued: "Upon a moderate computation, the money expended in consequence of such grants (before 1782) amounted to at least £60,000. Mr Arkwright and his partners also expended in large buildings in Derbyshire and elsewhere upwards of £30,000, and Mr Arkwright also erected a very large and extensive building in Manchester at the expense of upwards of £4000. Thus a business had been formed which already (he calculated) employed upwards of five thousand persons, and a capital on the whole of not less than £200,000."<sup>1</sup> It is impossible to discover exactly the rights of the matter. Certainly Arkwright had been intentionally obscure in his specifications, as he admitted, and for his defence, namely that it was to preserve the secret for his countrymen, there was only his word. He may have hoped to keep the secret for himself; and as to the originality of both inventions there were grave doubts. But Arkwright has received little sympathy, because his claims were regarded as grasping in view of the large fortune which he had already won. He began work with his first partners at Nottingham (when power was derived from horses) and started at Cromford in 1771 (where the force of water was used). Soon he was involved in numerous undertakings, and he remained active till his death in 1792. He had met throughout with a good deal of opposition, which possibly to a man of his temperament was stimulating. Even in the matter of getting protective legislation reframed to give scope to the application of the water-frame, a powerful section of Lancashire employers worked against him. This protective legislation must here be shortly reviewed.

In 1700 an act had been passed (11 & 12 William III. c. 10) prohibiting the importation of the printed calicoes of India, Persia and China. In 1721 the act 7 George I. c. 7 prohibited the use of any "printed, painted, stained or dyed calico," excepting only calicoes dyed all blue and muslins, neckcloths and fustians. This act was modified by the act 9 George II. c. 4 (allowing British calicoes with linen warps). Thus the matter stood as regards prints when Arkwright had demonstrated that stout cotton warps could be spun in England, and at the same time the officers of excise insisted upon exacting a tax of 6d. from the plain all-cottons instead of the 3d. paid by the cotton-linens, on the ground that the former were calicoes. Arkwright's plea, however, was admitted, and by the act 14 George II. c. 72 the still operative part of the act of 1721 was set aside, and the manufacture, use, and wear of cottons printed and stained, &c., was permitted subject to the payment of a duty of 3d. per sq. yd. (the same as the excise on cotton-linens) provided they were stamped "British manufactory." The duty was varied from time to time until its repeal in 1832.

Some more powerful force than that of man or horse was soon needed to work the heavy water-frames. Hence Arkwright placed his second mill on a water-course, fitting it with a water-wheel, and until the steam-engine became economical most of the new twist mills were built on water-

<sup>1</sup> Baines p. 183.

courses. On rare occasions the old fire-engines seem to have been tried.

The following passage quoted from a note in Baines's *History* illustrates the pressing need of the early mills: "On the river Irwell, from the first mill near Bacup, to Prestolee, near Bolton, there is about 900 ft. of fall available from mills, 800 of which is occupied. On this river and its branches it is computed that there are no less than three hundred mills. A project is in course of execution to increase the water-power of the district, already so great and so much concentrated, and to equalize the force of the stream by forming eighteen reservoirs on the hills, to be filled in times of flood, and to yield their supplies in the drought of summer. These reservoirs, according to the plan, would cover 270 acres of ground, and contain 241,300,000 cub. ft. of water, which would give a power equal to 6600 horses. The cost is estimated at £59,000. One reservoir has been completed, another is in course of formation, and it is probable that the whole design will be carried into effect."<sup>2</sup>

As early as 1788 there were 143 water-mills in the cotton industry of the United Kingdom, which were distributed as follows among the counties which had more than one.<sup>3</sup>

Lancashire . . . . .	41	Flintshire . . . . .	3
Derbyshire . . . . .	22	Berkshire . . . . .	2
Nottinghamshire . . . . .	17	Lanarkshire . . . . .	4
Yorkshire . . . . .	11	Renfrewshire . . . . .	4
Cheshire . . . . .	8	Perthshire . . . . .	3
Staffordshire . . . . .	7	Midlothian . . . . .	2
Westmorland . . . . .	5	Isle of Man . . . . .	1

The need of water to drive Arkwright's machinery, and its value for working other machinery, caused a strong decentralizing tendency to show itself in the cotton industry at this time, but more particularly in the twist-spinning branch. Ultimately the steam-engine (first used in the cotton industry in 1785) drew all branches of the industry into the towns, where the advantages of their juxtaposition—*i.e.* the external economies of centralization—could be enjoyed. Out of the crowding of the mills in one locality sprang the business specialism which has continued up to the present day. Here it will not be out of place to notice the appearance of the new power, electricity, in the cotton industry, the extension of which may involve striking economic changes. The first electric-driven spinning-mill in Lancashire, that of the "Acme" Spinning Company at Pendlebury, the work of which is confined to the ring-frame, was opened in 1905. Power is obtained from the stations of the Lancashire Power Company at Outwood near Radcliffe, some 5 m. distant.

The chief principle of the water-frame was the drawing out of the yarn to the required degree of tenacity by sets of gripping rollers revolving at different speeds. This principle is still applied universally. Twist was given by a "flyer" revolving round the bobbin upon which the yarn was being wound; the spinning so effected was known as throstle-spinning. The plan is still common in the subsidiary processes of the cotton industry, but for spinning itself the ring-frame, which appears to have been invented simultaneously in England and the United States (the first American patent is dated 1828), is rapidly supplanting the throstle-frame,<sup>4</sup> though the "ooziness" of mule yarn has not yet been successfully imitated by ring-frame yarn. The great invention relating to weft-spinning was the jenny, introduced by James Hargreaves probably about 1764, and first tried in a factory four years later.<sup>5</sup> Hargreaves unfortunately was unable to maintain his patent, because he had sold jennies before applying for protection. Crompton's mule, which combined the principles of the rollers and the jenny, was perfected about 1779. Both jennies and mules were known as "wheels," because they were worked in part by the turning of a wheel. As they could be set in motion without using much power, being light when of moderate

<sup>2</sup> Baines's *History of the Cotton Manufacture*, p. 86 n.

<sup>3</sup> These figures are quoted from a pamphlet published in 1788 entitled "An Important Crisis in the Calico and Muslin Manufactory in Great Britain explained." Many of the estimates given in this pamphlet are worthless, but there seems no reason why the figures quoted here should not be at least approximately correct.

<sup>4</sup> See article on COTTON-SPINNING MACHINERY.

<sup>5</sup> Hargreaves' claim to this invention has been disputed, but no satisfactory evidence has been brought forward to disprove his claim. Hargreaves was a carpenter and weaver of Stand-hill near Blackburn, and died in 1778.

size, for a long time they were worked entirely by hand or partially with the aid of horses or water. The first jenny- and mule-factories were small for this reason, and also because skill in the operative was a matter of fundamental importance,<sup>1</sup> as it was not in twist-spinning on the water-frame. The size of the typical weft-spinning mill suddenly increased after the scope for the application of power was enlarged by the use of the self-actor mule, invented in 1825 by Richard Roberts, of the firm of Sharp, Roberts & Co., machinists, of Manchester. In 1830 Roberts improved his invention and brought out the complete self-actor. Self-actors had been put forward by others besides Roberts—for instance by William Strutt, F.R.S. (son of Arkwright's partner), before 1790; William Kelly, formerly of Lanark mills, in 1792; William Eaton of Wiln in Derbyshire; Peter Ewart of Manchester; de Jongh of Warrington; Buchanan, of Catrine works, Scotland; Knowles of Manchester; and Dr Brewster of America<sup>2</sup>—but none had succeeded. And Roberts's machines did not immediately win popularity. For a long time the winding done by them was defective, and they suffered from other imperfections. Broadly speaking, until the American Civil War the number of hand-mules in use remained high. It was for the fine "counts" in particular that many employers preferred them.<sup>3</sup> About the end of the 'sixties, however, and in the early 'seventies, great improvements were effected in machinery, partly under the stimulus of a desire to elevate its fitness for dealing with short-staple cotton, and it became evident that hand-mules were doomed. Here we may suitably refer to the scutching machine for opening and cleaning cotton, invented by Mr Snodgrass of Glasgow in 1797, and introduced by Kennedy<sup>4</sup> to Manchester in 1808 or 1809; the cylinder carder invented by Lewis Paul and improved by Arkwright; and the lap-machine first constructed by Arkwright's son.

We now transfer our attention to that accumulation of improvements in manufacturing (as weaving is technically termed) which, taken in conjunction with the inventions already described, presaged the large factory system which covers Lancashire to-day. Gradually, for many years, the loom had been gathering complexities, though no fundamental alteration was introduced into its structure until 1738, when John Kay of Bury excited the wrath of his fellow-weavers by designing and employing the device of the fly-shuttle. For some unfathomable reason—for the opposition of the weavers hardly explains it, though they expressed their views forcibly and acted upon them violently—this invention was not much applied in the cotton industry until about a quarter of a century after its appearance. The plan was merely to substitute for human hands hammers at the ends of a lengthened lathe along which the shuttle ran, the hammers being set in motion by the jerking of a stick (the picking peg) to which they were attached by strings. The output of a weaver was enormously increased in consequence. In 1760 John Kay's son Robert added the drop-box, by the use of which many different kinds of weft could be worked into the same fabric without difficulty. It was in fact a partitioned lift, any partition of which could be brought to a level with the lathe and made for the time continuous with it. The drop-box usefully supplemented the "draw-boy," or "draught-boy," which provided for the raising of warps in groups, and thereby enabled figured goods to be produced. The "draw-boy" had been well known in the industry for a long time; in 1687 a Joseph Mason patented an invention for avoiding the expense of an assistant to work it,<sup>5</sup> but there is no evidence to show that his invention was of

practical value. Looms with "draw-boys" affixed, which could sometimes be worked by the weavers themselves, later became common under the name of harness-looms, which have since been supplanted by Jacquard looms, wherein the pattern is picked out mechanically.

The principle of the fly-shuttle was a first step towards the complete mechanizing of the action required for working a loom. The second step was the power-loom, the initial effort to design which was created by the tardiness of weaving as contrasted with the rapidity of spinning by power. After the general adoption of the jenny, supplies of yarn outran the productive powers of the agencies that existed for converting them into fabrics, and as a consequence, it would seem, some yarn was directed into exports which might have been utilized for the manufacture of cloth for export had the loom been more productive. The agitation for the export tax on yarn at the end of the 18th, and in the first years of the 19th century, is therefore comprehensible, but there was no foundation for some of the allegations by which it was supported. For a large proportion of the exported yarn, fabrics could not have been substituted, since the former was required to feed the hand-looms in continental homes and domestic workshops, against much of the product of which there was no chance of competing. The hand-loom was securely linked to the home of the peasant, and though he would buy yarn to feed his loom he would not buy cloth and break it up.<sup>6</sup>

Cartwright's loom was not the first design adapted for weaving by power. A highly rudimentary and perfectly futile self-actor weaving machine, which would have been adapted for power-working had it been capable of working at all, had been invented by a M. de Gennes: a description of it, extracted from the *Journal de sçavans*, appeared in the *Philosophical Transactions* for July and August 1678, and again in the *Gentleman's Magazine* in 1751 (vol. xxi. pp. 391-392). It consisted of mechanical hands, as it were, that shot in and out of the warp and exchanged the shuttle.<sup>7</sup> Another idea, which however proved fruitful, was that of grinding the shuttle through the warps by the agency of cog-wheels working at each end upon teeth affixed to the upper side of the shuttle. Though shuttles could not in this fashion be set in rapid movement, the machine turned out to be economical for the production of ribbons and tapes, because many pieces could be woven by it at once. These contrivances were known as swivel-looms, and in 1724 Stukeley in his *Itinerarium curiosum* wrote that the people of Manchester have "looms that work twenty-four laces at a time, which was stolen from the Dutch." Ogden says also that they were set up in imitation of Dutch machines by Dutch mechanics invited over for the purpose. Another interesting passage relating to the swivel-looms will be found in the rules of the Manchester small-ware weavers dated 1756, where the complaint is made that the masters have acquired by the employment of "engine or Dutch looms such large and opulent fortunes as hath enabled them to vie with some of the best gentlemen of the country," and it is alleged that these machines, which wove twelve or fourteen pieces at once, "were in use in Manchester thirty years ago."<sup>8</sup> One power-factory at least was devoted to them as early as 1760, namely that of a Mr Gartside at Manchester, where water-power was applied, but the enterprise failed.<sup>9</sup> Cartwright's invention was probably perfected in its

<sup>6</sup> For further analysis of the arguments current see Chapman's *Lancashire Cotton Industry*, pp. 66 et seq.

<sup>7</sup> Also in the 17th century a John Barksstead was granted a patent for a method of manufacturing cotton goods, but the method is not described. 1691, Specification 276.

<sup>8</sup> In the parliamentary reports (1840), xxiv. p. 611, the invention of the swivel-loom is claimed for a "Van Anson." It is a plausible supposition that by "Van Anson" is meant Vaucanson, as he appears to have improved the swivel-loom. But he could not have been the original inventor, since in 1724 (that is, when Vaucanson was at the most fifteen years of age) they were being employed in Manchester.

<sup>9</sup> Aikin, pp. 175-176, and Guest, p. 44. An explanation of the mechanism of the swivel-loom will be found in the *Encyclopédie méthodique, manufactures, arts et métiers*, pt. i. vol. ii. pp. 202, 208, and *Recueil de planches*, vol. vi. (1786), pp. 72-78.

<sup>1</sup> See Chapman's *Lancashire Cotton Industry*, pp. 59 et seq.

<sup>2</sup> See Baines p. 207.

<sup>3</sup> "Counts" are determined by the number of hanks to the lb. A hank is 840 yds. The origin of the hank of 840 yds. is probably that spinners used a winding-reel of 1½ yds. in circumference, so that 80 threads (one "lea" or "rap" according to old phraseology) would contain 120 yds., and seven leas (i.e. a hank) would contain 840 yds. A hank of seven leas was the common measure in the woollen industry, in which the reels were 1 yd. or 2 yds. in circumference. For details see an article on the subject in the *Textile World Record*, vol. xxxi. No. 1.

<sup>4</sup> The author of the memoir of Crompton (see bibliography).

<sup>5</sup> Specification 257.

first form about 1787, but many corrections, improvements and additions had to be effected before it became an unqualified success. Cartwright's original idea was elaborated by numerous followers, and supplementary ideas were needed to make the system complete. Of the latter the most important were those due to William Radcliffe, and an ingenious mechanic who worked with him, Thomas Johnson, which were patented in 1803 and 1804. They related to the dressing of the warp before it was placed in the loom, and for the mechanical taking up of the cloth and drawing forward of the warp, so that the loom had not to be stopped for the cloth to be moved on and the warp brought within play of the shuttle to be sized. Looms fitted with the latter of these devices were known as "dandy" looms. The looms that followed need not be described here, nor need we concern ourselves with the degree in which some were imitations of others. It is of interest to note, however, in view of recent developments, that one of Cartwright's

patents included a warp-stop motion, though it was never tried practically so far as the writer is aware. Looms with warp-stop motions are now common in the United States, as are also automatic looms, but both are still the exception in Lancashire for reasons that will be sketched later.

Power-looms won their way only very gradually. Cartwright and others lost fortunes in trying to make them pay, but the former was compensated by a grant of £10,000 from government. In 1813 there were 2400 only in the whole of the United Kingdom; in 1820 there were 14,000, beside some 240,000 hand-looms; in 1829, 55,500; in 1833, 100,000; and in 1870, 440,700.<sup>1</sup> To-day there are about 700,000 in the cotton industry. The beginning, and the final consequences, of the competitive pressure of the power-looms may be read in the reports of official inquiries and in Rowbotham's diary.<sup>2</sup> It was upon the fine work that the hand-loom weavers retained their last hold. In 1829 John Kennedy wrote in his paper to the Manchester Literary and Philosophical Society on "The Rise and Progress of the Cotton Trade," "It is found . . . that one person cannot attend upon more than two power-looms, and it is still problematical [even in 1829, observe] whether the saving of labour counterbalances the expense of power and machinery and the disadvantage of being obliged to keep an establishment of power-looms constantly at work." It was not easy to obtain a sufficiency of good hands for the power-looms, because the operatives, who had acquired their habits under the domestic system, hated factory life. This, in conjunction with the ease with which the art of coarse weaving could be acquired and the cheapness of rough looms, helps to explain the wretched straits into which the hand-loom weavers were driven.

Improvements in machinery, which ultimately affected every process from cleaning the cotton to finishing the fabric, and the application of water and steam-power, so lowered the cost of production as to render Lancashire the cotton factory of the world. Figures are quoted in the table to show the rate of growth in different periods of England's imports and exports as regards the raw material and products of this industry. It is important to remember when reading the last 6 columns that the value of money was the same in 1831-1835, 1851-1855

and 1876-1880: the sums of Sauerbeck's index numbers for these periods were 454, 451 and 444 respectively. In the last two periods there were considerable depressions in prices. If prices had remained constant, in the periods 1891-1895 and 1896-1900 the figures of exports would have been £90 millions and £91 millions respectively. The growth in trade has been partly occasioned by the enormous increase in the volume of cotton goods consumed all over the world, which in turn has been due to (1) the growth of population, (2) the increase in productive

Year.	Imports of Raw Cotton, Million lb.	Raw Cotton re-exported, Million lb.	Exports of Cotton Yarns and Manufactures, Million £.			Imports of Cotton Yarns and Manufactures, Million £.		
			Yarns.	Manu- factures.	Total.	Yarns.	Manu- factures (excluding Lace).	Total.
1700-1705	1.17	..	..	..	..	..	..	..
1771-1775	4.76	..	..	..	..	..	..	..
1785-1789	..	..	..	..	1.07 <sup>1</sup>	..	..	..
1791-1795	26.00	..	..	..	2.09 <sup>2</sup>	..	..	..
1816-1820	139.00	10.6	2.5	13.8	16.30	..	..	..
1831-1835	313.00	23.0	4.8	14.2	19.00	..	..	..
1851-1855	872.00	124.0	6.8	24.9	31.70	..	..	..
1876-1880	1456.00	180.0	12.4	56.1	68.30	..	2.29	2.29
1891-1895	1746.00	217.0	9.7	56.6	66.30	.42	2.78	3.20
1896-1900	1798.00	223.0	8.9	58.2	67.10	.26	4.27	4.53
1901-1905	1920.00	265.0	8.4	70.7	79.10	.22	5.10	5.32

efficiency and well-being, and (3) the substitution of cotton fabrics for woollen and linen fabrics. The rate of growth between the periods 1771-1781 and 1781-1791 (which is not shown in the above table) was particularly remarkable, and reached as high a figure (when measured by importations of weight of cotton) as 320%.

Nothing is more interesting in the cotton industry than the processes of differentiation and integration that have taken place from time to time. Weaving and spinning had been to a large extent united in the industry in its earliest form, in that both were frequently conducted beneath the same roof. With mechanical improvements in spinning, that branch of the industry became a separate business, and a substantial section of it was brought under the factory régime. Weaving continued to be performed in cottages or in hand-loom sheds where no spinning at all was attempted. Cartwright's invention carried weaving back to spinning, because both operations then needed power, and the trouble of marketing yarn was largely spared by the reunion. Mr W. R. Grey stated in 1833 to the committee of the House of Commons on manufactures, commerce and shipping, that he knew of no single person then building a spinning mill who was not attaching to it a power-loom factory. Some years later the weaving-shed split away from spinning, partly no doubt because of the economies of industrial specialism, partly because of commercial developments, to be described later, which rendered dissociation less hazardous than it had been, and partly because, in consequence of these developments, much manufacturing (as weaving is termed) was constituted a business strikingly dissimilar from spinning. The manufacturer runs more risks in laying by stocks than the spinner, because of the greater variety of his product and the more frequent changes that it undergoes. The former, therefore, must devote more time than the latter to keeping his order book and the productive power of his shed in close correspondence. The minute care of this kind that must be exercised in some classes of businesses explains why the small manufacturer still holds his own while the small spinner has been crushed out. It also explains to some extent the prevalence of joint-stock companies in spinning, and their comparative rarity in manufacturing. Here we should notice, perhaps, that the only combination of importance in the cotton industry proper (apart from calico-printing, bleaching, &c., and the manufacture of sewing-cotton) is the Fine Cotton Spinners and Doublers Association, founded in 1898, which is practically coextensive with fine spinning and doubling.

<sup>1</sup> Official values.

<sup>1</sup> Figures for the years above up to 1838 will be found in parliamentary reports (1840), xxiv. p. 611.

<sup>2</sup> This is the manuscript diary of a weaver of Oldham roughly covering the period 1787 to 1830. It is now in the Oldham public library. Mr S. Andrew edited extracts from it in a series of articles in the *Standard* (an Oldham paper), under the title *Annals of Oldham*, beginning January 1, 1887.

The specialism of the two main branches of the industry has been followed by the specialism of sub-branches and by the localization of specialized parts. Of the localization of certain sections of the cotton industry the late Mr Elijah Helm, who spoke with the authority of great local knowledge, has written as follows:—

"Spinning is largely concentrated in south Lancashire and in the adjoining borderland of north Cheshire. But even within this area there is further allocation. The finer and the very finest yarns are spun in the neighbourhood of Bolton, and in or near Manchester, much of this being used for the manufacture of sewing-thread; whilst other descriptions, employed almost entirely for weaving, are produced in Oldham and other towns. The weaving branches of the industry are chiefly conducted in the northern half of Lancashire—most of it in very large boroughs, as Blackburn, Burnley and Preston. Here, again, there is a differentiation. Preston and Chorley produce the finer and lighter fabrics; Blackburn, Darwen and Accrington, shirtings, dhooties and other goods extensively shipped to India; whilst Nelson and Colne make cloths woven from dyed yarn, and Bolton is distinguished for fine quiltings and fancy cotton dress goods. These demarcations are not absolutely observed, but they are sufficiently clear to give to each town in the area covered by the cotton industry a distinctive place in its general organization."<sup>1</sup>

The present local distribution of the cotton industry, as far as it is displayed statistically, is revealed in the table beneath, based upon the figures of spindles and looms given by Worrall and those of operatives in the census returns of 1901.

*Distribution of Cotton Operatives in Lancashire and the Vicinity according to the Census Returns of 1901, together with the Number of Spindles and Looms according to Worrall.*

	No. of Operatives.	No. of Spindles (in Thousands).	No. of Looms.
Blackburn . . . . .	41,400	1,325	75,300
Bolton . . . . .	29,800	5,035	20,100
Oldham . . . . .	29,500	11,603	18,500
Burnley . . . . .	27,900	687	79,300
Manchester and Salford . . . . .	27,200	2,666	24,200 <sup>2</sup>
Preston . . . . .	25,000	2,036	57,900
Rochdale . . . . .	14,800	2,168	25,100
Darwen . . . . .	12,500	336	28,700
Nelson . . . . .	12,400	23	39,000
Glossop <sup>3</sup> . . . . .	..	968	15,400
Bury . . . . .	10,700	818	22,200
Stockport . . . . .	9,700	1,803	8,700
Ashton-under-Lyne . . . . .	8,600	1,839	11,500
Accrington . . . . .	8,300	417	36,400
Colne . . . . .	7,300	140 <sup>4</sup>	20,500
Heywood . . . . .	7,300	869	6,400
Stalybridge . . . . .	7,100	1,106	7,100
Todmorden . . . . .	6,900	261	15,800
Rawtenstall . . . . .	6,600	356	8,800
Hyde . . . . .	6,500	553	7,900
Chadderton . . . . .	6,400	..	..
Haslingden . . . . .	6,100	148	12,000
Bacup . . . . .	5,900	315	9,300
Chorley . . . . .	5,900	547	17,900
Farnworth, near Bolton . . . . .	5,700	738	10,600
Leigh . . . . .	5,000	1,667	5,900
Great Harwood . . . . .	4,900	72	12,400
Middleton . . . . .	4,900	511	2,500
Radcliffe . . . . .	4,800	157	8,900

Local markets have steadily lost in importance, partly owing to railway development, and it is now almost entirely in Manchester, on the Exchange, that dealing in yarns and fabrics takes place, and arrangements are made for export. The old Manchester Exchange, built in 1729, was taken down in 1792. A new Exchange, reared on a contiguous site, was opened in 1809, the first stone having been laid in 1806. The present building was erected in 1869. The great bulk of the exports of cotton goods proceeds from Liverpool, though London used to be the leading port, and Liverpool is still the chief English market for raw cotton, though now from one-sixth to one-eighth of English cotton supplies come up the Manchester Ship Canal.

<sup>1</sup> Printed in *British Industries*. Edited by W. J. Ashley.

<sup>2</sup> Manchester only.

<sup>3</sup> The number of operatives in places in Derbyshire is not separately specified.

<sup>4</sup> Includes Foulridge with Colne.

To understand the present organization of the cotton industry the reader must begin by mentally separating the commercial from the industrial functions. By the industrial functions are meant the arrangements of factors in production—choosing the most suitable machinery and hands, combining them in the most economical system, adapting the material used to this system, and keeping its working at the highest attainable level. The commercial functions consist in business which is not industrial. Analysis will show that there are, broadly speaking, two classes of commercial functions, namely (1) arranging for purchases and sales, and (2) the bearing of risks. The character of the former is apparent: it consists, as regards yarn, in discovering for each manufacturer which spinner makes the yarn which is best adapted to his requirements at the lowest cost, and in finding the most suitable customers for spinners. Risk-bearing is a commercial function of another kind. Every business that involves anticipation involves commercial risks. Thus the spinner who sells "forward" yarn, trusting that the price of cotton will not rise, is taking commercial risks, and so is the spinner who produces for stock, trusting that the class of yarn that he is making will continue in demand. These two instances will suffice to indicate what is meant by the carrying of commercial risks. To make the rest of our argument clear it will be well to write down formulae. Let A and B represent respectively the industrial operations of spinning and manufacturing. Let  $a$  and  $\alpha$  represent respectively the commercial operations implied by the separate existence of A, that is, the buying of cotton and the selling of yarn; and let  $b$  and  $\beta$  stand for the commercial operations associated with manufacturing, that is, the buying of yarn on the one hand, and the finding of customers and arranging for their purchases on the other hand. Then, A and B being distinct businesses, it is obvious that a range of schemes is possible of which the extremes may be roughly represented as follows:—

1. (aAa), (bBb)
2. (a), (A), (ab), (B), ( $\beta$ ),

where the brackets signify independent businesses. In case 1 each spinning business would be engaged with three problems, namely, (i.) buying material at the most favourable time, (ii.) producing at the lowest cost, and (iii.) finding buyers and selling at the highest price, including the arranging for the performance of the most remunerative work. But in case 2 the spinner would confine his attention to purely industrial matters, while the problem of finding cotton and arranging for the bearing of the risks as to future prices would rest with other persons, and the business of bringing spinner and manufacturer together and taking such risks as may be involved in ordering or disposing of yarn would be the function of yet others. In case 2 the commercial functions may be said to have differentiated completely from the main body of the industry. We need hardly give illustrations of the intermediate arrangements that formally lie between cases 1 and 2. A may retain commercial risks but find customers through intermediaries; in such an event there would be only partial differentiation of the commercial functions. The reader must be reminded also that for the sake of simplicity in the formulae we have overlooked different classes of A and B, omitted bleaching, dyeing, printing and finishing, and drawn no distinction between the various classes of commercial work covered by one letter, for instance, selling in the home market and selling abroad.

It may help the reader to appreciate the organic growth of the cotton industry if we now run over the main lines of its evolution. Originally the industrial units were held together in one homogeneous commercial setting. The Manchester merchants bought cotton and warps, put them out to the weavers, and arranged for the finishing of the cloth and then for its sale, so far as they had not been acting on orders already received. There were variations of this system—for instance, in early years weavers sometimes bought their own yarns and cotton and sold their cloth—but just before the industrial revolution the arrangement sketched above was the most usual. Adverting to our formula, the Manchester merchants, we observe, performed functions

Modern  
organiza-  
tion.

a (in conjunction with importers), b (as regarded warps), and  $\beta$ . Weft the weaver had to get spun by his family or outsiders. So, broadly speaking, there was one single commercial setting. After the appearance of the factory, the commercial work as between the water-twist mills, the mule-spinning businesses and the manufacturers, so far as the businesses were distinct, appears to have been done by the several producing firms concerned. It was not at once that (ab) began to differentiate.  $\beta$  was already a separate business in the hands of Manchester merchants and the foreign houses who had established themselves in Manchester to direct the export trade. At the present time an advanced stage of commercial specialism has been reached. From the risks connected with the buying of cotton the spinner may if he please escape entirely.<sup>1</sup> Selling work is now done usually through intermediaries, but there is no one uniform rule as to the carrying of the commercial risks involved. This appears to be now to some extent a matter of arrangement between the persons concerned, but ultimately no doubt the risks will have to be borne by those most qualified by experience to bear them, namely, the commercial specialists. In no other trade in England, and in no other cotton industry abroad, has commercial specialism been carried so far as in the cotton trade of Lancashire. It is partly in consequence of the difference in this respect between the cotton industry in Lancashire and abroad that the separation of spinning from weaving is far more common in England than elsewhere. Elsewhere producers are deterred from specializing processes further in distinct businesses by the fear of the worries of buying and selling as between them.

The explanation of differences in respect of the degree of commercial specialism in different places and industries can be formulated only very generally. Time is required for the differentiation and localization to take place. The English cotton trade had not advanced very far in the "thirties," if we are to judge from the evidence given to commissions and parliamentary committees. The general conditions under which commercial specialism evolves may be taken to be a moderately limited range of products which do not present many varieties, and the qualities of which can be judged generally on inspection. In such circumstances private markets need not be built up, as they must be, for instance, for a new brand of soap which claims some subtle superiority to all others. Soaps under present conditions must be marketed by their producers. Broadly stated, if there be little competition as to substitutes, though there may be much as to price in relation to quality, commercial functions may specialize. On the whole this is the case in the cotton industry; in so far as it is not and firms

produce specialities, they undertake much of the marketing work themselves.

The advantages of commercial specialism are numerous. Firstly it allows of differentiation of industrial processes, and this, of necessity, is accompanied by increasing returns. When weaving dissociates from spinning, both the number of looms in each business and the number of spindles in each business tend to increase; more division of labour is therefore secured, and lower costs of production are reached, and there is a further gain because producers concentrate their attention upon a smaller range of work. Again when producers are freed entirely, or to some extent, from commercial worries, they can attain a higher level of efficiency at the industrial task of mill organization, and a more perfect accommodation of capacity to function will be brought about. If the business unit is (aAa), a particular person may retain his place in the market by reason of his excellence at the work a or a, though as works organizer (*i.e.* at the performances of function A) he may be incompetent. The heads of businesses will succeed according to their average capacities at the three tasks a, A and a, and there is no guarantee, therefore, that any one of these tasks will be performed with the highest attainable efficiency in our present somewhat immobile economic system. But if the three functions are separated there is more certainty of a person's success in the performance of each determining his continued discharge of it. The problems that arise when specialized markets become very highly developed are dealt with in the article COTTON: *Marketing and Supply*.

The distribution of cotton operatives among the chief centres has already been shown, but their distribution between processes has yet to be considered, and the proportions of different ages and sexes from time to time, together with the total. With such statistical material as is available relating to supplies of labour we may set forth also the official returns made of the quantity of machinery at work from time to time. It hardly need be pointed out that the ratio of machinery to operatives roughly measures the efficiency of labour, other things being equal.

*Operatives in various processes.*

*Machinery in the United Kingdom (in Thousands).*

Years.	Spinning Spindles.	Doubling Spindles.	Power-Looms.
1874	37,516	4366	463
1878	39,528	4679	515
1885	40,120	4228	561
1890	40,512	3993	616
1903	43,905	3952	684

*Operatives employed in the Cotton Industry (in Thousands). (From the Census Returns.²)*  
(The figures in italics relate to Married and Widowed Women.)

	1901.				1891.				1881.			
	Lancashire.		England and Wales.		Lancashire.		England and Wales.		Lancashire.		England and Wales.	
	M.	F.	M.	F.	M.	F.	M.	F.	M.	F.	M.	F.
Cotton, card and blowing-room processes	11.4	28.7	13.8	34.0	..	..	..	..	..	..	..	..
Cotton spinning processes	49.5	19.6	64.1	28.6	..	..	..	..	..	..	..	..
Cotton winding, warping, &c.	14.8	4.3	18.3	6.0	..	..	..	..	..	..	..	..
Cotton weaving, warping, &c.	57.6	13.0	66.1	15.8	..	..	..	..	..	..	..	..
Total	133.3	265.9	162.3	320.7	178.2	281.8	213.2	332.8	150.7	249.8	185.4	302.4
Cotton workers in other processes or undefined	29.0	6.7	34.5	9.4	..	..	..	..	..	..	..	..
Tape, manufacturer dealer	..	1.8	..	2.3	..	..	..	..	..	..	..	..
Thread, manufacturer dealer	..	..	..	..	.47	.25	.9	1.5	.4	.24	.7	1.2
Fustian, manufacturer dealer	..	..	..	..	.2	.9	.6	2.1	.1	.9	.5	1.7
Cotton, calico, warehouseman, dealer	.6	1.2	2.1	2.6	1.1	2.9	3.2	5.0	1.7	3.5	3.0	5.2
	..	.55	..	1.0	..	..	..	..	2.5	.3	3.2	.38

<sup>1</sup> This is explained in the article COTTON: *Marketing and Supply*.  
<sup>2</sup> Census classifications have been altered twice in the period covered by this table.



# COTTON MANUFACTURE

In Scotland there are less than 15,000 cotton operatives distributed as follows:—

	In Thousands.
Card and blowing-room processes . . . . .	4
Spinning-room processes . . . . .	2.1
Winding, warping, &c. . . . .	2.7
Weaving, warping, &c. . . . .	6.8
Workers in other processes or undefined . . . . .	2.8
<b>Total</b> . . . . .	<b>14.8</b>

the proportion of children employed and the steady increase in the number of operatives as a whole until recent years. The contraction of the body of operatives of late years seems to have occurred primarily among children and young persons (where the first check would naturally be looked for), and secondarily among adult males. If allowance be made for the smaller value of children as compared with adults, and the census results be taken, it is not evident that there has been any diminution in the amount of labour-power; and if the factory inspectors' returns be accepted, the falling off in the number of operatives cannot be proved to have taken place

*Operatives employed in Cotton Factories in the United Kingdom and Percentages of each Class. (From Returns of Factory Inspectors.)*

	1835.	1838.	1847.	1850.	1856.	1862.	1867.
Male and Female under 13, or half-timers . . . . .	13.2	45.7	5.8	4.6	6.5	8.8	10.4
Male, 13 to 18 . . . . .	12.5	16.6	11.8	11.2	10.3	9.1	8.6
Male, over 18 . . . . .	26.4	24.9	27.1	28.7	27.4	26.4	26.0
Female, over 13 . . . . .	47.9	53.8	55.3	55.5	55.8	55.7	55.0
<b>Total number of Cotton Operatives</b> . . . . .	<b>218,000</b>	<b>259,500</b>	<b>316,400</b>	<b>331,000</b>	<b>379,300</b>	<b>451,600</b>	<b>401,100</b>
	1870.	1874.	1878.	1885.	1890.	1895.	1901.
Male and Female under 13, or half-timers . . . . .	9.6	14.0	12.8	9.9	9.1	5.8	4.1
Male, 13 to 18 . . . . .	8.5	8.0	7.2	7.9	8.2	7.9	7.0
Male, over 18 . . . . .	26.0	24.1	25.3	26.4	26.9	27.6	27.8
Female, over 13 . . . . .	55.9	53.9	54.7	55.8	55.8	58.7	61.1
<b>Total number of Cotton Operatives</b> . . . . .	<b>450,100</b>	<b>479,600</b>	<b>483,000</b>	<b>504,100</b>	<b>528,800</b>	<b>538,900</b>	<b>513,000</b>

*Number of Operatives (in Thousands) engaged in Spinning, Manufacturing and Subsidiary Processes (excluding Lace-making, but including the Fustian Manufacture). (From Census Returns.)*

	Males.				Females.				Males and Females.			
	Under 15.	15-20.	Over 20.	All Ages.	Under 15.	15-20.	Over 20.	All Ages.	Under 15.	15-20.	Over 20.	All Ages.
1881	29	39	121	189	40	81	189	310	69	120	310	500
1891	36	45	137	218	50	94	197	341	86	139	334	560
1901	24	36	139	199	36	92	207	335	60	128	346	535

The fact that the branches of work covered by the figures are not identical explains discrepancies between this and the previous table.

are given below, together with averages for cotton and wool workers, the building trades, mining, workers in iron, sailors, compositors and agriculturists (England), the numbers in each class being allowed for in the average. Side by side with these figures, Sauerbeck's index numbers of general wholesale prices are given, together with the average prices of wheat per quarter. It must be remembered that the figures given above for cotton workers and average wages for eight trades do not measure the differences between each, but only the differences between the movements of each. Actual average money wages in the cotton industry have probably been approximately those stated in the second table beneath, but as these figures are culled from various sources they must not be taken to indicate fluctuations.<sup>2</sup>

*Number of Operatives engaged in the Cotton Industry (Processes being distinguished and Ages and Sex). (From Special Returns made by Factory Inspectors.)*

	Males in Thousands.			Females in Thousands.			Total in Thousands.
	Half-timers.	Under 18.	18 and over.	Half-timers.	Under 18.	18 and over.	
Spinning and Preparatory Processes							
1896	5.58	22.24	71.44	4.40	30.12	78.69	212
1898-1899 <sup>1</sup>	5.42	21.57	71.37	3.86	30.44	77.64	210
1901	4.98	21.10	68.98	3.10	30.98	81.68	211
Weaving and Preparatory Processes							
1896	7.54	18.79	75.81	11.87	49.19	151.34	315
1898-1899 <sup>1</sup>	6.21	17.29	72.74	10.38	48.38	150.99	306
1901	4.72	14.86	73.81	8.0	45.66	155.03	302

The figures in this table are not quite complete except for 1901; the relations between the changes shown for each class should nevertheless be accurately represented.

The most noticeable features of these tables are the decrease in

The wage of fine spinners exceeds the average wage of spinners

*Index Numbers of Money, Wages and Prices.*

	1840.	1855.	1860.	1866.	1870.	1874.	1877.	1880.	1883.	1886.	1891.	1902.
Cotton operatives	50	54	64	74	74	90	90	85	90	93	100	105
Average wages for eight trades	61	61	73	81	83	97	94	89	92	90	100	108.7 <sup>2</sup>
Sauerbeck's index number	103	73	99	102	96	102	94	88	82	69	72	69
Average price of wheat per quarter	66/4	40/3	53/3	49/11	46/11	55/9	56/9	44/4	41/7	31/-	37/-	28/1

*Weekly Wages in the Manchester and District Cotton Trade.*

	1834.	1836.	1839.	1841.	1849.	1850.	1859.	1860.	1870.	1877.	1882.	1883.	1886.
	s. d.	s. d.	s. d.	s. d.	s. d.	s. d.	s. d.	s. d.	s. d.	s. d.	s. d.	s. d.	s. d.
Spinners' average	23 4	23 11	22 11	22 0	21 7	20 5	24 1	23 2	27 8	34 4	31 6	32 4	35 7
Big piecers' average	11 0	9 3	8 0	8 8	8 6	13 0	10 0	10 0	11 0	12 4	16 0	16 0	13 7
Weavers' average	11 0	10 2	9 6	9 6	10 6	10 3	11 2	10 8	12 2	15 1	15 6	15 0	13 3

<sup>1</sup> Average for 1898 and 1899.

<sup>2</sup> See chapter on cotton in Bowley's *Wages in the United Kingdom* and table there given.

<sup>3</sup> Average for a slightly different group.

by percentages varying from about 25 to 35. In the above figures the earnings of three classes of spinners are averaged.

The highest wages are earned by mule-spinners (who are all males); their assistants, known as piecers, are badly paid. Persons can easily be found, however, to work as piecers, because they hope ultimately to become "minders," *i.e.* mule-spinners in charge of mules. The division of the total wage paid on a pair of mules between the minder and the piecers is largely the result of the policy of the spinners' trade union. Almost without exception in Lancashire one minder takes charge of a pair of mules with two or three assistants according to the amount of work to be done. Among the weavers there is no rule as to the number of assistants to full weavers (who are both male and female), or as to the number of looms managed by a weaver, but the proportion of assistants is much less than in the spinning branches, perhaps because of the inferior strength of the weavers' unions. For the calculation of wages piece-rate lists are universally employed as regards the payment of full weavers and spinners; some piecers get a definite share of the total wage thus assigned to a pair of mules, while others are paid a fixed weekly amount. Many ring-spinners are now paid also by piece-rate lists, and all other operatives are almost universally so paid, except, as a rule, the hands in the blowing-room and on the carding-machines. Spinning and weaving lists are most complicated; allowances are made in them for most incidents beyond the operatives' control, by which the amount of the wage might be affected. Still, however, they could not cover all circumstances, and much is left to the manner of their application and private arrangement. They should be regarded as giving the basis, rather than as actually settling, the wage in all cases. The history of lists stretches back to the first quarter of the 19th century as regards spinners, and to about the middle of the century generally as regards weavers, though a weaving list agreed to by eleven masters was drawn up as early as 1834. There are still many different district lists in use, but the favourite spinning lists are those of Oldham and Bolton, and the weaving list most generally employed is that known as the "Uniform List," which is a compromise between the lists of Blackburn, Preston and Burnley. Under the "Particulars Clause," first included in a Factory Act in 1891 and given extended application in 1895, the particulars required for the calculation of wages must be rendered by the employer. As in spinning there used to be doubts about the quantity of work done, the "indicator," which measures the length of yarn spun, is coming into general use under pressure from the operatives. We ought to observe here that the Oldham spinning list differs from all others in that its basis is an agreed normal time-wage for different kinds of work on which piece-rates are reckoned. But in effect understandings as to the level of normal time-wages are the real basis everywhere. If the average wages in a particular mill are lower than elsewhere for reasons not connected with the quality of labour (*e.g.* because of antiquated machinery or the low quality of the cotton used), the men demand "allowances" to raise their wages to the normal level. Advances and reductions are made on the lists, and under the Brooklands Agreement, entered into by masters and men in the cotton spinning industry in 1893, advances and reductions in future must not exceed 5% or succeed one another by a shorter period than twelve months. The changes as a rule now are 5% or 2½%. In all branches of the cotton industry it is usual for a conference to take place between the interested parties before a strike breaks out, on the demand of one or other for an advance or reduction.

Organization among the workers in the cotton industry is remarkably thorough. Almost all spinners are members of trade unions, and though the weavers are not so strongly united, the bulk of them are organized. The piecers are admitted as members of piecers' associations, connected with the spinners' associations and controlled by them. Attempts to form independent piecers' unions have failed. Weavers' assistants are included in the weavers' unions, which may be joined in different classes, the benefits connected with which vary with the amounts paid. One subscription only, however, is imposed by each branch spinners' association, but in all branches it is not the same, though every branch pays the same per member to the amalgamation. All the trade unions of the chief workers in the cotton industry are federated in the four societies: (1) the Amalgamated Association of Operative Cotton Spinners (created in 1853 and reformed in 1870), (2) the Northern Counties Amalgamated Association of Weavers (founded 1884), (3) the Amalgamated Association of Card and Blowing-room Operatives (established 1886), and (4) the Amalgamated Association of Power-loom Overlookers (founded 1884). These were not, however, the first attempts at federation, and the term "federation" must not be taken in any strict sense. The distribution of power between the central authority and the local societies varies, but in some cases, for instance among the spinners, the local societies approximate as closely to the status of mere branches, as to that of independent units federated for limited objects. We ought also to mention the societies of warp-dressers and warpers, tape-sizers and cloth-workers and warehousemen. There is no one federation of all cotton-workers, but the United Textile Factory Workers has been periodically called into being to press the matter of factory legislation, and international textile congresses are occasionally held by the operatives of different countries.

As to employers, four extensive associations include almost all the organization among them, two concerned chiefly with spinning and two with weaving. The former two are the Federation of Master Cotton Spinners' Associations with local associations and including 21,000,000 spindles, and the Bolton Master Cotton Spinners' Association with 7,000,000 spindles; the latter two are the North and North-East Lancashire Spinners' and Manufacturers' Association, covering about 3,000,000 spindles in addition to a large section of the looms of Lancashire, and the United Cotton Manufacturers' Association.<sup>1</sup>

Factory legislation began in the cotton industry, and in no industry is it now more developed. The first acts were those of 1802 and 1819, both of which applied only to cotton-mills, and the former of which related only to parish apprentices. The first really important measure was that of 1833, which curtailed the abuse of child-labour, enforced some education and provided for factory inspectors, of whom there were at first only four. The next act of importance, that of 1844, was chiefly remarkable for its inclusion of all women among young persons. The proportion of women, young persons and children engaged in the cotton industry is so high, that most regulations affecting them, *e.g.* those relating to the hours of labour, must practically be extended to all cotton operatives. This act killed night work for "young persons," and children were not allowed to work at night. The year 1847 saw the introduction of what was known as the Ten Hours Act —after the 1st of May 1848 the hours of young persons (women included) and children were not to exceed ten a day and fifty-eight a week. A further limitation of hours to 5½ a week was secured in 1874, and this was cut down by another hour (the concession of the 12 o'clock Saturday) in 1901. "Young persons" now includes all who are not half-timers and have not attained the age of eighteen, and all women. The rules as regards the employment of children, which have steadily improved, are at present as follows. No child under twelve may be employed. On attaining the age of thirteen the child may become a full-timer if he has obtained the prescribed educational certificate (*i.e.* fifth standard attainment or three hundred attendances each year for five consecutive years). Failing this he must wait till he is fourteen before he can be employed full time. Half-timers may be employed either (a) on alternate days, which must not be the same days in two successive weeks, or (b) in morning and afternoon sets. In the case of arrangement (a), the child when at work may be employed during the same period as a young person or woman, which in Lancashire is almost universally from 6 to 6 with two hours for meals.<sup>2</sup> In the case of arrangement (b), which is the system generally adopted in Lancashire, a half-timer in the morning set works from 6 to 12.30, with half an hour for breakfast, and in the afternoon from 1.30 to 6, except on Saturdays, when the hours are from 6 till 11.30 for a manufacturing operative, or till 12 for other work, for instance, cleaning. The child must not work two consecutive weeks in the same set (that is, in mornings or afternoons), nor on two successive Saturdays, nor on Saturday at all if during any other day of the same week the period of employment has exceeded 5½ hours (*i.e.* a child in the morning set does not work on the Saturday). Other important features of factory legislation relate to the fencing of dangerous machinery and its cleaning when in motion (the regulations being strictest in the case of children and most lax in the case of male adults), and conditions of health, including the amount of steaming allowed, which was first regulated by the Cotton Cloth Factories Act of 1889.

#### *The Cotton Industry outside England.*

A brief survey will now be made of the cotton industry in parts of the globe other than the British Isles, and as a prelude to the following broad estimates of the numbers of spindles and looms in the chief national seats of the cotton industry may be put forward.<sup>3</sup> The table is further supplemented by other figures<sup>4</sup> for the number of spindles at different times in the United Kingdom, the United States and the continent; and finally we may add the figures of cotton consumed.

The different average fineness of counts spun in different places must be borne in mind when the consumption of each district at the same time is being considered, but the relations between the amounts consumed in the contrasted districts in the two periods would not be affected much by this difference.

<sup>1</sup> A detailed analysis of the whole labour question in the cotton industry will be found in Chapman's *Lancashire Cotton Industry*.

<sup>2</sup> There are other permissible arrangements, namely from 7 to 7 and from 8 to 8, but they are not used in the textile trades of Lancashire.

<sup>3</sup> The figures for looms are based upon a number of returns and estimates. Those for spindles are taken from the highly authoritative estimates of the International Federation of Master Cotton Spinners.

<sup>4</sup> *Journal of Board of Trade*, April 28th, 1904.

## COTTON MANUFACTURE

	Estimated Population in 1902. In Millions.	Million Spinning Spindles in 1909.	Thousand Power-Looms about 1906.
United Kingdom . . . . .	42	53.5	700
United States . . . . .	79	27.8	550
Germany . . . . .	58	9.8	215
France . . . . .	39	6.8	110
Russia . . . . .	139	7.8	150
India . . . . .	294 (1901)	5.8	45
Austria . . . . .	26.7	4.2	80
Spain . . . . .	18.6 (1900)	1.9	69
Italy . . . . .	33	4.0	100
Switzerland . . . . .	3.4	1.5	30
Japan . . . . .	46	1.7	..
Belgium . . . . .	..	1.2	..

Cotton Spindles (including Doubling Spindles) in Millions.

	United Kingdom.	Europe.	United States.	Other Countries.	Total.
1870	37.7	13	7.1	..	57.8
1880	44.5	21	10.6	2	78.1
1890	44.5	26	14.2	4	88.7
1900	46.2	32	19	7	104.2
1903	47.9	33	22.2	7.5	110.6

Average Annual Consumption of Cotton in the Period 1831-1835.

	Millions of lb.
United Kingdom . . . . .	295
Continent of Europe . . . . .	143
United States . . . . .	79

Average Annual Consumption of Cotton in the Period 1900-1905.

	Millions of lb.
United Kingdom . . . . .	1634
Continent of Europe . . . . .	2486
United States . . . . .	1995

Roughly the consumption of cotton per spindle in the three areas to-day is, in lb, 35 for the United Kingdom, 70 for the continent, and 95 for the United States.

Before the cotton industry in other countries is described it will be necessary to explain how it could have developed there on a large scale at all. Of course this growth is to be accounted for very largely by the natural protection of cost of transport aided by tariffs. But it would be a mistake for Englishmen to imagine that all foreign cotton mills are the product of a forcing culture, and that if the favourable conditions created by import duties were removed they would totally disappear. No doubt some of the growth is artificial, but much is natural and would have taken place under universal free trade conditions. Much of it, indeed, would have appeared in these circumstances even were cost of production a negligible quantity, difficult though it may be at first to reconcile this statement with certain ordinary conceptions of the operations of the law of increasing returns. Lancashire secured an immense lead at the beginning of the 19th century, and if the cost of production may be represented as varying inversely as the magnitude of the industry, every addition to her success increased her advantages. How could the small industry, with a high cost of production because it was small, compete with Lancashire? The answer is to be found in the peculiar conditions governing international trade and a closer analysis of "increasing returns." "Increasing returns" in any place are a function of two variables, (1) the magnitude of the world market under conditions of world commerce, and (2) the magnitude of the industry in the spot in question. The economies connected with the first variable, which in such an industry as the cotton industry are enormous, and govern ultimately the limits of business specialism, are shared by every national section of the industry whether it be great or small. If Haiti started a cotton factory she might import all her specialized machinery—the specialism involved in producing which is dependent upon the exportation of some of it—and restrict narrowly the work undertaken by her one factory. The cotton goods outside this range she would still import, and if her specialized product were in excess of local demand she could export some of it, if she were favourably placed in respect of cost of carriage, for cost of production in

Haiti would not be impossibly high, since machinery and the general system of production would be quite up to date though labour might be highly inefficient. Of course, the country with a large industry enjoys high local economies, and it might be thought that these alone would be a menace to the stability of the small industry, because if the industry in the favoured locality increased these would increase also and the small industry would be undersold. The answer to this difficulty is that foreign trade depends upon ratios between ratios, that is, upon the ratios between the costs of production of all the products of each country in relation to similar ratios for other countries. Relatively, therefore, diminishing returns operate in every country. In every country there must come a time, the utility of commodities being taken into account, when a unit of labour and capital provides less utility when applied to the creation of cotton goods, say, than when applied to producing something else for home consumption or for export in exchange for commodities wanted at home. It becomes apparent, therefore, that cotton industries of widely varying sizes dispersed throughout the world can settle into relations of perfectly stable equilibrium, as that term is understood by the economist. Slow changes, of course, in their relative volumes might be looked for with changes in a mutable world, but very sudden collapses would be impossible unless the general course of human affairs were revolutionized.

*The United States.*—The machine-cotton industry was carried to North America almost as soon as it evolved in England. Models of Arkwright's machines were smuggled across the Atlantic in 1786—Arkwright's first mill had not been started in England until 1769—and these with a jenny and stock-card were publicly exhibited. From these models a great mass of machinery was soon constructed. The first mill was erected in 1788 (that of the Beverly Association), the second appeared in 1790, the third five years later, and in 1798 Samuel Slater started with some of his wife's relatives the first mill in which the principle of the water-frame was carried throughout. It is said that it was not until 1814 that power-loom manufacturing was commenced, but in England success with the power-loom was long delayed. As early as 1831, however, there were in the United States—mainly in the New England states—800 factories, a million and a quarter spindles, 33,500 looms and 62,200 operatives. At this time the annual consumption of cotton was about 77,000,000 lb as compared with some 300,000,000 lb in England at the same date, and 2,000,000,000 approximately in the United States at the present time.<sup>1</sup> Writing in 1840, James Montgomery said that, in respect of cost of production, the American industry was 19% behind that of England apart from the cost of raw material, which was then a good deal less to the Americans. In 1878, when there was much interest in the question of British efficiency in the cotton industry because the passage of the Factory Act of 1874 had cut down the working hours, the *Economist* contrasted the result of twenty-five years' growth in England and America:—

"In 1853 the average English production per weaver of 8½ lb shirting was 825 yds. per week of sixty hours. In 1878 the working hours had fallen to fifty-seven, and the production had risen to 975 yds. An increased production of 23% is thus due to improvement in the processes of manufacture. In 1865 there were 24,151 persons employed in Massachusetts in the production of cotton goods, and they produced 175,000,000 yds. In 1875 the operatives numbered 60,176, and their product was 874,000,000 yds. The operatives had increased 150% and their products had increased 500%. The increase of production due to improved methods was thus in England 23%, and in Massachusetts 100%. I do not, of course, suppose that the American manufacturer is in advance of his English rival to the extent of this difference, for I presume that he started upon the career of improvement from a lower platform. But a progress so greatly more rapid than ours will be admitted to cast much light on the change which has occurred in our relative positions."

The contrast no doubt was not perfect, as indeed it could not be

<sup>1</sup>The early history of the industry in the United States is summarized in one of the official bulletins of the state of Massachusetts, dated 1798. See W. R. Bagnall, *Textile Industries of the U. S.* (1893).

in view of the varieties of product and their changes, but it proves at any rate that Americans were making vast strides in industrial efficiency even before the period when American methods and American enterprise were monopolizing in a wonderful degree the attention of the business world.<sup>1</sup> About a dozen years later the low real cost of production of simple fabrics in the United States was universally admitted, and also that American manufacturers were making more use of machinery than their European rivals. In a typical weaving shed in Massachusetts, for instance, of which particulars were published, twenty women "tended" as many as eight looms apiece, forty-three managed seven, two hundred and thirty-two managed six, and only eleven had five only.<sup>2</sup> Since then, moreover, advance has been rapid, and the sudden development of the South has astonished the business community of other centres of the cotton industry.

Before the lines of development in America are specifically dealt with, and particularly the industrial phenomena in the South, a few words must be said of the general extension of the industry. The consumption of cotton in the United States in million lb was about 75 in 1830, 390 in 1860, 1100 in 1890 and nearly 2000 on an average of the five crop years from 1900-1901 to 1904-1905: active spindles advanced from 1,250,000 in 1830 to 10,653,000 in 1880 and about 21,250,000 in 1905. Looms which numbered 33,500 in 1830 had reached 226,000 in 1880 and nearly 550,000 in 1905. At the same time population, it must be remembered, was growing at a phenomenal rate: from 31.4 millions in 1860 it had passed to 38.6, 50.2, 62.6 and 76.3 at the succeeding decennial censuses, the decennial rates of increase being in order 22.5, 30, 25 and 20.5 as compared with 8.5, 10.5, 8 and 9 as shown by the corresponding censuses in the United Kingdom. Protection was of course contributory to the growth of the American cotton industry. It may be remarked incidentally that the New World, including the West Indies and the Chinese empire, take the bulk of American exports, which for so large an industry are inconsiderable. The imports have always been well in excess of the exports. The encouragement of home industries by tariffs was definitely aimed at after the war with England during the Napoleonic struggles, and although a sensible reduction of duties was experienced after 1845 the reaction to protection that followed the Civil War was never significantly departed from except by the single act of 1883. In 1790 the duties on cotton goods were 7½% *ad valorem*, and they rose gradually until they reached 25% in 1816. Slight reductions some seventeen years later were followed in the early 'forties by a tariff of 30%. Diminutions were succeeded by oscillations, though at no point was a low level touched. Severe charges were imposed in 1890, and after some relaxation in 1894 the policy of restrictiveness was restored in 1897. According to the calculations made by the English Board of Trade in 1903<sup>3</sup> no fabrics were admitted at a charge equivalent to less than 68% *ad valorem*, and no yarns were admitted at a charge lower than 45% *ad valorem*. Cotton thread is subjected to a rate equivalent to 375%.<sup>4</sup>

The character of the growth of the cotton industry in the United States, as revealed by recent census returns, is peculiarly interesting:—

Cotton small wares are included in the totals for 1880 and 1890, but excluded from those for 1900 and 1905. We must observe further that "capital" is a vague term. Recent events in the United States afford a valuable empirical indication of the effect that improved machinery actually has upon wages. The new automatic looms caused a saving of labour per unit of product which recalled the complete subversion at the industrial revolution of the proportions in which the several factors in production were organized. Displacement of labour and falling wages might not unreasonably have been looked for temporarily, but wages stuck at their old level or rose. The rise was caused by numerous converging forces which brought their united weight to bear. First, prices so fell as the result of the new machinery that the increased volume of commodities which the market could absorb more than counterbalanced, it would seem, the labour-saving of the new machinery, the cotton industry being taken as a whole. It must be remembered that to increase the output from the subsidiary processes where labour had not been saved more hands had to be drafted in. Thus, a contraction of the body of weavers was accompanied by an expansion of the body of cotton operatives. Again weavers' wages were naturally raised in a special degree because automatic machinery called for quick, trustworthy and intelligent hands, endowed with versatility, especially in the days when the machinery was still in the semi-experimental stage. The American employer tries to save in labour but not to save in wages, if a generalization may be ventured. The good workman gets high pay, but he is kept at tasks requiring his powers and is not suffered to waste his time doing the work of unskilled and boy labour. There is, certainly, in the American labour problem no serious grievance on the question of wages. If there is any abuse it consists in excessively fierce work. Mr. T. M. Young, who visited the American cotton districts in 1904 with an informal commission of Lancashire spinners and manufacturers, did not think that the cause of the high wages—allowance being made for the purchasing power of money, they are above those of England, though cotton operatives in England are well paid relatively—was the superiority of the American cotton worker; neither did the representatives of the English cotton operatives who accompanied the Moseley Commission. As often as not "the cotton operative in the United States is a French Canadian, a German, an Italian, a Hungarian, an Albanian, a Portuguese, a Russian, a Greek, or an Armenian." It is the extensive "exploitation" of machinery seemingly, together with the speed of work, which keep wages high, combined with the horizontal and vertical mobility of American labour, which prevents it from accumulating in pools, and causes streams of the best hands to be flowing continuously to other callings and places, and no insignificant proportion to climb the social ladder. The remainder naturally profit, for a local or trade congestion of labour is avoided, and the voluminous recruiting of enterprise by the intensified competition among employers keeps the demand for labour high.

One noticeable point in the table quoted above is that until recently cotton consumed increased much faster than the number of spindles. This might be explained in a variety of ways. Average counts remaining constant, the average speed of the

	Thousands.				Percentage Increases.		
	1880.	1890.	1900.	1905.	1880-1890.	1890-1900.	1900-1905.
Active Spindles	10,653	14,188	19,008	23,156	33.8	34	21.8
Looms	226	325	451	541	43.90	38.7	20
lb cotton consumed	750,344	1,117,946	1,814,003	1,873,075	48.99	62.3	3.3
Wages	\$42,041	\$66,025	\$85,126	\$94,378	57	28.9	10.9
Capital	\$208,280	\$354,021	\$460,843	\$605,100	70	30.2	31.3
Employees not officers and clerks	174.7	218.9	297.9	310.5	25.3	36.1	4.2

<sup>1</sup> See also the official report of J. P. Harris-Gastrell in 1873.

<sup>2</sup> Quoted by Schulze-Gaevernitz.

<sup>3</sup> Memorandum on British and foreign trade and industrial conditions.

<sup>4</sup> The method of calculating these percentages is discussed in the blue-book mentioned.

spindle might have risen; or the latter remaining constant, counts might have been getting finer. Speeds have certainly gone up a good deal of late on some counts. And it is quite likely, too, that concentration on the manufacture of coarse goods for export, with stout warps to keep down the

breakages and raise the output per loom, may be reckoned as one cause.

Despite the recent sensational growth in the South, the New England States still remain the most prominent seat of the American cotton industry. They contained in 1905 about 14 million spindles as compared with 7.7 millions in the South and West, and their relative possession of looms approaches, though it does not quite reach, the same proportion. The leading States in the South in order of importance are South Carolina, North Carolina, Georgia and Alabama, and in the North, first Massachusetts with an enormous lead, then, in order, Rhode Island, New Hampshire, Connecticut, Maine, New York, Pennsylvania, New Jersey. The bulk of the cotton industry in the North is contained within a small area. A circle around Providence, Rhode Island, of 30 m. radius includes, according to the twelfth census, nearly  $7\frac{1}{2}$  million spindles,—there were only 58,500 spindles in this area in 1809. Of the chief towns Fall River stood first in 1900 in value output, and was followed in order by Philadelphia, New Bedford, Lowell, Manchester and Pawtucket. The climate of Fall River is very similar to that of English spinning districts. Its population in 1900 was 105,000, and of these only 14,600 were of American parentage. Of the remainder, 16,700 were English, 17,800 Irish, 20,600 French Canadians and about 5000 Portuguese. Among the rest of foreign parentage, Armenians, Russians and Italians are numerous. But Massachusetts is famous for the number of immigrants it attracts. It is almost incredible, but nevertheless a fact according to a recent statistical report, that in 1903 as many as 91% of the cotton operatives of the State were of foreign descent—chiefly French Canadian and Irish. In 1902 there were nearly 90 mills at Fall River with 3,000,000 spindles and 16,000 looms. The spindles amount to about one-third of all in Massachusetts, but Fall River's share of the looms of the State is not large. The spindles exceed in number those possessed by any State except of course the one in which it is placed. In comparison with a great spinning town in England, nevertheless, Fall River does not appeal strongly to the English imagination. It has little over a quarter of the spindles of Oldham, or three-fifths of those of Bolton,—among English towns it would stand third, *i.e.* between Bolton and Manchester and Salford, which, in spite of the movement of spinning to the hills, still holds in England a leading place. The whole of Massachusetts, it is of interest to observe, has fewer spindles than Oldham, and only about half those of Oldham and Bolton together. Originally it was the river which attracted the mills to Fall River, and as the water-power available was almost inexhaustible, it was possible for the mills to congregate together and for a town to grow up. In England, when much of the industry was dependent for power upon water, decentralization was entailed, for the thin streams of Lancashire could not support more than two or three mills at most in proximity. Hence in England, after Watt's steam-engine had succeeded, the economies of centralization led eventually to the desertion of the mills on the water-courses. But at Fall River the perfecting of the application of steam-power merely involved its use to supplement the water-power on the old site. The presence of water-power explains half the success of New England. In the six States 35% of all the power used is derived from water, and in the cotton-manufacturing of these States water provides 32.6% of the power. For industrial purposes generally the river most exploited is the Merrimac, upon which stand the leading cotton towns of Lowell, Lawrence and Manchester. Hitherto little has been done in the way of using water to generate electric power.<sup>1</sup>

The two most striking features of the American industry to-day are the introduction of the automatic looms, already briefly referred to, and the development of the South. The Northrop Loom Company has spent a fortune in pushing its loom on to the market. It has not hesitated to share risks, and it has run one "advertisement" mill at least, namely that at Burlington, Vermont, with 55,000 spindles and nearly 1300 looms. In this mill the labour-saving is shown by the following

<sup>1</sup> Upon the above see Uttley's report.

figures, the looms being of two sizes, 32 in. and 44 in. Of the former, 3 weavers run 18 each, 39 tend 16 each, only a few odd weavers tend less than 16, and learners even are at work on 8 to 11 each; on the latter, of 29 weavers 17 mind 16 looms each and 12 mind 12 (on stripped fabrics).<sup>2</sup> Of course a high level of efficiency would be expected in this show mill. That American employers have readily been converted to a belief in the economy of the new machinery we are not astonished to learn in view of the American temperament, the intensity of competition among business leaders, and the prevailing spirit of adventure. Thousands of workable old looms have been scrapped, and probably at the present time there are 100,000 automatic looms running in the United States. No other country can point to a rate of substitution which approaches that in the United States. The causes, apart from the temperamental and social to which reference has already been made, are probably (1) that there is disagreement as to the present economy of automatic looms on many fabrics,<sup>3</sup> (2) that Americans aim at frequency of renewal of plant, and avoid making their machinery so durable as to prove ultimately, perhaps, a handicapping inheritance, and (3) that a greater bulk of American work is appropriate for the new looms than of English or continental work. But automatic machinery is being used increasingly in Lancashire.<sup>4</sup> And the operatives ultimately benefit. It is the half-developed machine, to which labour must actually be linked as an essential part, which is responsible for monotonous work and creates the dislike of mechanical aids.

Now we turn to the recent development of the Southern States. Never has an industry grown faster than that of the two Carolinas, Georgia and Alabama. Some of the earliest experiments with the machine industry were conducted in South Carolina, but from that time till the end of the 19th century nobody imagined the possibility of a great Southern expansion. In 1880 the South contained less than half a million spindles—*i.e.* about as many as Hyde, Middleton or Chorley, and one-twenty-third of the numbers in Oldham. Twenty years later they had increased twelvefold and the Southern States, in respect of the number of spindles, had taken precedence of Bolton. To-day probably about eight and a half millions might be counted. In addition there are some two hundred thousand looms, or nearly as many as in the three leading cotton-weaving towns of England—Burnley, Blackburn and Preston. The rapid oncoming of the South may also be traced by its consumption of cotton—which as an index, however, is not perfect. This on an annual average was, in thousand bales, 164, 269, 453, 717 and 1233 in each of the periods 1876-1880, 1881-1885, 1886-1889, 1891-1895 and 1895-1900 successively. The consumption since then, as compared with that of the Northern States, Great Britain and the European continent, has been as follows. It must be remembered that the consumption per spindle varies greatly from place to place.

*Consumption of Cotton in Thousand Bales of about 500 lb each.*

	Southern States.	Northern States.	Total United States.	Great Britain.	Europe.
1900-1901	1583	1963	3546	3269	4576
1901-1902	2017	2066	4083	3253	4836
1902-1903	1958	1866	3824	3185	5148
1903-1904	1889	2046	3935	3017	5148
1904-1905	2270	2292	4562	3620	5148

The densest distribution of mills in the South is along the line of the Southern railroad, in the district known as the Piedmont. Of this group Charlotte in North Carolina is the natural centre: roughly, half the spindles and half the looms in the Southern States would be included within a circle around Charlotte of a

<sup>2</sup> The figures are those quoted by Mr T. M. Young and relate to the year 1902.

<sup>3</sup> See *e.g.* some passages upon this point in Uttley's report.

<sup>4</sup> For an account of the numerous types of automatic looms see the article on WEAVING: § *Machinery*.



radius of about 100 m. Of the remainder a large proportion is scattered over a wide area.

Much interest has been excited by this newly created Lancashire of a new type, and much speculation as to the causes that account for it has been elicited. An informal commission of Lancashire spinners and manufacturers crossed the Atlantic to make inquiries in 1902 and investigations have been undertaken by other persons,<sup>1</sup> and much has been written on the subject. A general explanation can now be framed without much difficulty, as in all probability most of the relevant facts have been brought to light. First and foremost the general development of the cotton industry in the United States must be emphasized. The industry was unquestionably foredoomed to expansion at this time, and the only question was where the expansion should take place. It was plain that the growth might be so great as to present the appearance of a new industry created with new labour rather than an extension of an old industry. It was not altogether surprising, therefore, that the exploitation of a new field of labour was thought of. The labour market of the North was comparatively exhausted; in less developed parts of the country larger supplies of intrinsically good labour might be looked for at lower wages. Skill was not a matter of much moment, because in the North it would have been necessary to incorporate much labour without previous experience in the industry, the work was intended to be of the rough kind upon which manual skill is least important, and it was intended to repose reliance for economy upon machinery in the main. The choice of new fields meant at the outset the sacrifice of some of the economies of localization, but so large an expansion was looked for that projectors did not despair of creating fresh industrial localization of sufficient magnitude to produce such economies as are derived from it, which, it must be observed, are inconsiderable in America, and have declined relatively with falling cost of transport and the adoption, as regards machinery, of the principle of interchangeable parts. And at any rate a new local industry would have a slight advantage in supplying markets in proximity to it.

These were the main general considerations, and the scale was turned in favour of the new locality (a) by the advantage of nearer supplies of cotton, and (b) by the known presence of much half-occupied white labour in the vicinity of otherwise suitable sites close to the cotton-fields. It must be borne in mind that the whole calculation had not to be reared merely upon an intangible theoretical basis. Cotton mills already existed in the South, and comparisons of costs of production, as things were then, afforded some groundwork for judgment.

As regards the first of the two special advantages mentioned above, the saving in the cost of carriage of the raw material is not commonly held to be high. Transport to the cotton ports is so well organized and sea-carriage is so cheap that Lancashire's distance from the source of her raw material is not a very appreciable handicap. A good deal of the cotton that must be used in some of the Southern mills cannot be supplied locally because it is not grown in the neighbourhood, and the requirements of these mills are met by transport arrangements which at present cost a sum not altogether out of relation to similar costs in the New England States and Lancashire. The percentages of freight charges on raw material in 1900 were \$2.18 in Georgia, \$1.50 in North Carolina, \$1.17 in South Carolina, and the amazingly low figure of \$1.20 in Massachusetts, but of course some part of the explanation is the somewhat higher quality of cotton on an average that is worked up in Massachusetts. For some years, however, the saving in labour has been a most important economy. Large supplies of half-occupied white labour existed in the Southern States among the families of small farmers who flocked South after the Civil War, and in the districts of the decayed hand industry in the mountains of Kentucky and North Carolina. For small money wages much of this labour could be attracted to the mills. Negroes do not work in the mills; the reason is said to

<sup>1</sup> Of which special mention may be made of Uttley's report as a Gartside scholar of the university of Manchester, already referred to, and Pidgin's report for the Massachusetts Bureau of Labour Statistics.

be partly their own disinclination and partly that they are not very efficient at factory work. As outside labourers, however, they have afforded important aid at a very trifling cost, but the expense of outside labour to a mill is never an item of much weight. The halcyon days to employers, when keen workers could be had for low wages, are now said to be past. The demand for labour was considerable, and as time went on additional supplies could be enticed only with the offer of better pay. In 1904 it was reported that some mills were unable to get fully to work for want of hands even at the improved rates. Again the Southern operatives have been visited by emissaries from the operatives of the New England States, which explains partly the present aspect of the wages question. Mr Pidgin, in his official report to the Massachusetts Bureau of Labour Statistics, questions whether a saving in wages can be expected to continue, and points out that though wages have been low the average efficiency of the operatives has not been high. Some, indeed, were sent to gain experience in Northern mills in the hopes that on their return they would spread the tradition of working at high pressure. Mr Pidgin is at some pains to measure labour efficiency in the South and North as far as it is possible to do so, but no simple sets of figures will prove very much. The value of the product per operative in 1900 was \$1200 in Massachusetts, \$1010 in Georgia, \$937 in North Carolina and \$984 in South Carolina, but the value of the product per operative depends as much upon the fixed capital charge per operative as upon the latter's efficiency. And the amount of machinery used per head is higher in the South than in the North. The percentage of operatives to machinery in Massachusetts being expressed as 100, that of Georgia was 53, that of North Carolina 43 and that of South Carolina 55 in 1900. These figures must be borne in mind when the average numbers employed in a mill in different States are being considered: in 1900 the averages were 565 for Massachusetts, 273 for Georgia, 171 for North Carolina and 378 for South Carolina. Measured by quantity of machinery the sizes of mills would stand in quite different relations. Hours of work in the South are bound to fall and the abuse of child labour, which had unquestionably crept in, may be expected to discontinue entirely. The factory conditions of children are better now than they were, but in some places they are still very bad. In Georgia no children under twelve are employed, but infants without fathers may begin work at ten years of age, and according to Mr Pidgin's report, "it certainly seemed as though the intention was honoured more in the breach than in the observance, or that there must be many widows in the neighbourhood of the cotton mills." In North and South Carolina the employment of children under twelve is illegal, but in these States also conditions are recognized under which it is possible to employ them earlier. According to figures relating to 1900 the dependence on child labour in the Southern States is very striking. The proportions engaged at different ages in the three chief cotton-manufacturing Southern States and Massachusetts are as follows:

	Men, 16 Years and over.	Women, 16 Years and over.	Children under 16.
Massachusetts . . . . .	48.98	44.59	6.43
Georgia . . . . .	39.98	35.52	24.50
North Carolina . . . . .	42.22	34.23	23.55
South Carolina . . . . .	44.43	28.72	26.85

It might be said that children are more useful when the work is rough, but this argument can hardly be regarded as accounting altogether for the great discrepancy as between Massachusetts and the South. The work is much rougher in the South: in 1900 the counts spun respectively in Massachusetts, Georgia, North Carolina and South Carolina were 25.10, 14.37, 18.83, and 19.04, and on the showing of the American census of 1900 spinning was getting finer over the last decade of the 19th century.

As contributory to the influences already recorded as accounting for Southern success it has been hinted that in the North employers have been less ready to welcome the new machinery, though in comparison with European rivals they would seem at

first to have acted rashly. However this may be, the South enjoyed the important advantage that its industry began just after a great technical advance had been made. When Northern mill-owners were anxiously deliberating about the destruction of good machinery merely because it was antiquated in design, the fortunate Southern mill-proprietor was getting to work with appliances up to date in every particular. It will be easier to balance comparative advantages as between North and South when undertakers in the newer district are confronted by problems concerning replacements and alterations. The rapidity of Southern growth need not astonish those who have watched the operations by which new mills are frequently set up in Lancashire and remember that the American business man is more daring than his British cousin. Company promotion in the great financial centres, payment for machinery and other plant in shares, or partially in shares, a general diffusion of risks and pledging of credit, would explain even more rapid growth of industries of even greater magnitude.

Broad generalizations are difficult to frame, hard to establish and liable to be misleading; some generalizations relating to the features of the American cotton industry taken as a whole the author is tempted to venture nevertheless. The characteristics of labour have already been incidentally commented upon. We have also noticed that the bulk of the work done is of a rough and simple character. In spite of American nationalism and the prevalence of protective sentiments it is said that there is still a prejudice in the United States against home-made fine cotton goods.<sup>1</sup> "The product of the American system is a cloth which is, on the whole, distinctly inferior in appearance, 'feel' and finish to that produced by the Lancashire system. To equal a Lancashire cloth in these respects an American cloth must not only be made of better cotton, but must contain more of it—perhaps 5% more. To this rule of inferiority there are, it is needless to say, exceptions, notably some of the American drills made for the China market. But the American home market, which absorbs nearly the whole of the product of American looms, is less exacting in these matters than the markets in which Lancashire cloths are sold."<sup>2</sup> It follows that the average counts spun in the United States are lower than in England, though they have been rising somewhat. Another feature of American spinning as compared with English is the high proportion of ring-frames to mules. In New England between 1890 and 1900 mule-spindles advanced by 100,000 and ring-spindles by nearly 2,000,000: in the South mule-spindles increased only from 108,500 to 180,500, while to the ring-frames 2,700,000 were added. To the general rule Rhode Island is the sole exception; here mule-spindles have increased and ring-spindles decreased; but in Rhode Island much of the fine spinning—for instance that for hosiery—is congregated.<sup>3</sup> One explanation of the preponderance of ring-spinning is to be found in the character of American fabrics. Again most of the operatives are not of a kind likely to acquire great excellence at mule-spinning. To the Americans we largely owe the ring-frame, because their encouragement helped it through the difficult period when its defects were serious, though it appears to have been discovered independently in both countries.

American organization displays intense specialism, but of a type different from that in England, where businesses are specialized by processes; in America they are specialized by products but hardly at all by processes. Independent spinning, independent manufacturing, independent bleaching, dyeing and finishing are the significant features of English industry to the bird's-eye view; in the United States the typical firm will spin, make up its own yarn, and perhaps complete its fabrics for the market; but the mills, it must be remembered, are intensely specialized as to the range of their product, so that the statement that American mills are less specialized than English mills must be received with caution. For some reasons we should expect to

find the American method applied even in England for fabrics of the highest qualities, because in their case the adaptation of the yarn to the fabric, and finishing to the fabric, are of great importance, and actually where the American plan is followed in England the explanation is frequently the speciality of the product which is associated with the particular firm producing it. When a firm manufactures a speciality of this kind it cannot always trust bought yarn, or the finishing applied to fabrics in the ton. But for other reasons specialized processes might be looked for where qualities were highest, as by specialism alone can the greatest excellence be attained. The final selection of method depends upon the relative importance for high qualities in the finished product of the connectedness of processes and the perfection of parts; and to these considerations must be added cost of transport between the works devoted to distinct processes, and the development of the commercial functions by which specialized process businesses are kept functioning as a whole. Probably it is the high development of British industry on the commercial side which chiefly explains the arrangements found in England. Attention should also be directed to the huge magnitude of American businesses. This is partly a consequence of American ambition in business, and partly a consequence of the undeveloped commercial ligaments by which producing businesses are brought into union. American producers in both North and South are too widely scattered for one town, like Manchester in the English cotton district, to be visited frequently by them for the purpose of making purchases and effecting sales. Even if the Americans did possess a convenient commercial centre, the high cost of transport between works distributed over a very wide area would prevent much specialism of businesses by processes from appearing. Writing capital letters for industrial processes and small letters and Greek letters for commercial functions, the possible arrangements in the cotton industry may be represented broadly as follows, brackets indicating the scope of businesses:<sup>4</sup>

- I. (a,A,B,C,d)
- II. (a)(A,B,C)(d).
- III. (aAa)(bBβ)(cCγ).
- IV. (a)(A)(a,b)(B)(β,c)(C)(γ).

The American industry approximates to the first type, while the English approximates rather to the last. Differences in respect of specialism by range of product are not shown in the formulae.

*Other Parts of America.*—Little need be said of the cotton industry in other parts of the New World. In Canada in 1909 there were, approximately, 855,000 spindles, and in Mexico in 1906, where the first factory was established in 1834, 450,000 spindles. In Brazil also there is an appreciable number of spindles, distributed (in 1895) among 134 factories, which are located chiefly in Rio de Janeiro and Minas Geraes, and are run for the most part by turbines and water-wheels.

*Germany.*—In Germany the cotton industry is by no means so intensely localized as in England, but three large districts may be distinguished:—

1. The north-west district, which consists of the Rhine Province and Westphalia and contained 1½ million spindles in 1901.
2. The country north of the mountain ranges of northern Bohemia comprises the middle district, which contained 2½ million spindles in 1901. In Saxony the industry has been carried on for four centuries.
3. Alsace, Baden, Württemberg and Bavarian Swabia make up the south-west district, to which some 3½ million spindles were assigned. It is in close proximity to the cotton districts of east France, Switzerland and Vorarlberg.

According to Oppel (1902) the German spinning industry is chiefly localized in—

Prussia	with	2020	thousand	spindles
Saxony	"	1870	"	"
Alsace	"	1600	"	"
Bavaria	"	1390	"	"

The spindles of Württemberg, which stands next, do not much exceed half a million. Only sixteen places in Germany (shown in tabular form on p. 169) contained as many as 100,000 spindles in 1901.

The history of the hand industry in Germany runs back some centuries. At the time when it flourished in the Netherlands we may be sure that it was prosecuted to some extent farther north and east. The start with the machine industry was not long

<sup>4</sup> Similar formulae have been used above, where a fuller explanation is given.

<sup>1</sup> *Textile Recorder*, August 15th, 1905.

<sup>2</sup> *Young's American Cotton Industry*, p. 13.

<sup>3</sup> Utley's report, p. 4.

delayed after its economies had been learnt in England. It was fostered by protection against the cheap products of Lancashire, and in the course of time stimulated by every step taken towards the economic unity of the German states which broke down local barriers

	Spindles in Thousands.		Spindles in Thousands.
Mülhausen . . . .	471	Chemnitz . . . .	195
Augsburg . . . .	373	Gebweiler . . . .	187
Gronau . . . . .	274	Leipzig . . . . .	182
Werdau . . . . .	249	Crimmitschau . . .	168
Rheydt . . . . .	248	Logelbach . . . . .	141
München-Gladbach	216	Bocholt . . . . .	128
Rheine . . . . .	198	Bamberg . . . . .	125
Hof . . . . .	196	Bayreuth . . . . .	100

and therefore enlarged the German market. Duties upon cotton goods, however, were not immoderately high until the measure of 1879, the policy of which was carried to a further stage in 1885. Slight reactions were brought about in 1888 and 1891, largely by the complaints, not only of the consumers of finished goods, but also of manufacturers whose costs of production were kept up by the high prices of home-spun yarns and the tax on imported substitutes. According to the investigations made by the Board of Trade, the general *ad valorem* impact of German duties on British goods stood somewhat as follows in 1902:—

Statement showing the Average Incidence (ad valorem) of the Import Duties levied by Germany on British Cotton Goods.

	Average Value of Exports from the United Kingdom to all Countries in 1902.	Rate of Duty estimated Equivalent.	Approximate Equivalent Rate of Duty <i>ad valorem</i> .
Cotton manufactures—			Per Cent.
Piece goods, unbleached .	2·01d. per yd.	0·87d. per yd.	43
" " bleached . . . . .	2·46d. " "	1·09d. " "	44
" " printed . . . . .	2·68d. " "	1·31d. " "	49
" " dyed, &c. . . . .	3·46d. " "	1·31d. " "	38
Cotton thread for sewing .	26·89d. per lb	3·81d. per lb	14
Cotton yarn—			
Grey . . . . .	10·49d. " "	0·98d. " "	9
Bleached or dyed . . . .	11·23d. " "	1·63d. " "	15

The duties are not prohibitive—they are much less than those of the United States at the same time—but they are heavy on the classes of goods which come into competition with home-made goods. The general principle of the tariff is to treat easiest commodities which are made with least success at home, or are in the highest degree raw material for a home manufacture. Therefore yarns are not taxed very heavily, and of these the finest counts escape with slight discouragement.

In the cotton industry, as well as in numerous other industries of Germany, almost feverish activity was shown after the Franco-German War. Previously great advance had been made, but it was not until the last quarter of the 19th century that Germany forced herself into the first rank. As measured by the annual consumption of cotton the German industry increased as follows:—

Metric Tons of Cotton per Annum.	(In Thousands.)
1836-1840 . . . . .	9
1856-1860 . . . . .	46
1876-1880 . . . . .	124
1886-1890 . . . . .	201
1899-1903 . . . . .	324

It must be remembered that the spindles and looms of Alsace and Lorraine were reckoned as German after the war: they amounted in 1895 to one and a half million spindles and nearly forty thousand looms.

In the 'seventies there was no dispute as to England's substantial lead in respect of efficiency. Alexander Redgrave, the chief factory inspector, made inquiries on the continent both in 1873, when Lancashire was anxious as to the comparative cost of production abroad because of the short-time bill then before parliament, and previously, and reported most unfavourably upon the state of the industry in Germany. Hours were long, the skill of the hands was inferior, speeds were low and time was wasted. In several important respects his views were corroborated by M. Taine in his *Notes on England*, and by the evidence adduced before the German commission upon the cotton and linen industries in 1878. A marked contrast is noticeable between the sketches drawn of this period and the careful picture presented by Professor Schulze-Gaevernitz of the early 'nineties," but even in the latter the advantage of England is represented as substantial in every essential respect. The gap

which existed has narrowed, but it is still unmistakable. To give one example, according to Dr Huber's figures there were in Saxony at the end of the 19th century 106 spindles to an operative and about as many weavers as looms, whereas in England there were about twice as many spindles to an operative and twice as many looms as persons engaged in weaving sheds.<sup>1</sup> As regards manufacturing, the character of the product may partly explain the difference, but it will not entirely. The reader need hardly be warned that the comparison drawn is exceedingly rough. German cotton operatives taken all round are certainly less efficient than English labour of the same kind. The reason is partly that the proportion of the German workpeople who have been for long specialized to the industry, and look forward to continuing in it all their lives, is not high. Complaint is constantly made of the number of vacancies created in the mills each year by operatives leaving, and of the impossibility of filling them with experienced hands. Many of the vacancies are caused by the return of workpeople to the country parts. Sometimes the mills are in the country, or within easy reach of it, and labour is obtained from the unoccupied members of peasants' families. In these cases the factories do not always succeed in attracting the most capable people, and work in the factory is not infrequently looked upon as a makeshift to supplement a family's earnings. Among Lancashire operatives far more pride of occupation may be met with. In many of the industrial parts of Germany English conditions are evolving, but they are not generally the rule. An American consul may be taken to report to his own country without prejudice as to the rival merits of German and English conditions: one such wrote in 1901:—"The task of educating labour

up to a high degree of efficiency is difficult, and many generations are necessary to achieve that result. The English cotton spinners have attained such a degree of skill and intelligence that, for the most part, no supervision is necessary. In Germany the presence of a technical overseer is indispensable. Another advantage which England enjoys is the cheap price of machinery. Germany imports the major part of her machinery from England, and German wholesale dealers in these machines have not been able, by placing large orders, to overcome the difference caused by freight and tariff." Wages reflect the efficiencies of countries, not of course perfectly, but in some degree. They are much higher in Lancashire than in Germany, as is made evident by an article from the pen of Professor Hasbach in *Schmollers Jahrbuch* (vol. ii., 1903). The author tries to show that Germany is not so far behind England industrially as is generally believed, and the contrast drawn by him, greatly to the advantage of Lancashire, is not likely to exaggerate the superiority of English conditions. It is calculated by Professor Hasbach that the daily wages of spinners are about 5/10 to 6/ at Oldham, 6/6 at Bolton and 5/6 in Stalybridge and neighbouring places. With these he compares the 3/70 to 3/80 marks paid in the Rhine Province and Leipzig, and the 3 to 3/15 marks paid in the Vogtland, Bavaria and Alsace, and mentions an exceptionally high wage of 4½ marks, which was earned by an operative who worked a new and long doubling mule. The wage paid to the big piecer in England, Dr Hasbach goes on to show, is not much greater than that received by a good assistant in Germany. This comparison as it stands will probably give some readers an idea that English advantages are greater than they actually are, because it may be overlooked that the great difference between wages in the case of English and German spinners is not repeated among the piecers. Taking a spinner and his first assistant as the unit, we should have a joint average daily wage of about 8/6 in England and 6/ in Germany. In the case of weavers, comparison of wages is more difficult to draw, but the advantage of England would seem to be but little less. However, in instituting a comparison between two countries, as regards the relative efficiency of labour in some industries, we should do well to remind ourselves that efficiency is a somewhat transitory thing, dependent upon education and experience as much as upon aptitude. In respect of the capacity of labour for the task required in the cotton industry, we could not (writing in 1907) make the statement that England leads significantly with the assurance with which we can assert her superiority in respect of present attainments. The cotton industry has not been prosecuted on a large scale in Germany so long as in England, and the Germans have not, therefore, had the same opportunity for developing their latent powers. But the thoughtfulness and carefulness of the German workman are beyond dispute, and these qualities will procure for him a leading place where work is not mechanical. Already in the cotton industry it is said that the operatives are displaying quite striking powers of undertaking a wide range of work and changing easily from one pattern to another. Hence German firms feel little hesitation in taking small orders on special designs; they do not experience any great difficulty in getting their factors accommodated to produce the required articles.

<sup>1</sup> *Deutschland als Industriestaat.*

real cost of production in England in the organization of the industry. The German industry is not only less localized, but, as we might perhaps infer from that circumstance, less specialized. A German factory will turn out scores of patterns where an English firm will confine itself to a few specialities. Time is wasted in accommodating machinery to changes and in accustoming the hands to new work. The German producer suffers from the undeveloped state of the market. In England specialized markets with specialized dealers have greatly assisted producers both in their buying and selling. A German manufacturer may have to find his customers as the English manufacturer need not; at least, so Professor Schulze-Gaevernitz has assured us, and conditions have not been wholly transformed since he made his careful analysis. He wrote:—"But especially disadvantageous is the decentralization in respect to the sale. Here also the German manufacturer stands under the same disadvantages with which the English had to struggle in the 'thirties. The German manufacturer still seeks his customers through travellers and agents, and in many instances through retail sellers, whose financial standing is often questionable, whose necessity for credit is always certain. Hence the complaints about the bad conditions of payment in Germany which crop up continually in the *enquête*. The manufacturers had to wait three, four or six months, and even twelve months and longer for payment. In reality there existed 'termless terms,' a 'complete anarchy in the method of payment.' . . . The manufacturer cannot be at the same time commission agent, banker, merchant and retail dealer; he needs sound customers capable of paying. He fares best if the sale is concentrated in one market, and 'change' prices simplify the struggle between buyer and seller. The search for customers, foreign as well as home, and the bearing of all possible risks of disposal, are in any case difficult enough to necessitate the whole strength of a man. The wholesale merchant alone is in a position to pay the manufacturer in cash or on sure, short terms. But especially where export is in question is the dispersal of sales an extreme impediment. The manufacturer cannot follow the fashions in Australia and South America; the foreign buyer cannot travel from mill to mill."

It is the want of commercial development in Germany which accounts for the more frequent combination of weaving and spinning there than in England. But in Germany to-day economic enterprise is flourishing, and commercial development may confidently be looked for together with advance in other directions. It is not many years since the typical German cotton factory was comparatively primitive; now mills can be exhibited which might have been erected recently in Oldham. Between the early 'eighties and the 'nineties the expansion of the German industry was enormous—the imports of cotton-wool rose by nearly 70%—yet the number of spinning-mills was actually reduced from 6750 to 2450, while the number of weaving-sheds fell from 56,200 to 32,750. At the same time the factories devoted to mixed goods declined from 25,200 to less than 16,350. From these figures we may gather how rapidly the average size of mills and weaving-sheds enlarged in the period. One cause, no doubt, was that improved economies in the new businesses forced antiquated factories to shut down and make way for still newer erections. There were recently about twice as many persons engaged in weaving as in spinning, but the largest numbers of all—slightly in excess of those in weaving-sheds—were the persons occupied in the manufacture of cotton-lace, trimmings, &c. As we might imagine, Germany's exports of cotton goods are not high. Including yarns they amounted to £13.7 million per annum in 1899-1903. In order of value their largest exports are (1) coloured goods, (2) hosiery, (3) lace and embroidery, (4) yarns, and (5) trimmings, &c.

*France.*—Into the industrial conditions of the two leading rivals of England we have entered in some detail; the state of affairs in the rest of the world must be dealt with more briefly. Of France more ought to be said than we can find place for, though in respect of the magnitude of her cotton industry, as measured by the quantity of spindles, she stands now not fourth, but fifth, Russia taking precedence. But the work of the French is incomparably superior to anything that is turned out from Russia. France suffered a severe blow when the industry of Alsace and Lorraine was lost to Germany, but the inexhaustible originality of French *design* will always secure for her goods a place in the first rank. As regards *artistic* results France leads, but the real cost of her spinning and weaving cannot approach in lowness that of Lancashire. After costly strikes the French workmen have succeeded in shortening their hours to ten and a half a day; and here it may be remarked that the International Association of Textile Operatives tends to equate continental industrial conditions to those of England. The French industry has been fostered by tariffs. When the Board of Trade calculation was made, French tariffs were found to bear upon British cotton goods with about the same severity as those of Germany, except that the former treated more hardly yarns and cotton thread for sewing. French protectionism has kept down her exports; such as they are the majority proceed now to her colonies. Normandy, the north and east, in order, are the chief seats of the industry. In Normandy the leading city is Rouen, and Darnétal, Maromme, Sotteville, Havre, Yvetot, Dieppe, Évreux. Gisors, Falaise and Flers are important places. The north contains the

important towns of Lille, Tourcoing, Roubaix, St Quentin, Amiens and Hellemmes. The Vosges is the chief district of the east, and the leading towns are Epinal, St Dié, Remiremont, Senones, Val d'Ajol, Cornimont and La Bresse. The following towns which are not included in any of the districts mentioned above are also noteworthy:—Troyes, Nantes, Cholet, Laval, Tarare, Roanne, Thizy and Villefranche upon the Saône. Cotton arrives at Havre and Marseilles; at the latter chiefly the product of Egypt and the East. Havre used to be the most important cotton port in continental Europe, but to-day more spindles are fed from Bremen than from Havre. France's consumption of cotton annually in the period 1899-1903 was 215,000 metric tons.

*Russia.*—Power-spinning was carried into Russia by Ludwig Knoop, who had learnt the trade in Manchester, and to his efforts its early success was due. The growth, largely the result of very heavy protectionism—according to the Board of Trade report, from 50 to more than 100% more severe than that of Germany,—has been rapid, as the following table bears witness:—

Average yearly Importation of Cotton wool and Yarn into Russia.

	Raw Cotton in thousand tons.	Cotton Yarn in thousand tons.
1824-1826	·9	5·4
1836-1838	4·6	10·1
1842-1844	8·4	9·5
1848-1850	21·4	4·5
1889-1891	117·4	3·4
1899-1903	180·0	2·9

Table showing approximately the Growth of Spindles and Looms in Russia.

	Spindles.	Looms.
1857	1,000,000	..
1877	..	55,000
1887	4,000,000	85,000
1900	6,000,000	146,000
1909	7,800,000	..

The chief districts were the following in 1900:—

Government.	Factories.	Spindles (in thousands).	Looms (in thousands).
Moscow	56	1295	33
Vladimir	67	1224	42
Piotrkov	25	745	20
St Petersburg	24	1074	11
Jaroslav	4	347	2
Kostroma	25	274	20
Tver	6	348	9
Esthonia	1	440	2
Ryazan	4	146	3
Elsewhere	15	198	4
Total	227	6091	146

Fine spinning has been attempted only recently. Generally speaking 70's used to be the upper limit, but now counts up to 140's are tried, though the bulk of the output is coarse yarn. The inefficiency of the labour was made abundantly plain by Dr Schulze-Gaevernitz in his economic study of Russia, and conditions have not greatly altered for the better since. Roughly, 170,000 operatives worked 6,000,000 spindles in 1900, which means 35 spindles per head as compared with more than 100 in Saxony and more than 200 in England. In weaving the ratio of operatives to machinery worked out at about one loom to each weaver, which is comparatively much less unfavourable to Russia. The proportion in Saxony is about the same, but in England the average approaches two looms to a weaver. The speed of machinery cannot be compared, and we must remember that the above contrasts are rough only, and made without regard to differences of product. Russia is encouraging the growth of cotton at home. It is of very inferior quality, but 100,000 tons from the provinces of central Asia and Trans-Caucasia were used in 1900: her imports in the same year were about 170,000 tons.

*Switzerland.*—Swiss spindles advanced until the early 'seventies,' but a decline followed. Details are:—

1830	400,000
1850	950,000
1876	1,854,000
1883	1,809,000
1898	1,704,000
1909 (estimated)	1,500,000

The falling off is occasioned mainly by (a) the developing industrialism of the rest of Europe, notably Germany, and (b) the diminishing importance of the natural advantage of water-power with the

improvement of steam-engines. Swiss yarns have been kept out of continental markets in the interests of home spinning. Now fancy cotton goods, laces and trimmings are the leading specialities of the Swiss textile workers. About half the Swiss spindles are in the canton of Zürich, between a quarter and a third in Glarus, about the same in St Gall and 9% in Aargau. Figures show that the average size of the Swiss mill is small. The average spindles to a mill were 22,000, and very few mills held more than 50,000 spindles. Some 9000 of the power-looms are in Zürich, some 4500 in Glarus and 4000 in St Gall. Wald in the south-east of the canton of Zürich is an important centre of the muslin manufacture.

*Austria.*—Austria contains about 4,200,000 spindles and more yarn is consumed than it produces, as on balance there is an excess of imports of yarn. Bohemia, lower Austria, Tirol and Vorarlberg account for the mass of Austrian spinning. The following details relating to these districts recently are of interest:—

	Mills.	Spindles.	Average spindles to a mill.
Bohemia	82	1,870,000	22,800
Lower Austria	23	460,000	20,000
Tirol and Vorarlberg	20	435,000	21,700

Reichenberg and the surrounding district is the chief manufacturing place: here are more than 80,000 looms, nearly a half of which are hand-loom.

*Italy.*—Recent industrial growth in Italy is remarkable: statistics of spindles since 1870 are as follows, but the percentage of error is probably high:—

1870	500,000
1888	900,000
1898	2,100,000
1909	4,000,000

The distribution of spindles is roughly as follows:—

Lombardy	1,850,000
Piedmont	1,000,000
Venetia	550,000
Campania	250,000
Liguria	250,000
Tuscany	100,000

The distribution of spindles and power-looms in the chief manufacturing towns in Italy is shown in the following table:—

	Spindles.		Spindles.
Turin	470,000	Genoa	210,000
Bergamo	450,000	Salerno	150,000
Como	250,000	Brescia	310,000
Milan	660,000	Naples	100,000
Novara	410,000	Udine	240,000

	Power- Looms.		Power- Looms.
Milan	40,000	Pisa	2,500
Turin	22,000	Como	6,000
Novara	13,000	Bergamo	13,000
Genoa	6,000	Udine	3,500

The district between Milan and Lago Maggiore contains numerous villages devoted to the cotton industry. Many of the factories in the province of Bergamo are situated in the Valle Seriana, which is endowed with abundant water-power. In this district coarse and medium yarns and grey cloth are the chief products. In the province of Milan there are several small towns, notably Gallarate, Busto Arsizio and Monza, in which the manufacture of coloured and fancy goods is extensively carried on. The finest spinning in Italy is done in Turin. The coarsest spinning is done in Venetia.

*The Netherlands.*—In 1805 the cotton industry was reintroduced into the Netherlands from England in its factory form. Seventeen mules bearing 16,000 spindles are said to have been smuggled across the channel, while forty Englishmen were enticed over to work them, in spite of English legal prohibitions. Liévin Bauwens was the prime mover of the achievement. Expansion rapidly followed, and in 1892 Belgian spindles numbered nearly a million. Since then a decline has set in. Ghent, with about 600,000 spindles, is the only really important place: no other place has as many as 50,000. Holland possesses about 417,000 spindles: the leading district is Twente and the leading town Enschede; Twente contains also about 20,000 power-looms. Rotterdam is the chief cotton port; Amsterdam, always a far-away second, has lost place still further of late.

*Spain and Portugal.*—The greatness of Spain in the cotton industry lies buried in the remote past, but of late she has awakened somewhat, with the result that her spindles now number about 1,853,000. Catalonia is the chief province where the industry is carried on, and Barcelona surpasses all other centres. Portugal possesses nearly half a million spindles (the bulk in Lisbon and Oporto), many of which have appeared since 1894.

*The Rest of Europe.*—Of Sweden, Norway, Denmark, Greece and Macedonia no special mention need be made, nor of other parts where the cotton industry may just exist. It may be mentioned here that among the scattered rural populations of many parts of the continent, even in such advanced countries as France and Germany, hand-loom are still to be found in large numbers.

*India.*—The hand-cotton-industry has been carried on in India since the earliest times, and for many years English fabrics were protected against the all-cottons of India. Soon after the introduction of spinning by rollers, English all-cottons began to rival the Indian in quality as well as in cost. A large export trade to India has grown up, but Indian hand-loom weavers still ply their craft. In 1851 power-spinning was started, and by 1876 there were in India 1,000,000 spindles. Since then they have nearly reached six millions and importations of yarn have been significantly affected. The growth of Indian power-spinning, which is almost entirely of the ring variety, was attributed by some to the depreciation of the rupee after 1873, but the fall in the value of the rupee was stopped in 1893 and the competition continued. The real explanation, no doubt, is that at the cost of Indian labour it is found cheaper to import machinery and coal than to export or cease to grow cotton and import yarn. This was the conclusion of the majority report of the committee of the Manchester Chamber of Commerce, which made an inquiry into Bombay and Lancashire spinning in 1888. Besides, as regards Indian exports to China, the remission in 1875 of the 3% export duty on yarns must be borne in mind. The efficiency of labour in India is only a small fraction of that of Lancashire operatives. Recently complaint has been made that Indian mills are being run inhumanly long hours with the same set of labour, and that child-labour is being abused, both legally and illegally—legally as regards children over fourteen who are classed as adults. The working of heavy hours began with the electric lighting of the mills; previously all shut down at sunset largely because of the cost of illumination. The outcry which has been raised is, perhaps, sufficient guarantee that the worst evils will be remedied. Indian spinning, it must be remembered, is still very coarse as a rule, though some fine work is attempted and the average of counts spun is rising. Though there are about a ninth as many spindles in India as in the United Kingdom, there are only about one-fifteenth as many power-looms, 46,400 in all, to which figure they rose between 1891 and 1904 from 24,700. The reason for the paucity of power-looms is probably two-fold, (1) the low cost of production of Lancashire weavers, and (2) the habit of hand-loom weaving which is fixed in the Indian people. A rapid increase of power-looms is, however, observable. The hand-loom industry is gigantic, particularly in the Madras Presidency and the Central Provinces; in the latter district alone there were estimated to be 150,000 hand-loom in 1883. The following details relating to the Indian cotton industry are supplied officially:—

*Cotton Mills in India, including Mills in Native States and French India.*

Mills.	1897-1898.	1903-1904.
Mills (number)	164	204
Capital (thousand £s)	648	1,067
Looms (number)	36,946	46,421
Spindles (thousands)	4,219	5,213
Persons employed (daily average)	148,753	186,271
Yarn produced:—		
Counts (1 to 20 thousand lb)	400,384	474,509
Counts (above „ „ „)	62,212	104,250
Total lb	462,596	578,759
Yarn produced:—		
Bombay (thousand lb)	324,649	414,932
Bengal „ „	44,807	46,487
Madras „ „	32,516	28,714
United Provinces (including Ajmere-Merwara) (thousand lb)	26,747	29,930
Central Provinces (thousand lb)	18,334	24,549
Punjab „ „	6,607	11,578
Elsewhere „ „	8,936	22,569
Total lb	462,596	578,759
Woven goods:—		
Grey (thousand lb)	83,136	111,494
Others „ „	8,152	26,550
Total lb	91,288	138,044

*China.*—In China spinning has not met with the same success as India, and power-manufacturing has not yet obtained a sure footing. The ingrained conservatism of the Chinese temperament is no doubt a leading cause. Of the spindles in China—about 600,000 in all—from a half to three-fifths are in Shanghai. The following details



# COTTON MANUFACTURE

relating to the inception of the power-industry are quoted from a Diplomatic and Consular Report of 1905:—

"The initial experiment on modern lines was made in 1891, when a semi-official Chinese syndicate started at Shanghai—the Chinese Cotton Cloth Mill and the Chinese Cotton Spinning Company. Its originators claimed for themselves a quasi-monopoly, and prohibited outsiders who were not prepared to pay a fixed royalty for the privilege from engaging in similar undertakings. Although certain Chinese accepted this onerous condition, foreigners resented it as an undue interference with their treaty rights, and it was only when Japan, in 1895, after her war with China, inserted in the treaty of Shimonoseki an article providing for the freedom of Japanese subjects to engage in all kinds of manufacturing industries in the open ports of China, and permitting them to import machinery for such purposes, that outsiders were afforded an opportunity of exploiting the rich field for commercial development thereby thrown open. Accordingly, so soon as the Japanese treaty came into force no time was lost in turning this particular clause to account, and the erection of no less than 11 mills—Chinese and foreign—was taken in hand. At that time the pioneer mill, which was burnt to the ground in October 1893, but subsequently rebuilt, and other Chinese-owned mills were together working some 120,000 spindles and 850 looms."

By 1905 the mills increased to 17, the spindles to 620,000 and the looms to 2250, but there is little inclination to expansion. Yarns for the hand-loom are obtained primarily from India and secondarily from Japan. The following are the recent figures relating to imported yarns:—

In million lb

	1898.	1899.	1900.	1901.	1902.	1903.
	lb	lb	lb	lb	lb	lb
British	9.1	7.8	4.1	7.0	4.3	2.2
Indian	186.7	254.2	131.5	228.9	251.6	250.8
Japanese	64.7	104.0	62.9	66.4	69.7	110.9
Hong-Kong	..	..	..	..7	..8	1.2
Tongkinese	..	..	..	..	..	.01
Total	260.5	366.0	198.5	303.0	326.4	365.1

Japan.—If in China the factory cotton industry reveals no prospects as yet of a great future, the same cannot be said of Japan.

The chief centres of spinning with their outputs in value of yarn for a year at the beginning of the 20th century are stated beneath:

	Thousands.		Thousands.
	£ s.		£ s.
Osaka	1226.5	Nara	111.5
Hyogo	495.5	Hiroshima	91.3
Okayama	374.4	Kyoto	82.2
Miye	238.1	Wakayama	79.2
Tokyo	227.9	Ehime	70.5
Aichi	224.3	Kajawa	36.4
Fukuoka	168.1		

The following table gives other valuable information:—

Year.	Gross Amount of Capital invested.	Average Number of Spindles used daily.	Quantity of Raw and Ginned Cotton demanded.	Total Production of Cotton Yarn.	Average Number of Male Operatives daily employed.	Average Number of Female Operatives daily employed.	Annual Working Days.	Daily Working Hours.	Average Daily Wage of Male Operatives.	Average Daily Wage of Female Operatives.
	Thousand £	Thousands.	Million lb.	Million lb.						
1892-1894	1123	420	112.9	97.9	6,916	21,695	290	22	4d. to 4½d.	2d. to 2½d.
1900-1902	3569	1209	335.3	288.0	13,373	50,271	312	19	7½d.	4½d. to 5d.
1903	3441	1290	375.5	322.7	13,160	57,166	308	20	7½d. to 8d.	4½d. to 5d.
1904	3470	1306	332.1	285.9	10,967	52,115	309	20	8d.	5d.

With amazing adaptability the Japanese have assumed the methods of Western civilization as a whole. But hand-weaving more than holds its own, and power-weaving has as yet met with little success. The custom already mentioned as a cause of the continued triumph of the hand-loom in India and China is strong also in Japan, and the economy of the factory system is greater relatively in spinning than in manufacturing. In Japan it is ring-spinning which prevails: 95% of the spindles are on ring-frames. Ring-spinning entails less skill on the part of the operative, and ring-yarn is quite satisfactory for the sort of fabrics used most largely in the Far East. The counts produced are low as a rule. Generally mills run day and night with double shifts, and the system seems to pay, though night-work is found to be less economical than day-work there as elsewhere. More operatives are placed on a given quantity of machinery in Japan than in Lancashire—possibly more "labour" as well as more operatives, because labour as well as operatives may be cheaper. On the same work the output per spindle per hour is less in Japan than in England, even when day-shifts only are taken into account.

Japanese work has been severely criticized, but the recency of the introduction of the cotton industry must not be forgotten.

BIBLIOGRAPHY.—The literature relating to the cotton industry is enormous. The most complete bibliographies will be found in Chapman's *Lancashire Cotton Industry* (where short descriptions of the several works included, which relate only to the United Kingdom, are given); Hammond's *Cotton Culture and Trade*; and Oppel's *Die Baumwolle*. The list of books set forth here must be select only.

The development of the English industry can be traced through the following:—Aikin, *A Description of the Country from Thirty to Forty Miles round Manchester* (1795); Andrew, *Fifty Years' Cotton Trade* (1887); Baines, *History of the Cotton Manufacture in Great Britain* (1835); Banks, *A Short Sketch of the Cotton Trade of Preston for the last Sixty-Seven Years* (1888); Butterworth, *Historical Sketches of Oldham* (1847 or 1848); Butterworth, *An Historical Account of the Towns of Ashton-under-Lyne, Stalybridge and Dukinfield* (1842); Chapman, *The Lancashire Cotton Industry* (1904); Cleland, *Description of the City of Glasgow* (1840); *A Complete History of the Cotton Trade, &c.*, by a person concerned in trade (1823); Ellison, *The Cotton Trade of Great Britain including a History of the Liverpool Cotton Market and of the Liverpool Cotton Brokers' Association* (1886); Léon Faucher, *Études sur Angletterre* (1845); French, *The Life and Times of Samuel Crompton* (1859); Guest, *A Compendious History of the Cotton-manufacture, with a Disproof of the Claim of Sir Richard Arkwright to the Invention of its Ingenious Machinery* (1823); Guest, *The British Cotton Manufacture and a Reply to the Article on Spinning Machinery, contained in a recent Number of the Edinburgh Review* (1828); Helm, *Chapters in the History of the Manchester Chamber of Commerce* (1902); Kennedy, *Miscellaneous Papers on Subjects connected with the Manufactures of Lancashire* (1849); Ogden, *A Description of Manchester . . . with a Succinct History of its former original Manufactories, and their Gradual Advancement to the Present State of Perfection at which they are arrived, by a Native of the Town* (1783); Radcliffe, *Origin of the New System of Manufacture, commonly called "Power-Loom Weaving" and the Purposes for which this System was invented and brought into use, fully explained in a Narrative concerning William Radcliffe's Struggles through Life to remove the Cause which has brought this Country to its Present Crisis* (1828); Rees' *Cyclopaedia*, articles on Cotton (1808), Spinning (1816) and Weaving (1818); Ure, *The Cotton Manufacture of Great Britain, investigated and illustrated, with an Introductory View of its Comparative State in Foreign Countries* (2 vols.); Ure, *The Philosophy of Manufacture; or An Exposition of the Scientific, Moral and Commercial Economy of the Factory System of Great Britain* (1835); Watts, *Facts of the Cotton Famine* (1866); Wheeler, *Manchester: its Political, Social and Commercial History, Ancient and Modern* (1836).

In addition there are many short papers in the Manchester public library. Much valuable information may be obtained from parliamentary papers; a list of relevant ones is printed as an appendix to Chapman's *Lancashire Cotton Industry*, but it is too lengthy to repeat here. The most important are the reports relating to the hand-loom weavers, those on the employment of children in factories (of which a list will be found in Hutchins and Harrison's *History of the Factory Legislation*), and the state of trade and the annual reports of the factory inspectors. On labour questions there is a list of authorities in Chapman's *Lancashire Cotton Industry* and also of

parliamentary papers containing useful material. Printed copies of the "Wages Lists" are issued by the trade unions. The Factory Acts are dealt with in Hutchins and Harrison's *History*, mentioned above, as well as the literature relating to them; while the handbooks by Redgrave and by Abraham and Davies are specially useful.

On the industry abroad the following are the fullest authorities:—Besso, *The Cotton Industry in Switzerland, Vorarlberg and Italy* (1910) (a report made as a Gartside Scholar of the University of Manchester); Chapman's *Cotton Industry and Trade* (1905); Hammond, *The Cotton Industry*; Hasbach's article, "Zur Charakteristik der englischen Industrie," in *Schmollers Jahrbuch*, vol. ii. (1903); Leconte, *Le Cotton*; Lochmüller, *Zur Entwicklung der Baumwollindustrie in Deutschland* (1906); Montgomery, *The Cotton Manufacture of the United States of America contrasted and compared with that of Great Britain* (1840); Oppel, *Die Baumwolle* (1902); Schulze-Gaevernitz, *Der Grossbetrieb: ein wirtschaftlicher und sozialer Fortschritt: eine Studie auf dem Gebiete der Baumwollindustrie* (1892; translated as *The Cotton Trade in England and on the Continent*); T. M. Young,

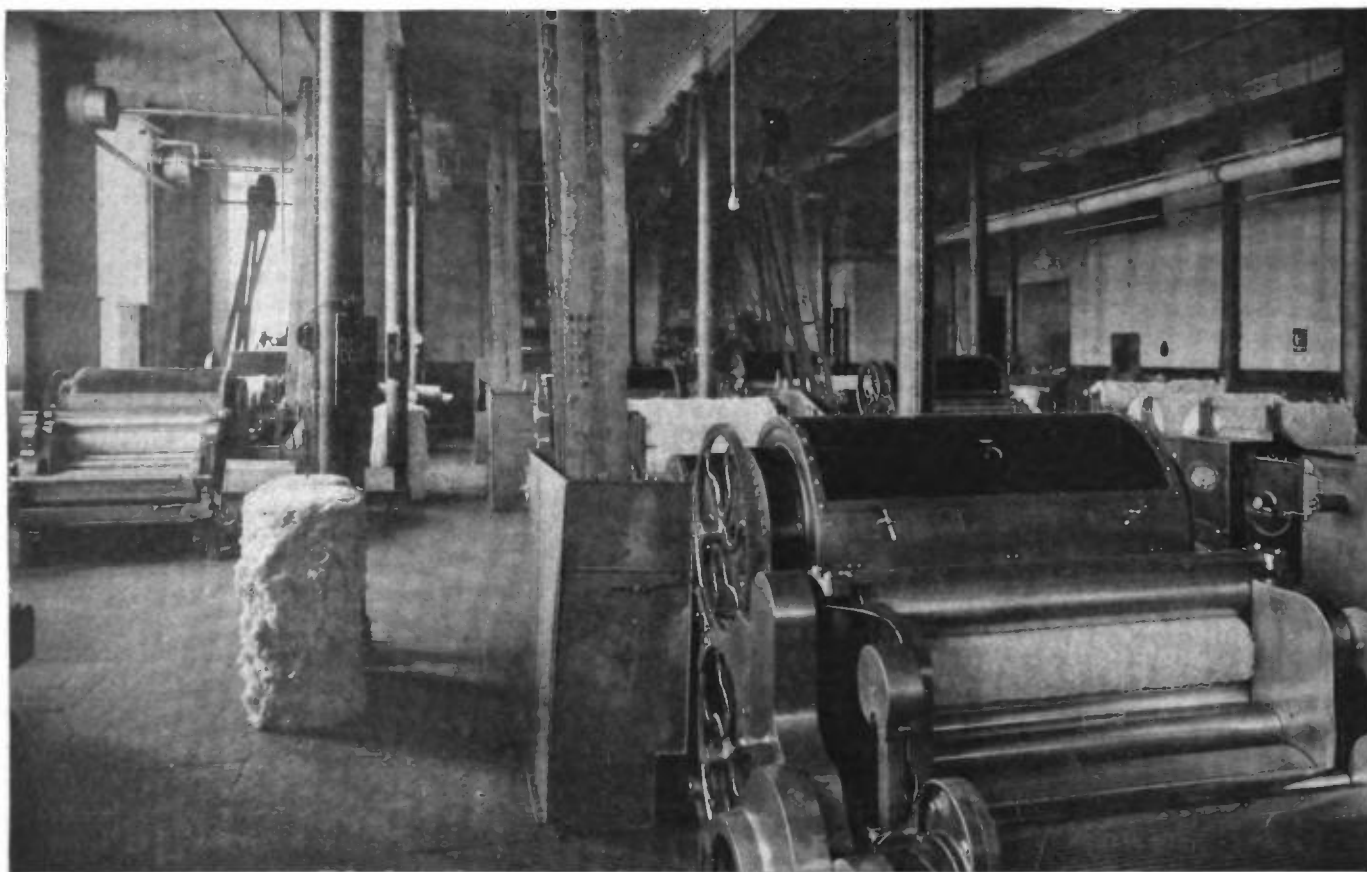

FIG. 10.—BLOWING ROOM.

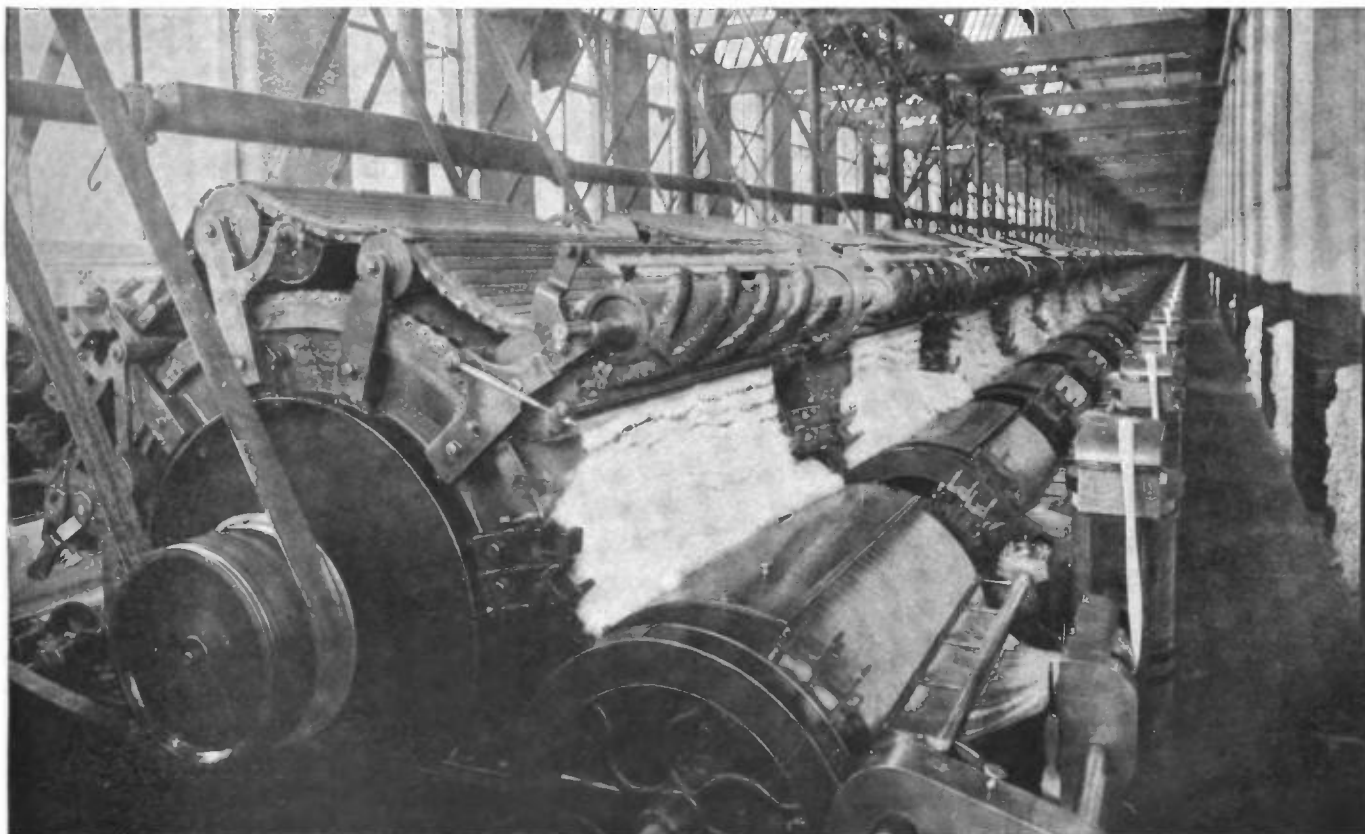

FIG. 11.—CARDING ROOM.

*(From Photographs taken in a Manchester Fine Cotton-spinning Mill, by R. Banks.)*

# COTTON-SPINNING MACHINERY

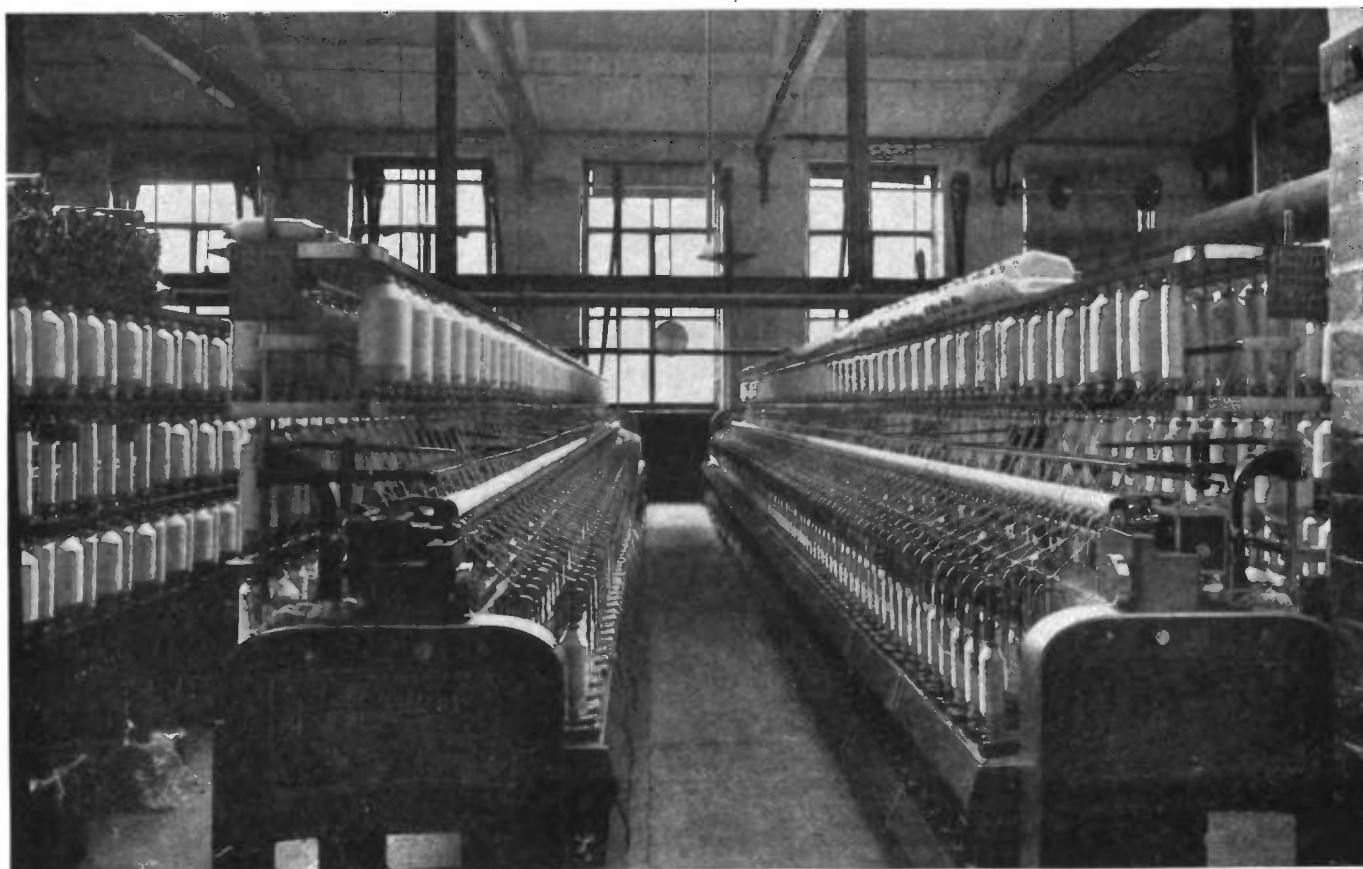

FIG. 12.—JACK-FRAME ROOM.

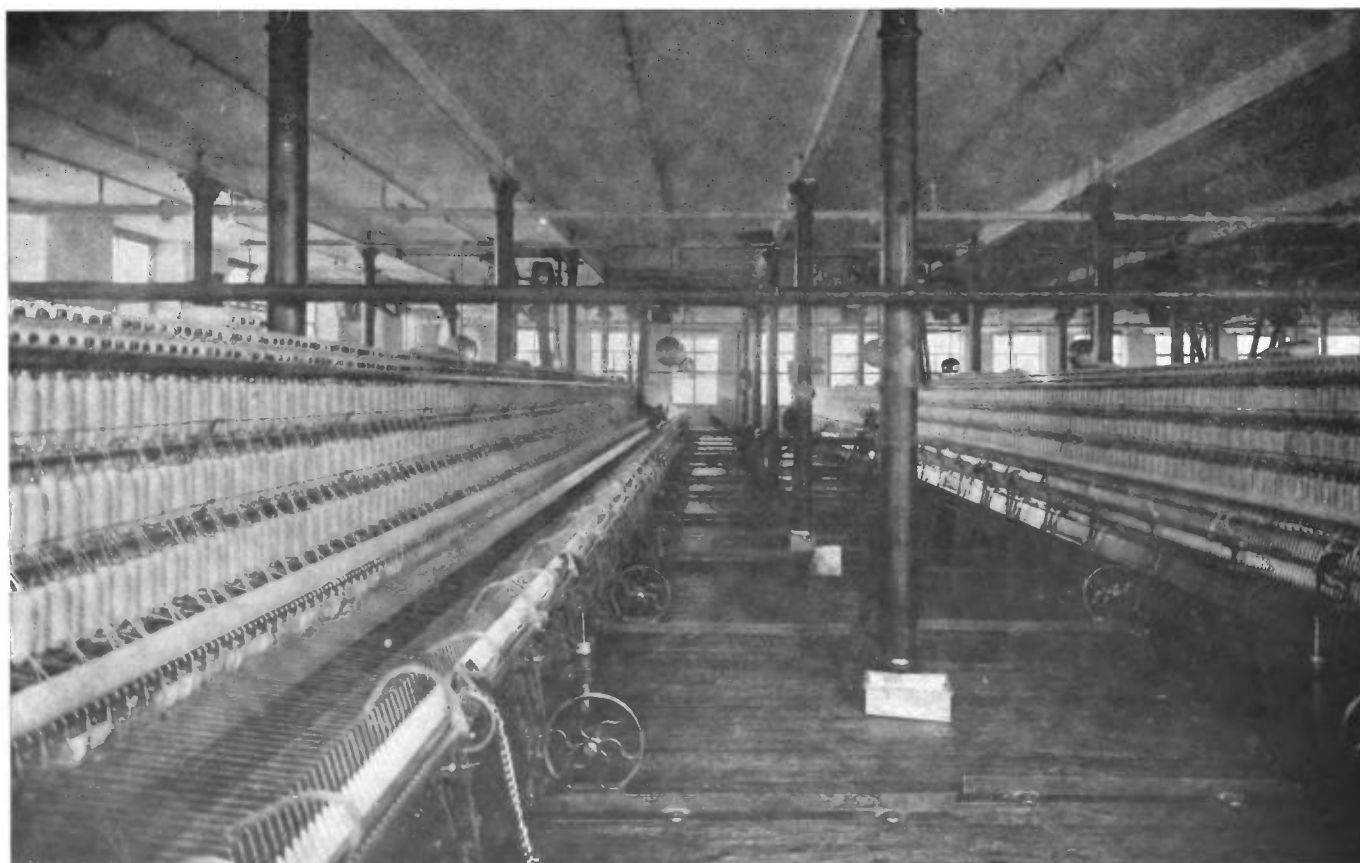

FIG. 13.—SPINNING-ROOM.

*(From Photographs taken in a Manchester Fine Cotton-spinning Mill, by R. Banks.)*

*American Cotton Industry* (1902); Uttley, *Cotton Spinning and Manufacturing in the United States of North America* (1905; a report of a tour as Gartside scholar of the university of Manchester); and the Gartside reports on the cotton industries of France and Germany by Forrester and Dehn respectively. Information will also be found in Diplomatic and Consular Reports, and fragments may be gathered from other books such as G. Drage's *Russian Affairs*, Dyer's *Dai Nippon*, and Huber's *Deutschland als Industriestaat*. Japan has published since 1901 a very full financial and economical annual, and the British government issues annually a good statistical abstract for India. The American census contains much detailed information, and there are, in addition to the statistics issued by the Federal government, those of Massachusetts, the Bureau of Statistics of which has also reported the results of an investigation into the industry in the Southern states. Among official matter the semi-official Bombay and Lancashire cotton spinning inquiry of the Manchester Chamber of Commerce may be included. The census of production of the United Kingdom must be mentioned, and the reports of the International Congresses of Cotton Spinners and Manufacturers. As to labour, see the reports of the International Textile Congresses.

The periodical literature is of good quality and much of it is filed in the Patent Office library. We may notice particularly the *Cotton Factory Times*; *Textile Journal*; *Textile Manufacturer*; *Textile Mercury*; *Textile Recorder*; *Textile World Record* (American); *Der Leipziger Monatschrift für Textilindustrie*; and the French *Textile Journal*. Shepperson's *Cotton Facts* is an annual which relates chiefly, though not entirely, to raw cotton, as does also *Cotton*, the periodical of the Manchester Cotton Association. For technical works we may refer here to the well-known treatises of Brooks, Guest, Marsden, Nasmith and Walmsley, and to Johanssen's ponderous two-volumed *Handbuch der Baumwollspinnerei, Rohweissweberei und Fabrikanlagen*. (S. J. C.)

**COTTON-SPINNING MACHINERY.** The earliest inventors of spinning machinery (see SPINNING) directed their energies chiefly to the improvement of the final stage of the operation, but no sooner were these machines put to practical use than it became apparent that success depended upon mechanically conducting the operations preliminary to spinning. Later inventors were, therefore, called upon not only to improve the inventions of their predecessors, but to devise machinery for preparing the fibres to be spun. Arkwright quickly perceived the importance of this aspect of the problem, and he devoted even more energy to it than

growers, for by the then existing methods of separating cotton lint from seed it would have been impossible to provide an adequate supply of raw material. By inventing the saw gin, Eli Whitney, an American, in the year 1792, did for cotton planters what Paul,

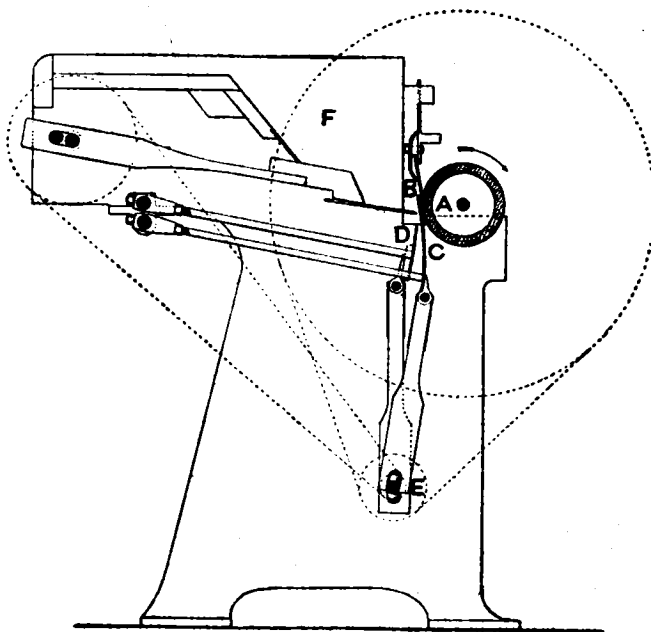

FIG. 2.

Arkwright, Crompton, Cartwright, Watt and others did for textile manufacturers, for he provided them with the means for increasing their output almost indefinitely.

*Cotton-ginning* is the process by which cotton seeds are separated from the adhering fibres. The most primitive machine employed in India and China for this purpose is the churka, which consists of two wooden rollers fixed in a frame and revolving in contact. Seed cotton is fed into these rollers and the fibres pass forward but the seeds remain behind. It is a device which does not injure the fibres, but no improvement has been found by which the churka can be converted into a sufficiently productive machine for modern requirements. In a modified form Whitney's saw gin is still used to clean a large portion of the annual crop of short and medium stapled cottons. It consists of from 60 to 70 saws (A, fig. 1), which are mounted upon a shaft and revolve between the interstices of an iron grid (B); against this grid the seed cotton is held whilst the fibres are drawn through, the seeds being left behind. The operation is as follows:— seed cotton is fed into the hopper (C), and conveyed by a lattice (D) to a spiked roller (E), which regulates the supply to the hopper (F). Whilst in (F) the cotton is engaged by the teeth of the saws (A), and drawn through the grid (B), but the bars are too close to permit the seeds to pass. A brush (G) strips the cotton lint from the saws, after which it is drawn through a flue (H) to the surface of a perforated roller (I) by pneumatic action; it then passes between (I) and (J) out of the machine. The Macarthy gin is the only other type in extensive use; it is employed to clean both long and short stapled cottons. In this gin the fibres are drawn by a leather-covered roller (A, fig. 2) over the edge of a stationary blade (B) called a doctor, which is fixed tangential to the roller. Two cranks (E) move two other blades (C, D) up and down immediately behind, and parallel to, the fixed blade (B). The

lint cotton is thrown into the hopper (F) and the fibres are drawn by the roller (A) until the seeds are against the edge of the doctor (B), when the beaters (C, D) strike them off, but permit the fibres to go forward with the roller. Attempts continue to be made so to improve both machines, that production may be increased,

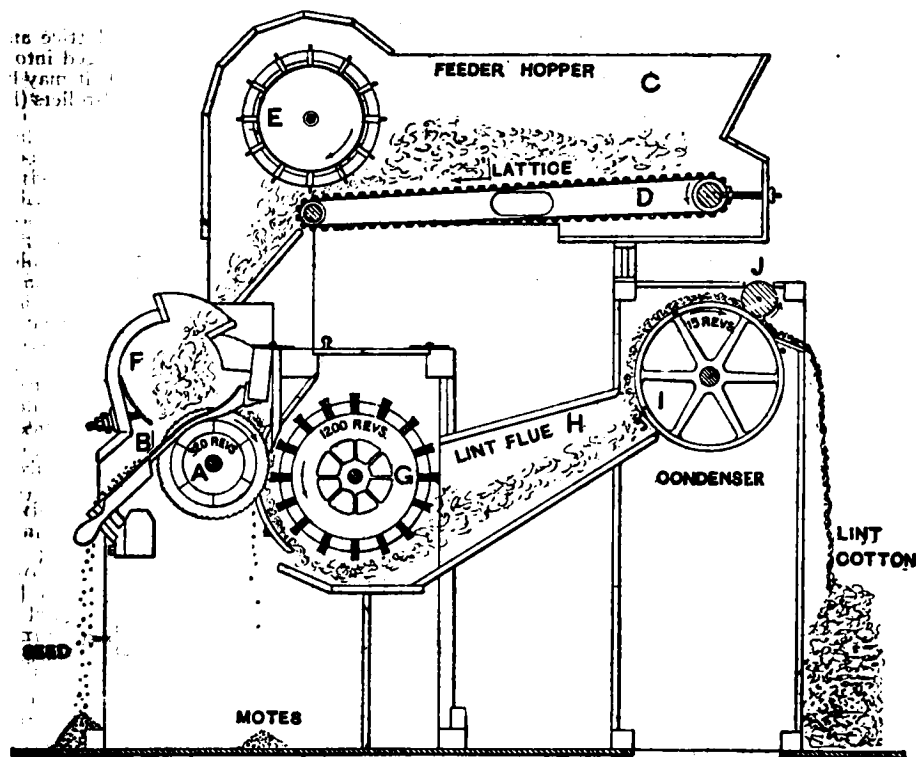

FIG. 1.

to the invention with which his name is more intimately associated. But, given a complete series of machines for preparing and spinning, the cotton industry (see COTTON MANUFACTURE) must have remained unprogressive without the co-operation of cotton

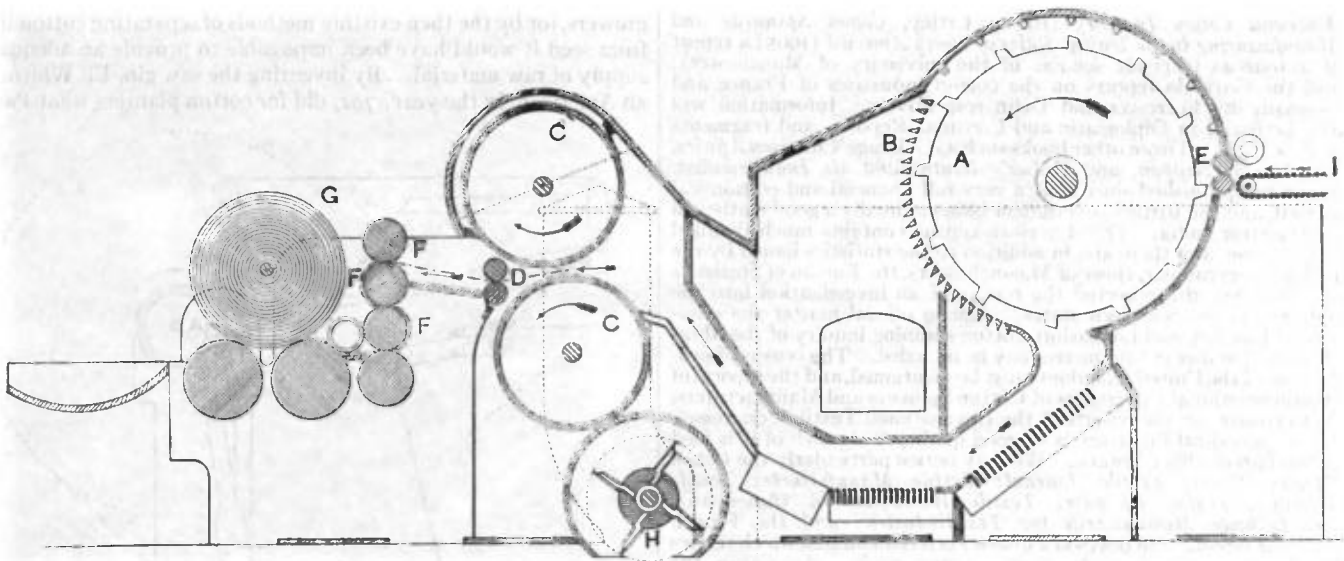

FIG. 3.

and labour charges, and the risks of injuring the fibres, reduced.

**Baling.**—As cotton leaves the gin, it is in some cases rolled, under compression, into cylindrical bales; but it is usually packed into rectangular bales, that vary in weight from 160 lb to 750 lb, by steam or hydraulic presses. After pressing, the cotton is covered with coarse jute bagging, and the whole secured by iron bands. In this form it arrives at the spinning mills.

In the mill treatment of cotton it soon became an established practice to divide the work into the following operations, namely (1) Mixing the fibres into a homogeneous mass; (2) removing impurities; (3) combing out entanglements in, and ranging the fibres in parallel lines; (4) simultaneous combination and attenuation of groups of parallel fibres; (5) completing the combination and attenuation, and twisting the fibres into a thread; (6) compounding, finishing and making-up of threads. These remain the essential conditions of cotton-spinning. The principal machines used to carry out the foregoing stages are: The bale breaker, opener and scutcher; the card and comber; the drawing, slubbing, intermediate and roving frames; ring and mule spinning; winding, doubling; clearing and gassing the reel, and bundling press, together with several auxiliary machines. All the operations included in this list are not

necessarily employed in the production of all kinds of yarn; low counts require fewer, and high counts more processes.

A *bale breaker* is used to disentangle fibres which have been, by hydraulic or steam presses, converted into hard masses that resist manual efforts to disentangle them. It may consist of three pairs of spiked and one pair of fluted rollers. If so, the matted cotton is fed into the first pair, seized by the second pair, which have a higher surface velocity, and pulled, while the third pair reduce the whole to a more or less fluffy mass, and the fluted rollers deliver it upon a travelling lattice by which it is conveyed to, and deposited upon, the floor of the mixing room. Instead of rollers, a *hopper breaker* may be used. In this machine the cotton is carried by a horizontal lattice into contact with a sloping spiked one, whose spikes tear away small tufts and deposit them upon a second lattice for removal to the mixing room. A stack of pulled cotton is formed by superposing thin layers from different bales, and when completed the cotton is drawn from top to bottom of the stack. By this means a thorough mixing of fibres is effected.

**The Opener.**—Mixed cotton may be thrown upon a lattice and conveyed to a spiked roller to be pulled, beaten, discharged into a trunk, and drawn by pneumatic force to the opener. Or it may be spread (fig. 3) upon a lattice (I), and carried between feed-rollers (E)

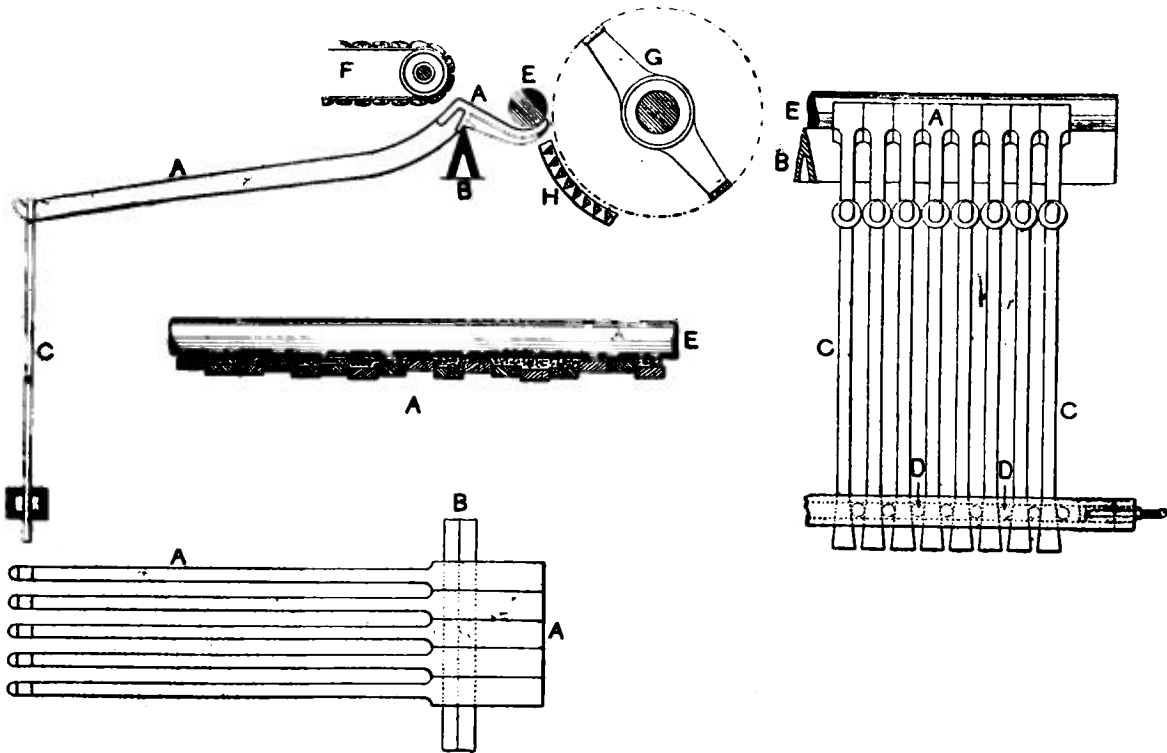

FIG. 4.



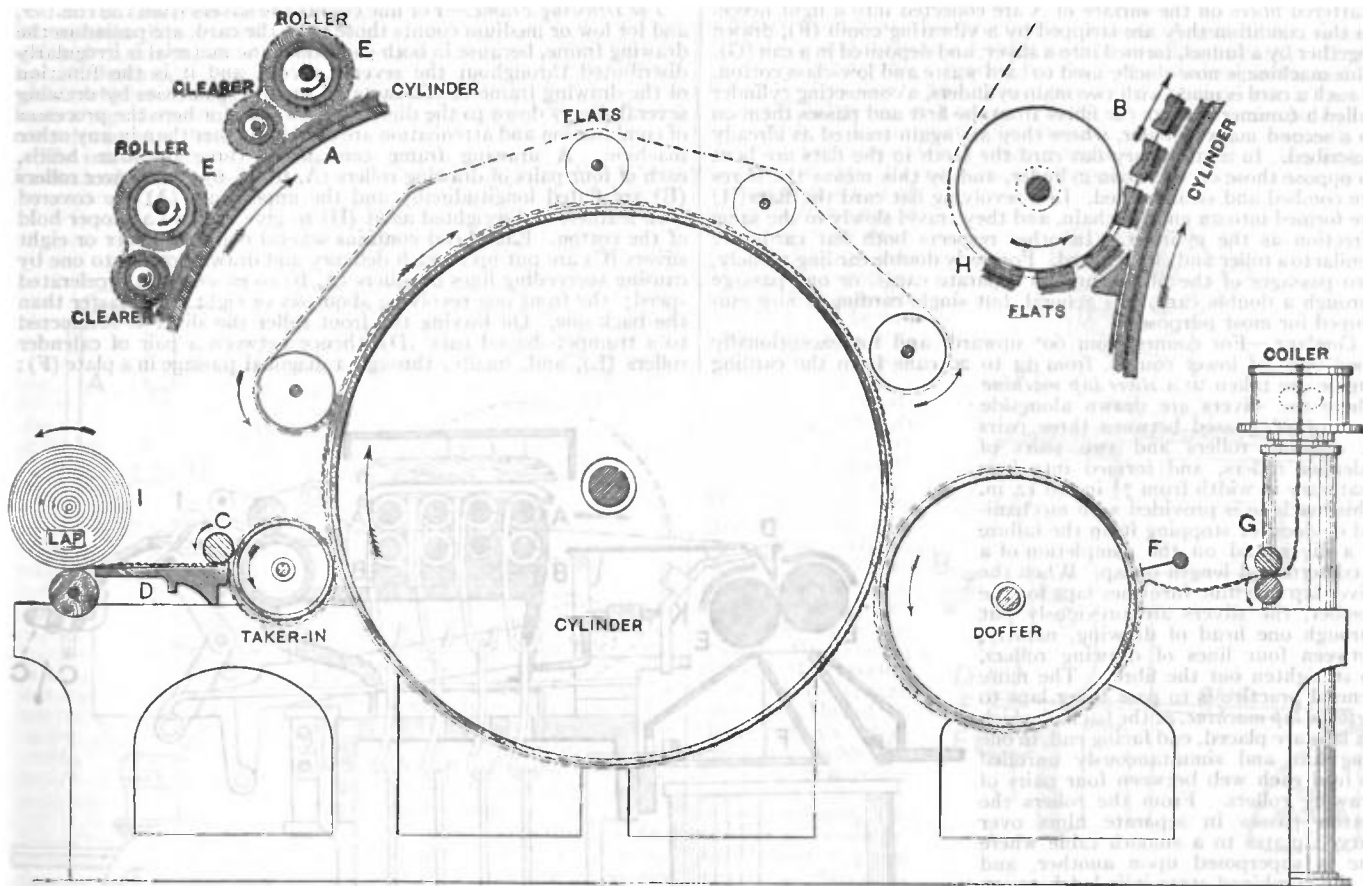

FIG. 5.

to be subjected to the action of a beater (A) whose teeth first seize tufts of cotton and then fling them upon a grid (B), to be subsequently seized by other teeth and again flung off until dirt and other impurities pass between the grating. The beater may be cylindrical (as at A) or in the form of a truncated cone; in either event, from four to twelve rows of teeth project from its surface. It is from 18 in. to upwards of 36 in. in diameter, approximately 40 in. wide, and the largest cylindrical beaters make from 300 to 700 revolutions; whilst conical beaters make about 1000, and small ones make from 1000 to 1500 revolutions per minute. The opened cotton is carried, in the direction indicated by the arrows, upon a strong blast of air which is generated by a fan (H), and this deposits it in patches upon the surfaces of two perforated zinc or wire cylinders (C), but dust and foreign particles pass through the interstices. As these cylinders revolve towards each other the cotton passes between them in the form of a sheet to a pair of feed-rollers (D), which may again deliver it to a beater with two or three blades; if so, from this beater the cotton is next borne on an air current to, and between, a second pair of perforated cylinders. In either event, the final cages (C, C) deliver the cotton to feed-rollers (D) and they pass it to calender-rollers (F), by which it is compressed into a sheet, and finally coiled into a lap (G). Various kinds of openers have been patented, all of which differ in some important respects; for example, a hopper feed may be substituted for the trunk or the lattice feed, in which event the cotton from the mixing room is conveyed mechanically upon lattices, and deposited in a hopper affixed to an opener. In this hopper a sloping spiked lattice elevates the cotton to an evening roller, whose office is to sweep back the surplus supply from the spikes, but allow the requisite quantity to pass forward to the beater. A regular supply of cotton to an opener is of great importance, and in order to insure it a table is often formed by substituting for the lower roller (E) a series of levers (A, fig. 4) all mounted upon a fulcrum (B), and having their free arms weighted by wedge-shaped pendants (C), that are separated by bowls (D). A fluted feed-roller (E) is fixed above this table and the cotton is led over the lever but beneath the roller. If the cotton is unequally distributed, thick places will press down the levers and thin ones will permit them to rise (as at A', E'). The rise of one pendant may be cancelled by the fall of another, but any balance of their movements is transmitted to a belt fork which governs a belt running upon a pair of inverted cones, and by this means the belt is traversed to and fro to drive the feed-roller (E) at a superior speed when the supply of cotton is insufficient, and at an inferior speed when the supply is excessive.

**The Scutcher.**—In many respects a scutcher resembles an opener; its function is to continue the cleaning and form laps of uniform

weight and density for the carding engine. Occasionally the scutcher is the first cleaning machine, in which event cotton, in a loose fleece, is spread evenly upon a lattice. But in order to carry the combination of fibres one stage further, three or four opener laps are generally placed upon the feeder, so that, as the laps unroll, three or four sheets of cotton will be superposed, and in this form are passed by the lattice (F, fig. 4) and the feed-roller (E) to either one or two beaters, which are furnished with two or three blades. The beater (G) flings the cotton against the bars of a grid (H) to loosen, and cause the dirt to pass between the bars, after which the cotton is carried forward upon an air current, in the same manner as in an opener, and formed into a lap. In case two scutchers are required, the laps from the first are fed into the second, where they are similarly treated; in both machines the lever and pendent mechanism furnishes the means by which uniformity is attained. A beater may consist of a straight, smooth blade (as at G), or of a blade provided with stout teeth; in the latter event the operation resembles combing rather than beating. Two-bladed beaters revolve from 1200 to 1500 times per minute; those with three blades from 900 to 1000 times per minute.

**Carding Engine.**—The functions of a card (see **CARDING**) are: to place the fibres parallel; to remove remaining impurities and immature fibres; and to form mature fibres into a porous band, called a sliver. A carding engine consists of three cylinders which are covered with cards; the first, or taker-in (see fig. 5), is the smallest; the second and largest is the main cylinder; and the third is the doffer. If the main cylinder is surmounted with a series of small ones (as at A), the engine is called a roller and clearer card. If a series of fixed strips of card are placed above the main cylinder, the engine is known as a stationary flat card. But if the strips move forward (as at B), it is a revolving flat card. In a roller and clearer card the small cylinders (E) are also covered with cards, but their teeth are bent to oppose those on the main cylinder, and they revolve with a different velocity. The taker-in is covered with saw teeth cut in a strip of steel which is fixed in the surface of that cylinder; it receives the cotton (I) from a feed-roller (C) that turns above a smooth iron table (D) called the feed plate, and strikes out the heaviest particles of remaining dirt. In passing through the fringe of lap, the teeth comb the attached fibres but deliver the loose ones to the main cylinder. The latter carries them into contact with the teeth on the rollers (E), by whose lower surface velocity combing is again effected. Short fibres become fixed amongst the teeth of (A) and (E), but those lying crosswise are transferred from (A) to (E) and from (E) to the clearer, which again presents them to the cylinder.

When long fibres are turned to point in the direction of rotation they advance upon the cylinder A to the doffer teeth, where the

scattered fibres on the surface of A are collected into a light fleece. In this condition they are stripped by a vibrating comb (F), drawn together by a funnel, formed into a sliver, and deposited in a can (G). This machine is now chiefly used to card waste and low-class cotton. If such a card is made with two main cylinders, a connecting cylinder called a tummer collects the fibres from the first and passes them on to a second main cylinder, where they are again treated as already described. In a stationary flat card the teeth in the flats are bent to oppose those on the main cylinder, and by this means the fibres are combed and straightened. In a revolving flat card the flats (H) are formed into an endless chain, and they travel slowly in the same direction as the cylinder. In other respects both flat cards are similar to a roller and clearer card. Formerly double carding, namely, two passages of the fibres through separate cards, or one passage through a double card, was general, but single carding is now employed for most purposes.

**Combing.**—For counts from 60<sup>+</sup> upward, and for exceptionally good yarn of lower counts, from 14 to 20 cans from the carding engine are taken to a *sliver lap machine* where the slivers are drawn alongside each other, passed between three pairs of drawing rollers and two pairs of calender rollers, and formed into laps that vary in width from 7½ in. to 12 in. This machine is provided with mechanical devices for stopping it on the failure of a sliver, and on the completion of a predetermined length of lap. When the sliver lap machine furnishes laps for the comber, the slivers are previously put through one head of drawing, namely, between four lines of drawing rollers, to straighten out the fibres. The more general practice is to pass sliver laps to a *ribbon lap machine*, at the back of which six laps are placed, end facing end, in one long line and simultaneously unrolled to feed each web between four pairs of drawing rollers. From the rollers the cotton passes in separate films over curved plates to a smooth table where one is superposed upon another, and in the combined state it is led between two pairs of calender rollers and formed into a lap from 7½ to 10½ in. wide. In the cotton industry the *Heilmann comber*, or some modification of that machine, is used to straighten thoroughly the fibres of carded cotton, to cast out all below a certain length, and leave only those that are perfectly clean and approximate to uniformity in length. For fine yarns of medium quality only part of the slivers required to form a thread are combed. But for fine yarns of good quality all slivers are once combed, and those for superfine yarns are twice, or "double combed." This machine is made with six or eight heads, each of which is supplied with a ribbon lap. One end of every lap is fed by a pair of rollers between the open jaws of a nipper which immediately closes upon the sheet of cotton, but a fringe is left protruding into the path of a cylinder, on whose periphery either one set of 17, or two sets of 13, graduated needle combs, and one, or two, fluted segments are secured. The first comb to reach the cotton may have as few as 16, and the last 90 teeth per inch. After the combs have passed successively through the overhanging fringe of fibres, the nipper opens and a fresh length of about ⅓ to ⅔ of an inch is fed in. Meanwhile, a fluted segment on the cylinder has moved up to support the fringe; a top comb, which was inoperative when the cylinder combs were acting, has descended into the fringe, and three rollers first return a portion of the material already combed so that it may overlap that last treated. The rollers then reverse the direction of their rotation; one of them and the segment engage the fringe, and draw the tail ends of all free fibres through the teeth of the top comb. The product of all the heads is next united, condensed, formed into a continuous sliver, and deposited in a can.

One cycle of movements, therefore, only combs from ⅓ to ⅔ of an inch of each fibre; the top comb deals with the tail ends, and the major portion of the work is done by the cylinder combs. The foregoing operations are repeated at the rate of from 85 to 90 times per minute, during which from 15% to upwards of 25% of carded material is removed; but this is capable of being spun into coarse yarns. A comber invented by John W. Nasmith is a modification of the foregoing. In his machine the cylinder combs act upon the forward ends of the fibres whilst under the control of the nipper, after which two pairs of rollers return a sufficient portion of the previously combed film to overlap, and to enable the front rollers to engage the fringe. The rollers then draw a part of the fringe through the teeth of the top comb, which, as a sequence, treats all but the forward ends of the fibres. Since one passage through the cylinder and top combs completes the operation for one set of fibres, this machine gives a higher production; it also gives a wider range of adaptability, and a lower percentage of waste than the Heilmann machine.

**The Drawing Frame.**—For fine counts the slivers from the comber, and for low or medium counts those from the card, are passed to the drawing frame, because in both conditions the material is irregularly distributed throughout the several slivers, and it is the function of the drawing frame to eliminate all such irregularities by drawing several slivers down to the dimensions of one, for here the processes of combination and attenuation are carried further than in any other machine. A drawing frame consists of three or four heads, each of four pairs of drawing rollers (A, B, fig. 6). The lower rollers (B) are fluted longitudinally and the upper ones (A) are covered with leather, and weighted as at (H) to give the two a proper hold of the cotton. Each head contains several deliveries. Six or eight slivers (C) are put up to each delivery and drawn down into one by causing succeeding lines of rollers (A, B) to move at an accelerated speed; the front one revolving about six or eight times faster than the back one. On leaving the front roller the sliver is conducted to a trumpet-shaped tube (D), thence between a pair of calender rollers (E), and, finally, through a diagonal passage in a plate (F);

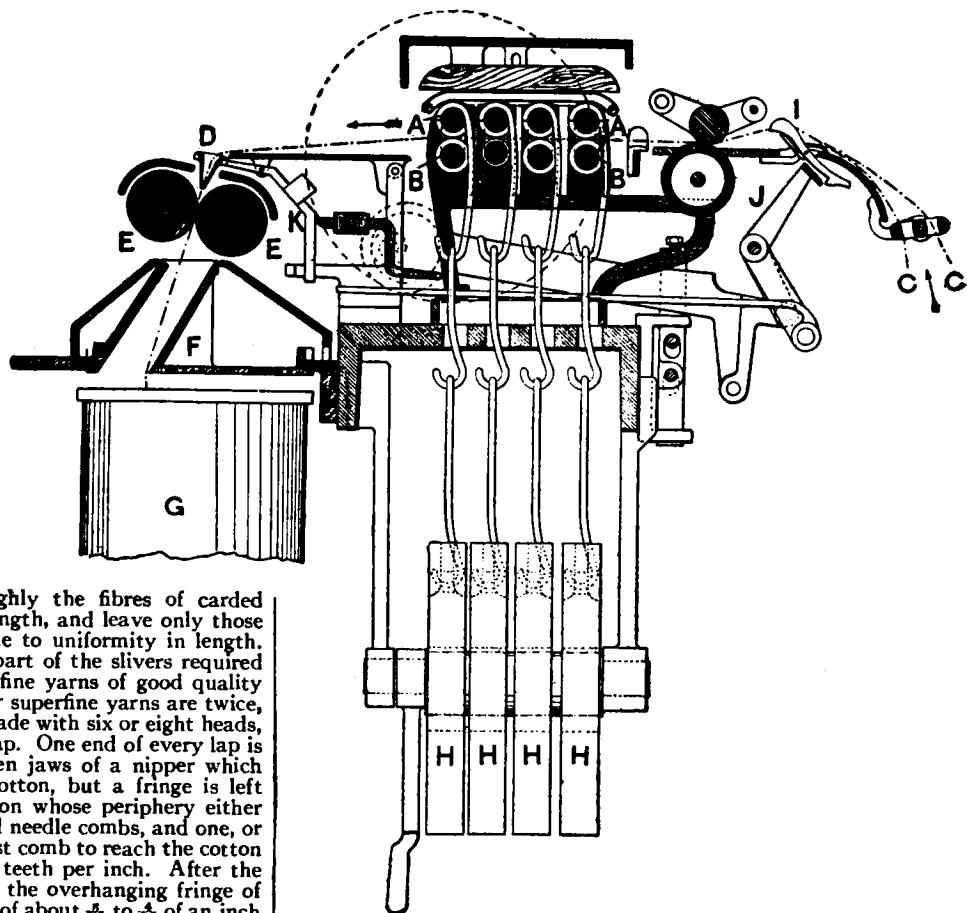

FIG. 6.

the latter coils the sliver into a rotating can (G). Back and front devices are provided to arrest motion in this machine when a sliver fails. At the back, each sliver passes over and depresses a separate spoon-shaped lever (I), thereby lifting the hooked lower end of (I) high enough to allow an arm (J) to vibrate. On the failure of a sliver the hook of (I) engages with (J) and dislocates the driving gear. In front, the trumpet-shaped tube (D) is mounted on a lever (K), and so long as a sliver presses down the mouth of (D), the machine continues in motion, but when a sliver fails, the lever (K) causes the driving gear to stop the machine. Six or eight cans containing once drawn slivers are put up to the second head and similarly drawn, and finally, a similar number of twice drawn slivers are fed into the third head and again drawn, giving in all  $6 \times 6 \times 6 = 216$  doublings; or  $8 \times 8 \times 8 = 512$  doublings. Occasionally four heads of drawings are used and eight slivers drawn into one, which gives  $8 \times 8 \times 8 \times 8 = 4096$  doublings; hence, irregularities in an original sliver have been minimized by successive combination and attenuation.

**Flyer Frames.**—Cotton in cans, from the final head of drawing, is transferred to the *slubbing frame*, by which it is attenuated, slightly twisted, and wound upon spools. Each sliver is drawn out by means of three pairs of rollers, and as it emerges from the front pair, a flyer (A, fig. 7), which revolves uniformly upon a spindle (B), carries the sliver (C) round with it to twist the fibres axially. This flyer coils the twisted material upon a wooden tube (D) in close-wound spirals and in successive layers. The tube is loosely mounted upon,

but driven independently of, the spindle, in order that as the tube increases in diameter the number of revolutions it makes may be reduced to suit the constant delivery of the roving. This is effected by a differential motion which usually consists of a large wheel, within which two other wheels are made to work; the interior wheels have a regular motion, but the large wheel is driven from a pair of cone drums at a decreasing speed.

The *intermediate frame* comes between the slubbing and roving frames and is of similar construction to the slubber, but has a larger number of spindles and smaller tubes. Instead of having cans put at the back, the slubbing tubes are mounted vertically in a creel, passed in pairs through the rollers, and drawn down to a smaller diameter than a single slubbing. In this machine, therefore, the fourfold processes of combination, attenuation, twisting and winding are effected consecutively and continuously.

The *roving frame* is similar in principle to the slubber and intermediate machines, but it contains a greater number of spindles, and the tubes are smaller than either. It receives the rovings from the intermediate frame, draws two into one, twists them and winds them upon tubes. This machine is usually the last employed to prepare cotton for spinning, but for spinning fine yarns from the best Egyptian and Sea Islands cottons, a second roving, or *Jack frame* may be required, in which event pairs of rovings from the first machine are similarly treated in the second in order to render the final product sufficiently fine for spinning yarns of the requisite counts.

*Spinning* (see SPINNING).—Improvements upon the Saxony wheel caused continuous spinning to become a mechanical art at an earlier date than intermittent spinning. Arkwright's water-twist frame was gradually changed to the *throstle*, which was a duplex machine furnished with one set of drawing rollers, and one set of spindles and flyers at each side of the frame-work. All the bosses of one line of rollers were connected so that one driving gear would serve for the whole length, and all the spindles

were driven by bands from a central cylinder. The roving spools were placed vertically in a creel between the two sets of rollers, and the rovings reduced to the requisite fineness by the latter; after which each was passed through a coiled eye at the lower end of a flyer leg, and attached to a double-flanged spool which was loosely mounted upon a spindle. At each revolution of a flyer a twist was put into the attenuated roving, and the flyer wrapped as much thread upon a spool as the rollers delivered. The spools rested upon a piece of woollen cloth stretched over a rail, and this rail rose and fell through a space equal to the length of the spool barrel. On account of a thread having to pull a spool round, it was not possible to spin finer counts than 60<sup>s</sup>, and since each flyer was mounted upon the top of an unsupported spindle, vibration increased with speed. In order to avoid such vibration Mr Danforth, in or about 1829, placed an inverted cup upon the top of a stationary spindle, and upon the spindle a freely fitting sleeve and wharve; the former to receive a spool, the latter to rotate both. By a traverse motion all the spools were simultaneously raised or depressed, so as to have their barrels, when at the highest point, entirely within the cup, and when at the lowest entirely below it. A thread passed from the drawing rollers, outside the cup, to a spool. As a spool rotated its thread was uniformly twisted, the lower edge of the cup built the yarn equally on every part of the spool barrel, and the requisite drag resulted from friction set up by the thread rubbing against the surface of the cup. The throstle has almost disappeared from the cotton industry, and Danforth's cap frame entirely so, but the latter is still used to spin worsted.

*Ring spinning* is practically the only system of continuous spinning used in the cotton industry; it was first patented in the United States of America by J. Thorpe, in 1828, and in that country was extensively used long before it became established in England. Its chief feature consists in the substitution for the flyer, or the cap, of a smooth annular ring (A, fig. 8) formed with a flange at the upper edge, over which a light C-shaped piece of wire (B), called a traveller, is sprung. The rings are secured in a rail (C) that rises quickly and falls slowly, but at each succeeding ascent and descent it attains

a higher point than that previously reached. A spindle (D) is supported by, and turns in a bolster secured to a fixed rail (E). If the bolster only provides a bearing for the centre of the spindle, and so leaves the foot free to find its own position of steadiness, it is known as a self-balancing or gravity spindle. A recess in the bolster is filled with oil to automatically lubricate the bearing. A spindle is placed in the centre of each ring; it has a sleeve fitted upon it which carries a wharve (F) that covers the upper part of the bolster, and

a band from a pair of drums is drawn round the wharve to drive the spindle. So perfect is the construction of these spindles that they can be run without appreciable vibration at speeds far beyond the ability of operatives to attend them; although a speed of 11,000 revolutions per minute is a practicable one. After passing the drawing rollers (G), the roving (H) is twisted into the traveller (B), and made fast to a spool (I) placed upon the spindle. As spinning proceeds the traveller is pulled round the ring by the thread; it thus puts a drag upon, and holds the thread at the winding point. In all continuous spinning the number of twists inserted into a given length of thread is governed by the surface speed of the front roller, relatively to the revolutions of the flyer, or to the speed of the winding surface.

*Intermittent Spinning.*—The essential difference between continuous and intermittent spinning is that the former draws and twists consecutively, whilst the latter draws and twists simultaneously. In the *mule*, a creel (A, fig. 9), fixed at the back of the machine, is designed to hold the rovings (B) in three or four tiers, from whence they pass between three lines of drawing rollers (C) and two faller wires (D). They are next led to spindles (E) mounted in a carriage (F) whose wheels run upon rails (G) called slips. As the rollers (C) feed the partially attenuated rovings the carriage recedes from the rollers a little faster than the rovings are delivered, thus completing the attenuation. Meanwhile, the spindles are revolved rapidly by bands passing from a tinned cylinder (H) and the threads are twisted. This twist goes first to the thin places where least resistance is offered to it, leaving thick places almost untwisted; the pull of the carriage, therefore, causes the fibres to slip most readily where there are fewest twists, and gives to a thread an approximation to uniformity in diameter. For fine yarns the rollers cease to rotate slightly before the carriage has attained the end of its outward run, or stretch, and at such times all attenuation is due to the pull of the spindles upon the threads. On the termination of a stretch the carriage stops, the twisting is completed, the spindles reverse the direction of their rotation to back off, or remove the yarn which is coiled round the spindles above the winding point, and whilst one faller wire (D), operating on all the threads at once, descends to the winding position of each spindle, the other rises to take up the yarn delivered by the spindles. This completed, the carriage returns to the roller beam, and in doing so the spindles revolve in their normal direction to wind the stretch of 48 to 66 in. of yarn spun in the outward journey. All the foregoing movements are regulated to succeed each other in their proper order, the termination of one operation being the initiation of the next.

Crompton's original machine was controlled manually throughout, but later he devised means for moving the carriage out mechanically, for stopping the rollers at the proper time, and for locking the carriage whilst the spindles added the final twist to the threads. After which all parts became stationary and the manual operations commenced. These consisted in backing off, operating the faller wire, rotating the spindles and pushing the carriage home. In the year 1785 the first steam-engine was employed for cotton spinning, and in 1792 William Kelly placed the headstock of a mule, in which the chief mechanism is situated, in the middle of the carriage, instead of at one end. By this device one machine was doubled in length, and shortly afterwards two mules, each of 300 to 400 spindles, were allotted to one spinner and his assistants. Kelly also attempted to control all parts of the machine mechanically, but in

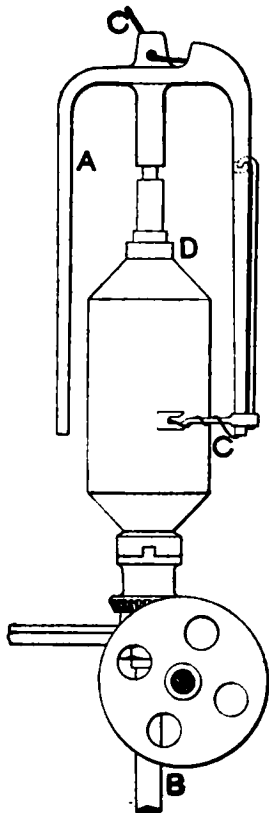

FIG. 7.

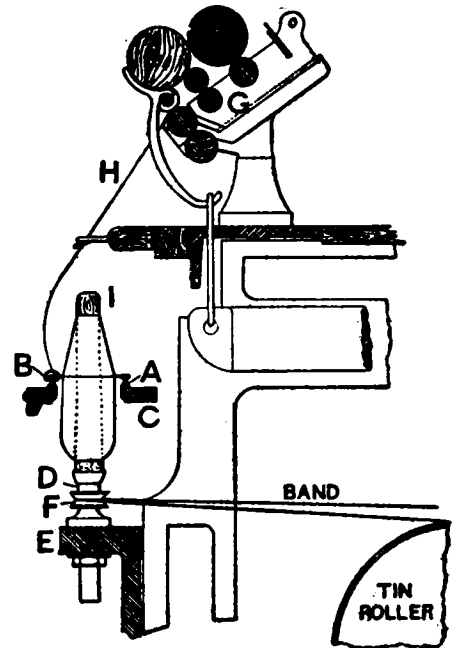

FIG. 8.

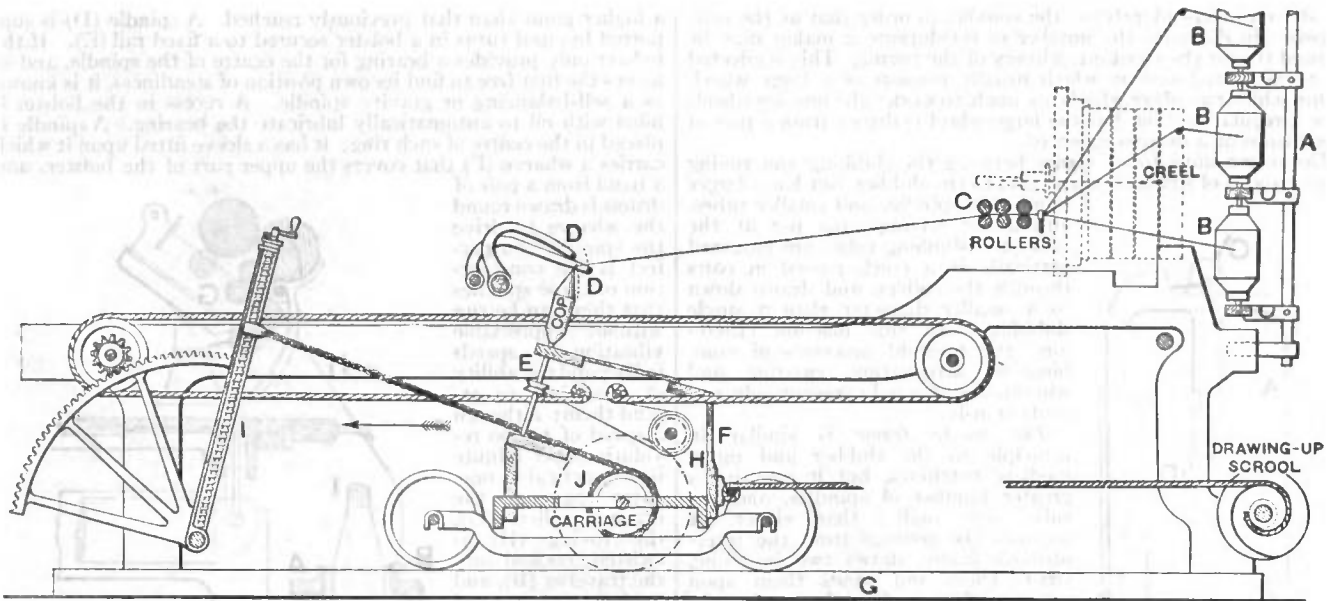

FIG. 9.

this he failed, as did Eaton, Smith and many others, although each contributed something towards the solution of the problems involved in automatic spinning. Eventually the hand mule became a machine in which most of the work was done automatically; the spinner being chiefly required to regulate the velocity of the backing off, and the inward run of the carriage, and to actuate the fallers. As a result of these alterations the machine was made almost double the length of Kelly's. In this state many mules continued to be used until the last decade of the 19th century, and a few are still in use. Between the years 1824 and 1830 Richard Roberts invented mechanism that rendered all parts of the mule self-acting, the chief parts of which are shown at (I, J), and they regulate the rotation of the spindles during the inward run of the carriage. At first his machine was only used to spin coarse and low-medium counts, but it is now employed to spin all counts of yarn. Although numerous changes have since been made in the self-acting mule, the machine still bears indelible marks of the genius of Roberts.

For many purposes the threads as spun by the ring frame or the mule are ready for the manufacturer; but where extra strength or smoothness is required, as in threads for sewing, crocheting, hosiery, lace and carpets; also where multicoloured effects are needed, as in Grandrelle, or some special form of irregularity, as in corkscrewed, and knopped yarns, two or more single threads are compounded and twisted together. This operation is known as doubling. In order to prepare threads for doubling it may be necessary to wind side by side upon a flanged bobbin, or upon a straight or a tapering spool, from two to six threads before twisting them into one.

**Winding machines** for this purpose are of various kinds. There are those in which the threads are laid evenly between the flanges of a bobbin, and those that coil the threads upon a straight or a tapering tube to form "cheeses." In the latter the tubes may be laid upon diagonally split drums and rotated by frictional contact. By placing each group of threads to be wound in the slit of a rotating drum, it is drawn quickly to and fro and coiled upon a spool. If solid instead of split drums be used, the guides for all the threads on one side of a machine are attached to a bar, which is traversed by a cam placed at one end of the frame. Or independent mechanism may be provided throughout for treating each group of threads to be wound. The bobbins or tubes may be filled from cops, ring spools or hanks, but a stop motion is required for each thread, which will come into operation immediately a fracture occurs.

**Doublers.**—In action doublers are continuous and intermittent. The former resemble throstle and ring spinning machines, but since they do not attenuate the material, only one line of rollers is provided. The folded material is placed in a creel and led through the rollers to the spindles to be twisted in a wet or dry condition. If wet, the moisture flattens down most of the protruding ends of the fibres and produces a comparatively smooth thread; if dry, the doubled yarn retains some of its furry character. There are two types of continuous doublers, which are known respectively as English and Scotch. By the English system of dry doubling the yarn from the creel may be treated, on its way to the spindle, in various ways to obtain the desired tension. It may be led under a rod, over a guide, round and between the rollers, and round a glass peg. For wet doubling, a trough containing water is placed behind the rollers, and the yarn passes beneath a glass rod in the water, thence over a guide, beneath, between and over the rollers to the spindles. By the Scotch system the trough is placed below the

rollers, and the bottom roller is partly immersed in water. It is claimed that this system wets the fibres more thoroughly than the English one. For the purpose of twisting the strands together the spindles may be provided either with flyers, as in throstle spinning, or with rings and travellers, as in ring spinning. The twist is generally in the opposite direction to that in the single threads. When more than three strands are required in a compound thread it is customary to pass the material more than once through the doubler, as, for example, in a sixfold thread, two strands may be first twisted together in the same or in the opposite direction to the spinning twist; after which the once-doubled thread is "cleared," folded, and three strands of twofold yarn are twisted in the opposite direction to that employed in the first operation. In some machines folding and twisting proceed simultaneously, and some are furnished with an automatic stop motion. But when twisting two threads together to oppose the spinning twist, the failure of one causes the other to untwist and break, therefore, under such circumstances a stop motion is unnecessary.

Intermittent doublers are known as twinners, and these are of two kinds, namely, English and French. In the former the spindles are fitted in a stationary rail, but the creel, containing the cops or ring spools, is mounted upon a carriage and moves in and out, as in Hargreaves' spinning jenny (see SPINNING). French twinners have a stationary creel, and the spindles move in and out with the carriage, as in the spinning mule. The material to be folded is often subjected to the action of steam in order to render it less resilient, after which it is mounted upon skewers in the creel, and two or three threads are passed to each spindle to be twisted together and formed into a cop. Between the creel and the spindles all the strands are kept equally tense by drawing them over flannel-covered boards and under porcelain weights. For wet doubling, the strands pass through a trough containing water, and the flannel surfaces are also wet.

**Clearing.**—After the first, or the final, doubling it is often necessary to remove lumps, imperfect knots and loose fibres from a thread. This is accomplished by passing each through a slit, or clearer, whose width is adjusted to the diameter of the thread to be treated. By this means anything which gives a thread abnormal bulk will be prevented from passing the slit. Once through the slit, a thread is coiled upon a friction-driven, double or single-headed bobbin. If the former, the coils are evenly laid; if the latter, they are disposed into a bottle shape. Or, again, cheeses may be wound.

**Gassing.**—In cases where a thread with a smooth surface is required the extending ends of fibres must be burned off. Thus: each thread from a creel is drawn over a tension rod to two freely mounted pulleys, having parallel grooves cut in their surfaces and axes in the same horizontal plane. After bending a thread forward and backward in the grooves of both pulleys, it passes through a Bunsen flame and is coiled upon a tube, which is held against the face of a rotating drum, while a vibrating guide distributes the thread across the tube. The gas-burner is situated midway between the grooved pulleys, and so mounted beneath the thread that it will automatically swivel sideways and thus move the flame away from a stationary thread. Winding begins slightly before the flame moves beneath a thread, and the rapid motion of the latter permits the flame to burn off undesirable matters without injuring the thread.

**Reeling.**—Doubled or gassed yarn may be wound upon warpers' bobbins and made into warps for the loom, or it may be reeled into

hanks for the preparing and finishing processes. But a reel hanks yarns for bleaching, dyeing, printing, polishing and bundling, and is adapted for cops, ring spools, doubling bobbins or cheeses. From cops, ring spools and cheeses the yarn is usually drawn over one end, but flanged bobbins are mounted upon spindles and the yarn is drawn from the side. A reel has a circumference of 54 in., and after making 80 or 560 revolutions it automatically stops; the first gives a lea of 120 yds. and the last a hank of 840 yds. For grant reeling, however, a hank may be from 5000 to 10,000 yds. long. Reeling is of two kinds, namely, open and crossed. Open reeling forms leas, and seven of these are united in one hank by a lease band which retains the divisions. In cross reeling a thread is traversed over a portion of the reel surface by a reciprocating guide to form a hank without divisions. On the completion of a set of hanks the reel is made to collapse and thus facilitate the removal of the yarn.

**Bundling Press.**—Hanks are made into short or long bundles, each weighing 5 or 10 lb. In short bundles it is usual to form groups of ten hanks, and these are twisted together, folded and compressed into bundles; but in long bundles the hanks are compressed without being folded. A press consists of a strong table upon which a box, with open ends, is formed. The bottom of this box is grooved transversely and made to rise and fall by wheel gearing or by eccentrics. The sides and top are made of vertical and horizontal bars, set to coincide with the grooves in the bottom. To one set of vertical bars a similar number of horizontal top pieces are hinged, and to the other set levers are jointed, which hold the horizontal bars in position. When the hinged bars are turned up, strings are drawn through the grooves, and the bottom is covered with stout paper. The hanks are then laid in the box, another paper is placed above them, and the hinged bars are drawn down and locked. The bottom then rises a predetermined distance, and automatically stops. While in this position the strings are tied, the bottom of the press next descends, and the bundle is removed. (T. W. F.)

**COTYS**, a name common to several kings of Thrace. The most important of them, a cruel and drunken tyrant, who began to reign in 382 B.C., was involved with the Athenians in a dispute for the possession of the Thracian Chersonese. In this he was assisted by the Athenian Iphicrates, to whom he had given his daughter in marriage. On the revolt of Ariobarzanes from Persia, Cotys opposed him and his ally, the Athenians. In 358 he was murdered by the sons of a man whom he had wronged.

See Cornelius Nepos, *Iphicrates*, *Timotheus*; Xenophon, *Agésilas*; Demosthenes, *Contra Aristocratem*; Theopompus in Müller, *Fragmenta Historicorum Graecorum*, i.

**COUCH, DARIUS NASH** (1822–1897), American soldier, was born at South East, Putnam county, N.Y., on the 23rd of July 1822, and graduated from West Point in 1846, serving in the Mexican war and in the war against the Seminole Indians. He left the army in 1855, but soon after the outbreak of the civil war he was made a brigadier-general U.S.V. He served as a divisional commander in the battles of the Army of the Potomac in 1862, and at Fredericksburg (December 1862) and Chancellorsville (May 1863) he commanded the II. corps. He had been made a major-general U.S.V. in July 1862. During the Gettysburg campaign he was employed in organizing the Pennsylvania militia, and he subsequently served in the West, taking part in the battle of Nashville, and in the final operations in the Carolinas. He left the army after the war. General Couch died on the 12th of February 1897 at Norwalk, Connecticut.

**COUCY, LE CHÂTELAIN DE**, French *trouvère* of the 12th century. He is probably the Guy de Couci who was castellan of the castle of that name from 1186 to 1203. Some twenty-six songs are attributed to him, and about fifteen or sixteen are undoubtedly authentic. They are modelled very closely on Provençal originals, but are saved from the category of mere imitations by a grace and simplicity peculiar to the author. The legend of the love of the Châtelain de Coucy and the Lady of Fayel, in which there figures a jealous husband who makes his wife eat the heart of her lover, has no historical basis, and dates from a late 13th century romance by Jakemon Sakesep. It is worth noting that the story, which seems to be Breton in origin, has been also told of a Provençal troubadour, Guilhem de Cabestaing, and of the minnesinger Reinmar von Brennenberg. Pierre de Belloy, who wrote some account of the family of Couci, made the story the subject of his tragedy *Gabrielle de Vergy*.

The songs of the Châtelain de Coucy were edited by Fritz Fath

(Heidelberg, 1883). For the romance see Gaston Paris, in the *Hist. litt. de la France* (vol. 28, pp. 352-360). An exquisite song, "Chanterai por mon courage," expressing a woman's regrets for her lover at the Crusade, is attributed in one MS., probably erroneously, to the Lady of Fayel (*Hist. litt.* xxiii, 556). An English metrical romance of "The Knight of Curtesy," and the "Fair Lady of Faguell," was printed by William Copland, and reprinted in Ritson's *Eng. Metrical Romances* (ed. E. Goldsmid, vol. iii., 1885).

**COUCY-LE-CHÂTEAU**, a village of northern France, in the department of Aisne, 18 m. W.S.W. of Laon on a branch of the Northern railway. Pop. (1906) 663. It has extensive remains of fortifications of the 13th century, the most remarkable feature of which is the Porte de Laon, a gateway flanked by massive towers and surmounted by a fine apartment. Coucy also has a church of the 15th century, preserving a façade in the Romanesque style. The importance of the place is due, however, to the magnificent ruins of a feudal fortress (see CASTLE) crowning the eminence on the slope of which the village is built. The remains, which embrace an area of more than 10,000 sq. yds., form an irregular quadrilateral built round a court-yard and flanked by four huge towers. The nucleus of the stronghold is a donjon over 200 ft. high and over 100 ft. in diameter, standing on the south side of the court. Three large vaulted apartments, one above the other, occupy its interior. The court-yard was surrounded on the ground-floor by storehouses, kitchens, &c., above which on the west and north sides were the great halls known as the *Salle des preux* and the *Salle des preuses*. A chapel projected from the west wing. The bailey or base-court containing other buildings and covering three times the area of the château extended between it and the village. The architectural unity of the fortress is due to the rapidity of its construction, which took place between 1230 and 1242, under Enguerrand III., lord of Coucy. A large part of the buildings was restored or enlarged at the end of the 14th century by Louis d'Orléans, brother of Charles VI., by whom it had been purchased. The place was dismantled in 1652 by order of Cardinal Mazarin. It is now state property. In 1856 researches were carried on upon the spot by Viollet-le-Duc, and measures for the preservation of the ruins were subsequently undertaken.

**Sires de Coucy.**—Coucy gave its name to the sires de Coucy, a feudal house famous in the history of France. The founder of the family was Enguerrand de Boves, a warlike lord, who, at the end of the 11th century seized the castle of Coucy by force. Towards the close of his life, he had to fight against his own son, Thomas de Marle, who in 1115 succeeded him, subsequently becoming notorious for his deeds of violence in the struggles between the communes of Laon and Amiens. He was subdued by King Louis VI. in 1117, but his son Enguerrand II. continued the struggle against the king. Enguerrand III., the Great, fought at Bouvines under Philip Augustus (1214), but later he was accused of aiming at the crown of France, and he took part in the disturbances which arose during the regency of Blanche of Castile. These early lords of Coucy remained till the 14th century in possession of the land from which they took their name. Enguerrand IV., sire de Coucy, died in 1320 without issue and was succeeded by his nephew Enguerrand, son of Arnold, count of Guines, and Alix de Coucy, from whom is descended the second line of the house of Coucy. Enguerrand VI. had his lands ravaged by the English in 1339 and died at Crécy in 1346. Enguerrand VII., sire de Coucy, count of Soissons and Marle, and chief butler of France, was sent as a hostage to England, where he married Isabel, the eldest daughter of King Edward III. Wishing to remain neutral in the struggle between England and France, he went to fight in Italy. Having made claims upon the domains of the house of Austria, from which he was descended through his mother, he was defeated in battle (1375-1376). He was entrusted with various diplomatic negotiations, and took part in the crusade of Hungary against the Sultan Bayezid, during which he was taken prisoner, and died shortly after the battle of Nicopolis (1397). His daughter Marie sold the fief of Coucy to Louis, duke of Orleans, in 1400. The Châtelain de Coucy (see above) did not belong to the house of the lords of Coucy, but was castellan of the castle of that name.



**COUES, ELLIOTT** (1842-1899), American naturalist, was born at Portsmouth, New Hampshire, on the 9th of September 1842. He graduated at Columbian (now George Washington) University, Washington, D.C., in 1861, and at the Medical school of that institution in 1863. He served as a medical cadet at Washington in 1862-1863, and in 1864 was appointed assistant-surgeon in the regular army. In 1872 he published his *Key to North American Birds*, which, revised and rewritten in 1884 and 1901, has done much to promote the systematic study of ornithology in America. In 1873-1876 Coues was attached as surgeon and naturalist to the United States Northern Boundary Commission, and in 1876-1880 was secretary and naturalist to the United States Geological and Geographical Survey of the Territories, the publications of which he edited. He was lecturer on anatomy in the medical school of the Columbian University in 1877-1882, and professor of anatomy there in 1882-1887. He resigned from the army in 1881 to devote himself entirely to scientific research. He was a founder of the American Ornithologists' Union, and edited its organ, *The Auk*, and several other ornithological periodicals. He died at Baltimore, Maryland, on the 25th of December 1899. In addition to ornithology he did valuable work in mammalogy; his book *Fur-Bearing Animals* (1877) being distinguished by the accuracy and completeness of its description of species, several of which are already becoming rare. In 1887 he became president of the Esoteric Theosophical Society of America. Among the most important of his publications, in several of which he had collaboration, are *A Field Ornithology* (1874); *Birds of the North-west* (1874); *Monographs on North American Rodentia*, with J. A. Allen (1877); *Birds of the Colorado Valley* (1878); *A Bibliography of Ornithology* (1878-1880, incomplete); *New England Bird Life* (1881); *A Dictionary and Check List of North American Birds* (1882); *Biogen, A Speculation on the Origin and Motive of Life* (1884); *The Daemon of Darwin* (1884); *Can Matter Think?* (1886); and *Neuro-Myology* (1887). He also contributed numerous articles to the *Century Dictionary*, wrote for various encyclopaedias, and edited the *Journals of Lewis and Clark* (1893), and *The Travels of Zebulon M. Pike* (1895).

**COULISSE** (French for "groove," from *couler*, to slide), a term for a groove in which a gate of a sluice, or the side-scenes in a theatre, slide up and down, hence applied to the space on the stage between the wings, and generally to that part of the theatre "behind the scenes" and out of view of the public. It is also a term of the Paris Bourse, derived from a *coulisse*, or passage in which transactions were carried on without the authorized *agents de change*. The name *coulissier* was thus given to unauthorized *agents de change*, or "outside brokers" who, after many attempts at suppression, were finally given a recognized status in 1901. They bring business to the *agents de change*, and act as intermediaries between them and other parties. (See STOCK EXCHANGE: *Paris*.)

**COULOMB, CHARLES AUGUSTIN** (1736-1806), French natural philosopher, was born at Angoulême on the 14th of June 1736. He chose the profession of military engineer, spent three years, to the decided injury of his health, at Fort Bourbon, Martinique, and was employed on his return at Rochelle, the Isle of Aix and Cherbourg. In 1781 he was stationed permanently at Paris, but on the outbreak of the Revolution in 1789 he resigned his appointment as *intendant des eaux et fontaines*, and retired to a small estate which he possessed at Blois. He was recalled to Paris for a time in order to take part in the new determination of weights and measures, which had been decreed by the Revolutionary government. Of the National Institute he was one of the first members; and he was appointed inspector of public instruction in 1802. But his health was already very feeble, and four years later he died at Paris on the 23rd of August 1806. Coulomb is distinguished in the history alike of mechanics and of electricity and magnetism. In 1779 he published an important investigation of the laws of friction (*Théorie des machines simples, en ayant regard au frottement de leurs parties et à la roideur des cordages*), which was followed twenty years later by a memoir on fluid resistance. In 1785 appeared his *Recherches théoriques et expérimentales sur la force de torsion et sur l'élasticité*

*des fils de métal*, &c. This memoir contained a description of different forms of his torsion balance, an instrument used by him with great success for the experimental investigation of the distribution of electricity on surfaces and of the laws of electrical and magnetic action, of the mathematical theory of which he may also be regarded as the founder. The practical unit of quantity of electricity, the *coulomb*, is named after him.

**COULOMMIERS**, a town of northern France, capital of an *arrondissement* in the department of Seine-et-Marne, 45 m. E. of Paris by rail. Pop. (1906) 5217. It is situated in the fertile district of Brie, in a valley watered by the Grand-Morin. The church of St Denis (13th and 16th centuries), and the ruins of a castle built by Catherine of Gonzaga, duchess of Longueville, in the early 17th century, are of little importance. There is a statue to Commandant Beaurepaire, who, in 1792, killed himself rather than surrender Verdun to the Prussians. Coulommiers is the seat of a subprefect, and has a tribunal of first instance and a communal college. Printing is the chief industry, tanning, flour-milling and sugar-making being also carried on. Trade is in agricultural products, and especially in cheeses named after the town.

**COUMARIN**,  $C_9H_6O_2$ , a substance which occurs naturally in sweet woodruff (*Asperula odorata*), in the tonka bean and in yellow melilot (*Melilotus officinalis*). It can be obtained from the tonka bean by extraction with alcohol. It is prepared artificially by heating aceto-ortho-coumaric acid (which is formed from sodium salicyl aldehyde) or from the action of acetic anhydride and sodium acetate on salicyl aldehyde (Sir W. H. Perkin, *Berichte*, 1875, 8, p. 1599). It can also be prepared by heating a mixture of phenol and malic acid with sulphuric acid, or by passing bromine vapour at  $107^\circ C.$  over the anhydride of melilotic acid. It forms rhombic crystals (from ether) melting at  $67^\circ C.$  and boiling at  $290^\circ C.$ , which are readily soluble in alcohol, and moderately soluble in hot water. It is applied in perfumery for the preparation of the *Asperula* essence. On boiling with concentrated caustic potash it yields the potassium salt of coumaric acid, whilst when fused with potash it is completely decomposed into salicylic and acetic acids. Sodium amalgam reduces it, in aqueous solution, to melilotic acid. It forms addition products with bromine and hydrobromic acid. By the action of phosphorus pentasulphide it is converted into thiocoumarin, which melts at  $101^\circ C.$ ; and in alcoholic solution, on the addition of hydroxylamine hydrochloride and soda, it yields coumarin oxime.

Ortho-coumaric acid (o-oxy-cinnamic acid) is obtained from coumarin as shown above, or by boiling coumarin for some time with sodium ethylate. It melts at  $208^\circ C.$  and is easily soluble in hot water and in alcohol. It cannot be converted into coumarin by heating alone, but it is readily transformed on heating with acetic anhydride or acetyl chloride. By the action of sodium amalgam it is readily converted into *melilotic acid*, which melts at  $81^\circ C.$ , and on distillation furnishes its lactone, *hydrocoumarin*, melting at  $25^\circ C.$  For the relations of coumaric and coumarinic acid see *Annalen*, 254, p. 181. The homologues of coumarin may be obtained by the action of sulphuric acid on phenol and the higher fatty acids (propionic, butyric and isovaleric anhydrides), substitution taking place at the carbon atom in the  $\alpha$  position to the  $-CO-$  group, whilst by the condensation of acetoacetic ester and phenols with sulphuric acid the  $\beta$  substituted coumarins are obtained.

*Umbelliferone* or 4-oxy-coumarin, occurs in the bark of *Daphne mezereum* and may be obtained by distilling such resins as galbanum or asafoetida. It may be synthesized from resorcin and malic anhydride or from  $\beta$  resorcyaldehyde, acetic anhydride and sodium acetate. *Daphnetin* and *Aesculetin* are dioxy-coumarins.

The structural formulae of coumarin and the related substances are:

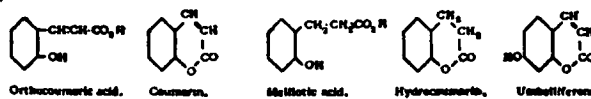

**COUMARONES** or **BENZOPURPURANES**, organic compounds containing the ring system  $C_6H_4 \begin{matrix} \text{CH} \\ \diagup \quad \diagdown \\ \text{O} \end{matrix} \text{CH}$ . This ring system

may be synthesized in many different ways, the chief methods employed being as follows: by the action of hot alcoholic potash on *o*-bromcoumarin (R. Fittig, *Ann.*, 1883, 216, p. 162),

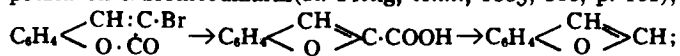

from sodium salts of phenols and *o*-chloroacetoacetic ester (A. Hantzsch, *Ber.*, 1886, 19, p. 1292),

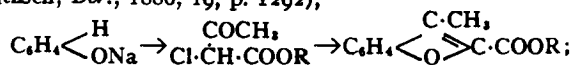

or from ortho-oxaldehydes by condensation with ketones (S. Kostanecki and J. Tambor, *Ber.*, 1896, 29, p. 237), or with chloroacetic acid (A. Rossing, *Ber.*, 1884, 17, p. 3000),

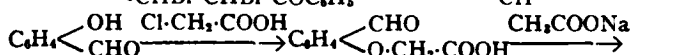
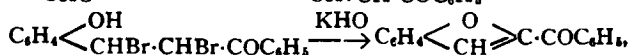
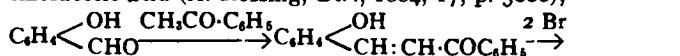

The parent substance coumarone,  $C_9H_6O$ , is also obtained by heating *o*-chlor-ortho-oxystyrol with concentrated potash solution (G. Komppa, *Ber.*, 1893, 26, p. 2971),

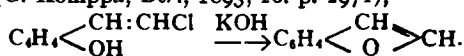

It is a colourless liquid which boils at 171-172° C. and is readily volatile in steam, but is insoluble in water and in potash solution. Concentrated acids convert it into a resin. When heated with sodium and absolute alcohol, it is converted into *hydrocoumarone*,  $C_9H_8O$ , and ethyl phenol.

**COUNCIL** (Lat. *concilium*, from *cum*, together, and the root *cal*, to call), the general word for a convocation, meeting, assembly. The Latin word was frequently confused with *consilium* (from *consulere*, to deliberate, cf. *consul*), advice, *i.e.* counsel, and thus specifically an advisory assembly. Du Cange (*Gloss. Med. Infim. Latin.*) quotes the Greek words *σύνδοδος*, *συνέδριον*, *συμβόλιον* as the equivalent of *concilium*. In French the distinction between *conseil* (from *consilium*), advice, and *concile*, council (*i.e.* ecclesiastical—its only meaning) has survived, but the two English derivatives are much confused. In the New Testament, "council" is the rendering of the Hebrew Sanhedrin, Gr. *συνέδριον*. The word is generally used in English for all kinds of congregations or convocations assembled for administrative and deliberative purposes.<sup>1</sup>

The present article is confined to a history of the development of the ecclesiastical council, summoned to adjust matters in dispute with the civil authority or for the settlement of doctrinal and other internal disputes. For details see under separate headings, NICAËA, &c.

From a very early period in the history of the Church, councils or synods have been held to decide on matters of doctrine and discipline. They may be traced back to the second half of the 2nd century A.D., when sundry churches in Asia Minor held consultations about the rise of Montanism. Their precise origin is disputed. The common Roman Catholic view is that they are apostolic though not prescribed by divine law, and the apostolic precedent usually cited is the "council" of Jerusalem (Acts xv.; Galatians ii.). Waiving the consideration of vital critical questions and accepting Acts xv. at its face value, the assembly at Jerusalem would scarcely seem to have been a council in the technical sense of the word; it was in essence a meeting of the Jerusalem church at which delegates from Antioch were heard but apparently had no vote, the decision resting solely with the mother church. R. Sohm argues that synods grew from the custom of certain local churches which, when confronted with a

<sup>1</sup> For the Greek Council see BOULE; for the Hebdomadal Council see OXFORD; see also ENGLAND: *Local Government*.

serious problem of their own, augmented their numbers by receiving delegates from the churches of the neighbourhood. Hauck, however, holds that these augmented church meetings, which dealt with the affairs of but a single church, are to be distinguished from the synods, which took cognizance of matters of general interest. Older Protestant writers have contented themselves with saying either that synods were of apostolic origin, or that they were the inevitable outcome of the need of the leaders of churches to take counsel together, and that they were perhaps modelled on the secular provincial assemblies (*concilia provincialia*).

Every important alteration in the constitution of the Church has affected the composition and function of synods; but the changes were neither simultaneous nor precisely alike throughout the Roman empire. The synods of the 2nd century were extraordinary assemblies which met to deliberate upon pressing problems. They had no fixed geographical limits for membership, no *ex-officio* members, nor did they possess an authority which did away with the independence of the local church. In the course of the 3rd century came the decisive change, which increased the prestige of the councils: the right to vote was limited to bishops. This was the logical outgrowth of the belief that each local church ought to have but one bishop (monarchical episcopate), and that these bishops were the sole legitimate successors of the apostles (apostolic succession), and therefore official organs of the Holy Spirit. Although as late as 250 the consensus of the priests, the deacons and the people was still considered essential to the validity of a conciliar decision at Rome and in certain parts of the East, the development had already run its course in northern Africa. It was a further step in advance when synods began to meet at regular intervals. They were held annually in Cappadocia by the middle of the 3rd century, and the council of Nicaea commanded in 325 that semi-annual synods be held in every province, an arrangement which was not systematically enforced, and was altered in 692, when the Trullan Council reduced the number to one a year.

With the multiplication of synods came naturally a differentiation of type. In text-books we find clear lines drawn between diocesan, provincial, national, patriarchal and oecumenical synods; but the first thousand years of church history do not justify the sharpness of the traditional distinction. The *provincial* synods, presided over by the metropolitan (archbishop), were usually held at the capital of the province, and attempted to legislate on all sorts of questions. The state had nothing to do with calling them, nor did their decrees require governmental sanction. Various abortive attempts were made to set up synods of *patriarchal* or at least of more than provincial rank. In North Africa eighteen such synods were held between 393 and 424; during part of the 5th and 6th centuries *primatial* councils assembled at Arles; and the patriarchs of Constantinople were accustomed to invite to their "*endemic* synods" (*σύνδοδος ἐνδημοῦσσαι*) all bishops who happened to be sojourning at the capital. *Papal* synods from the 5th and especially from the 9th century onward included members such as the archbishops of Ravenna, Milan, Aquileia and Grado, who resided outside the Roman archdiocese; but the territorial limits from which the membership was drawn do not appear to have been precisely defined.

Before the form of the provincial synod had become absolutely fixed, there arose in the 4th century the *oecumenical* council. The Greek term *σύνδοδος οἰκουμένης*<sup>2</sup> (*oikoumeniké*) (used by Eusebius, *Vita Constantini*, iii. 6) is preferable to the Latin *concilium universale* or *generale*, which has been applied loosely to national and even to provincial synods. The oecumenical synods were not the logical outgrowth of the network of provincial synods; they were creations of the imperial power. Constantine, who had not even been baptized, laid the foundations when, in response to a petition of the Donatists, he referred their case to a committee of bishops that convened at Rome, which meeting Eusebius calls a

<sup>2</sup> From ἡ οἰκουμένη (γῆ), the inhabited world; Latin *oecumenicus* or *universalis*. The English forms "oecumenical" and "ecumenical" are both used.

synod. After that the emperor summoned the council of Arles to settle the matter. For both of these assemblies it was the emperor that decided who should be summoned, paid the travelling expenses of the bishops, determined where the council should be held and what topics should be discussed. He regarded them as temporary advisory bodies, to whose recommendations the imperial authority might give the force of law. In the same manner he appointed the time and place for the council of Nicaea, summoned the episcopate, paid part of the expenses out of the public purse, nominated the committee in charge of the order of business, used his influence to bring about the adoption of the creed, and punished those who refused to subscribe. To be sure, the council of Nicaea commanded great veneration, for it was the first attempt to assemble the entire episcopate; but no more than the synods of Rome and of Arles was it an organ of ecclesiastical self-government—it was rather a means whereby the Church was ruled by the secular power. The subsequent oecumenical synods of the undivided Church were patterned on that of Nicaea. Most Protestant scholars maintain that the secular authorities decided whether or not they should be convened, and issued the summons; that imperial commissioners were always present, even if they did not always preside; that on occasion emperors have confirmed or refused to confirm synodal decrees; and that the papal confirmation was neither customary nor requisite. Roman Catholic scholars to-day tend to recede from the high ground very generally taken several centuries ago, and Funk even admits that the right to convoke oecumenical synods was vested in the emperor regardless of the wishes of the pope, and that it cannot be proved that the Roman see ever actually had a share in calling the oecumenical councils of antiquity. Others, however, while acknowledging the futility of seeking historical proofs that the popes *formally* called, directed and confirmed these synods, yet assert that the emperor performed these functions not of his own right but in his quality as protector of the Church, that this involved his acting at the request or at least with the permission and approval of the Church, and in particular of the pope, and that a special though not a stereotyped papal confirmation of conciliar decrees was necessary to their validity.

In the Germanic states which arose on the ruins of the Western Empire we find *national* and *diocesan* synods; provincial synods were unusual. National synods were summoned by the king or with his consent to meet special needs; and they were frequently *concilia mixta*, at which lay dignitaries appeared. Although the Frankish monarchs were not absolute rulers, nevertheless they exercised the right of changing or rejecting synodal decrees which ran counter to the interests of the state. Clovis held the first French national synod at Orleans in 511; Reccared, the first in Spain in 589 at Toledo. Under Charlemagne they were occasionally so representative that they might almost be ranked as general synods of the West (Regensburg, 792, Frankfort, 794). Contemporaneous with the evolution of the national synod was the development of a new type of diocesan synod, which included the priests of separate and mutually independent parishes and also the leaders of the monastic clergy.

The papal synods came into the foreground with the success of the Cluniac reform of the Church, especially from the Lateran synod of 1059 on. They grew in importance until at length Calixtus II. summoned to the Lateran the synod of 1123 as "*generale concilium*." The powers which the pope as bishop of the church in Rome had exercised over its synods he now extended to the oecumenical councils. They were more completely under his control than the ancient ones had been under the sway of the emperor. The Pseudo-Isidorean principle that all major synods need papal authorization was insisted on, and the decrees were formulated as papal edicts.

The absolutist principles cherished by the papal court in the 12th and 13th centuries did not pass unchallenged; but the protests of Marsilius of Padua and the less radical William of Occam remained barren until the Great Schism of 1378. As neither the pope in Rome nor his rival in Avignon would give way, recourse was had to the idea that the supreme power was vested

not in the pope but in the oecumenical council. This "conciliar theory," propounded by Conrad of Gelnhausen and championed by the great Parisian teachers Pierre d'Ailly and Gerson, proceeded from the nominalistic axiom that the whole is greater than its part. The decisive revolutionary step was taken when the cardinals independently of both popes ventured to hold the council of Pisa (1409). The council of Constance asserted the supremacy of oecumenical synods, and ordered that these be convened at regular intervals. The last of the Reform councils, that of Basel, approved these principles, and at length passed a sentence of deposition against Pope Eugenius IV. Eugenius, however, succeeded in maintaining his power, and at the council of Florence (1439) secured the condemnation of the conciliar theory; and this was reiterated still more emphatically, on the eve of the Reformation, by the fifth Lateran council (1516). Thenceforward the absolutist theories of the 13th and 14th centuries increasingly dominated the Roman Church. The popes so distrusted oecumenical councils that between 1517 and 1869 they called but one; at this (Trent, 1545-1563), however, all treatment of the question of papal versus conciliar authority was purposely avoided. Although the Declaration of the French clergy of 1682 reaffirmed the conciliar doctrines of Constance, since the French Revolution this "Gallicanism" has shown itself to be but a passing phase of constitutional theory; and in the 19th century the ascendancy of Ultramontanism became so secure that Pius IX. could confidently summon to the Vatican a synod which set its seal on the doctrine of papal infallibility. Yet it would be a misconception to suppose that the Vatican decrees mean the surrender of the ancient belief in the infallibility of oecumenical synods; their decisions may still be regarded as more solemn and more impressive than those of the pope alone; their authority is fuller, though not higher. At present it is agreed that the pope has the sole right of summoning oecumenical councils, of presiding or appointing presidents and of determining the order of business and the topics which shall come up. The papal confirmation is indispensable; it is conceived of as the stamp without which the expression of conciliar opinion lacks legal validity. In other words, the oecumenical council is now practically in the position of the senate of an absolute monarch. It is in fact an open question whether a council is to be ranked as really oecumenical until after its decrees have been approved by the pope. (See VATICAN COUNCIL, ULTRAMONTANISM, INFALLIBILITY.)

The earlier oecumenical councils have well been called "the pitched battles of church history." Summoned to combat heresy and schism, in spite of degrading pressure from without and tumultuous disorder within, they ultimately brought about a modicum of doctrinal agreement. On the one side as time went on they bound scholarship hand and foot in the winding-sheet of tradition, and also fanned the flames of intolerance; yet on the other side they fostered the sense of the Church's corporate oneness. The diocesan and provincial synods have formed a valuable system of regularly recurring assemblies for disposing of ecclesiastical business. They have been held most frequently, however, in times of stress and of reform, for instance in the 11th, 16th and 19th centuries; at other periods they have lapsed into disuse: it is significant that to-day the prelate who neglects to convene them suffers no penalty. At present the main function of both provincial and oecumenical synods seems to be to facilitate obedience to the wishes of the central government of the Church.

The *right to vote* (*votum definitivum*) has been distinguished from early times from the right to be heard (*votum consultativum*). The Reform Synods of the 15th century gave a decisive vote to doctors and licentiates of theology and of laws, some of them sitting as individuals, some as representatives of universities. Roman Catholic canonists now confine the right to vote at oecumenical councils to bishops, cardinal deacons, generals or vicars general of monastic orders and the *praelati nullius* (exempt abbots, &c.); all other persons, lay or clerical, who are admitted or invited, have merely the *votum consultativum*—they are chiefly procurators of absent bishops, or very learned priests. It was but a clumsy and temporary expedient, designed to offset the preponderance of Italian bishops dependent on the pope

when the council of Constance subdivided itself into several groups or "nations," each of which had a single vote. In voting, the simple majority decides; yet such is the importance attached to a unanimous verdict that an irreconcilable minority may absent itself from the final vote, as was the case at the Vatican Council.

The numbering of oecumenical synods is not fixed; the list most used in the Roman Church to-day is that of Hefele (*Conciliengeschichte*, 2nd ed., I. 59 f.):

	A.D.
1. Nicaea I. . . . .	325
2. Constantinople I. . . . .	381
3. Ephesus . . . . .	431
4. Chalcedon . . . . .	451
5. Constantinople II. . . . .	553
6. Constantinople III. . . . .	680
7. Nicaea II. . . . .	787
8. Constantinople IV. . . . .	869
9. Lateran I. . . . .	1123
10. Lateran II. . . . .	1139
11. Lateran III. . . . .	1179
12. Lateran IV. . . . .	1215
13. Lyons I. . . . .	1245
14. Lyons II. . . . .	1274
15. Vienne . . . . .	1311
16. Constance (in part) . . . . .	1414-1418
17a. Basel (in part) . . . . .	1431 ff.
17b. Ferrara-Florence (a continuation of Basel) . . . . .	1438-1442
18. Lateran V. . . . .	1512-1517
19. Trent . . . . .	1545-1563
20. Vatican . . . . .	1869-1870

(Each of these and certain other important synods are treated in separate articles.)

By including Pisa (1409) and by treating Florence as a separate synod, certain writers have brought the number of oecumenical councils up to twenty-two. These standard lists are of the type which became established through the authority of Cardinal R. F. Bellarmine (1542-1621), who criticized Constance and Basel, while defending Florence and the fifth Lateran council against the Gallicans. As late as the 16th century, however, "the majority did not regard those councils in which the Greek Church did not take part as oecumenical at all" (Harnack, *History of Dogma*, vi. 17). The Greek Church accepts only the first seven synods as oecumenical; and it reckons the Trullan synod of 692 (the Quinisextum) as a continuation of the sixth oecumenical synod of 680. But concerning the first seven councils it should be remarked that Constantinople I. was but a general synod of the East; its claim to oecumenicity rests upon its reception by the West about two centuries later. Similarly the only representatives of the West present at Constantinople II. were certain Africans; the pope did not accept the decrees till afterwards and they made their way in the West but gradually. Just as there have been synods which have come to be considered oecumenical though not convoked as such, so there have been synods which though summoned as oecumenical, failed of recognition: for instance Sardica (343), Ephesus (449), Constantinople (754). The last two received the imperial confirmation and from the legal point of view were no whit inferior to the others; their decrees, however, were overthrown by subsequent synods. As the Protestant leaders of the 16th century held fast the traditional christology, they regarded with veneration the dogmatic decisions of Nicaea I., Constantinople I., Ephesus and Chalcedon. These four councils had enjoyed a more or less fortuitous pre-eminence both in Roman and in canon law, and by many Catholics at the time of the Reformation were regarded, along with the three great creeds (Apostles', Nicene, Athanasian), as a sort of irreducible minimum of orthodoxy. In the 17th century the liberal Lutheran George Calixtus based his attempts at reuniting Christendom on this *consensus quinqueseccularis*. Many other Protestants have accepted Constantinople II. and III. as supporting the first four councils; and still others, notably many Anglican high churchmen, have felt bound by all the oecumenical synods of the undivided Church. The common Protestant attitude toward synods is, however, that they may err and have erred, and that the Scriptures and not conciliar

decisions are the sole infallible standard of faith, morals and worship.

**Protestant Councils.**—The churches of the Reformation have all had a certain measure of synodal life. The Church of England has maintained its ancient provincial synods or convocations, though for the greater part of the 18th and the first part of the 19th centuries they transacted no business. In the Lutheran churches of Germany there was no strong agitation in favour of introducing synods until the 19th century, when a movement, designed to render the churches less dependent on the governmental consistories, won its way, until at length Prussia itself fell into line (1873 and 1876). As the powers granted to the German synods are very limited, many of their advocates have been disillusioned; but the Lutheran churches of America, being independent of the state, have developed synods both numerous and potent. In the Reformed churches outside Germany synodal life is vigorous; its forms were developed by the Huguenots in days of persecution, and passed thence to Scotland and other presbyterian countries. Even many of the churches of congregational polity have organized national councils (see CONGREGATIONALISM); but here the principle of the independence of the local church prevents the decisions from binding those congregations which do not approve of the decrees. Moreover, in the last decade of the 19th century a growing desire for a rapprochement between the Free Churches in the United Kingdom as a whole led to the annual assembly of the Free Church Council for the consideration of all matters affecting the dissenting bodies. This body has no executive or doctrinal authority and is rather a conference than a council. In general it may be said that synods are becoming more and more powerful in Protestant lands, and that they are destined to still greater prominence because of the growing sentiment for Christian unity.

**AUTHORITIES.**—GENERAL COLLECTIONS: *Collectio regia* (Paris, 1644, 37 vols.) (the first very extensive work); P. Labbe (not Labbé) and G. Cossart, *Sacrosancta concilia* (Paris, 1672, 17 vols.), with supplement by Etienne Baluze (Baluzeus), 1683 (based on above); J. Hardouin (Harduinus), *Conciliorum collectio regia maxima* (Paris, 1715), 11 tomi in 12 vols. (to 1714; more exact; indexed; serious omissions); enlarged edition by N. Coletus (Venice, 1728-1732), supplemented by J. D. Mansi, *Sanctorum conciliorum et decretorum nova collectio* (Lucca, 1748, 6 tomi). Convenient but fallible is Mansi's *Sacrorum conciliorum et decretorum nova et amplissima collectio* (Florence, 1759-1767; completed Venice, 1769-1798, 31 vols.); facsimile reproduction by Welter (Paris, 1901 ff.), adding (tom. O) *Introductio seu apparatus ad sacrosancta concilia*, and (tom. 17B and 18B) Baluze, *Capitularia regum Francorum*, and continuing to date by reproducing parts of Coletus and of Mansi's supplement to Coletus, and furnishing (tom. 37 ff.) a new edition of the councils from 1720 on by J. B. Martin and L. Petit. A careful text of Roman Catholic synods from 1682 to 1870 is *Collectio Lacensis (Acta et decreta sacrorum conciliorum recentiorum*, Friburgi, 1870 ff.), 7 vols.

**SPECIAL COLLECTIONS:** GREAT BRITAIN: *Concilia Magnae Britanniae et Hiberniae*, ed. D. Wilkins (London, 1737, 4 vols.); *Councils and Ecclesiastical Documents relating to Great Britain and Ireland*, ed. by A. W. Haddan and W. Stubbs (Oxford, 1869 ff., 4 vols.); J. W. Joyce, *Handbook of the Convocations or Provincial Synods of the Church of England* (London, 1887); *Concilia Scotiae* (1225-1559), ed. Joseph Robertson (Edinburgh, Bannatyne Club, 1866, 2 tom.).

**UNITED STATES:** *Collectio Lacensis* (Roman Catholic synods); *The American Church History Series* (New York, 1893 ff. 13 vols.) gives information on the various Protestant synods.

**FRANCE.**—*Concilia aevi Merovingici*, rec. F. Maassen (Hanover, 1893) (*Monumenta Germaniae historica, Legum sectio iii.*, *Concilia*, tom. i.); *Concilia antiqua Galliae*, cur. J. Sirmond (Paris, 1629, 3 vols.); supplement by P. de la Lande (Paris, 1666); L. Odespün, *Concilia novissima Galliae* (Paris, 1646); *Conciliorum Galliae tam editorum quam ineditorum, stud. congreg. S. Mauri*, tom. i. (Paris, 1789). Synods of the Reformed Churches of France are contained in J. Quick, *Synodicon in Gallia reformata* (London, 1692, 2 vols.); J. Aymon, *Tous les synodes nationaux des églises réformées de France* (La Haye, 1710, 2 vols.); E. Hugues, *Les Synodes du désert* (Paris, 1885 f., 3 vols.). For the synods of other countries see Herzog-Hauck, 3rd ed., 19, 262 f., and Wetzlar and Welte, 2nd ed., 3809 f.

**LESS ELABORATE TEXTS:** *Canones apostolorum et conciliorum saeculorum*, iv.-vii., rec. H. T. Bruns (Berlin, 1839, 2 vols.) (still useful); J. Fulton, *Index Canonum* (3rd ed., New York, 1892) (3rd and 4th centuries); W. Bright, *Notes on the Canons of the First Four General Councils* (2nd ed., Oxford, 1892); *Die Kanones der*

wichtigsten altkirchlichen Concilien nebst den apostolischen Kanones, ed. F. Lauchert (Freiburg i. B., 1896); *Enchiridion symbolorum et definitionum, quae de rebus fidei et morum a conciliis oecumenicis et summis pontificibus emanarunt*, ed. H. Denzinger (7th ed., Würzburg, 1895); *Bibliothek der Symbole und Glaubensregeln der alten Kirche*, ed. by A. Hahn (3rd edition, revised and enlarged, Breslau, 1897), with variant readings; C. Mirbt, *Quellen zur Geschichte des Papsttums und des römischen Katholizismus* (2nd much enlarged ed., Tübingen, 1901); E. F. Karl Müller, *Die Bekenntnisschriften der reformierten Kirche* (Leipzig, 1903) (for all countries). These last five are elaborately indexed.

TRANSLATIONS: John Johnson, *A Collection of the Laws and Canons of the Church of England* [601-1519], 2 parts (London, 1720; reprinted Oxford, 1850 f., in the *Library of Anglo-Catholic Theology*); P. Schaff, *The Creeds of Christendom* (New York, 1877, 3 vols.) (texts and translations parallel); *Canons and Creeds of the First Four Councils*, ed. by E. K. Mitchell, in *Translations and Reprints from the Original Sources of European History, published by the Department of History of the University of Pennsylvania*, vol. iv. 2 (1897); H. R. Percival, *The Ecumenical Councils* (New York, 1900) (*Nicene and Post-Nicene Fathers*, second series, vol. xiv.; translates canons and compiles notes; bibliography in Introduction).

GENERAL HISTORIES OF COUNCILS: C. J. von Hefele, *Concilien-geschichte* (Freiburg i. B., 1855); English translation of the earlier volumes to A.D. 787, from A.D. 326 on, based on the second German edition (Edinburgh, 1871 ff.); French, by Delarc (Paris, 1869-1874, 10 vols.). This first edition not entirely superseded by the second, made after the Vatican council, and continued by Knöpfler and by Hergenröther (Freiburg, 1873-1890, 9 vols.); a French translation, with continuation and critical and bibliographical notes, *par un religieux bénédictin de Farnborough*, tome i. 1<sup>re</sup> partie (Paris, Létouzey, 1907); Paul Viollet, *Examen de l'histoire des conciles de Mgr Hefele* (Paris, 1876) (*Extrait de la Revue historique*); W. P. du Bose, *The Ecumenical Councils* (New York, 1896) (popular); P. Guérin, *Les Conciles généraux et particuliers* (Paris, 1868, 3rd impression, 1897, 3 tom.); see also A. Harnack, *History of Dogma* (Boston, 1895-1900, 7 vols.); F. Loofs, *Leitfaden der Dogmengeschichte* (4th ed., enlarged, Halle, 1906).

LITERATURE: *Dictionnaire universel et complet des conciles*, rédigé par A. C. Peltier, publié par Migne (Paris, 1847, 2 vols.) (Migne, *Encyclopédie théologique*, vol. 13 f.); Z. Zitelli-Natali, *Epilome historico-canonicum conciliorum generalium* (Rome, 1881); F. X. Kraus, *Realencyklopädie der christlichen Altertümer*, vol. i. (Freiburg i. B., 1882) (art. "Concilien" by Funk); William Smith and S. Cheetham, *Dictionary of Christian Antiquities* (London, 1876-1880, 2 vols.) (erudite detail); Wetzer und Welte's *Kirchenlexikon*, 2nd ed. by Hergenröther and Kaulen (Freiburg i. B., 1882-1903, 13 vols.) (art. "Concil" by Scheeben); *La Grande Encyclopédie* (Paris, s.d., 31 vols.) (numerous articles); P. Hinschius, *Das Kirchenrecht der Katholiken und Protestanten in Deutschland*, vol. 3 (Berlin, 1883) (fundamental and masterly); R. von Scherer, *Handbuch des Kirchenrechtes*, vol. i. (Graz, 1886) (excellent notes and references); E. H. Landon, *A Manual of Councils of the Holy Catholic Church*, (revised ed., London, [1893], 2 vols.) (paraphrases chief canons; needs revision); Martigny, *Dictionnaire des antiquités chrétiennes* (3rd ed., Paris, 1889) (for ceremonial); R. Sohm, *Kirchenrecht*, vol. i. (Leipzig, 1892) (brilliant); A. Kneer, *Die Entstehung der konziliaren Theorie* (Rome, 1893); *Realencyklopädie für protestantische Theologie und Kirche*, begründet von J. J. Herzog, 3rd revised ed. by A. Hauck (Leipzig, 1896 ff.) (in vol. 19 Hauck's excellent *Synoden*, 1907); F. X. Funk, *Kirchengeschichtliche Abhandlungen und Untersuchungen* (Paderborn, 1897); A. V. G. Allen, *Christian Institutions* (New York, 1897), chap. xi.; C. A. Kneller, "Papst und Konzil im ersten Jahrtausend" (*Zeitschrift für katholische Theologie*, vols. 27 and 28, Innsbruck, 1893 f.); F. Bliemetzrieder, *Das Generalkonzil im grossen abendländischen Schisma* (Paderborn, 1904); Wilhelm and Scannell, *Manual of Catholic Theology* (3rd ed., London, 1906, sect. 32); J. Forget, "Conciles," in A. Vacant and E. Mangéot, *Dictionnaire de théologie catholique*, tome 3, 636-676 (Paris, 1906 ff.), with elaborate bibliography; *The Catholic Encyclopedia* (New York, 1907 ff.). (W. W. R.)\*

**COUNCIL BLUFFS**, a city and the county-seat of Pottawattamie county, Iowa, U.S.A., about 2½ m. E. of the Missouri river opposite Omaha, Nebraska, with which it is connected by a road bridge and two railway bridges. Pop. (1890) 21,474; (1900) 25,802, of whom 3723 were foreign-born; (1910) 29,292. It is pre-eminently a railway centre, being served by the Union Pacific, of which it is the principal eastern terminus, the Chicago, Burlington & Quincy, the Chicago, Milwaukee & Saint Paul, the Chicago & Northwestern, the Chicago, Rock Island & Pacific, the Chicago Great-Western, the Illinois Central, and the Wabash, which together have given it considerable commercial importance. It is built for the most part on level ground at the foot of high bluffs; and has several parks, the most attractive of which, commanding fine views, is Fairmount Park. With the exception

of bricks and tiles, carriages and wagons, agricultural implements, and the products of its railway shops, its manufactures are relatively unimportant, the factory product in 1905 being valued at only \$1,924,109. Council Bluffs is the seat of the Western Iowa Business College, and of the Iowa school for the deaf. On or near the site of Council Bluffs, in 1804, Lewis and Clark held a council with the Indians, whence the city's name. In 1838 the Federal government made this the headquarters of the Pottawattamie Indians, removed from Missouri. They remained until 1846-1847, when the Mormons came, built many cabins, and named the place Kanessville. The Mormons remained only about five years, but on their departure for Utah their places were speedily taken by new immigrants. During 1849-1850 Council Bluffs became an important outfitting point for California gold seekers—the goods being brought by boat from Saint Louis—and in 1853 it was incorporated as a city.

**COUNSEL AND COUNSELLOR**, one who gives advice, more particularly in legal matters. The term "counsel" is employed in England as a synonym for a barrister-at-law, and may refer either to a single person who pleads a cause, or collectively, to the body of barristers engaged in a case. Counsellor or, more fully, counsellor-at-law, is practically an obsolete term in England, but is still in use locally in Ireland as an equivalent to barrister. In the United States, a counsellor-at-law is, specifically, an attorney admitted to practice in all the courts; but as there is no formal distinction of the legal profession into two classes, as in England, the term is more often used loosely in the same sense as "lawyer," i.e. one who is versed in, or practises law.

**COUNT** (Lat. *comes*, gen. *comitis*, Fr. *comte*, Ital. *conte*, Span. *conde*), the English translation of foreign titles equivalent generally to the English "earl."<sup>1</sup> In Anglo-French documents the word *counte* was at all times used as the equivalent of earl, but, unlike the feminine form "countess," it did not find its way into the English language until the 16th century, and then only in the sense defined above. The title of earl, applied by the English to the foreign counts established in England by William the Conqueror, is dealt with elsewhere (see EARL). The present article deals with (1) the office of count in the Roman empire and the Frankish kingdom, (2) the development of the feudal count in France and under the Holy Roman Empire, (3) modern counts.

1. The Latin *comes* meant literally a companion or follower. In the early Roman empire the word was used to designate the companions of the emperor (*comites principis*) and so became a title of honour. The emperor Hadrian chose senators as companions on his travels and to help him in public business. They formed a permanent council, and Hadrian's successors entrusted these *comites* with the administration of justice and finance, or placed them in military commands. The designation *comes* thus developed into a formal official title of high officers of state, some qualification being added to indicate the special duties attached to the office in each case. Thus in the 5th century, among the *comites* attached to the emperor's establishment, we find, e.g., the *comes sacrarum largitionum* and the *comes rei privatae*; while others, forming the council, were styled *comites consistorii*. Others were sent into the provinces as governors, *comites per provincias constituti*; thus in the *Notitia dignitatum* we find a *comes Aegypti*, a *comes Africae*, a *comes Belgicae*, a *comes Lugdunensis* and others. Two of the generals of the Roman province of Britain were styled the *comes Britanniae* and the *comes littoris Saxonici* (count of the Saxon shore).

At Constantinople in the latter Roman empire the Latin word *comes* assumed a Greek garb as *κόμης* and was declined as a Greek noun (gen. *κόμητος*); the *comes sacrarum largitionum* (count of the sacred bounties) was called at Constantinople *ὁ κόμης τῶν σακρῶν λαργιτιῶνων* and the *comes rerum privatarum*

<sup>1</sup> The exact significance of a title is difficult to reproduce in a foreign language. Actually, only some foreign counts could be said to be equivalent to English earls; but "earl" is always translated by foreigners by words (*comte*, *Graf*) which in English are represented by "count," itself never used as the synonym of "earl." Conversely old English writers had no hesitation in translating as "earl" foreign titles which we now render "count."



(count of the private estates) was called *κόμες τῶν περιβάτων*. The count of the sacred bounties was the lord treasurer or chancellor of the exchequer, for the public treasury and the imperial fisc had come to be identical; while the count of the private estates managed the imperial demesnes and the privy purse. In the 5th century the "sacred bounties" corresponded to the *aerarium* of the early Empire, while the *res privatae* represented the fisc. The officers connected with the palace and the emperor's person included the count of the wardrobe (*comes sacrae vestis*), the count of the residence (*comes domorum*), and, most important of all, the *comes domesticorum et sacri stabuli* (graecized as *κόμες τοῦ στάβλου*). The count of the stable, originally the imperial master of the horse, developed into the "illustrious" commander-in-chief of the imperial army (Stilicho, e.g., bore the full title as given above), and became the prototype of the medieval constable (q.v.).

An important official of the second rank (*spectabilis*, "respectable" as contrasted with those of highest rank who were "illustrious") was the count of the East, who appears to have had the control of a department in which 600 officials were engaged. His power was reduced in the 6th century, when he was deprived of his authority over the Orient diocese, and became civil governor of Syria Prima, retaining his "respectable" rank. Another important officer of the later Roman court was the *comes sacri patrimonii*, who was instituted by the emperor Anastasius. In this connexion it should be observed that the word *patrimonium* gradually changed in meaning. In the beginning of the 3rd century *patrimonium* meant crown property, and *res privata* meant personal property: at the beginning of the 6th century *patrimonium* meant personal property, and *res privata* meant crown property. It is difficult to give briefly a clear idea of the functions of the three important officials *comes sacrarum largitionum*, *comes rei privatae* and *comes sacri patrimonii*; but the terms have been well translated by a German author as *Finanzminister des Reichsschatzes* (finance minister of the treasury of the Empire), *F. des Kronschatzes* (of the crown treasury), and *F. des kaiserlichen Privatvermögens* (of the emperor's private property).

The Frankish kings of the Merovingian dynasty retained the Roman system of administration, and under them the word *comes* preserved its original meaning; the *comes* was a companion of the king, a royal servant of high rank. Under the early Frankish kings some *comites* did not exercise any definite functions; they were merely attached to the king's person and executed his orders. Others filled the highest offices, e.g. the *comes palatii* and *comes stabuli* (see CONSTABLE). The kingdom was divided for administrative purposes into small areas called *pagi* (*pays*, Ger. *Gau*), corresponding generally to the Roman *civitates* (see CITY).<sup>1</sup> At the head of the *pagus* was the *comes*, corresponding to the German *Graf* (*Gaugraf*, cf. Anglo-Saxon *scire-gerefa*,<sup>2</sup> sheriff). The *comes* was appointed by the king and removable at his pleasure, and was chosen originally from all classes, sometimes from enfranchised slaves. His essential functions were judicial and executive, and in documents he is often described as the king's agent (*agens publicus*) or royal judge (*judex publicus* or *fiscalis*). As the delegate of the executive power he had the right to military command in the king's name, and to take all the measures necessary for the preservation of the peace, i.e. to exercise the royal "ban" (*bannus regis*). He was at once public prosecutor and judge, was responsible for the execution of the sentences of the courts, and as the king's representative exercised the royal right of protection (*mundium regis*) over churches, widows, orphans and the like. He enjoyed a triple wergeld, but had no definite salary, being remunerated by the receipt of certain revenues, a system which contained the germs of discord, on account of the confusion of his public and private

<sup>1</sup> The changing language of this epoch speaks of *civitates*, subsequently of *pagi*, and later of *comitatus* (counties).

<sup>2</sup> The A.S. *gerefa*, however, meaning "illustrious," "chief," has apparently, according to philologists, no connexion with the German *Graf*, which originally meant "servant" (cf. "knight," "valet," &c.). It is the more curious that the *gerefa* should end as a servant ("reeve"), the *Graf* as a noble (count).

estates. He also retained a third of the fines which he imposed in his judicial capacity.

Under the early Carolings the title count did not indicate noble birth. A *comes* was generally raised from childhood in the king's palace, and rose to be a count through successive stages. The count's office was not yet a dignity, nor hereditary; he was not independent nor appointed for life, but exercised the royal power by delegation, as under the Merovingians. While, however, he was theoretically paid by the king, he seems to have been himself one of the sources of the royal revenue. The counties were, it appears, farmed out; but in the 7th century the royal choice became restricted to the larger landed proprietors, who gradually emancipated themselves from royal control, and in the 8th century the term *comitatus* begins to denote a geographical area, though there was little difference in its extent under the Merovingian kings and the early Carolings. The count was about to pass into the feudatory stage. Throughout the middle ages, however, the original official and personal connotation of the title was never wholly lost; or perhaps it would be truer to say, with Selden, that it was early revived with the study of the Roman civil law in the 12th century. The unique dignity of count of the Lateran palace,<sup>3</sup> bestowed in 1328 by the emperor Louis IV. the Bavarian on Castrucio de' Antelminelli, duke of Lucca, and his heirs male, was official as well as honorary, being charged with the attendance and service to be performed at the palace at the emperor's coronation at Rome (Du Cange, s.v. *Comites Palatii Lateranensis*; Selden, *op. cit.* p. 321). This instance, indeed, remained isolated; but the personal title of "count palatine," though honorary rather than official, was conferred on officials—especially by the popes on those of the Curia—had no territorial significance, and was to the last reminiscent of those early *comites palatii* whose relations to the sovereign had been purely personal and official (see PALATINE). A relic of the old official meaning of "count" still survives in Transylvania, where the head of the political administration of the Saxon districts is styled count (*comes, Graf*) of the Saxon Nation.

2. *Feudal Counts*.—The process by which the official counts were transformed into feudal vassals almost independent is described in the article FEUDALISM. In the confusion of the period of transition, when the title to possession was usually the power to hold, designations which had once possessed a definite meaning were preserved with no defined association. In France, by the 10th century, the process of decomposition of the old organization had gone far, and in the 11th century titles of nobility were still very loosely applied. That of "count" was, as Luchaire points out, "equivocal" even as late as the 12th century; any castellan of moderate rank could style himself *comte* who in the next century would have been called *seigneur* (*dominus*). Even when, in the 13th century, the ranks of the feudal hierarchy in France came to be more definitely fixed, the style of "count" might imply much, or comparatively little. In the oldest register of Philip Augustus counts are reckoned with dukes in the first of the five orders into which the nobles are divided, but the list includes, besides such almost sovereign rulers as the counts of Flanders and Champagne, immediate vassals of much less importance—such as the counts of Soissons and Dammartin—and even one mediate vassal, the count of Bar-sur-Seine. The title was still in fact "equivocal," and so it remained throughout French history. In the official lists it was early placed second to that of duke (Luchaire, *Manuel*, p. 181, note 1), but in practice at least the great *comtes-pairs* (e.g. of Champagne) were the equals of any duke and the superiors of many. Thus, too, in modern times royal princes have been given the title of count (Paris, Flanders, Caserta), the heir of Charles X. actually changing his style, without sense of loss, from that of duc de Bordeaux to that of comte de Chambord. From the 16th

<sup>3</sup> "Count of the Lateran Palace" (*Comes Sacri Lateranensis Palatii*) was later the title usually bestowed by the popes in creating counts palatine. The emperors, too, continued to make counts palatine under this title long after the Lateran had ceased to be an imperial palace.

century onwards the equivocal nature of the title in France was increased by the royal practice of selling it, either to viscounts or barons in respect of their fiefs, or to rich *roturiers*.

In Germany the change from the official to the territorial and hereditary counts followed at the outset much the same course as in France, though the later development of the title and its meaning was different. In the 10th century the counts were permitted by the kings to divide their benefices and rights among their sons, the rule being established that countships (*Grafschaften*) were hereditary, that they might be held by boys, that they were heritable by females and might even be administered by females. The *Grafschaft* became thus merely a bundle of rights inherent in the soil; and, the count's office having become his property, the old counties or *Gauen* rapidly disappeared as administrative units, being either amalgamated or subdivided. By the second half of the 12th century the official character of the count had quite disappeared; he had become a territorial noble, and the foundation had been laid of territorial sovereignty (*Landeshoheit*). The first step towards this was the concession to the counts of the military prerogatives of dukes, a right enjoyed from the first by the counts of the marches (see MARGRAVE), then given to counts palatine (see PALATINE) and, finally, to other counts, who assumed by reason of it the style of landgrave (*Landgraf*, i.e. count of a province). At first all counts were reckoned as princes of the Empire (*Reichsfürsten*); but since the end of the 12th century this rank was restricted to those who were immediate tenants of the crown,<sup>1</sup> the other counts of the Empire (*Reichsgrafen*) being placed among the free lords (*barones, liberi domini*). Counts of princely rank (*gefürstete Grafen*) voted among the princes in the imperial diet; the others (*Reichsgrafen*) were grouped in the *Grafenbänke*—originally two, to which two more were added in the 17th century—each of which had one vote. In 1806, on the formation of the Confederation of the Rhine, the sovereign counts were all mediatised (see MEDIATIZATION). Even before the end of the Empire (1806) the right of bestowing the title of count was freely exercised by the various German territorial sovereigns.

3. *Modern Counts*.—Any political significance which the feudal title of count retained in the 18th century vanished with the changes produced by the Revolution. It is now simply a title of honour and one, moreover, the social value of which differs enormously, not only in the different European countries, but within the limits of the same country. In Germany, for instance, there are several categories of counts: (1) the mediatised princely counts (*gefürstete Grafen*), who are reckoned the equals in blood of the European sovereign houses, an equality symbolized by the "closed crown" surmounting their armorial bearings. The heads of these countly families of the "high nobility" are entitled (by a decree of the federal diet, 1820) to the style of *Erlaucht* (illustrious, most honourable); (2) Counts of the Empire,<sup>2</sup> (*Reichsgrafen*), descendants of those counts who, before the end of the Holy Roman Empire (1806), were *Reichsständisch*, i.e. sat in one of the *Grafenbänke* in the imperial diet, and entitled to a ducal coronet; (3) Counts (a) descended from the lower nobility of the old Empire, titular since the 15th century, (b) created since; their coronet is nine-pointed (cf. the nine points and strawberry leaves of the English earl). The difficulty of determining in any case the exact significance of the title of a German count, illustrated by the above, is increased by the fact that the title is generally heritable by all male descendants, the only exception being in Prussia, where, since 1840, the rule of primogeniture has prevailed and the bestowal of the title is dependent on a rent-roll of £3000 a year. The result

<sup>1</sup> Of these there were four who, as counts of the Empire *par excellence*, were sometimes styled "simple counts" (*Schlechtgrafen*), i.e. the counts of Cleves, Schwarzburg, Cilli and Savoy; they were entitled to the ducal coronet. Three of these had become dukes by the 17th century, but the count (now prince) of Schwarzburg still styled himself "Of the four counts of the Holy Roman Empire, count of Schwarzburg" (see Selden, ed. 1672, p. 312).

<sup>2</sup> This title is borne by certain English families, e.g. by Lord Arundell of Wardour. In other cases it has been assumed without due warrant. See J. H. Round, "English Counts of the Empire," in *The Ancestor*, vii. 15 (Westminster, October 1903).

is that the title is very widespread and in itself little significant. A German or Austrian count may be a wealthy noble of princely rank, a member of the Prussian or Austrian Upper House, or he may be the penniless cadet of a family of no great rank or antiquity. Nevertheless the title, which has long been very sparingly bestowed, always implies a good social position. The style *Allgraf* (old count), occasionally found, is of some antiquity, and means that the title of count has been borne by the family from time immemorial.

In medieval France the significance of the title of count varied with the power of those who bore it; in modern France it varies with its historical associations. It is not so common as in Germany or Italy; because it does not by custom pass to all male descendants. The title was, however, cheapened by its revival under Napoleon. By the decree of the 1st of March 1808, reviving titles of nobility, that of count was assigned *ex officio* to ministers, senators and life councillors of state, to the president of the Corps Législatif and to archbishops. The title was made heritable in order of primogeniture, and in the case of archbishops through their nephews. These Napoleonic countships, increased under subsequent reigns, have produced a plentiful crop of titles of little social significance, and have tended to lower the status of the counts deriving from the *ancien régime*. The title of marquis, which Napoleon did not revive, has risen proportionately in the estimation of the Faubourg St Germain. As for that of count, it is safe to say that in France its social value is solely dependent on its historical associations.

Of all European countries Italy has been most prolific of counts. Every petty Italian prince, from the pope downwards, created them for love or money; and, in the absence of any regulating authority, the title was also widely and loosely assumed, while often the feudal title passed with the sale of the estate to which it was attached. Casanova remarked that in some Italian cities all the nobles were *baroni*, in others all were *conti*. An Italian *conte* may or may not be a gentleman; he has long ceased, *qua* count, to have any social prestige, and his rank is not recognized by the Italian government. As in France, however, there are some Italian *conti* whose titles are respectable, and even illustrious, from their historic associations. The prestige belongs, however, not to the title but to the name. As for the papal countships, which are still freely bestowed on those of all nations whom the Holy See wishes to reward, their prestige naturally varies with the religious complexion of the country in which the titles are borne. They are esteemed by the faithful, but have small significance for those outside. In Spain, on the other hand, the title of *conde*, the earlier history of which follows much the same development as in France, is still of much social value, mainly owing to the fact that the rule of primogeniture exists, and that, a large fee being payable to the state on succession to a title, it is necessarily associated with some degree of wealth. The Spanish counts of old creation, some of whom are *grandees* and members of the Upper House, naturally take the highest rank; but the title, still bestowed for eminent public services or other reasons, is of value. The title, like others in Spain, can pass through an heiress to her husband. In Russia the title of count (*graf*, fem. *grafinya*), a foreign importation, has little social prestige attached to it, being given to officials of a certain rank. In the British empire the only recognized counts are those of Malta, who are given precedence with baronets of the United Kingdom.

See Selden, *Titles of Honor* (London, 1672); Du Cange, *Glossarium Med. Lat.* (ed. Niort, 1883) s.v. "Comes"; *La Grande Encyclopédie*, s.v. "Comte"; A. Luchaire, *Manuel des institutions françaises* (Paris, 1892); P. Guilhaumez, *Essai sur l'origine de la noblesse en France au moyen âge* (Paris, 1902); Brunner, *Deutsche Rechtsgeschichte*, Band ii. (Leipzig, 1892).

**COUNTER.** (1) (Through the O. Fr. *conteoir*, modern *comptoir*, from Lat. *computare*, to reckon), a round piece of metal, wood or other material used anciently in making calculations, and now for reckoning points in games of cards, &c., or as tokens representing actual coins or sums of money in gambling games such as roulette. The word is thus used, figuratively, of something of no real value, a sham. In the original sense of "a means of counting money,

or keeping accounts," "counter" is used of the table or flat-topped barrier in a bank, merchant's office or shop, on which money is counted and goods handed to a customer. The term was also applied, usually in the form "compter," to the debtors' prisons attached to the mayor's or sheriff's courts in London and some other boroughs in England. The "compters" of the sheriff's courts of the city of London were, at various times, in the Poultry, Bread St., Wood St. and Giltspur St.; the Giltspur St. compter was the last to be closed, in 1854. (2) (From Lat. *contra*, opposite, against), a circular parry in fencing, and in boxing, a blow given as a parry to a lead of an opponent. The word is also used of the stiff piece of leather at the back of a boot or shoe, of the rounded angle at the stern of a ship, and, in a horse, of the part lying between the shoulder and the under part of the neck. In composition, counter is used to express contrary action, as in "countermand," "counterfeit," &c.

**COUNTERFEITING** (from Lat. *contra-facere*, to make in opposition or contrast), making an imitation without authority and for the purpose of defrauding. The word is more particularly used in connexion with the making of imitations of money, whether paper or coin. (See COINAGE OFFENCES; FORGERY.)

**COUNTERFORT** (Fr. *contrefort*), in architecture, a buttress or pier built up against the wall of a building or terrace to strengthen it, or to resist the thrust of an arch or other constructional feature inside.

**COUNTERPOINT** (Lat. *contrapunctus*, "point counter point," "note against note"), in music, the art happily defined by Sir Frederick Gore Ouseley as that "of combining" melodies: this should imply that good counterpoint is the production of beautiful harmony by a combination of well-characterized melodies. The individual audibility of the melodies is a matter of which current criticism enormously overrates the importance. What is always important is the peculiar life breathed into harmony by contrapuntal organization. Both historically and aesthetically "counterpoint" and "harmony" are inextricably blended; for nearly every harmonic fact is in its origin a phenomenon of counterpoint. And if in later musical developments it becomes possible to treat chords as, so to speak, harmonic lumps with a meaning independent of counterpoint, this does not mean that they have really changed their nature; but it shows a difference between modern and earlier music precisely similar to that between modern English, in which metaphorical and abstract expressions are so constantly used that they have become a mere shorthand for the literal and concrete expression, and classical Greek, where metaphors and abstractions can appear only as elaborate similes or explicit philosophical ideas. The laws of counterpoint are, then, laws of harmony with the addition of such laws of melody as are not already produced by the interaction of harmonic and melodic principles. In so far as the laws of counterpoint are derived from purely harmonic principles, that is to say, derived from the properties of concord and discord, their origin and development are discussed in the article HARMONY. In so far as they depend entirely on melody they are too minute and changeable to admit of general discussion; and in so far as they show the interaction of melodic and harmonic principles it is more convenient to discuss them under the head of harmony, because they appear in such momentary phenomena as are more easily regarded as successions of chords than as principles of design. All that remains, then, for the present article is the explanation of certain technical terms.

1. *Canto Fermo* (i.e. plain chant) is a melody in long notes given to one voice while others accompany it with quicker counterpoints (the term "counterpoint" in this connexion meaning accompanying melodies). In the simplest cases the *Canto Fermo* has notes of equal length and is unbroken in flow. When it is broken up and its rhythm diversified, the gradations between counterpoint on a *Canto Fermo* and ordinary forms of polyphony, or indeed any kind of melody with an elaborate accompaniment, are infinite and insensible.

2. *Double Counterpoint* is a combination of melodies so designed that either can be taken above or below the other. When this change of position is effected by merely altering the octave of

either or both melodies (with or without transposition of the whole combination to another key), the artistic value of the device is simply that of the raising of the lower melody to the surface. The harmonic scheme remains the same, except in so far as some of the chords are not in their fundamental position, while others, not originally fundamental, have become so. But double counterpoint may be in other intervals than the octave; that is to say, while one of the parts remains stationary, the other may be transposed above or below it by some interval other than an octave, thus producing an entirely different set of harmonies.

*Double Counterpoint in the 12th* has thus been made a powerful means of expression and variety. The artistic value of this device depends not only on the beauty and novelty of the second scheme of harmony obtained, but also on the change of melodic expression produced by transferring one of the melodies to another position in the scale. Two of the most striking illustrations of this effect are to be found in the last chorus of Brahms's *Triumphed* and in the fourth of his variations on a theme by Haydn.

*Double Counterpoint in the 10th* has, in addition to this, the property that the inverted melody can be given in the new and in the original positions simultaneously.

Double counterpoint in other intervals than the octave, 10th and 12th, is rare, but the general principle and motives for it remain the same under all conditions. The two subjects of the *Confiteor* in Bach's B minor Mass are in double counterpoint in the octave, 11th and 13th. And Beethoven's Mass in D is full of pieces of double counterpoint in the inversions of which a few notes are displaced so as to produce momentary double counterpoint in unusual intervals, obviously with the intention of varying the harmony. Technical treatises are silent as to this purpose, and leave the student in the belief that the classical composers used these devices, if at all, in a manner as meaningless as the examples in the treatises.

3. *Triple, Quadruple and Multiple Counterpoint*.—When more than two melodies are designed so as to combine in interchangeable positions, it becomes increasingly difficult to avoid chords and progressions of which some inversions are incorrect. In triple counterpoint this difficulty is not so great; although a complete triad is dangerous, as it is apt to invert as a " $\frac{4}{3}$ " which requires careful handling. On the other hand, in triple counterpoint the necessity for strictness is at its greatest, because there are only six possible inversions, and in a long polyphonic work most of these will be required. Moreover, the artistic value of the device is at its highest in three-part polyphonic harmony, which, whether invertible or not, is always a fine test of artistic economy, while the inversions are as evident to the ear, especially where the top part is concerned, as those in double counterpoint. Triple counterpoint (and a fortiori multiple counterpoint) is normally possible only at the octave; for it will be found that if three parts are designed to invert in some other interval this will involve two of them inverting in a third interval which will give rise to incalculable difficulty. This makes the fourth of Brahms's variations on a theme of Haydn almost miraculous. The plaintive expression of the whole variation is largely due to the fact that the flowing semiquaver counterpoint below the main theme is on each repeat inverted in the 12th, with the result that its chief emphasis falls upon the most plaintive parts of the scale. But in the first eight bars of the second part of the variation a third contrapuntal voice appears, and this too is afterwards inverted in the 12th, with perfectly natural and smooth effect. But this involves the inversion of two of the counterpoints with each other in the 9th, a kind of double counterpoint which is almost impossible. The case is unique, but it admirably illustrates the difference between artistic and merely academic mastery of technical resource.

*Quadruple Counterpoint* is not rare with Bach. It would be more difficult than triple, but for the fact that of its twenty-four possible inversions not more than four or five need be correct. *Quintuple counterpoint* is admirably illustrated in the finale of Mozart's *Jupiter Symphony*, in which everything in the successive statement and gradual development of the five themes conspires

to give the utmost effect to their combination in the coda. Of course Mozart has not room for more than five of the 120 possible combinations, and from these he selects such as bring fresh themes into the outside parts, which are the most clearly audible. *Sextuple Counterpoint* may be found in Bach's great double chorus, *Nun ist das Heil*, and in the finale of his concerto for three claviers in C, and probably in other places.

4. *Added Thirds and Sixths*.—An easy and effective imitation of triple and quadruple counterpoint, embodying much of the artistic value of inversion, is found in the numerous combinations of themes in thirds and sixths which arise from an extension of the principle which we mentioned in connexion with double counterpoint in the 10th, namely, the possibility of performing it in its original and inverted positions simultaneously. The *Pleni sunt coeli* of Bach's B minor Mass is written in this kind of transformation of double into quadruple counterpoint; and the artistic value of the device is perhaps never so magnificently realized as in the place, at bar 84, where the trumpet doubles the bass three octaves and a third above while the alto and second tenor have the counter subjects in close thirds in the middle.

Almost all other contrapuntal devices are derived from the principle of the *canon* and are discussed in the article **CONTRAPUNTAL FORMS**.

As a training in musical grammar and style, the rhythms of 16th-century polyphony were early codified into "the five species of counterpoint" (with various other species now forgotten) and practised by students of composition. The classical treatise on which Haydn and Beethoven were trained was Fux's *Gradus ad Parnassum* (1725). This was superseded in the 19th century by Cherubini's, the first of a long series of attempts to bring up to date as a dead language what should be studied in its original and living form. (D. F. T.)

**COUNTERSCARP** (= "opposite scarp," Fr. *contrescarpe*), a term used in fortification for the outer slope of a ditch; see **FORTIFICATION AND SIEGECRAFT**.

**COUNTERSIGN**, a military term for a sign, word or signal previously arranged and required to be given by persons approaching a sentry, guard or other post. In some armies the "countersign" is strictly the reply of the sentry to the pass-word given by the person approaching.

**COUNTRY** (from the Mid. Eng. *contre* or *contrie*, and O. Fr. *cuntrie*; Late Lat. *contrata*, showing the derivation from *contra*, opposite, over against, thus the tract of land which fronts the sight, cf. Ger. *Gegend*, neighbourhood), an extent of land without definite limits, or such a region with some peculiar character, as the "black country," the "fen country" and the like. The extension from such descriptive limitation to the limitation of occupation by particular owners or races is easy; this gives the common use of the word for the land inhabited by a particular nation or race. Another meaning is that part of the land not occupied by towns, "rural" as opposed to "urban" districts; this appears too in "country-house" and "country town"; so too "countryman" is used both for a rustic and for the native of a particular land. The word appears in many phrases, in the sense of the whole population of a country, and especially of the general body of electors, as in the expression "go to the country," for the dissolution of parliament preparatory to a general election.

**COUNTY** (through Norm. Fr. *counté*, cf. O. Fr. *cunté*, *conté*, Mod. Fr. *comté*, from Lat. *comitatus*, cf. Ital. *comitato*, Prov. *comtat*; see **COUNT**), in its most usual sense the name given to certain important administrative divisions in the United Kingdom, the British dominions beyond the seas, and the United States of America. The word was first introduced after the Norman Conquest as the equivalent of the old English "shire," which has survived as its synonym, though occasionally also applied to divisions smaller than counties, e.g. Northhamshire, Hexhamshire and Hallamshire. The word "county" is also sometimes used, alternatively with "countship," to translate foreign words, e.g. the French *comté* and the German *Grafschaft*, which connote the territorial jurisdiction of a count (*q.v.*). The present article is confined to a sketch of the origin and development of English

counties, which have served in a greater or less degree as the model for the county organizations in the various countries of the English-speaking world which are described under their proper headings.

About one-third of the English counties represent ancient kingdoms, sub-kingdoms or tribal divisions, such as Kent, Sussex, Norfolk, Devon; but most of the remaining counties take their names from some important town within their respective boundaries. The counties to the south of the Thames (except Cornwall) already existed in the time of Alfred, but those of the midlands seem to have been created during the reign of Edward the Elder (901-925) and to have been artificially bounded areas lying around some stronghold which became a centre of civil and military administration. There is reason, however, for thinking that the counties of Bedford, Cambridge, Huntingdon and Northampton are of Danish origin. Northumberland, Cumberland and Westmorland were not recognized as English counties until some time after the Norman Conquest, the last two definitely appearing as fiscal areas in 1177. The origin of Rutland as a county is obscure, but it had its own sheriff in 1154.

In the period preceding the Norman Conquest two officers appear at the head of the county organization. These are the ealdorman or earl, and the *scirgerefa* or sheriff. The shires of Wessex appear each to have had an ealdorman, whose duties were to command its military forces, to preside over the county assembly (*scirgemot*), to carry out the laws and to execute justice. The name ealdorman gave way to that of earl, probably under Danish influence, in the first half of the 11th century, and it is probable that the office of sheriff came into existence in the reign of Canute (1017-1035), when the great earldoms were formed and it was no longer possible for the earl to perform his various administrative duties in person in a group of counties. After the Norman Conquest the earl was occasionally appointed sheriff of his county, but in general his only official connexion with it was to receive the third penny of its pleas, and the earldom ceased to be an office and became merely a title. In the 12th century the office of coroner was created, two or more of them being chosen in the county court as vacancies occurred. In the same century verderers were first chosen in the same manner for the purpose of holding inquisitions on vert and venison in those counties which contained royal forests. It was the business of the sheriff (*vicecomes*) as the king's representative to serve and return all writs, to levy distresses on the king's behalf, to execute all royal precepts and to collect the king's revenue. In this work he was assisted by a large staff of clerks and bailiffs who were directly responsible to him and not to the king. The sheriff also commanded the armed forces of the crown within his county, and either in person or by deputy presided over the county court which was now held monthly in most counties. In 1300 it was enacted that the sheriffs might be chosen by the county, except in Worcestershire, Cornwall, Rutland, Westmorland and Lancashire, where there were then sheriffs in fee, that is, sheriffs who held their offices hereditarily by royal grant. The elective arrangement was of no long duration, and it was finally decided in 1340 that the sheriffs should be appointed by the chancellor, the treasurer and the chief baron of the exchequer, but should hold office for one year only. The county was from an early period regarded as a community, and approached the king as a corporate body, while in later times petitions were presented through the knights of the shire. It was also an organic whole for the purpose of the conservation of the peace. The assessment of taxation by commissioners appointed by the county court developed in the 13th century into the representation of the county by two knights of the shire elected by the county court to serve in parliament, and this representation continued unaltered save for a short period during the Protectorate, until 1832, when many of the counties received a much larger representation, which was still further increased by later acts.

The royal control over the county was strengthened from the 14th century onward by the appointment of justices of the peace.

This system was further developed under the Tudors, while in the middle of the 16th century the military functions of the sheriff were handed over to a new officer, the lord-lieutenant, who is now more prominently associated with the headship of the county than is the sheriff. The lord-lieutenant now usually holds the older office of *custos rotulorum*, or keeper of the records of the county. The justices of the peace are appointed upon his nomination, and until lately he appointed the clerk of the peace. The latter appointment is now made by the joint committee of quarter sessions and county council.

The Tudor system of local government received little alteration until the establishment of county councils by the Local Government Act of 1888 handed over to an elected body many of the functions previously exercised by the nominated justices of the peace. For the purposes of this act the ridings of Yorkshire, the divisions of Lincolnshire, east and west Sussex, east and west Suffolk, the soke of Peterborough and the Isle of Ely are regarded as counties, so that there are now sixty administrative counties of England and Wales. Between 1373 and 1692 the crown granted to certain cities and boroughs the privilege of being counties of themselves. There were in 1835 eighteen of these counties corporate, Bristol, Chester, Coventry, Gloucester, Lincoln, Norwich, Nottingham, York and Carmarthen, each of which had two sheriffs, and Canterbury, Exeter, Hull, Lichfield, Newcastle-upon-Tyne, Poole, Southampton, Worcester and Haverfordwest, each of which had one sheriff. All these boroughs, with the exception of Carmarthen, Lichfield, Poole and Haverfordwest, which remain counties of themselves, and forty-seven others, were created county boroughs by the Local Government Act 1888, and are entirely dissociated from the control of a county council. The City of London is also a county of itself, whose two sheriffs are also sheriffs of Middlesex, while for the purposes of the act of 1888 the house-covered district which extends for many miles round the City constitutes a county.

The county has always been the unit for the organization of the militia, and from about 1782 certain regiments of the regular army were associated with particular counties by territorial titles. The army scheme of 1907-1908 provided for the formation of county associations under the presidency of the lord-lieutenant for the organization of the new territorial army.

See *Statutes of the Realm*; W. Stubbs, *Constitutional History of England (1874-1878)*; F. W. Maitland, *Domesday Book and Beyond (1897)*; Sir F. Pollock and F. W. Maitland, *History of English Law (1895)*; H. M. Chadwick, *Studies on Anglo-Saxon Institutions (1905)*, and *The Victoria History of the Counties of England*. (G. J. T.)

**COUNTY COURT**, in England, a local court of civil jurisdiction. The county court, it has been said, is at once the most ancient and the most modern of English civil tribunals. The Saxon *Curia Comitatus*, maintained after the Norman Conquest, was a local court and a small debts court. It was instituted by Alfred the Great, its jurisdiction embracing civil, and, until the reign of William I., ecclesiastical matters. The officers of the court consisted of the earldorman, the bishop and the sheriff. The court was held once in every four weeks, being presided over by the earl, or, in his absence, the sheriff. The suitors of the court, *i.e.* the freeholders, were the judges, the sheriff being simply a presiding officer, pronouncing and afterwards executing the judgment of the court. The court was not one of record. The appointment of judges of assize in the reign of Henry II., as well as the expensive and dilatory procedure of the court, brought about its gradual disuse, and other local courts, termed courts of request or of conscience, were established. These, in turn, proved unsatisfactory, owing both to the limited nature of their jurisdiction (restricted to causes of debt not exceeding 40s. in value, and to the fact that they were confined to particular places. Accordingly, with the view of making justice cheaper and more accessible the County Courts Act 1846 was passed. This act had the modest title of "An Act for the Recovery of Small Debts and Demands in England." The original limit of the jurisdiction of the new courts was £20, extended in 1850 to £50 in actions of debt, and in 1903 (by an act which came into force in 1905) to £100. Thirteen amending acts were passed, by which new jurisdiction was from time to time conferred on the county

courts, and in the year 1888 an act was passed repealing the previous acts and consolidating their provisions, with some amendment. This is now the code or charter of the county courts.

The grain of mustard-seed sown in 1846 has grown into a goodly tree, with branches extending over the whole of England and Wales; and they embrace within their ambit a more multifarious jurisdiction than is possessed by any other courts in the kingdom. England and Wales were mapped out into 59 circuits (not including the city of London), with power for the crown, by order in council, to abolish any circuit and rearrange the areas comprised in the circuits (sec. 4). There is one judge to each circuit, but the lord chancellor is empowered to appoint two judges in a circuit, provided that the total number of judges does not exceed 60. The salary of a county court judge was originally fixed at £1200, but he now receives £1500. He must at the time of his appointment be a barrister-at-law of at least seven years' standing, and not more than sixty years of age; after appointment he cannot sit as a member of parliament or practise at the bar.

Every circuit (except in Birmingham, Clerkenwell, and Westminster) is divided into districts, in each of which there is a court, with a registrar and bailiffs. The judges are directed to attend and hold a court in each district at least once in every month, unless the lord chancellor shall otherwise direct (secs. 10, 11). But in practice the judge sits several times a month in the large centres of population, and less frequently than once a month in the court town of sparsely inhabited districts. By sec. 185 of the act of 1888 the judges and officers of the city of London court have the like jurisdiction, powers, and authority as those of a county court, and the county court rules apply to that court.

The ordinary jurisdiction of the county courts may be thus tabulated:—

Subject matter.	Pecuniary limit of jurisdiction.
Common-law actions, with written consent of both parties	Unlimited.
Actions founded on contract (except for breach of promise of marriage, in which the county courts have no jurisdiction)	£100.
Actions founded on tort (except libel, slander, and seduction, in which the county courts have no jurisdiction)	£100.
Counter claims (unless plaintiff gives written notice of objection)	Unlimited.
Ejectment or questions of title to realty	£100 annual value.
Equity jurisdiction	£500.
Probate jurisdiction	£200 personalty and £300 realty.
Admiralty jurisdiction	£300.
Bankruptcy jurisdiction	Unlimited.
Replevin	Unlimited.
Interpleader transferred from High Court	£500.
Actions in contract transferred from High Court	£100.
Actions in tort transferred from High Court	Unlimited.
Companies (winding up), when the paid-up capital does not exceed	£10,000.

There is no discoverable principle upon which these limits of the jurisdiction of the county courts have been determined. But the above table is not by any means an exhaustive statement of the jurisdiction of the county courts. For many years it has been the practice of parliament to throw on the county court judges the duty of acting as judges or arbitrators for the purpose of new legislation relating to social subjects. It is impossible to classify the many statutes which have been passed since 1846 and which confer some jurisdiction, apart from that under the County Courts Act, on county courts or their judges. Some of these acts impose exceptional duties on the judges of the county courts, others confer unlimited jurisdiction concurrently with the High Court or some other court, others, again, confer limited or, sometimes, exclusive jurisdiction. A list of all the acts will be found in the *Annual County Courts Practice*. A county court judge may determine all matters of fact as well as law, but a jury may be summoned at the option of either plaintiff or defendant when the amount in dispute exceeds £5, and in actions under £5 the judge may in his discretion, on application of either of the parties, order that the action be tried by jury. The number of



jurymen impanelled and sworn at the trial was, by the County Courts Act 1903, increased from five to eight.

There is an appeal from the county courts on matters of law to a divisional court of the High Court, *i.e.* to the admiralty division in admiralty cases and to the king's bench division in other cases (sec. 120 of act of 1888). The determination of the divisional court is final, unless leave be given by that court or the court of appeal (Judicature Acts 1894). (See further APPEAL.) In proceedings under the Workmen's Compensation Act the appeal from a county court judge is to the court of appeal, with a subsequent appeal to the House of Lords. In 1908 a Committee was appointed by the lord chancellor "to inquire into certain matters of county court procedure." The committee presented a report in 1909 (H.C. 71), recommending the extension of existing county court jurisdiction, but a bill introduced to give effect to the recommendations was not proceeded with.

See *Annual County Courts Practice*, also "Fifty Years of the English County Courts," by County Court Judge Sir T. W. Snagge, in *Nineteenth Century*, October 1897.

**COUPÉ** (French for "cut off"), a small closed carriage of the brougham type, with four wheels and seats for two persons; the term is also used of the front compartment on a *diligence* or mail-coach on the continent of Europe, and of a compartment in a railway carriage with seats on one side only.

**COUPLET**, a pair of lines of verse, which are welded together by an identity of rhyme. The *New English Dict.* derives the use of the word from the French *couplet*, signifying two pieces of iron riveted or hinged together. In rhymed verse two lines which complete a meaning in themselves are particularly known as a couplet. Thus, in Pope's *Eloisa to Abelard*:—

"Speed the soft intercourse from soul to soul,  
And waft a sigh from Indus to the Pole."

In much of old English dramatic literature, when the mass of the composition is in blank verse or even in prose, particular emphasis is given by closing the scene in a couplet. Thus, in the last act of Beaumont and Fletcher's *Thierry and Theodoret* the action culminates in an unexpected rhyme:—

"And now lead on; they that shall read this story  
Shall find that virtue lives in good, not glory."

In French literature, the term couplet is not confined to a pair of lines, but is commonly used for a stanza. A "square" couplet, in French, for instance, is a strophe of eight lines, each composed of eight syllables. In this sense it is employed to distinguish the more emphatic parts of a species of verse which is essentially gay, graceful and frivolous, such as the songs in a vaudeville or a comic opera. In the 18th century, Le Sage, Piron and even Voltaire did not hesitate to engage their talents on the production of couplets, which were often witty, if they had no other merit, and were well fitted to catch the popular ear. This signification of the word *couplet* is not unknown in England, but it is not customary; it is probably used in a stricter and a more technical sense to describe a pair of rhymed lines, whether serious or merry. The normal type, as it may almost be called, of English versification is the metre of ten-syllabled rhymed lines designated as *heroic couplet*. This form of iambic verse, with five beats to each line, is believed to have been invented by Chaucer, who employs it first in the Prologue *The Legend of Good Women* the composition of which is attributed to the year 1385. That poem opens with the couplet:—

"A thousand times have I heard man tell  
That there is joy in heaven and pain in hell."

This is an absolutely correct example of the heroic couplet, which ultimately reached such majesty in the hands of Dryden and such brilliancy in those of Pope. It has been considered proper for didactic, descriptive and satirical poetry, although in the course of the 19th century blank verse largely took its place. Epigram often selects the couplet as the vehicle of its sharpened arrows, as in Sir John Harington's

"Treason doth never prosper: what's the reason?  
Why, if it prosper, none dare call it treason."

(E. G.)

**COUPON** (from Fr. *couper*, to cut), a certificate entitling its owner to some payment, share or other benefit; more specifically,

one of a series of interest certificates or dividend warrants attached to a bond running for a number of years. The word coupon (a piece cut off) possesses an etymological meaning so comprehensive that, while on the Stock Exchange it is only used to denote such an interest certificate or a certificate of stock of a joint-stock company, it may be as suitably, and elsewhere is perhaps more frequently, applied to tickets sold by tourist agencies and others. The coupons by means of which the interest on a bond or debenture is collected are generally printed at the side or foot of that document, to be cut off and presented for payment at the bank or agency named on them as they become due. The last portion, called a "talon," is a form of certificate, and entitles the holder, when all the coupons have been presented, to obtain a fresh coupon sheet. They pass by delivery, and are as a rule exempt from stamp duty. Coupons for the payment of dividends are also attached to the share warrants to bearer issued by some joint-stock companies. The coupons on the bonds of most of the principal foreign loans are payable in London in sterling as well as abroad.

**COURANTE** (a French word derived from *courir*, to run), a dance in 3-2 time march in vogue in France in the 17th century (see DANCE). It is also a musical term for a movement or independent piece based on the dance. In a *suite* it followed the *Allemande (q.v.)*, with which it is contrasted in rhythm.

**COURAYER, PIERRE FRANÇOIS LE** (1681-1776), French Roman Catholic theological writer, was born at Rouen on the 17th of November 1681. While canon regular and librarian of the abbey of St Geneviève at Paris, he conducted a correspondence with Archbishop Wake on the subject of episcopal succession in England, which supplied him with material for his work, *Dissertation sur la validité des ordinations des Anglais et sur la succession des évêques de l'Église anglicane, avec les preuves justificatives des faits avancés* (Brussels, 1723; Eng. trans. by D. Williams, London, 1725; reprinted Oxford, 1844, with memoir of the author), an attempt to prove that there has been no break in the line of ordination from the apostles to the English clergy. His opinions exposed him to a prosecution, and with the help of Bishop Atterbury, then in exile in Paris, he took refuge in England, where he was presented by the university of Oxford with a doctor's degree. In 1736 he published a French translation of Paolo Sarpi's *History of the Council of Trent*, and dedicated it to Queen Caroline, from whom he received a pension of £200 a year. Besides this he translated Sleidan's *History of the Reformation*, and wrote several theological works. He died in London on the 17th of October 1776, and was buried in the cloisters of Westminster Abbey. In his will, dated two years before his death, he declared himself still a member of the Roman Catholic Church, although dissenting from many of its opinions.

**COURBET, GUSTAVE** (1819-1877), French painter, was born at Ornans (Doubs) on the 10th of June 1819. He went to Paris in 1839, and worked at the studio of Steuben and Hesse; but his independent spirit did not allow him to remain there long, as he preferred to work out his own way by the study of Spanish, Flemish and French painters. His first works, an "Odalisque," suggested by Victor Hugo, and a "Lélia," illustrating George Sand, were literary subjects; but these he soon abandoned for the study of real life. Among other works he painted his own portrait with his dog, and "The Man with a Pipe," both of which were rejected by the jury of the Salon; but the younger school of critics, the neo-romantics and realists, loudly sang the praises of Courbet, who by 1849 began to be famous, producing such pictures as "After Dinner at Ornans" and "The Valley of the Loire." The Salon of 1850 found him triumphant with the "Burial at Ornans," the "Stone-Breakers" and the "Peasants of Flazey." His style still gained in individuality, as in "Village Damsels" (1852), the "Wrestlers," "Bathers," and "A Girl Spinning" (1852). Though Courbet's realistic work is not devoid of importance, it is as a landscape and sea painter that he will be most honoured by posterity. Sometimes, it must be owned, his realism is rather coarse and brutal, but when he paints the forests of Franche-Comté, the "Stag-Fight," "The Wave," or the "Haunt of the Does," he is inimitable. When Courbet had

made a name as an artist he grew ambitious of other glory; he tried to promote democratic and social science, and under the Empire he wrote essays and dissertations. His refusal of the cross of the Legion of Honour, offered to him by Napoleon III., made him immensely popular, and in 1871 he was elected, under the Commune, to the chamber. Thus it happened that he was responsible for the destruction of the Vendôme column. A council of war, before which he was tried, condemned him to pay the cost of restoring the column, 300,000 francs (£12,000). To escape the necessity of working to the end of his days at the orders of the State in order to pay this sum, Courbet went to Switzerland in 1873, and died at La Tour du Peilz, on the 31st of December 1877, of a disease of the liver aggravated by intemperance. An exhibition of his works was held in 1882 at the *École des Beaux-Arts*.

See Champfleury, *Les Grandes Figures d'hier et d'aujourd'hui* (Paris, 1861); Mantz, "G. Courbet," *Gaz. des beaux-arts* (Paris, 1878); Zola, *Mes Haines* (Paris, 1879); C. Lemonnier, *Les Peintres de la Vie* (Paris, 1888). (H. FR.)

**COURBEVOIE**, a town of northern France, in the department of Seine, 5 m. W.N.W. of Paris on the railway to Versailles. Pop. (1906) 29,339. It is a residential suburb of Paris, and has a fine avenue opening on the Neuilly bridge, and forming with it a continuation of the Champs Élysées. It carries on bleaching and the manufacture of carriage bodies, awnings, drugs, biscuits, &c.

**COURCELLE - SENEUIL, JEAN GUSTAVE** (1813-1892), French economist, was born at Seneuil (Dordogne) on the 22nd of December 1813. Seneuil was an additional name adopted from his native place. Devoting himself at first to the study of the law, he was called to the French bar in 1835. Soon after, however, he returned to Dordogne and settled down as a manager of iron-works. He found leisure to study economic and political questions, and was a frequent contributor to the republican papers. On the establishment of the second republic in 1848 he became director of the public domains. After the *coup d'état* of Napoleon III. in 1851 he went to South America, and held the professorship of political economy at the National Institute of Santiago, in Chile, from 1853 to 1863, when he returned to France. In 1879 he was made a councillor of state, and in 1882 was elected a member of the *Académie des sciences morales et politiques*. He died at Paris on the 29th of June 1892. Courcelle-Seneuil, as an economist, was strongly inclined towards the liberal school, and was equally partial to the historical and experimental methods; but his best energies were directed to applied economy and social questions. His principal work is *Traité théorique et pratique d'économie politique* (2 vols., 1858); among his others may be mentioned *Traité théorique et pratique des opérations de banque* (1853); *Études sur la science sociale* (1862); *La Banque libre* (1867); *Liberté et socialisme* (1868); *Protection et libre échange* (1879); he also translated into French John Stuart Mill's *Principles*.

**COURCI, JOHN DE** (d. 1219?), Anglo-Norman conqueror of Ulster, was a member of a celebrated Norman family of Oxfordshire and Somersetshire, whose parentage is unknown, and around whose career a mass of legend has grown up. It would appear that he accompanied William Fitz-Aldelm to Ireland when the latter, after the death of Strongbow, was sent thither by Henry II., and that he immediately headed an expedition from Dublin to Ulster, where he took Downpatrick, the capital of the northern kingdom. After some years of desultory fighting de Courci established his power over that part of Ulster comprised in the modern counties of Antrim and Down, throughout which he built a number of castles, where his vassals, known as "the barons of Ulster," held sway over the native tribes. After the accession of Richard I., de Courci in conjunction with William de Lacy appears in some way to have offended the king by his proceedings in Ireland. De Lacy quickly made his peace with Richard, while de Courci defied him; and the subsequent history of the latter consisted mainly in the vicissitudes of a lasting feud with the de Lacys. In 1204 Hugh de Lacy utterly defeated de Courci in battle, and took him prisoner. De Courci, however,

soon obtained his liberty, probably by giving hostages as security for a promise of submission which he failed to carry out, seeking an asylum instead with the O'Neills of Tyrone. He again appeared in arms on hearing that Hugh de Lacy had obtained a grant of Ulster with the title of earl; and in alliance with the king of Man he ravaged the territory of Down; but was completely routed by Walter de Lacy, and disappeared from the scene till 1207, when he obtained permission to return to England. In 1210 he was in favour with King John, from whom he received a pension, and whom he accompanied to Ireland. There is some indication of his having sided with John in his struggle with the barons; but of the later history of de Courci little is known. He probably died in the summer of 1219. Both de Courci and his wife Affreca were benefactors of the church, and founded several abbeys and priories in Ulster.

A story is told that de Courci when imprisoned in the Tower volunteered to act as champion for King John in single combat against a knight representing Philip Augustus of France; that when he appeared in the lists his French opponent fled in panic; whereupon de Courci, to gratify the French king's desire to witness his prowess, "cleft a massive helmet in twain at a single blow," a feat for which he was rewarded by a grant of the privilege for himself and his heirs to remain covered in the presence of the king and all future sovereigns of England. This tale, which still finds a place in Burke's *Peerage* in the account of the baron Kingsale, a descendant of the de Courci family, is a legend without historic foundation which did not obtain currency till centuries after John de Courci's death. The statement that he was created earl of Ulster, and that he was thus "the first Englishman dignified with an Irish title of honour," is equally devoid of foundation. John de Courci left no legitimate children.

See J. H. Round's art. "Courci, John de," in *Dictionary of National Biography*, vol. xii. (London, 1887), to which is added a bibliography of the original and later authorities for the life of de Courci.

**COURIER, PAUL LOUIS** (1773-1825), French Hellenist and political writer, was born in Paris on the 4th of January 1773. Brought up on his father's estate of Méré in Touraine, he conceived a bitter aversion for the nobility, which seemed to strengthen with time. He would never take the name "de Méré," to which he was entitled, lest he should be thought a nobleman. At the age of fifteen he was sent to Paris to complete his education; his father's teaching had already inspired him with a passionate devotion to Greek literature, and although he showed considerable mathematical ability, he continued to devote all his leisure to the classics. He entered the school of artillery at Châlons, however, and immediately on receiving his appointment as sub-lieutenant in September 1793 he joined the army of the Rhine. He served in various campaigns of the Revolutionary wars, especially in those of Italy in 1798-99 and 1806-7, and in the German campaign of 1809. He became *chef d'escadron* in 1803.

He made his first appearance as an author in 1802, when he contributed to the *Magasin encyclopédique* a critique on Johannes Schweighäuser's edition of Athenæus. In the following year appeared his *Éloge d'Hélène*, a free imitation rather than a translation from Isocrates, which he had sketched in 1798. Courier had given up his commission in the autumn of 1808, but the general enthusiasm in Paris over the preparations for the new campaign affected him, and he attached himself to the staff of a general of artillery. But he was horror-struck by the carnage at Wagram (1809), refusing from that time to believe that there was any art in war. He hastily quitted Vienna, escaping the formal charge of desertion because his new appointment had not been confirmed. The savage independence of his nature rendered subordination intolerable to him; he had been three times disgraced for absenting himself without leave, and his superiors resented his satirical humour. After leaving the army he went to Florence, and was fortunate enough to discover in the Laurentian Library a complete manuscript of Longus's *Daphnis and Chloe*, an edition of which he published in 1810. In consequence of a misadventure—blotting the manuscript—he was

involved in a quarrel with the librarian, and was compelled by the government to leave Tuscany. He retired to his estate at Vézetz (Indre-et-Loire), but frequently visited Paris, and divided his attention between literature and his farm.

After the second restoration of the Bourbons the career of Courier as political pamphleteer began. He had before this time waged war against local wrongs in his own district, and had been the adviser and helpful friend of his neighbours. He now made himself by his letters and pamphlets one of the most dreaded opponents of the government of the Restoration. The first of these was his *Pétition aux deux chambres* (1816), exposing the sufferings of the peasantry under the royalist reaction. In 1817 he was a candidate for a vacant seat in the Institute; and failing, he took his revenge by publishing a bitter *Lettre à Messieurs de l'Académie des Inscriptions et Belles-Lettres* (1819). This was followed (1819-1820) by a series of political letters of extraordinary power published in *Le Censeur Européen*. He advocated a liberal monarchy, at the head of which he doubtless wished to see Louis Philippe. The proposal, in 1821, to purchase the estate of Chambord for the duke of Bordeaux called forth from Courier the *Simple Discours de Paul Louis, vigneron de la Chavonnière*, one of his best pieces. For this he was tried and condemned to suffer a short imprisonment and to pay a fine. Before he went to prison he published a *compte rendu* of his trial, which had a still larger circulation than the *Discours* itself. In 1823 appeared the *Livret de Paul Louis, the Gazette de village*, followed in 1824 by his famous *Pamphlet des pamphlets*, called by his biographer, Armand Carrel, his swan-song. Courier published in 1807 his translation from Xenophon, *Du commandement de la cavalerie et de l'équitation*, and had a share in editing the *Collections des romans grecs*. He also projected a translation of Herodotus, and published a specimen, in which he attempted to imitate archaic French; but he did not live to carry out this plan. In the autumn of 1825, on a Sunday afternoon (August 18th), Courier was found shot in a wood near his house. The murderers, who were servants of his own, remained undiscovered for five years.

The writings of Courier, dealing with the facts and events of his own time, are valuable sources of information as to the condition of France before, during, and after the Revolution. Sainte-Beuve finds in Courier's own words, "peu de matière et beaucoup d'art," the secret and device of his talent, which gives his writings a value independent of the somewhat ephemeral subject-matter.

A *Collection complète des pamphlets politiques et opuscules littéraires de P. L. Courier* appeared in 1826. See editions of his *Œuvres* (1848), with an admirable biography by Armand Carrel, which is reproduced in a later edition, with a supplementary criticism by F. Sarcey (1876-1877); also three notices by Sainte-Beuve in the *Causeries du lundi* and the *Nouveaux Lundis*.

**COURIER** (from the O. Fr. *courier*, modern *courrier*, from Lat. *currere*, to run), properly a running messenger, who carried despatches and letters; a system of couriers, mounted or on foot, formed the beginnings of the modern post-office (see **POST**, and **POSTAL SERVICE**). The despatches which pass between the foreign office and its representatives abroad, and which cannot be entrusted to the postal service or the telegraph, are carried by special couriers, styled, in the British service, King's Messengers. "Courier," more particularly, is applied to a travelling attendant, whose duties are to arrange for the carrying of the luggage, obtaining of passports, settling of hotel accommodation, and generally to look to the comfort and facility of travel. The name "courier" and the similar word "*courant*" (Ital. *coranto*) have often been used as the title of a newspaper or periodical (see **NEWSPAPERS**); the *Courier*, founded in 1792, was for some time the leading London journal.

**COURLAND**, or **KURLAND**, one of the Baltic provinces of Russia, lying between 55° 45' and 57° 45' N. and 21° and 27° E. It is bounded on the N.E. by the river Dvina, separating it from the governments of Vitebsk and Livonia, N. by the Gulf of Riga, W. by the Baltic, and S. by the province of East Prussia and the Russian government of Kovno. The area is 10,535 sq. m., of which 101 sq. m. are occupied by lakes. The surface is generally

low and undulating, and the coast-lands flat and marshy. The interior is characterized by wooded dunes, covered with pine, fir, birch and oak, with swamps and lakes, and fertile patches between. The surface nowhere rises more than 700 ft. above sea-level. The Mitau plain divides it into two parts, of which the western is fertile and thickly inhabited, except in the north, while the eastern is less fertile and thinly inhabited. One-third of the area is still forest.

Courland is drained by nearly one hundred rivers, of which only three, the Dvina, the Aa and the Windau, are navigable. They all flow north-westwards and discharge into the Baltic Sea. Owing to the numerous lakes and marshes, the climate is damp and often foggy, as well as changeable, and the winter is severe. Agriculture is the chief occupation, the principal crops being rye, barley, oats, wheat, flax and potatoes. The land is mostly owned by nobles of German descent. In 1863 laws were issued to enable the Letts, who form the bulk of the population, to acquire the farms which they held, and special banks were founded to help them. By this means some 12,000 farms were bought by their occupants; but the great mass of the population are still landless, and live as hired labourers, occupying a low position in the social scale. On the large estates agriculture is conducted with skill and scientific knowledge. Fruit grows well. Excellent breeds of cattle, sheep and pigs are kept. Libau and Mitau are the principal industrial centres, with iron-works, agricultural machinery works, tanneries, glass and soap works. Flax spinning is mostly a domestic industry. Iron and limestone are the chief minerals; a little amber is found on the coast. The only seaports are Libau, Windau and Polangen, there being none on the Courland coast of the Gulf of Riga. The population was 619,154 in 1870; 674,437 in 1897, of whom 345,756 were women; 714,200 (estimate) in 1906. Of the whole, 79 % are Letts, 8½ % Germans, 1.7 % Russians, and 1 % each Poles and Lithuanians. In addition there are about 8 % Jews and some Lives. The chief towns of the ten districts are Mitau (Doblenkiy district), capital of the government (pop. 35,011 in 1897), Bauske (6543), Friedrichstadt (5223), Goldingen (9733), Grobin (1489), Hasenpoth (3338), Illuxt (2340), Talsen (6215), Tuckum (7542) and Windau (7132). The prevailing religion is the Lutheran, to which 76 % of the population belong; the rest belong to the Orthodox Eastern and the Roman Catholic churches.

Anciently Courland was inhabited by the Cours or Kurs, a Lettish tribe, who were subdued and converted to Christianity by the Brethren of the Sword, a German military order, in the first quarter of the 13th century. In 1237 it passed under the rule of the Teutonic Knights owing to the amalgamation of this order with that of the Brethren of the Sword. At that time it comprised the two duchies of Courland and Semgallen. Under the increasing pressure of Russia (Muscovy) the Teutonic Knights in 1561 found it expedient to put themselves under the suzerainty of Poland, the grandmaster Gotthard Kettler (d. 1587) becoming the first duke of Courland. The duchy suffered severely in the Russo-Swedish wars of 1700-9. But by the marriage in 1710 of Kettler's descendant, Duke Frederick William (d. 1711), to the princess Anne, niece of Peter the Great and afterwards empress of Russia, Courland came into close relation with the latter state, Anne being duchess of Courland from 1711 to 1730. The celebrated Marshal Saxe was elected duke in 1726, but only managed to maintain himself by force of arms till the next year. The last Kettler, William, titular duke of Courland, died in 1737, and the empress Anne now bestowed the dignity on her favourite Biren, who held it from 1737 to 1740 and again from 1763 till his death in 1772. During nearly the whole of the 18th century Courland, devastated by continual wars, was a shuttlecock between Russia and Poland; until eventually in 1795 the assembly of the nobles placed it under the Russian sceptre. The Baltic provinces—Esthonia, Livonia and Courland—ceased to form collectively one general government in 1876.

See H. Hollmann, *Kurlands Agrarverhältnisse* (Riga, 1893), and E. Seraphim, *Geschichte Liv-, Esth-, und Kurlands* (2 vols., Reval, 1895-1896).

**COURNOT, ANTOINE AUGUSTIN** (1801-1877), French economist and mathematician, was born at Gray (Haute-Saône) on the 28th of August 1801. Trained for the scholastic profession, he was appointed assistant professor at the Academy of Paris in 1831, professor of mathematics at Lyons in 1834, rector of the Academy of Grenoble in 1835, inspector-general of studies in 1838, rector of the Academy of Dijon and honorary inspector-general in 1854, retiring in 1862. He died in Paris on the 31st of March 1877. Cournot was the first who, with a competent knowledge of both subjects, endeavoured to apply mathematics to the treatment of economic questions. His *Recherches sur les principes mathématiques de la théorie des richesses* (English trans. by N. T. Bacon, with bibliography of mathematics of economics by Irving Fisher, 1897) was published in 1838. He mentions in it only one previous enterprise of the same kind (though there had in fact been others)—that, namely, of Nicholas François Canard (c.1750-1833), whose book, *Principes d'économie politique* (Paris, 1802), was crowned by the French Academy, though "its principles were radically false as well as erroneously applied." Notwithstanding Cournot's just reputation as a writer on mathematics, the *Recherches* made little impression. The truth seems to be that his results are in some cases of little importance, in others of questionable correctness, and that, in the abstractions to which he has recourse in order to facilitate his calculations, an essential part of the real conditions of the problem is sometimes omitted. His pages abound in symbols representing unknown functions, the form of the function being left to be ascertained by observation of facts, which he does not regard as a part of his task, or only some known properties of the undetermined function being used as bases for deduction. In his *Principes de la théorie des richesses* (1863) he abandoned the mathematical method, though advocating the use of mathematical symbols in economic discussions, as being of service in facilitating exposition. Other works of Cournot's were *Traité élémentaire de la théorie des fonctions et du calcul infinitésimal* (1841); *Exposition de la théorie des chances et des probabilités* (1843); *De l'origine et des limites de la correspondance entre l'algèbre et la géométrie* (1847); *Traité de l'enchaînement des idées fondamentales dans les sciences et dans l'histoire* (1861); and *Revue sommaire des doctrines économiques* (1877).

**COURSING** (from Lat. *cursus*, *currere*, to run), the hunting of game by dogs solely by sight and not by scent. From time to time the sport has been pursued by various nations against various animals, but the recognized method has generally been the coursing of the hare by greyhounds. Such sport is of great antiquity, and is fully described by Arrian in his *Cynegeticus* about A.D. 150, when the leading features appear to have been much the same as in the present day. Other Greek and Latin authors refer to the sport; but during the middle ages it was but little heard of. Apart from private coursing for the sake of filling the pot with game, public coursing has become an exhilarating sport. The private sportsman seldom possesses good strains of blood to breed his greyhounds from or has such opportunities of trying them as the public courser.

The first known set of rules in England for determining the merits of a course were drawn up by Thomas, duke of Norfolk, in Queen Elizabeth's reign; but no open trials were heard of until half a century later, in the time of Charles I. The oldest regular coursing club of which any record exists is that of Swaffham, in Norfolk, which was founded by Lord Orford in 1766; and in 1780 the Ashdown Park (Berkshire) meeting was established. During the next seventy years many other large and influential societies sprang up throughout England and Scotland, the Altcar Club (on the Sefton estates, near Liverpool) being founded in 1825. The season lasts about six months, beginning in the middle of September. It was not until 1858 that a coursing parliament, so to speak, was formed, and a universally accepted code of rules drawn up. In that year the National Coursing Club was founded. It is composed of representatives from all clubs in the United Kingdom of more than a year's standing, and possessing more than twenty-four members. Their rules govern meetings, and their committee adjudicate on matters of dispute.

A comparative trial of two dogs, and not the capture of the game pursued, is the great distinctive trait of modern coursing. A greyhound stud-book was started in 1882.

The breeding and training of a successful kennel is a precarious matter; and the most unaccountable ups and downs of fortune often occur in a courser's career. At a meeting an agreed-on even number of entries are made for each stake, and the ties drawn by lot. After the first round the winner of the first tie is opposed to the winner of the second, and so on until the last two dogs left in compete for victory; but the same owner's greyhounds are "guarded" as far as it is possible to do so. A staff of beaters drive the hares out of their coverts or other hiding-places, whilst the slipper has the pair of dogs in hand, and slips them simultaneously by an arrangement of nooses, when they have both sighted a hare promising a good course. The judge accompanies on horseback, and the six points whereby he decides a course are—(1) speed; (2) the go-by, or when a greyhound starts a clear length behind his opponent, passes him in the straight run, and gets a clear length in front; (3) the turn, where the hare turns at not less than a right angle; (4) the wrench, where the hare turns at less than a right angle; (5) the kill; (6) the trip, or unsuccessful effort to kill. He may return a "no course" as his verdict if the dogs have not been fairly tried together, or an "undecided course" if he considers their merits equal. The open Waterloo meeting, held at Altcar every spring,—the name being taken from its being originated by the proprietor of the Waterloo Hotel, Liverpool,—is now the recognized fixture for the decision of the coursing championship, and the Waterloo Cup (1836) is the "Blue Riband" of the leash. In the United States, several British colonies, and other countries, the name has been adopted, and Waterloo Coursing Cups are found there as in England. In America an American Coursing Board controls the sport, the chief meetings being in North and South Dakota, Kansas, Nebraska, Iowa and Minnesota.

The chief works on coursing are:—Arrian's *Cynegeticus*, translated by the Rev. W. Dansey (1831); T. Thacker, *Courser's Companion and Breeder's Guide* (1835); Thacker's *Courser's Annual Remembrancer* (1849-1851); D. P. Blaine, *Encyclopaedia of Rural Sports* (3rd ed., 1870); and J. H. Walsh, *The Greyhound* (3rd ed., 1875). See also the *Coursing Calendar* (since 1857); *Coursing and Falconry* (Badminton Library, 1892); *The Hare* ("Fur and Feather" series, 1896); and *The Greyhound Stud Book* (since 1882).

**COURT, ANTOINE** (1696-1760), French Protestant divine, was born in the village of Villeneuve-de-Berg, in the province of the Vivarais. He has been designated the "Restorer of Protestantism in France," and was the organizer of the "Church of the Desert." He was eight years old when the Camisard revolt was finally suppressed, and nineteen when on the 8th of March 1715 the edict of Louis XIV. was published, declaring that "he had abolished entirely the exercise of the so-called reformed religion" ("qu'il avait aboli tout exercice de la religion prétendue réformée"). Antoine, taken to the secret meetings of the persecuted Calvinists, began, when only seventeen, to speak and exhort in these congregations of "the desert." He came to suspect after a time that many of the so-called "inspired" persons were "dupes of their own zeal and credulity," and decided that it was necessary to organize at once the small communities of believers into properly constituted churches. To the execution of this vast undertaking he devoted his life. On the 21st of August 1715 he summoned all the preachers in the Cévennes and Lower Languedoc to a conference or synod near the village of Monoblet. Here elders were appointed, and the preaching of women, as well as pretended revelations, was condemned. The village of Monoblet "thus seems entitled to the honour of having had the first organized Protestant church after the revocation of the edict of Nantes" (H. M. Baird). But there were as yet no ordained pastors. Pierre Corteiz was therefore sent to seek ordination. He was ordained at Zürich, and from him Court himself received ordination. The scene of his labours for fifteen years was Languedoc, the Vivarais, and Dauphiné. His beginnings were very small prayer-meetings in "the desert." But the work progressed under his wise direction, and he was able "to be present, in 1744, at meetings of ten thousand souls." In 1724 Louis XV., again

assuming that there were no Protestants in France, prohibited the most secret exercise of the Reformed religion, and imposed severe penalties. It was impossible fully to carry out this menace. But persecution raged, especially against the pastors. A price was set on the life of Court; and in 1730 he escaped to Lausanne. He had already, with the aid of some of the Protestant princes, established a theological college ("Seminaire de Lausanne") there, and during the remaining thirty years of his life he filled the post of director. He had the title of deputy-general of the churches, and was really the pillar of their hope. The Seminary of Lausanne sent forth all the pastors of the Reformed Church of France till the days of the first French Empire. Court formed the design of writing a history of Protestantism, and made large collections for the purpose, which have been preserved in the Public Library of Geneva; but this he did not live to carry out. He died at Lausanne in 1760. He wrote, amongst other works, a *Histoire des troubles des Cévennes ou de la guerre des Camisards* (1760). He was the father of the more generally known Antoine Court de Gebelin (q.v.).

For details of his life see Napoléon Peyrat's *Histoire des pasteurs du désert* (1842; English translation, 1852); Edmond Hugues, *Antoine Court, histoire de la restauration du protestantisme en France au XVIII<sup>e</sup> siècle* (2nd ed., 1872), *Les Synodes du désert* (3 vols., 1885-1886), *Mémoires d'Antoine Court* (1885); E. and E. Haag, *La France protestante*, vol. iv. (1884, new edition); H. M. Baird, *The Huguenots and the Revocation of the Edict of Nantes* (1895), vol. ii.; cf. *Bulletin de la société de l'histoire du protestantisme français* (1893-1906).

**COURT** (from the O. Fr. *court*, Late Lat. *cortis*, *curtis*, a popular form of class. Lat. *cohors*, gen. *cohortis*; the mod. Fr. form *cour* is due to the influence of the Lat. *curia*, the word used in mediæval documents to translate "court" in the feudal sense), a word originally denoting an enclosed place, and so surviving in its architectural sense (courtyard, &c.), but chiefly used as a general term for judicial tribunals and in the special sense of the household of the king, called "the court."<sup>1</sup> All law courts were not, however, purely judicial in character; the old county court, for instance, was the assembly of the freeholders of the county in which representatives and certain officers were elected. Such assemblies in early times exercised political and legislative as well as judicial functions. But these have now been almost entirely separated everywhere, and only judicial bodies are now usually called courts. In every court, says Blackstone, there must be three parts,—an actor or plaintiff, *reus* or defendant, and *judex*, or judge.

The language of legal fictions, which English lawyers invariably use in all constitutional subjects, makes the king the ultimate source of all judicial authority, and assumes his personal presence in all the courts.

"As by our excellent constitution," says Blackstone, "the sole executive power of the laws is vested in the person of the king, it will follow that all courts of justice, which are the medium by which he administers the laws, are derived from the power of the crown. For whether created by act of parliament or letters patent, or subsisting by prescription (the only methods by which any court of judicature can exist), the king's consent in the two former is expressly, in the latter impliedly given. In all these courts the king is supposed in contemplation of law to be always present; but as that is in fact impossible, he is then represented by his judges, whose power is only an emanation of the royal prerogative."

These words might give a false impression of the historical and legal relations of the courts and the crown, if it is not remembered that they are nothing more than the expression of a venerable fiction. The administration of justice was, indeed, one of the functions of the king in early times; the king himself sat on circuit so late as the reign of Edward IV.; and even after regular tribunals were established, a reserve of judicial power still remained in the king and his council, in the exercise of which it was possible for the king to participate personally. The last judicial act of an English king, if such it can be called, was that by which James I. settled the dispute between the court of chancery and courts of common law. Since the establishment of parliamentary government the courts take their law directly from the legislature, and the king is only connected with them

<sup>1</sup> Cf. the German *Hof* for court-yard, court of law, and royal court.

indirectly as a member of the legislative body. The king's name, however, is still used in this as in other departments of state action. The courts exercising jurisdiction in England are divided by certain features which may here be briefly indicated.

We may distinguish between (1) superior and inferior courts. The former are the courts of common law and the court of chancery, now High Court of Justice. The latter are the local or district courts, county courts, &c. (2) Courts of record and courts not of record. "A court of record is one whereof the acts and judicial proceedings are enrolled for a perpetual memory and testimony, which rolls are called the records of the court, and are of such high and supereminent authority that their truth is not to be called in question. For it is a settled rule and maxim that nothing shall be averred against a record, nor shall any plea or even proof be admitted to the contrary. And if the existence of the record shall be denied it shall be tried by nothing but itself; that is, upon bare inspection whether there be any such record or no; else there would be no end of disputes. All courts of record are the courts of the sovereign in right of the crown and royal dignity, and therefore any court of record has authority to fine and imprison for contempt of its authority" (Stephen's *Blackstone*). (3) Courts may also be distinguished as civil or criminal. (4) A further distinction is to be made between courts of first instance and courts of appeal. In the former the first hearing in any judicial proceeding takes place; in the latter the judgment of the first court is brought under review. Of the superior courts, the High Court of Justice in its various divisions is a court of first instance. Over it is the court of appeal, and over that again the House of Lords. The High Court of Justice is (through divisional courts) a court of appeal for inferior courts. (5) There is a special class of local courts, which do not appear to fall within the description of either superior or inferior courts. Some, while administering the ordinary municipal law, have or had jurisdiction exclusive of their superior courts; such were the common pleas of Durham and Lancaster. Others have concurrent jurisdiction with the superior courts; such are the lord mayor's court of London, the passage court of Liverpool, &c.

The distribution of judicial business among the various courts of law in England may be exhibited as follows.

**Criminal Courts.**—(1) The lowest is that of the justice of the peace, sitting in petty sessions of two or more, to determine in a summary way certain specified minor offences. In populous districts, such as London, Manchester, &c., stipendiary magistrates are appointed, generally with enlarged powers. Besides punishing by summary conviction, justices may commit prisoners for trial at the assizes. (2) The justices in quarter sessions are commissioned to determine felonies and other offences. An act of 1842 (5 & 6 Vict. c. 38) contains a list of offences *not* triable at quarter sessions—treason, murder, forgery, bigamy, &c. (see **QUARTER SESSIONS, COURT OF**). The corresponding court in a borough is presided over by a recorder. (3) The more serious offences are reserved for the judges of the superior courts sitting under a commission of oyer and terminer or gaol delivery for each county. The assize courts, as they are called, sit in general in each county twice a year, following the division of circuits; but additional assizes are also held under acts of 1876 and 1877, which permit several counties to be united together for that purpose (see **CIRCUIT**). London, which occupies an exceptional position in all matters of judicature, has a high criminal court of its own, established by the Central Criminal Court Act 1834, under the name of the central criminal court. Its judges usually present are a rota selected from the superior judges of common law, the recorder, common serjeant, and the judge of the City of London court.<sup>2</sup> The criminal appeal court, to which all persons convicted on indictment may appeal, superseded in 1908 (by the Criminal Appeal Act 1907) the court for crown cases reserved, to which any question of law arising on the trial of a prisoner

<sup>2</sup> The sittings are held in the court-house in the Old Bailey. The old sessions house was destroyed in the Gordon riots of 1780. The building erected in its place, although enlarged from time to time, was very incommodious, and a new structure, occupying the site of Newgate Prison, which was pulled down for the purpose, was completed in 1907.



could after conviction be remitted by the judge in his discretion. To the criminal appeal court there is an appeal both on questions of fact and of law (see APPEAL).

*Civil Courts.*—In certain special cases, civil claims of small importance may be brought before justices or stipendiaries. Otherwise, and excepting the special and peculiar jurisdictions above mentioned, the civil business of England and Wales may be said to be divided between the county courts (taking small cases) and the High Court of Justice (taking all others).

The effect of the Judicature Acts on the constitution of the superior courts may be briefly stated. There is now one Supreme Court of Judicature, consisting of two permanent divisions called the High Court of Justice and the court of appeal. The former takes the jurisdiction of the court of chancery, the three common law courts, the courts of admiralty, probate, and divorce, the courts of pleas at Lancaster and Durham, and the courts created by commissions of assize, oyer and terminer, and gaol delivery. The latter takes the jurisdiction of the court of appeal in chancery (including chancery of Lancaster), the court of the lord warden of the stannaries, and of the exchequer chamber, and the appellate jurisdiction in admiralty and heresy matters of the judicial committee; and power is given to the sovereign to transfer the remaining jurisdiction of that court to the court of appeal. By the Appellate Jurisdiction Act of 1876 the House of Lords is enabled to sit for the hearing of appeals from the English court of appeal and the Scottish and Irish courts during the prorogation and dissolution of parliament. The lords of appeal, of whom three must be present, are the lord chancellor, the lords of appeal in ordinary, and peers who have held "high judicial office" in Great Britain or Ireland. The lords in ordinary are an innovation in the constitution of the House. They hold the rank of baron for life only, have a right to sit and vote in the House during tenure of office only, and a salary of £6000 per annum.

There are also many obsolete or decayed courts, of which the most noticeable are dealt with under their individual headings, as COURT BARON, COURT LEET, &c.

The history of English courts affords a remarkable illustration of the continuity that characterizes English institutions. It might perhaps be too much to say that all the courts now sitting in England may be traced back to a common origin, but at any rate the higher courts are all offshoots from the same original judicature. Leaving out of account the local courts, we find the higher jurisdiction after the Norman Conquest concentrated along with all other public functions in the king and council. The first sign of a separation of the judicial from the other powers of this body is found in the recognition of a Curia Regis, which may be described as the king's council, or a portion of it, charged specially with the management of judicial and revenue business. In relation to the revenue it became the exchequer, under which name a separate court grew up whose special field was the judicial business arising out of revenue cases. By Magna Carta the inconvenience caused by the curia following the king's person was remedied, in so far as private litigation was concerned, by the order that common pleas (Communia Placita) should be held at some fixed place; and hence arose the court of common pleas. The Curia Regis, after having thrown off these branches, is represented by the king's bench, so that from the same stock we have now three courts, differing at first in functions, but through competition for business, and the ingenious use of fictions, becoming finally the co-ordinate courts of common law of later history. But an inner circle of counsellors still surrounded the king, and in his name claimed to exercise judicial as well as other power; hence the chancellor's jurisdiction, which became, partly in harmony with the supra-legal power claimed from which it sprang, and partly through the influence of the ecclesiastical chancellors by whom it was first administered, the equity of English law. Similar developments of the same authority were the court of requests (which was destroyed by a decision of the common pleas) and the court of star chamber—a court of criminal equity, as it has been called,—which, having been made the instrument of tyranny, was abolished in 1641. Even then

the productive power of the council was not exhausted; the judicial committee of the privy council, established in 1832, superseding the previous court of delegates, exercises the jurisdiction in appeal belonging to the king-in-council. The appellate jurisdiction of the Lords rests on their claim to be the representatives of the ancient great council of the realm.

See further ADMIRALTY, HIGH COURT OF; APPEAL; CHANCERY; COMMON LAW; COMMON PLEAS, COURT OF; DIVORCE; EQUITY; &c.

*United States.*—The Federal judicial system of the United States is made by the Constitution independent both of the Legislature and of the Executive. It consists of the Supreme Court, the circuit courts, and the district courts.

The Supreme Court is created by the Constitution, and consisted in 1909 of nine judges, who are nominated by the President and confirmed by the Senate. They hold office during good behaviour, *i.e.* are removable only by impeachment, thus having a tenure even more secure than that of English judges. The court sits at Washington from October to July in every year. The sessions of the court are held in the Capitol. A rule requiring the presence of six judges to pronounce a decision prevents the division of the court into two or more benches; and while this secures a thorough consideration of every case, it also retards the despatch of business. Every case is discussed twice by the whole body, once to ascertain the view of the majority, which is then directed to be set forth in a written opinion; then again, when the written opinion, prepared by one of the judges, is submitted for criticism and adoption by the court as its judgment.

The other Federal courts have been created by Congress under a power in the Constitution to establish "inferior courts." The circuit courts consist of twenty-nine circuit judges, acting in nine judicial circuits, while to each circuit there is also allotted one of the justices of the Supreme Court. Circuit courts of appeals, established to relieve the Supreme Court, consist of three judges (two forming a quorum), and are made up of the circuit and district judges of each circuit and the Supreme Court justice assigned to the circuit. Some cases may, however, be appealed to the Supreme Court from the circuit court of appeals, and others directly from the lower courts. The district courts number (1909) ninety, in most cases having a single justice. There is also a special tribunal called the court of claims, which deals with the claims of private persons against the Federal government. It is not strictly a part of the general judicial system, but is a creation of Congress designed to relieve that body of a part of its own labours.

The jurisdiction of the Federal courts extends only to those cases in which the Constitution makes Federal law applicable. All other cases are left to the state courts, from which there is no appeal to the Federal courts, unless where some specific point arises which is affected by the Federal Constitution or a Federal law. The classes of cases dealt with by the Federal courts are as follows:—

1. Cases in law and equity arising under the Constitution, the laws of the United States, and treaties made under their authority;
2. Cases affecting ambassadors, other public ministers and consuls;
3. Cases of admiralty and maritime jurisdiction;
4. Controversies to which the United States shall be a party;
5. Controversies between two or more states, between a state and citizens of another state, between citizens of different states, between citizens of the same state claiming lands under grants of different states, and between a state or the citizens thereof and foreign states, citizens or subjects (*Const.*, Art. III., § 2). Part of this jurisdiction has, however, been withdrawn by the eleventh Amendment to the Constitution, which declares that "the judicial power of the United States shall not be construed to extend to any suit commenced or prosecuted against one of the United States by citizens of another state, or by citizens or subjects of any foreign state."

The jurisdiction of the Supreme Court is original in cases affecting ambassadors, and wherever a state is a party; in other cases it is appellate. In some matters the jurisdiction of the

Federal courts is exclusive; in others it is concurrent with that of the state courts.

As it frequently happens that cases come before state courts in which questions of Federal law arise, a provision has been made whereby due respect for the latter is secured by giving the party to a suit who relies upon Federal law, and whose contention is overruled by a state court, the right of having the suit removed to a Federal court. The Judiciary Act of 1789 (as amended by subsequent legislation) provides for the removal to the Supreme Court of the United States of "a final judgment or decree in any suit rendered in the highest court of a state in which a decision could be had, where is drawn in question the validity of a treaty or statute of, or an authority exercised under the United States, and the decision is against their validity; or where is drawn in question the validity of a statute of, or an authority exercised under, any state, on the ground of their being repugnant to the Constitution, treaties or laws of the United States, and the decision is in favour of their validity; or where any title, right, privilege or immunity is claimed under the Constitution, or any treaty or statute of, or commission held, or authority exercised under the United States, and the decision is against the title, right, privilege or immunity specially set up or claimed by either party under such Constitution, treaty, statute, commission or authority." If the decision of the state court is in favour of the right claimed under Federal law or against the validity or applicability of the state law set up, there is no ground for removal, because the applicability or authority of Federal law in the particular case could receive no further protection from a Federal court than has in fact been given by the state court.

The power exercised by the Supreme Court in declaring statutes of Congress or of state legislatures (or acts of the Executive) to be invalid because inconsistent with the Federal Constitution, has been deemed by many Europeans a peculiar and striking feature of the American system. There is, however, nothing novel or mysterious about it. As the Federal Constitution, which emanates directly from the people, is the supreme law of the land everywhere, any statute passed by any lower authority (whether the Federal Congress or a state legislature), which contravenes the Constitution, must necessarily be invalid in point of law, just as in the United Kingdom a railway by-law which contravened an act of parliament would be invalid. Now, the functions of judicial tribunals—of all courts alike, whether Federal or state, whether superior or inferior—is to interpret the law, and if any tribunal finds a Congressional statute or state statute inconsistent with the Constitution, the tribunal is obliged to hold such statute invalid. A tribunal does this not because it has any right or power of its own in the matter, but because the people have, in enacting the Constitution as a supreme law, declared that all other laws inconsistent with it are *ipso jure* void. When a tribunal has ascertained that an inferior law is thus inconsistent, that inferior law is therewith, so far as inconsistent, to be deemed void. The tribunal does not enter any conflict with the Legislature or Executive. All it does is to declare that a conflict exists between two laws of different degrees of authority, whence it necessarily follows that the weaker law is extinct. This duty of interpretation belongs to all tribunals, but as constitutional cases are, if originating in a lower court, usually carried by appeal to the Supreme Court, men have grown accustomed to talk of the Supreme Court as in a special sense the guardian of the Constitution.

The Federal courts never deliver an opinion on any constitutional question unless or until that question is brought before them in the form of a lawsuit. A judgment of the Supreme Court is only a judgment on the particular case before it, and does not prevent a similar question being raised again in another lawsuit, though of course this seldom happens, because it may be assumed that the court will adhere to its former opinion. There have, however, been instances in which the court has virtually changed its view on a constitutional question, and it is understood to be entitled so to do.

**COURT BARON**, an English manorial court dating from the middle ages and still in existence. It was laid down by Coke

that a manor had two courts, "the first by the common law, and is called a court baron," the freeholders ("barons") being its suitors; the other a customary court for the copyholders. Stubbs adopted this explanation, but the latest learning, expounded by Professor Maitland, holds that court baron means *curia baronis*, "*la court de seigneur*," and that there is no evidence for there being more than one court. The old view that at least two freeholders were required for its composition is also now discarded. Prof. Maitland's conclusion is that the "court baron" was not even differentiated from the "court-leet" at the close of the 13th century, but that there was a distinction of jurisdictional rights, some courts having only feudal rights, while others had regalities as well. When the court-leet was differentiated, the court baron remained with feudal rights alone. These rights he was disposed to trace to a lord's jurisdiction over his men rather than to his possession of the manor, although in practice, from an early date, the court was associated with the manor. Its chief business was to administer the "custom of the manor" and to admit fresh tenants who had acquired copyholds by inheritance or purchase, and had to pay, on so doing, a "fine" to the lord of the manor. It is mainly for the latter purpose that the court is now kept. It is normally presided over by the steward of the lord of the manor, who is a lawyer, and its proceedings are recorded on "the court rolls," of which the older ones are now valuable for genealogical as well as for legal purposes.

See *Select Pleas in Manorial and other Seigniorial Courts*, vol. i., and *The Court Baron* (Selden Society). (J. H. R.)

**COURT DE GEBELIN, ANTOINE** (1728-1784), French scholar, son of Antoine Court (*q.v.*), was born at Nîmes in 1728. He received a good education, and became, like his father, a pastor of the Reformed Church. This office, however, he soon relinquished, to devote himself entirely to literary work. He had conceived the project of a work which should set in a new light the phenomena, especially the languages and mythologies, of the ancient world; and, after his father's death, he went to Paris in order to be near the necessary books. After long years of research, he published in 1775 the first volume of his vast undertaking under the title of *Le Monde primitif, analysé et comparé avec le monde moderne*. The ninth volume appeared in 1784, leaving the work still unfinished. The literary world marvelled at the encyclopaedic learning displayed by the author, and supposed that the French Academy, or some other society of scholars, must have combined their powers in its production. Now, however, the world has well-nigh forgotten the huge quartos. These learned labours did not prevent Gebelin from pleading earnestly the cause of religious tolerance. In 1760 he published a work entitled *Les Toulousaines*, advocating the rights of the Protestants; and he afterwards established at Paris an agency for collecting information as to their sufferings, and for exciting general interest in their cause. He co-operated with Franklin and others in the periodical work entitled *Affaires de l'Angleterre et de l'Amérique* (1776, sqq.), which was devoted to the support of American independence. He was also a supporter of the principles of the economists, and Quesnay called him his well-beloved disciple. In the last year of his life he became acquainted with Mesmer, and published a *Lettre sur le magnétisme animal*. He was imposed upon by speculators in whom he placed confidence, and was reduced to destitution by the failure of a scheme in which they engaged him. He died at Paris on the 10th of May 1784.

See *La France protestante*, by the brothers Haag, tome iv.; Charles Dardier, *Court de Gebelin* (Nîmes, 1890).

**COURTENAY**, the name of a famous English family. French genealogists head the pedigree of this family with one Athon or Athos, who is said to have fortified Courtenay in Gâtinois about the year 1010. His son Josselin had, with other issue, Miles, lord of Courtenay, founder of the Cistercian abbey of Fontaine-Jean. By his wife Ermengarde, daughter of Renaud, count of Nevers, Miles left a son Renaud, one of the magnates who followed Louis le Jeune to the Holy Land. This was the last lord of Courtenay of the line of Athon. Elizabeth, his elder daughter—a younger daughter died without issue,—carried Courtenay and

other lordships to her husband Pierre, seventh and youngest son of the French king Louis VI. the Fat, the marriage taking place about 1150, and the many descendants of this royal match bore the surname of Courtenay.

Pierre, the eldest son, was founder of a short-lived dynasty of emperors of Constantinople, which ended in 1261 when Baldwin (Baudouin), last of the Frankish emperors, fled before Michael Palaeologus from a capital in flames. Baldwin's son Philip, however, bore the empty title, and his granddaughter Catherine, wife of Charles, count of Valois, was titular empress. Other lines of the royal Courtenays, sprung from Pierre of France, were lords of Champignolles, Tanlai, Yerre, Bleneau, La Ferté Loupière and Chevillon. On the death of Gaspard, sieur de Bleneau, in 1655, his cousin Louis de Courtenay, comte de Cési (*jure uxoris*) and sieur de Chevillon, had Bleneau, and reckoned himself the surviving chief of his house. He styled himself Prince de Courtenay and his family made attempts to obtain recognition for their royal blood. But their laboriously constructed genealogies availed nothing to this impoverished race. The last "Prince de Courtenay," an ex-captain of dragoons, died in 1730; his uncle Roger de Courtenay, abbé des Eschalis, who died in 1733, was the last recognized member of the line of Pierre of France.

A younger branch of the first house of Courtenay came from Josselin, second son of Josselin, son of Athon. This Josselin, a notable crusader, went to the Holy Land with the count of Blois, and held by the sword for eleven years the county of Edessa, given him by his cousin King Baldwin II. Edessa was won back by the infidel from his son Josselin, who died a prisoner in Aleppo in 1147. A grandson, also a Josselin, was seneschal of the kingdom of Jerusalem.

In England a house of Courtenay has flourished with varying fortunes since the reign of the first Angevin king. The monks of Ford, to whom they were benefactors, complacently set down their patrons as the offspring of the royal Courtenays, of whose origin they had some dim knowledge, deriving them from "Florus," son of Louis the Fat. A comparison of dates destroys the story. But they were, doubtless, Courtenays of the stock of Athon. Josselin, the first count of Edessa, has been suggested by modern writers as their founder, but the name Reynaud, borne by the first known ancestor of the English house, suggests that they may have sprung from a younger son of Josselin I. of Courtenay by his marriage about 1095 with Ermengarde, daughter of Reynaud, count of Nevers. It is also notable that the English Courtenays have, from the first introduction of armorial bearings, borne with various differences the three red roundels in a golden field, the arms of the Courtenays in France, the shield of the earls of Devonshire being identical with that of the lords of La Ferté Loupière.

Several Courtenays whose kinship cannot be exactly ascertained, appear in English records of the 12th century. One of them, Robert de Courtenay, married the daughter and heir of Reynold fitz Urse, the leader of the murderers of Archbishop Thomas Becket. His son, William, a Shropshire baron, held the castle of Montgomery, as heir by his mother of Baldwin de Buslers, or Bollers, to whom Henry I. had given it with his "niece" Sibil de Falaise. This William married Ada of Dunbar, daughter of Patrick, earl of Dunbar, but died in the reign of King John, without issue.

Reynaud de Courtenay, ancestor of the main English line, may well have been a brother of the Robert above named. The English pedigrees confuse him with his son of the same name. He was a favourite with Henry II., his attestations of charters showing him as a constant companion at home and abroad of the king, whom he followed to Wexford in the Irish expedition of 1172. Henry gave him Berkshire lands at Sutton, still known as Sutton Courtenay, by a charter to which the date of 1161 can be assigned. In England he had to wife Maude, daughter of Robert fitz Roy by Maude of Avranches, the elder Maude being the heir of the house of Brionne. By her, who survived him, dying before January 1224, he had no issue, but by a wife who may have died before his coming to England he had, with other issue,

Robert and Reynaud. Robert, who succeeded to Sutton about 1192, was husband of Alice de Rumeli, widow of Gilbert Pipard, and one of the three sisters and co-heirs of William, the boy of Egremont, of whose drowning in the Strid Wordsworth has made a ballad. Robert died childless in 1209. Of his brother Reynaud or Reynold de Courtenay little is known, save that he was a married man in 1178 when he and his wife Hawise were given by the pope a licence to have a free chapel at Okehampton. This wife, Hawise de Ayencourt, was, with Maude his father's second wife, a daughter and co-heir of Maude of Avranches, her father being the lord of Ayencourt, first husband of the last named Maude. Her great inheritance included the honour of Okehampton in Devonshire of which, as a widow, she had livery about 1205. Her son, Robert de Courtenay, succeeded to her land in 1219, having been his uncle Robert's heir in Sutton ten years before. Like his father he advanced his house by a great marriage, his wife being Mary, the younger daughter of William de Vernon, earl of Devon and of the Isle of Wight. He was succeeded in 1242 by his son John, who by Isabel, a daughter of Hugh de Vere, earl of Oxford, has issue Hugh, whose wife was Eleanor, daughter of the earl of Winchester, elder of the two favourites of Edward II. The son of this marriage, another Hugh, followed his father at Okehampton in 1291. Two years later died Isabel, surviving sister and heir of Baldwin de Reviers, earl of Devon, and widow of William de Forz, last earl of Aumerle (Albemarle). On her death-bed she had granted her lordship of the Wight to the king, but her cousin Hugh de Courtenay succeeded her in the unalienated estates of the house of Reviers. He was summoned as a baron on the 6th of February 1298/9, and in 1300 he displayed his banner before the castle of Caerlaverock. Claiming the "third penny" of the county of Devon, he was refused by the exchequer as he did not claim in the name of an earl. Following, however, a writ of inquiry, a patent of the 22nd of February 1334/5 declared him earl of Devon and qualified to take such style as his ancestors, earls of Devon, were wont to take. Hugh, his son, the second earl, a warrior who drove the French back from their descent on Cornwall in 1339, made another of the brilliant marriages of this family, his wife being Eleanor, daughter of Humfrey de Bohun, earl of Hereford and Essex, by Elizabeth daughter of Edward I. Their eldest son, Sir Hugh de Courtenay, shared in the honours of Crécy and Calais, and was one of the knights founders of the order of the Garter, the stall-plate of his arms being yet in St George's chapel at Windsor. This knight died in the lifetime of the earl, as did his only son Hugh, summoned as a baron on the 3rd of January 1370/1, a companion at Najara of the Black Prince, whose step-daughter Maude of Holland he had married. The earl was therefore succeeded by his grandson Edward (son of Edward his third son), earl marshal of England in 1385, who died blind in 1419, the year after the death of Sir Edward his heir apparent, one of the conquerors at Agincourt. Hugh, a second son of Earl Edward, succeeded as fourth earl of the Courtenay line. By his wife, a sister of the renowned Talbot, earl of Shrewsbury, he had issue Thomas the fifth earl, a partisan of Henry VI., whose wife was Margaret Beaufort, daughter of John, earl of Somerset. The effigy of this granddaughter of John of Gaunt, with the shields of Courtenay and Beaufort above it, is in Colyton church. It is less than life size, a fact which has given rise to a village legend that it represents "Little choke-a-bone," an infant daughter of the tenth earl, who died "choked by a fish bone." In spite of the evidence of the shields and the 15th century dress of the effigy, the legend has now been strengthened by an inscription upon a brass plate, and in the year 1907 ignorance engaged a monumental sculptor to deface the effigy by giving its broken features the newly carved face of a young child. Both sons of this marriage fell in the Wars of the Roses, Thomas the sixth earl being taken at Towton by the Yorkists and beheaded at York in 1462, his younger brother Henry having the same fate at Salisbury in 1466.

The earldom being extinguished by attainder, Sir Humphrey Stafford was created earl of Devon in 1469, but in the same year, having retired with his men from the expedition against

Robin of Redesdale, another earl of Devon suffered at the headsman's hands, his patent being afterwards annulled by a statute of Henry VII. On the restoration of Henry VI. John Courtenay, only surviving brother of Thomas and Henry, was restored to the earldom by the reversal of attainder. He, too, died in the Lancastrian cause, being killed on the 4th of May 1471 at Tewkesbury, where he led the rear of the host. The representation of the Reviers earls and of the Courtenay barony fell then to his sisters and their descendants. Beside him at Tewkesbury died his cousin Sir Hugh Courtenay of Boconnoc, son of Hugh, a younger brother of the blind earl, leaving a son Edward, who thus became the heir male of the house though not its heir general. Joining in the cause which had cost so many of his kinsmen their lives, he and his brother Walter shared the duke of Buckingham's rising. On its failure they fled into France to the earl of Richmond, beside whom Sir Edward fought at Bosworth. By a patent of the 26th of October 1485 he was created earl of Devon with remainder to the heirs male of his body, and by an act of 1485 he was restored to all honours lost in his attainder by the Yorkist parliament. He defended Exeter against Warbeck's rebels and was a knight of the Garter in 1489, dying twenty years later, when the earldom became again forfeit by his son's attainder. That son, William Courtenay, had drawn the jealousy of Henry VII. by a marriage with Catherine, sister of the queen and daughter of King Edward IV., the Yorkist sovereign whose hand had been so heavy on the Courtenays. After the queen's death, Henry sent his wife's brother-in-law to the Tower on a charge of corresponding with Edmund Pole, an attainder following. But on the accession of Henry VIII., the young king released his uncle, who although styled an earl was not fully restored in blood at his death in 1511. His son Henry Courtenay obtained from parliament in December 1512 a reversal of his father's attainder, thus succeeding to the earldom of his grandfather. At the Field of Cloth of Gold he ran a course with the king of France. He was knight of the Garter and on the 15th of June 1525 had a patent as marquess of Exeter. Profiting by the suppression of the monasteries he increased his estate, his power being all but supreme in the west country. But Cromwell was his enemy and the royal strain in his blood was a dangerous thing. Involved in correspondence with Cardinal Pole, he was sent to the Tower with his wife and his young son, and on the 9th of December 1538 he was beheaded as a traitor. The misfortunes of the house were heavy upon the son, who at twelve years old was a prisoner for the sake of his high descent. His honours had been forfeited, and release did not come until the accession of Queen Mary, who took him into favour. Noailles the ambassador found him *le plus beau et le plus agréable gentilhomme d'Angleterre*, and he had some hopes of becoming king consort. The queen created him earl of Devonshire by a patent of the 3rd of September 1553 and in the next month he was restored in blood. But, disappointed in his hopes, he formed some wild plans for marrying the Lady Elizabeth and making her queen. He could raise Devon and Cornwall. Wyatt did raise Kent, but the plot was soon crushed. The earl was sent back to the Tower and thence to Fotheringhay. At Easter of 1555 he was released on parole and exiled, dying suddenly at Padua in 1556. His co-heirs were the descendants of the four sisters of Earl Edward (d. 1519), the wives of four Cornish squires, and with him was extinguished, to the belief of all men, the Courtenays' earldom of Devon. His heir male was Sir William Courtenay, his sixth cousin once removed, head of a knightly line of Courtenays whose seat was Powderham Castle, a line which, during the civil wars, stood for the White Rose. Sir William, who is said to have been killed at St Quintin in 1557, was succeeded by his son, another Sir William, one of the undertakers for the settling of Ireland, where the family obtained great estates. William Courtenay of Powderham, of whose marriage with the daughter of Sir William Waller (the parliament's general) it is remarked that the years of bride and bridegroom added together were less than thirty when their first child was born, was created a baronet by writ of privy seal in February 1644, the patent being never enrolled. His great grandson, Sir William Courtenay, many years a member of parliament, was on

the 6th of May 1762, ten days before his death, created Viscount Courtenay of Powderham Castle.

Since the death at Padua in 1556 of Edward, earl of Devon, that ancient title had been twice revived. Charles Blount, Lord Mountjoy, who was created earl of Devon in 1603, died without lawful issue in 1606. In 1618 Sir William Cavendish, son of the famous Bess of Hardwick, was given the same title, which is still among the peerage honours of the ducal house descending from him. For the Courtenays, who had without protest accepted a baronetcy and a viscounty, their earldom was dead. In the reign of William IV., the third and last Viscount Courtenay was living unmarried in Paris, an exile who for sufficient reasons was keeping out of the reach of the English criminal law. In the name of this man, his presumptive heir male, William Courtenay, clerk assistant of the parliament, succeeded in persuading the House of Lords that the Courtenay earldom under the patent of 1553 was still in existence, the plea being that the terms of the remainder—to him and his heirs male for ever—did not limit the succession to heirs male of the body of the grantee. Five other cases wherein the words *de corpore suo* had been omitted from the patent are known to peerage lawyers. In no case had a peerage before been claimed by collateral heirs male. "I have often rallied Brougham," writes Lord Campbell, "upon his creating William Courtenay earl of Devon. He says he consulted Chief Justice Tenterden. But Tenterden knew nothing of peerage law." After the death of the exile in 1835 the clerk of the parliament succeeded him as an earl by force of the House of Lords decision of the 15th of March 1831. His second son, the Rev. Henry Hugh Courtenay (1811-1904), succeeded, as 13th earl, a nephew whose extravagance had impoverished the estates. He in turn was followed, as 14th earl, by his grandson Charles Pepys Courtenay (b. 1870).

No other recognized branch of this house, once so widely spread in the western counties, is now among the landed houses of England. Among its cadets were many famous warriors, but three prelates must be reckoned as the most eminent of the Courtenays. William, a younger son of the match of Courtenay and Bohun, was bishop of Hereford in 1370, bishop of London in 1375 and archbishop of Canterbury in 1381. Proceeding against Wycliffe he opposed John of Gaunt, who, taunting him with his trust in his great kinsfolk, threatened to drag him out of St Paul's by his hair, a threat which roused the angry Londoners in his defence. He died in 1396 and lies buried at the feet of the Black Prince in his cathedral of Canterbury. By his will he left his best mitre to his nephew Richard Courtenay—son and pupil, as he styles him—against the time he should be a bishop. This Richard, a friend of Henry V. when prince, and treasurer of his household, was bishop of Norwich in 1413. Twice chancellor of Oxford, he repelled Archbishop Arundel and all his train when that primate would have had a visitation of the university, although the claim of the university to independence was at last broken down. Tall of stature, eloquent and learned, he kept the favour of the king, who was with him when he died of dysentery in the host before Harfleur. Heir of this bishop was his nephew Sir Philip of Powderham, whose younger son Peter Courtenay was the third of the Courtenay prelates, being bishop of Exeter from 1478 to 1487, when he was translated to Winchester. Although of the Yorkist Courtenays, he was of Buckingham's party and, being attainted by Richard III. for joining with certain of his kinsfolk in an attempt to raise the west, he escaped to Brittany, whence he returned with the first Tudor sovereign, who had him in high favour. A fourth prelate of this family was Henry Reginald Courtenay, who was bishop of Bristol 1794-1797 and bishop of Exeter from 1797 to his death in 1803.

See charter, patent, close, fine and plea rolls, inquests *post mortem*, and other records. G. E. C.'s *Complete Peerage*; *Dictionary of National Biography*; *Notes and Queries*, series viii. vol. 7; J. H. Round's *Peerage Studies*; *Calendars of State Papers*; Machyn's *Diary* (Camden Society); *Chronicles of Capgrave, Wavrin, Adam of Usk*, &c. (O. BA.)

**COURTENAY, RICHARD** (d. 1415), English prelate, was a son of Sir Philip Courtenay of Powderham Castle, near Exeter, and a grandson of Hugh Courtenay, earl of Devon (d. 1377). He

was a nephew of William Courtenay, archbishop of Canterbury, and a descendant of Edward I. Educated at Exeter College, Oxford, he entered the church, where his advance was rapid. He held several prebends, was dean of St Asaph and then dean of Wells, and became bishop of Norwich in 1413. As chancellor of the university of Oxford, an office to which he was elected in 1407 and again in 1410, Courtenay asserted the independence of the university against Thomas Arundel, archbishop of Canterbury, in 1411; but the archbishop, supported by Henry IV. and Pope John XXIII., eventually triumphed. Courtenay was a personal friend of Henry V. both before and after he came to the throne; and in 1413, immediately after Henry's accession, he was made treasurer of the royal household. On two occasions he went on diplomatic errands to France, and he was also employed by Henry on public business at home. Having accompanied the king to Harfleur in August 1415, Courtenay was attacked by dysentery and died on the 15th of September 1415, his body being buried in Westminster Abbey.

Another member of this family, PETER COURTENAY (d. 1492), a grandnephew of Richard, also attained high position in the English Church. Educated at Exeter College, Oxford, Peter became dean of Windsor, then dean of Exeter; in 1478 bishop of Exeter; and in 1487 bishop of Winchester in succession to William of Waynflete. With Henry Stafford, duke of Buckingham, and others he attempted to raise a rebellion against Richard III. in 1483, and fled to Brittany when this enterprise failed. Courtenay was restored to his dignities and estates in 1485 by Henry VII., whom he had accompanied to England, and he died on the 23rd of September 1492.

See J. H. Wylie, *History of England under Henry IV.* (London, 1884-1898).

**COURTENAY, WILLIAM** (c. 1342-1396), English prelate, was a younger son of Hugh Courtenay, earl of Devon (d. 1377), and through his mother Margaret, daughter of Humphrey Bohun, earl of Hereford, was a great-grandson of Edward I. Being a native of the west of England he was educated at Stapledon Hall, Oxford, and after graduating in law was chosen chancellor of the university in 1367. Courtenay's ecclesiastical and political career began about the same time. Having been made prebendary of Exeter, of Wells and of York, he was consecrated bishop of Hereford in 1370, was translated to the see of London in 1375, and became archbishop of Canterbury in 1381, succeeding Simon of Sudbury in both these latter positions. As a politician the period of his activity coincides with the years of Edward III.'s dotage, and with practically the whole of Richard II.'s reign. From the first he ranged himself among the opponents of John of Gaunt, duke of Lancaster; he was a firm upholder of the rights of the English Church, and was always eager to root out Lollardy. In 1373 he declared in convocation that he would not contribute to a subsidy until the evils from which the church suffered were removed; in 1375 he incurred the displeasure of the king by publishing a papal bull against the Florentines; and in 1377 his decided action during the quarrel between John of Gaunt and William of Wykeham ended in a temporary triumph for the bishop. Wycliffe was another cause of difference between Lancaster and Courtenay. In 1377 the reformer appeared before Archbishop Sudbury and Courtenay, when an altercation between the duke and the bishop led to the dispersal of the court, and during the ensuing riot Lancaster probably owed his safety to the good offices of his foe. Having meanwhile become archbishop of Canterbury Courtenay summoned a council, or synod, in London, which condemned the opinions of Wycliffe; he then attacked the Lollards at Oxford, and urged the bishops to imprison heretics. He was for a short time chancellor of England during 1381, and in January 1382 he officiated at the marriage of Richard II. with Anne of Bohemia, afterwards crowning the queen. In 1382 the archbishop's visitation led to disputes with the bishops of Exeter and Salisbury, and Courtenay was only partially able to enforce the payment of a special tax to meet his expenses on this occasion. During his concluding years the archbishop appears to have upheld the papal authority in England, although not to the injury of the English Church.

He protested against the confirmation of the statute of provisors in 1390, and he was successful in slightly modifying the statute of praemunire in 1393. Disliking the extravagance of Richard II. he publicly reproved the king, and after an angry scene the royal threats drove him for a time into Devonshire. In 1386 he was one of the commissioners appointed to reform the kingdom and the royal household, and in 1387 he arranged a peace between Richard and his enemies under Thomas of Woodstock, duke of Gloucester. Courtenay died at Maidstone on the 31st of July 1396, and was buried in Canterbury cathedral.

See W. F. Hook, *Lives of the Archbishops of Canterbury*, vol. iv. (London, 1860-1876); and W. Stubbs, *Constitutional History*, vols. ii. and iii. (Oxford, 1895-1896).

**COURTESY** (O. Fr. *curtesie*, later *courtoisie*), manners or behaviour that suit a court, politeness, due consideration for others. A special application of the word is in the expression "by courtesy," where something is granted out of favour and not of right, hence "courtesy" titles, i.e. those titles of rank which are given by custom to the eldest sons of dukes, marquesses and earls, usually the second title held by the father; to the younger sons and to the daughters of dukes and marquesses, viz. the prefix "lord" and "lady" with the Christian and surname. For "tenure by the courtesy" see CURTESY. Another form of the word, "curtsey" or "curtsy," was early confined to the expression of courtesy or respect by a gesture or bow, now only of the reverence made by a woman, consisting in a bending of the knees accompanied by a lowering of the body.

**COURTHOPE, WILLIAM JOHN** (1842- ), English writer and historian of poetry, whose father was rector of South Malling, Essex, was born on the 17th of July 1842. From Harrow school he went to New College, Oxford; took first-classes in classical "moderations" and "greats"; and won the Newdigate prize for poetry (1864) and the Chancellor's English essay (1868). He seemed destined for distinction as a poet, his volume of *Ludibria Lunae* (1869) being followed in 1870 by the remarkably fine *Paradise of Birds*. But a certain academic quality of mind seemed to check his output in verse and divert it into the field of criticism. Apart from many contributions to the higher journalism, his literary career is associated mainly with his continuation of the edition of Pope's works, begun by Whitwell Elwin (1816-1900), which appeared in ten volumes from 1871-1889; his life of Addison (Men of Letters series, 1882); his *Liberal Movement in English Literature* (1885); and his tenure of the professorship of Poetry at Oxford (1895-1901), which resulted in his elaborate *History of English Poetry* (the first volume appearing in 1895), and his *Life in Poetry* (1901). He deals with the history of English poetry as a whole, and in its unity as a result of the national spirit and thought in succeeding ages, and attempts to bring the great poets into relation with this. In 1887 he was appointed a civil service commissioner, being first commissioner in 1892, and being made a C.B. He was made an honorary fellow of his old college at Oxford in 1896, and was given the honorary degrees of D.Litt. by Durham in 1895 and of LL.D. by Edinburgh University in 1898.

**COURT LEET**, an English petty criminal court for the punishment of small offences. It has been usual to make a distinction between court baron and court leet<sup>1</sup> as being separate courts, but in the early history of the court leet no such distinction

<sup>1</sup> The history of the word "leet" is very obscure. It appears in Anglo-French documents as *lete* and in Anglo-Latin as *leta*. Professor W. W. Skeat has connected it with Old English *lætan*, to let, which is very doubtful, though this is the origin of the use of the word in such expressions as "two-" "three-way leet," a place where cross-roads meet. The *New English Dictionary* suggests a connexion with "lathe," a term which survives as a division of the county of Kent, containing several "hundreds." This is of Old Norwegian origin, and seems to have meant "landed possessions." There is also another Old Norwegian *leith*, a court or judicial assembly, and modern Danish has *laegd*, a division of the country for military purposes. J. H. Round (*Feudal England*, p. 101) points out that the Suffolk hundred was divided for assessment into equal blocks called "leets" (see further F. W. Maitland, *Select Pleas in Manorial Courts*, Selden Soc. Publications I. lxxiii-lxxvi). "Leet" is also used, chiefly in Scotland, for a list of persons nominated for election to an office. This is, apparently, a shortened form of the French *élite*, elected.



can be drawn. At a very early time the lords of manors exercised or claimed certain jurisdictional franchises. Of these the most important was the "view of frankpledge" and its attendant police jurisdiction. Some time in the later middle ages the court baron when exercising these powers gained the name of *leet*, and, later, of "court leet." The *quo warranto* proceedings of Edward I. established a sharp distinction between the court baron, exercising strictly manorial rights, and the court leet, depending for its jurisdiction upon royal franchise. The court leet was a court of record, and its duty was not only to view the pledges but to present by jury all crimes that might happen within the jurisdiction, and punish the same. The steward of the court acted as judge, presiding wholly in a judicial character, the ministerial acts being executed by the bailiff. The court leet began to decline in the 14th century, being superseded by the more modern courts of the justices, but in many cases courts leet were kept up until nearly the middle of the 19th century. Indeed, it cannot be said that they are now actually extinct, as many still survive for formal purposes, and by s. 40 of the Sheriffs Act 1887 they are expressly kept up.

**COURT-MARTIAL**, a court for the trial of offences against military or naval discipline, or for the administration of martial law. In England courts-martial have inherited part of the jurisdiction of the old *Curia militaris*, or court of the chivalry, in which a single marshal and at one time the high constable proceeded "according to the customs and usages of that court, and, in cases omitted according to the civil law, *secundum legem armorum*" (Coke, 4 *Ins.* 17). The modern form of the courts was adopted by ordinance in the time of Charles I., when English soldiers were studying the "articles and military laws" of Gustavus Adolphus and the Dutch military code of Arnheim; it is first recognized by statute in the first Mutiny Act of 1689. The Mutiny Act (with various extensions and amendments) and the statutory articles of war continued to be the sources of military law which courts-martial administered until 1879, when they were codified in the Army Discipline and Regulation Act 1879, which was, in turn, superseded by the Army Act 1881. This act is re-enacted annually by the Army (Annual) Act. The constitution of courts-martial, their procedure, &c., are dealt with under **MILITARY LAW**.

*Naval Courts-Martial.*—The administration of the barbarous naval law of England was long entrusted to the discretion of commanders acting under instructions from the lord high admiral, who was supreme over both the royal and merchant navy. It was the leaders of the Long Parliament who first secured something like a regular tribunal by passing in 1645 an ordinance and articles concerning martial law for the government of the navy. Under this ordinance Blake, Monk and Penn issued instructions for the holding general and ship courts-martial with written records, the one for captains and commanders, the other for subordinate officers and men. Of the latter the mate, gunner and boatswain were members, but the admirals reserved a control over the more serious sentences. Under an act of 1661 the high admiral again received power to issue commissions for holding courts-martial—a power which continues to be exercised by the board of admiralty. During the 18th century, under the auspices of Anson, the jurisdiction was greatly extended, and the Consolidation Act of 1749 was passed in which the penalty of death occurs as frequently as the curses in the commination service. The Naval Articles of War have always been statutory, and the whole system may now be said to rest on the Naval Discipline Act 1866, as amended by the act of 1884. The navy has its courts of inquiry for the confidential investigation of charges "derogatory to the character of an officer and a gentleman." Under the act of 1866 a court-martial must consist of from five to nine officers of a certain rank, and must be held publicly on board of one of H.M. ships of war, and where at least two such ships are together. The rank of the president depends on that of the prisoner. A judge-advocate attends, and the procedure resembles that in military courts, except that the prisoner is not asked to plead, and the sentence, if not one of death, does not require the confirmation

of the commander-in-chief abroad or of the admiralty at home. The court has a large and useful power of finding the prisoner guilty of a less serious offence than that charged, which might well be imitated in the ordinary criminal courts. The death sentence is always carried out by hanging at the yard-arm; Admiral Byng, however, was shot in 1757. The board of admiralty have, under the Naval Discipline Acts, a general power of suspending, annulling, and modifying sentences which are not capital. The jurisdiction extends to all persons belonging to the navy, to land forces and other passengers on board, shipwrecked crews, spies, persons borne on the books of H.M. ships in commission, and civilians on board who endeavour to seduce others from allegiance. The definition of the jurisdiction by locality includes harbours, havens or creeks, lakes or rivers, in or out of the United Kingdom; all places within the jurisdiction of the admiralty; all places on shore out of the United Kingdom; the dockyards, barracks, hospitals, &c., of the service wherever situated; all places on shore in or out of the United Kingdom for all offences punishable under the Articles of War except those specified in section 38 of the Naval Discipline Act 1860, which are punishable by ordinary law. The Royal Marines, while borne on the books of H.M. ships, are subject to the Naval Discipline Acts, and, by an order in council, 1882, when they are embarked on board ship for service on shore; otherwise they are under the Army Acts. By s. 179, sub-sec. 7, of the Army Act, in the application of the act to the Royal Marines the admiralty is substituted for military authorities.

**AUTHORITIES.**—Simmons, *On the Constitution and Practice of Courts-Martial*; Clode, *Military and Martial Law*; Stephens, Gifford and Smith, *Manual of Naval Law and Court-Martial Procedure*. The earlier writers on courts-martial are Adye (1796), M'Arthur (1813), Maltby (1813, Boston), James (1820), D'Aguilar (1843), and Hough, *Precedents in Military Law* (1855).

**COURTNEY, LEONARD HENRY COURTNEY, BARON** (1832—), English politician and man of letters, eldest son of J. S. Courtney, a banker, was born at Penzance on the 6th of July 1832. At Cambridge, Leonard Courtney was second wrangler and first Smith's prizeman, and was elected a fellow of his college, St John's. He was called to the bar at Lincoln's Inn in 1858, was professor of political economy at University College from 1872 to 1875, and in December 1876, after a previous unsuccessful attempt, was elected to parliament for Liskeard in the Liberal interest. He continued to represent the borough, and the district into which it was merged by the Reform Act of 1885, until 1900, when his attitude towards the South African War—he was one of the foremost of the so-called "Pro-Boer" party—compelled his retirement. Until 1885 he was a devoted adherent of Mr Gladstone, particularly in finance and foreign affairs. In 1880 he was under-secretary of state for the home department, in 1881 for the colonies, and in 1882 secretary to the treasury; but he was always a stubborn fighter for principle, and upon finding that the government's Reform Bill in 1884 contained no recognition of the scheme for proportional representation, to which he was deeply committed, he resigned office. He refused to support Mr Gladstone's Home Rule Bill in 1885, and was one of those who chiefly contributed to its rejection, and whose reputation for unbending integrity and intellectual eminence gave solidity to the Liberal Unionist party. In 1886 he was elected chairman of committees in the House of Commons, and his efficiency in this office seemed to mark him out for the speakership in 1895. A Liberal Unionist, however, could only be elected by Conservative votes, and he had made himself objectionable to a large section of the party by his independent attitude on various questions, on which his Liberalism outweighed his party loyalty. He would in any case have been incapacitated by an affection of the eyesight, which for a while threatened to withdraw him from public life altogether. After 1895 Mr Courtney's divergences from the Unionist party on questions other than Irish politics became gradually more marked. He became known in the House of Commons principally for his candid criticism of the measures introduced by his nominal leaders, and he was rather to be ranked among the Opposition than as a Ministerialist; and when the crisis with the Transvaal

came in 1899, Mr Courtney's views, which remained substantially what they were when he supported the settlement after Majuba in 1881, had plainly become incompatible with his position even as a nominal follower of Lord Salisbury and Mr Chamberlain. He gradually reverted to formal membership of the Liberal party, and in January 1906 unsuccessfully contested a division of Edinburgh as a supporter of Sir Henry Campbell-Bannerman at the general election. Among the birthday honours of 1906 he was elevated to the peerage as Baron Courtney of Penwith (Cornwall). Lord Courtney, who in 1883 married Miss Catherine Potter (an elder sister of Mrs Sidney Webb), was a prominent supporter of the women's movement. In earlier years he was a regular contributor to *The Times*, and he wrote numerous essays in the principal reviews on political and economic subjects. In 1901 he published a book on *The Working Constitution of the United Kingdom*.

Two of his brothers, John Mortimer Courtney (b. 1838), and William Prideaux Courtney (b. 1845), also attained public distinction, the former in the government service in Canada (from 1869, retiring in 1906), rising to be deputy-minister of finance, and the latter in the British civil service (1865-1892), and as a prominent man of letters and bibliographer.

**COURTOIS, JACQUES** (1621-1676) and **GUILLAUME** (1628-1679). The two French painters who bore these names are also called by the Italian equivalents Giacomo (or Jacopo) Cortese and Guglielmo Cortese. Each of the brothers is likewise named, from his native province, Le Bourguignon, or Il Borgognone.

Jacques Courtois was born at St Hippolyte, near Besançon, in 1621. His father was a painter, and with him Jacques remained studying up to the age of fifteen. Towards 1637 he came to Italy, was hospitably received at Milan by a Burgundian gentleman, and entered, and for three years remained in, the French military service. The sight of some battle-pictures revived his taste for fine art. He went to Bologna, and studied under the friendly tutelage of Guido; thence he proceeded to Rome, where he painted, in the Cistercian monastery, the "Miracle of the Loaves." Here he took a house and after a while entered upon his own characteristic style of art, that of battle-painting, in which he has been accounted to excel all other old masters; his merits were cordially recognized by the celebrated Cerquozzi, named Michelangelo delle Battaglie. He soon rose from penury to ease, and married a painter's beautiful daughter, Maria Vagini; she died after seven years of wedded life. Prince Matthias of Tuscany employed Courtois on some striking works in his villa, Lappoggio, representing with much historical accuracy the prince's military exploits. In Venice also the artist executed for the senator Sagredo some remarkable battle-pieces. In Florence he entered the Society of Jesus, taking the habit in Rome in 1655; it was calumniously rumoured that he adopted this course in order to escape punishment for having poisoned his wife. As a Jesuit father, Courtois painted many works in churches and monasteries of the society. He lived piously in Rome, and died there of apoplexy on the 20th of May 1676 (some accounts say 1670 or 1671). His battle-pieces have movement and fire, warm colouring (now too often blackened), and great command of the brush,—those of moderate dimensions are the more esteemed. They are slight in execution, and tell out best from a distance. Courtois etched with skill twelve battle-subjects of his own composition. The Dantzig painter named in Italy Pandolfo Reschi was his pupil.

Guillaume Courtois, born likewise at St Hippolyte, came to Italy with his brother. He went at once to Rome, and entered the school of Pietro da Cortona. He studied also the Bolognese painters and Giovanni Barbieri, and formed for himself a style with very little express mannerism, partly resembling that of Maratta. He painted the "Battle of Joshua" in the Quirinal Gallery, the "Crucifixion of St Andrew" in the church of that saint on Monte Cavallo, various works for the Jesuits, some also in co-operation with his brother. His last production was Christ admonishing Martha. His draughtsmanship is better than that of Jacques, whom he did not, however, rival in spirit, colour or composition. He also executed some etchings. Guillaume Courtois died of gout on the 15th of June 1679.

**COURTRAI** (Flemish, *Kortryk*), an important and once famous town of West Flanders, Belgium, situated on the Lys. Pop. (1904) 34,564. It is now best known for its fine linen, which ranks with that of Larne. The lace factories are also important and employ 5000 hands. But considerable as is the prosperity of modern Courtrai it is but a shadow of what it was in the middle ages during the halcyon period of the Flemish communes. Then Courtrai had a population of 200,000, now it is little over a sixth of that number. On the 11th of July 1302 the great battle of Courtrai (see INFANTRY) was fought outside its walls, when the French army, under the count of Artois, was vanquished by the allied burghers of Bruges, Ypres and Courtrai with tremendous loss. As many as 700 pairs of golden spurs were collected on the field from the bodies of French knights and hung up as an offering in an abbey church of the town, which has long disappeared. There are still, however, some interesting remains of Courtrai's former grandeur. Perhaps the Pont de Broel, with its towers at either end of the bridge, is as characteristic and complete as any monument of ancient Flanders that has come down to modern times. The hôtel de ville, which dated from the earlier half of the 16th century, was restored in 1846, and since then statues have also been added to represent those that formerly ornamented the façade. Two richly and elaborately carved chimney-pieces in the hôtel de ville merit special notice. The one in the council chamber upstairs dates from 1527 and gives an allegorical representation of the Virtues and the Vices. The other, three-quarters of a century later, contains an heraldic representation of the noble families of the town. The church of St Martin dates from the 15th century, but was practically destroyed in 1862 by a fire caused by lightning. It has been restored. The most important building at Courtrai is the church of Notre Dame, which was begun by Count Baldwin IX. in 1191 and finished in 1211. The portal and the choir were reconstructed in the 18th century. In the chapel behind the choir is hung one of Van Dyck's masterpieces, "The Erection of the Cross." The chapel of the counts attached to the church dates from 1373, and contained mural paintings of the counts and countesses of Flanders down to the merging of the title in the house of Burgundy. Most if not all of these had become obliterated, but they have now been carefully restored. With questionable judgment portraits have been added of the subsequent holders of the title down to the emperor Francis II. (I. of Austria), the last representative of the houses of Flanders and Burgundy to rule in the Netherlands. Courtrai celebrated the 600th anniversary of the battle mentioned above by erecting a monument on the field in 1902, and also by fêtes and historical processions that continued for a fortnight.

Courtrai, the *Contracum* of the Romans, ranked as a town from the 7th century onwards. It was destroyed by the Normans, but was rebuilt in the 10th century by Baldwin III. of Flanders, who endowed it with market rights and laid the foundation of its industrial importance by inviting the settlement of foreign weavers. The town was once more burnt, in 1382, by the French after the battle of Roosebeke, but was rebuilt in 1385 by Philip the Bold, duke of Burgundy.

**COURVOISIER, JEAN JOSEPH ANTOINE** (1775-1835), French magistrate and politician, was born at Besançon on the 30th of November 1775. During the revolutionary period he left the country and served in the army of the *émigrés* and later in that of Austria. In 1801, under the Consulate, he returned to France and established himself as an advocate at Besançon, being appointed *conseiller-auditeur* to the court of appeal there in 1808. At the Restoration he was made advocate-general by Louis XVIII., resigned and left France during the Hundred Days, and was reappointed after the second Restoration in 1815. In 1817, after the modification of the constitution by the *ordonnance* of the 5th of September, he was returned to the chamber of deputies, where he attached himself to the left centre and supported the moderate policy of Richelieu and Decazes. He was an eloquent speaker, and master of many subjects; and his proved royalism made it impossible for the ultra-Royalists to discredit him, much as they resented his consistent opposition to

their short-sighted violence. After the revolt at Lyons in 1817 he was nominated *procureur-général* of the city, and by his sense and moderation did much to restore order and confidence. He was again a member of the chamber from 1819 to 1824, and vigorously opposed the exceptional legislation which the second administration of Richelieu passed under the influence of the ultra-Royalists. In 1824 he failed to secure re-election, and occupied himself with his judicial duties until his nomination as councillor of state in 1827. On the 8th of August 1829 he accepted the offer of the portfolio of justice in the Polignac ministry, but resigned on the 19th of May 1830, when he realized that the government intended to abrogate the Charter and the inevitable revolution that would follow. During the trial of the ex-ministers, in December, he was summoned as a witness, and paid a tribute to the character of his former colleagues which, under the circumstances, argued no little courage. He refused to take office under Louis Philippe, and retired into private life, dying on the 18th of September 1835.

**COUSCOUS**, or *kous-kous* (an Arabic word derived from *kaskasa*, to pound), a dish common among the inhabitants of North Africa, made of flour rubbed together and steamed over a stew of mutton, fowl, &c., with which it is eaten.

**COUSIN, JEAN** (1500–1590), French painter, was born at Soucy, near Sens, and began as a glass-painter, his windows in the Sainte Chapelle at Vincennes being considered the finest in France. As a painter of subject pictures he is ranked as the founder of the French school, as having first departed from the practice of portraits. His "Last Judgment," influenced by Parmigiano, is in the Louvre, and a "Descent from the Cross" (1523) in the museum at Mainz is attributed to him. He was known also as a sculptor, and an engraver, both in etching and on wood, his wood-cuts for Jean le Clerc's Bible (1596) and other books being his best-known work. He also wrote a *Livre de perspective* (1560), and a *Livre de portraiture* (1571).

See Ambroise Firmin-Didot, *Étude sur J. Cousin* (1872), and *Recueil des œuvres choisies de J. Cousin* (1873).

**COUSIN, VICTOR** (1792–1867), French philosopher, the son of a watchmaker, was born in Paris, in the Quartier St Antoine, on the 28th of November 1792. At the age of ten he was sent to the grammar school of the Quartier St Antoine, the Lycée Charlemagne. Here he studied until he was eighteen. The lycée had a connexion with the university, and when Cousin left the secondary school he was "crowned" in the ancient hall of the Sorbonne for the Latin oration delivered by him there, in the general concourse of his school competitors. The classical training of the lycée strongly disposed him to literature. He was already known among his compeers for his knowledge of Greek. From the lycée he passed to the Normal School of Paris, where Laromiguière was then lecturing on philosophy. In the second preface to the *Fragmens philosophiques*, in which he candidly states the varied philosophical influences of his life, Cousin speaks of the grateful emotion excited by the memory of the day in 1811, when he heard Laromiguière for the first time. "That day decided my whole life. Laromiguière taught the philosophy of Locke and Condillac, happily modified on some points, with a clearness and grace which in appearance at least removed difficulties, and with a charm of spiritual *banhomie* which penetrated and subdued." Cousin was set forthwith to lecture on philosophy, and he speedily obtained the position of master of conferences (*maître de conférences*) in the school. The second great philosophical impulse of his life was the teaching of Royer-Collard. This teacher, as he tells us, "by the severity of his logic, the gravity and weight of his words, turned me by degrees, and not without resistance, from the beaten path of Condillac into the way which has since become so easy, but which was then painful and unfrequented, that of the Scottish philosophy." In 1815–1816 Cousin attained the position of *suppléant* (assistant) to Royer-Collard in the history of modern philosophy chair of the faculty of letters. There was still another thinker who influenced him at this early period,—Maine de Biran, whom Cousin regarded as the unequalled psychological observer of his time in France.

These men strongly influenced both the method and the matter of Cousin's philosophical thought. To Laromiguière he attributes the lesson of decomposing thought, even though the reduction of it to sensation was inadequate. Royer-Collard taught him that even sensation is subject to certain internal laws and principles which it does not itself explain, which are superior to analysis and the natural patrimony of the mind. De Biran made a special study of the phenomena of the will. He taught him to distinguish in all cognitions, and especially in the simplest facts of consciousness, the fact of voluntary activity, that activity in which our personality is truly revealed. It was through this "triple discipline," as he calls it, that Cousin's philosophical thought was first developed, and that in 1815 he entered on the public teaching of philosophy in the Normal School and in the faculty of letters.<sup>1</sup> He then took up the study of German, worked at Kant and Jacobi, and sought to master the *Philosophy of Nature* of Schelling, by which he was at first greatly attracted. The influence of Schelling may be observed very markedly in the earlier form of his philosophy. He sympathized with the principle of faith of Jacobi, but regarded it as arbitrary so long as it was not recognized as grounded in reason. In 1817 he went to Germany, and met Hegel at Heidelberg. In this year appeared Hegel's *Encyclopédie der philosophischen Wissenschaften*, of which Cousin had one of the earliest copies. He thought Hegel not particularly amiable, but the two became friends. The following year Cousin went to Munich, where he met Schelling for the first time, and spent a month with him and Jacobi, obtaining a deeper insight into the *Philosophy of Nature*.

The political troubles of France interfered for a time with his career. In the events of 1814–1815 he took the royalist side. He at first adopted the views of the party known as *doctrinaire*, of which Royer-Collard was the philosophical chief. He seems then to have gone farther than his party, and even to have approached the extreme Left. Then came a reaction against liberalism, and in 1821–1822 Cousin was deprived of his offices alike in the faculty of letters and in the Normal School. The Normal School itself was swept away, and Cousin shared at the hands of a narrow and illiberal government the fate of Guizot, who was ejected from the chair of history. This enforced abandonment of public teaching was not wholly an evil. He set out for Germany with a view to further philosophical study. While at Berlin in 1824–1825 he was thrown into prison, either on some ill-defined political charge at the instance of the French police, or on account of certain incautious expressions which he had let fall in conversation. Liberated after six months, he continued under the suspicion of the French government for three years. It was during this period, however, that he thought out and developed what is distinctive in his philosophical doctrine. His eclecticism, his ontology and his philosophy of history were declared in principle and in most of their salient details in the *Fragmens philosophiques* (Paris, 1826). The preface to the second edition (1833) and the *Avertissement* to the third (1838) aimed at a vindication of his principles against contemporary criticism. Even the best of his later books, the *Philosophie écossaise* (4th ed., 1863), the *Du vrai, du beau, et du bien* (12th ed., 1872; Eng. trans., 3rd ed., Edinburgh, 1854), and the *Philosophie de Locke* (4th ed., 1861) were simply matured revisions of his lectures during the period from 1815 to 1820. The lectures on Locke were first sketched in 1819, and fully developed in the course of 1829.

During the seven years of enforced abandonment of teaching, he produced, besides the *Fragmens*, the edition of the works of Proclus (6 vols., 1820–1827), and the works of Descartes (11 vols., 1826). He also commenced his *Translation of Plato* (13 vols.), which occupied his leisure time from 1825 to 1840.

We see in the *Fragmens* very distinctly the fusion of the different philosophical influences by which his opinions were finally matured. For Cousin was as eclectic in thought and habit of mind as he was in philosophical principle and system. It is

<sup>1</sup> *Fragmens philosophiques—préface deuxième.*

with the publication of the *Fragmens* of 1826 that the first great widening of his reputation is associated. In 1827 followed the *Cours de l'histoire de la philosophie*.

In 1828 M. de Vatimesnil, minister of public instruction in Martignac's ministry, recalled Cousin and Guizot to their professorial positions in the university. The three years which followed were the period of Cousin's greatest triumph as a lecturer. His return to the chair was the symbol of the triumph of constitutional ideas and was greeted with enthusiasm. The hall of the Sorbonne was crowded as the hall of no philosophical teacher in Paris had been since the days of Abelard. The lecturer had a singular power of identifying himself for the time with the system which he expounded and the historical character he portrayed. Clear and comprehensive in the grasp of the general outlines of his subject, he was methodical and vivid in the representation of details. In exposition he had the rare art of unfolding and aggrandizing. There was a rich, deep-toned, resonant eloquence mingled with the speculative exposition; his style of expression was clear, elegant and forcible, abounding in happy turns and striking antitheses. To this was joined a singular power of rhetorical climax. His philosophy exhibited in a striking manner the generalizing tendency of the French intellect, and its logical need of grouping details round central principles.

There was withal a moral elevation in his spiritual philosophy which came home to the hearts of his hearers, and seemed to afford a ground for higher development in national literature and art, and even in politics, than the traditional philosophy of France had appeared capable of yielding. His lectures produced more ardent disciples, imbued at least with his spirit, than those of any other professor of philosophy in France during the 18th century. Tested by the power and effect of his teaching influence, Cousin occupies a foremost place in the rank of professors of philosophy, who like Jacobi, Schelling and Dugald Stewart have united the gifts of speculative, expository and imaginative power. Tested even by the strength of the reaction which his writings have in some cases occasioned, his influence is hardly less remarkable. The taste for philosophy—especially its history—was revived in France to an extent unknown since the 17th century.

Among the men who were influenced by Cousin we may note T. S. Jouffroy, J. P. Damiron, Garnier, J. Barthélemy St Hilaire, F. Ravaisson-Mollien, Rémusat, Jules Simon, and A. Franck. Jouffroy and Damiron were first fellow-students and then disciples. Jouffroy, however, always kept firm to the early—the French and Scottish—impulses of Cousin's teaching. Cousin continued to lecture regularly for two years and a half after his return to the chair. Sympathizing with the revolution of July, he was at once recognized by the new government as a friend of national liberty. Writing in June 1833 he explains both his philosophical and his political position:—

"I had the advantage of holding united against me for many years both the sensational and the theological school. In 1830 both schools descended into the arena of politics. The sensational school quite naturally produced the demagogic party, and the theological school became quite as naturally absolutism, safe to borrow from time to time the mask of the demagogue in order the better to reach its ends, as in philosophy it is by scepticism that it undertakes to restore theocracy. On the other hand, he who combated any exclusive principle in science was bound to reject also any exclusive principle in the state, and to defend representative government."

The government was not slow to do him honour. He was induced by the ministry of which his friend Guizot was the head to become a member of the council of public instruction and counsellor of state, and in 1832 he was made a peer of France. He ceased to lecture, but retained the title of professor of philosophy. Finally, he accepted the position of minister of public instruction in 1840 under Thiers. He was besides director of the Normal School and virtual head of the university, and from 1840 a member of the Institute (Academy of the Moral and Political Sciences). His character and his official position at this period gave him great power in the university and in the educa-

tional arrangements of the country. In fact, during the seventeen and a half years of the reign of Louis Philippe, Cousin mainly moulded the philosophical and even the literary tendencies of the cultivated class in France.

But the most important work he accomplished during this period was the organization of primary instruction. It was to the efforts of Cousin that France owed her advance, in primary education, between 1830 and 1848. Prussia and Saxony had set the national example, and France was guided into it by Cousin. Forgetful of national calamity and of personal wrong, he looked to Prussia as affording the best example of an organized system of national education; and he was persuaded that "to carry back the education of Prussia into France afforded a nobler (if a bloodless) triumph than the trophies of Austerlitz and Jena." In the summer of 1831, commissioned by the government, he visited Frankfurt and Saxony, and spent some time in Berlin. The result was a series of reports to the minister, afterwards published as *Rapport sur l'état de l'instruction publique dans quelques pays de l'Allemagne et particulièrement en Prusse*. (Compare also *De l'instruction publique en Hollande*, 1837.) His views were readily accepted on his return to France, and soon afterwards through his influence there was passed the law of primary instruction. (See his *Exposé des motifs et projet de loi sur l'instruction primaire, présentés à la chambre des députés, séance du 2 janvier 1833*.)

In the words of the *Edinburgh Review* (July 1833), these documents "mark an epoch in the progress of national education, and are directly conducive to results important not only to France but to Europe." The *Report* was translated into English by Mrs Sarah Austin in 1834. The translation was frequently reprinted in the United States of America. The legislatures of New Jersey and Massachusetts distributed it in the schools at the expense of the states. Cousin remarks that, among all the literary distinctions which he had received, "None has touched me more than the title of foreign member of the American Institute for Education." To the enlightened views of the ministries of Guizot and Thiers under the citizen-king, and to the zeal and ability of Cousin in the work of organization, France owes what is best in her system of primary education,—a national interest which had been neglected under the Revolution, the Empire and the Restoration (see *Exposé*, p. 17). In the first two years of the reign of Louis Philippe more was done for the education of the people than had been either sought or accomplished in all the history of France. In defence of university studies he stood manfully forth in the chamber of peers in 1844, against the clerical party on the one hand and the levelling or Philistine party on the other. His speeches on this occasion were published in a tractate *Défense de l'université et de la philosophie* (1844 and 1845).

This period of official life from 1830 to 1848 was spent, so far as philosophical study was concerned, in revising his former lectures and writings, in maturing them for publication or reissue, and in research into certain periods of the history of philosophy. In 1835 appeared *De la Métaphysique d'Aristote, suivi d'un essai de traduction des deux premiers livres*; in 1836, *Cours de philosophie professé à la faculté des lettres pendant l'année 1818*, and *Ouvrages inédits d'Abelard*. This *Cours de philosophie* appeared later in 1854 as *Du vrai, du beau, et du bien*. From 1825 to 1840 appeared *Cours de l'histoire de la philosophie*, in 1829 *Manuel de l'histoire de la philosophie de Tennemann*, translated from the German. In 1840-1841 we have *Cours d'histoire de la philosophie morale au XVIII<sup>e</sup> siècle* (5 vols.). In 1841 appeared his edition of the *Œuvres philosophiques de Maine-de-Biran*; in 1842, *Leçons de philosophie sur Kant* (Eng. trans. A. G. Henderson, 1854); and in the same year *Des Pensées de Pascal*. The *Nouveaux fragments* were gathered together and republished in 1847. Later, in 1859, appeared *Petri Abaelardi Opera*.

During this period Cousin seems to have turned with fresh interest to those literary studies which he had abandoned for speculation under the influence of Laromiguière and Royer-Collard. To this renewed interest we owe his studies of men

and women of note in France in the 17th century. As the results of his work in this line, we have, besides the *Des Pensées de Pascal*, 1842, *Études sur les femmes et la société du XVII<sup>e</sup> siècle*, 1853. He has sketched Jacqueline Pascal (1844), Madame de Longueville (1853), the marquise de Sablé (1854), the duchesse de Chevreuse (1856), Madame de Hautefort (1856).

When the reign of Louis Philippe came to a close through the opposition of his ministry, with Guizot at its head, to the demand for electoral reform and through the policy of the Spanish marriages, Cousin, who was opposed to the government on these points, lent his sympathy to Cavaignac and the Provisional government. He published a pamphlet entitled *Justice et charité*, the purport of which showed the moderation of his political views. It was markedly anti-socialistic. But from this period he passed almost entirely from public life, and ceased to wield the personal influence which he had done during the preceding years. After the *coup d'état* of the 2nd of December, he was deprived of his position as permanent member of the superior council of public instruction. From Napoleon and the Empire he stood aloof. A decree of 1852 placed him along with Guizot and Villemain in the rank of honorary professors. His sympathies were apparently with the monarchy, under certain constitutional safeguards. Speaking in 1853 of the political issues of the spiritual philosophy which he had taught during his lifetime, he says,—“It conducts human societies to the true republic, that dream of all generous souls, which in our time can be realized in Europe only by constitutional monarchy.”<sup>1</sup>

During the last years of his life he occupied a suite of rooms in the Sorbonne, where he lived simply and unostentatiously. The chief feature of the rooms was his noble library, the cherished collection of a lifetime. He died at Cannes on the 13th of January 1867, in his sixty-fifth year. In the front of the Sorbonne, below the lecture rooms of the faculty of letters, a tablet records an extract from his will, in which he bequeaths his noble and cherished library to the halls of his professorial work and triumphs.

*Philosophy.*—There are three distinctive points in Cousin's philosophy. These are his method, the results of his method, and the application of the method and its results to history,—especially to the history of philosophy. It is usual to speak of his philosophy as eclecticism. It is eclectic only in a secondary and subordinate sense. All eclecticism that is not self-condemned and inoperative implies a system of doctrine as its basis,—in fact, a criterion of truth. Otherwise, as Cousin himself remarks, it is simply a blind and useless syncretism. And Cousin saw and proclaimed from an early period in his philosophical teaching the necessity of a system on which to base his eclecticism. This is indeed advanced as an illustration or confirmation of the truth of his system,—as a proof that the facts of history correspond to his analysis of consciousness. These three points—the method, the results, and the philosophy of history—are with him intimately connected; they are developments in a natural order of sequence. They become in practice Psychology, Ontology and Eclecticism in history.

First, as to method. On no point has Cousin more strongly insisted than the importance of method in philosophy. That which he adopts, and the necessity of which he so strongly proclaims, is the ordinary one of observation, analysis and induction. This observational method Cousin regards as that of the 18th century,—the method which Descartes began and abandoned, and which Locke and Condillac applied, though imperfectly, and which Reid and Kant used with more success, yet not completely. He insists that this is the true method of philosophy as applied to consciousness, in which alone the facts of experience appear. But the proper condition of the application of the method is that it shall not through prejudice of system omit a single fact of consciousness. If the authority of consciousness is good in one instance, it is good in all. If not to be trusted in one, it is not to be trusted in any. Previous systems have erred in not presenting the facts of consciousness,

<sup>1</sup> *Du vrai, du beau, et du bien* (preface).

*i.e.* consciousness itself, in their totality. The observational method applied to consciousness gives us the science of psychology. This is the basis and the only proper basis of ontology or metaphysics—the science of being—and of the philosophy of history. To the observation of consciousness Cousin adds induction as the complement of his method, by which he means inference as to reality necessitated by the data of consciousness, and regulated by certain laws found in consciousness, *viz.* those of reason. By his method of observation and induction as thus explained, his philosophy will be found to be marked off very clearly, on the one hand from the deductive construction of notions of an absolute system, as represented either by Schelling or Hegel, which Cousin regards as based simply on hypothesis and abstraction, illegitimately obtained; and on the other, from that of Kant, and in a sense, of Sir W. Hamilton, both of which in the view of Cousin are limited to psychology, and merely relative or phenomenal knowledge, and issue in scepticism so far as the great realities of ontology are concerned. What Cousin finds psychologically in the individual consciousness, he finds also spontaneously expressed in the common sense or universal experience of humanity. In fact, it is with him the function of philosophy to classify and explain universal convictions and beliefs; but common-sense is not with him philosophy, nor is it the instrument of philosophy; it is simply the material on which the philosophical method works, and in harmony with which its results must ultimately be found.

The three great results of psychological observation *Results.*  
are Sensibility, Activity or Liberty, and Reason.

These three facts are different in character, but are not found apart in consciousness. Sensations, or the facts of the sensibility, are necessary; we do not impute them to ourselves. The facts of reason are also necessary, and reason is not less independent of the will than the sensibility. Voluntary facts alone are marked in the eyes of consciousness with the characters of imputability and personality. The will alone is the person or *Me*. The *me* is the centre of the intellectual sphere without which consciousness is impossible. We find ourselves in a strange world, between two orders of phenomena which do not belong to us, which we apprehend only on the condition of our distinguishing ourselves from them. Further, we apprehend by means of a light which does not come from ourselves. All light comes from the reason, and it is the reason which apprehends both itself and the sensibility which envelops it, and the will which it obliges but does not constrain. Consciousness, then, is composed of these three integrant and inseparable elements. But Reason is the immediate ground of knowledge and of consciousness itself.

But there is a peculiarity in Cousin's doctrine of activity or freedom, and in his doctrine of reason, which enters deeply into his system. This is the element of spontaneity in volition and in reason. This is the heart of what is new alike in his doctrine of knowledge and being. *Spontaneity  
in will.* Liberty or freedom is a generic term which means a cause or being endowed with self-activity. This is to itself and its own development its own ultimate cause. Free-will is so, although it is preceded by deliberation and determination, *i.e.* reflection, for we are always conscious that even after determination we are free to will or not to will. But there is a primary kind of volition which has not reflection for its condition, which is yet free and spontaneous. We must have willed thus spontaneously first, otherwise we could not know, before our reflective volition, that we could will and act. Spontaneous volition is free as reflective, but it is the prior act of the two. This view of liberty of will is the only one in accordance with the facts of humanity; it excludes reflective volition, and explains the enthusiasm of the poet and the artist in the act of creation; it explains also the ordinary actions of mankind, which are done as a rule spontaneously and not after reflective deliberation.

But it is in his doctrine of the Reason that the distinctive principle of the philosophy of Cousin lies. The reason given to us by psychological observation, the reason of our consciousness, is impersonal in its nature. We do not make it; its character is precisely the opposite of individuality; it is universal and



necessary. The recognition of universal and necessary principles in knowledge is the essential point in psychology; it ought to be put first and emphasized to the last that these exist, and that they are wholly impersonal or absolute. *Impersonality of reason.* The number of these principles, their enumeration and classification, is an important point, but it is secondary to that of the recognition of their true nature. This was the point which Kant missed in his analysis, and this is the fundamental truth which Cousin thinks he has restored to the integrity of philosophy by the method of the observation of consciousness. And how is this impersonality or absoluteness of the conditions of knowledge to be established? The answer is in substance that Kant went wrong in putting necessity first as the criterion of those laws. This brought them within the sphere of reflection, and gave as their guarantee the impossibility of thinking them reversed; and led to their being regarded as wholly relative to human intelligence, restricted to the sphere of the phenomenal, incapable of revealing to us substantial reality—necessary, yet subjective. But this test of necessity is a wholly secondary one; these laws are not thus guaranteed to us; they are each and all given to us, given to our consciousness, in an act of spontaneous apperception or apprehension, immediately, instantaneously, in a sphere above the reflective consciousness, yet within the reach of knowledge. And "all subjectivity with all reflection expires in the spontaneity of apperception. The reason becomes subjective by relation to the voluntary and free self; but in itself it is impersonal; it belongs not to this or to that self in humanity; it belongs not even to humanity. We may say with truth that nature and humanity belong to it, for without its laws both would perish."

But what is the number of those laws? Kant reviewing the enterprise of Aristotle in modern times has given a complete list of the laws of thought, but it is arbitrary in classification and may be legitimately reduced. According to *Laws of reason.* Cousin, there are but two primary laws of thought, that of causality and that of substance. From these flow naturally all the others. In the order of nature, that of substance is the first and causality second. In the order of acquisition of our knowledge, causality precedes substance, or rather both are given us in each other, and are contemporaneous in consciousness.

These principles of reason, cause and substance, given thus psychologically, enable us to pass beyond the limits of the relative and subjective to objective and absolute reality,—enable us, in a word, to pass from psychology, or the science of knowledge, to ontology or the science of being. These laws are inextricably mixed in consciousness with the data of volition and sensation, with free activity and fatal action or impression, and they guide us in rising to a personal being, a self or free cause, and to an impersonal reality, a not-me—nature, the world of force—lying out of us, and modifying us. As I refer to myself the act of attention and volition, so I cannot but refer the sensation to some cause, necessarily other than myself, that is, to an external cause, whose existence is as certain for me as my own existence, since the phenomenon which suggests it to me is as certain as the phenomenon which had suggested my reality, and both are given in each other. I thus reach an objective impersonal world of forces which corresponds to the variety of my sensations. The relation of these forces or causes to each other is the order of the universe.

But these two forces, the me and the not-me, are reciprocally limitative. As reason has apprehended these two simultaneous phenomena, attention and sensation, and led us immediately to conceive the two sorts of distinct causes, correlative and reciprocally finite, to which they are related, so, from the notion of this limitation, *The infinite or absolute.* we find it impossible under the same guide not to conceive a supreme cause, absolute and infinite, itself the first and last cause of all. This is relatively to self and not-self what these are to their proper effects. This cause is self-sufficient, and is sufficient for the reason. This is God; he must be conceived under the notion of cause, related to humanity and the world. He is absolute substance only in so far as he is absolute cause,

and his essence lies precisely in his creative power. He thus creates, and he creates necessarily.

This theodicy of Cousin laid him open obviously enough to the charge of pantheism. This he repels, and his answer may be summed up as follows. Pantheism is properly the deification of the law of phenomena, the universe God. *Charge of Pantheism.* But I distinguish the two finite causes self and not-self from each other and from the infinite cause. They are not mere modifications of this cause or properties, as with Spinoza,—they are free forces having their power or spring of action in themselves, and this is sufficient for our idea of independent finite reality. I hold this, and I hold the relation of these as effects to the one supreme cause. The God I plead for is neither the deity of Pantheism, nor the absolute unity of the Eleatics, a being divorced from all possibility of creation or plurality, a mere metaphysical abstraction. The deity I maintain is creative, and necessarily creative. The deity of Spinoza and the Eleatics is a mere substance, not a cause in any sense. As to the necessity under which Deity exists of acting or creating, this is the highest form of liberty, it is the freedom of spontaneity, activity without deliberation. His action is not the result of a struggle between passion and virtue. He is free in an unlimited manner the purest spontaneity in man is but the shadow of the freedom of God. He acts freely but not arbitrarily, and with the consciousness of being able to choose the opposite part. He cannot deliberate or will as we do. His spontaneous action excludes at once the efforts and the miseries of will and the mechanical operation of necessity.

The elements found in consciousness are also to be found in the history of humanity and in the history of philosophy. In external nature there are expansion and contraction which correspond to spontaneity and reflection. *History of philosophy.* External nature again in contrast with humanity expresses spontaneity; humanity expresses reflection. In human history the East represents the spontaneous stage; the Pagan and Christian world represent stages of reflection.

This was afterwards modified, expanded and more fully expressed by saying that humanity in its universal development has three principal moments. First, in the spontaneous stage, where reflection is not yet developed, and art is imperfect, humanity has thought only of the immensity around it. It is preoccupied by the infinite. Secondly, in the reflective stage, mind has become an object to itself. It thus knows itself explicitly or reflectively. Its own individuality is now the only or at least the supreme thing. This is the moment of the finite. Thirdly, there comes an epoch in which the self or me is subordinated. Mind realizes another power in the universe. The finite and the infinite become two real correlatives in the relation of cause and product. This is the third and highest stage of development, the relation of the finite and the infinite. As philosophy is but the highest expression of humanity, these three moments will be represented in its history. The East typifies the infinite, Greece the finite or reflective epoch, the modern era the stage of relation or correlation of infinite and finite. In theology, the dominant philosophical idea of each of these epochs results in pantheism, polytheism, theism. In politics we have in correspondence also with the idea, monarchy, democracy, constitutionalism.

Eclecticism thus means the application of the psychological method to the history of philosophy. Confronting the various systems co-ordinated as sensualism, idealism, scepticism, mysticism, with the facts of consciousness, the result was reached "that each system expresses an order of phenomena and ideas, which is in truth very real, but which is not alone in consciousness, and which at the same time holds an almost exclusive place in the system; whence it follows that each system is not false but incomplete, and that in re-uniting all incomplete systems, we should have a complete philosophy, adequate to the totality of consciousness." *Eclecticism.* Philosophy, as thus perfected, would not be a mere aggregation of systems, as is ignorantly supposed, but an integration of the truth in each system after the false or incomplete is discarded.

Such is the system in outline. The historical position of the system lies in its relations to Kant, Schelling and Hegel. Cousin was opposed to Kant in asserting that the unconditioned in the form of infinite or absolute cause is but a mere unrealizable tentative or effort on the part of the mind, something different from a mere negation, yet not equivalent to a positive thought. With Cousin the absolute as the ground of being is grasped positively by the intelligence, and it renders all else intelligible; it is not as with Kant a certain hypothetical or regulative need.

With Schelling again Cousin agrees in regarding this supreme ground of all as positively apprehended, and as a source of development, but he utterly repudiates Schelling's method. The intellectual intuition either falls under the eye of consciousness, or it does not. If not, how do you know it and its object which are identical? If it does, it comes within the sphere of psychology; and the objections to it as thus a relative, made by Schelling himself, are to be dealt with. Schelling's intellectual intuition is the mere negation of knowledge.

Again the pure being of Hegel is a mere abstraction,—a hypothesis illegitimately assumed, which he has nowhere sought to vindicate. The very point to be established is the possibility of reaching being *per se* or pure being; yet in the Hegelian system this is the very thing assumed as a starting-point. Besides this, of course, objections might be made to the method of development, as not only subverting the principle of contradiction, but as galvanizing negation into a means of advancing or developing the whole body of human knowledge and reality. The intellectual intuition of Schelling, as above consciousness, the pure being of Hegel, as an empty abstraction, unvindicated, illegitimately assumed, and arbitrarily developed, are equally useless as bases of metaphysics. This led Cousin, still holding by essential knowledge of being, to ground it in an analysis of consciousness,—in psychology.

The absolute or infinite—the unconditioned ground and source of all reality—is yet apprehended by us as an immediate datum of reality; and it is apprehended in consciousness—under its condition, that, to wit, of distinguishing subject and object, knower and known. The doctrine of Cousin was criticized by Sir W. Hamilton in the *Edinburgh Review* of 1829, and it was animadverted upon about the same time by Schelling. Hamilton's objections are as follows. The correlation of the ideas of infinite and finite does not necessarily imply their correality, as Cousin supposes; on the contrary, it is a presumption that finite is simply positive and infinite negative of the same—that the finite and infinite are simply contradictory relatives. Of these "the positive alone is real, the negative is only an abstraction of the other, and in the highest generality even an abstraction of thought itself." A study of the few sentences under this head might have obviated the trifling criticism of Hamilton's objection which has been set afloat recently, that the denial of a knowledge of the absolute or infinite implies a foregone knowledge of it. How can you deny the reality of that which you do not know? The answer to this is that in the case of contradictory statements—A and not A—the latter is a mere negation of the former, and posits nothing; and the negation of a notion with positive attributes, as the finite, does not extend beyond abolishing the given attributes as an object of thought. The infinite or non-finite is not necessarily known, ere the finite is negated, or in order to negate it; all that needs be known is the finite itself; and the contradictory negation of it implies no positive. Non-organized may or may not correspond to a positive—*i.e.* an object or notion with qualities contradictory of the organized; but the mere sublation of the organized does not posit it, or suppose that it is known beforehand, or that anything exists corresponding to it. This is one among many flaws in the Hegelian dialectic, and it paralyzes the whole of the *Logic*. Secondly, the conditions of intelligence, which Cousin allows, necessarily exclude the possibility of knowledge of the absolute—they are held to be incompatible with its unity. Here Schelling and Hamilton argue that Cousin's absolute is a mere relative. Thirdly, it is objected that in order to deduce

the conditioned, Cousin makes his absolute a relative; for he makes it an absolute cause, *i.e.* a cause existing absolutely under relation. As such it is necessarily inferior to the sum total of its effects, and dependent for reality on these—in a word, a mere potency or becoming. Further, as a theory of creation, it makes creation a necessity, and destroys the notion of the divine. Cousin made no reply to Hamilton's criticism beyond alleging that Hamilton's doctrine necessarily restricted human knowledge and certainty to psychology and logic, and destroyed metaphysics by introducing nescience and uncertainty into its highest sphere—theodicy.

The attempt to render the laws of reason or thought impersonal by professing to find them in the sphere of spontaneous apperception, and above reflective necessity, can hardly be regarded as successful. It may be that we first of all primitively or spontaneously affirm cause, substance, time, space, &c., in this way. But these are still in each instance given us as realized in a particular form.

In no single act of affirmation of cause or substance, much less in such a primitive act, do we affirm the universality of their application. We might thus get particular instances or cases of these laws, but we could never get the laws themselves in their universality, far less absolute impersonality. And as they are not supposed to be mere generalizations from experience, no amount of individual instances of the application of any one of them by us would give it a true universality. The only sure test we have of their universality in our experience is the test of their reflective necessity. We thus after all fall back on reflection as our ground for their universal application; mere spontaneity of apprehension is futile; their universality is grounded in their necessity, not their necessity in their universality. How far and in what sense this ground of necessity renders them personal are of course questions still to be solved.

But if these three correlative facts are immediately given, it seems to be thought possible by Cousin to vindicate them in reflective consciousness. He seeks to trace the steps which the reason has spontaneously and consciously, but irreflectively, followed. And here the question arises—Can we vindicate in a reflective or mediate process this spontaneous apprehension of reality?

The self is found to be a cause of force, free in its action, on the ground that we are obliged to relate the volition of consciousness to the self as its cause, and its ultimate cause. It is not clear from the analysis whether the self is immediately observed as an acting or originating cause, or whether reflection working on the principle of causality is compelled to infer its existence and character. If self is actually so given, we do not need the principle of causality to infer it; if it is not so given, causality could never give us either the notion or the fact of self as a cause or force, far less as an ultimate one. All that it could do would be to warrant a cause of some sort, but not this or that reality as the cause. And further, the principle of causality, if fairly carried out, as universal and necessary, would not allow us to stop at personality or will as the ultimate cause of its effect—volition. Once applied to the facts at all, it would drive us beyond the first antecedent or term of antecedents of volition to a still further cause or ground—in fact, land us in an infinite regress of causes.

The same criticism is even more emphatically applicable to the influence of a not-self, or world of forces, corresponding to our sensations, and the cause of them. Starting from sensation as our basis, causality could never give us this, even though it be allowed that sensation is impersonal to the extent of being independent of our volition. Causality might tell us that a cause there is of sensation somewhere and of some sort; but that this cause is a force or sum of forces, existing in space, independently of us, and corresponding to our sensations, it could never tell us, for the simple reason that such a notion is not supposed to exist in our consciousness. Causality cannot add to the number of our notions,—cannot add to the number of realities we know. All it can do is to necessitate us to think that a cause there is of a given change, but *what* that cause is it cannot of itself inform us, or even suggest to us, beyond implying that it must be adequate

*Criticism  
of his  
sophy.  
Impersonality  
of  
reason.*

to the effect. Sensation might arise, for aught we know, so far as causality leads us, not from a world of forces at all, but from a will like our own, though infinitely more powerful, acting upon us, partly furthering and partly thwarting us. And indeed such a supposition is, with the principle of causality at work, within the limits of probability, as we are already supposed to know such a reality—a will—in our own consciousness. When Cousin thus set himself to vindicate those points by reflection, he gave up the obvious advantage of his other position that the realities in question are given us in immediate and spontaneous apprehension. The same criticism applies equally to the inference of an absolute cause from the two-limited forces which he names self and not-self. Immediate spontaneous apprehension may seize this supreme reality; but to vindicate it by reflection as an inference on the principle of causality is impossible. This is a mere paralogism; we can never infer either absolute or infinite from relative or finite.

The truth is that Cousin's doctrine of the spontaneous apprehension of impersonal truth amounts to little more than a presentment in philosophical language of the ordinary convictions and beliefs of mankind. This is important as a preliminary stage, but philosophy properly begins when it attempts to co-ordinate or systematize those convictions in harmony, to conciliate apparent contradiction and opposition, as between the correlative notions of finite and infinite; the apparently conflicting notions of personality and infinitude, self and not-self; in a word, to reconcile the various sides of consciousness with each other. And whether the laws of our reason are the laws of all intelligence and being—whether and how we are to relate our fundamental, intellectual and moral conceptions to what is beyond our experience, or to an infinite being—are problems which Cousin cannot be regarded as having solved. These are in truth the outstanding problems of modern philosophy.

Cousin's doctrine of spontaneity in volition can hardly be said to be more successful than his impersonality of the reason through spontaneous apprehension. Sudden, unpremeditated volition may be the earliest and the most artistic; but it is not the best. Volition is essentially a free choice between alternatives, and that is best which is most deliberate, because it is most rational. Aristotle touched this point in his distinction between *βούλησις* and *προαίρεσις*. The sudden and unpremeditated wish represented by the former is wholly inferior in character to the free choice of the latter, guided and illumined by intelligence. In this we can deliberately resolve upon what is in our power; in that we are subject to the vain impulse of wishing the impossible. Spontaneity is pleasing, sometimes beautiful, but it is not in this instance the highest quality of the thing to be obtained. That is to be found in a guiding and illumining reflective activity.

Eclecticism is not open to the superficial objection of proceeding without a system or test in determining the complete or incomplete. But it is open to the objection of assuming that a particular analysis of consciousness has reached all the possible elements in humanity and in history, and all their combinations. It may be asked, Can history have that which is not in the individual consciousness? In a sense not; but our analysis may not give all that is there, and we ought not at once to impose that analysis or any formula on history. History is as likely to reveal to us in the first place true and original elements, and combinations of elements in man, as a study of consciousness. Besides, the tendency of applying a formula of this sort to history is to assume that the elements are developed in a certain regular or necessary order, whereas this may not at all be the case; but we may find at any epoch the whole mixed, either crossing or co-operative, as in the consciousness of the individual himself. Further, the question as to how these elements may possibly have grown up in the general consciousness of mankind is assumed to be non-existent or impossible.

It was the tendency of the philosophy of Cousin to outline things and to fill up the details in an artistic and imaginative interest. This is necessarily the case, especially in the application

to history of all formulas supposed to be derived either from an analysis of consciousness, or from an abstraction called pure thought. Cousin was observational and generalizing rather than analytic and discriminating. His search into principles was not profound, and his power of rigorous consecutive development was not remarkable. He left no distinctive permanent principle of philosophy. But he left very interesting psychological analyses, and several new, just, and true expositions of philosophical systems, especially that of Locke and the philosophers of Scotland. He was at the same time a man of impressive power, of rare and wide culture, and of lofty aim,—far above priestly conception and Philistine narrowness. He was familiar with the broad lines of nearly every system of philosophy ancient and modern. His eclecticism was the proof of a reverential sympathy with the struggles of human thought to attain to certainty in the highest problems of speculation. It was eminently a doctrine of comprehension and of toleration. In these respects it formed a marked and valuable contrast to the arrogance of absolutism, to the dogmatism of sensationalism, and to the doctrine of church authority, preached by the theological school of his day. His spirit, while it influenced the youth of France, saved them from these influences. As an educational reformer, as a man of letters and learning, who trod "the large and impartial ways of knowledge," and who swayed others to the same paths, as a thinker influential alike in the action and the reaction to which he led, Cousin stands out conspicuously among the memorable Frenchmen of the 19th century.

Sir W. Hamilton (*Discussions*, p. 541), one of his most resolute opponents, described Cousin as "A profound and original thinker, a lucid and eloquent writer, a scholar equally at home in ancient and in modern learning, a philosopher superior to all prejudices of age or country, party or profession, and whose lofty eclecticism, seeking truth under every form of opinion, traces its unity even through the most hostile systems."

**BIBLIOGRAPHY.**—J. Barthélemy St Hilaire, *V. Cousin, sa vie et sa correspondance* (3 vols., Paris, 1895); H. Höffding, *Hist. of Mod. Phil.* ii. 311 (Eng. trans., 1900); C. E. Fuchs, *Die Philosophie Victor Cousins* (Berlin, 1847); J. Alaux, *La Philos. de M. Cousin* (Paris, 1864); P. Janet, *Victor Cousin et son œuvre* (Paris, 1885); Jules Simon, *V. Cousin* (1887); Adolphe Franck, *Moralistes et philosophes* (1872); J. P. Damiron, *Souvenirs de vingt ans d'enseignement* (Paris, 1859); H. Taine in *Les Philosophes* (Paris, 1868), pp. 79-202. (J. V.; X.)

**COUSIN** (Fr. *cousin*, Ital. *cugino*, Late Lat. *cosinus*, perhaps a popular and familiar abbreviation of *consobrinus*, which has the same sense in classical Latin), a term of relationship. Children of brothers and sisters are to each other first cousins, or cousins-german; the children of first cousins are to each other second cousins, and so on; the child of a first cousin is to the first cousin of his father or mother a first cousin once removed.

The word cousin has also, since the 16th century, been used by sovereigns as an honorific style in addressing persons of exalted, but not equal sovereign rank, the term "brother" being reserved as the style used by one sovereign in addressing another. Thus, in Great Britain, dukes, marquesses and earls are addressed by the sovereign in royal writs, &c., as "cousin." In France the kings thus addressed princes of the blood royal, cardinals and archbishops, dukes and peers, the marshals of France, the grand officers of the crown and certain foreign princes. In Spain the right to be thus addressed is a privilege of the grandes.

**COUSINS, SAMUEL** (1801-1887), English mezzotint engraver, was born at Exeter on the 9th of May 1801. He was pre-eminently the interpreter of Sir Thomas Lawrence, his contemporary. During his apprenticeship to S. W. Reynolds he engraved many of the best amongst the three hundred and sixty little mezzotints illustrating the works of Sir Joshua Reynolds which his master issued in his own name. In the finest of his numerous transcripts of Lawrence, such as "Lady Acland and her Sons," "Pope Pius VII." and "Master Lambton," the distinguishing characteristics of the engraver's work; brilliancy and force of effect in a high key, corresponded exactly with similar qualities in the painter. After the introduction of steel

for engraving purposes about the year 1823, Cousins and his contemporaries were compelled to work on it, because the soft copper previously used for mezzotint plates did not yield a sufficient number of fine impressions to enable the method to compete commercially against line engraving, from which much larger editions were obtainable. The painter-like quality which distinguished the 18th-century mezzotints on copper was wanting in his later works, because the hardness of the steel on which they were engraved impaired freedom of execution and richness of tone, and so enhanced the labour of scraping that he accelerated the work by stipple, etching the details instead of scraping them out of the "ground" in the manner of his predecessors. To this "mixed style," previously used by Richard Earlom on copper, Cousins added heavy roulette and rocking-tool textures, tending to fortify the darks, when he found that the "burr" even on steel failed to yield enough fine impressions to meet the demand. The effect of his prints in this method after Reynolds and Millais was mechanical and out of harmony with the picturesque technique of these painters, but the phenomenal popularity which Cousins gained for his works at least kept alive and in favour a form of mezzotint engraving during a critical phase of its history. Abraham Raimbach, the line engraver, dated the decline of his own art in England from the appearance in 1837 of Cousins's print (in the "mixed style") after Landseer's "Bolton Abbey." Such plates as "Miss Peel," after Lawrence (published in 1833); "A Midsummer Night's Dream," after Landseer (1857); "The Order of Release" and "The First Minuet," after Millais (1856 and 1868); "The Strawberry Girl" and "Lavinia, Countess Spencer," after Reynolds; and "Miss Rich," after Hogarth (1873-1877), represent various stages of Cousins's mixed method. It reached its final development in the plates after Millais's "Cherry Ripe" and "Pomona," published in 1881 and 1882, when the invention of coating copper-plates with a film of steel to make them yield larger editions led to the revival of pure mezzotint on copper, which has since rendered obsolete the steel plate and the mixed style which it fostered. The fine draughtsmanship of Cousins was as apparent in his prints as in his original lead-pencil portraits exhibited in London in 1882. In 1885 he was elected a full member of the Royal Academy, to which institution he later gave in trust £15,000 to provide annuities for superannuated artists who had not been so successful as himself. One of the most important figures in the history of British engraving, he died in London, unmarried, on the 7th of May 1887.

See George Pycroft, M.R.C.S.E., *Memoir of Samuel Cousins, R.A., Member of the Legion of Honour* (published for private circulation by E. E. Leggatt, London, 1899); Algernon Graves, *Catalogue of the Works of Samuel Cousins, R.A.* (published by H. Graves and Co., London, 1888); and Alfred Whitman, *Samuel Cousins* (published by George Bell & Sons, London, 1904), which contains a catalogue, good illustrations, and much detail useful to the collector and dealer. (G. P. R.)

**COUSTOU**, the name of a famous family of French sculptors.

**NICOLAS COUSTOU** (1658-1733) was the son of a wood-carver at Lyons, where he was born. At eighteen he removed to Paris, to study under C. A. Coysevox, his mother's brother, who presided over the recently-established Academy of Painting and Sculpture; and at three-and-twenty he gained the Colbert prize, which entitled him to four years' education at the French Academy at Rome. He afterwards became rector and chancellor of the Academy of Painting and Sculpture. From the year 1700 he was a most active collaborator with Coysevox at the palaces of Marly and Versailles. He was remarkable for his facility; and though he was specially influenced by Michelangelo and Algardi, his numerous works are among the most typical specimens of his age now extant. The most famous are "La Seine et la Marne," "La Saône," the "Berger Chasseur" in the gardens of the Tuileries, the bas-relief "Le Passage du Rhin" in the Louvre, and the "Descent from the Cross" placed behind the choir altar of Notre Dame at Paris.

His younger brother, **GUILLAUME COUSTOU** (1677-1746), was a sculptor of still greater merit. He also gained the Colbert prize; but refusing to submit to the rules of the Academy, he

soon left it, and for some time wandered houseless through the streets of Rome. At length he was befriended by the sculptor Legros, under whom he studied for some time. Returning to Paris, he was in 1704 admitted into the Academy of Painting and Sculpture, of which he afterwards became director; and, like his brother, he was employed by Louis XIV. His finest works are the famous group of the "Horse Tamers," originally at Marly, now in the Champs Elysées at Paris, the colossal group "The Ocean and the Mediterranean" at Marly, the bronze "Rhône" which formed part of the statue of Louis XIV. at Lyons, and the sculptures at the entrance of the Hôtel des Invalides. Of these latter, the bas-relief representing Louis XIV. mounted and accompanied by Justice and Prudence was destroyed during the Revolution, but was restored in 1815 by Pierre Cartellier from Coustou's model; the bronze figures of Mars and Minerva, on either side of the doorway, were not interfered with.

Another **GUILLAUME COUSTOU** (1716-1777), the son of Nicolas, also studied at Rome, as winner of the Colbert prize. While to a great extent a copyist of his predecessors, he was much affected by the bad taste of his time, and produced little or nothing of permanent value.

See Louis Gougenot, *Éloge de M. Coustou le jeune* (1903); Arsène Houssaye, *Histoire de l'art français au XVIII<sup>e</sup> siècle* (1860); Lady Dilke, *Gazette des beaux-arts*, vol. xxv. (1901) (2 articles).

**COUTANCES, WALTER OF** (d. 1207), bishop of Lincoln and archbishop of Rouen, commenced his career in the chancery of Henry II., was elected bishop of Lincoln in 1182, and in 1184 obtained, with the king's help, the see of Rouen. Throughout his career he was much employed in diplomatic and administrative duties. He started with Richard I. for the Third Crusade, but was sent back from Messina to investigate the charges which the barons and the official class had brought against the chancellor, William Longchamp. There was no love lost between the two; and they were popularly supposed to be rivals for the see of Canterbury. The archbishop of Rouen sided with the barons and John, and sanctioned Longchamp's deposition—a step which was technically warranted by the powers which Richard had given, but by no means calculated to protect the interests of the crown. The Great Council now recognized the archbishop as chief justiciar, and he remained at the head of the government till 1193, when he was replaced by Hubert Walter. The archbishop did good service in the negotiations for Richard's release, but subsequently quarrelled with his master and laid Normandy under an interdict, because the border stronghold of Château Gaillard in the Vexin had been built on his land without his consent. After Richard's death the archbishop accepted John as the lawful heir of Normandy and consecrated him as duke. But his personal inclinations leaned to Arthur of Brittany, whom he was with difficulty dissuaded from supporting. The archbishop accepted the French conquest of Normandy with equanimity (1204), although he kept to his old allegiance while the issue of the struggle was in doubt. He did not long survive the conquest, and his later history is a blank.

See W. Stubbs's editions of *Benedictus Abbas, Hoveden* and *Diceto* (Rolls series); R. Howlett's edition of "William of Newburgh" and "Richard of Devizes" in *Chronicles, &c., of the Reigns of Stephen, Henry II. and Richard I.* (Rolls series). See also the preface to the third volume of Stubbs's *Hoveden*, pp. lix.-xcviii.; J. H. Round's *Commune of London*, and the French poem on *Guillaume le Maréchal* (ed. P. Meyer, *Soc. de l'Histoire de France*). (H. W. C. D.)

**COUTANCES**, a town of north-western France, capital of an arrondissement of the department of Manche, 7 m. E. of the English Channel and 58 m. S. of Cherbourg on the Western railway. Pop. (1906) 6089. Coutances is beautifully situated on the right bank of the Soule on a granitic eminence crowned by the celebrated cathedral of Notre-Dame. The date of this church has been much disputed, but while traces of Romanesque architecture survive, the building is, in the main, Gothic in style and dates from the first half of the 13th century. The slender turrets massed round the western towers and the octagonal central tower, which forms a lantern within, are conspicuous features of the church. In the interior, which comprises the

nave with aisles, transept and choir with ambulatory and side chapels, there are fine rose-windows with stained glass of the 14th century, and other works of art. Of the other buildings of Coutances the church of St Pierre, in which Renaissance architecture is mingled with Gothic, and that of St Nicolas, of the 16th and 17th centuries, demand mention. There is an aqueduct of the 14th century to the west of the town. Coutances is a quiet town with winding streets and pleasant boulevards bordering it on the east; on the western slope of the hill there is a public garden. The town is the seat of a bishop, a court of assizes and a sub-prefect; it has tribunals of first instance and of commerce, a lycée for boys, a communal college and a training college for girls, and an ecclesiastical seminary. Leather-dressing and wool-spinning are carried on and there is trade in live-stock, in agricultural produce, especially eggs, and in marble.

Coutances is the ancient *Cosedia*, which before the Roman conquest was one of the chief towns in the country of the Unelli. Towards the end of the 3rd century its name was changed to *Constantia*, in honour of the emperor Constantius Chlorus, who fortified it. It became the capital of the *pagus Constantinus* (Cotentin), and in the middle ages was the seat of a viscount. It has been an episcopal see since the 5th century. In the 17th century it was the centre of the revolt of the *Nu-pieds*, caused by the imposition of the salt-tax (*gabelle*).

A good bibliography of general works and monographs on the archaeology and the history of the town and diocese of Coutances is given in U. Chevalier, *Répertoire des sources, &c., Topo-Bibliographie* (Montbéliard, 1894-1899), s.v.

**COUTHON, GEORGES** (1755-1794), French revolutionist, was born at Orcet, a village in the district of Clermont in Auvergne. He studied law, and was admitted advocate at Clermont in 1785. At this period he was noted for his integrity, gentle-heartedness and charitable disposition. His health was feeble and both legs were paralysed. In 1787 he was a member of the provincial assembly of Auvergne. On the outbreak of the Revolution Couthon, who was now a member of the municipality of Clermont-Ferrand, published his *L'Aristocrate converti*, in which he revealed himself as a liberal and a champion of constitutional monarchy. He became very popular, was appointed president of the tribunal of the town of Clermont in 1791, and in September of the same year was elected deputy to the Legislative Assembly. His views had meanwhile been embittered by the attempted flight of Louis XVI., and he distinguished himself now by his hostility to the king. A visit to Flanders for the sake of his health brought him into close intercourse and sympathy with Dumouriez. In September 1792 Couthon was elected member of the National Convention, and at the trial of the king voted for the sentence of death without appeal. He hesitated for a time as to which party he should join, but finally decided for that of Robespierre, with whom he had many opinions in common, especially in matters of religion. He was the first to demand the arrest of the proscribed Girondists. On the 30th of May 1793 he became a member of the Committee of Public Safety, and in August was sent as one of the commissioners of the Convention attached to the army before Lyons. Impatient at the slow progress made by the besieging force, he decreed a *levée en masse* in the department of Puy-de-Dôme, collected an army of 60,000 men, and himself led them to Lyons. When the city was taken, on the 9th of October 1793, although the Convention ordered its destruction, Couthon did not carry out the decree, and showed moderation in the punishment of the rebels. The Republican atrocities began only after Couthon was replaced, on the 3rd of November 1793, by Collot d'Herbois. Couthon returned to Paris, and on the 21st of December was elected president of the Convention. He contributed to the prosecution of the Hébertists, and was responsible for the law of the 22nd Prairial, which in the case of trials before the Revolutionary Tribunal deprived the accused of the aid of counsel or of witnesses or their defence, on the pretext of shortening the proceedings. During the crisis preceding the 9th Thermidor, Couthon showed considerable courage, giving up a journey to Auvergne in order, as he wrote, that he might either die or

triumph with Robespierre and liberty. Arrested with Robespierre and Saint-Just, his colleagues in the triumvirate of the Terror, and subjected to indescribable sufferings and insults, he was taken to the scaffold on the same cart with Robespierre on the 28th of July 1794 (10th Thermidor).

See Fr. Mège, *Correspondance de Couthon . . . suivie de "L'Aristocrate converti," comédie en deux actes de Couthon* (Paris, 1872); and *Nouveaux Documents sur Georges Couthon* (Clermont-Ferrand, 1890); also F. A. Aulard, *Les Orateurs de la Législative et de la Convention* (Paris, 1885-1886), ii. 425-443.

**COUTTS, THOMAS** (1735-1822), English banker and founder of the banking house of Coutts & Co., was born on the 7th of September 1735. He was the fourth son of John Coutts (1699-1751), who carried on business in Edinburgh as a corn factor and negotiator of bills of exchange, and who in 1742 was elected lord provost of the city. The family was originally of Montrose, but one of its members had settled at Edinburgh about 1696. Soon after the death of John Coutts the business was divided into two branches, one carried on in Edinburgh, the other in London. The banking business in London was in the hands of James and Thomas Coutts, sons of John Coutts. From the death of his brother in 1778, Thomas, as surviving partner, became sole head of the firm; and under his direction the banking house rose to the highest distinction. His ambition was to establish his character as a man of business and to make a fortune; and he lived to succeed in this aim and long to enjoy his reputation and wealth. A gentleman in manners, hospitable and benevolent, he counted amongst his friends some of the literary men and the best actors of his day. Of the enormous wealth which came into his hands he made munificent use. His private life was not without its romantic elements. Soon after his settlement in London he married Elizabeth Starkey, a young woman of humble origin, who was in attendance on the daughter of his brother James. They lived happily together, and had three daughters—Susan, married in 1796 to the 3rd earl of Guilford; Frances, married in 1800 to John, 1st marquess of Bute; and Sophia, married in 1793 to Sir Francis Burdett. Mrs Coutts dying in 1815, her husband soon after married the popular actress, Harriet Mellon; and to her he left the whole of his immense fortune. He died in London on the 24th of February 1822. His widow married in 1827 the 9th duke of St Albans, and died ten years later, having bequeathed her property to Angela, youngest daughter of Sir Francis Burdett, who then assumed the additional name and arms of Coutts. In 1871 this lady was created Baroness Burdett-Coutts (*q.v.*).

See C. Rogers, *Genealogical Memoirs of the Families of Colt and Coutts* (1879); and R. Richardson, *Coutts & Co.* (1900).

**COUTURE, THOMAS** (1815-1879), French painter, was born at Senlis (Oise), and studied under Baron A. J. Gros and Paul Delaroche, winning a Prix de Rome in 1837. He began exhibiting historical and *genre* pictures at the Salon in 1840, and obtained several medals. His masterpiece was his "Romans in the Decadence of the Empire" (1847), now in the Luxembourg; and his "Love of Money" (1844; at Toulouse), "Falconer" (1855), and "Damocles" (1872), are also good examples.

**COUVADE** (literally a "brooding," from Fr. *couver*, to hatch, Lat. *cubare*, to lie down), a custom so called in Béarn, prevalent among several peoples in different parts of the world, requiring that the father, at and sometimes before the birth of his child, shall retire to bed and fast or abstain from certain kinds of food, receiving the attentions generally shown to women at their confinements. The existence of the custom in ancient classical times is testified to by Apollonius Rhodius, Diodorus (who refers to its existence among the Corsicans), and Strabo (who noticed it among the Spanish Basques, by whom, as well as by the Gascons, it has been said to be still observed, though the most recent researches entirely discredit this). Travellers, from the time of Marco Polo, who relates its observance in Chinese Turkestan, have found the custom to prevail in China, India, Borneo, Siam, Africa and the Americas. Even in Europe it cannot be said to have entirely disappeared. In certain of the Baltic provinces of Russia the husband, on the lying-in of the wife, takes to his bed and groans in mock pain. One writer believes he found traces of



it in the little island of Marken in the Zuyder Zee. Even in rural England, notably in East Anglia, a curiously obstinate belief survives (the prevalence of which in earlier times is proved by references to it in Elizabethan drama) that the pregnancy of the woman affects the man, and the young husband who complains of a toothache is assailed by pleasantries as to his wife's condition. In Guiana the custom is observed in its most typical form. The woman works to within a few hours of the birth, but some days before her delivery the father leaves his occupations and abstains from certain kinds of animal food lest the child should suffer. Thus the flesh of the agouti is forbidden, lest the child should be lean, and that of the capibara or water-cavy, for fear he should inherit through his father's gluttony that creature's projecting teeth. A few hours before delivery the woman goes alone, or with one or two women-friends, into the forest, where the baby is born. She returns as soon as she can stand, to her work, and the man then takes to his hammock and becomes the invalid. He must do no work, must touch no weapons, is forbidden all meat and food, except at first a fermented liquor and after the twelfth day a weak gruel of cassava meal. He must not even smoke, or wash himself, but is waited on hand and foot by the women. So far is the comedy carried that he whines and groans as if in actual pain. Six weeks after the birth of the child he is taken in hand by his relatives, who lacerate his skin and rub him with a decoction of the pepper-plant. A banquet is then held from which the patient is excluded, for he must not leave his bed till several days later; and for six months he must eat the flesh of neither fish nor bird. Almost identical ceremonies have been noticed among the natives of California and New Mexico; while in Greenland and Kamchatka the husband may not work for some time before and after his wife's confinement. Among the Larkas of Bengal a period of isolation and uncleanness, synchronous with that compulsory on the woman, is imperative for the man, on the conclusion of which the child's parentage is publicly proclaimed.

No certain explanation can be offered for the custom. The most reasonable view is that adopted by E. B. Tylor, who traces in it the transition from the earlier matriarchal to the later patriarchal system of tribe-organization. Among primitive tribes, and probably in all ages, the former order of society, in which descent and inheritance are reckoned through the mother alone, as being the earliest form of family life, is and was very common, if not universal. The acknowledgment of a relationship between father and son is characteristic of the progress of society towards a true family life. It may well be that the Couvade arose in the father's desire to emphasize the bond of blood between himself and his child. It is a fact that in some countries the father has to purchase the child from its mother; and in the Roman ceremony of the husband raising the baby from the floor we may trace the savage idea that the male parent must formally proclaim his adoption and responsibility for the offspring. Max Müller, in his *Chips from a German Workshop*, endeavoured to find an explanation in primitive "henpecking," asserting that the unfortunate husband was tyrannized over by "his female relatives and afterwards frightened into superstition,"—that, in fact, the whole fabric of ceremony is reared on nothing but masculine hysteria; but this theory can scarcely be taken seriously. The missionary, Joseph François Lafitau, suspected a psychological reason, assuming the custom to be a dim recollection of original sin, the isolation and fast types of repentance. The explanation of the American Indians is that if the father engaged in any hard or hazardous work, e.g. hunting, or was careless in his diet, the child would suffer and inherit the physical faults and peculiarities of the animals eaten. This belief that a person becomes possessed of the nature and form of the animal he eats is widespread, being as prevalent in the Old World as in the New, but it is insufficient to account for the minute ceremonial details of La Couvade as practised in many lands. It is far more likely that so universal a practice has no trivial beginnings, but is to be considered as a mile-stone marking a great transitional epoch in human progress.

AUTHORITIES.—E. B. Tylor's *Early History of Man* (1865; and

ed. p. 301); F. Max Müller, *Chips from a German Workshop* (1868-1875), ii. 281; Lord Avebury, *Origin of Civilisation* (1900); Brett's *Indian Tribes of Guiana*; Johann Baptist von Spix and Karl F. P. von Martius, *Travels in Brazil* (1823-1831), ii. 281; J. F. Lafitau, *Mœurs des sauvages américains* (1st ed., 1724); W. Z. Ripley, *Races of Europe* (1900); A. H. Keane's *Ethnology* (1896), p. 368 and footnote; A. Giraud-Teulon, *Les Origines du mariage et de la famille* (Paris, 1884).

**COVE**, a word mostly used in the sense of a small inlet or sheltered bay in a coast-line. In English dialect usage it is also applied to a cave or to a recess in a mountain-side. The word in O. Eng. is *cofa*, and cognate forms are found in the Ger. *Koben*, Norwegian *kove*, and in various forms in other Teutonic languages. It has no connexion with "alcove," recess in a room or building, which is derived through the Span. *alcoba* from Arab. *al*, the, and *qubbah*, vault, arch, nor with "cup" or "coop," nor with "cave" (Lat. *cava*). The use of the word was first confined to a small chamber or cell or inner recess in a room or building. From this has come the particular application in architecture to any kind of concave moulding, the term being usually applied to the quadrantal curve rising from the cornice of a lofty room to the moulded borders of the horizontal ceiling. The term "coving" is given in half-timbered work to the curved soffit under a projecting window, or in the 18th century to that occasionally found carrying the gutter of a house. In the Musée Plantin at Antwerp the hearth of the fireplace of the upper floor is carved on coving, which forms part of the design of the chimney-piece in the room below. The slang use of "cove" for any male person, like a "fellow," "chap," &c., is found in the form "cofe" in T. Harman's *Caveat for Curseators* (1587) and other early quotations. This seems to be identical with the Scots word "cofe," a pedlar, hawker, which is formed from "coff," to sell, purchase, cognate with the Ger. *kaufen*, to buy, and the native English "cheap." The word "cove," therefore, is in ultimate origin the same as "chap," short for "chapman," a pedlar.

**COVELLITE**, a mineral species consisting of cupric sulphide, CuS, crystallizing in the hexagonal system. It is of less frequent occurrence in nature than copper-glance, the orthorhombic cuprous sulphide. Crystals are very rare, the mineral being usually found as compact and earthy masses or as a blue coating on other copper sulphides. Hardness 1½-2; specific gravity 4.6. The dark indigo-blue colour is a characteristic feature, and the mineral was early known as indigo-copper (Ger. *Kupferindig*). The name covellite is taken from N. Covelli, who in 1839 observed crystals of cupric sulphide encrusting Vesuvian lava, the mineral having been formed here by the interaction of hydrogen sulphide and cupric chloride, both of which are volatile volcanic products. Covellite is, however, more commonly found in copper-bearing veins, where it has resulted by the alteration of other copper sulphides, namely chalcopyrite, copper-glance and erubescite. It is found in many copper mines; localities which may be specially mentioned are Sangerhausen in Prussian Saxony, Butte in Montana, and Chile; in the Medicine Bow Mountains, of Wyoming a platiniferous covellite is mined, the platinum being present as sperrylite (platinum arsenide). (L. J. S.)

**COVENANT** (an O. Fr. form, later *convenant*, from *convenir*, to agree, Lat. *convenire*), a mutual agreement of two or more parties, or an undertaking made by one of the parties. In the Bible the Hebrew word *בְּרִית*, *bērîth*, is used widely for many kinds of agreements; it is then applied to a contract between two persons or to a treaty between two nations, such as the covenant made between Abimelech and Isaac, representing a treaty between the Israelites and the Philistines (Gen. xxvi. 26 seq.); more particularly to an engagement made between God and men, or such agreements as, by the observance of a religious rite, regarded God as a party to the engagement. Two suggestions have been made for the derivation of *bērîth*: (1) tracing the word from a root "to cut," and the reference is to the primitive rite of cutting victims into parts, between which the parties to an agreement passed, cf. the Greek *θυσια τίμνω*, and the account (Gen. xv. 17) of the covenant between God and Abraham, where "a smoking furnace and burning lamp passed

between the pieces" of the victims Abraham had sacrificed; (2) connecting it with an Assyrio-Babylonian *biritu*, fetter, alliance. *Berith* was translated in the Septuagint by *diathēnē*, which in classical Greek had the meaning of "will"; hence the Vulgate, in the Psalms and the New Testament, translates the word by *testamentum*; but elsewhere in the Old Testament by *foedus* or *factum*; similarly Wycliffe's version gives "testament" and "covenant" respectively. The books of Scripture dealing with the old or Mosaic, and new or Christian dispensation are sometimes known as the Books of the Old and the New Covenant. The word appears in the system of theology developed by Johannes Cocceius (*q. n.*), and known as the "Covenant" or "Federal" Theology, based on the two Covenants of Works or Life made by God with Adam, on condition of obedience, and of grace or redemption, made with Christ. In Scottish ecclesiastical history, covenant appears in the two agreements signed by the members of the Scottish Church in defence of their religious and ecclesiastical systems (see COVENANTERS).

**COVENANT**, in law, is the English equivalent of the Lat. *conventio*, which, although not technical, was the most general word in Roman law for "agreement." It was frequently used along with *pactum*, also a general term, but applied especially to agreements to settle a question without carrying it before the courts of law.

The word "covenant" has been used in a variety of senses in English law.

1. In its strict sense, covenant means an agreement *under seal*; that something has or has not already been done, or shall or shall not be done hereafter (Shep. *Touchstone*, 160, 162). It is most commonly used with reference to sales or leases of land, but is sometimes applied to any promise or stipulation, whether under seal or not. The person who makes, and is bound to perform, the promise or stipulation is the covenantor; the person in whose favour it is made is the covenantee.

2. Covenants have been subdivided into numerous classes, only a few of which need to be described. It is unnecessary to do more than mention affirmative and negative covenants, joint or several, alternative or disjunctive covenants, dependent or independent covenants. As to collateral covenants, covenants "running with the land," and covenants in leases (including "usual," "proper" and "restrictive" covenants), see LANDLORD AND TENANT. But there are other classes as to which something must be said.

A covenant is said to be *express* when it is created by the express words of the parties to the deed declaratory of their intention. It is not indispensable that the word "covenant" should be used. Any word which clearly indicates the intention of the parties to covenant will suffice. An *implied* covenant, or *covenant in law*, "depends for its existence on the intentment and construction of law." There are some words which of themselves do not import an express covenant, yet, being made use of in certain contracts, have a similar operation and are called covenants in law; and they are as effectually binding on the parties as if expressed in the most unequivocal terms" (Platt on *Covenants*, p. 40). Thus, the word "demise," used in a lease of deed, raises the implication of a covenant both for "quiet enjoyment" and for title to let; and it has been judicially suggested that a covenant for quiet enjoyment may be implied from any word or words of like import (*Budd-Scott v. Daniell*, 1902, 2 K.B. p. 359). The Conveyancing Act 1881 provides (§ 7) that in a conveyance for valuable consideration, other than a mortgage, there shall be implied, as against the person who conveys and is expressed to convey as "beneficial owner," certain *qualified* covenants—*i. e.* covenants extending only to the acts or omissions of the vendor, persons through whom he derives title otherwise than by purchase for value, and persons claiming under them—for "right to convey," "quiet enjoyment," "freedom from incumbrances" and "further assurance." Of these statutory covenants for title the only one which requires explanation is the covenant for further assurance. It imports an agreement on the part of the covenantor to do such reasonable acts, in addition to those already performed, as may be necessary

for the completion of the transfer made (or intended to be made) at the requirements of the covenantee (Platt on *Covenants*, p. 341). All these statutory implied covenants "run with the land" (see LANDLORD AND TENANT). Where a mortgagor conveys, and is expressed to convey, as "beneficial owner," there are implied *absolute* covenants—*i. e.* covenants amounting to a warranty against and for the acts and omissions of the whole world—that he has a right to convey, that the mortgagee shall have quiet enjoyment of the property after default, free from incumbrances and for further assurance. Special provisions as to implied covenants by the lessor in leases are made in England by § 7 (B) of the Conveyancing Act 1881 and in Ireland by the Land Act (Ireland) 1860, § 41. The distinction between *real* and *personal* covenants is that the former do, while the latter do not, run with the land. An *inherent* covenant is another name for a *real* covenant (Shep. *Touchstone*, 176; Platt, 60). When a covenant relates to an act already done, it is usually termed a covenant *executed*; where the performance is future, the covenant is termed *executory*. The *covenant for seisin* was an assurance to the grantee that the grantor had the estate which he purported to convey. In England it is now included in the covenant for right to convey; but is still in separate use in several states in America. The *covenant to stand seised to uses* was an assurance by means of which, under the Statute of Uses [1536] (see USES), a conveyance of an estate might be effected. When such a covenant is made, the legal estate in the land passes at once to the covenantee under the statute. The consideration for the covenant must be relationship by blood or marriage. It is still occasionally though very rarely employed. The *covenant not to sue* belongs to the law of contract and needs no explanation.

Most of the classes of covenants above mentioned are in use in the United States. In New York, Michigan, Minnesota, Oregon, Wisconsin and Wyoming the implication of covenants for title has been, with certain exceptions, prohibited by statute. In Alabama, Arkansas, Delaware, Illinois, Indiana, Mississippi, Missouri, Montana, Nevada, New Mexico, Pennsylvania and Texas the words *grant, bargain and sell*, in conveyances in fee, unless specially restricted, amount to qualified covenants that the grantor was seised in fee, free from incumbrances, and for quiet enjoyment (4 Kent, *Commentaries*, § 473; Bouvier, *Law Dictionary*, *s. v.* Covenant). In some of the states a *covenant of non-claim*, or of *warranty*, an assurance by the grantor that neither he nor his heirs, nor any other person shall claim any title in the premises conveyed, is in general use.

3. An *action of covenant* lay for breaking covenant. As to the history of this action see Pollock and Maitland, *History of English Law*, ii, 106; and Holmes, *The Common Law*, p. 272. There was also a *writ of covenant*. But this remedy had fallen into disuse before 1830 (see Platt on *Covenants*, p. 543), and was abolished by the Common Law Procedure Acts. Since the Judicature Acts, an action on a covenant follows the same course as, and is indistinguishable from, any ordinary action for breach of contract. The remedy is by damages, decree of specific preference or injunction to prevent the breach.

The term "covenant" is unknown to Scots law. But its place is filled to some extent by the doctrine of "warrandice." Many of the British colonies have legislated, as to the implication of covenants for title, on the lines of the English Conveyancing Act 1881; *e. g.* Tasmania, Conveyancing and Law of Property Act 1884 (47 Vict. No. 10).

As to covenants in restraint of trade see RESTRAINT. **AUTHORITIES**.—In addition to the authorities cited in the text see: *English Law*: Goodeve, *Law of Real Property* (5th ed., London, 1906); C. Foa, *Landlord and Tenant* (3rd ed., London, 1901); Hamilton, *Law of Covenants* (London); Fawcett, *Law of Landlord and Tenant* (3rd ed., London, 1905). *American Law*: Rawle, *Law of Covenants for Title* (Boston, 1887); *Encyclopaedia of American Law* (3rd ed., 1890), vol. viii, tit. "Covenants" (A. W. R.).

**COVENANTERS**, the name given to a party which, originating in the Reformation movement, played an important part in the history of Scotland; and to a lesser extent in that of England, during the 17th century. The Covenanters were thus named because in a series of *bands of covenants* they bound themselves to maintain the Presbyterian doctrine and polity as the sole religion of their country. The first "godly band" is dated December 1557; but more important is the covenant of 1581, drawn up by John Craig in consequence of the strenuous efforts

which the Roman Catholics were making to regain their hold upon Scotland, and called the King's Confession or National Covenant. Based upon the Confession of Faith of 1560, this document denounced the pope and the doctrines of the Roman Catholic Church in no measured terms. It was adopted by the General Assembly, signed by King James VI. and his household, and enjoined on persons of all ranks and classes; and was again subscribed in 1590 and 1596. In 1637 Scotland was in a state of turmoil. Charles I. and Archbishop Laud had just met with a reverse in their efforts to impose the English liturgy upon the Scots; and fearing further measures on the part of the king, it occurred to Archibald Johnston, Lord Warriston, to revive the National Covenant of 1581. Additional matter intended to suit the document to the special circumstances of the time was added, and the covenant was adopted and signed by a large gathering in Greyfriars' churchyard, Edinburgh, on the 28th of February 1638, after which copies were sent throughout the country for additional signatures. The subscribers engaged by oath to maintain religion in the state in which it existed in 1580, and to reject all innovations introduced since that time, while professed expressions of loyalty to the king were added. The General Assembly of 1638 was composed of ardent Covenanters, and in 1640 the covenant was adopted by the parliament, and its subscription was required from all citizens. Before this date the Covenanters were usually referred to as *Supplicants*, but from about this time the former designation began to prevail.

A further development took place in 1643. The leaders of the English parliament, worsted in the Civil War, implored the aid of the Scots, which was promised on condition that the Scottish system of church government was adopted in England. After some haggling a document called the Solemn League and Covenant was drawn up. This was practically a treaty between England and Scotland for the preservation of the reformed religion in Scotland, the reformation of religion in England and Ireland "according to the word of God and the example of the best reformed churches," and the extirpation of popery and prelacy. It was subscribed by many in both kingdoms and also in Ireland, and was approved by the English parliament, and with some slight modifications by the Westminster Assembly of Divines. Charles I. refused to accept it when he surrendered himself to the Scots in 1646, but he made important concessions in this direction in the "Engagement" made with the Scots in December 1647. Charles II. before landing in Scotland in June 1650 declared by a solemn oath his approbation of both covenants, and this was renewed on the occasion of his coronation at Scone in the following January.

From 1638 to 1651 the Covenanters were the dominant party in Scotland, directing her policy both at home and abroad. Their power, however, which had been seriously weakened by Cromwell's victory at Dunbar in September 1651, was practically destroyed when Charles II. was restored nine years later. Firmly seated upon the throne Charles renounced the covenants, which in 1662 were declared unlawful oaths, and were to be abjured by all persons holding public offices. Episcopacy was restored, the court of high commission was revived, and ministers who refused to recognize the authority of the bishops were expelled from their livings. Gathering around them many of the Covenanters who clung tenaciously to their standards of faith, these ministers began to preach in the fields, and a period of persecution marked by savage hatred and great brutality began. Further oppressive measures were directed against the Covenanters, who took up arms about 1665, and the struggle soon assumed the proportions of a rebellion. The forces of the crown under John Graham of Claverhouse and others were sent against them, and although the insurgents gained isolated successes, in general they were worsted and were treated with great barbarity. They maintained, however, their cherished covenants with a zeal which persecution only intensified; in 1680 the more extreme members of the party signed a document known as the "Sanquhar Declaration," and were afterwards called Cameronians from the name of their leader, Richard Cameron (*q.v.*). They renounced their allegiance to King James

and were greatly disappointed when their standards found no place in the religious settlement of 1689, continuing to hold the belief that the covenants should be made obligatory upon the entire nation. The Covenanters had a martyrology of their own, and the halo of romance has been cast around their exploits and their sufferings. Their story, however, especially during the time of their political predominance, is part of the general history of Scotland (*q.v.*).

The texts of the National Covenant and the Solemn League and Covenant are printed in S. R. Gardiner's *Constitutional Documents of the Puritan Revolution* (Oxford, 1899). See also J. H. Burton, *History of Scotland* (Edinburgh, 1905); A. Lang, *History of Scotland* (Edinburgh, 1900); S. R. Gardiner, *History of England* (London, 1883-1884); G. Grub, *Ecclesiastical History of Scotland* (Edinburgh, 1861); J. Macpherson, *History of the Church in Scotland* (Paisley, 1901); and J. K. Hewison, *The Covenanters* (1908).

**COVENT GARDEN**, formerly an open space north of the Strand, London, England, now occupied by the principal flower, fruit and vegetable market in the metropolis. This was originally the so-called "convent garden" belonging to the abbey of St Peter, Westminster. In the first half of the 17th century the site of the garden was laid out as a square by Inigo Jones, with a piazza on two sides; and as early as 1656 it was becoming a market place for the same commodities as are now sold in it. Covent Garden Theatre (1858) is the chief seat of grand opera in London. The site has carried a theatre since 1733, but earlier buildings were burnt in 1809 and 1856.

**COVENTRY, SIR JOHN** (d. 1682), son of John Coventry, the second son of Thomas, Lord Keeper Coventry, was returned to the Long Parliament in 1640 as member for Evesham. During the Civil War he served for the king, and at the Restoration was created a knight. In 1667, and in the following parliaments of 1678, 1679 and 1681, he was elected for Weymouth, and opposed the government. On the 21st of December 1670, owing to a jest made by Coventry in the House of Commons on the subject of the king's amours, Sir Thomas Sandys, an officer of the guards, with other accomplices, by the order of Monmouth, and (it was said) with the approval of the king himself, waylaid him as he was returning home to Suffolk Street and slit his nose to the bone. The outrage created an extraordinary sensation, and in consequence a measure known as the "Coventry Act" was passed, declaring assaults accompanied by personal mutilation a felony without benefit of clergy. Sir John died in 1682. Sir William Coventry, his uncle, speaks slightly of him, ridicules his vanity and wishes him out of the House of Commons to be "out of harm's way."

**COVENTRY, THOMAS COVENTRY, 1ST BARON** (1578-1640), lord keeper of England, eldest son of Sir Thomas Coventry, judge of the common pleas (a descendant of John Coventry, lord mayor of London in the reign of Henry VI.), and of Margaret Jeffreys of Earls Croome, or Croome D'Abitot, in Worcestershire, was born in 1578. He entered Balliol College, Oxford, in 1592, and the Inner Temple in 1594, becoming bencher of the society in 1614, reader in 1616, and holding the office of treasurer from 1617 till 1621. His exceptional legal abilities were rewarded early with official promotion. On the 16th of November 1616 he was made recorder of London in spite of Bacon's opposition, who, although allowing him to be "a well trained and an honest man," objected that he was "bred by my Lord Coke and seasoned in his ways."<sup>1</sup> On the 14th of March 1617 he was appointed solicitor-general and was knighted; was returned for Droitwich to the parliament of 1621; and on the 11th of January in that year was made attorney-general. He took part in the proceedings against Bacon for corruption, and was manager for the Commons in the impeachment of Edward Floyd for insulting the elector and electress palatine.

On the 1st of November 1625 he was made lord keeper of the great seal; in this capacity he delivered the king's reprimand to the Commons on the 29th of March 1626, when he declared that "liberty of counsel" alone belonged to them and not "liberty of control." On the 10th of April 1628 he received the title of Baron Coventry of Aylesborough in Worcestershire. At the

<sup>1</sup> Spedding's *Bacon*, vi. 97.

opening of parliament in 1628 he threatened that the king would use his prerogative if further thwarted in the matter of supplies. In the subsequent debates, however, while strongly supporting the king's prerogative against the claims of the parliament to executive power, he favoured a policy of moderation and compromise. He defended the right of the council to commit to prison without showing cause, and to issue "general" warrants; though he allowed it should only be employed in special circumstances, disapproved of the king's sudden dissolution of parliament, and agreed to the liberation on bail of the seven imprisoned members on condition of their giving security for their good behaviour. He showed less subservience than Bacon to Buckingham, and his resistance to the latter's pretensions to the office of lord high constable greatly incensed the duke. Buckingham taunted Coventry with having gained his place by his favour; to which the lord keeper replied, "Did I conceive I had my place by your favour, I would presently unmake myself by returning the seal to his Majesty."<sup>1</sup> After this defiance Buckingham's sudden death alone probably prevented Coventry's displacement. He passed sentence of death on Lord Audley in 1631, drafted and enforced the proclamation of the 20th of June 1632 ordering the country gentlemen to leave London, and in 1634 joined in Laud's attack on the earl of Portland for speculation. The same year, in an address to the judges, he supported the proposed levy of ship-money on the inland as well as the maritime counties on the plea of the necessity of effectually arming, "so that they might not be enforced to fight," "the wooden walls" being in his opinion "the best walls of this kingdom."<sup>2</sup> In the Star Chamber Coventry was one of Lilburne's judges in 1637, but he generally showed conspicuous moderation, inclining to leniency in the cases of Richard Chambers in 1629 for seditious speeches, and of Henry Sherfield in 1632 for breaking painted glass in a church. He prevented also the hanging of men for resistance to impressment, and pointed out its illegality, since the men were not subject to martial law. While contributing thirty horse to the Scottish expedition in 1638, and lending the king £10,000 in 1639, he gave no support to the forced loan levied upon the city in the latter year. He died on the 14th of January 1640.

Lord Coventry held the great seal for nearly fifteen years, and was enabled to collect a large fortune. He was an able judge, and he issued some important orders in chancery, probably alluded to by Wood, who ascribes to him a tract on "The Fees of all law Officers."<sup>3</sup> Whitelocke accuses him of mediocrity,<sup>4</sup> but his contemporaries in general have united in extolling his judicial ability, his quick despatch of business and his sound and sterling character. Clarendon in particular praises his statesmanship, and compares his capacity with Lord Strafford's, adding, however, that he seldom spoke in the council except on legal business and had little influence in political affairs; to the latter circumstance he owed his exceptional popularity. He describes him as having "in the plain way of speaking and delivery a strange power of making himself believed," as a man of "not only firm gravity but a severity and even some morosity," as "rather exceedingly liked than passionately loved."

Lord Coventry married (1) Sarah, daughter of Sir Edward Sebright of Besford in Worcestershire, by whom besides a daughter he had one son, Thomas, who succeeded him as 2nd baron, and (2) Elizabeth, daughter of John Aldersley of Spurstow, Cheshire, and widow of William Pitchford, by whom he had four sons, John, Francis, Henry and Sir William Coventry, the statesman.

Thomas Coventry, 5th baron (d. 1699), was created an earl in 1697 with a special limitation, on failure of his own male issue, to that of Walter, youngest brother of the lord keeper, from whom the present earl of Coventry is descended.

**COVENTRY, SIR WILLIAM** (c. 1628-1686), English statesman, son of the lord keeper, Thomas, Lord Coventry, by his second

wife Elizabeth Aldersley, was born about 1628. He matriculated at Queen's College, Oxford, at the age of fourteen. Owing to the outbreak of the Civil War he was obliged to quit his studies, but according to Sir John Bramston "he had a good tutor who made him a scholar, and he travelled and got the French language in good perfection." "He was young whilst the war continued," wrote Clarendon, "yet he had put himself before the end of it into the army and had the command of a foot company and shortly after travelled into France." Here he remained till all hopes of obtaining foreign assistance and of raising a new army had to be laid aside, when he returned to England and kept aloof from the various royalist intrigues. When, however, a new prospect of a restoration appeared in 1660, Coventry hastened to Breda, was appointed secretary to James, duke of York, lord high admiral of England, and headed the royal procession when Charles entered London in triumph.

He was returned to the Restoration parliament of 1661 for Great Yarmouth, became commissioner for the navy in May 1662 and in 1663 was made D.C.L. at Oxford. His great talents were very soon recognized in parliament, and his influence as an official was considerable. His appointment was rather that of secretary to the admiralty than of personal assistant to the duke of York,<sup>5</sup> and was one of large gains. Wood states that he collected a fortune of £60,000. Accusations of corruption in his naval administration, and especially during the Dutch war, were brought against him, but there is nothing to show that he ever transgressed the limits sanctioned by usage and custom in obtaining his emoluments. Pepys in his diary invariably testifies to the excellence of his administration and to his zeal for reform and economy. His ability and energy, however, did little to avert the naval collapse, owing chiefly to financial mismanagement and to the ill-advised appointments to command. Coventry denied all responsibility for the Dutch War in 1665, which Clarendon sought to place upon his shoulders, and his repudiation is supported by Pepys; it was, moreover, contrary to his well-known political opinion. The war greatly increased his influence, and shortly before the victory off Lowestoft, on the 31st of June 1665, he was knighted and made a privy councillor (26th of June) and was subsequently admitted to the committee on foreign affairs. In 1667 he was appointed to the board of treasury to effect financial reforms. "I perceive," writes Pepys on the 23rd of August 1667, "Sir William Coventry is the man and nothing done till he comes," and on his removal in 1669 the duke of Albemarle, no friendly or partial critic, declares that "nothing now would be well done." His appointment, however, came too late to ward off the naval disaster at Chatham the same year and the national bankruptcy in 1672.

Meanwhile Coventry's rising influence had been from the first the cause of increasing jealousy to the old chancellor Clarendon, who especially disliked and discouraged the younger generation. Coventry resented this repression and thought ill of the conduct of the administration. He became the chief mover in the successful attack made upon Clarendon, but refused to take any part in his impeachment. Two days after Clarendon's resignation (on the 31st of August), Coventry announced his intention of leaving the duke's service and of terminating his connexion with the navy.<sup>6</sup> As the principal agent in effecting Clarendon's fall he naturally acquired new power and influence, and the general opinion pointed to him as his successor as first minister of the crown. Personal merit, patriotism and conspicuous ability, however, were poor passports to place and power in Charles II.'s reign. Coventry retained merely his appointment at the treasury, and the brilliant but unscrupulous and incapable duke of Buckingham, a favourite of the king, succeeded to Lord Clarendon. The relations between the two men soon became unfriendly. Buckingham ridiculed Sir William's steady attention to business, and was annoyed at his opposition to Clarendon's impeachment. Coventry rapidly lost influence, was excluded from the cabinet council, and six months after Clarendon's fall complains he has scarcely a friend at court. Finally, in March

<sup>1</sup> Hackett's *Life of Bishop Williams*, ii. 19.

<sup>2</sup> Rushworth (1680), part ii. vol. i. 294. <sup>3</sup> *Ath. Oxon.* ii. 650.

<sup>4</sup> There is an adverse opinion also expressed in Pepys's *Diary*, August 26, 1666, probably based on little real knowledge.

<sup>5</sup> *Pepysiana*, by H. B. Wheatley (1903), 154.

<sup>6</sup> Foxcroft, *Life of Sir G. Savile*, i. 54.

1669, Buckingham having written a play in which Sir William was ridiculed, the latter sent him a challenge. Notice of the challenge reached the authorities through the duke's second, and Sir William was imprisoned in the Tower on the 3rd of March and subsequently expelled from the privy council. He was superseded in the treasury on the 11th of March by Buckingham's favourite, Sir Thomas Osborne, afterwards earl of Danby and duke of Leeds, and was at last released from the Tower on the 21st in disgrace. The real cause of his dismissal was clearly the final adoption by Charles of the policy of subservience to France and desertion of Holland and Protestant interests. Six weeks before Coventry's fall, the conference between Charles, James, Arlington, Clifford and Arundel had taken place, which resulted a year and a half later in the disgraceful treaty of Dover. To such schemes Sir William, with his steady hostility to France and active devotion to Protestantism, was doubtless a formidable opponent. He now withdrew definitely from official life, still retaining, however, his ascendancy in the House of Commons, and leading the party which condemned and criticized the reactionary and fatal policy of the government, his credit and reputation being rather enhanced than diminished by his dismissal.<sup>1</sup>

In 1673 was published a pamphlet which went through five editions the same year, entitled *England's appeal from the Private Cabal at Whitehall to the Great Council of the Nation . . . by a true Lover of his Country*, an anonymous work universally ascribed to Sir William, which forcibly reflects his opinions on the French entanglement. In the great matter of the Indulgence, while refusing to discuss the limits of prerogative and liberty, he argued that the dispensing power of the crown could not be valid during the session of parliament, and criticized the manner of the declaration while approving its ostensible object. He supported the Test Act, but maintained a statesmanlike moderation amidst the tide of indignation rising against the government, and refused to take part in the personal attacks upon ministers, drawing upon himself the same unpopularity as his nephew Halifax incurred later. In the same year he warmly denounced the alliance with France. During the summer of 1674 he was again received at court. In 1675 he supported the bill to exclude Roman Catholics from both Houses, and also the measure to close the House of Commons to placemen; and he showed great activity in his opposition to the French connexion, especially stigmatizing the encouragement given by the government to the levying of troops for the French service. In May 1677 he voted for the Dutch alliance. Like most of his contemporaries he accepted the story of the popish plot in 1678. Coventry several times refused the highest court appointments, and he was not included in Sir W. Temple's new-modelled council in April 1679. In the exclusion question he favoured at first a policy of limitations, and on his nephew Halifax, who on his retirement became the leader of the moderate party, he enjoined prudence and patience, and greatly regretted the violence of the opposition which eventually excited a reaction and ruined everything. He refused to stand for the new parliament, and retired to his country residence at Minster Lovell near Witney, in Oxfordshire. He died unmarried on the 23rd of June 1686, at Somerhill near Tunbridge Wells, where he had gone to take the waters, and was buried at Penshurst, where a monument was erected to his memory. In his will he ordered his funeral to be at small expense, and left £2000 to the French Protestant refugees in England; besides £3000 for the liberation of captives in Algiers. He had shortly before his death already paid for the liberation of sixty slaves. He was much beloved and respected in his family circle, his nephew, Henry Savile, alluding to him in affectionate terms as "our dearest uncle" and "incomparable friend."

Though Sir William Coventry never filled that place in the national administration to which his merit and exceptional ability clearly entitled him, his public life together with his correspondence are sufficient to distinguish him from amongst his contemporaries as a statesman of the first rank. Lord Halifax obviously derived from his honoured mentor those principles of government which, by means of his own brilliant

<sup>1</sup> *Savile Correspondence* (Camden Soc.), 295.

intellectual gifts, originality and imaginative insight, gained further force and influence. Halifax owed to him his interest in the navy and his grasp of the necessity to a country of a powerful maritime force. He drew his antagonism to France, his religious tolerance, wide religious views but firm Protestantism doubtless from the same source. Sir William was the original "Trimmer." Writing to his nephew Viscount Weymouth, while denying the authorship of *The Character of a Trimmer*, he says:—"I have not been ashamed to own myself to be a trimmer . . . one who would sit upright and not overturn the boat by swaying too much to either side." He shared the Trimmer's dislike of party, urging Halifax in the exclusion contest "not to be thrust by the opposition of his enemies into another party, but that he keep upon a national bottom which at length will prevail." His prudence is expressed in his "perpetual unwillingness to do things which I cannot undo." "A singular independence of spirit, a breadth of mind which refused to be contracted by party formulas, a sanity which was proof against the contagion of national delirium, were equally characteristic of uncle and nephew."<sup>2</sup> Sir William Coventry's conceptions of statesmanship, under the guiding hand of his nephew, largely inspired the future revolution settlement, and continued to be an essential condition of English political growth and progress.

Besides the tract already mentioned Coventry was the author of *A Letter to Dr Burnet giving an Account of Cardinal Pool's Secret Powers . . .* (1685). *The Character of a Trimmer*, often ascribed to him, is now known to have been written by Lord Halifax. "Notes concerning the Poor," and an essay "concerning the decay of rents and the remedy," are among the Malet Papers (*Hist. MSS. Comm. Ser. 5th Rep. app. 320 (a)*) and *Add. MSS. Brit. Mus.* (cal. 1882-1887); an "Essay concerning France" (4th Rep. app. 229 (b)) and a "Discourse on the Management of the Navy" (230b) are among the MSS. of the marquess of Bath, also a catalogue of his library (233(a)).

BIBLIOGRAPHY.—No adequate life of Sir William Coventry has been written; the most satisfactory appreciation of his character and abilities is to be found in the several passages relating to him in the *Life of George Savile, Marquis of Halifax*, by Miss A. C. Foxcroft (1898); see also *Hist. MSS. Comm. 3 and 4 Rep.* (Longleat Collection), 5 Rep. (*Malet Collection* and see Index) now in the Brit. Mus. add. Cal. (1882-1887), some of his papers being also at Devonshire House; *MSS. of Marquis of Ormond*, iii. of *J. M. Heathcote and Miscellaneous Collections*; *Clarendon's Life and Continuation* (Oxford, 1857); *Calendar of Clarendon Papers*; *Burnet's Hist. of His Own Times* (Oxford, 1823); *Hallam's Constitutional Hist.* (1854), chap. xi.; *John Evelyn's Memoirs*; *Pepys's Diary and Pepysiana* (ed. H. B. Wheatley, 1903); *Calendar of State Papers, Domestic; Savile Correspondence* (Camden Society, 1858, vol. lxxi.); *A. Grey's Debates*; *Sir John Bramston's Autobiography* (Camden Soc., 1845); *Wood's Athenae Oxonienses*, iv. 190; *Saturday Review* (Oct. 11, 1873). (P. C. Y.)

COVENTRY, a municipal, county and parliamentary borough of Warwickshire, England; 94 m. N.W. from London by the London & North Western railway. Pop. (1901) 69,978. The Coventry canal communicates with the Trent and Mersey and Birmingham canals, and the midland system generally. Coventry stands on a gentle eminence, with higher ground lying to the west, and is watered by the Sherbourne and the Radford Brook, feeders of the Avon, which unite within the town. Of its ancient fortifications two gates and some portions of the wall are still extant, and several of the older streets are picturesque from the number of half-timbered houses projecting over the footways.

The most remarkable buildings are the churches; of these the oldest are St Michael's, one of the finest specimens of Perpendicular architecture in England, with a beautiful steeple rising to a height of 303 ft.; Holy Trinity church, a cruciform structure with a lofty steeple at the intersection; and St John's, or Bablake church, which is nearly a parallelogram on the ground plan, but cruciform in the clerestory with a central tower. Christ church dates only from 1832, but it is attached to the ancient spire of the Grey Friars' church. Of secular buildings the most interesting is St Mary's hall, erected by the united guilds in the early part of the 15th century. The principal chamber,

<sup>2</sup> Foxcroft's *Life of Sir G. Savile*, i. 36.



situated above a fine crypt, is 76 ft. long, 30 ft. wide and 34 ft. high; its roof is of carved oak, and in the north end there is a large window of old stained glass, with a curious piece of tapestry beneath nearly as old as the building. In the treasury is preserved a valuable collection of ancient monuments. A statue of Sir Thomas White, lord mayor of London (1532-1533), founder of St John's College, Oxford, was erected in 1883. The cemetery, laid out by Sir Joseph Paxton, the architect and landscape gardener, and enlarged in 1887, is particularly beautiful. The educational institutions include a well-endowed free grammar school, founded in the reign of Elizabeth, in modern buildings (1885), a technical school, school of art, endowed charity schools, and a county reformatory for girls; and among the charitable foundations, which are numerous and valuable, Bond's hospital for old men and Ford's hospital for old women are remarkable as fine specimens of ancient timber work. Swanswell and Spenser Parks were opened in 1883, and a recreation ground in 1880.

Coventry was formerly noted for its woollens, and subsequently acquired such a reputation for its dyeing that the expression "as true as Coventry blue" became proverbial. Existing industries are the making of motor cars, cycles and their accessories, for which Coventry is one of the chief centres in Great Britain; sewing machines are also produced; and carpet-weaving and dyeing, art metal working and watch making are carried on. An ancient fair is held in Whit-week. A county of itself till 1843, the town became a county borough in 1888. The corporation consists of a mayor, 10 aldermen and 30 councillors. The parliamentary borough returns one member. In 1894 a suffragan bishopric of Coventry was established under the see of Worcester, but no longer exists. Area, 4149 acres.

The village which afterwards became important as Coventry (*Coventreu, Coventre*) owed its existence to the foundation of a Benedictine monastery by Earl Leofric and his wife Godgyfu, the famous Lady Godiva (*g.v.*), in 1043. The manor, which in 1066 belonged to the latter, descended to the earls of Chester and to Robert de Montalt, and from him passed to Isabella queen of Edward II. and the crown. Ranulf, earl of Chester, granted the earliest extant charter to the town in 1153, by which his burgesses were to hold of him in free burghage as they held of his father, and to have their portmote. This, with further privileges, was confirmed by Henry II. in 1177, and by nearly every succeeding sovereign until the 17th century. In 1345 Edward III. gave Coventry a corporation, mayor and bailiffs empowered to hold pleas and keep the town prison. Edward the Black Prince granted the mayor and bailiffs the right to hold the town in fee farm of £50 and to build a wall. In 1452 Henry VI. formed the city and surrounding hamlets into a county, and James I. incorporated Coventry in 1622. It first sent two representatives to parliament in 1295, but the returns were irregular. The prior's market on Fridays was probably of Saxon origin; a second market was granted in 1348, while fairs, still held, were obtained in 1217 for the octave of Holy Trinity, and in 1348 and in 1442 for eight days from the Friday after Corpus Christi. As early as 1216 Coventry was important for its trade in wool, cloth and caps, its gilds later being particularly numerous and wealthy. In 1568 Flemish weavers introduced new methods, but the trade was destroyed in the wars of the 17th century. During the middle of the 16th century there was a flourishing manufacture of blue thread, but this decayed before 1581; in the 18th century the manufacture of ribbon was introduced.

The popular phrase "to send to Coventry" (*i.e.* to refuse to associate with a person) is of uncertain derivation. The *New English Dictionary* selects the period of the Civil War of the 17th century as that in which the origin of the phrase is probably to be found. Clarendon (*History of the Great Rebellion*, 1647) states that the citizens of Birmingham rose against certain small parties of the king's supporters, and sent the prisoners they captured to Coventry, which was then strongly parliamentary.

See *Victoria County History, Warwick*; William Dugdale, *The Antiquities of Coventry, illustrated from records* (Coventry, 1765).

**COVER** (from the Fr. *couvert*, from *couvrir*, to cover, Lat. *coopervire*), that which hides, shuts in or conceals, a lid to a

box or vessel, &c., the binding of a book or wrapper of a parcel; as a hunting term, the wood or undergrowth which shelters game. As a commercial term, the word means in its widest sense a security against loss, but is employed more particularly in connexion with stock exchange transactions to signify a "deposit made with a broker to secure him from being out of pocket in the event of the stocks falling against his client and the client not paying the difference" (*In re Cromwelle*, 1808, 2 Q. B. 383). It is a mode of speculation engaged in almost entirely by persons who wish to limit their risk to a small amount, and, as a rule, the transactions are largely carried out in England with "outside" brokers, *i.e.* those dealers in securities who are not members of the Stock Exchange. The deposit is so much per cent or per share, usually 1% on the market value of the securities up to about twice the amount of the turn of the market; the client being able to close the transaction at any time during the currency of the cover, but the broker only when the cover is exhausted or has "run off." Cover is not money deposited to abide the event of a wager, but as security against a debt which may arise from a gaming contract, and it may be recovered back, if unappropriated.

**COVERDALE, MILES** (1488?-1569), English translator of the Bible and bishop of Exeter, was born of Yorkshire parents about 1488, studied philosophy and theology at Cambridge, was ordained priest at Norwich in 1514, and then entered the convent of Austin friars at Cambridge. Here he came under the influence of the prior, Robert Barnes, made the acquaintance of Sir Thomas More and of Thomas Cromwell, and began a thorough study of the Scriptures. He was one of those who met at the White Horse tavern to discuss theological questions, and when Barnes was arrested on a charge of heresy, Coverdale went up to London to assist him in drawing up his defence. Soon afterwards he left the convent, assumed the habit of a secular priest, and began to preach against confession and the worship of images. In 1531 he graduated bachelor of canon law at Cambridge, but from 1528 to 1534 he prudently spent most of his time abroad. No corroboration has, however, been found for Foxe's statement that in 1529 he was at Hamburg assisting Tyndale in his translation of the Pentateuch. In 1534 he published two translations of his own, the first Dulichius's *Vom alten und neuen Gott*, and the second a *Paraphrase upon the Psalms*, and in 1535 he completed his translation of the Bible. The venture seems to have been projected by Jacob van Meteren, who apparently employed Coverdale to do the translation, and Froschover of Zürich to do the printing. No perfect copy is known to exist, and the five or six which alone have title-pages give no name of publisher or place of publication. The volume is dedicated to the king of England, where Convocation at Cranmer's instance had, in December 1534, petitioned for an authorized English version of the Scriptures. As a work of scholarship it does not rank particularly high. Some of the title-pages state that it had been translated out of "Douche" (*i.e.* German) "and Latyn"; and Coverdale mentions that he used five interpreters, which are supposed to have been the Vulgate, the Latin version of Pagninus, Luther's translation, the Zürich version, and Tyndale's Pentateuch and New Testament. There is no definite mention of the original Greek and Hebrew texts; but it has considerable literary merit, many of Coverdale's phrases are retained in the authorized version, and it was the first complete Bible to be printed in English. Two fresh editions were issued in 1537, but none of them received official sanction. Coverdale was, however, employed by Cromwell to assist in the production of the Great Bible of 1539, which was ordered to be placed in all English churches. The work was done at Paris until the French government stopped it, when Coverdale and his colleagues returned to England early in 1539 to complete it. He was also employed in the same year in assisting at the suppression of superstitious usages, but the reaction of 1540 drove him once more abroad. His Bible was prohibited by proclamation in 1542, while Coverdale himself defied the Six Articles by marrying Elizabeth Macheson, sister-in-law to Dr John MacAlpine.

For a time Coverdale lived at Tübingen, where he was created

D.D. In 1545 he was pastor and schoolmaster at Bergzabern in the duchy of Pfalz-Zweibrücken. In March 1548 he was at Frankfurt, when the new English Order of Communion reached him; he at once translated it into German and Latin and sent a copy to Calvin, whose wife had befriended Coverdale at Strassburg. Calvin, however, does not seem to have approved of it so highly as Coverdale.

Coverdale was already on his way back to England, and in October 1548 he was staying at Windsor Castle, where Cranmer and some other divines, inaccurately called the Windsor Commission, were preparing the First Book of Common Prayer. His first appointment had been as almoner to Queen Catherine Parr, then wife of Lord Seymour; and he preached her funeral sermon in September 1548. He was also chaplain to the young king and took an active part in the reforming measures of his reign. He was one of the most effective preachers of the time. A sermon by him at St Paul's on the second Sunday in Lent, 1549, was immediately followed by the pulling down of "the sacrament at the high altar." A few weeks later he preached at the penance of some Anabaptists, and in January 1550 he was put on a commission to prosecute Anabaptists and all who infringed the Book of Common Prayer. In 1549 he wrote a dedication to Edward for a translation of the second volume of Erasmus's *Paraphrases*; and in 1550 he translated Otto Wermueller's *Precious Pearl*, for which Protector Somerset, who had derived spiritual comfort from the book while in the Tower, wrote a preface. He was much in request at funerals: he preached at Sir James Wilford's in November 1550, and at Lord Wentworth's before a great concourse in Westminster Abbey in March 1551.

Perhaps it was his gift of oratory which suggested his appointment as bishop of the refractory men of Devon and Cornwall. He had already, in August 1549, at some risk, gone down with Lord Russell to turn the hearts of the rebels by preaching and persuasion, and two years later he was appointed bishop of Exeter by letters patent, on the compulsory retirement of his predecessor, Veysey, who had reached an almost mythical age. He was an active prelate, and perhaps the vigorous Protestantism of the West in Elizabeth's reign was partly due to his persuasive powers. He sat on the commission for the reform of the canon law, and was in constant attendance during the parliaments of 1552 and 1553. On Mary's accession he was at once deprived on the score of his marriage, and Veysey in spite of his age was restored. Coverdale was called before the privy council on the 1st of September, and required to find sureties; but he was not further molested, and when Christian III. of Denmark at the instance of Coverdale's brother-in-law, MacAlpine, interceded in his favour, he was in February 1555 permitted to leave for Denmark with two servants, and his baggage unsearched; one of these "servants" is said to have been his wife. He declined Christian's offer of a living in Denmark, and preferred to preach at Wesel to the numerous English refugees there, until he was invited by Duke Wolfgang to resume his labours at Bergzabern. He was at Geneva in December 1558, and is said to have participated in the preparation of the Geneva version of the Bible.

In 1559 Coverdale returned to England and resumed his preaching at St Paul's and elsewhere. Clothed in a plain black gown, he assisted at Parker's consecration, in spite of the facts that he had himself been deprived, and did not resume his bishopric, and that his original appointment had been by the uncanonical method of letters patent. Conscientious objections were probably responsible for his non-restoration to the see of Exeter, and his refusal of that of Llandaff in 1563. He objected to vestments, and in his living of St Magnus close to London Bridge, which he received in 1563, he took other liberties with the Act of Uniformity. His bishop, Grindal, was his friend, and his vagaries were overlooked until 1566, when he resigned his living rather than conform. He still preached occasionally, and always drew large audiences. He died in February 1568, and was buried on the 19th in St Bartholomew's behind the Exchange. When this church was pulled down in 1840 to make room for the new Exchange, his remains were removed to St Magnus.

Coverdale's works, most of them translations, number twenty-six in all; nearly all, with his letters, were published in a collected edition by the Parker Soc., 2 vols., 1846. An excellent account is given in the *Dict. Nat. Biog.* of his life, with authorities, to which may be added R. W. Dixon's *Church History*, Bishop and Gasquet's *Edward VI. and the Book of Common Prayer*; Acts of the Privy Council; Letters and Papers of Henry VIII.; *Lit. Rem. of Edward VI.* (Roxburghe Club); Whittingham's *Brief Discourse of Troubles at Frankfurt*; Pocock's *Troubles connected with the Prayer-Book* (Camden Soc.). (A. F. P.)

**COVERTURE** (a covering, an old French form of the modern *couverture*), a term in English law applied to the condition of a woman during marriage, when she is supposed to be under the cover, influence and protection of her husband, and so immune in certain cases from punishment for crime committed in the presence and on the presumed coercion of her husband. (See further HUSBAND AND WIFE.)

**COVILHÃ**, a town of Portugal, in the district of Castello Branco, formerly included in the province of Beira; on the eastern slope of the Serra da Estrela, and on the Abrantes-Guarda railway. Pop. (1900) 15,469. Covilhã, which has been often compared with a collection of swallows' nests clinging to the rugged granitic mountain side, is shaped like an amphitheatre of closely crowded houses, overlooking the river Zezere and its wild valley from a height of 2180 ft. Over 4000 operatives are employed in the manufacture of *saragoça*, a coarse brown cloth worn by the peasantry throughout Portugal. The village of Unhaes da Serra (1507), 6 m. W.S.W., is noted for its sulphurous springs and baths.

**COVILHAM** (COVILHÃO, COVILHÃ), **PERO** or **PEDRO DE**, Portuguese explorer and diplomatist (fl. 1487-1525), was a native of Covilhã in Beira. In early life he had gone to Castile and entered the service of Alphonso, duke of Seville; later, when war broke out between Castile and Portugal, he returned to his own country, and attached himself, first as a "groom," then as a "squire," to King Alphonso V. and his successor John II. On the 7th of May 1487, he was despatched, in company with Alphonso de Payva, on a mission of exploration in the Levant and adjoining regions of Asia and Africa, with the special object of learning where "cinnamon and other spices could be found," as well as of discovering the land of Prester John, by "overland" routes. Bartholomeu Diaz, at this very time, went out to find the Prester's country, as well as the termination of the African continent and the ocean route to India, by sea. Covilham and Payva were provided with a "letter of credence for all the countries of the world" and with a "map for navigating, taken from the map of the world" and compiled by Bishop Calcadilha, and doctors Rodrigo and Moyses. The first two of these were prominent members of the commission which advised the Portuguese government to reject the proposals of Columbus. The explorers started from Santarem and travelled by Barcelona to Naples, where their bills of exchange were paid by the sons of Cosimo de' Medici; thence they passed to Rhodes, where they lodged with two other Portuguese, and so to Alexandria and Cairo, where they posed as merchants. In company with certain Moors from Fez and Tlemçen they now went by way of Tor to Suakin and Aden, where (as it was now monsoon time) they parted, Covilham proceeding to India and Payva to Ethiopia—the two companions agreeing to meet again in Cairo. Covilham thus arrived at Cannanore and Calicut, whence he retraced his course to Goa and Ormuz, the Red Sea and Cairo, making an excursion on his way down the East African coast to Sofala, which he was probably the first European to visit. At Cairo he heard of Payva's death, and met with two Portuguese Jews—Rabbi Abraham of Beja, and Joseph, a shoe-maker of Lamego—who had been sent by King John with letters for Covilham and Payva. By Joseph of Lamego Covilham replied with an account of his Indian and African journeys, and of his observations on the cinnamon, pepper and clove trade at Calicut, together with advice as to the ocean way to India. This he truly represented as quite practicable: "to this they (of Portugal) could navigate by their coast and the seas of Guinea." The first objective in the eastern ocean, he added, was Sofala or the

Island of the Moon, our Madagascar—"from each of these lands one can fetch the coast of Calicut." With this information Joseph returned to Portugal, while Covilham, with Abraham Beja, again visited Aden and Ormuz. At the latter he left the rabbi; and himself came back to Jidda, the port of the Arabian holy land, and penetrated (as he told Alvarez many years later) even to Mecca and Medina. Finally, by Mount Sinai, Tor and the Red Sea, he reached Zeila, whence he struck inland to the court of Prester John (*i.e.* Abyssinia). Here he was honourably received; lands and lordships were bestowed upon him; but he was not permitted to leave. When the Portuguese embassy under Rodrigo de Lima, including Father Francisco Alvarez, entered Abyssinia in 1520, Covilham wept with joy at the sight of his fellow-countrymen. It was then forty years since he had left Portugal, and over thirty since he had been a prisoner of state in "Ethiopia." Alvarez, who professed to know him well, and to have heard the story of his life, both "in confession and out of it," praises his power of vivid description "as if things were present before him," and his extraordinary knowledge of "all spoken languages of Christians, Moors and Gentiles." His services as an interpreter were valuable to Rodrigo de Lima's embassy; but he never succeeded in escaping from Abyssinia.

See Francisco Alvarez, *Verdadera Informaçam das terras do Preste Joam*, esp. chs. 73, 89, 98, 102-103, 105 (pp. 177, 224, 254, 264, 265-270, 275, of the Hakluyt Society's English edition, *The Portuguese Embassy to Abyssinia . . . 1520-1727*, London, 1881); an abstract of this, with some inaccuracies, is given in Major's *Prince Henry the Navigator* (London, 1868), pp. 339-340.

**COVIN** (from the Fr. *covine*, or *covine*, from Lat. *convenire*, to come together), an association of persons, so used in the Statute of Labourers of 1360, which, *inter alia*, declared void "all alliances and covins of masons and carpenters." The more common use of the term in English law was for a secret agreement between persons to cheat and defraud, but the word is now obsolete, and has been superseded by "collusion" or "conspiracy to cheat and defraud."

**COVINGTON**, a city and one of the two county-seats of Kenton county, Kentucky, U.S.A., on the Ohio river opposite Cincinnati, with which it is connected by bridges; and at the mouth of the Licking river (also spanned by bridges), opposite Newport, Ky. Pop. (1890) 37,371; (1900) 42,938, of whom 5223 were foreign-born and 2478 were negroes; (1910) 53,270. In 1900 it ranked second in population among the cities of Kentucky. The city is served by the Chesapeake & Ohio, and the Louisville & Nashville railways, by interurban electric railways, and by steamboat lines to the Ohio river ports. It is built on a plain commanding good views and partly shut in by neighbouring hills. Its streets, mostly named from eminent Kentuckians, are paved chiefly with asphalt, macadam and brick. There are numerous fine residences and several attractive public buildings, including that of the United States government—modern Gothic in style—the court-house and city hall combined, and the public library. Covington is the seat of a Roman Catholic bishopric, and its cathedral, in the flamboyant Gothic style, is one of the finest church buildings in the state. In the city are the Academy of Notre Dame and St Joseph's high school for boys, both Roman Catholic. The principal charitable institutions are the hospital of Saint Elizabeth, a German orphan asylum, a Protestant children's home, a home for aged women and a Wayfarers' Rest. Covington is the trade centre of an extensive district engaged in agriculture and stock raising, and as a manufacturing centre it ranked second in the state in 1905 (value of factory products \$6,099,715), its products including tobacco, cotton goods, structural iron and steel, foundry and machine shop products, liquors and cordage. A settlement was established here in 1812, and three years later a town was laid out and named in honour of Gen. Leonard Covington (1768-1813), who was mortally wounded at Chrystler's Field during the War of 1812. In 1834 Covington was chartered as a city; and in 1908 it annexed Central Covington (pop. in 1900, 2155).

**COWARD**, a term of contempt for one who, before danger, pain or trouble, shows fear, whether physical or moral. The derivation of the word has been obscured by a connexion in sense

with the verb "cow," to instil fear into, which is derived from old Norse *kuga*, a word of similar meaning, and with the verb "cower," to crouch, which is also Scandinavian in origin.<sup>1</sup> The true derivation is from the French *coe*, an old form of *quene*, a tail, from Lat. *cauda*, hence *cowart* or *coward*. The reference to "tail" is either to the expression "turn tail" in flight, or to the habit of animals dropping the tail between the legs when frightened; in heraldry, a lion in this position is a "lion coward." In the fable of *Reynard the Fox* the name of the hare is Coart, Kywart, Cuwaert or other variants.

**COWBRIDGE**, a market town and a municipal and contributory parliamentary borough of Glamorganshire, Wales, with a station on the Taff Vale railway branch from Llantrisant to Aberthaw on the coast, distant by rail 162½ m. from London, 12 m. W. of Cardiff, 7 m. S.E. of Bridgend, and 6 m. S. of Llantrisant station. The population in 1901 was 1202, a decrease of over 12% since 1891. Less than one-third of the number was Welsh-speaking. The town mainly consists of one long street running east and west, and is in a wide valley through which runs the river Thaw (Welsh, *Ddawan*), here crossed by a stone bridge.

Cowbridge is probably situated on the Roman road from Cardiff westwards, which seems to have kept nearly the course of the present main road. Roman coins have been discovered here. It has in fact been suggested, mainly on etymological grounds, that the town occupies the site of the Roman *Bovium*: the modern Welsh name, *y Bontfaen* ("stone bridge") is probably a corruption of the medieval, *Pont y fôn*, the precise equivalent of "Cowbridge," which is first found in documents of the second half of the 13th century as *Covbruge* and *Cubrigg*. Others place *Bovium* on a vicinal road, at *Boverton* near *Llantwit Major*, about 6 m. to the south near the coast, though the most likely site is near *Ewenny*, 5 m. to the west of Cowbridge. After the Norman conquest of Glamorgan, the town grew up as an appanage of the castle of *St Quentin*, which occupies a commanding position half a mile south-west of the town. It was walled round before the 13th century. A tower is mentioned in 1487 when it was granted away by the burgesses. *Leland* in his itinerary (*c.* 1535) describes the town wall as three-quarters of a mile round and as having three gates. There was even then a considerable suburb on the west bank of the river and outside the walls. The south wall and gateway are still standing.

The town was a borough by prescription until 1682, when it received a charter of incorporation from Charles II. confirming its previous privileges. Under the Unreformed Corporations Act of 1883 the corporation was dissolved, but on the petition of the inhabitants a new charter was granted in March 1887. During the Tudor and Stuart periods Cowbridge was almost if not quite the chief town of Glamorgan, its importance being largely due to its central and accessible position in a rich agricultural district where a large number of the county gentry lived. The great sessions were held here alternately with Cardiff and Swansea from 1542 till their abolition in 1830, and the quarter sessions were held here once a year down to 1850. From 1536 to 1832 it was one of the eight contributory boroughs within the county which returned a member to parliament, but since 1832 it has been contributory with Cardiff and Llantrisant in returning a member. It has a separate commission of the peace. Sir Edward Stradling (1529-1609) established a grammar school here, but died before endowing it; it was refounded in 1685 by Sir Leoline Jenkins, who provided that it should be administered by Jesus College, Oxford, which body erected the present buildings in 1847. It has throughout its existence been one of the leading schools in Wales. An intermediate school for girls was established here by the county in 1806. The church of *St Mary* (formerly chapelry to *Llanblethian*) is of early English style and has a fine embattled tower, of the same military

<sup>1</sup> A connexion has also been imagined with *cow* (O. Eng. *cu*; common in Scandinavian languages, and of similar root to Skr. *go*, whence also Gr. *βός*, Lat. *bos*), the female bovine animal, on account of its timidity.

type as the towers of Llanblethian and Ewenny. There are three Nonconformist chapels. There are a town hall and market place. The town is now wholly dependent on agriculture; and has good markets and cattle fairs, that on the 4th of May being a charter fair.

**COWDENBEATH**, a police burgh, Fifeshire, Scotland, 5½ m. N.E. of Dunfermline by the North British railway. Pop. (1891) 4249; (1901) 7908. The principal industry is coal-mining, and the public buildings include churches, schools and a hall. Meetings in connexion with the adoption and promulgation of the Covenant were held in the old parish church of Beath.

**COWELL, JOHN** (1554-1611), English jurist, was born at Ernsborough, Devonshire. He was educated at Eton, and King's College, Cambridge, ultimately becoming professor of civil law in that university, and master of Trinity Hall. In 1607 he compiled a law dictionary, *The Interpreter*, in which he exalted the king's prerogative so much that he was prosecuted before the House of Commons by Sir Edward Coke, and saved from imprisonment only by the interposition of James I. His book was burnt by order of the House of Commons. Dr Cowell also wrote a work entitled *Institutiones Juris Anglicani*. He died at Oxford on the 11th of October 1611.

**COWEN, FREDERIC HYMEN** (1852- ), English musical composer, was born at Kingston, Jamaica, on the 29th of January 1852. At four years old he was brought to England, where his father became treasurer to the opera at Her Majesty's theatre, and private secretary to the earl of Dudley. His first teacher was Henry Russell, and his first published composition appeared when he was but six years old. He studied the piano with Benedict, and composition with Goss; in 1865 he was at Leipzig under Hauptmann, Moscheles, Reinecke and Plaidy. Returning home on the outbreak of the Austro-Prussian War, he appeared as a composer for the orchestra in an overture played at the Promenade Concerts at Covent Garden in September 1866. In the following autumn he went to Berlin, where he was under Kiel, at Stern's conservatorium. A symphony and a piano concerto were given in St James's Hall in 1869, and from that time Cowen has been recognized as primarily a composer, his talents as a pianist being subordinate, although his public appearances were numerous for some time afterwards. His cantata, *The Rose Maiden*, was given in London in 1870, his second symphony by the Liverpool Philharmonic Society in 1872, and his first festival work, *The Corsair*, in 1876 at Birmingham. In that year his opera, *Pauline*, was given by the Carl Rosa Company with moderate success. In 1884 he conducted five concerts of the Philharmonic Society, and in 1888, on the resignation of Arthur Sullivan, became the regular conductor of the society, resigning the post in 1892. In the year of his appointment, 1888, he went to Melbourne as the conductor of the daily concerts given in connexion with the Exhibition there. In 1896 Cowen was appointed conductor of the Liverpool Philharmonic Society and of the Manchester orchestra, in succession to Sir Charles Hallé. In 1899 he was reappointed conductor of the Philharmonic Society. His works include:—Operettas: *Garibaldi* (1860) and *One Too Many* (1874); operas: *Pauline* (1876), *Thotgrim* (1890), *Signa* (Milan, 1893), and *Harold* (1895); oratorios: *The Deluge* (1878), *St Ursula* (1881), *Ruth* (1887), *Song of Thanksgiving* (1888), *The Transfiguration* (1895); cantatas: *The Rose Maiden* (1870), *The Corsair* (1876), *The Sleeping Beauty* (1885), *St John's Eve* (1889), *The Water Lily* (1893), *Ode to the Passions* (1898), besides short cantatas for female voices; a large number of songs, ranging from the popular "ballad" to more artistic lyrics, anthems, part-songs, duets, &c.; six symphonies, among which No 3, the "Scandinavian," has had the greatest success; four overtures; suites, *The Language of Flowers* (1880), *In the Olden Times* (1883), *In Fairyland* (1896); four English dances (1896); a concerto for piano and orchestra, and a fantasia for the same played by M. Paderewski (1900); a quartet in C minor, and a trio in A minor, both early works; pianoforte pieces, &c. Cowen is never so happy as when treating of fantastic or fairy subjects; and whether in his cantatas for female voices, his charming *Sleeping*

*Beauty*, his *Water Lily* or his pretty overture, *The Butterfly's Ball* (1901), he succeeds wonderfully in finding graceful expression for the poetical idea. His dance music, such as is to be found in various orchestral suites, is refined, original and admirably instrumented; and if he is seldom as successful in portraying the graver aspects of emotion, the vogue of his semi-sacred songs has been widespread.

**COWEN, JOSEPH** (1831-1900), English politician and journalist, son of Sir Joseph Cowen, a prominent citizen and mine-owner of Newcastle-on-Tyne, was born in 1831, and was educated at Edinburgh University. In 1874 he was elected member of parliament for the borough on the death of his father, who had held the seat as a Liberal since 1865. Joseph Cowen was at that time a strong Radical on domestic questions, an advocate of co-operation, an admirer of Garibaldi, Mazzini and Kossuth, a sympathizer with Irish Nationalism, and one who in speech, dress and manner identified himself with the North-country mining class. Short in stature and uncouth in appearance, his individuality first shocked and then by its earnestness impressed the House of Commons; and his sturdy independence of party ties, combined with a gift of rough but genuine eloquence (of which his speech on the Royal Title Bill of 1876 was an example); rapidly made him one of the best-known public men in the country. He was, moreover, an Imperialist and a Colonial Federationist at a time when Liberalism was tied and bound to the Manchester traditions; and, to the consternation of the official wire-pullers, he vigorously supported Disraeli's foreign policy, and in 1881 opposed the Gladstonian settlement with the Boers. His independence (which his detractors attributed in some degree to his alleged susceptibility to Tory compliments) brought him into collision both with the Liberal caucus and with the party organization in Newcastle itself, but Cowen's personal popularity and his remarkable powers as an orator triumphed in his own birthplace, and he was again elected in 1885 in spite of Liberal opposition. Shortly afterwards, however, he retired both from parliament and from public life, professing his disgust at the party intrigues of politics, and devoted himself to conducting his newspaper, the *Newcastle Daily Chronicle*; and to his private business as a mine-owner. In this capacity he exercised a wide influence on local opinion, and the revolt of the Newcastle electorate in later years against doctrinaire Radicalism was largely due to his constant preaching of a broader outlook on national affairs. He continued behind the scenes to play a powerful part in forming North-country opinion until his death on the 18th of February 1900.

His letters were published by his daughter in 1909.

**COWES**, a seaport and watering-place in the Isle of Wight, England, 12 m. S.S.E. of Southampton. West Cowes is separated from East Cowes by the picturesque estuary of the river Medina, the two towns (each of which is an urban district) lying on opposite sides of its mouth at the apex of the northern coast of the island. Pop. (1901) West Cowes, 8652; East Cowes, 3196. The port between them is the chief on the island, and is the headquarters of the Royal Yacht Squadron (founded in 1812); it is in regular steamship communication with Southampton and Portsmouth. West Cowes is served by the Isle of Wight Central railway. A steam ferry and a floating bridge across the Medina, here 600 yds. broad, unite the towns. Behind the harbour the houses rise picturesquely on gentle wooded slopes, and numerous villas adorn the vicinity. The towns owe their origin to two forts or castles, built on each side of the mouth of the Medina by Henry VIII. in 1540, for the defence of the coast; the eastern one has disappeared, but the west castle remains and is used as the club-house of the Yacht Squadron. The marine parade of West Cowes, and the public promenade called the Green, are close to the castle. The industrial population is chiefly employed in the shipbuilding yards, in the manufacture of ships' fittings, and in engineering works. The harbour is under an elective body of commissioners. On the opposite side of the Medina a broad carriageway leads to East Cowes Castle, a handsome edifice built by John Nash, the favourite architect of George IV., in 1798, and immediately beyond it are the grounds surrounding

Osborne House (see OSBORNE), built in 1845 after the property had been purchased by Queen Victoria, the church of St Mildred, Whippingham, lying a mile to the south.

**COWL** (through Fr. *coule*, from Lat. *cucullus* or *cuculla*, a covering; the word is found in various forms in most European languages, cf. Ger. *Kugel* or *Kigel*, Dutch *kovel*, Irish *cochal* or *cochull*; the ultimate origin may be the root *kal*, found in Lat. *clam*, secretly, and Gr. *καλύπτειν*, to hide, cover up), an outer garment worn by both sexes in the middle ages; a part of the monastic dress, hence the phrase "to take the cowl," signifying entry upon the religious life. The *cucullus* worn by the early Egyptian anchorites was a hood covering the head and neck. Later generations lengthened the garment until it reached to the heels, and St Benedict issued a rule restricting its length to two cubits. Chapter 55 of his *Institute* prescribes the following dress in temperate climates: a cowl and tunic, thick in winter and thin in summer, with a scapular for working hours and shoes and stockings, all of simple material and make. In the 14th century the cowl and the frock were frequently confounded, but the council of Vienne defined the former as "a habit long and full without sleeves," and the latter as "a long habit with long and wide sleeves." While the term thus seems strictly to imply a hooded gown it is often applied to the hood alone. It is also used to describe a loose vestment worn over the frock in the winter season and during the night office.

The word "cowl" is also applied to a hood-shaped covering to a chimney or ventilating shaft, to help down-draught, and to clear the up-current of foul air (see VENTILATION).

**COWLEY, ABRAHAM** (1618-1667), English poet, was born in the city of London late in 1618. His father, a wealthy citizen, who died shortly before his birth, was a stationer. His mother was wholly given to works of devotion, but it happened that there lay in her parlour a copy of *The Faery Queen*. This became the favourite reading of her son, and he had twice devoured it all before he was sent to school. As early as 1628, that is, in his tenth year, he composed his *Tragicall History of Píramus and Thisbe*, an epical romance written in a six-line stanza, of his own invention. It is not too much to say that this work is the most astonishing feat of imaginative precocity on record; it is marked by no great faults of immaturity, and possesses constructive merits of a very high order. Two years later the child wrote another and still more ambitious poem, *Constantia and Philetus*, being sent about the same time to Westminster school. Here he displayed the most extraordinary mental precocity and versatility, and wrote in his thirteenth year yet another poem; the *Elegy on the Death of Dudley, Lord Carlton*. These three poems of considerable size, and some smaller ones, were collected in 1633, and published in a volume entitled *Poetical Blossoms*, dedicated to the head-master of the school, and prefaced by many laudatory verses by schoolfellows. The author at once became famous, although he had not, even yet, completed his fifteenth year. His next composition was a pastoral comedy, entitled *Love's Riddle*, a marvellous production for a boy of sixteen, airy, correct and harmonious in language, and rapid in movement. The style is not without resemblance to that of Randolph, whose earliest works, however, were at that time only just printed. In 1637 Cowley was elected into Trinity College, Cambridge, where he betook himself with enthusiasm to the study of all kinds of learning, and early distinguished himself as a ripe scholar. It was about this time that he composed his scriptural epic on the history of King David, one book of which still exists in the Latin original, the rest being superseded in favour of an English version in four books, called the *Dauidis*, which he published a long time after. This his most grave and important work is remarkable as having suggested to Milton several points which he afterwards made use of. The epic, written in a very dreary and turgid manner, but in good rhymed heroic verse, deals with the adventures of King David from his boyhood to the smiting of Amalek by Saul, where it abruptly closes. In 1638 *Love's Riddle* and a Latin comedy, the *Naufragium Jocularé*, were printed, and in 1641 the passage of Prince Charles through Cambridge gave occasion to the production of

another dramatic work, *The Guardian*, which was acted before the royal visitor with much success. During the civil war this play was privately performed at Dublin, but it was not printed till 1650. It is bright and amusing, in the style common to the "sons" of Ben Jonson, the university wits who wrote more for the closet than the public stage.

The learned quiet of the young poet's life was broken up by the Civil War; he warmly espoused the royalist side. He became a fellow of Trinity College, Cambridge, but was ejected by the Parliamentarians in 1643. He made his way to Oxford, where he enjoyed the friendship of Lord Falkland, and was tossed, in the tumult of affairs, into the personal confidence of the royal family itself. After the battle of Marston Moor he followed the queen to Paris, and the exile so commenced lasted twelve years. This period was spent almost entirely in the royal service, "bearing a share in the distresses of the royal family, or labouring in their affairs. To this purpose he performed several dangerous journeys into Jersey, Scotland, Flanders, Holland, or wherever else the king's troubles required his attendance. But the chief testimony of his fidelity was the laborious service he underwent in maintaining the constant correspondence between the late king and the queen his wife. In that weighty trust he behaved himself with indefatigable integrity and unsuspected secrecy; for he ciphered and deciphered with his own hand the greatest part of all the letters that passed between their majesties, and managed a vast intelligence in many other parts, which for some years together took up all his days, and two or three nights every week." In spite of these labours he did not refrain from literary industry. During his exile he met with the works of Pindar, and determined to reproduce their lofty lyric passion in English. At the same time he occupied himself in writing a history of the Civil War, which he completed as far as the battle of Newbury, but unfortunately afterwards destroyed. In 1647 a collection of his love verses, entitled *The Mistress*, was published, and in the next year a volume of wretched satires, *The Four Ages of England*, was brought out under his name, with the composition of which he had nothing to do. In spite of the troubles of the times, so fatal to poetic fame, his reputation steadily increased, and when, on his return to England in 1656, he published a volume of his collected poetical works, he found himself without a rival in public esteem. This volume included the later works already mentioned, the *Pindarique Odes*, the *Dauidis*, the *Mistress* and some *Miscellanies*. Among the latter are to be found Cowley's most vital pieces. This section of his works opens with the famous aspiration—

"What shall I do to be for ever known,  
And make the coming age my own?"

It contains elegies on Wotton, Vandyck, Falkland, William Hervey and Crashaw, the last two being among Cowley's finest poems, brilliant, sonorous and original; the amusing ballad of *The Chronicle*, giving a fictitious catalogue of his supposed amours; various gnomic pieces; and some charming paraphrases from Anacreon. The *Pindarique Odes* contain weighty lines and passages, buried in irregular and inharmonious masses of moral verbiage. Not more than one or two are good throughout, but a full posy of beauties may easily be culled from them. The long cadences of the Alexandrines with which most of the strophes close, continued to echo in English poetry from Dryden down to Gray, but the *Odes* themselves, which were found to be obscure by the poet's contemporaries, immediately fell into disesteem. *The Mistress* was the most popular poetic reading of the age, and is now the least read of all Cowley's works. It was the last and most violent expression of the amatory affectation of the 17th century, an affectation which had been endurable in Donne and other early writers because it had been the vehicle of sincere emotion, but was unendurable in Cowley because in him it represented nothing but a perfunctory exercise, a mere exhibition of literary calisthenics. He appears to have been of a cold, or at least of a timid, disposition; in the face of these elaborately erotic volumes, we are told that to the end of his days he never summoned up courage to speak of love to a single woman in real life. The "Leonora" of *The Chronicle* is said to have been the



only woman he ever loved, and she married the brother of his biographer, Sprat.

Soon after his return to England he was seized in mistake for another person, and only obtained his liberty on a bail of £1000. In 1658 he revised and altered his play of *The Guardian*, and prepared it for the press under the title of *The Cutter of Coleman Street*, but it did not appear until 1663. Late in 1658 Oliver Cromwell died, and Cowley took advantage of the confusion of affairs to escape to Paris, where he remained until the Restoration brought him back in Charles's train. He published in 1663 *Verses upon several occasions*, in which *The Complaint* is included.

Wearied with the broils and fatigues of a political life, Cowley obtained permission to retire into the country; through his friend, Lord St Albans, he obtained a property near Chertsey, and here, devoting himself to the study of botany, and buried in his books, he lived in comparative solitude until his death. He took a great and practical interest in experimental science, and he was one of those who were most prominent in advocating the foundation of an academy for the protection of scientific enterprise. Cowley's pamphlet on *The Advancement of Experimental Philosophy*, 1661, led directly to the foundation of the Royal Society, to which body Cowley, in March 1667, at the suggestion of Evelyn, addressed an ode which is the latest and one of the strongest of his poems. He died in the Porch House, in Chertsey, on the 28th of July 1667, in consequence of having caught a cold while superintending his farm-labourers in the meadows late on a summer evening. On the 3rd of August Cowley was buried in Westminster Abbey beside the ashes of Chaucer and Spenser, where in 1675 the duke of Buckingham erected a monument to his memory. His *Poëmata Latina*, including six books "Plantarum," were printed in 1668.

Throughout their parallel lives the fame of Cowley completely eclipsed that of Milton, but posterity instantly and finally reversed the judgment of their contemporaries. The poetry of Cowley rapidly fell into a neglect as unjust as the earlier popularity had been. As a prose writer, especially as an essayist, he holds, and will not lose, a high position in literature; as a poet it is hardly possible that he can enjoy more than a very partial revival. The want of nature, the obvious and awkward art, the defective melody of his poems, destroy the interest that their ingenuity and occasional majesty would otherwise excite. He had lofty views of the mission of a poet and an insatiable ambition, but his chief claim to poetic life is the dowry of sonorous lyric style which he passed down to Dryden and his successors of the 18th century.

The works of Cowley were collected in 1668, when Thomas Sprat, afterwards bishop of Rochester, brought out a splendid edition in folio, to which he prefixed a graceful and elegant life of the poet. There were many reprints of this collection, which formed the standard edition till 1881, when it was superseded by A. B. Grosart's privately printed edition in two volumes, for the Chertsey Worthies library. The Essays have frequently been revived with approval. (E. G.)

**COWLEY, HANNAH** (1743-1809), English dramatist and poet, daughter of Philip Parkhouse, a bookseller at Tiverton, Devonshire, was born in 1743. When about twenty-five years old she married Mr Cowley, of the East India Company's service, who died in 1797. Some years after her marriage, being at the theatre with her husband, she expressed the opinion that she could write as good a piece as the one being performed, and within a fortnight she had written her first play, *The Runaway*. She sent it to Garrick, who produced it at Drury Lane in 1776. Between then and 1795 she wrote twelve more plays, all of which (with one exception) were produced at Drury Lane or Covent Garden; and *The Belle's Stratagem* (1782), with one or two others, still survives in the list of acting plays. Among other pieces were *Albina*, *Countess Raimond*, *A Bold Stroke for a Husband*, *More Ways than One*, and *A School for Greybeards, or The Mourning Bride*. Mrs Cowley was the author of a number of indifferent poems, mainly historical, and under the name of "Anna Matilda," which has since become proverbial, she carried on a sentimental correspondence in the *World* with Robert Merry. She died at Tiverton on the 11th of March 1809.

**COWLEY, HENRY RICHARD CHARLES WELLESLEY, 1ST EARL** (1804-1884), British diplomatist, was the eldest son of Henry Wellesley, 1st Baron Cowley (1773-1847), and Charlotte, daughter of Charles, 1st Earl Cadogan, and was consequently a nephew of the duke of Wellington and of the marquess Wellesley. Born on the 17th of June 1804, he entered the diplomatic service in 1824, receiving his first important appointment in 1848, when he became minister plenipotentiary to the Swiss cantons; and in the same year he was sent to Frankfort to watch the proceedings of the German parliament. This was followed by his appointment as envoy extraordinary to the new Germanic confederation, a position which he only held for a short time, as he was chosen in 1852 to succeed the 1st marquess of Normanby as the British ambassador in Paris. Baron Cowley, as Wellesley had been since his father's death in 1847, held this important post for fifteen years, and the story of his diplomatic life in Paris cannot be separated from the general history of England and France. As minister during the greater part of the reign of Napoleon III., he conducted the delicate negotiations between the two countries during the time of those eastern complications which preceded and followed the Crimean War, and also during the excitement and unrest produced by the attempt made in 1858 by Felice Orsini to assassinate the emperor of the French; while his diplomatic skill was no less in evidence during the war between France and Austria and the subsequent course of events in Italy. In 1857 he had been created Earl Cowley and Viscount Dangan; in 1866 he was made a knight of the Garter; and having assisted Richard Cobden to conclude the commercial treaty between Great Britain and France in 1860, he retired in 1867 from a position which he had filled with distinction to himself and with benefit to his country. In 1863 Cowley had inherited the estate of Draycot in Wiltshire from his kinsman the 5th earl of Mornington, and he lived in retirement until his death on the 15th of July 1884. He had married in 1833 Olivia Cecilia (d. 1885), daughter of Charlotte, baroness de Ros and Lord Henry Fitzgerald, by whom he had three sons and two daughters, and was succeeded in his titles by his eldest son, William Henry, 2nd Earl Cowley (1834-1895), father of Henry Arthur Mornington, 3rd earl (b. 1866).

**COWLEY FATHERS**, the name commonly given to the members of the Society of Mission Priests of St John the Evangelist, an Anglican religious community, the headquarters of which are in England, at Cowley St John, close to Oxford. The society was founded in 1865 by the Rev. R. M. Benson "for the cultivation of a life dedicated to God according to the principles of poverty, chastity and obedience." The society, which is occupied both with educational and missionary work, has a house in London and branch houses at Bombay and Poona in India, at Cape Town and at St Cuthbert's, Kaffraria, in South Africa; and at Boston in the United States of America. The costume of the Cowley Fathers consists of a black frock or cassock confined by a black cord and a long black cloak.

**COWPENS**, a town of Spartanburg county, South Carolina, U.S.A., in the N. part of the state. Pop. (1890) 349; (1900) 692. It is served by the Southern railway. In colonial days cattle were rounded up and branded here—whence the name. Seven miles N. of the town is the field of the battle of Cowpens, fought on the 17th of January 1781, during the War of American Independence, between the Americans under Gen. Daniel Morgan and the British under Gen. Banastre Tarleton, the British being defeated. A monument was erected on the battlefield in 1859, but was much defaced during the Civil War. The town of Cowpens was founded in 1876, and was incorporated in 1880.

**COWPER, WILLIAM COWPER, 1ST EARL** (c. 1665-1723), lord chancellor of England, was the son of Sir William Cowper, Bart., of Ratling Court, Kent, a Whig member of parliament of some mark in the two last Stuart reigns. Educated at St Albans school, Cowper was called to the bar in 1688; having promptly given his allegiance to the prince of Orange on his landing in England, he was made recorder of Colchester in 1694, and in 1695 entered parliament as member for Hertford. He

enjoyed a large practice at the bar, and had the reputation of being one of the most effective parliamentary orators of his generation. He lost his seat in parliament in 1702 owing to the unpopularity caused by the trial of his brother Spencer on a charge of murder. In 1705 he was appointed lord keeper of the great seal, and took his seat on the woolsack without a peerage. In the following year he conducted the negotiations between the English and Scottish commissioners for arranging the union with Scotland. In November of the same year (1706) he succeeded to his father's baronetcy; and on the 14th of December he was raised to the peerage as Baron Cowper of Wingham, Kent.

When the union with Scotland came into operation in May 1707 the queen in council named Cowper lord high chancellor of Great Britain, he being the first to hold this office. He presided at the trial of Dr Sacheverell in 1710, but resigned the seal when Harley and Bolingbroke took office in the same year. On the death of Queen Anne, George I. appointed Cowper one of the lords justices for governing the country during the king's absence, and a few weeks later he again became lord chancellor. A paper which he drew up for the guidance of the new king on constitutional matters, entitled *An Impartial History of Parties*, marks the advance of English opinion towards party government in the modern sense. It was published by Lord Campbell in his *Lives of the Lord Chancellors*. Cowper supported the impeachment of Lord Oxford for high treason in 1715, and in 1716 presided as lord high steward at the trials of the peers charged with complicity in the Jacobite rising, his sentences on whom have been censured as unnecessarily severe. He warmly supported the septennial bill in the same year. On the 18th of March 1718 he was created Viscount Fordwich and Earl Cowper, and a month later he resigned office on the plea of ill-health, but probably in reality because George I. accused him of espousing the prince of Wales's side in his quarrel with the king. Taking the lead against his former colleagues, Cowper opposed the proposal brought forward in 1719 to limit the number of peers, and also the bill of pains and penalties against Atterbury in 1723. In his last years he was accused, but probably without reason, of active sympathy with the Jacobites. He died at his residence, Colne Green, built by himself on the site of the present mansion of Panshanger on the 10th of October 1723.

Cowper was not a great lawyer, but Burnet says that "he managed the court of chancery with impartial justice and great despatch"; the most eminent of his contemporaries agreed in extolling his oratory and his virtues. He was twice married—first, about 1686, to Judith, daughter and heiress of Sir Robert Booth, a London merchant; and secondly, in 1706, to Mary, daughter of John Clavering, of Chopwell, Durham. Swift (*Examiner*, xvii., xxii.) alludes to an allegation that Cowper had been guilty of bigamy, a slander for which there appears to have been no solid foundation. His younger brother, Spencer Cowper (1669–1728), was tried for the murder of Sarah Stout in 1699, but was acquitted; the lady, who had fallen in love with Cowper, having in fact committed suicide on account of his inattention. He was one of the managers of the impeachment of Sacheverell; was attorney-general to the prince of Wales (1714), chief justice of Chester (1717), and judge of the common pleas (1727). He was grandfather of William Cowper, the poet.

The 1st earl left two sons and two daughters by his second wife. The eldest son, William (1709–1764), who succeeded to the title, assumed the name of Clavering in addition to that of Cowper on the death of his maternal uncle. His wife was a daughter of the earl of Grantham, and grand-daughter of the earl of Ossory. The son of this marriage, George Nassau, 3rd Earl Cowper (1738–1789), inherited the estates of the earl of Grantham; and in 1778 he was created by the emperor Joseph II. a prince of the Holy Roman Empire. The 5th earl (1778–1837) married a daughter of Lord Melbourne, the prime minister, by whom he had two sons; and his widow married as her second husband Lord Palmerston, who devised his property of Broadlands to her second son, William Francis Cowper-Temple (1811–1888), who was created Baron Mount Temple in 1880. The elder son, George Augustus Frederick (1806–1856), 6th Earl

Cowper, married Anne Florence, daughter of Thomas Philip, earl de Grey; and this lady at her father's death became *suo jure* baroness Lucas of Cradwell. Francis Thomas de Grey, 7th Earl Cowper (1834–1905), in addition to the other family titles, became in 1871 10th Baron Dingwall in the peerage of Scotland, and 8th Baron Butler of Moore Park in the peerage of Ireland as heir-general of Thomas, earl of Ossory, son of the 1st duke of Ormonde; the attainder of 1715 affecting those titles having been reversed in July 1871. On the death of his mother he also inherited the barony of Lucas of Cradwell. On the death without issue in 1905 of the 7th earl, who was lord lieutenant of Ireland 1880–1882, the earldom and barony of Cowper, together with the viscountcy of Fordwich, became extinct; the barony of Butler fell into abeyance among his sisters and their heirs, and the baronies of Lucas and Dingwall devolved on his nephew, Auberon Thomas Herbert (b. 1876).

See *Private Diary of Earl Cowper*, edited by E. C. Hawtrey for the Roxburghe Club (Eton, 1833); *The Diary of Mary, Countess Cowper*, edited by the Hon. Spencer Cowper (London, 1864); Lord Campbell, *Lives of the Lord Chancellors and Keepers of the Great Seal* (8 vols., London, 1845–1869); Edward Foss, *The Judges of England* (9 vols., London, 1848–1864); Gilbert Burnet, *History of his Own Time* (6 vols., Oxford, 1833); T. B. Howell, *State Trials*, vol. xii.-xv. (33 vols., London, 1809–1828); G. E. C., *Complete Peerage* (London, 1889). (R. J. M.)

**COWPER, WILLIAM** (1731–1800), English poet, was born in the rectory (now rebuilt) of Great Berkhamstead, Hertfordshire, on the 26th of November (O.S. 15th) 1731, his father the Rev. John Cowper being rector of the parish as well as a chaplain to George II. On both the father's and the mother's side he was of ancient lineage. The father could trace his family back to the time of Edward IV. when the Cowpers were Sussex land-owners, while his mother, Ann, daughter of Roger Donne of Ludham Hall, Norfolk, was of the same race as the poet Donne, and the family claimed to have Plantagenet blood in its veins. Of more human interest were Cowper's immediate predecessors. His grandfather was that Spencer Cowper who, after being tried for his life on a charge of murder, lived to be a judge of the court of common pleas, while his elder brother became lord chancellor and Earl Cowper, a title which became extinct in 1905. Here is the poet's genealogical tree.

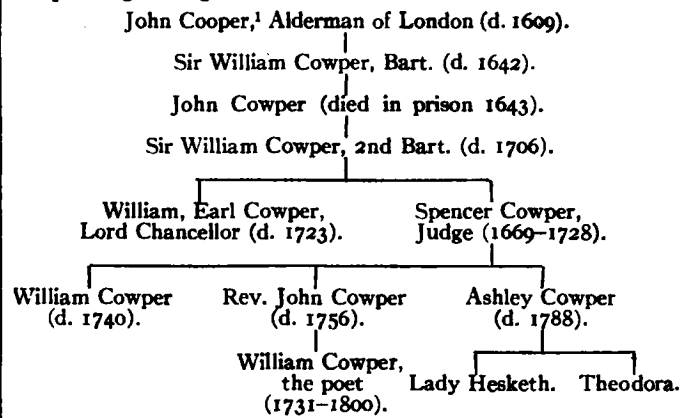

The Rev. John Cowper was twice married. Cowper's mother, to whom the memorable lines were written beginning "Oh that these lips had language," was his first wife. She died in 1737 at the age of thirty-four, when the poet was but six years old, and she is buried in Berkhamstead church. Cowper's step-mother is buried in Bath, and a tablet on the walls of the cathedral commemorates her memory. The father, who appears to have been a conscientious clergyman with no special interest in his sons, died in 1756 and was buried in the Cowper tomb at Panshanger. Only one other of his seven children grew to manhood—John, who was born in 1737.

The poet appears to have attended a dame's school in earliest infancy, but on his mother's death, when he was six years old, he was sent to boarding-school, to a Dr Pitman at Markyate, a

<sup>1</sup> Alderman Cooper thus spelt his name and all the family from that day to this, including the poet, have so pronounced it.

village 6 m. from Berkhamstead. From 1738 to 1741 he was placed in the care of an oculist, as he suffered from inflammation of the eyes. In the latter year he was sent to Westminster school, where he had Warren Hastings, Impey, Lloyd, Churchill and Colman for schoolfellows. It was at the Markyate school that he suffered the tyranny that he commemorated in *Tirocinium*. His days at Westminster, Southey thinks, were "probably the happiest in his life," but a boy of nervous temperament is always unhappy at school. At the age of eighteen Cowper entered a solicitor's office in Ely Place, Holborn. Here he had Thurlow, the future lord chancellor, as a fellow-clerk, and it is stated that Thurlow promised to help his less pushful comrade in the days of realized ambition. Three years in Ely Place were rendered happy by frequent visits to his uncle Ashley's house in Southampton Row, where he fell deeply in love with his cousin Theodora Cowper. At twenty-one years of age he took chambers in the Middle Temple, where we first hear of the dejection of spirits that accompanied him periodically through manhood. He was called to the bar in 1754. In 1759 he removed to the Inner Temple and was made a commissioner of bankrupts. His devotion to his cousin, however, was a source of unhappiness. Her father, possibly influenced by Cowper's melancholy tendencies, perhaps possessed by prejudices against the marriage of cousins, interposed, and the lovers were separated—as it turned out for ever. During three years he was a member of the Nonsense Club with his two schoolfellows from Westminster, Churchill and Lloyd, and he wrote sundry verses in magazines and translated two books of Voltaire's *Henriade*. A crisis occurred in Cowper's life when his cousin Major Cowper nominated him to a clerkship in the House of Lords. It involved a preliminary appearance at the bar of the house. The prospect drove him insane, and he attempted suicide; he purchased poison, he placed a penknife at his heart, but hesitated to apply either measure of self-destruction. He has told, in dramatic manner, of his more desperate endeavour to hang himself with a garter. Here he all but succeeded. His friends were informed, and he was sent to a private lunatic asylum at St Albans, where he remained for eighteen months under the charge of Dr Nathaniel Cotton, the author of *Visions*. Upon his recovery he removed to Huntingdon in order to be near his brother John, who was a fellow of St Benet's College, Cambridge. John had visited his brother at St Albans and arranged this. An attempt to secure suitable lodgings nearer to Cambridge had been ineffectual. In June 1765 he reached Huntingdon, and his life here was essentially happy. His illness had broken him off from all his old friends save only his cousin Lady Hesketh, Theodora's sister, but new acquaintances were made, the Unwins being the most valued. This family consisted of Morley Unwin (a clergyman), his wife Mary, and his son (William) and daughter (Susannah). The son struck up a warm friendship which his family shared. Cowper entered the circle as a boarder in November (1765). All went serenely until in July 1767 Morley Unwin was thrown from his horse and killed. A very short time before this event the Unwins had received a visit from the Rev. John Newton (*q.v.*), the curate of Olney in Buckinghamshire, with whom they became friends. Newton suggested that the widow and her children with Cowper should take up their abode in Olney. This was achieved in the closing months of 1767. Here Cowper was to reside for nineteen years, and he was to render the town and its neighbourhood memorable by his presence and by his poetry. His residence in the Market Place was converted into a Cowper Museum a hundred years after his death, in 1900. Here his life went on its placid course, interrupted only by the death of his brother in 1770, until 1773, when he became again deranged. It can scarcely be doubted that this second attack interrupted the contemplated marriage of Cowper with Mary Unwin, although Southey could find no evidence of the circumstance and Newton was not informed of it. J. C. Bailey brings final evidence of this (*The Poems of Cowper*, page 15). The fact was kept secret in later years in order to spare the feelings of Theodora Cowper, who thought that her cousin had remained as faithful as she had done to their early love.

It was not until 1776 that the poet's mind cleared again. In 1779 he made his first appearance as an author by the *Olney Hymns*, written in conjunction with Newton, Cowper's verses being indicated by a "C." Mrs Unwin suggested secular verse, and Cowper wrote much, and in 1782 when he was fifty-one years old there appeared *Poems of William Cowper of the Inner Temple, Esq.: London, Printed for J. Johnson, No. 72 St Paul's Churchyard*. The volume contained "Table Talk," "The Progress of Error," "Truth," "Expostulation" and much else that survives to be read in our day by virtue of the poet's finer work. This finer work was the outcome of his friendship with Lady Austen, a widow who, on a visit to her sister, the wife of the vicar of the neighbouring village of Clifton, made the acquaintance of Cowper and Mrs Unwin. The three became great friends. Lady Austen determined to give up her house in London and to settle in Olney. She suggested *The Task* and inspired *John Gilpin* and *The Royal George*. But in 1784 the friendship was at an end, doubtless through Mrs Unwin's jealousy of Lady Austen. Cowper's second volume appeared in 1785;—*The Task; A Poem in Six Books. By William Cowper of the Inner Temple, Esq.; To which are added by the same author An Epistle to Joseph Hill, Esq., Tirocinium or a Review of Schools, and the History of John Gilpin: London, Printed for J. Johnson, No. 72 St Paul's Church Yard; 1785*. His first book had been a failure, one critic even declaring that "Mr Cowper was certainly a good, pious man, but without one spark of poetic fire." This second book was an instantaneous success, and indeed marks an epoch in literary history. But before its publication—in 1784—the poet had commenced the translation of Homer. In 1786 his life at Olney was cheered by Lady Hesketh taking up a temporary residence there. The cousins met after an interval of twenty-three years, and Lady Hesketh was to be Cowper's good angel to the end, even though her letters disclose a considerable impatience with Mrs Unwin. At the end of 1786 a removal was made to Weston Underwood, the neighbouring village which Cowper had frequently visited as the guest of his Roman Catholic friends the Throckmortons. This was to be his home for yet another ten years. Here he completed his translation of Homer, materially assisted by Mr Throckmorton's chaplain Dr Gregson. There are six more months of insanity to record in 1787. In 1790, a year before the *Homer* was published, commenced his friendship with his cousin John Johnson, known to all biographers of the poet as "Johnny of Norfolk." Johnson also aspired to be a poet, and visited his cousin armed with a manuscript. Cowper discouraged the poetry, but loved the writer, and the two became great friends. New friends were wanted, for in 1792 Mrs Unwin had a paralytic stroke, and henceforth she was a hopeless invalid. A new and valued friend of this period was Hayley, famous in his own day as a poet and in history for his association with Romney and Cowper. He was drawn to Cowper by the fact that both were contemplating an edition of "Milton," Cowper having received a commission to edit, writing notes and translating the Latin and Italian poems. The work was never completed. In 1794 Cowper was again insane and his lifework was over. In the following year a removal took place into Norfolk, under the loving care of John Johnson. Johnson took Cowper and Mary Unwin to North Tuddenham, thence to Mundesley, then to Dunham Lodge, near Swaffham, and finally in October 1796 they moved to East Dereham. In December of that year Mrs Unwin died. Cowper lingered on, dying on the 25th of April 1800. The poet is buried near Mrs Unwin in East Dereham church.

Cowper is among the poets who are epoch-makers. He brought a new spirit into English verse, and redeemed it from the artificiality and the rhetoric of many of his predecessors. With him began the "enthusiasm of humanity" that was afterwards to become so marked in the poetry of Burns and Shelley, Wordsworth and Byron. With him began the deep sympathy with nature, and love of animal life, which was to characterize so much of later poetry.

Although Cowper cannot rank among the world's greatest poets or even among the most distinguished of poets of his own country, his place is a very high one. He had what is a rare

quality among English poets, the gift of humour, which was very singularly absent from others who possessed many other of the higher qualities of the intellect. Certain of his poems, moreover,—for example, "To Mary," "The Receipt of my Mother's Portrait," and the ballad "On the Loss of the Royal George,"—will, it may safely be affirmed, continue to be familiar to each successive generation in a way that pertains to few things in literature. Added to this, one may note Cowper's distinction as a letter-writer. He ranks among the half-dozen greatest letter-writers in the English language, and he was perhaps the only great letter-writer with whom the felicity was due to the power of what he has seen rather than what he has read.

**BIBLIOGRAPHY.**—The first important life of Cowper was by Hayley in 1803. In its complete form it appeared in 4 volumes in 1806 and was reprinted in 1809 and 1812. It was reprinted again by the Rev. T. S. Grimshawe with the *Correspondence* in 8 volumes in 1835. Robert Southey's much more valuable *Life and Letters* appeared also in 15 volumes in 1834–1837. The *Private Correspondence*, edited by John Johnson, appeared in 2 volumes in 1824 and again in 1835. The *Complete Correspondence*, edited by Thomas Wright, was published in 1904, but more correspondence appeared in *Notes and Queries*, July, August and September, 1904, and in *The Poems of William Cowper*, edited by J. C. Bailey (1905). Edward Dowden unearthed new correspondence with William Hayley in *The Atlantic Monthly* (1907). Short lives of Cowper have appeared in many quarters, from Thomas Taylor's (1833) to Goldwin Smith's in the "English Men of Letters" series (1880). Another brief biography of great merit is attached to the Globe edition of Cowper's *Works*. Essays by Leslie Stephen, Stopford Brooke, Whitwell Elwin, George Eliot and Walter Bagehot deserve attention. See also 'St Beuve's *Couseris du Lundi* (1868), vol. xi.; *Letters of Lady Hesketh to John Johnson* (1901); *John Newton*, by the Rev. Josiah Bull (1868); *Cowper and Mary Unwin*, by Caroline Gearey (1900); and *A Concordance to the Poetic Works of William Cowper*, by John Neave (1887).

**COWRY**, the popular name of the shells of the *Cypræida*, a family of mollusks. Upwards of 100 species are recognized, and they are widely distributed over the world—their habitat being the shallow water along the sea-shore. The best known is the money cowry or *Cypræa moneta*, a small shell about half an inch in length, white and straw-coloured without and blue within, which derives its distinctive name from the fact that in various countries it has been employed as a kind of currency. (See SHELL-MONEY.) In Africa among those tribes, such as the Niam-Niam, who do not recognize their monetary value, the shells are in demand as fashionable decorations, just as in Germany they were in use as an ornament for horses' harness, and were popular enough to acquire several native names, such as *Brustharnisch* or breastplates, and *Otterköpfchen* or little adders' heads. Besides the *Cypræa moneta* various species are employed in this decorative use. The *Cypræa aurora* is a mark of chieftainship among the natives of the Friendly Islands; the *Cypræa annulus* is a favourite with the Asiatic islanders; and several of the larger kinds have been used in Europe for the carving of cameos. The tiger cowry, *Cypræa tigris*, so well known as a mantelpiece ornament in England and America, is commonly used by the natives of the Sandwich Islands to sink their nets; and they have also an ingenious plan of cementing portions of several shells into a smooth oval ball which they then employ as a bait to catch the cuttle-fish. While the species already mentioned occur in myriads in their respective habitats, the *Cypræa princeps* and the *Cypræa umbilicata* are extremely rare.

**COW-TREE**, or **MILK-TREE**, *Brosimum Galactodendron* (natural order Moraceae), a native of Venezuela. As in other members of the order, the stem contains a milky latex, which flows out in considerable quantities when a notch is cut in it. The "milk" is sweet and pleasant tasting. Another species, *B. Alicastrum*, the bread-nut tree, a native of central America and Jamaica, bears a fruit which is cooked and eaten. The bread-fruit (*Artocarpus*) is an allied genus of the same natural order.

**COX, DAVID** (1783–1859), English painter, was born on the 29th of April 1783, in a small house attached to the forge of his father, a hardworking master smith, in a mean suburb of Birmingham. Turning his hand to what he could get to do, Joseph Cox, the father, was both blacksmith and whitesmith, and when the war with France began took to the making of bayonets and horse

shoes, on wholesale commission, and immediately the boy David was thought able to assist he was taken from the poor elementary school in the neighbourhood, and set to the anvil. The attempt to turn the boy to this kind of labour had, however, been made too early; it was too heavy for his strength, and he was sent to what was called by the cyclops of Birmingham a "toy trade," making lacquered buckles, painted locket, tin snuff-boxes and other "fancy" articles. Here David very soon acquired some power of painting miniatures, and his talents might have been misdirected had his master, Fieldler by name, not released him from his apprenticeship by dying by his own hand; and David found an opening as colour-grinder and scene-painter's fag in the theatre then leased, with several others, by the father of Macready, the tragedian.

This obscure step, not one of promotion at the time, was really the most important incident in the uneventful career of Cox. The boy, who had inherited a rather weakly body, and had been trained with care by a pious mother, while intellectually negative and unable to cope with any kind of learning whatever, had endless perseverance, great strength of application, and all through life remained genial, gentle, simple-minded and modest, his penetration and self-reliance being wholly professional, inspired by his love of nature and his knowledge of his subject. Not very quick, and with little versatility, he went step by step in one line of study from the time he began to get the smallest remuneration for his pictures to the age of seventy-five, when he painted large in oil very much the same class of subjects he had of old produced small in water-colours, with the same impressive and unaffectedly noble sentiment, only increased by the mastery of almost infinite practice. He was never led astray by fictitious splendour of any kind, except once indeed in 1825, when he imitated Turner, and produced a classic subject he called "Carthage, Aeneas, and Achates." He never visited Venice or Egypt, or crossed the Channel except for a week or two in Belgium and Paris, and never even went to Scotland for painting purposes. Bettws-y-Coed and its neighbourhood was everything to him, and characteristics most truly English were beloved by him with a sort of filial instinct. So completely did he love the country, that even London, where it was his interest to live, had few attractions, and did not retain him long.

This residence in the metropolis which began in 1804 was, however, of the most essential educational advantage to him. The Water-Colour Society was established the year after he arrived, and was mainly supported by landscape-painters. He was not, of course, admitted at first into membership, not till 1813, before which time an attempt to establish a rival exhibition had been made. In this Cox joined, the result being very serious to him, an entire failure entailing the seizure and forced sale of all the pictures. At that time the tightest economy was the rule with him, and to save the trifling cost of new strainers or stretching boards, he covered up one picture by another. When these works were prepared for re-sale, fifty years afterwards, some of them yielded picture after picture, peeled off the boards like the waistcoats from the body of the gravedigger in Hamlet!

While lodging near Astley's Circus he married his landlady's daughter, and then took a modest cottage at Dulwich, where he gradually left off scene-painting and became teacher, giving lessons at ten shillings a lesson. This entailed walking to the pupils' homes, and the gift of the paintings done before the pupils. These have since been frequently sold for large sums, but his own price, when lucky enough to sell his best works, was never over a few pounds, and more frequently about fifteen shillings. Sometimes, indeed, he sold them in quantities at two pounds a dozen to be resold to country teachers. By and by he resisted the leaving of the work done to the pupil, but with little advantage to himself, as he saw no end to the accumulation of his own productions, and actually tore them up, and threw them into areas, or pushed them into drains during his trudge homeward. A number of years after he pointed out a particular drain to a friend, and said, "Many a work of mine has gone down that way to the Thames!"

Shortly after he had turned thirty, his stay in London suddenly

ended. He was offered the enormous sum of £100 per annum, by a ladies' college in Hereford, and thither he went. This sum he supplemented by teaching in the Hereford grammar school for many years, at six guineas a year, and in other schools at better pay, but still, and up to his fortieth year, we find his prices for pictures from eight to twenty-five shillings. Cox has no history apart from his productions, and these particulars as to his remuneration possess an interest almost dramatic when we contrast them with the enormous sums realized by his later works, and with the "honours and observance, troops of friends," that accompanied old age with him, when settled down in his own home at Harborne, near his native town, where he died on the 7th of June 1859.

Cox's second short residence in London, dating from 1835 to 1840, marks the period of his highest powers. During those years, and for twelve years after, his productiveness kept pace with his mastery, and it would be difficult to overrate the impressiveness of effect, and high feeling, within the narrow range of subject displayed by many of these works. He was now surrounded by dealers, and wealth flowed in upon him. Still he remained the same, a man with few wants and scarcely any enjoyments except those furnished by his brush and his colours. The home at Harborne was a pleasant one, but the approach to the front was useless as the door was kept fastened up, the only entrance being through the garden at the back, and the principal room appropriated as his studio he was content to reach by a narrow stair from the kitchen. Neither in it nor elsewhere was there any luxury or even taste visible:—no *bric-à-brac*, no objects of interest, few or no books, no pictures except landscapes by his friends. When in winter, after his wife's death, the fire went out, and the cold at last surprised him, he lifted his easel into the little dining-room and began again. A union of his friends was formed in 1855 to procure a portrait of him, which was painted by Sir J. Watson Gordon; and an exhibition of his works was opened in London in 1858 and again another in 1859. This was actually open when the news of his death arrived.

The number of David Cox's works, great and small, is enormous. He produced hundreds annually for perhaps forty-five years. Before his death and for ten years thereafter, their prices were remarkable, as witness the following obtained at auction—"Going to the Mill," £1575; "Old Mill at Bettws-y-Coed," £1575; "Outskirts of a Wood, with Gipsies," £2305; "Peace and War," £3430.

See Hall, *Biography of David Cox* (1881). (W. B. Sc.)

**COX, SIR GEORGE WILLIAM** (1827-1902), English divine and scholar, was born on the 10th of January 1827, at Benares, India, and was educated at Rugby and Trinity College, Oxford. In 1850 he was ordained, and in 1860 took a mastership at Cheltenham College, which he held for only a year. He had already contributed to the *Edinburgh Review*, and had published in 1850 *Poems, Legendary and Historical* (with E. A. Freeman), and in 1853 a *Life of St Boniface*. From 1861 he devoted himself entirely to literary work, chiefly in connexion with history and comparative mythology. Many of his works were avowedly popular in character, and the most important, the *History of Greece*, has been superseded and is now of little value. His studies in mythology were inspired by Max Müller, but his treatment of the subjects was his own. He was an extreme supporter of the solar and nebular theory as the explanation of myths. He also edited (with W. T. Brande) *A Dictionary of Science, Literature and Art* (1875). Sir George Cox (who succeeded to the baronetcy in 1877) was a Broad Churchman, and a prominent supporter of Bishop Colenso in 1863-1865; and five years after Colenso's death he published (1888) his *Life of the bishop*. He was himself nominated to the see of Natal, but was refused consecration. In 1881 he was made vicar of Scrayingham, York, but resigned the living in 1897. In 1896 he was given a civil list pension. He died at Walmer on the 9th of February 1902.

WORKS.—*Tales from Greek Mythology* (1861); *A Manual of Mythology* (1867); *Latin and Teutonic Christendom* (1870); *The Mythology of the Aryan Nations* (1870, new ed., 1882); *History*

*of Greece* (1874); *General History of Greece* (1876); *History of the Establishment of British Rule in India*, and *An Introduction to the Science of Comparative Mythology* (1881); *Lives of Greek Statesmen* (1885); *Concise History of England* (1887).

**COX, JACOB DOLSON** (1828-1900), American general, political leader and educationalist, was born on the 27th of October 1828 in Montreal, Canada. His father, a shipbuilder of German descent (Koch), and his mother, a descendant of William Brewster, were natives of New York City, where the boy grew up, studying law in an office in 1842-1844, and working in a broker's office in 1844-1846, and where, under the influence of Charles G. Finney (1792-1875), whose daughter he afterwards married, he prepared himself for the ministry. He graduated at Oberlin College in 1851, having in the meantime given up his theological studies in rebellion at Finney's dogmatism. In 1851-1853 he was superintendent of schools at Warren, Ohio; in 1853 was admitted to the Ohio bar, being at that time an anti-slavery Whig; and in 1859 was elected to the state senate, in which with Garfield and James Monroe (1821-1898) he formed the "Radical Triumvirate," Cox himself presenting a petition for a personal liberty law and urging woman's rights, especially larger property rights to married women. Appointed by Governor Dennison one of three brigadiers-general of militia in 1860, he eagerly undertook the study of tactics, strategy and military history. He rendered great assistance in raising troops for the Union service in 1861, enlisted himself in spite of poor health and a family of six small children, and in April was commissioned a brigadier-general, U.S.V. He took part in the West Virginia campaign of 1861, served in the Kanawha region, in supreme command after Rosecrans's relief in the spring, until August 1862, when his troops were ordered to join Burnside's 9th Corps in Virginia. After the death at his side of General Reno in the battle of South Mountain, and during Antietam, Cox commanded the corps, and at the close of the campaign (6th Oct. 1862) he was appointed major-general, U.S.V., but the appointment was not confirmed. In April-December 1863 he was head of the department of Ohio. In 1864 he took part in the Atlanta campaign under Sherman, as a divisional and subsequently corps-commander: at the battle of Franklin he commanded the 23rd Corps, and he served at Nashville also. He led an expedition following Sherman into the Carolinas and fought two successful actions with Bragg at Kinston, N.C. He was governor of Ohio in 1866-1867, and as such advocated the colonization of the freedmen in a restricted area, and sympathized with President Johnson's programme of Reconstruction and worked for a compromise between Johnson and his opponents, although he finally deserted Johnson. In 1868 he was chairman of the Republican national convention which nominated Grant. He was secretary of the interior in 1869-1870; opposed the confirmation of the treaty for the annexation of Santo Domingo, negotiated by O. E. Babcock and urged by President Grant; introduced the merit system in his department, and resigned in October 1870 because of pressure put on him by politicians piqued at his prohibition of campaign levies on his clerks, and because of the interference of Grant in favour of William McGarrah's attempt by legal proceedings to obtain from Cox a patent to certain California mining lands. He took up legal practice in Cincinnati, became president in 1873, and until 1877 was receiver, of the Toledo & Wabash & Western. In 1877-1879 he was a representative in Congress. From 1881 to 1897 he was dean of the Cincinnati law school, and from 1885 to 1889 president of the University of Cincinnati. He died at Magnolia, Massachusetts, on the 4th of August 1900. A successful lawyer, and in his later years a prominent microscopist, who won a gold medal of honour for microphotography at the Antwerp Exposition of 1891, he is best known as one of the greatest "civilian" generals of the Civil War, and, with the possible exception of J. C. Ropes, the highest American authority of his time on military history, particularly the history of the American Civil War. He wrote *Atlanta* (New York, 1882) and *The March to the Sea, Franklin and Nashville* (New York, 1882), both in the series *Campaigns of the Civil War*; *The Second Battle of Bull Run, as Connected*



with the *Fitz-John Porter Case* (Cincinnati, 1882); and the valuable *Military Reminiscences of the Civil War* (2 vols., New York, 1900) published posthumously.

See J. R. Ewing, *Public Services of Jacob Dolson Cox* (Washington, 1902), a Johns Hopkins University dissertation; and W. C. Cochran, "Early Life and Military Services of General Jacob Dolson Cox," in *Bibliotheca Sacra*, vol. 58 (Oberlin, Ohio, 1901).

**COX, KENYON** (1856– ), American painter, was born at Warren, Ohio, on the 27th of October 1856, being the son of Gen. Jacob Dolson Cox. He was a pupil of Carolus-Duran and of J. L. Gérôme in Paris from 1877 to 1882, when he opened a studio in New York, subsequently teaching with much success in the Art Students' League. His earlier work was mainly of the nude drawn with great academic correctness in somewhat conventional colour. Receiving little encouragement for such pictures, he turned to mural decorative work, in which he achieved prominence. Among his better-known examples are the frieze for the court room of the Appellate Court, New York, and decorations for the Walker Art Gallery, Bowdoin College; for the Capitol at Saint Paul, Minnesota, and for other public and private buildings. He wrote with much authority on art topics, and is the author of the critical reviews, *Old Masters and New* (1905) and *Painters and Sculptors* (1907), besides some poems. He became a National Academician in 1903. His wife, *née* Louise H. King (b. 1865), whom he married in 1892, also became a figure and portrait-painter of note.

**COX, RICHARD** (1500?–1581), dean of Westminster and bishop of Ely, was born of obscure parentage at Whaddon, Buckinghamshire, in 1499 or 1500. He was educated at the Benedictine priory of St Leonard Snelshall near Whaddon, at Eton, and at King's College, Cambridge, where he graduated B.A. in 1524. At Wolsey's invitation he became a member of the cardinal's new foundation at Oxford, was incorporated B.A. in 1525, and created M.A. in 1526. In 1530 he was engaged in persuading the more unruly members of the university to approve of the king's divorce. A premature expression of Lutheran views is said to have caused his departure from Oxford and even his imprisonment, but the records are silent on these sufferings which do not harmonize with his appointment as master of the royal foundation at Eton. In 1533 he appears as author of an ode on the coronation of Anne Boleyn, in 1535 he graduated B.D. at Cambridge, proceeding D.D. in 1537, and in the same year subscribing the Institution of a Christian Man. In 1540 he was one of the fifteen divines to whom were referred crucial questions on the sacraments and the seat of authority in the Church; his answers (printed in Pocock's *Burnet*, iii. 443–496) indicate a mind tending away from Catholicism, but susceptible to "the king's doctrine"; and, indeed, Cox was one of the divines by whom Henry said the "King's Book" had been drawn up when he wished to impress upon the Regent Arran that it was not exclusively his own doing. Moreover, he was present at the examination of Barnes, subscribed the divorce of Anne of Cleves, and in that year of reaction became archdeacon and prebendary of Ely and canon of Westminster. He was employed on other royal business in 1541, was nominated to the projected bishopric of Southwell, and was made king's chaplain in 1542. In 1543 he was employed to ferret out the "Prebendaries' Plot" against Cranmer, and became the archbishop's chancellor. In December he was appointed dean of Oseney (afterwards Christ Church) Oxford, and in July was made almoner to Prince Edward, in whose education he took an active part. He was present at Dr Crome's recantation in 1546, denounced it as insincere and insufficient, and severely handled him before the privy council.

After Edward's accession, Cox's opinions took a more Protestant turn, and he became one of the most active agents of the Reformation. He was consulted on the compilation of the Communion office in 1548, and the first and second books of Common Prayer, and sat on the commission for the reform of the canon law. As chancellor of the university of Oxford (1547–1552) he promoted foreign divines such as Peter Martyr, and was a moving spirit of the two commissions which sought with some success to eradicate everything savouring of popery from the

books, MSS., ornaments and endowments of the university, and earned Cox the sobriquet of its cancellor rather than its chancellor. He received other rewards, a canonry of Windsor (1548), the rectory of Harrow (1547) and the deanery of Westminster (1549). He lost these preferments on Mary's accession, and was for a fortnight in August 1553 confined to the Marshalsea. He was not of the stuff of which martyrs are made; he remained in obscurity until after the failure of Wyatt's rebellion, and then in May 1554 escaped in the same ship as the future archbishop Sandys, to Antwerp. Thence in March 1555 he made his way to Frankfort, where he played an important part in the first struggle between Anglicanism and Puritanism. The exiles had, under the influence of Knox and Whittingham, adopted Calvinistic doctrine and a form of service far more Puritanical than the Prayer-Book of 1552. Cox stood up for that service, and the exiles were divided into Knoxians and Coxians. Knox attacked Cox as a pluralist, Cox accused Knox of treason to the emperor Charles V. This proved the more dangerous charge: Knox and his followers were expelled, and the Prayer-Book of 1552 was restored.

In 1559 Cox returned to England, and was elected bishop of Norwich, but the queen changed her mind and Cox's destination to Ely, where he remained twenty-one years. He was an honest, but narrow-minded ecclesiastic, who held what views he did hold intolerantly, and was always wanting more power to constrain those who differed from him (see his letter in *Hatfield MSS.* i. 308). While he refused to minister in the queen's chapel because of the crucifix and lights there, and was a bitter enemy to the Roman Catholics, he had little more patience with the Puritans. He was grasping, or at least tenacious of his rights in money matters, and was often brought into conflict with courtiers who coveted episcopal lands. The queen herself intervened, when he refused to grant Ely House to her favourite, Sir Christopher Hatton; but the well-known letter beginning "Proud Prelate" and threatening to unfrock him seems to be an impudent forgery which first saw the light in the *Annual Register* for 1761. It hardly, however, misrepresents the queen's meaning, and Cox was forced to give way. These and other trials led him to resign his see in 1580, and it is significant that it remained vacant for nineteen years. Cox died on the 22nd of July 1581: a monument erected to his memory twenty years later in Ely cathedral was defaced, owing, it was said, to his evil repute. Strype (*Whitgift*, i. 2) gives Cox's hot temper and marriage as reasons why he was not made archbishop in 1583 in preference to Whitgift, who had been his chaplain; but Cox had been dead two years in 1583. His first wife's name is unknown; she was the mother of his five children, of whom Joanna married the eldest son of Archbishop Parker. His second wife was the widow of William Turner (d. 1568), the botanist and dean of Wells.

Voluminous details about Cox's life are given in Strype's *Works*, Parker Soc. Publ., and Cooper's *Athenae Cantab.* i. 437–445. See also *Letters and Papers of Henry VIII.*; *Acts of the Privy Council*; *Cal. Dom. State Papers*; *Cal. Hatfield MSS.*; *Lit. Rem. of Edward VI.*; *Whittingham's Troubles at Frankfort*; *Machyn's Diary*; *Pocock's Burnet*; *Bentham's Ely*; *Willis's Cathedrals*; *Le Neve's Fasti*; *R. W. Dixon's Church History*. (A. F. P.)

**COX, SAMUEL** (1826–1893), English nonconformist divine, was born in London on the 19th of April 1826. For some years he worked as an apprentice in the London docks, and then entered the Baptist College at Stepney. In 1851 he became pastor of a Baptist church at Southsea, removing in 1855 to Ryde, and in 1863 to Nottingham. He was president of the Baptist Association in 1873 and received the degree of D.D. from St Andrews in 1882. Cox had distinct gifts as a biblical expositor and was the founder and first editor of a monthly journal *The Expositor* (1875–1884). Among the best known of his numerous theological publications are *Salvator Mundi* (1877), *A Commentary on the Book of Job* (1880), *The Larger Hope* (1883).

**COX, SAMUEL HANSON** (1793–1880), American Presbyterian divine, was born at Rahway, N.J., on the 25th of August 1793, of Quaker stock. He was pastor of the Presbyterian church at Mendham, N.J., in 1817–1821, and of two churches in New York from 1821 to 1834. He helped to found the University of the City of New York, and from 1834 to 1837 was professor of pastoral

theology at Auburn. The next seventeen years were passed in active ministry at Brooklyn, whence in 1854, owing to a throat affection, he removed to Owego, N.Y. He died at Bronxville, N.Y., on the 2nd of October 1880. Cox was a fine orator, and a speech made in Exeter Hall in 1833, in which he put the responsibility for slavery in America on the British government, made a great impression. It was he who described the appellation D.D. as a couple of "semi-lunar fardels."

His son, ARTHUR CLEVELAND COXE (1818-1896), who changed the spelling of the family name, graduated at the University of the City of New York in 1838 and at the General Theological Seminary in 1841. He was rector of St John's Church, Hartford, in 1843-1854, of Grace Church, Baltimore, in 1854-1863, and of Calvary Church, New York City, in 1863. In 1863 he became assistant bishop and in 1865 bishop of western New York. He was strongly influenced by the Oxford Movement. Bishop Coxe wrote spirited defences of Anglican orders and published several volumes of verse, notably *Christian Ballads* (1845).

**COXCIE, MICHAEL** (1499-1592), Flemish painter, was born at Malines, and studied under Bernard van Orley, who probably induced him to visit Italy. At Rome in 1532 he painted the chapel of Cardinal Enckenvoort in the church of Santa Maria dell' Anima; and Vasari, who knew him, says with truth "that he fairly acquired the manner of an Italian." But Coxcie's principal occupation was designing for engravers; and the fable of Psyche in thirty-two sheets by Agostino Veneziano and the Master of the Die are favourable specimens of his skill. During a subsequent residence in the Netherlands Coxcie greatly extended his practice in this branch of art. But his productions were till lately concealed under an interlaced monogram M.C.O.K.X.I.N. Coxcie returned in 1539 to Malines, where he matriculated, and painted for the chapel of the gild of St Luke the wings of an altarpiece now in Sanct Veit of Prague. The centre of this altarpiece, by Mabuse, represents St Luke portraying the Virgin; the side pieces contain the Martyrdom of St Vitus and the Vision of St John in Patmos. At van Orley's death in 1541 Coxcie succeeded to the office of court painter to the regent Mary of Hungary, for whom he decorated the castle of Binche. He was subsequently patronized by Charles V., who often coupled his works with those of Titian; by Philip II., who paid him royally for a copy of van Eyck's "Agnus Dei"; and by the duke of Alva, who once protected him from the insults of Spanish soldiery at Malines. There are large and capital works of his (1587-1588) in St Rombaud of Malines, in Ste Gudule of Brussels, and in the museums of Brussels and Antwerp. His style is Raphaelesque grafted on the Flemish, but his imitation of Raphael, whilst it distantly recalls Giulio Romano, is never free from affectation and stiffness. He died at Malines on the 5th of March 1592.

**COXE, HENRY OCTAVIUS** (1811-1881), English librarian and scholar, was born at Bucklebury, in Berkshire, on the 20th of September 1811. He was educated at Westminster school and Worcester College, Oxford. Immediately on taking his degree in 1833, he began work in the manuscript department of the British Museum, became in 1838 sub-librarian of the Bodleian, at Oxford, and in 1860 succeeded Dr Bandinel as head librarian, an office he held until his death in 1881. Having proved himself an able palaeographer, he was sent out by the British government in 1857 to inspect the libraries in the monasteries of the Levant. He discovered some valuable manuscripts, but the monks were too wise to part with their treasures. One valuable result of his travels was the detection of the forgery attempted by Constantine Simonides. He was the author of various catalogues, and under his direction that of the Bodleian, in more than 720 volumes, was completed. He published *Rogeri de Wendover Chronica*, 5 vols. (1841-1844); the *Black Prince, an historical poem written in French by Chandos Herald* (1842); and *Report on the Greek Manuscripts yet remaining in the Libraries of the Levant* (1858). He was not only an accurate librarian but an active and hard-working clergyman, and was for the last twenty-five years of his life in charge of the parish of Wytham, near Oxford. He was likewise honorary fellow of Worcester and Corpus Christi Colleges. He died on the 8th of July 1881.

**COXE, WILLIAM** (1747-1828), English historian, son of Dr William Coxe, physician to the royal household, was born in London on the 7th of March 1747. Educated at Marylebone grammar school and at Eton College, he proceeded to King's College, Cambridge, and was elected a fellow of this society in 1768. In 1771 he took holy orders, and afterwards visited many parts of Europe as tutor and travelling companion to various noblemen and gentlemen. In 1786 he was appointed vicar of Kingston-on-Thames, and in 1788 rector of Bemerton, Wiltshire. He also held the rectory of Stourton from 1801 to 1811 and that of Fovant from 1811 until his death. In 1791 he was made prebendary of Salisbury, and in 1804 archdeacon of Wiltshire. He married in 1803 Eleanora, daughter of William Shairp, consul-general for Russia, and widow of Thomas Yeldham of St Petersburg. He died on the 8th of June 1828.

During a long residence at Bemerton Coxe was mainly occupied in literary work. His *Memoirs of Sir Robert Walpole* (London, 1798), *Memoirs of Horatio, Lord Walpole* (London, 1802), *Memoirs of John, duke of Marlborough* (London, 1818-1819), *Private and Original Correspondence of Charles Talbot, duke of Shrewsbury* (London, 1821), *Memoirs of the Administrations of Henry Pelham* (London, 1829), are very valuable for the history of the 18th century. His *History of the House of Austria* (London, 1807, new ed. 1853 and 1873), and *Memoirs of the Bourbon Kings of Spain* (London, 1813), give evidence of careful and painstaking work on the part of the author. The style, however, as in all his works, is remarkably dull. His other works are mainly accounts of his travels: *Sketches of the Natural, Political and Civil State of Switzerland* (London, 1779), *Account of the Russian Discoveries between Asia and America* (London, 1780), *Account of Prisons and Hospitals in Russia, Sweden and Denmark* (London, 1781), *Travels into Poland, Russia, Sweden and Denmark* (London, 1784), *Travels in Switzerland* (London, 1789), *Letter on Secret Tribunals of Westphalia* (London, 1796), *Historical Tour in Monmouthshire* (London, 1801). He also edited Gay's *Fables*, and wrote a *Life of John Gay* (Salisbury, 1797), *Anecdotes of G. F. Handel and J. C. Smith* (London, 1798), and a few other works of minor importance. Some of his books have been translated into French, and several have gone through two or more editions.

**COXSWAIN** (properly "cockswain," and pronounced *cox'n*, usually shortened to "cox"; from "cock," a small boat, and *swain*, a servant), in the navy, a petty officer in charge of a ship's boat and its crew, who steers; the coxswain of the captain's gig takes a special rank among petty officers. In the National Lifeboat Institution of Great Britain the "coxswain" is a paid permanent official on each station, who has charge of the lifeboat and house, is responsible for its care, and steers and takes command when afloat. The word is also used, generally, of any one who steers a boat.

**COXWELL, HENRY TRACEY** (1819-1900), English aeronaut, was born at Wouldham, Kent, on the 2nd of March 1819, the son of a naval officer. He was educated for the army, but became a dentist. From a boy he had been greatly interested in ballooning, then in its infancy, but his own first ascent was not made until 1844. In 1848 he became a professional aeronaut, making numerous public ascents in the chief continental cities. Returning to London, he gave exhibitions from the Cremorne and subsequently from the Surrey Gardens. By 1861 he had made over 400 ascents. In 1862 in company with Dr James Glaisher, he attained the greatest height on record, about 7 m. His companion became insensible, and he himself, unable to use his frost-bitten hands, opened the gas-valve with his teeth, and made an extremely rapid but safe descent. The result of this and other aerial voyages by Coxwell and Glaisher was the making of some important contributions to the science of meteorology. Coxwell was most pertinacious in urging the practical utility of employing balloons in time of war. He says: "I had hammered away in *The Times* for little less than a decade before there was a real military trial of ballooning for military purposes at Aldershot." His last ascent was made in 1885, and he died on the 5th of January 1900.

See his *My Life and Balloon Experiences* (1887).

**COYOTE**, the Indian name for a North American member of the dog family, also known as the prairie-wolf, and scientifically as *Canis latrans*. Ranging from Canada in the north to Guatemala in the south, and chiefly frequenting the open plains on both sides of the chain of the Rocky Mountains, the coyote, under all its various local phases, is a smaller animal than the true wolf, and may apparently be regarded as the New World representative of the jackals, or perhaps, like the Indian wolf (*C. pallipes*), as a type intermediate between wolves and jackals. In addition to its inferior size, the coyote is also shorter in the leg than the wolf, and carries a more luxuriant coat of hair. The average length is about 40 in., and the general tone of colour tawny mingled with black and white above and whitish below, the tail having a black tip and likewise a dark gland-patch near the root of the upper surface. There is, however, considerable local variation both in the matter of size and of colour from the typical coyote of Iowa, which measures about 50 in. in total length and is of a full rich tint. The coyote of the deserts of eastern California, Nevada and Utah is, for instance, a smaller and paler-coloured animal, whose length is usually about 42 in. On this and other local variations a number of nominal species have been founded; but it is preferable to regard them in the light of geographical phases or races, such as the above-mentioned *C. latrans estor* of Nevada and Utah, *C. l. mearnsi* of Arizona and Sonora, and *C. l. fruster* of Oklahoma and the Arkansas River district.

It is to distinguish them from the grey, or timber, wolves that coyotes have received the name of "prairie-wolves"; the two titles indicating the nature of the respective habitats of the two species. Coyotes are creatures of slinking and stealthy habits, living in burrows in the plains, and hunting in packs at night, when they utter yapping cries and blood-curdling yells as they gallop. Hares ("jack-rabbits"), chipmunks or ground-squirrels, and mice form a large portion of their food; but coyotes also kill the fawns of deer and prongbuck, as well as sage-hens and other kinds of game-birds. "In the flat lands," write Messrs Witmer Stone and W. E. Cram, in their *American Animals* (1902), "they dig burrows for themselves or else take possession of those already made by badgers and prairie-dogs. Here in the spring the half-dozen or more coyote pups are brought forth; and it is said that at this season the old ones systematically drive any large game they may be chasing as near to their burrow, where the young coyotes are waiting to be fed, as possible before killing it, in order to save the labour of dragging it any great distance. When out after jack-rabbits two coyotes usually work together. When a jack-rabbit starts up before them, one of the coyotes bounds away in pursuit while the other squats on his haunches and waits his turn, knowing full well that the hare prefers to run in a circle, and will soon come round again, when the second wolf takes up the chase and the other rests in his turn. . . . When hunting antelope (prongbuck) and deer the coyotes spread out their pack into a wide circle, endeavouring to surround their game and keep it running inside their ring until exhausted. Sage-hens, grouse and small birds the coyote hunts successfully alone, quartering over the ground like a trained pointer until he succeeds in locating his bird, when he drops flat in the grass and creeps forward like a cat until close enough for the final spring."

When hard put to it for food, coyotes will, it is reported, eat hips, juniper-berries and other wild fruits. (R. L.\*)

**COYPEL**, the name of a French family of painters. Noel Coypel (1628-1707), also called, from the fact that he was much influenced by Poussin, **COYPEL LE POUSSIN**, was the son of an unsuccessful artist. Having been employed by Charles Errard to paint some of the pictures required for the Louvre, and having afterwards gained considerable fame by other pictures produced at the command of the king, in 1672 he was appointed director of the French Academy at Rome. After four years he returned to France; and not long after he became director of the Academy of Painting. The Martyrdom of St James, in Notre Dame is perhaps his finest work.

His son, **ANTOINE COYPEL** (1661-1772), was still more celebrated

than his father. Antoine studied under his father, with whom he spent four years at Rome. At the age of eighteen he was admitted into the Academy of Painting, of which he became professor and rector in 1707, and director in 1714. In 1716 he was appointed king's painter, and he was ennobled in the following year. Antoine Coypel received a careful literary education, the effects of which appear in his works; but the graceful imagination displayed by his pictures is marred by the fact that he was not superior to the artificial taste of his age. He was a clever etcher, and engraved several of his own works. His *Discours prononcés dans les conférences de l'Académie royale de Peinture, &c.*; appeared in 1741.

Antoine's half-brother, **NOEL NICHOLAS COYPEL** (1692-1734), was also an exceedingly popular artist; and his son, Charles Antoine (1694-1752), was painter to the king and director of the Academy of Painting. The latter published interesting academical lectures in *Le Mercure* and wrote several plays which were acted at court, but were never published.

**COYPU**, the native name of a large South American aquatic rodent mammal, known very generally among European residents in the country as nutria (the Spanish word for otter) and scientifically as *Myocastor* (or *Myopotamus*) *coypu*. Its large size, aquatic habits, partially webbed hind-toes, and the smooth, broad, orange-coloured incisors, are sufficient to distinguish this rodent from the other members of the family *Capromyidae*. Coypu are abundant in the fresh waters of South America, even small ponds being often tenanted by one or more pairs. Should the water dry up, the coypu seek fresh homes. Although subsisting to a considerable extent on aquatic plants, these rodents frequently come ashore to feed, especially in the evening. Several young are produced at a birth, which are carried on their mother's back when swimming. The fur is of some commercial value, although rather stiff and harsh; its colour being reddish-brown. (See **RODENTIA**.)

**COYSEVOX, CHARLES ANTOINE** (1640-1720), French sculptor, was born at Lyons on the 20th of September 1640, and belonged to a family which had emigrated from Spain. The name should be pronounced Cozévo. He was only seventeen when he produced a statue of the Madonna of considerable merit; and having studied under Lerambert and trained himself by taking copies in marble from the Greek masterpieces (among others from the Venus de Medici and the Castor and Pollux), he was engaged by the bishop of Strassburg, Cardinal Fürstenberg, to adorn with statuary his château at Saverne (Zabern). In 1666 he married Marguerite Quillier, Lerambert's niece, who died a year after the marriage. In 1671, after four years spent on Saverne, which was subsequently destroyed by fire in 1780, he returned to Paris. In 1676 his bust of the painter Le Brun obtained admission for him to the Académie Royale. A year later he married Claude Bourdict.

In consequence of the influence exercised by Le Brun between the years 1677 and 1685, he was employed by Louis XIV. in producing much of the decoration and a large number of statues for Versailles; and he afterwards worked, between 1701 and 1709, with no less facility and success, for the palace at Marly, subsequently destroyed in the Revolution.

Among his works are the "Mercury and Fame," first at Marly and afterwards in the gardens of the Tuileries; "Neptune and Amphitrite," in the gardens at Marly; "Justice and Force," at Versailles; and statues, in which the likenesses are said to have been remarkably successful, of most of the celebrated men of his age, including Louis XIV. and Louis XV. at Versailles, Colbert (at Saint-Eustache), Mazarin (in the church des Quatre-Nations), Condé the Great (in the Louvre), Maria Theresa of Austria, Turenne, Vauban, Cardinals de Bouillon and de Polignac, Fénelon, Racine, Bossuet (in the Louvre), the comte d'Harcourt, Cardinal Fürstenberg and Charles Le Brun (in the Louvre). Coysevox died in Paris on the 10th of October 1720.

Besides the works given above he carved about a dozen memorials, including those to Colbert (at Saint-Eustache), to Cardinal Mazarin (in the Louvre), and to the painter Le Brun (in the church of Saint Nicholas-du-Chardon).

Among the pupils of Coysevox were Nicolas and Guillaume Coustou.

See Henry Jouin, *A. Coysevox, sa vie, son œuvre* (1883); Jean du Seigneur, *Revue universelle des arts*, vol. i. (1855), pp. 32 et seq.

**CRAB** (Ger. *Krabbe, Krebs*), a name applied to the Crustacea of the order *Brachyura*, and to other forms, especially of the order *Anomura*, which resemble them more or less closely in appearance and habits.

The *Brachyura*, or true crabs, are distinguished from the long-tailed lobsters and shrimps which form the order *Macrura*, by the fact that the abdomen or tail is of small size and is carried folded up under the body. In most of them the body is transversely oval or triangular in outline and more or less flattened, and is covered by a hard shell, the carapace. There are five pairs of legs. The first pair end in nippers or chelae and are usually much more massive than the others which are used in walking or swimming. The eyes are set on movable stalks and can be withdrawn into sockets in the front part of the carapace. There are six pairs of jaws and foot-jaws (maxillipedes) enclosed within a "buccal cavern," the opening of which is covered by the

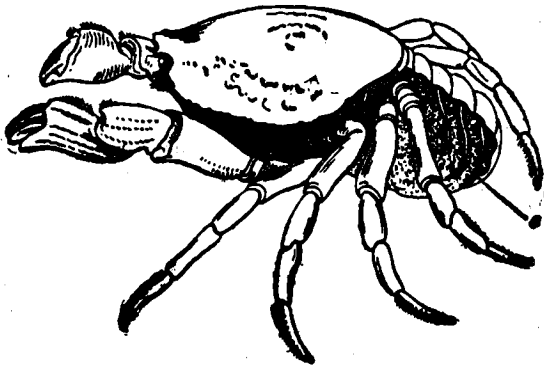

FIG. 1.—Side view of Crab (Morse), the abdomen extended and carrying a mass of eggs beneath it; *e*, eggs.

broad and flattened third pair of foot-jaws. The abdomen is usually narrow and triangular in the males, but in the females it is broad and rounded and bears appendages to which the eggs are attached after spawning (fig. 1).

As in most Crustacea, the young of nearly all crabs, when newly hatched, are very different from their parents. The first

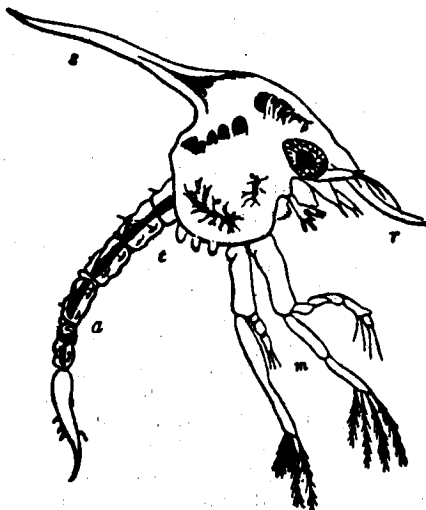

FIG. 2.—Zoëa of Common Shore-Crab in its second stage. *r*, Rostral spine; *s*, Dorsal spine; *m*, Maxillipeds; *t*, Buds of thoracic feet; *a*, Abdomen. (Spence Bate.)

larval stage is known as a Zoëa, this name having been given to it when it was believed by naturalists to be a distinct and independent species of animal. The Zoëa is a minute transparent organism, swimming at the surface of the sea. It has a rounded body, armed with long spines, and a long segmented tail. The eyes are large but not set on stalks, the legs are not yet developed, and the foot-jaws form swimming paddles. After casting its skin several times as it grows in size, the young crab passes into a stage known as the *Megalopa* (fig. 2), also formerly regarded as

an independent animal, in which the body and limbs are more crab-like, but the abdomen is large and not filled up. After a

further moult the animal assumes a form very similar to that of the adult. There are a few crabs, living on land or in fresh water, which do not pass through a metamorphosis but leave the egg as miniature adults.

Most crabs live in the sea, and even the land-crabs, which are abundant in tropical countries, nearly all visit the sea occasionally and pass through their early stages in it. Many shore-crabs living between tide-marks are more or less amphibious, and the river-crab of southern Europe or Lenten crab (*Potamon edule*, better known as *Thelphusa fluviatilis*) is an example of the fresh-water crabs which are abundant in most of the warmer regions of the world. As a rule, crabs breathe by gills, which are lodged in a pair of cavities at the sides of the carapace, but in the true land-crabs the cavities become enlarged and modified so as to act as lungs for breathing air.

Walking or crawling is the usual mode of locomotion, and the peculiar sidelong gait familiar to most people in the common shore-crab, is characteristic of most members of the group. The crabs of the family *Portunidae*, and some others, swim with great dexterity by means of their flattened paddle-shaped feet.

Like many other Crustacea, crabs are often omnivorous and act as the scavengers of the sea, but many are predatory in their habits and some are content with a vegetable diet.

Though no crab, perhaps, is truly parasitic, some live in relations of "commensalism" with other animals. The best known examples of this are the little "mussel-crabs" (*Pinnotheridae*) which live within the shells of mussels and other bivalve mollusca and probably share the food of their hosts. Some crabs live among corals, and one species at least gives rise to hollow swellings on the branches of a coral like the "galls" which are formed on plants by certain insects. Another crab (*Melia tessellata*) carries in each of its claws a living sea-anemone which it uses as an animated weapon of defence and an implement for the capture of prey. Many of the sluggish spider-crabs (*Maididae*) have their shells covered by a forest of growing sea-weeds, zoophytes and sponges, which are "planted" there by the crab itself, and which afford it a very effective disguise.

Many of the larger crabs are sought for as food by man. The most important and valuable are the edible crab of British and European coasts (*Cancer pagurus*) and the blue crab of the Atlantic coast of the United States (*Callinectes sapidus*).

Among the *Anomura*, the best known are the hermit-crabs, which live in the empty shells of Gasteropod Mollusca, which they carry about with them as portable dwellings. In these, the abdomen is soft-skinned and spirally twisted so as to fit into the shells which they inhabit. The common hermit-crab of the British coasts (*Pagurus* or *Eupagurus Bernhardus*) is sometimes called the soldier-crab from its pugnacity. Small specimens are found between tide-marks inhabiting the shells of periwinkles and other small molluscs, but the full-grown specimens live in deeper water and are usually found in the shell of the whelk (*Buccinum*). As the crab grows it changes its dwelling from time to time, often having to fight with its fellows for the possession of an empty shell. Sometimes an annelid worm lives inside the shell along with the hermit and often the outside is covered with zoophytes. In some species, as in the British *Eupagurus prideauxi*, a sea-anemone is constantly found attached to the shell, profiting by the active locomotion of the crab and probably sharing the crumbs of its food, while it affords its host protection by its stinging powers.

In tropical countries the hermit-crabs of the family *Coenobitidae* live on land, often at considerable distances from the sea, to which, however, they return for the purpose of hatching out their spawn. The large robber-crab or cocoa-nut crab of the Indo-Pacific islands (*Birgus latro*), which belongs to this family, has given up the habit of carrying a portable dwelling, and the upper surface of its abdomen has become covered by shelly plates. The stories of its climbing palm-trees to get the fruit were long doubted, but it has been seen, and even photographed in the act. (W. T. CA.)

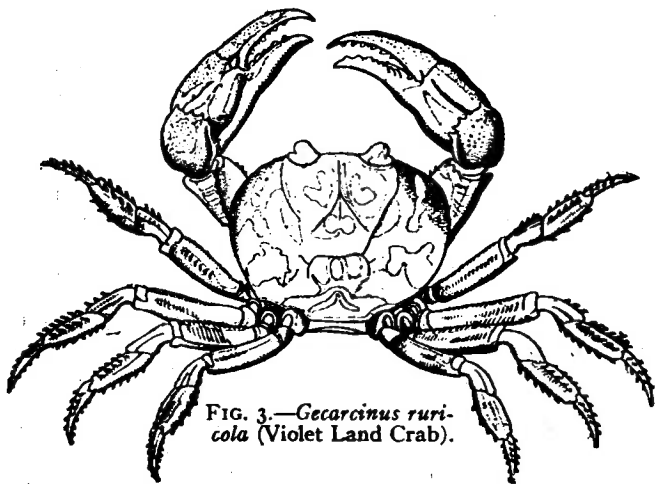

FIG. 3.—*Gecarcinus ruficola* (Violet Land Crab).

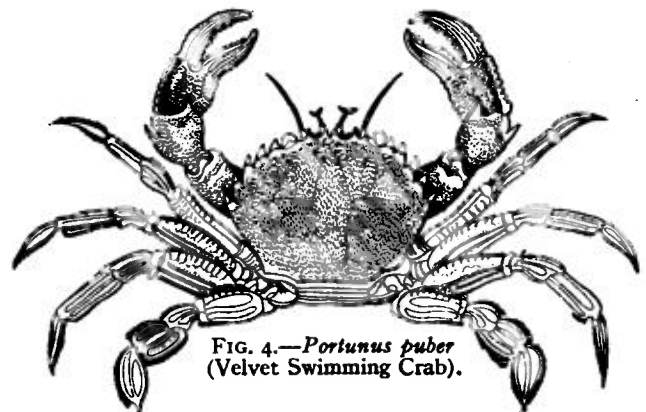

FIG. 4.—*Portunus puber* (Velvet Swimming Crab).

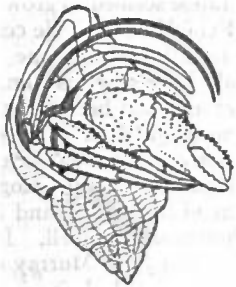

FIG. 6.—*Eupagurus Bernhardus* (Soldier Crab).

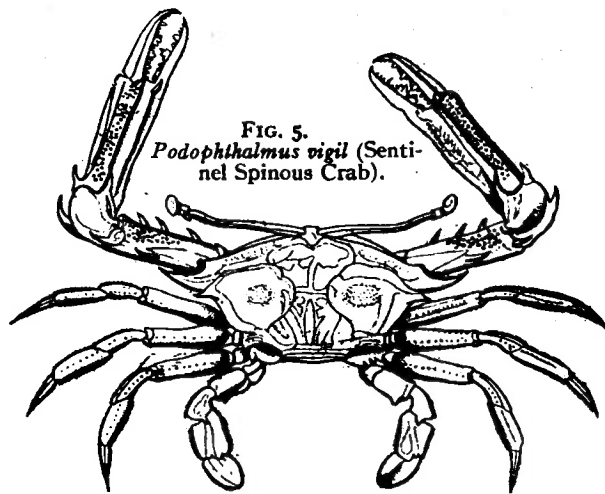

FIG. 5.—*Podophthalmus vigil* (Sentinel Spinous Crab).



FIG. 7.—*Pinnotheres pisum* (Pea Crab).

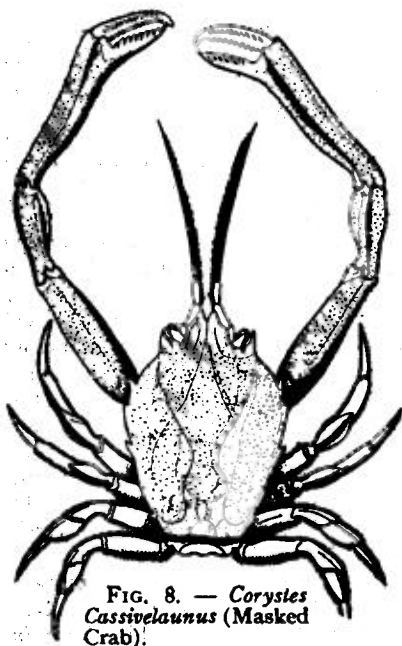

FIG. 8.—*Corystes Cassivelaunus* (Masked Crab).

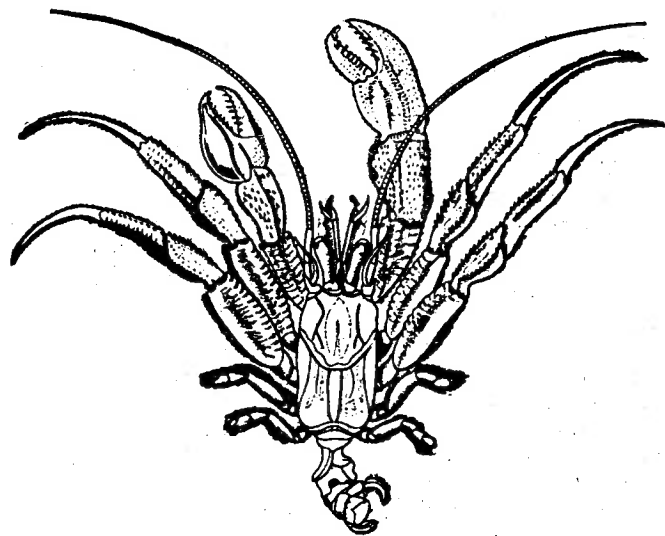

FIG. 9.—*Eupagurus angulatus* (a Hermit Crab).



**CRABBE, GEORGE** (1754-1832), English poet, was born at Aldeburgh in Suffolk on the 24th of December 1754. His family was partly of Norfolk, partly of Suffolk origin, and the name was doubtless originally derived from "crab." His grandfather, Robert Crabbe, was the first of the family to settle at Aldeburgh, where he held the appointment of collector of customs. He died in 1734, leaving one son, George, who practised many occupations, including that of a schoolmaster, in the adjoining village of Orford. Finally the poet's father obtained a small post in the customs of Aldeburgh, married Mary Lodwick, the widow of a publican, and had six children, of whom George was the eldest.

The sea has swept away the small cottage that was George Crabbe's birthplace, but one may still visit the quay at Slaughden, some half-mile from the town, where the father worked and the son was at a later date to work with him. At first attending a dame's school in Aldeburgh, when nine or ten years of age he was sent to a boarding-school at Bungay, and at twelve to a school at Stowmarket, where he remained two years. His father dreamt of the medical profession for his clever boy, and so in 1768 he went to Wickham Brook near Newmarket as an apothecary's assistant. In 1771 we find him assisting a surgeon at Woodbridge, and it was while here that he met Sarah Elmy. Crabbe was now only eighteen years of age, but he became "engaged" to this lady in 1772. It was not until 1783 that the pair were married. The intervening years were made up of painful struggle, in which, however, not only the affection but the purse of his betrothed assisted him. About the time of Crabbe's return from Woodbridge to Aldeburgh he published at Ipswich his first work, a poem entitled *Inebriety* (1775). He found his father fallen on evil days. There was no money to assist him to a partnership, and surgery for the moment seemed out of the question. For a few weeks Crabbe worked as a common labourer, rolling butter casks on Slaughden quay. Before the year was out, however, the young man bought on credit "the shattered furniture of an apothecary's shop and the drugs that stocked it." This was at Aldeburgh. A year later Crabbe installed a deputy in the surgery and paid his first visit to London. He lodged in Whitechapel, took lessons in midwifery and walked the hospitals. Returning to Aldeburgh after nine months—in 1777—he found his practice gone. Even as a doctor for the poor he was an utter failure, poetry having probably taken too firm a hold upon his mind. At times he suffered hunger, so utterly unable was he to earn a livelihood. After three years of this, in 1780 Crabbe paid his second visit to London, enabled thereto by the loan of five pounds from Dudley Lang, a local magnate. This visit to London, which was undertaken by sea on board the "Unity" smack, made for Crabbe a successful career. His poem *The Candidate*, issued soon after his arrival, helped not at all. For a time he almost starved, and was only saved, it is clear, by gifts of money from his sweetheart Sarah Elmy. He importuned the great, and the publishers also. Everywhere he was refused, but at length a letter which reached Edmund Burke in March 1781 led to the careful consideration on the part of that great man of Crabbe's many manuscripts. Burke advised the publication of *The Library*, which appeared in 1781. He invited him to Beaconsfield, and made interest in the right quarters to secure Crabbe's entry into the church. He was ordained in December 1781 and was appointed curate to the rector of Aldeburgh.

Crabbe was not happy in his new post. The Aldeburgh folk could not reverence as priest a man they had known as a day labourer. Crabbe again appealed to Burke, who persuaded the duke of Rutland to make him his chaplain (1782), and Crabbe took up his residence in Belvoir Castle, accompanying his new patron to London, when Lord Chancellor Thurlow (who told him he was "as like Parson Adams as twelve to the dozen") gave him the two livings of Frome St Quentin and Evershot in Dorsetshire, worth together about £200 a year. In May 1783 Crabbe's poem *The Village* was published by Dodsley, and in December of this year he married Sarah Elmy. Crabbe continued his duties as ducal chaplain, being in the main a non-resident priest so far as his Dorsetshire parishes were concerned. In 1785 he published *The Newspaper*. Shortly after this he moved

with his wife from Belvoir Castle to the parsonage of Stathern, where he took the duties of the non-resident vicar Thomas Parke, archdeacon of Stamford. Crabbe was at Stathern for four years. In 1789, through the persuasion of the duchess of Rutland (now a widow, the duke having died in Dublin as lord-lieutenant of Ireland in 1787), Thurlow gave Crabbe the two livings of Muston in Leicestershire and West Allington in Lincolnshire. At Muston parsonage Crabbe resided for twelve years, divided by a long interval. He had been four years at Muston when his wife inherited certain interests in a property of her uncle's that placed her and her husband in possession of Ducking Hall, Parham, Suffolk. Here he took up his residence from 1793 to 1796, leaving curates in charge of his two livings. In 1796 the loss of their son Edmund led the Crabbes to remove from Parham to Great Glemham Hall, Suffolk, where they lived until 1801. In that year Crabbe went to live at Rendham, a village in the same neighbourhood. In 1805 he returned to Muston. In 1807 he broke a silence of more than twenty years by the publication of *The Parish Register*, in 1810 of *The Borough*, and in 1812 of *Tales in Verse*. In 1813 Crabbe's wife died, and in 1814 he was given the living of Trowbridge, Wiltshire, by the duke of Rutland, a son of his early patron, who, it is interesting to recall, wanted the living of Muston for a cousin of Lord Byron. From 1814 to his death in 1832 Crabbe resided at Trowbridge.

These last years were the most prosperous of his life. He was a constant visitor to London, and in friendship with all the literary celebrities of the time. "Crabbe seemed to grow young again," remarks his biographer, M. René Huchon. He certainly carried on a succession of mild flirtations, and one of his parishioners, Charlotte Ridout, would have married him. The elderly widower had proposed to her and had been accepted in 1814, but he drew out of the engagement in 1816. He proposed to yet another friend, Elizabeth Charter, somewhat later. In his visits to London Crabbe was the guest of Samuel Rogers, in St James's Place, and was a frequent visitor to Holland House, where he met his brother poets Moore and Campbell. In 1817 his *Tales of the Hall* were completed, and John Murray offered £3000 for the copyright, Crabbe's previous works being included. The offer after much negotiation was accepted, but Crabbe's popularity was now on the wane.

In 1822 Crabbe went to Edinburgh on a visit to Sir Walter Scott. The adventure, complicated as it was by the visit of George IV. about the same time, is most amusingly described in Lockhart's biography of Scott, although one episode—that of the broken wine-glass—is discredited by Crabbe's biographer, M. Huchon. Crabbe died at Trowbridge on the 3rd of February 1832, and was buried in Trowbridge church, where an ornate monument was placed over his tomb in August 1833.

Never was any poet at the same time so great and continuous a favourite with the critics, and yet so conspicuously allowed to fall into oblivion by the public. All the poets of his earlier and his later years, Cowper, Scott, Byron, Shelley in particular, have been reprinted again and again. With Crabbe it was long quite otherwise. His works were collected into eight volumes, the first containing his life by his son, in 1832. The edition was intended to continue with some of his prose writings, but the reception of the eight volumes was not sufficiently encouraging. A reprint, however, in one volume was made in 1847, and it has been reproduced since in 1854, 1867 and 1901. The exhaustion of the copyright, however, did no good for Crabbe's reputation, and it was not until the end of the century that sundry volumes of "selections" from his poems appeared; Edward FitzGerald, of Omar Khayyám fame, always a loyal admirer, made a "Selection," privately printed by Quaritch, in 1879. A "Selection" by Bernard Holland appeared in 1899, another by C. H. Herford in 1902 and a third by Deane in 1903. The *Complete Works* were published by the Cambridge University Press in three volumes, edited by A. W. Ward, in 1906.

Crabbe's poems have been praised by many competent pens, by Edward FitzGerald in his *Letters*, by Cardinal Newman in his *Apologia*, and by Sir Leslie Stephen in his *Hours in a Library*, most notably. His verses comforted the last hours of Charles

James Fox and of Sir Walter Scott, while Thomas Hardy has acknowledged their influence on the realism of his novels. But his works have ceased to command a wide public interest. He just failed of being the artist in words who is able to make the same appeal in all ages. Yet to-day his poems will well repay perusal. His stories are profoundly poignant and when once read are never forgotten. He is one of the great realists of English fiction, for even considered as a novelist he makes fascinating reading. He is more than this: for there is true poetry in Crabbe, although his most distinctively lyric note was attained when he wrote under the influence of opium, to which he became much addicted in his later years.

**BIBLIOGRAPHY.**—*The Works of Crabbe* (8 vols., Murray, 1834; 1 vol., Murray, 1901), and the *Works* in the Cambridge Press Classics, edited by A. W. Ward (1906), have already been referred to. The life by Crabbe's son in one volume, *The Life of the Rev. George Crabbe, L.L.B.*, by his son the Rev. George Crabbe, A.M. (1834), has not been separately reprinted as it deserves to be. A recent biography is *George Crabbe and His Times, 1754-1832; A Critical and Biographical Study*, by René Huchon, translated from the French by Frederick Clarke (1907). Brief biographies by T. H. Keibel ("Great Writers" series) and by Canon Ainger ("English Men of Letters" series) also deserve attention. (C. K. S.)

**CRACKER** (from "crack," a common Teutonic word, cf. Ger. *krachen*, Dutch *kraken*, meaning to break with a sharp sound), that which "cracks"; it is, therefore, applied (1) to a firework so constructed that it explodes with several reports and jumps at each explosion, when placed on the ground (see FIREWORKS); (2) to a roll of coloured and ornamented paper containing sweets, small articles of cheap jewelry, paper caps and other trifles, together with a strip of card with a fulminant which explodes with a "crack" on being pulled; (3) to a thin crisp biscuit (*q.v.*); in America the general name for a biscuit. In the southern states of America, "cracker" is a term of contempt for the "poor" or "mean whites," particularly of Georgia and Florida; the term is an old one and dates back to the Revolution, and is supposed to be derived from the "cracked corn" which formed the staple food of the class to whom the term refers.

**CRACOW** (Pol. *Kraków*; Ger. *Krakau*), a town and episcopal see of Austria, in Galicia, 212 m. W. by N. of Lemberg by rail. Pop. (1900) 91,310, of which 21,000 were Jews, 5000 Germans and the remainder Poles. Although in regard to its population it is only the second place in Galicia, Cracow is the most interesting town in the whole of Poland. No other Polish town possesses so many old and historic buildings, none of them contains so many national relics, or has been so closely associated with the development and destinies of Poland as Cracow. And the ancient capital is still the intellectual centre of the Polish nation.

Cracow is situated in a fertile plain on the left bank of the Vistula (which becomes navigable here) and occupies a position of great strategical importance. It consists of the old inner town and seven suburbs. The only relics of the fortifications of the old town, whose place is now occupied by shady promenades, is the Florian's Gate and the Rondell, a circular structure, built in 1498. Cracow has 39 churches—about half the number it formerly had—and 25 convents for monks and nuns. Of these the most important is the Stanislaus cathedral, in Gothic style, consecrated in 1359, and built on the Wawel, the rocky eminence to the S.W. of the old town. Here the kings of Poland were crowned, and this church is also the Pantheon of the Polish nation, the burial place of its kings and its great men. Here lie the remains of John Sobieski, of Thaddeus Kosciuszko, of Joseph Poniatowski and of Adam Mickiewicz. Here also are conserved the remains of St Stanislaus, the patron saint of the Poles, who, as bishop of Cracow, was slain before the altar by King Boleslaus in 1079. The cathedral is adorned with many valuable objects of art, paintings and sculptures, by such artists as Veit Stoss, Guido Reni, Peter Vischer, Thorwaldsen, &c. Part of the ancient Polish regalia is also kept here. The Gothic church of St Mary, founded in 1223, rebuilt in the 14th century with several chapels added in the 15th and 16th centuries, was restored in 1889-1893, and decorated with paintings from the designs by Matejko. It contains a huge high altar, the masterpiece of Veit Stoss, who was a native of Cracow, executed in

1477-1489; a colossal stone crucifix, dating from the end of the 15th century, and several sumptuous tombs of noble families from the 16th and 17th centuries. The Dominican church, a Gothic building of the 13th century, but practically rebuilt after a fire in 1850; the Franciscan church, also of the 13th century, also much modernized; the church of St Florian of the 12th century, rebuilt in 1768, which contains the late-Gothic altar by Veit Stoss, executed in 1518, during his last sojourn in Cracow; the church of St Peter, with a colossal dome, built in 1597, after the model of that of St Peter at Rome, and the beautiful Augustinian church in the suburb of Kazimierz, are all worth mentioning. Of the principal secular buildings, the royal castle (*Zamek Królewski*), a huge building, begun in the 13th century, and successively enlarged by Casimir the Great and by Sigismund I. Jagiello (1510-1533), is situated on the Wawel, and was until 1610 the residence of the Polish kings. It suffered much from fires and other disasters, and from 1846 onward was used as a barracks and a military hospital; it has now, however, been cleared out and restored. The Jagellonian university, now housed in a magnificent Gothic building erected in 1881-1887, was attended in 1901 by 1255 students, and had 175 professors and lecturers. The language of instruction is Polish. It is the second oldest university in Europe—the oldest being that of Prague—and was famous during the 15th and 16th centuries. It was founded by Casimir the Great in 1364, and completed by Ladislaus Jagiello in 1400. Its rich library is now housed in the old university buildings, erected in the 15th century, in the beautiful Gothic court of which a bronze statue of Copernicus was placed in 1900. The Polish Academy of Science, founded in 1872, is housed in the new university buildings. In the Ring-Platz, or the principal square, opposite the church of St Mary, is the *Tuchhaus* (cloth-hall, Pol. *Sukiennice*), a building erected in 1257, several times renovated and enlarged, most recently in 1879, which contains the Polish national museum of art. Behind it is a Gothic tower, the only relic of the old town hall, demolished in 1820. The Czartoryski museum contains a large collection of objects of art, a rich library and a precious collection of manuscripts, relating to the history of Poland.

Among the manufactures of the town are machinery, agricultural implements, chemicals, soap, tobacco, &c. But Cracow is more important as a trading than as an industrial centre. Its position on the Vistula and at the junction of several railways makes it the natural mart for the exchange of the products of Silesia, Hungary and Russian and Austrian Poland. Its trade in timber, salt, textiles, cattle, wine and agricultural produce of all kinds is very considerable. In the neighbourhood of Cracow there are mines of coal and zinc, and not far away lies the village of Krzeszowice with sulphur baths. About 2½ m. N.W. lies the Kosciuszko Hill, a mound of earth 100 ft. high, thrown up in 1820-1823 on the Borislava hill (1093 ft.), in honour of Thaddeus Kosciuszko, the hero of Poland. On the opposite bank of the Vistula, united to Cracow by a bridge, lies the town of Podgorze (pop. 18,142); near it is the Krakus Hill, smaller than the Kosciuszko Hill, and a thousand years older than it, erected in honour of Krakus, the founder of Cracow. About 8 m. S.E. of Cracow is situated Wieliczka (*q.v.*), with its famous salt mines.

**History.**—Tradition assigns the foundation of Cracow to the mythical Krak, a Polish prince who is said to have built a stronghold here about A.D. 700. Its early history is, however, entirely obscure. In the latter part of the 10th century it was annexed to the Bohemian principality, but was recaptured by Boleslaus Chrobry, who made it the seat of a bishopric, and it became the capital of one of the most important of the principalities into which Poland was divided from the 12th century onwards. The city was practically ruined during the first Tatar invasion in 1241, but the introduction of German colonists restored its prosperity, and in 1257 it received "Magdeburg rights," i.e. a civic constitution modelled on that of Magdeburg. In this year the *Tuchhalle* was built. The town, however, had yet to pass through many vicissitudes. It suffered again from Tatar invasions; in 1290 it was captured by Wenceslaus II. of Bohemia and was held by the Bohemians until, in 1305, the Polish king

Ladislaus Lokietek recovered it from Wenceslaus III. Ladislaus made it his capital, and from this time until 1764 it remained the coronation and burial place of the Polish kings, even after the royal residence had been removed by Siegmund III. (1587-1632) to Warsaw. On the third partition of Poland in 1795 Austria took possession of Cracow; but in 1809 Napoleon wrested it from that power, and incorporated it with the duchy of Warsaw, which was placed under the rule of the king of Saxony. In the campaign of 1812 the emperor Alexander made himself master of this and the other territory which formed the duchy of Warsaw. At the general settlement of the affairs of Europe by the great powers in 1815, it was agreed that Cracow and the adjoining territory should be formed into a free state; and, by the Final Act of the congress signed at Vienna in 1815, "the town of Cracow, with its territory, is declared to be forever a free, independent and strictly neutral city, under the protection of Russia, Austria and Prussia." In February 1846, however, an insurrection broke out in Cracow, apparently a ramification of a widely spread conspiracy throughout Poland. The senate and the other authorities of Cracow were unable to subdue the rebels or to maintain order, and, at their request, the city was occupied by a corps of Austrian troops for the protection of the inhabitants. The three powers, Russia, Austria and Prussia, made this a pretext for extinguishing this independent state; and as the outcome of a conference at Vienna (November 1846) the three courts, contrary to the assurance previously given, and in opposition to the expressed views of the British and French governments, decided to extinguish the state of Cracow and to incorporate it with the dominions of Austria.

**CRADDOCK, CHARLES EGBERT** (1850- ), the pen-name of MARY NOAILLES MURFREE, American author, who was born near Murfreesboro, Tennessee, on the 24th of January 1850, the great-granddaughter of Col. Hardy Murfree. She was crippled in childhood by paralysis. She attended school in Nashville and Philadelphia. Spending her summers in the mountains of eastern Tennessee, she came to know the primitive people there with whose life her writings deal. She contributed to *Appleton's Journal*, and, first in 1878, to *The Atlantic Monthly*. No one, apparently, suspected that the author of these stories was a woman, and her identity was not disclosed until 1885, a year after the publication of her first volume of short stories, *In the Tennessee Mountains*. She deals mainly with the narrow, stern life of the Tennessee mountaineers, who, left behind in the advance of civilization, live amid traditions and customs, and speak a dialect, peculiarly their own; and her work abounds in exquisite descriptions of scenery. Among her other books are: *Where the Battle was Fought* (1884), a novel dealing with the old aristocratic southern life; *Down the Ravine* (1885) and *The Story of Keodon Bluffs* (1887) for young people; *The Prophet of the Great Smoky Mountains* (1885), a novel; *In the Clouds* (1886), a novel; *The Despot of Broomsedge Cove* (1888), a novel; *In the "Stranger-People's" Country* (1891); *His Vanished Star* (1894), a novel; *The Mystery of Witch-Face Mountain and Other Stories* (1895); *The Phantoms of the Footbridge and Other Stories* (1895); *The Young Mountaineers* (1897), short stories; *The Juggler* (1897); *The Story of Old Fort Loudon* (1899); *The Bushwhackers and Other Stories* (1899); *The Champion* (1902); *A Spectre of Power* (1903); *The Frontiersman* (1904); *The Storm Centre* (1905); *The Amulet* (1906); *The Windfall* (1907); and *Fair Mississippian* (1908).

**CRADLE** (of uncertain etymology, possibly connected with "crate" and "creel," i.e. basket; the derivation from a Celtic word, with a sense of rocking, is scouted by the *New English Dictionary*), a child's bed of wood, wicker or iron, with enclosed sides, slung upon pivots or mounted on rockers. It is a very ancient piece of furniture, but the date when it first assumed its characteristic swinging or rocking form is by no means clear. A miniature in an illuminated *Histoire de la belle Héloïse* in the Bibliothèque Nationale in Paris (end of the 14th or beginning of the 15th century) shows an infant sleeping in a tiny four-post bed slung upon rockers. In its oldest forms the cradle is an oblong oak box without a lid—originally the rockers appear to

have been detachable—but, like all other household appliances, it has been subject to changes of fashion alike in shape and adornment. It has been panelled and carved, supported on Renaissance pillars, inlaid with marqueterie or mounted in gilded bronze. The original simple shape persisted for two or three centuries—even the hood made its appearance very early. In the 18th century, however, cradles were often very elaborate—indeed in France they had begun to be so much earlier, but the richly carved and upholstered examples were used chiefly for purposes of state, being in fact miniature *lits de parade*. In modern times they have become lighter and simpler, the old hood being very often replaced by a draped curtain dependent from a carved or shaped upright. About the middle of the 19th century iron cradles were introduced, along with iron bedsteads. A number of undoubted historic cradles have been preserved, together with many others with doubtful attributions. Two alleged cradles of Henry V. exist; one which claims to have been used by the unhappy earl of Derwentwater is in the Victoria and Albert Museum in London; the other is at Windsor Castle. That of Henry IV. of France, now in the Château de Pau, is mounted upon a large tortoiseshell. That of the king of Rome ("Napoleon II.") was designed by Prud'hon, and along with that of the comte de Chambord is preserved in the Garde Meuble. In England a cradle is now often called a "bassinet" (i.e. little basket), and the "cot" has to some extent taken its place. By analogy, the word "cradle" is also applied to various sorts of framework in engineering, and to a rocking-tool used in engraving.

**CRADDOCK**, a town of South Africa, capital of a division of the Cape province, in the upper valley of the Great Fish river, 181 m. by rail N. by E. of Port Elizabeth. Pop. (1904) 7762. It is one of the chief centres of the wool industry of the Cape, and does also a large trade in ostrich feathers, mohair, &c. The town enjoys a reputation as one of the best health resorts in the province. It stands at an altitude of 2856 ft.; the climate is very dry, the average annual rainfall being 14.50 in. The mean maximum temperature is 77.6° F. Three miles N. of the town are sulphur baths (temp. 100° F.) used for the treatment of rheumatism. In the neighbouring district survive a few herds of zebras, now protected by the game laws. The town dates from the beginning of the 19th century and is named after Sir John Craddock, governor of the Cape 1811-1813. The division has an area of 3048 sq. m. and a pop. (1904) of 18,803, of whom 41% are white.

**CRAFT** (a word common to Teutonic languages for strength, or power; cf. Ger. *Kraft*), a word confined in English only, of the Teutonic languages in which it occurs, to intellectual power, and used as a synonym of "art." It then means skill or ingenuity, especially in the manual arts, hence its use in the expression "Arts and Crafts" (*q.v.*), and it is thus applied to the trade or profession in which such skill is displayed, to an association of workmen of a particular trade, a trade guild, and in particular to Freemasons, "the craft"; the word appears also in words such as "handicraft" or "craftsman." Skill applied to outwit or deceive gives the common sense of cunning or trickery, and it is this meaning which is implied in such combined words as "priestcraft," "witchcraft" and the like. A more particular use of the word is in the nautical sense of vessels of transport by water; this is probably a colloquially shortened form either of "vessels of a fisherman's, lighterman's &c., craft," i.e. "art," or of "vessels of a heavier or lighter craft," i.e. burden or capacity; in both cases the qualifying words are dropped and the word comes to be used of vessels in general.

**CRAG** (a Celtic word, cf. Gael. *creag*, Manx *creg*, and Welsh and modern Scots *craig*), a steep rock. The word appears in many place-names in the north of England and in Scotland, and is also connected with "carrick," a word of similar meaning, also found in place-names. In geology, the term is applied to the strata in which a shelly sand deposit is found, and, in the expression "crag and tail," to a formation of hills, in which one side is precipitous and lofty and the other slopes or "tails" gradually away, as in the Castle Rock in Edinburgh.

**CRAGGS, JAMES** (1657–1721), English politician, was a son of Anthony Craggs of Holbeck, Durham, and was baptized on the 10th of June 1657. After following various callings in London, Craggs, who was a person of considerable financial ability, entered the service of the duchess of Marlborough, and through her influence became in 1702 member of parliament for Gram-pound, retaining his seat until 1713. He was in business as an army clothier and held several official positions, becoming joint postmaster-general in 1715; and, making the most of his opportunities in all these capacities, he amassed a great deal of money. Craggs also increased his wealth by mixing in the affairs of the South Sea Company, but after his death an act of parliament confiscated all the property which he had acquired since December 1719. He left an enormous fortune when he died on the 16th of March 1721. It is possible that Craggs committed suicide.

His son, **JAMES CRAGGS** the younger (1686–1721), was born at Westminster on the 9th of April 1686. Part of his early life was spent abroad, where he made the acquaintance of George Louis, elector of Hanover, afterwards King George I. In 1713 he became member of parliament for Tregoney, in 1717 secretary-at-war, and in the following year one of the principal secretaries of state. Craggs was implicated in the South Sea Bubble, but not so deeply as his father, whom he predeceased, dying on the 16th of February 1721. Among Craggs's friends were Pope, who wrote the epitaph on his monument in Westminster Abbey, Addison and Gay.

**CRAIG, JOHN** (1512?–1600), Scottish reformer, born about 1512, was the son of Craig of Craigston, Aberdeenshire, who was killed at Flodden in 1513. After an education at St Andrews, and acting as tutor to the children of Lord Darcy, the English warden of the North, he became a Dominican, but was soon in trouble as a heretic. In 1536 he made his way to England, but failing to obtain the preferment he desired at Cambridge, he went on to Italy, where the influence of Cardinal Pole, who was himself accused of heresy, secured him the post of master of the novices in the Dominican convent at Bologna. For some years he was busy travelling in the Levant in the interests of his order, but a perusal of Calvin's *Institutes* revived his heretical tendencies, and he was condemned to be burnt. Like the English scholar and statesman, Thomas Wilson, he owed his escape to the riot which broke out on the death of Paul IV. on the 18th of August 1559, when the mob burst open the prison of the Inquisition. After various adventures he reached Vienna, where he preached, and was protected by the semi-Lutheran archduke (afterwards the emperor) Maximilian II.

In 1560 he returned to Scotland, where in 1561 he was ordained minister of Holyrood, and in 1562 Knox's colleague in the High Church. His defence of church property and privilege against the predatory instincts of the nobles and the pretensions of the state brought him into conflict with Lethington and others; but he seems to have condoned, if he was not privy to, Riccio's murder. At first he refused to publish the banns of marriage between Mary and Bothwell, though in the end he yielded with a protest that he "abhorred and detested the marriage." He had been associated with Knox in various commissions for the organization of the church, but he wished to compromise between the two extreme parties. From 1571–1579 Craig was in the north, whither he had been sent to "illuminate those dark places in Mar, Buchan and Aberdeen." In 1579 he was appointed chaplain to the young James VI., and returned to Edinburgh. In 1581 episcopacy was abolished as a result of the report of a commission on which Craig had sat; he also assisted at the composition of the *Second Book of Discipline* and the National Covenant of 1580, and in 1581 compiled "Ane Shorte and Generale Confession" called the "King's Confession," which was imposed on all parish ministers and graduates and became the basis of the Covenant of 1638. He approved of the Ruthven raid, and admonished James in terms which made him weep, but produced no alteration in his conduct, and before long Craig was denouncing the supremacy of Arran. But he was averse from the violence of Melville, and was willing to admit the royal supremacy "as far as the word of God

allows." James VI., like Henry VIII., accepted this compromise, and the oath in this form was taken by Craig, the royal chaplains and some others. In 1592 was published Craig's *Catechism*. He died on the 12th of December 1600.

See T. G. Law's Pref. to Craig's *Catechism* (1885); Bain's *Cal. Scottish State Papers*; Reg. P. C. Scotl.; Hew Scott's *Fasti Eccles. Scot.*; Knox's, Calderwood's and Grub's *Eccles. Histories*; McCrie's *Life of Melville*; Hay Fleming's *Mary, Queen of Scots*; Bannatyne's *Memorials*. (A. F. P.)

**CRAIG, SIR THOMAS** (c. 1538–1608), Scottish jurist and poet, was born about 1538. It is probable that he was the eldest son of William Craig of Craigfintray, or Craigston, in Aberdeenshire, but beyond the fact that he was in some way related to the Craigfintray family nothing regarding his birth is known with certainty. He was educated at St Andrews, where he took the B.A. degree in 1555. From St Andrews he went to France, to study the canon and the civil law. He returned to Scotland about 1561, and was admitted advocate in February 1563. In 1564 he was appointed justice-depute by the justice-general, Archibald, earl of Argyll; and in this capacity he presided at many of the criminal trials of the period. In 1573 he was appointed sheriff-depute of Edinburgh, and in 1606 procurator for the church. He never became a lord of session, a circumstance that was unquestionably due to his own choice. It is said that he refused the honour of knighthood which the king wished to confer on him in 1604, when he came to London as one of the Scottish commissioners regarding the union between the kingdoms—the only political object he seems to have cared about; but in accordance with James's commands he has always been styled and reputed a knight. Craig was married to Helen, daughter of Heriot of Lumpfroy in Midlothian, by whom he had four sons and three daughters. His eldest son, Sir Lewis Craig (1569–1622), was raised to the bench in 1604, and among his other descendants are several well-known names in the list of Scottish lawyers. He died on the 26th of February 1608.

Except his poems, the only one of Craig's works which appeared during his lifetime was his *Jus feudale* (1603; ed. R. Burnet, 1655; Leipzig, 1716; ed. J. Baillie 1732). The object of this treatise was to assimilate the laws of England and Scotland, but, instead of this, it was an important factor in building up and solidifying the law of Scotland into a separate system. Other works were *De unione regnorum Britanniae tractatus*, *De jure successionis regni Angliæ* and *De hominio disputatio*. Translations of the last two have been published, and in 1910 an edition of the *De Unione* appeared, with translation and notes by C. S. Terry. Craig's first poem, an *Epithalamium* in honour of the marriage of Mary queen of Scots and Darnley, appeared in 1565. Most of his poems have been reprinted in the *Delitiae poetarum Scotorum*.

See P. F. Tytler, *Life of Craig* (1823); Life prefixed to Baillie's edition of the *Jus feudale*.

**CRAIGIE, PEARL MARY TERESA** (1867–1906), Anglo-American novelist and dramatist, who wrote under the pen-name of "JOHN OLIVER HOBBS," was born at Boston, U.S.A., on the 3rd of November 1867. She was the elder daughter of John Morgan Richards, and was educated in London and Paris. When she was nineteen she married Reginald Walpole Craigie, by whom she had one son, John Churchill Craigie; but the marriage proved an unhappy one, and was dissolved on her petition in July 1895. She was brought up as a Nonconformist, but in 1892 was received into the Roman Catholic Church, of which she remained a devout and serious member. Her first little book, the brilliant and epigrammatic *Some Emotions and a Moral*, was published in 1891 in Mr Fisher Unwin's "Pseudonym Library," and was followed by *The Sinner's Comedy* (1892), *A Study in Temptations* (1893), *A Bundle of Life* (1894), *The Gods, Some Mortals, and Lord Wickenham*. *The Herb Moon* (1896), a country love story, was followed by *The School for Saints* (1897), with a sequel, *Robert Orange* (1900). Mrs Craigie had already written a one-act "proverb," *Journeys end in Lovers Meeting*, produced by Ellen Terry in 1894, and a three-act tragedy, "Osbern and Ursyne," printed in the *Anglo-Saxon Review* (1899), when her successful piece, *The Ambassador*, was produced at the St James's Theatre in 1898. *A Repentance* (one

act, 1899) and *The Wisdom of the Wise* (1900) were produced at the same theatre, and *The Flute of Pan* (1904) first at Manchester and then at the Shaftesbury theatre; she was also part author of *The Bishop's Move* (Garrick Theatre, 1902). Later books are *The Serious Wooing* (1901), *Love and the Soul Hunters* (1902), *Tales about Temperament* (1902), *The Vineyard* (1904). Mrs Craigie died suddenly of heart failure in London on the 13th of August 1906.

**CRAIK, DINAH MARIA** (1826-1887), English novelist, better known by her maiden name of Mulock, and still better as "the author of *John Halifax, Gentleman*," was the daughter of Thomas Mulock, an eccentric religious enthusiast of Irish extraction, and was born on the 20th of April 1826 at Stoke-upon-Trent, in Staffordshire, where her father was the minister of a small congregation. She settled in London about 1846, determined to obtain a livelihood by her pen, and, beginning with fiction for children, advanced steadily until *John Halifax, Gentleman* (1857), placed her in the front rank of the women novelists of her day. *A Life for a Life* (1859), though inferior, maintained a high position, but she afterwards wrote little of importance except some very charming tales for children. Her most remarkable novels, after those mentioned above, were *The Oglevias* (1849), *Olive* (1850), *The Head of the Family* (1851), *Agatha's Husband* (1853). There is much passion and power in these early works, and all that Mrs Craik wrote was characterized by high principle and deep feeling. Some of the short stories in *Avillion and other Tales* also exhibit a fine imagination. She published some poems distinguished by genuine lyrical spirit, narratives of tours in Ireland and Cornwall, and *A Woman's Thoughts about Women*. She married Mr G. L. Craik, a partner in the house of Macmillan & Company, in 1864, and died at Shortlands, near Bromley, Kent, on the 12th of October 1887.

**CRAIK, GEORGE LILLIE** (1798-1866), English man of letters, the son of a schoolmaster, was born at Kennoway, Fifeshire, in 1798. He studied at the university of St Andrews with the intention of entering the church, but, altering his plans, became the editor of a local newspaper, and went to London in 1824 to devote himself to literature. He became connected with a short-lived literary paper called the *Verulam*; in 1831 he published his *Pursuit of Knowledge under Difficulties* among the works of the Society for the Diffusion of Useful Knowledge; he contributed a considerable number of biographical and historical articles to the *Penny Cyclopaedia*; and he edited the *Pictorial History of England*, himself writing much of the work. In 1844 he published his *History of Literature and Learning in England from the Norman Conquest to the Present Time*, illustrated by extracts. Craik is best known for his abridged version of this work, *The History of English Literature and the English Language* (1861), which passed through several editions. In the next year appeared his *Spenser and his Poetry*, an abstract of Spenser's poems, with historical and biographical notes and frequent quotations; and in 1847 his *Bacon, his Writings and his Philosophy*, a work of a similar kind. The two last-mentioned works appeared among *Knight's Weekly Volumes*. Two years later Craik obtained the chair of history and English literature at Queen's College, Belfast, a position which he held till his death, which took place on the 25th of June 1866. He had married Miss Jeannette Dempster (d. 1856) in 1826, and his daughter, Georgiana Marion Craik (Mrs A. W. May), wrote over thirty novels, of which *Lost and Won* (1859) was the best. Besides the works already noticed, Craik published the *History of British Commerce from the Earliest Times* (1844), *Romance of the Peerage* (1848-1850) and *The English of Shakespeare* (1856).

**CRAIL** (formerly **KAREL**), a royal and police burgh of Fifeshire, Scotland, 2 m. from Fife Ness, the most easterly point of the county, and 11 m. S.E. of St Andrews by the North British railway, but 2 m. nearer by road. Pop. (1901) 1077. It is said to have been a town of some note as early as the 9th century; and its castle, of which there are hardly any remains, was the residence of David I. and other Scottish kings. It was constituted a royal burgh by a charter of Robert Bruce in 1306, and had its privileges confirmed by Robert II. in 1371, by Mary in 1553, and by Charles I. in 1635. Of its priory, dedicated to

St Rufus, a few ruins still exist. The church of **Maclrubha**, the patron saint of Crail, is an edifice of great antiquity. Many of the ordinary houses are massive and quaint. The public buildings include a library and reading-room and town hall. The chief industries comprise fisheries, especially for crabs, shipping and brewing. It is growing in favour as a summer resort. It unites with St Andrews, the two Anstruthers, Kilrenny, Pittenweem and Cupar in returning one member to parliament.

Balcomie Castle, about 2 m. to the N.E., dates from the 14th century. Here Mary of Guise landed in 1538, a few days before her marriage to James V. in St Andrews cathedral. In the 18th century it passed through the hands of various proprietors and was ultimately shorn of much of its original size and grandeur. The East Neuk is a term applied more particularly to the country round Fife Ness, and more generally to all of the peninsula east of an imaginary line drawn from St Andrews to Elie. For fully half the year the cottages of its villages are damp with the haar, or dense mist, borne on the east wind from the North Sea.

**CRAILSHEIM**, or **KRAILSHEIM**, a town of Germany, in the kingdom of Württemberg, on the Jagst, a tributary of the Neckar, at the junction of railways to Heilbronn and Fürth. Pop. (1900) 5251. There are two Evangelical churches and a Roman Catholic church, and a handsome town hall, with a tower 225 ft. high. The industrial establishments include extensive tanneries and machine workshops, and there is a brisk trade in cattle and agricultural produce.

Crailsheim was incorporated as a town in 1338, successfully withstood a siege by the forces of several Swabian imperial cities (1379-1380), a feat which is annually celebrated, passed later into the possession of the burgraves of Nuremberg, and came in 1791 to Prussia, in 1806 to Bavaria and 1810 to Württemberg.

**CRAIOVA**, or **KRAJOVA**, the capital of the department of Doljiu, Rumania, situated near the left bank of the river Jiu, and on the main Walachian railway from Verciorova to Bucharest. Pop. (1900) 45,438. A branch railway to Calafat facilitates the export trade with Bulgaria. Craiova is the chief commercial town west of Bucharest; the surrounding uplands are very rich in grain, pasturage and vegetable products, and contain extensive forests. The town has rope and carriage factories, and close by is a large tannery, worked by convict labour, and supplying the army. The principal trade is in cattle, cereals, fish, linen, pottery, glue and leather. In the town, which is the headquarters of the First Army Corps, there are military and commercial academies, an appeal court and a chamber of commerce, besides many churches, Greek Orthodox, Roman Catholic, and Protestant, with synagogues for the Jews.

Craiova, which occupied the site of the Roman Castra Nova, was formerly the capital of Little Walachia. Its ancient bans or military governors were, next to the princes, the chief dignitaries of Walachia, and the district is still styled the banat of Craiova. Among the holders of this office were Michael the Brave (1593-1601), and several members of the celebrated Bassarab family (q.v.). The bans had the right of coining money stamped with their own effigies, and hence arose the name of *bani* (centimes). The Rumanian franc, or *leu* ("lion"), so called from the image it bore, came likewise from Craiova. In 1397 Craiova was the scene of a victory won by Prince Mircea over Bayezid I. sultan of the Turks; and in October 1853, of an engagement between Turks and Russians.

**CRAMBO**, an old rhyming game which, according to Strutt (*Sports and Pastimes*), was played as early as the 14th century under the name of the *ABC of Aristotle*. In the days of the Stuarts it was very popular, and is frequently mentioned in the writings of the time. Thus Congreve's *Love for Love*, i. 1, contains the passage, "Get the Maids to Crambo in an Evening, and learn the knack of Rhyming." Crambo, or capping the rhyme, is now played by one player thinking of a word and telling the others what it rhymes with, the others not naming the actual word they guess but its meaning. Thus one says "I know a word that rhymes with *bird*." A second asks "Is it ridiculous?" "No, it is not absurd." "Is it a part of speech?" "No, it is not a word." This proceeds until the right word is guessed.



In *Dumb Crambo* the guessers, instead of naming the word, express its meaning by dumb show, a rhyme being given them as a clue.

**CRAMER, JOHANN BAPTIST** (1771-1858), English musician, of German extraction, was born in Mannheim, on the 24th of February 1771. He was the son of Wilhelm Cramer (1743-1799), a famous London violinist and musical conductor, one of a numerous family who were identified with the progress of music during the 18th and 19th centuries. Johann Baptist was brought to London as a child, and it was in London that the greater part of his musical efforts was exercised. From 1782 to 1784 he studied the pianoforte under Muzio Clementi, and soon became known as a professional pianist both in London and on the continent; he enjoyed a world-wide reputation, and was particularly appreciated by Beethoven. He died in London on the 16th of April 1858. Apart from his pianoforte-playing Cramer is important as a composer, and as principal founder in 1824 of the London music-publishing house of Cramer & Co. He wrote a number of sonatas, &c., for pianoforte, and other compositions; but his *Études* is the work by which he lives as a composer. These "studies" have appeared in numerous editions, from 1810 onwards, and became the staple pieces in the training of pianists.

**CRAMER, JOHN ANTONY** (1793-1848), English classical scholar and geographer, was born at Mitlödi in Switzerland. He was educated at Westminster and Christ Church, Oxford. He resided in Oxford till 1844, during which time he held many important offices, being public orator, principal of New Inn Hall (which he rebuilt at his own expense), and professor of modern history. In 1844 he was appointed to the deanery of Carlisle, which he held until his death at Scarborough on the 24th of August 1848. His works are of considerable importance: *A Dissertation on the Passage of Hannibal over the Alps*, published anonymously with H. L. Wickham (2nd ed., 1828), "a scholar-like work of first-rate ability"; geographical and historical descriptions of *Ancient Italy* (1826), *Ancient Greece* (1828), *Asia Minor* (1832); *Travels of Nicander Nucius of Corcyra* [Greek traveller of the 16th century] in England (1841); *Catenae Graecorum Patrum in Novum Testamentum* (1838-1844); *Anecdota Graeco* (from the MSS. of the royal library in Paris, 1839-1841).

**CRÄMER, KARL VON** (1818-1902), Bavarian politician, had a very remarkable career, rising gradually from a mere workman in a factory at Doos near Nuremberg to the post of manager, and finally becoming part proprietor of the establishment. Leaving business in 1870 he devoted his time entirely to politics. From 1848 he had been a member of the Bavarian second chamber, at first representing the district of Erlangen-Fürth, and afterwards Nuremberg, which city also sent him after the war of 1866 as its deputy to the German customs parliament, and from 1871 to 1874 to the first German *Reichstag*. He sat in these bodies as a member of the Progressive party (*Fortschrittspartei*), and in Bavaria was one of the leaders of the Liberal (*Freisinnige*) party. His eloquence had a great hold upon the masses. As a parliamentarian he was very clear-headed, and thoroughly understood how to lead a party. For many years he was the reporter of the finance committee of the chamber. In 1882, on account of his great services in connexion with the Bavarian National Exhibition of Nuremberg, the order of the crown of Bavaria was conferred upon him, carrying with it the honour of nobility. He died at Nuremberg on the 31st of December 1902.

**CRAMP, CHARLES HENRY** (1828- ), American ship-builder, was born in Philadelphia, Pennsylvania, on the 9th of May 1828, of German descent, his family name having been Krampf. He was the eldest of eleven children of William Cramp (1807-1869), a pioneer American shipbuilder, who in 1830 established shipyards on the Delaware river near Philadelphia. The son was educated at the Philadelphia Central high school, after which he was employed in his father's shipyards and made himself master of every detail of ship construction. He showed especial aptitude as a naval architect and designer, and after becoming his father's partner in 1849 it was to that branch of

the work that he devoted himself. His inventive capacity and resourcefulness, together with the complete success of his innovations in naval construction, soon gave him high rank as an authority on shipbuilding, and made his influence in that industry widely felt. In the Mexican War he designed surf boats for the landing of troops at Vera Cruz; during the Civil War he designed and built several ironclads for the United States navy, notably the "New Ironsides" in 1862, and the light-draught monitors used in the Carolina sounds; and after 1887 constructed wholly or in part from his own designs many of the most powerful ships in the "new" navy, including the cruisers "Columbia," "Minneapolis" and "Brooklyn," and the battleships "Indiana," "Iowa," "Massachusetts," "Alabama" and "Maine." In every progressive step in ocean shipbuilding, in the transformation from sail to steam, and from wood to iron and steel, Cramp had a prominent part. His fame as a shipbuilder extended to Europe, and he built warships for several foreign navies, among others the "Retvizan" and the "Variag" for the Russian government. He also constructed a number of freight and passenger steamships for several trans-Atlantic lines.

See A. C. Buel, *Memoirs of C. H. Cramp* (Philadelphia, 1906).

**CRAMP**, a painful spasmodic contraction of muscles, most frequently occurring in the limbs, but also apt to affect certain internal organs. This disorder belongs to the class of diseases known as local spasms, of which other varieties exist in such affections as spasmodic asthma and colic. The cause of these painful seizures resides in the nervous system, and operates either directly from the great nerve centres, or, as is generally the case, indirectly by reflex action, as, for example, when attacks are brought on by some derangement of the digestive organs.

In its most common form, that of cramp in the limbs, this disorder comes on suddenly, often during sleep, the patient being aroused by an agonizing feeling of pain in the calf of the leg or back of the thigh, accompanied in many instances with a sensation of sickness or faintness from the intensity of the suffering. During the paroxysm the muscular fibres affected can often be felt gathered up into a hard knot. The attack in general lasts but a few seconds, and then suddenly departs, the spasmodic contraction of the muscles ceasing entirely, or, on the other hand, relief may come more gradually during a period of minutes or even hours. A liability to cramp is often associated with a rheumatic or gouty tendency, but occasional attacks are common enough apart from this, and are often induced by some peculiar posture which a limb has assumed during sleep. Exposure of the limbs to cold will also bring on cramp, and to this is probably to be ascribed its frequent occurrence in swimmers. Cramp of the extremities is also well known as one of the most distressing accompaniments of cholera. It is likewise of frequent occurrence in the process of parturition, just before delivery.

This painful disorder can be greatly relieved and often entirely removed by firmly grasping or briskly rubbing the affected part with the hand, or by anything which makes an impression on the nerves, such as warm applications. Even a sudden and vigorous movement of the limb will often succeed in terminating the attack.

What is termed cramp of the stomach, or gastralgia, usually occurs as a symptom in connexion with some form of gastric disorder, such as aggravated dyspepsia, or actual organic disease of the mucous membrane of the stomach.

The disease known as *Writer's Cramp*, or *Scrivener's Palsy*, is a spasm which affects certain muscles when engaged in the performance of acts, the result of education and long usage, and which does not occur when the same muscles are employed in acts of a different kind. This disorder owes its name to the relative frequency with which it is met in persons who write much, although it is by no means confined to them, but is liable to occur in individuals of almost any handicraft. It was termed by Dr Duchenne *Functional Spasm*.

The symptoms are in the first instance a gradually increasing difficulty experienced in conducting the movements required for executing the work in hand. Taking, for example, the case of writers, there is a feeling that the pen cannot be moved with

the same freedom as before, and the handwriting is more or less altered in consequence. At an early stage of the disease the difficulty may be to a large extent overcome by persevering efforts, but ultimately, when the attempt is persisted in, the muscles of the fingers, and occasionally also those of the forearm, are seized with spasm or cramp, so that the act of writing is rendered impossible. Sometimes the fingers, instead of being cramped, move in a disorderly manner and the pen cannot be grasped, while in other rare instances a kind of paralysis affects the muscles of the fingers, and they are powerless to make the movements necessary for holding the pen. It is to be noted that it is only in the act of writing that these phenomena present themselves, and that for all other movements the fingers and arms possess their natural power. The same symptoms are observed and the same remarks apply *mutatis mutandis* in the case of musicians, artists, composers, seamstresses, tailors and many mechanics in whom this affection may occur. Indeed, although actually a rare disease, no muscle or group of muscles in the body which is specially called into action in any particular occupation is exempt from liability to this functional spasm.

The exact pathology of writer's cramp has not been worked out, but it is now generally accepted that the disease is not a local one of muscles or nerves, but that it is an affection of the central nervous system. The complaint never occurs under thirty years of age, and is more frequent in males than females. Occasionally there is an inherited tendency to the disease, but more usually there is a history of alcoholism in the parents, or some neuropathic heredity. In its treatment the first requisite is absolute cessation from the employment which caused it. Usually, however, complete rest of the arm is undesirable, and recovery takes place more speedily if other actions of a different kind are regularly practised. If a return to the same work is a necessity, then Sir W. R. Gowers insists on some modification of method in performing the act, as writing from the shoulder instead of the wrist.

**CRAMP-RINGS**, rings anciently worn as a cure for cramp and "falling-sickness" or epilepsy. The legend is that the first one was presented to Edward the Confessor by a pilgrim on his return from Jerusalem, its miraculous properties being explained to the king. At his death it passed into the keeping of the abbot of Westminster, by whom it was used medically and was known as St Edward's Ring. From that time the belief grew that the successors of Edward inherited his powers, and that the rings blessed by them worked cures. Hence arose the custom for the successive sovereigns of England each year on Good Friday formally to bless a number of cramp-rings. A service was held; prayers and psalms were said; and water "in the name of the Father, Son and Holy Ghost" was poured over the rings, which were always of gold or silver, and made from the metal that the king offered to the Cross on Good Friday. The ceremony survived to the reign of Queen Mary, but the belief in the curative powers of similar circlets of sacred metal has lingered on even to the present day.

For an account of the ceremony see F. G. Waldron, *The Literary Museum* (London, 1792); see also *Notes and Queries*, vol. vii., 1853; vol. ix., 1878.

**CRANACH, LUCAS** (1472-1553), German painter, was born at Cronach in upper Franconia, and learnt the art of drawing from his father. It has not been possible to trace his descent or the name of his parents. We are not informed as to the school in which he was taught, and it is a mere guess that he took lessons from the south German masters to whom Mathew Grunewald owed his education. But Grunewald practised at Bamberg and Aschaffenburg, and Bamberg is the capital of the diocese in which Cronach lies. According to Gunderam, the tutor of Cranach's children, Cranach signalized his talents as a painter before the close of the 15th century. He then drew upon himself the attention of the elector of Saxony, who attached him to his person in 1504. The records of Wittenberg confirm Gunderam's statement to this extent that Cranach's name appears for the first time in the public accounts on the 24th of June 1504, when he drew 50 gulden for the salary of half a year, as *pictor ducalis*.

The only clue to Cranach's settlement previous to his Wittenberg appointment is afforded by the knowledge that he owned a house at Gotha, and that Barbara Brengbier, his wife, was the daughter of a burgher of that city.

Of his skill as an artist we have sufficient evidence in a picture dated 1504. But as to the development of his manner prior to that date we are altogether in ignorance. In contrast with this obscurity is the light thrown upon Cranach after 1504. We find him active in several branches of his profession,—sometimes a mere house-painter, more frequently producing portraits and altar-pieces, a designer on wood, an engraver of copper-plates, and draughtsman for the dies of the electoral mint. Early in the days of his official employment he startled his master's courtiers by the realism with which he painted still life, game and antlers on the walls of the country palaces at Coburg and Lochau; his pictures of deer and wild boar were considered striking, and the duke fostered his passion for this form of art by taking him out to the hunting field, where he sketched "his grace" running the stag, or Duke John sticking a boar. Before 1508 he had painted several altar-pieces for the Schlosskirche at Wittenberg in competition with Dürer, Burgkmair and others; the duke and his brother John were portrayed in various attitudes and a number of the best woodcuts and copper-plates were published. Great honour accrued to Cranach when he went in 1509 to the Netherlands, and took sittings from the emperor Maximilian and the boy who afterwards became Charles V. Till 1508 Cranach signed his works with the initials of his name. In that year the elector gave him the winged snake as a motto, and this motto or *Kleinod*, as it was called, superseded the initials on all his pictures after that date. Somewhat later the duke conferred on him the monopoly of the sale of medicines at Wittenberg, and a printer's patent with exclusive privileges as to copyright in Bibles. The presses of Cranach were used by Luther. His chemist's shop was open for centuries, and only perished by fire in 1871. Relations of friendship united the painter with the Reformers at a very early period; yet it is difficult to fix the time of his first acquaintance with Luther. The oldest notice of Cranach in the Reformer's correspondence dates from 1520. In a letter written from Worms in 1521, Luther calls him his gossip, warmly alluding to his "Gevatterin," the artist's wife. His first engraved portrait by Cranach represents an Augustinian friar, and is dated 1520. Five years later the friar dropped the cowl, and Cranach was present as "one of the council" at the betrothal festival of Luther and Catherine Bora. The death at short intervals of the electors Frederick and John (1525 and 1532) brought no change in the prosperous situation of the painter; he remained a favourite with John Frederick I., under whose administration he twice (1537 and 1540) filled the office of burgomaster of Wittenberg. But 1547 witnessed a remarkable change in these relations. John Frederick was taken prisoner at the battle of Mühlberg, and Wittenberg was subjected to stress of siege. As Cranach wrote from his house at the corner of the market-place to the grand-master Albert of Brandenburg at Königsberg to tell him of John Frederick's capture, he showed his attachment by saying, "I cannot conceal from your Grace that we have been robbed of our dear prince, who from his youth upwards has been a true prince to us, but God will help him out of prison, for the Kaiser is bold enough to revive the Papacy, which God will certainly not allow." During the siege Charles bethought him of Cranach, whom he remembered from his childhood and summoned him to his camp at Pistritz. Cranach came, reminded his majesty of his early sittings as a boy, and begged on his knees for kind treatment to the elector. Three years afterwards, when all the dignitaries of the Empire met at Augsburg to receive commands from the emperor, and when Titian at Charles's bidding came to take the likeness of Philip of Spain, John Frederick asked Cranach to visit the Swabian capital; and here for a few months he was numbered amongst the household of the captive elector, whom he afterwards accompanied home in 1552. He died on the 16th of October 1553 at Weimar, where the house in which he lived still stands in the market-place.

The oldest extant picture of Cranach, the "Rest of the Virgin

during the Flight into Egypt," marked with the initials L. C., and the date of 1504, is by far the most graceful creation of his pencil. The scene is laid on the margin of a forest of pines, and discloses the habits of a painter familiar with the mountain scenery of Thuringia. There is more of gloom in landscapes of a later time; and this would point to a defect in the taste of Cranach, whose stag hunts are otherwise not unpleasing. Cranach's art in its prime was doubtless influenced by causes which but slightly affected the art of the Italians, but weighed with potent consequence on that of the Netherlands and Germany. The business of booksellers who sold woodcuts and engravings at fairs and markets in Germany naturally satisfied a craving which arose out of the paucity of wall-paintings in churches and secular edifices. Drawing for woodcuts and engraving of copper-plates became the occupation of artists of note, and the talents devoted in Italy to productions of the brush were here monopolized for designs on wood or on copper. We have thus to account for the comparative unproductiveness as painters of Dürer and Holbein, and at the same time to explain the shallowness apparent in many of the later works of Cranach; but we attribute to the same cause also the tendency in Cranach to neglect effective colour and light and shade for strong contrasts of flat tint. Constant attention to mere contour and to black and white appears to have affected his sight, and caused those curious transitions of pallid light into inky grey which often characterize his studies of flesh; whilst the mere outlining of form in black became a natural substitute for modelling and chiaroscuro. There are, no doubt, some few pictures by Cranach in which the flesh-tints display brightness and enamelled surface, but they are quite exceptional. As a composer Cranach was not greatly gifted. His ideal of the human shape was low; but he showed some freshness in the delineation of incident, though he not unfrequently bordered on coarseness. His copper-plates and woodcuts are certainly the best outcome of his art; and the earlier they are in date the more conspicuous is their power. Striking evidence of this is the "St Christopher" of 1506, or the plate of "Elector Frederick praying before the Madonna" (1509). It is curious to watch the changes which mark the development of his instincts as an artist during the struggles of the Reformation. At first we find him painting Madonnas. His first woodcut (1505) represents the Virgin and three saints in prayer before a crucifix. Later on he composes the marriage of St Catherine, a series of martyrdoms, and scenes from the Passion. After 1517 he illustrates occasionally the old gospel themes, but he also gives expression to some of the thoughts of the Reformers. In a picture of 1518 at Leipzig, where a dying man offers "his soul to God, his body to earth, and his worldly goods to his relations," the soul rises to meet the Trinity in heaven, and salvation is clearly shown to depend on faith and not on good works. Again sin and grace become a familiar subject of pictorial delineation. Adam is observed sitting between John the Baptist and a prophet at the foot of a tree. To the left God produces the tables of the law, Adam and Eve partake of the forbidden fruit, the brazen serpent is reared aloft, and punishment supervenes in the shape of death and the realm of Satan. To the right, the Conception, Crucifixion and Resurrection symbolize redemption, and this is duly impressed on Adam by John the Baptist, who points to the sacrifice of the crucified Saviour. There are two examples of this composition in the galleries of Gotha and Prague, both of them dated 1529. One of the latest pictures with which the name of Cranach is connected is the altarpiece which Cranach's son completed in 1555, and which is now in the *Stadtkirche* (city church) at Weimar. It represents Christ in two forms, to the left trampling on Death and Satan, to the right crucified, with blood flowing from the lance wound. John the Baptist points to the suffering Christ, whilst the blood-stream falls on the head of Cranach, and Luther reads from his book the words, "The blood of Christ cleanseth from all sin." Cranach sometimes composed gospel subjects with feeling and dignity. "The Woman taken in Adultery" at Munich is a favourable specimen of his skill, and various repetitions of Christ receiving little children show the kindness of his disposition. But he was not

exclusively a religious painter. He was equally successful, and often comically naïve, in mythological scenes, as where Cupid, who has stolen a honeycomb, complains to Venus that he has been stung by a bee (Weimar, 1530; Berlin, 1534), or where Hercules sits at the spinning-wheel mocked by Omphale and her maids. Humour and pathos are combined at times with strong effect in pictures such as the "Jealousy" (Augsburg, 1527; Vienna, 1530), where women and children are huddled into telling groups as they watch the strife of men wildly fighting around them. Very realistic must have been a lost canvas of 1545, in which hares were catching and roasting sportsmen. In 1546, possibly under Italian influence, Cranach composed the "Fons Juventutis" of the Berlin Gallery, executed by his son, a picture in which hags are seen entering a Renaissance fountain, and are received as they issue from it with all the charms of youth by knights and pages.

Cranach's chief occupation was that of portrait-painting, and we are indebted to him chiefly for the preservation of the features of all the German Reformers and their princely adherents. But he sometimes condescended to depict such noted followers of the papacy as Albert of Brandenburg, archbishop elector of Mainz, Anthony Granvelle and the duke of Alva. A dozen likenesses of Frederick III. and his brother John are found to bear the date of 1532. It is characteristic of Cranach's readiness, and a proof that he possessed ample material for mechanical reproduction, that he received payment at Wittenberg in 1533 for "sixty pairs of portraits of the elector and his brother" in one day. Amongst existing likenesses we should notice as the best that of Albert, elector of Mainz, in the Berlin museum, and that of John, elector of Saxony, at Dresden.

Cranach had three sons, all artists:—John Lucas, who died at Bologna in 1536; Hans Cranach, whose life is obscure; and Lucas, born in 1515, who died in 1586.

See Heller, *Leben und Werke Lukas Cranachs* (2nd ed., Bamberg, 1844); Chr. Schuchard, *Lukas Cranachs des älteren Leben und Werke* (3 vols., Leipzig, 1851–1871); Warnecke, *Cranach der ältere* (Görlitz, 1879); M. B. Lindau, *Lucas Cranach* (1883); Lippmann, *Lukas Cranach, Sammlung, &c.* (Berlin, 1895), reproductions of his most notable woodcuts and engravings; Woermann, *Verzeichnis der Dresdener Cranach-Ausstellung von 1899* (Dresden, 1899); Flechsig, *Tafelbilder Cranach's des älteren und seiner Werkstatt* (Leipzig, 1900); Muther, *Lukas Cranach* (Berlin, 1902); Michaelson, *L. Cranach der ältere* (Leipzig, 1902). (J. A. C.)

**CRANBERRY**, the fruit of plants of the genus *Oxycoccus*, (natural order Vacciniaceae), often considered part of the genus *Vaccinium*. *O. palustris* (or *Vaccinium Oxycoccus*), the common cranberry plant, is found in marshy land in northern and central Europe and North America. Its stems are wiry, creeping and of varying length; the leaves are evergreen, dark and shining above, glaucous below, revolute at the margin, ovate, lanceolate or elliptical in shape, and not more than half an inch long; the flowers, which appear in May or June, are small and stalked, and have a four-lobed, rose-tinted corolla, purplish filaments, and anther-cells forming two long tubes. The berries ripen in August and September; they are pear-shaped and about the size of currants, are crimson in colour and often spotted, and have an acid and astringent taste. The American species, *O. macrocarpus*, is found wild from Maine to the Carolinas. It attains a greater size than *O. palustris*, and bears bigger and finer berries, which are of three principal sorts, the *cherry* or round, the *bugle* or oblong, and the *pear* or bell-shaped, and vary in hue from light pink to dark purple, or may be mottled red and white. *O. erythrocarpus* is a species indigenous in the mountains from Virginia to Georgia, and is remarkable for the excellent flavour of its berry.

Air and moisture are the chief requisites for the thriving of the cranberry plant. It is cultivated in America on a soil of peat or vegetable mould, free from loam and clay, and cleared of turf, and having a surface layer of clean sand. The sand, which needs renewal every two or three years, is necessary for the vigorous existence of the plants, and serves both to keep the underlying soil cool and damp, and to check the growth of grass and weeds. The ground must be thoroughly drained, and should be provided with a supply of water and a dam for flooding the plants during

winter to protect them from frost, and occasionally at other seasons to destroy insect pests; but the use of spring water should be avoided. The flavour of the fruit is found to be improved by growing the plants in a soil enriched with well-rotted dung, and by supplying them with less moisture than they obtain in their natural habitats. Propagation is effected by means of cuttings, of which the wood should be wiry in texture, and the leaves of a greenish-brown colour. In America, where, in the vicinity of Cape Cod, Massachusetts, the cultivation of the cranberry commenced early in the present century, wide tracts of waste land have been utilized for that purpose—low, easily flooded, marshy ground, worth originally not more than from \$10 to \$20 an acre, having been made to yield annually \$200 or \$300 worth of the fruit per acre. The yield varies between 50 and 400 bushels an acre, but 100 bushels, or about 35 barrels, is estimated to be the average production when the plants have begun to bear well. The approximate cranberry crop of the United States from 1890 to 1899 varied from 410,000 to 1,000,000 bushels.

Cranberries should be gathered when ripe and dry, otherwise they do not keep well. The darkest-coloured berries are those which are most esteemed. The picking of the fruit begins in New Jersey in October, at the close of the blackberry and whortleberry season, and often lasts until the coming in of cold weather. From 3 to 4 bushels a day may be collected by good workers. New York, Philadelphia, Boston and Baltimore are the leading American markets for cranberries, whence they are exported to the West Indies, England and France in great quantities. England was formerly supplied by Lincolnshire and Norfolk with abundance of the common cranberry, which it now largely imports from Sweden and Russia. The fruit is much used for pies and tarts, and also for making an acid summer beverage. The cowberry, or red whortleberry, *Vaccinium Vitis-Idaea*, is sometimes sold for the cranberry. The Tasmanian and the Australian cranberries are the produce respectively of *Astroloma humifusum* and *Lissanthe sapida*, plants of the order *Epacridaceae*.

For literature of the subject see the *Proceedings of the American Cranberry Growers' Association* (Trenton, N. J.). There is a good article on the American cranberry in L. H. Bailey's *Cyclopaedia of American Horticulture* (1900).

**CRANBROOK, GATHORNE GATHORNE-HARDY, 1ST EARL OF** (1814-1906), British statesman, was born at Bradford on the 1st of October 1814, the son of John Hardy, and belonged to a Yorkshire family. Entering upon active political life in 1847, eleven years after his graduation at Oxford, and nine years after his call to the bar, he offered himself as a candidate for Bradford, but was unsuccessful. In 1856 he was returned for Leominster, and in 1865 defeated Mr Gladstone at Oxford. In 1866 he became president of the Poor Law Board in Lord Derby's new administration. When in 1867 Mr Walpole resigned, from dissatisfaction with Mr Disraeli's Reform Bill, Mr Hardy succeeded him at the home office. In 1874 he was secretary for war; and when in 1878 Lord Salisbury took the foreign office upon the resignation of Lord Derby, Viscount Cranbrook (as Mr Hardy became within a month afterwards) succeeded him at the India office. At the same time he had assumed the additional family surname of Gathorne, which had been that of his mother. In Lord Salisbury's administrations of 1885 and 1886 Lord Cranbrook was president of the council, and upon his retirement from public life concurrently with the resignation of the cabinet in 1892 he was raised to an earldom. He died on the 30th of October 1906, being succeeded as 2nd earl by his son John Stewart Gathorne-Hardy, previously known as Lord Medway (b. 1839), who from 1868 to 1880 sat in parliament as a conservative for Rye, and from 1884 to 1892 for a division of Kent.

See *Gathorne Hardy, 1st earl of Cranbrook, a memoir with extracts from his correspondence*, edited by the Hon. A. E. Gathorne-Hardy (1910).

**CRANBROOK**, a market-town in the southern parliamentary division of Kent, England, 45 m. S.E. of London on a branch of the South-Eastern & Chatham railway from Paddock Wood. Pop. (1901) 3949. It lies on the Crane brook, a feeder of the river Beult, in a pleasant district, hilly and well wooded. It has

a fine church (mainly Perpendicular) dedicated to St Dunstan, which is remarkable for a baptistry, built in the early part of the 18th century, and some ancient stained glass. As the centre of the agricultural district of the Kentish Weald, it carries on an extensive trade in malt, hops and general goods; but its present condition is in striking contrast to the activity it displayed from the 14th to the 17th century, when it was one of the principal seats of the broadcloth manufacture. Remains of some of the old factories still exist. The town has a grammar school of Elizabethan foundation, which now ranks as one of the smaller public schools. In the neighbourhood are the ruins of the old mansion house of Sissinghurst, or Saxenhurst, built in the time of Edward VI.

**CRANDALL, PRUDENCE** (1803-1889), American school-teacher, was born, of Quaker parentage, at Hopkinton, Rhode Island, on the 3rd of September 1803. She was educated in the Friends' school at Providence, R. I., taught school at Plainfield, Conn., and in 1831 established a private academy for girls at Canterbury, Windham county, Connecticut. By admitting a negro girl she lost her white patrons, and in March 1833, on the advice of William Lloyd Garrison and Samuel J. May (1797-1871), she opened a school for "young ladies and little misses of colour." For this she was bitterly denounced, not only in Canterbury but throughout Connecticut, and was persecuted, boycotted and socially ostracized; measures were taken in the Canterbury town-meeting to break up the school, and finally in May 1833 the state legislature passed the notorious Connecticut "Black Law," prohibiting the establishment of schools for non-resident negroes in any city or township of Connecticut, without the consent of the local authorities. Miss Crandall, refusing to submit, was arrested, tried and convicted in the lower courts, whose verdict, however, was reversed on a technicality by the court of appeals in July 1834. Thereupon the local opposition to her redoubled, and she was finally in September 1834 forced to close her school. Soon afterward she married the Rev. Calvin Philleo. She died at Elk Falls, Kansas, on the 28th of January 1889. The Connecticut Black Law was repealed in 1838. Miss Crandall's attempt to educate negro girls at Canterbury attracted the attention of the whole country; and the episode is of considerable significance as showing the attitude of a New England community toward the negro at that time.

See J. C. Kimball's *Connecticut Canterbury Tale* (Hartford, Conn., 1889), and Samuel J. May's *Recollections of Our Anti-Slavery Conflict* (Boston, 1869).

**CRANE, STEPHEN** (1870-1900), American writer, was born at Newark, New Jersey, on the 1st of November 1870, and was educated at Lafayette College and Syracuse University. His first story, *Maggie, a Girl of the Streets*, was published in 1891, but his greatest success was made with *The Red Badge of Courage* (1896), a brilliant and highly realistic, though of course imaginary, description of the experiences of a private in the Civil War. He was also the author of various other stories, and acted as a war correspondent in the Greco-Turkish War (1897) and the Spanish American War (1898). His health became seriously affected in Cuba, and on his return he settled down in England. He died at Badenweiler, Germany, on the 5th of June 1900.

**CRANE, WALTER** (1845- ), English artist, second son of Thomas Crane, portrait painter and miniaturist, was born in Liverpool on the 15th of August 1845. The family soon removed to Torquay, where the boy gained his early artistic impressions, and, when he was twelve years old, to London. He early came under the influence of the Pre-Raphaelites, and was a diligent student of Ruskin. A set of coloured page designs to illustrate Tennyson's "Lady of Shalott" gained the approval of William James Linton, the wood-engraver, to whom Walter Crane was apprenticed for three years (1859-1862). As a wood-engraver he had abundant opportunity for the minute study of the contemporary artists whose work passed through his hands, of Rossetti, Millais, Tenniel and F. Sandys, and of the masters of the Italian Renaissance, but he was more influenced by the Elgin marbles in the British Museum. A further and important element in the development of his talent, was the study of

Japanese colour-prints, the methods of which he imitated in a series of toy-books, which started a new fashion. In 1862 a picture of his, "The Lady of Shalott," was exhibited at the Royal Academy, but the Academy steadily refused his maturer work; and after the opening of the Grosvenor Gallery in 1877 he ceased to send pictures to Burlington House. In 1864 he began to illustrate for Mr Edmund Evans, the colour printer, a series of sixpenny toy-books of nursery rhymes, displaying admirable fancy and beauty of design, though he was limited to the use of three colours. He was allowed more freedom in a delightful series begun in 1873, *The Frog Prince, &c.*, which showed markedly the influence of Japanese art, and of a long visit to Italy following on his marriage in 1871. *The Baby's Opera* was a book of English nursery songs planned in 1877 with Mr Evans, and a third series of children's books with the collective title, *A Romance of the Three R's*, provided a regular course of instruction in art for the nursery. In his early "Lady of Shalott" the artist had shown his preoccupation with unity of design in book illustration by printing in the words of the poem himself, in the view that this union of the calligrapher's and the decorator's art was one secret of the beauty of the old illuminated books. He followed the same course in *The First of May: A Fairy Masque* by his friend John R. Wise, text and decoration being in this case reproduced by photogravure. The "Goose Girl" illustration taken from his beautiful *Household Stories from Grimm* (1882) was reproduced in tapestry by William Morris, and is now in the South Kensington Museum. *Flora's Feast, A Masque of Flowers* had lithographic reproductions of Mr Crane's line drawings washed in with water colour; he also decorated in colour *The Wonder Book* of Nathaniel Hawthorne, and Margaret Deland's *Old Garden*; in 1894 he collaborated with William Morris in the page decoration of *The Story of the Glittering Plain*, published at the Kelmscott press, which was executed in the style of 16th-century Italian and German woodcuts; but in purely decorative interest the finest of his works in book illustration is Spenser's *Faerie Queene* (12 pts., 1894-1896) and the *Shepherd's Calendar*. The poems which form the text of *Queen Summer* (1891), *Renascence* (1891), and *The Sirens Three* (1886) are by the artist himself.

In the early 'eighties under Morris's influence he was closely associated with the Socialist movement. He did as much as Morris himself to bring art into the daily life of all classes. With this object in view he devoted much attention to designs for textile stuffs, for wall-papers, and to house decoration; but he also used his art for the direct advancement of the Socialist cause. For a long time he provided the weekly cartoons for the Socialist organs, *Justice* and *The Commonweal*. Many of these were collected as *Cartoons for the Cause*. He devoted much time and energy to the work of the Art Workers' Guild, and to the Arts and Crafts Exhibition Society, founded by him in 1888. His own easel pictures, chiefly allegorical in subject, among them "The Bridge of Life" (1884) and "The Mower" (1891), were exhibited regularly at the Grosvenor Gallery and later at the New Gallery. "Neptune's Horses," which, with many other of Mr Crane's pictures, came into the possession of Herr Ernst Seeger of Berlin, was exhibited at the New Gallery in 1893, and with it may be classed his "The Rainbow and the Wave."

His varied work includes examples of plaster relief, tiles, stained glass, pottery, wall-paper and textile designs, in all of which he applied the principle that in purely decorative design "the artist works freest and best without direct reference to nature, and should have learned the forms he makes use of by heart." An exhibition of his work of different kinds was held at the Fine Art Society's galleries in Bond Street in 1891, and taken over to the United States in the same year by the artist himself. It was afterwards exhibited in the chief German, Austrian and Scandinavian towns, arousing great interest throughout the continent.

Mr Crane became an associate of the Water Colour Society in 1888; he was an examiner of the science and art department at South Kensington; director of design at the Manchester Municipal school (1894); art director of Reading College (1896);

and in 1898 for a short time principal of the Royal College of Art. His lectures at Manchester were published with illustrated drawings as *The Bases of Design* (1898) and *Line and Form* (1900). *The Decorative Illustration of Books, Old and New* (2nd ed.,) London and New York, 1900) is a further contribution to theory.

A well-known portrait of Mr Crane by G. F. Watts, R.A., was exhibited at the New Gallery in 1893. There is a comprehensive and sumptuously illustrated book on *The Art of Walter Crane*, by P. G. Konody; a monograph (1902) by Otto von Schleinitz in the *Künstler Monographien* series (Bielefeld and Leipzig); and an account of himself by the artist in the Easter number of 1898 of the *Art Journal*.

**CRANE, WILLIAM HENRY** (1845- ), American actor, was born on the 30th of April 1845, in Leicester, Massachusetts, and made his first appearance at Utica, New York, in Donizetti's *Daughter of the Regiment* in 1863. Later he had a great success as Le Blanc the Notary, in the burlesque *Evangeline* (1873). He made his first hit in the legitimate drama with Stuart Robson (1836-1903), in *The Comedy of Errors* and other Shakespearian plays, and in *The Henrietta* (1881) by Bronson Howard (1842-1908). This partnership lasted for twelve years, and subsequently Crane appeared in various eccentric character parts in such plays as *The Senator* and *David Harum*. In 1904 he turned to more serious work and played Isidore Izard in *Business is Business*, an adaptation from Octave Mirbeau's *Les Affaires sont les affaires*.

**CRANE** (in Dutch, *Kraan*; O. Ger. *Kraen*; cognate, as also the Lat. *grus*, and consequently the Fr. *grue* and Span. *grulla*, with the Gr. *γέπavos*), the *Grus communis* or *G. cinerea* of ornithologists, one of the largest wading-birds, and formerly a native of England, where William Turner, in 1544, said that he had very often seen its young ("carum pipiones saepissime vidi"). Notwithstanding the protection afforded it by sundry acts of parliament, it has long since ceased from breeding in England. Sir T. Browne (*ob.* 1682) speaks of it as being found in the open parts of Norfolk in winter. In Ray's time it was only known as occurring at the same season in large flocks in the fens of Lincolnshire and Cambridgeshire; and though mention is made of cranes' eggs and young in the fen-laws passed at a court held at Revesby in 1780, this was most likely but the formal repetition of an older edict; for in 1768 Pennant wrote that after the strictest inquiry he found the inhabitants of those counties to be wholly unacquainted with the bird. The crane, however, no doubt then appeared in Britain, as it does now, at uncertain intervals and in unwonted places, having strayed from the migrating bands whose movements have been remarked from almost the earliest ages. Indeed, the crane's aerial journeys are of a very extended kind; and on its way from beyond the borders of the Tropic of Cancer to within the Arctic Circle, or on the return voyage, its flocks may be descried passing overhead at a marvellous height, or halting for rest and refreshment on the wide meadows that border some great river, while the seeming order with which its ranks are marshalled during flight has long attracted attention. The crane takes up its winter quarters under the burning sun of Central Africa and India, but early in spring returns northward. Not a few examples reach the chill polar soils of Lapland and Siberia, but some tarry in the south of Europe and breed in Spain, and, it is supposed, in Turkey. The greater number, however, occupy the intermediate zone and pass the summer in Russia, north Germany, and Scandinavia. Soon after their arrival in these countries the flocks break up into pairs, whose nuptial ceremonies are accompanied by loud and frequent trumpeting, and the respective breeding-places of each are chosen.

The nest is formed with little art on the ground in large open marshes, where the herbage is not very high—a tolerably dry spot being selected and used apparently year after year. Here the eggs, which are of a rich brown colour with dark spots, and always two in number, are laid. The young are able to run soon after they are hatched, and are at first clothed with tawny down. In the course of the summer they assume nearly the same grey plumage that their parents wear, except that the elongated plumes, which in the adults form a graceful covering of the hinder



parts of the body, are comparatively undeveloped, and the clear black, white and red (the last being due to a patch of papillose skin of that colour) of the head and neck are as yet indistinct. During this time they keep in the marshes, but as autumn approaches the different families unite by the rivers and lakes, and ultimately form the enormous bands which after much more trumpeting set out on their southward journey.

The crane's power of uttering its sonorous and peculiar trumpet-like notes is commonly ascribed to the formation of its trachea, which on quitting the lower end of the neck passes backward between the branches of the furcula and is received into a hollow space formed by the bony walls of the carina or keel of the sternum. Herein it makes three turns, and then runs upwards and backwards to the lungs. The apparatus on the whole much resembles that found in the whooping swans (*Cygnus musicus*, *C. buccinator* and others), though differing in some not unimportant details; but at the same time somewhat similar convolutions of the trachea occur in other birds which do not possess, so far as is known, the faculty of trumpeting. The crane emits its notes both during flight and while on the ground. In the latter case the neck and bill are uplifted and the mouth kept open during the utterance of the blast, which may be often heard from birds in confinement, especially at the beginning of the year.

As usually happens in similar cases, the name of the once familiar British species is now used in a general sense, and applied to all others which are allied to it. Though by former systematists placed near or even among the herons, there is no doubt that the cranes have only a superficial resemblance and no real affinity to the *Ardeidae*. In fact the *Gruidae* form a somewhat isolated group. Huxley included them together with the *Rallidae* in his *Geranomorphae*; but a more extended view of their various characters would probably assign them rather as relatives of the Bustards—not that it must be thought that the two families have not been for a very long time distinct. *Grus*, indeed, is a very ancient form, its remains appearing in the Miocene of France and Greece, as well as in the Pliocene and Post-pliocene of North America. In France, too, during the "Reindeer Period" there existed a huge species—the *G. primigenia* of Alphonse Milne-Edwards—which has doubtless been long extinct. At the present time cranes inhabit all the great zoogeographical regions of the earth, except the Neotropical, and some sixteen or seventeen species are discriminated. In Europe, besides the *G. communis* already mentioned, the Numidian or demoiselle-crane (*G. virgo*) is distinguished from every other by its long white ear-tufts. This bird is also widely distributed throughout Asia and Africa, and is said to have occurred in Orkney as a straggler. The eastern part of the Palaearctic Region is inhabited by four other species that do not frequent Europe (*G. antigone*, *G. japonensis*, *G. monachus*, and *G. leucogeranus*), of which the last is perhaps the finest of the family, with nearly the whole plumage of a snowy white. The Indian Region, besides being visited in winter by four of the species already named, has two that are peculiar to it (*G. torquata* and *G. indica*, both commonly confounded under the name of *G. antigone*). The Australian Region possesses a large species known to the colonists as the "native companion" (*G. australis*), while the Nearctic is tenanted by three species (*G. americana*, *G. canadensis* and *G. fraterculus*), to say nothing of the possibility of a fourth (*G. schlegeli*), a little-known and somewhat obscure bird, finding its habitat here. In the Ethiopian Region are two species (*G. paradisea* and *G. carunculata*), which do not occur out of Africa, as well as three others forming the group known as "crowned cranes"—differing much from other members of the family, and justifiably placed in a separate genus, *Balearica*. One of these (*B. pavonina*) inhabits northern and western Africa, while another (*B. regulorum*) is confined to the eastern and southern parts of that continent. The third (*B. ceciliae*), from the White Nile, has been described by Dr P. Chalmers Mitchell (*P.Z.S.*, 1904).

With regard to the literature of this species, a paper "On the Breeding of the Crane in Lapland" (*Ibis*, 1859, p. 191), by John Wolley, is one of the most pleasing contributions to natural history

ever written, and an admirably succinct account of all the different species was communicated by Blyth to *The Field* in 1873 (vol. xl. p. 631, vol. xli. pp. 7, 61, 136, 189, 248, 384, 408, 418). A beautiful picture representing a flock of cranes resting by the Rhine during one of their annual migrations is to be found in Wolf's *Zoological Sketches*. (A. N.)

**CRANES** (so called from the resemblance to the long neck of the bird, cf. Gr. *γέρανος*, Fr. *grue*), machines by means of which heavy bodies may be lifted, and also displaced horizontally, within certain defined limits. Strictly speaking, the name alludes to the arm or jib from which the load to be moved is suspended, but it is now used in a wider sense to include the whole mechanism by which a load is raised vertically and moved horizontally. Machines used for lifting only are not called cranes, but winches, lifts or hoists, while the term elevator or conveyor is commonly given to appliances which continuously, not in separate loads, move materials like grain or coal in a vertical, horizontal or diagonal direction (see CONVEYORS). The use of cranes is of great antiquity, but it is only since the great industrial development of the 19th century, and the introduction of other motive powers than hand labour, that the crane has acquired the important and indispensable position it now occupies. In all places where finished goods are handled, or manufactured goods are made, cranes of various forms are in universal use.

Cranes may be divided into two main classes—revolving and non-revolving. In the first the load can be lifted vertically, and then moved round a central pivot, so as to be deposited at any convenient point within the range. The type of this class is the ordinary jib crane. In the second class there are, in addition to the lifting motion, two horizontal movements at right angles to one another. The type of this class is the overhead traveller. The two classes obviously represent respectively systems of polar and rectangular coordinates. Jib cranes can be subdivided into fixed cranes and portable cranes; in the former the central post or pivot is firmly fixed in a permanent position, while in the latter the whole crane is mounted on wheels, so that it may be transported from place to place.

The different kinds of motive power used to actuate cranes—manual, steam, hydraulic, electric—give a further classification. Hand cranes are extremely useful where the load is not excessive, and the quantities to be dealt with are not great; also where speed is not important, and first cost is an essential consideration. The net effective work of lifting that can be performed by a man turning a handle may be taken, for intermittent work, as being on an average about 5000 foot-lb per minute; this is equivalent to 1 ton lifted about 2½ ft. per minute, so that four men can by a crane raise 1 ton 9 ft. in a minute or 9 tons 1 ft. per minute. It is at once evident that hand power is only suitable for cranes of moderate power, or in cases where heavy loads have to be lifted only very occasionally. This point is dwelt upon, because the speed limitations of the hand-crane are often overlooked by engineers. Steam is an extremely useful motive power for all cranes that are not worked off a central power station. The steam crane has the immense advantage of being completely self-contained. It can be moved (by its own locomotive power, if desired) long distances without requiring any complicated means of conveying power to it; and it is rapid in work, fairly economical, and can be adapted to the most varying circumstances. Where, however, there are a number of cranes all belonging to the same installation, and these are placed so as to be conveniently worked from a central power station, and where the work is rapid, heavy and continuous, as is the case at large ports, docks and railway or other warehouses, experience has shown that it is best to produce the power in a generating station and distribute it to the cranes. Down to the closing decades of the 19th century hydraulic power was practically the only system available for working cranes from a power station. The hydraulic crane is rapid in action, very smooth and silent in working, easy to handle, and not excessive in cost or upkeep,—advantages which have secured its adoption in every part of the world. Electricity as a motive power for cranes is of more recent introduction. The electric

transmission of energy can be performed with an efficiency not reached by any other method, and the electric motor readily adapts itself to cranes. When they are worked from a power station the great advantage is gained that the same plant which drives them can be used for many other purposes, such as working machine tools and supplying current for lighting. For dock-side jib cranes the use of electric power is making rapid strides. For overhead travellers in workshops, and for most of the cranes which fall into our second class, electricity as a motive power has already displaced nearly every other method. Cranes driven by shafting, or by mechanical power, have been largely superseded by electric cranes, principally on account of the much greater economy of transmission. For many years the best workshop travellers were those driven by quick running ropes; these performed admirable service, but they have given place to the more modern electric traveller.

The principal motion in a crane is naturally the hoisting or lifting motion. This is effected by slinging the load to an eye or hook, and elevating the hook vertically. There are three typical methods: (1) A direct pull may be applied to the hook, either by screws, or by a cylinder fitted with piston and rod and actuated by direct hydraulic or other pressure, as shown diagrammatically in fig. 1. These methods are used in exceptional cases, but present the obvious difficulty of giving

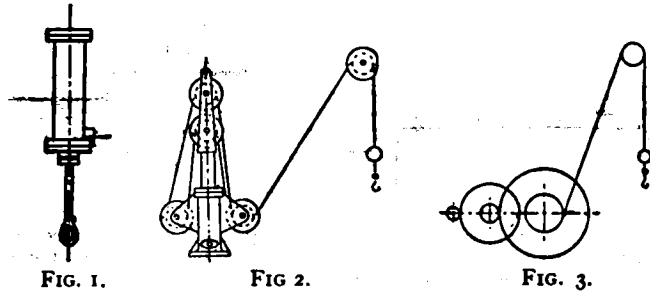

FIG. 1.

FIG. 2.

FIG. 3.

a very short range of lift. (2) The hook may be attached to a rope or chain, and the pulling cylinder connected with a system of pulleys around which the rope is led; by these means the lift can be very largely increased. Various arrangements are adopted; the one indicated in fig. 2 gives a lift of load four times the stroke of the cylinder. This second method forms the basis of the lifting gear in all hydraulic cranes. (3) The lifting rope or chain is led over pulley to a lifting barrel, upon which it is coiled as the barrel is rotated by the source of power (fig. 3). Sometimes, especially in the case of overhead travelling cranes for very heavy loads, the chain is a special pitch chain, formed of flat links pinned together, and the barrel is reduced to a wheel provided with teeth, or "sprockets," which engage in the links. In this case the chain is not coiled, but simply passes over the lifting wheel, the free end hanging loose. All the methods in this third category require a rotating lifting or barrel shaft, and this is the important difference between them and the hydraulic cranes mentioned above. Cranes fitted with rotating hydraulic engines may be considered as coming under the third category.

When the loads are heavy the above mechanisms are supplemented by systems of purchase blocks suspended from the jib or the traveller crab; and in barrel cranes trains of rotating gearing are interposed between the motor, or manual handle, and the barrel (fig. 3).

When a load is lifted, work has to be done in overcoming the action of gravity and the friction of the mechanism; when it is lowered, energy is given out. To control the speed and absorb this energy, brakes have to be provided. The hydraulic crane has a great advantage in possessing an almost ideal brake, for by simply throttling the exhaust from the lifting cylinder the speed of descent can be regulated within very wide limits and with perfect safety. Barrel cranes are usually fitted with band brakes, consisting of a brake rim with a friction band placed round it, the band being tightened as required. In ordinary cases conduction and convection suffice to dissipate the heat generated by the brake, but when a great deal of lowering has to be rapidly performed, or heavy loads have to be lowered to a great depth, special arrangements have to be provided. An excellent brake for very large cranes is Matthew's hydraulic brake, in which water is passed from end to end of cylinders fitted with reciprocating pistons, cooling jackets being provided. In electric cranes a useful method is to arrange the connexions so that the lifting motor acts as a dynamo, and, driven by the energy of the falling load, generates a current which is converted into heat by being passed through resistances. That the quantity of heat to be got rid of may become very considerable is seen when it is considered that the energy of a load of 60 tons

descending through 50 ft. is equivalent to an amount of heat sufficient to raise nearly 6 gallons of water from 60° F. to boiling point. Crane brakes are usually under the direct control of the driver, and they are generally arranged in one of two ways. In the first, the pressure is applied by a handle or treadle, and is removed by a spring or weight; this is called "braking on." In the second, or "braking off" method, the brake is automatically applied by a spring or weight, and is released either mechanically or, in the case of electric cranes, by the pull of a solenoid or magnet which is energized by the current passing through the motor. When the motor starts the brake is released; when it stops, or the current ceases, the brake goes on. The first method is in general use for steam cranes; it allows for a far greater range of power in the brake, but is not automatic, as is the second.

In free-barrel cranes the lifting barrel is connected to the revolving shaft by a powerful friction clutch; this, when interlocked with the brake and controller, renders electric cranes exceedingly rapid in working, as the barrel can be detached and lowering performed at a very high speed, without waiting for the lifting motor to come to rest in order to be reversed. This method of working is very suitable for electric dock-side cranes of capacities up to about 5 or 7 tons, and for overhead travellers where the height of lift is moderate. Where high speed lowering is not required it is usual to employ a reversing motor and keep it always in gear.

In steam cranes it is usual to work all the motions from one double cylinder engine. In order to enable two or more motions to be worked together, or independently as required, reversing friction cones are used for the subsidiary motions, especially the slewing motion. With the exception of a few special cranes in which friction wheels are employed, it is universally the practice, in steam cranes, to connect the engine shaft with the barrel shaft by spur toothed gearing, the gear being connected or disconnected by sliding pinions. In electric cranes the motor is connected to the barrel, either in a similar manner by spur gear or by worm gear. The toothed wheels give a slightly better efficiency, but the worm gear is somewhat smoother in its action and entirely silent; the noise of gearing can, however, be considerably reduced by careful machining of the teeth, as is now always done, and also by the use of pinions made of rawhide leather or other non-resonant material. When quick-running metal pinions are used they are arranged to run in closed oil-baths. Leather pinions must be protected from rats, which eat them freely. Worm wheel gearing is of very high efficiency if made very quick in pitch, with properly formed teeth perfectly lubricated, and with the end thrust of the worm taken on ball bearings. Much attention has been paid to the improvement of the mechanical details of the lifting and other motions of cranes, and in important installations the gearing is now usually made of cast steel. In revolving cranes ease of slewing can be greatly increased by the use of a live ring of conical rollers.

Electric motors for barrel cranes are not essentially different from those used for other purposes, but in proportioning the sizes the intermittent output has to be taken into consideration. This fact has led to the introduction of the "crane rated" motor, with a given "load factor." This latter gives the ratio of the length of the working periods to the whole time; e.g. a motor rated for a quarter load factor means that the motor is capable of exerting its full normal horse-power for three minutes out of every twelve, the pause being nine minutes, or one minute out of every four, the pause being three minutes. The actual load factor to be chosen depends on the nature of the work and the kind of crane. A dock-side crane unloading cargo with high lifts following one another in rapid succession will require a higher load factor than a workshop traveller with a very short lift and only a very occasional maximum load; and a traveller with a very long longitudinal travel will require a higher load factor for the travelling motor than for the lifting motor. In practice, the load factor for electric crane motors varies from  $\frac{1}{3}$  to  $\frac{1}{4}$ . In steam cranes much the same principle obtains in proportioning the boiler; e.g. the engines of a 10-ton steam crane have cylinders capable of indicating about 60 horse-power when working at full speed, but it is found that, in consequence of the intermittent working, sufficient steam can be supplied with a boiler whose heating surface is only  $\frac{1}{3}$  to  $\frac{1}{4}$  of that necessary for the above power, when developed continuously by a stationary engine.

In well-designed, quick-running cranes the mechanical efficiency of the lifting gear may be taken as about 85%; a good electric jib crane will give an efficiency of 72%, i.e. when actually lifting at full speed the mechanical work of lifting represents about 72% of the electric energy put into the lifting motor. A very convenient rule is to allow one brake horse-power of motor for every 10 foot-tons of work done at the hook; this is equivalent to an efficiency of 66 $\frac{1}{3}$ %, and is well on the safe side.

The motor in most common use for electric cranes is the series wound, continuous current motor, which has many advantages. It has a very large starting torque, which enables it to overcome the inertia of getting the load into motion, and it lifts heavy loads at a slower speed and lighter loads at a quicker one, behaving, under the action of the controller in a somewhat similar manner to that in which the cylinders of the steam crane respond to the action of the stop-valve. Three-phase motors are also much used for

crane-driving, and it is probable that improvements in single and two-phase motors will eventually largely increase their use for this class of work.

Tests of the comparative efficiencies of hydraulic and electric cranes tend to show that, although they do not vary to any very considerable extent with full load, yet the efficiency of the hydraulic crane falls away very much more rapidly than that of the electric crane when working on smaller loads. This drawback can be corrected to a slight extent by furnishing the hydraulic crane with more than one cylinder, and thus compounding it, but the arrangement does not give the same economical range of load as in an electric crane. In first cost the hydraulic crane has the advantage, but the power mains are much less expensive and more convenient to arrange in the electric crane.

The limit of speed of lift of hand cranes has already been mentioned; for steam jib cranes average practice is represented by the

**Speed.** formula  $V=30+200/T$ , where  $V$  is the speed of lift in feet per minute, and  $T$  the load in tons. Where electric or hydraulic cranes are worked from a central station the speed is greater, and may be roughly represented by  $V=5+300/T$ ; e.g. a 30-cwt. crane would lift with a speed of about 200 ft. per minute, and 100-ton crane with a speed of about 8 ft. per minute, but these speeds vary with local circumstances. The lifting speed of electric travellers is generally less, because the lift is generally much shorter, and may in ordinary cases be taken as  $V=3+85/T$ . The cross-traversing speed of travellers varies from 60 to 120 ft. per minute, and the longitudinal from 100 to 300 ft. per minute. The speed of these two motions depends much on the length of the span and of the longitudinal run, and on the nature of the work to be done; in certain cases, e.g. foundries, it is desirable to be able to lift, on occasions, at an extremely slow speed. In addition to the brakes on the lifting gear of cranes it is found necessary, especially in quick-running electric cranes, to provide a brake on the subsidiary motions, and also devices to stop the motor at the end of the lift or travel, so as to prevent over-running.

There are many other important points of crane construction too numerous to mention here, but it may be said generally that the advent of electricity has tended to increase speeds, and in consequence great attention is paid to all details that reduce friction and wear, such as roller and ball bearings and improved methods of lubrication; and, as in all other quick-running machinery, great stress has to be laid on accuracy of workmanship. The machinery, thus being of a higher class, requires more protection, and cranes that work in the open are now fitted with elaborate crane-houses or cabins, furnished with weather-tight doors and windows, and more care is taken to provide proper platforms, hand-rails and ladders of access, and also guards for the revolving parts of gearing.

**Typical Forms of Cranes.**—Fig. 4 is a diagram of a fixed hand revolving jib crane, of moderate size, as used in railway goods yards and similar places. It consists of a heavy base, which is securely bolted to the foundation, and which carries the strong crane-post, or pillar, around which the crane revolves. The revolving part is made with two side frames of cast iron or steel plates, and to these the lifting gear is attached.

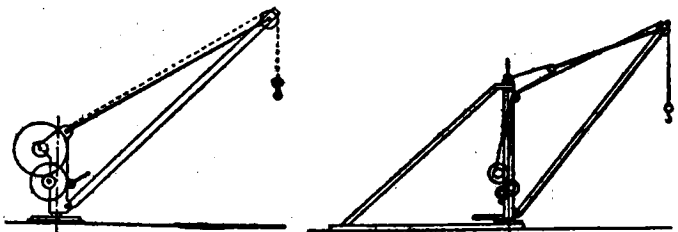

FIG. 4.

FIG. 5.

load is suspended from the crane jib; this jib is attached at the lower end to the side frames, and the upper end is supported by tie-rods, connected to the framework, the whole revolving together. This simple form of crane thus embodies the essential elements of foundation, post, framework, jib, tie-rods and gearing.

Fig. 5 shows another type of fixed crane, known as a derrick crane. Here the crane-post is extended into a long mast and is furnished with pivots at the top and bottom; the mast is supported by two "back ties," and these are connected to the socket of the bottom pivot by the "sleepers." This is a very good and comparatively cheap form of crane, where a long and variable radius is required, but it cannot slew through a complete circle. Derrick cranes are made of all powers, from the timber 1-ton hand derrick to the steel 150-ton derrick used in shipbuilding yards. The derrick crane introduces a problem for which many solutions have been sought, that of preventing the load from being lifted or lowered when the jib is pivoted up or down to alter the radius. To keep the load level, there are various devices for automatically coupling the jib-raising and the load-lowering motions.

Somewhat allied to the derrick are the sheer legs (fig. 6). Here the place of the jib is taken by two inclined legs joined together

at the top and pivoted at the bottom; a third back-leg is connected at the top to the other two, and at the bottom is coupled to a nut which runs on a long horizontal screw. This horizontal movement of the lower end of the back leg allows the whole arrangement to assume the position shown in fig. 7, so that a load can be taken out of a vessel and deposited on a quay wall. The same effect can be produced by shortening the back leg by a screw placed in the direction of its length. Sheer legs are generally built in very large sizes, and their use is practically confined to marine work.

Another type of fixed crane is the "Fairbairn" crane, shown in fig. 8. Here the jib, superstructure and post are all united in one piece, which revolves in a foundation well, being supported at the bottom by a toe-step and near the ground level by horizontal

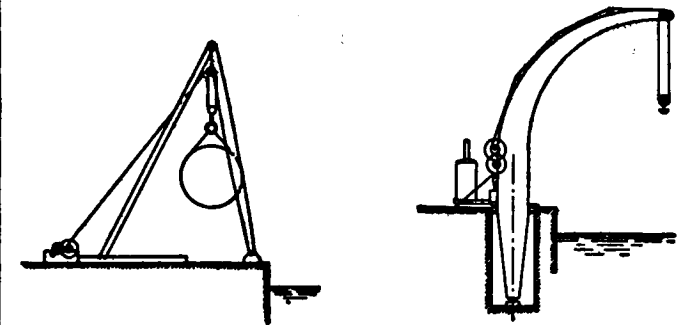

FIG. 7.

FIG. 8.

rollers. This type of crane used to be in great favour, in consequence of the great clearance it gives under the jib, but it is expensive and requires very heavy foundations.

The so-called "hammer-headed" crane (fig. 9) consists of a steel braced tower, on which revolves a large horizontal double cantilever; the forward part of this cantilever or jib carries the lifting crab, and the jib is extended backwards in order to form a support for the machinery and counter-balance. Besides the motions of lifting and revolving, there is provided a so-called "racking" motion, by which the lifting crab, with the load suspended, can be moved in and out along the jib without altering the level of the load. Such horizontal movement of the load is a marked feature of later crane design; it first became prominent in the so-called "Titan" cranes, mentioned below (fig. 14). Hammer-headed cranes are generally constructed in large sizes, up to 200 tons.

Another type of fixed revolving crane is the foundry or smithy crane (fig. 10). It has the horizontal racking motion mentioned

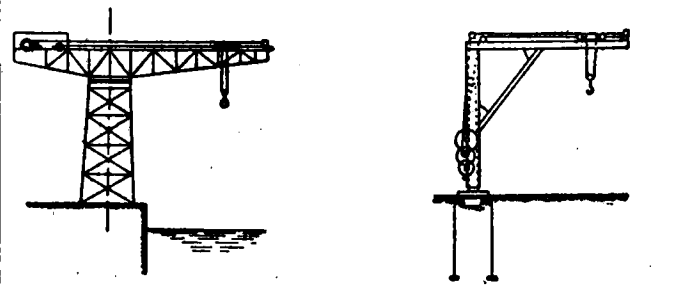

FIG. 9.

FIG. 10.

above, and revolves either on upper and lower pivots supported by the structure of the workshop, or on a fixed pillar secured to a heavy foundation. The type is often used in foundries, or to serve heavy hammers in a smithy, whence the name.

Portable cranes are of many kinds. Obviously, nearly every kind of crane can be made portable by mounting it on a carriage, fitted with wheels; it is even not unusual to make the Scottish derrick portable by using three trucks, one under the mast, and the others under the two back legs.

Fig. 11 represents a portable steam jib crane; it contains the same elements as the fixed crane (fig. 4), but the foundation bed is mounted on a truck which is carried on railway or road wheels. With portable cranes means must be provided to ensure the requisite stability against overturning; this is done by weighting the tail of the revolving part with heavy weights, and in steam cranes the

Portable cranes.

boiler is so placed as also to form part of the counterbalance. Where the rail-gauge is narrow and great weight is not desired, blocking girders are provided across the under side of the truck; these are arranged so that, by means of wedges or screws, they can be made to increase the base. In connexion with the stability of portable cranes, it may be mentioned that accidents more often arise from

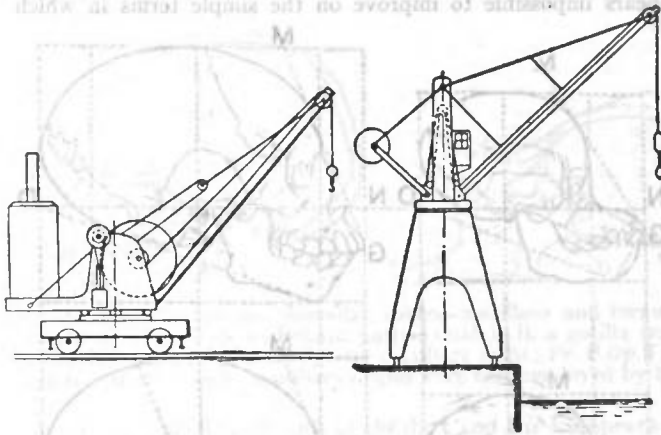

FIG. 11.

FIG. 12.

overturning backwards than forwards. In the latter case the overturning tendency begins as soon as the load leaves the ground, but ceases as soon as the load again touches the ground and thus relieves the crane of the extra weight, whereas overturning backwards is caused either by the reaction of a chain breaking or by excessive counterweight. When portable cranes are fitted with springs and axle-boxes, drawgear and buffers, so that they can be coupled to an ordinary railway train, they are called "break-down" or "wrecking" cranes.

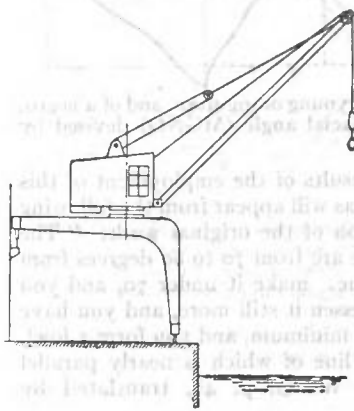

FIG. 13.

Dock-side jib cranes for working general cargo are almost always made portable, in order to enable them to be placed in correct position in regard to the hatchways of the vessels which they serve. Fig. 12 shows an ordinary hydraulic dock-side jib crane. This type is usually fitted with a very high jib, so as to lift goods in and out of high-sided vessels. The hydraulic lifting cylinders are placed inside the revolving steel mast or post, and the cabin for the driver is arranged high up in the front of the post, so as to give a good view of the work. The pressure is conveyed to the crane by means of jointed "walking" pipes, or flexible hose, connected to hydrants placed at regular intervals along the quay. It is often very desirable to have the quay space as little obstructed by the cranes as possible, so as not to interfere with railway traffic; this has led to the introduction of cranes mounted on high trucks or gantries, sometimes also called "portal" cranes. Where warehouses or station buildings run parallel to the quay line, the high truck is often extended, so as to span the whole quay; on one side the "long leg" runs on a rail at the quay edge, and on the other the "short leg" runs on a runway placed on the building. Cranes of this type are called "half-portal" cranes. Fig. 13 shows an electric crane of this class.

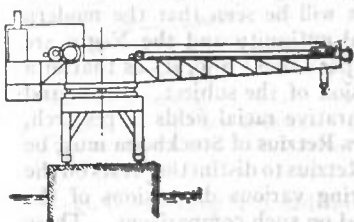

FIG. 14.

A special form of jib crane, designed to meet a particular purpose, is the "Titan" (fig. 14) largely used in the construction of piers and breakwaters. It contains all the essential elements of the hammer-headed crane, of which it may be considered to be the parent; in fact, the only essential difference is that the Titan is portable and the hammer-head crane fixed. The Titan was the first type of large

portable crane in which full use was made of a truly horizontal movement of the load; for the purpose for which the type is designed, viz. setting concrete blocks in courses, this motion is almost a necessity.

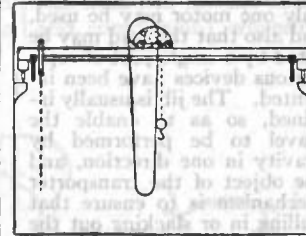

FIG. 15.

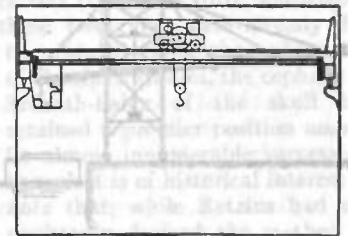

FIG. 16.

As types of non-revolving cranes, fig. 15 shows an overhead traveller worked by hand, and fig. 16 a somewhat similar machine worked by electric power. The principal component parts of a traveller are the main cross girders forming the bridge, the two end carriages on which the bridge rests, the running wheels which enable the end carriages to travel on the longitudinal gantry girders or runway, and the crab or jenny, which carries the hoisting mechanism, and moves across the span on

Non-revolving cranes.

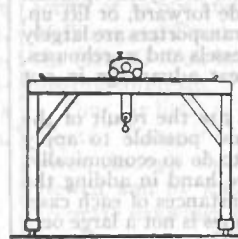

FIG. 17.

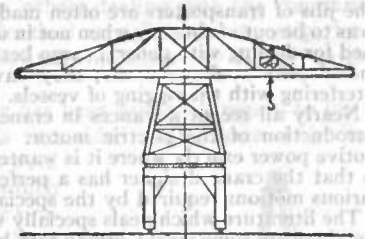

FIG. 18.

rails placed on the bridge girders. There are numerous and important variations of these two types, but the above contain the elements out of which most cranes of the class are built.

One variation is illustrated in fig. 17, and is called a "Goliath" or "Wellington." It is practically a traveller mounted on high legs, so as to permit of its being travelled on rails placed on the ground level, instead of on an elevated gantry. Of other variations and combinations of types, fig. 18 shows a modern design of crane intended to command the maximum of yard space, and having some of the characteristics both of the Goliath and of the revolving jib crane, and fig. 19 depicts a combination of a traveller and a hanging jib crane.

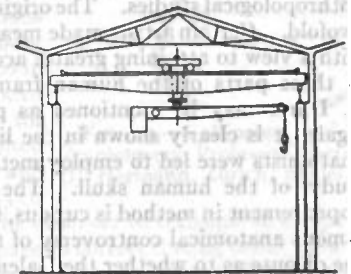

FIG. 19.

When the cross traverse motion of a traveller crab is suppressed, and the longitudinal travelling motion is increased in importance we come to a type of crane, the use of which is rapidly increasing; it goes by the name of "transporter." Transporters can only move the load to any point on a vertical surface (generally a plane surface); they have a lifting motion and a movement of translation. They are of two kinds: (1) those in which the motive power and lifting gear are self-contained on the crab; and (2) those in which the motive power is placed in a fixed position. A transporter of the first class is shown in fig. 20. From the lower flange of a suspended runway, made of a single I section, run wheels, from the axles of which the transporter is suspended. The latter consists of a framework carrying the hoisting barrel, with its driving motor and gearing, and a travelling motor, which is geared to the running wheels in such a manner as to be able to propel the whole machine; a seat is provided for the driver who manipulates the controllers. A transporter of this kind, when fitted with a grab, is a very efficient machine for taking coal from barges and depositing it in a coal store.

Transporters.

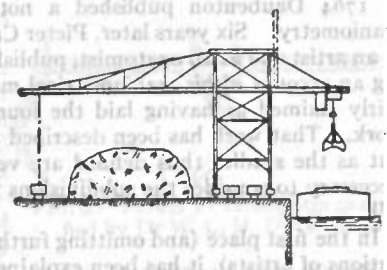

FIG. 20.

In the other class of transporter the load is not usually moved



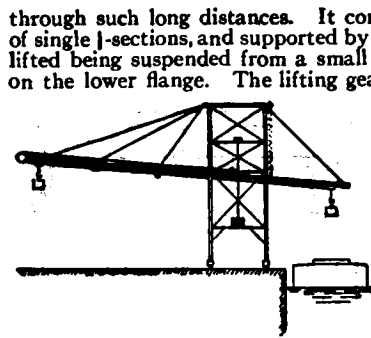

FIG. 21.

through such long distances. It consists essentially of a jib made of single J-sections, and supported by tie-rods (fig. 21), the load to be lifted being suspended from a small travelling carriage which runs on the lower flange. The lifting gear is located in any convenient fixed position. In order that only one motor may be used, and also that the load may be lifted by a single part of rope, various devices have been invented. The jib is usually inclined, so as to enable the travel to be performed by gravity in one direction, and the object of the transporter mechanism is to ensure that pulling in or slacking out the lifting rope shall perform the cycle of operations in the following order:—Supposing the load is ready to be lifted out of a vessel on to a quay, the pull of the lifting rope raises the load, the travelling jenny being meanwhile locked in position. On arriving at a certain height the lift ceases and the jenny is released, and by the continued pull of the rope, it runs up the jib; on arriving at an adjustable stop, the jenny is again locked, and the load can be lowered out; the hook can then be raised, when the jenny is automatically unlocked, and on paying out the rope the jenny gravitates to its first position, when the load is lowered and the cycle repeated. The jibs of transporters are often made to slide forward, or lift up, so as to be out of the way when not in use. Transporters are largely used for dealing with general cargo between vessels and warehouses, and also for coaling vessels; they have a great advantage in not interfering with the rigging of vessels.

Nearly all recent advances in crane design are the result of the introduction of the electric motor. It is now possible to apply motive power exactly where it is wanted, and to do so economically, so that the crane designer has a perfectly free hand in adding the various motions required by the special circumstances of each case.

The literature which deals specially with cranes is not a large one, but there are some good German text-books on the subject, amongst which may be mentioned *Die Hebezeuge* by Ernst (4th ed., Berlin, 1903), and *Cranes*, by Anton Böttcher, translated with additions by A. Tolhausen (London, 1908). (W. P. \*)

**CRANIOMETRY.** The application of precise methods of measurement marks a definite phase in the development of most branches of modern science, and thus craniometry, a comprehensive expression for all methods of measuring the skull (cranium), provides a striking landmark in the progress of anthropological studies. The origin of craniometry appears to be twofold. Certain artists made measurements of heads and skulls with a view to attaining greater accuracy in their representation of those parts of the human frame. Bernard de Palissy and A. Dürer may be mentioned as pioneers in such researches. Again, it is clearly shown in the literature of this subject, that anatomists were led to employ methods of measurement in their study of the human skull. The determining cause of this improvement in method is curious, for it appeared at the end of a famous anatomical controversy of the later middle ages, namely the dispute as to whether the Galenic anatomy was based on the study of the human body or upon those of apes. In the description of the dissection of a chimpanzee (in 1680) Tyson explains that the measurements he made of the skull of that animal were devised with a view to exhibiting the difference between this and the human skull.

The artists did not carry their researches very far. The anatomists on the contrary continued to make measurements, and in 1764 Daubenton published a noteworthy contribution to craniometry. Six years later, Pieter Camper, distinguished both as an artist and as an anatomist, published some lectures containing an account of his craniometrical methods, and these may be fairly claimed as having laid the foundation of all subsequent work. That work has been described above as anthropological, but as the studies thus defined are very varied in extent, it is necessary to consider the subdivisions into which they naturally fall.

In the first place (and omitting further reference to the contributions of artists), it has been explained that the measurements were first made with a view to elucidating the comparison of the skulls of men with those of other animals. This wide comparison constitutes the first subdivision of craniometric studies. And craniometric methods have rendered the results of comparison

much more clear and comprehensible than was formerly the case. It is further remarkable that among the first measurements employed angular determinations occur, and indeed the name of Camper is chiefly perpetuated in anthropological literature by the "facial angle" invented by that artist-anatomist (fig. 1). It appears impossible to improve on the simple terms in which

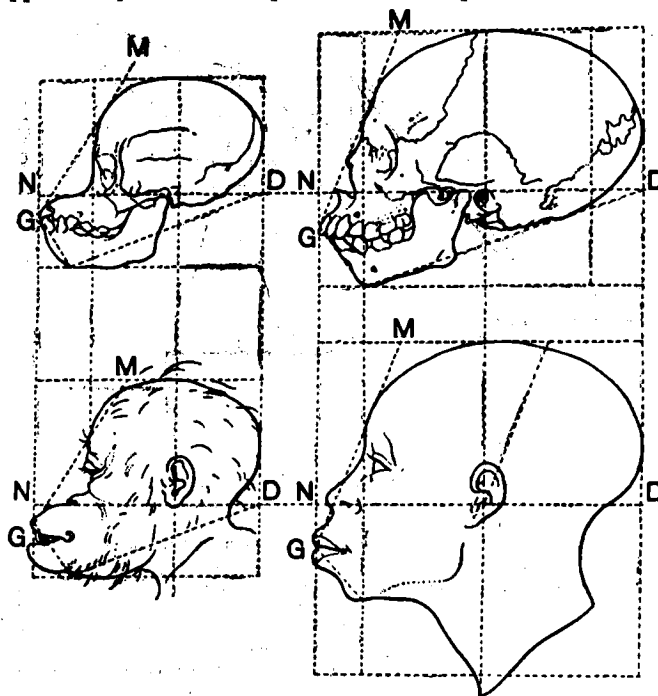

FIG. 1.—The skull and head of a young orang-utan, and of a negro, showing the lines including the facial angle (MGND) devised by Pieter Camper.

Camper describes the general results of the employment of this angle for comparative purposes, as will appear from the following brief extract from the translation of the original work: "The two extremities of the facial line are from 70 to 80 degrees from the negro to the Grecian antique: make it under 70, and you describe an ourang or an ape: lessen it still more, and you have the head of a dog. Increase the minimum, and you form a fowl, a snipe for example, the facial line of which is nearly parallel with the horizon." (Camper's Works, p. 42, translated by Cogan, 1821.)

In the 19th century the names of notable contributors to the literature of craniometry quickly increase in number; while it is impossible to analyse each contribution, or even record a complete list of the names of the authors, it must be added that for the purposes of far-reaching comparisons of the lower animals with mankind, craniometric methods were used by P. P. Broca in France and by T. H. Huxley (figs. 2 and 3) in England, with such genius and success as have not yet been surpassed.

The second division of craniometric studies includes those in which the skulls of the higher and lower races of mankind are compared. And in this domain, the advent of accurate numerical methods of recording observations brought about great advances. In describing the facial angle, it will be seen that the modern European, the Greek of classical antiquity and the Negro are compared. Thus it is that Camper's name appears as that of a pioneer in this second main division of the subject. Broca and Huxley cultivated similar comparative racial fields of research, but to these names that of Anders Retzius of Stockholm must be added here. The chief claim of Retzius to distinction rests on the merits of his system of comparing various dimensions of the skull, and of a classification based on such comparisons. These indices will be further defined below. It is convenient to mention here that the first aim of all these investigators was to obtain from the skull reliable data having reference to the conformation or size of the brain once contained within it. Only in later days did the tendency to overlook this, the fundamental aim and end



of craniometry, make its appearance; such nevertheless was the case, much to the detriment of craniometric science, which for a time seems to have become purely empirical.

The third subdivision of craniometric researches is one in which the field of comparison is still further narrowed. For herein the

One striking result was to exhibit a most marked contrast in respect of the breadth-index of the skull, between the Lapps and their Scandinavian neighbours, and thus a craniometric difference was added to the list of characters (such as stature, hair-colour and complexion) whereby these two types were already distinguished. Since the publication of Retzius's studies, the cephalic or breadth-index of the skull has retained a premier position among its almost innumerable successors, though it is of historical interest to note that, while Retzius had undoubtedly devised the method of comparing "breadth-indices," he always qualified the results of its use by reference to other data. These qualifications were overlooked by the immediate successors of Retzius, much to the disadvantage of craniometry. In addition to the researches on the skull

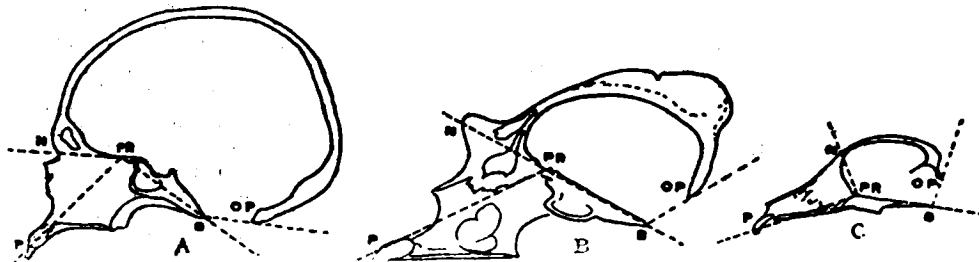

FIG. 2.—The sphenio-ethmoidal, sphenio-maxillary and foramino-basal angles are shown in the crania of:—A, a New Britain native (male); B, a gorilla (male); C, a dog. *N.Pr.B*, Sphenio-ethmoidal angle; *P.Pr.B*, Sphenio-maxillary angle; *Pr.B.Op*, Foramino-basal angle. The sphenio-ethmoidal and sphenio-maxillary angles were first employed by Huxley.

various sub-racial types such as the dark and fair Europeans are brought together for the purposes of comparison or contrast. But although the range of research is thus narrowed and restricted, the guiding principles and the methods remain unchanged. In this department of craniometry, Anders Retzius has gained the foremost place among the pioneers of research.

forms of Lapps and Swedes, others dealing with the comparison of Finns and Swedes (by Retzius) as well as the investigation of the form of skull in Basques and Guanches (by Broca) possess historic interest.

Thus far little or nothing has been said with regard to instruments. Camper devised a four-sided open frame with cross-wires, through which skulls were viewed and by means of which accurate drawings could be projected on to paper. The methods of Retzius as here described require the aid of callipers of various sorts, and such instruments were quickly devised and applied to the special needs of the case. Such instruments are still in use, and two forms of simple craniometer are shown in the accompanying illustrations (figs. 5 and 6). For the more accurate comparison required in the study of various European types, delicate instruments for measuring angles were invented by Anthelme in Paris (1836) and John Grattan in Belfast (1853). These instruments enabled the observer to transmit to the plane surface of a sheet of drawing paper a correct tracing of the contour of the specimen under investigation. A further modification was devised by the talented Dr Busk in the year 1861, and since that date the number and forms of these instruments have been greatly multiplied. With reference to contributors to the advance of knowledge in this particular department of craniometry, there should be added to the foregoing names those of Huxley, Sir W. H. Flower and Sir W. Turner in England, J. L. A. de Quatrefages in France, J. C. G. Lucae and H. Welcker in Germany. Moreover, the methods have also been multiplied, so that in addition to angular and linear measurements, those of the capacity or cubical contents of the cranium and those of the curvature of its surface demand reference.

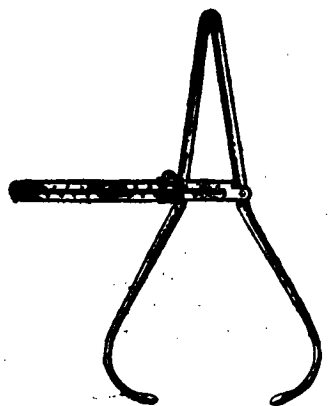

FIG. 5.—Callipers used in Craniometry, Professor Martin's (P. Hermann, Zürich) model.

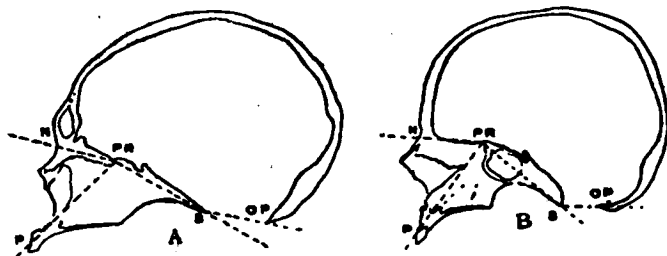
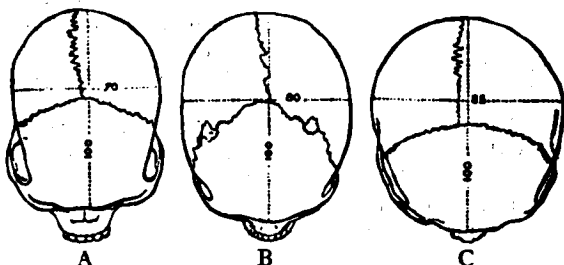

FIG. 3.—The sphenio-ethmoidal, sphenio-maxillary and foramino-basal angles are shown in the crania of:—A, a New Guinea native (male); B, a European woman. *N.Pr.B*, Sphenio-ethmoidal angle; *P.Pr.B*, Sphenio-maxillary angle; *Pr.B.Op*, Foramino-basal angle.

Retzius's name is, as already mentioned, associated not with any particular angle or angular measurement, but rather with a method of expressing as a formula two cranial dimensions which have been measured and which are to be compared. Thus for instance one skull may be so proportioned that its greatest width measures 75% of its greatest length (*i.e.* its width is to its length as three to four).

This ratio (of 75%) is termed the cephalic or breadth-index, which in such an instance would be described as equal to 75.



From Tylor's *Anthropology*, by permission of Macmillan & Co., Ltd.  
FIG. 4.—Top view of skulls. (A) Negro, index 70, dolichocephalic; (B) European, index 80, mesaticephalic; (C) Samoyed, index 85, brachycephalic.

A skull providing a breadth-index of 75 will naturally possess very different proportions from another which provides a corresponding index equal to 85. And in fact this particular index in human skulls varies from about 58 to 90 in undistorted examples (fig. 4). Such is the general scheme of Retzius's system of classification of skulls by means of indices, and one of his earliest applications of the method was to the inhabitants of Sweden.

And finally while two dimensions are combined in the cephalic index of Retzius, the combination of three dimensions (in a formula called a modulus) distinguishes some recent work, although the employment of the modulus is

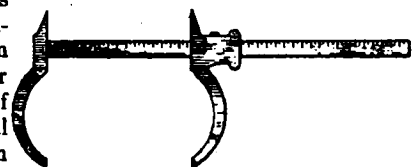

FIG. 6.—Flower's Craniometer as modified by Dr W. L. H. Duckworth.

actually a return to a system devised in 1859 by Karl E. von Baer.

The fourth subdivision of craniometry is closely allied to that which has just been described, and it deals with the comparison of the prehistoric and the recent types of mankind. The methods are exactly similar to those employed in the comparison of living races; but in some particular instances where the prehistoric individual is represented only by a comparatively minute portion of the skull, some special modifications of the usual procedures have been necessitated. In this field the works of W. His and L. Rüttimeyer on the prehistoric races of Switzerland, those of Ecker (South Germany), of Broca in France, of Thurnam and Davis in England, must be cited. G. Schwalbe, Kramberger,

l'homme et dans les animaux," *Comptes rendus de l'académie des sciences* (Paris, 1764); Camper, *Works* (1770, translated by Cogan, 1821); Broca, *Mémoires* (1862 and following years); Huxley, *Journal of Anatomy and Physiology*, vol. 1 (1867); Retzius, *Über die Schädelformen der Nordbewohner* (Stockholm, 1842); Anthelme, *Physiologie de la pensée* (Paris, 1836); Grattan, *Ulster Journal of Archaeology*, vol. 1 (1853); Busk, "A System of Craniometry," *Transactions of the Ethnological Society* (1861); Flower, *Catalogue of the Hunterian Museum, Osteology*, part 1 (London, 1879); Turner, "Challenger Reports," *Zoology*, vol. x. pt. 29, "Human Crania" (1884); de Quatrefages, *Crania ethnica* (Paris, 1873); Lucae, *Architectur des menschlichen Schädels* (Frankfort, 1855); Welcker, *Bau und Wachstum des menschlichen Schädels* (1862); Cleland, "An Inquiry into the Variations of the Human Skull," *Phil. Trans. Roy. Society* (1870), vol. 160, pp. 117 et seq.; von Baer, "Crania selecta," *Académie impériale des sciences de S. Pétersbourg* (1859); His and Rüttimeyer, *Crania Helvetica* (Basel, 1866); Ecker, *Crania Germaniae meridionalis* (1865); Thurnam and Davis, *Crania Britannica*; von Török, *Craniometrie* (Stuttgart, 1890); Benedikt, *Manuel technique et pratique d'anthropométrie cranio-céphalique* (Paris, 1889); Pearson, *Biometrika*, from vol. 1 (in 1902) onwards; Sergi, "The Varieties of the Human Species," English translation, Smithsonian Institution (Washington, 1894); Schwalbe, "Der Neanderthalschädel," *Bonner Jahrbücher*, Heft 106; also *Sonderheft der Zeitschrift für Morphologie und Anthropologie*; Kramberger, *Der paläolithische Mensch von Krapina* (Nägele, Stuttgart, 1901); Sollas, "The Cranial Characters of the Neanderthal Race," *Phil. Transactions of the Royal Society*, vol. 199, Series B, p. 298, 1908; Klaatsch, "Bericht über einen anthropologischen Streifzug nach London," *Zeitschrift für Ethnologie*, Heft 6, 1903, p. 875.

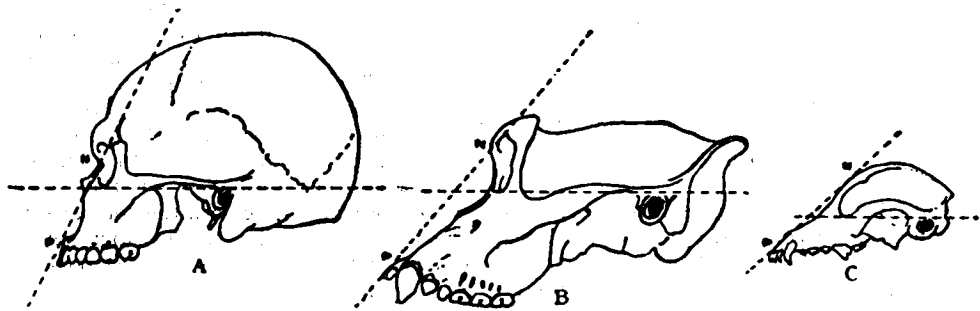

FIG. 7.—The facial angle of the Frankfort Agreement is shown in the crania of:—A, a New Britain native (male) 62°; B, a gorilla (male) 50°; C, a dog 42°. This angle has now replaced the facial angle of Camper (cf. fig. 1).

W. J. Sollas and H. Klaatsch are the most recent contributors to this department of craniometry.

Thus the complexity of craniometric studies has inevitably increased. In the hands of von Török of Budapest, as in those of M. Benedikt of Vienna at an earlier date, the number of measurements regarded as necessary for the complete "diagnosis" of a skull has reached a colossal total. Of the trend and progress of craniometry at the present day, three particular developments are noteworthy. First come the attempts made at various times to co-ordinate the systems of measurements so as to ensure uniformity among all observers; of these attempts two, viz. that of the German anthropologists at Frankfort in 1882 (figs. 7 and 8), and that of the Anthropometric Committee of the British

*Phil. Transactions of the Royal Society*, vol. 199, Series B, p. 298, 1908; Klaatsch, "Bericht über einen anthropologischen Streifzug nach London," *Zeitschrift für Ethnologie*, Heft 6, 1903, p. 875. *Handbooks*.—Topinard, *Éléments d'anthropologie générale* (Paris, 1885); Schmidt, *Anthropologische Methoden* (Leipzig, 1888); Duckworth, *Morphology and Anthropology* (Cambridge, 1904). *Journals*.—*Bulletins de la Société d'Anthropologie de Paris*, *Journal of the Royal Anthropological Institute of Great Britain and Ireland*, *Archiv für Anthropologie*, *Zeitschrift für Morphologie und Anthropologie*. (W. L. H. D.)

**CRANK**, a word of somewhat obscure etymology, probably connected with a root meaning "crooked," and appearing in the Ger. *krank*, ill, a figurative use of the original word; among other words in English containing the same original meaning are "cringe" and "crinkle."

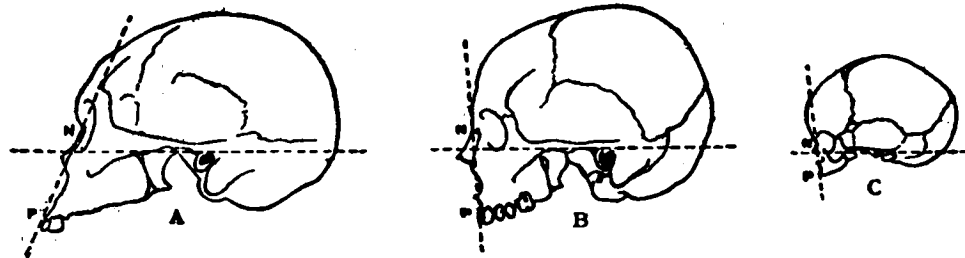

FIG. 8.—The facial angle of the Frankfort Agreement is shown in the crania of:—A, a New Guinea native (male) 75°; B, a European (woman) 93°; C, a new-born infant (93°).

Association (1906) seem to require at least a record. In the second place, the application of the methods of statistical science in dealing with large numbers of craniometric data has been richly rewarded in Prof. Karl Pearson's hands. Thirdly, and in connexion with such methods, there may be mentioned the extension of these systems of measurement, and of the methods of dealing with them on statistical principles, to the study of large numbers of the skulls of domestic and feral animals, such as white rats or the varieties of the horse. And lastly no account of craniometry would be complete without mention of the revolt, headed by the Italian anthropologist Sergi, against metrical methods of all kinds. It cannot, however, be alleged that the substitutes offered by the adherents of Sergi's principles encourage others to forsake the more orthodox numerical methods.

LITERATURE.—Tyson, *The Anatomy of a Pygmy* (London, 1699); Daubenton, "Sur la différence de la situation du tron occipital dans

In mechanics, a crank is a device by which reciprocating motion is converted into circular motion or vice versa, consisting of a *crank-arm*, one end of which is fastened rigidly at right angles to the rotating shaft or axis, while the other end bears a *crank-pin*, projecting from it at right angles and parallel to the shaft. When the reciprocating part of a machine, as the piston and piston-rod of a steam engine, is linked to this crank by a *crank-rod* or *connecting rod*, one end of which works on the crank-pin and the other on a pin in the end of the reciprocating part, the to-and-fro motion of the latter imparts a circular motion to the shaft and vice versa. The crank, instead of being made up as described above, may be formed by bending the shaft to the required shape, as sometimes in the handle of a winch. A *bell-crank*, so called because of its use in bell-hanging to change the direction of motion of the wires from horizontal to vertical or vice versa, consists of two arms rigidly connected at an angle, say of 90°, to each other and pivoted on a pin placed at the point of junction.

Crank is also the name given to a labour machine used in prisons as a means of punishment (see TREAD-MILL). Other uses of the word, connected with the primary meaning, are for a crooked path, a crevice or chink; and a freakish turn of thought or speech, as in Milton's phrase "quips and cranks." It is also used as a slang expression, American in origin, for a harmless

lunatic, or a faddist, whose enthusiasm for some one idea or hobby becomes a monomania. "Crank" or "crank-sided" is a nautical term used of a ship which by reason of her build or from want of balance is liable to overturn. This strictly nautical sense is often confused with "crank" or "cranky," that is, rickety or shaky, probably derived direct from the German *krank*, weak or ill.

**CRANMER, THOMAS** (1489-1556), archbishop of Canterbury, born at Aslacton or Aslockton in Nottinghamshire on the 2nd of July 1489, was the second son of Thomas Cranmer and of his wife Anne Hatfield. He received his early education, according to Moryce his secretary, from "a marvellous severe and cruel schoolmaster," whose discipline must have been severe indeed to deserve this special mention in an age when no schoolmaster bore the rod in vain. The same authority tells us that he was initiated by his father in those field sports, such as hunting and hawking, which formed one of his recreations in after life. To early training he also owed the skilful horsemanship for which he was conspicuous. At the age of fourteen he was sent by his mother, who had in 1501 become a widow, to Cambridge. Little is known with certainty of his university career beyond the facts that he became a fellow of Jesus College in 1510 or 1511, that he had soon after to vacate his fellowship, owing to his marriage to "Black Joan," a relative of the landlady of the Dolphin Inn, and that he was reinstated in it on the death of his wife, which occurred in childbirth before the lapse of the year of grace allowed by the statutes. During the brief period of his married life he held the appointment of lecturer at Buckingham Hall, now Magdalene College. The fact of his marrying would seem to show that he did not at the time intend to enter the church; possibly the death of his wife caused him to qualify for holy orders. He was ordained in 1523, and soon after he took his doctor's degree in divinity. According to Strype, he was invited about this time to become a fellow of the college founded by Cardinal Wolsey at Oxford; but Dean Hook shows that there is some reason to doubt this. If the offer was made, it was declined, and Cranmer continued at Cambridge filling the offices of lecturer in divinity at his own college and of public examiner in divinity to the university. It is interesting, in view of his later efforts to spread the knowledge of the Bible among the people, to know that in the capacity of examiner he insisted on a thorough acquaintance with the Holy Scriptures, and rejected several candidates who were deficient in this qualification.

It was a somewhat curious concurrence of circumstances that transferred Cranmer, almost at one step, from the quiet seclusion of the university to the din and bustle of the court. In August 1529 the plague known as the sweating sickness, which prevailed throughout the country, was specially severe at Cambridge, and all who had it in their power forsook the town for the country. Cranmer went with two of his pupils named Cressy, related to him through their mother, to their father's house at Waltham in Essex. The king (Henry VIII.) happened at the time to be visiting in the immediate neighbourhood, and two of his chief counsellors, Gardiner, secretary of state, afterwards bishop of Winchester, and Edward Fox, the lord high almoner, afterwards bishop of Hereford, were lodged at Cressy's house. Meeting with Cranmer, they were naturally led to discuss the king's meditated divorce from Catherine of Aragon. Cranmer suggested that if the canonists and the universities should decide that marriage with a deceased brother's widow was illegal, and if it were proved that Catherine had been married to Prince Arthur, her marriage to Henry could be declared null and void by the ordinary ecclesiastical courts. The necessity of an appeal to Rome was thus dispensed with, and this point was at once seen by the king, who, when Cranmer's opinion was reported to him, is said to have ordered him to be summoned in these terms: "I will speak to him. Let him be sent for out of hand. This man, I trow, has got the right sow by the ear."

At their first interview Cranmer was commanded by the king to lay aside all other pursuits and to devote himself to the question of the divorce. He was to draw up a written treatise, stating the course he proposed, and defending it by arguments

from scripture, the fathers and the decrees of general councils. His material interests certainly did not suffer by compliance. He was commended to the hospitality of Anne Boleyn's father, the earl of Wiltshire, in whose house at Durham Place he resided for some time; the king appointed him archdeacon of Taunton and one of his chaplains; and he also held a parochial benefice, the name of which is unknown. When the treatise was finished Cranmer was called upon to defend its argument before the universities of Oxford and Cambridge, which he visited, accompanied by Fox and Gardiner. Immediately afterwards he was sent to plead the cause before a more powerful if not a higher tribunal. An embassy, with the earl of Wiltshire at its head, was despatched to Rome in 1530, that "the matter of the divorce should be disputed and ventilated," and Cranmer was an important member of it. He was received by the Pope with marked courtesy, and was appointed "Grand Penitentiary of England," but his argument, if he ever had the opportunity of stating it, did not lead to any practical decision of the question.

Cranmer returned in September 1530, but in January 1531 he received a second commission from the king appointing him "Conciliarius Regius et ad Caesarem Orator." In the summer of 1531 he accordingly proceeded to Germany as sole ambassador to the emperor. He was also to sound the Lutheran princes with a view to an alliance, and to obtain the removal of some restrictions on English trade. At Nuremberg he became acquainted with Osiander, whose somewhat isolated theological position he probably found to be in many points analogous to his own. Both were convinced that the old order must change; neither saw clearly what the new order should be to which it was to give place. They had frequent interviews, which had doubtless an important influence on Cranmer's opinions. But Osiander's house had another attraction of a different kind from theological sympathy. His niece Margaret won the heart of Cranmer, and in 1532 they were married. Hook finds in the fact of the marriage corroboration of Cranmer's statement that he never expected or desired the primacy; and it seems probable enough that, if he had foreseen how soon the primacy was to be forced upon him, he would have avoided a disqualification which it was difficult to conceal and dangerous to disclose.

Expected or not, the primacy was forced upon him within a very few months of his marriage. In August 1532 Archbishop Warham died, and the king almost immediately afterwards intimated to Cranmer, who had accompanied the emperor in his campaign against the Turks, his nomination to the vacant see. Cranmer's conduct was certainly consistent with his profession that he did not desire, as he had not expected, the dangerous promotion. He sent his wife to England, but delayed his own return in the vain hope that another appointment might be made. The papal bulls of confirmation were dated February and March 1533, and the consecration took place on the 30th March. One peculiarity of the ceremony had occasioned considerable discussion. It was the custom for the archbishop elect to take two oaths, the first of episcopal allegiance to the pope, and the second in recognition of the royal supremacy. The latter was so wide in its scope that it might fairly be held to supersede the former in so far as the two were inconsistent. Cranmer, however, was not satisfied with this. He had a special protest recorded, in which he formally declared that he swore allegiance to the pope only in so far as that was consistent with his supreme duty to the king. The morality of this course has been much canvassed, though it seems really to involve nothing more than an express declaration of what the two oaths implied. It was the course that would readily suggest itself to a man of timid nature who wished to secure himself against such a fate as Wolsey's. It showed weakness, but it added nothing to whatever immorality there might be in successively taking two incompatible oaths.

In the last as in the first step of Cranmer's promotion Henry had been actuated by one and the same motive. The business of the divorce—or rather, of the legitimation of Anne Boleyn's expected issue—had now become very urgent, and in the new archbishop he had an agent who might be expected to forward it with the needful haste. The celerity and skill with which

Cranmer did the work intrusted to him must have fully satisfied his master. During the first week of April Convocation sat almost from day to day to determine questions of fact and law in relation to Catherine's marriage with Henry as affected by her previous marriage with his brother Arthur. Decisions favourable to the object of the king were given on these questions, though even the despotism of the most despotic of the Tudors failed to secure absolute unanimity. The next step was taken by Cranmer, who wrote a letter to the king, praying to be allowed to remove the anxiety of loyal subjects as to a possible case of disputed succession, by finally determining the validity of the marriage in his archiepiscopal court. There is evidence that the request was prompted by the king, and his consent was given as a matter of course. Queen Catherine was residing at Amptill in Bedfordshire, and to suit her convenience the court was held at the priory of Dunstable in the immediate neighbourhood. Declining to appear, she was declared contumacious, and on the 23rd of May the archbishop gave judgment declaring the marriage null and void from the first, and so leaving the king free to marry whom he pleased. The Act of Appeals had already prohibited any appeal from the archbishop's court. Five days later he pronounced the marriage between Henry and Anne—which had been secretly celebrated about the 25th of January 1533—to be valid. On the 1st of June he crowned Anne as queen, and on the 10th of September stood godfather to her child, the future Queen Elizabeth.

The breach with Rome and the subjection of the church in England to the royal supremacy had been practically achieved before Cranmer's appointment as archbishop: and he had little to do with the other constitutional changes of Henry's reign. But his position as chief minister of Henry's ecclesiastical jurisdiction forced him into unpleasant prominence in connexion with the king's matrimonial experiences. In 1536 he was required to revise his own sentence in favour of the validity of Henry's marriage with Anne Boleyn; and on the 17th of May the sentence is pronounced is fairly clear. Anne's sister, Mary Boleyn, had been Henry VIII.'s mistress; this by canon law was a bar to his marriage with Anne—a bar which had been removed by papal dispensation in 1527, but now the papal power to dispense in such cases had been repudiated, and the original objection revived. The sentence was grotesquely legal and unjust. With Anne's condemnation by the House of Lords Cranmer had nothing to do. He interceded for her in vain with the king, as he had done in the cases of Fisher, More and the monks of Christchurch. His share in the divorce of Anne of Cleves was less prominent than that of Gardiner, though he did preside over the Convocation in which nearly all the dignitaries of the church signified their approval of that measure. To his next and last interposition in the matrimonial affairs of the king no discredit attaches itself. When he was made cognizant of the charges against Catherine Howard, his duty to communicate them to the king was obvious, though painful.

Meanwhile Cranmer was actively carrying out the policy which has associated his name more closely, perhaps, than that of any other ecclesiastic with the Reformation in England. Its most important feature on the theological as distinct from the political side was the endeavour to promote the circulation of the Bible in the vernacular, by encouraging translation and procuring an order in 1538 that a copy of the Bible in English should be set up in every church in a convenient place for reading. Only second in importance to this was the re-adjustment of the creed and liturgy of the church, which formed Cranmer's principal work during the latter half of his life. The progress of the archbishop's opinion towards that middle Protestantism, if it may be so called, which he did so much to impress on the formularies of the Church of England, was gradual, as a brief enumeration of the successive steps in that progress will show. In 1538 an embassy of German divines visited England with the design, among other things, of forming a common confession for the two countries. This proved impracticable, but the frequent conferences Cranmer had with the theologians composing the embassy had doubtless a great influence in modifying his views. Both in parliament and

in Convocation he opposed the Six Articles of 1539, but he stood almost alone. During the period between 1540 and 1543 the archbishop was engaged at the head of a commission in the revision of the "Bishop's Book" (1537) or *Institutions of a Christian Man*, and the preparation of the *Necessary Erudition* (1543) known as the "King's Book," which was a modification of the former work in the direction of Roman Catholic doctrine. In June 1545 was issued his Litany, which was substantially the same as that now in use, and shows his mastery of a rhythmical English style.

The course taken by Cranmer in promoting the Reformation exposed him to the bitter hostility of the reactionary party or "men of the old learning," of whom Gardiner and Bonner were leaders, and on various occasions—notably in 1543 and 1545—conspiracies were formed in the council or elsewhere to effect his overthrow. The king, however, remained true to him, and all the conspiracies signally failed. It illustrates a favourable trait in the archbishop's character that he forgave all the conspirators. He was, as his secretary Morice testifies, "a man that delighted not in revenging."

Cranmer was present with Henry VIII. when he died (1547). By the will of the king he was nominated one of a council of regency composed of sixteen persons, but he acquiesced in the arrangement by which Somerset became lord protector. He officiated at the coronation of the boy king Edward VI., and is supposed to have instituted a sinister change in the order of the ceremony, by which the right of the monarch to reign was made to appear to depend upon inheritance alone, without the concurrent consent of the people. But Edward's title had been expressly sanctioned by act of parliament, so that there was no more room for election in his case than in that of George I., and the real motive of the changes was to shorten the weary ceremony for the frail child.

During this reign the work of the Reformation made rapid progress, the sympathies both of the Protector and of the young king being decidedly Protestant. Cranmer was therefore enabled without let or hindrance to complete the preparation of the church formularies, on which he had been for some time engaged. In 1547 appeared the *Homilies* prepared under his direction. Four of them are attributed to the archbishop himself—those on Salvation, Faith, Good Works and the Reading of Scripture. His translation of the German Catechism of Justus Jonas, known as Cranmer's Catechism, appeared in the following year. Important, as showing his views on a cardinal doctrine, was the *Defence of the True and Catholic Doctrine of the Sacrament*, which he published in 1550. It was immediately answered from the side of the "old learning" by Gardiner. The first prayer-book of Edward VI. was finished in November 1548, and received legal sanction in March 1549; the second was completed and sanctioned in April 1552. The archbishop did much of the work of compilation personally. The forty-two articles of Edward VI. published in 1553 owe their form and style almost entirely to the hand of Cranmer. The last great undertaking in which he was employed was the revision of his codification of the canon law, which had been all but completed before the death of Henry. The task was one eminently well suited to his powers, and the execution of it was marked by great skill in definition and arrangement. It never received any authoritative sanction, Edward VI. dying before the proclamation establishing it could be made, and it remained unpublished until 1571, when a Latin translation by Dr Walter Haddon and Sir John Cheke appeared under the title *Reformatio legum ecclesiasticarum*. It laid down the lawfulness and necessity of persecution to the death for heresy in the most absolute terms; and Cranmer himself condemned Joan Bocher to the flames. But he naturally loathed persecution, and was as tolerant as any in that age.

Cranmer stood by the dying bed of Edward as he had stood by that of his father, and he there suffered himself to be persuaded to take a step against his own convictions. He had pledged himself to respect the testamentary disposition of Henry VIII. by which the succession devolved upon Mary, and now he violated his oath by signing Edward's "device" of the crown to Lady Jane Grey.

On grounds of policy and morality alike the act was quite indefensible; but it is perhaps some palliation of his perjury that it was committed to satisfy the last urgent wish of a dying man, and that he alone remained true to the nine days' queen when the others who had with him signed Edward's device deserted her. On the accession of Mary he was summoned to the council—most of whom had signed the same device—reprimanded for his conduct, and ordered to confine himself to his palace at Lambeth until the queen's pleasure was known. He refused to follow the advice of his friends and avoid the fate that was clearly impending over him by flight to the continent. Any chance of safety that lay in the friendliness of a strong party in the council was more than nullified by the bitter personal enmity of the queen, who could not forgive his share in her mother's divorce and her own disgrace. On the 14th of September 1553 he was sent to the Tower, where Ridley and Latimer were also confined. The immediate occasion of his imprisonment was a strongly worded declaration he had written a few days previously against the mass, the celebration of which, he heard, had been re-established at Canterbury. He had not taken steps to publish this, but by some unknown channel a copy reached the council, and it could not be ignored. In November, with Lady Jane Grey, her husband, and two other Dudleys, Cranmer was condemned for treason. Renard thought he would be executed, but so true a Romanist as Mary could scarcely have an ecclesiastic put to death in consequence of a sentence by a secular court, and Cranmer was reserved for treatment as a heretic by the highest of clerical tribunals, which could not act until parliament had restored the papal jurisdiction. Accordingly in March 1554 he and his two illustrious fellow-prisoners, Ridley and Latimer, were removed to Oxford, where they were confined in the Bocardo or common prison. Ridley and Latimer were unflinching, and suffered bravely at the stake on the 16th of October 1555. Cranmer had been tried by a papal commission, over which Bishop Brooks of Gloucester presided, in September 1555. Brooks had no power to give sentence, but reported to Rome, where Cranmer was summoned, but not permitted, to attend. On the 25th of November he was pronounced contumacious by the pope and excommunicated, and a commission was sent to England to degrade him from his office of archbishop. This was done with the usual humiliating ceremonies in Christ Church, Oxford, on the 14th of February 1556, and he was then handed over to the secular power. About the same time Cranmer subscribed the first two of his "recantations." His difficulty consisted in the fact that, like all Anglicans of the 16th century, he recognized no right of private judgment, but believed that the state, as represented by monarchy, parliament and Convocation, had an absolute right to determine the national faith and to impose it on every Englishman. All these authorities had now legally established Roman Catholicism as the national faith, and Cranmer had no logical ground on which to resist. His early "recantations" are merely recognitions of his lifelong conviction of this right of the state. But his dilemma on this point led him into further doubts, and he was eventually induced to revile his whole career and the Reformation. This is what the government wanted. Northumberland's recantation had done much to discredit the Reformation, Cranmer's, it was hoped, would complete the work. Hence the enormous effect of Cranmer's recovery at the final scene. On the 21st of March he was taken to St Mary's church, and asked to repeat his recantation in the hearing of the people as he had promised. To the surprise of all he declared with dignity and emphasis that what he had recently done troubled him more than anything he ever did or said in his whole life; that he renounced and refused all his recantations as things written with his hand, contrary to the truth which he thought in his heart; and that as his hand had offended, his hand should be first burned when he came to the fire. As he had said, his right hand was steadfastly exposed to the flames. The calm cheerfulness and resolution with which he met his fate show that he felt that he had cleared his conscience, and that his recantation of his recantations was a repentance that needed not to be repented of.

It was a noble end to what, in spite of its besetting sin of infirmity of moral purpose, was a not ignoble life. The key to his character is well given in what Hooper said of him in a letter to Bullinger, that he was "too fearful about what might happen to him." This weakness was the worst blot on Cranmer's character, but it was due in some measure to his painful capacity for seeing both sides of a question at the same time, a temperament fatal to martyrdom. As a theologian it is difficult to class him. As early as 1538 he had repudiated the doctrine of Transubstantiation; by 1550 he had rejected also the Real Presence (Pref. to his *Answer to Dr Richard Smith*). But here he used the term "real" somewhat unguardedly, for in his *Defence* he asserts a real presence, but defines it as exclusively a spiritual presence; and he repudiates the idea that the bread and wine were "bare tokens." His views on church polity were dominated by his implicit belief in the divine right of kings (not of course the divine hereditary right of kings) which the Anglicans felt it necessary to set up against the divine right of popes. He set practically no limits to the ecclesiastical authority of kings; they were as fully the representatives of the church as the state, and Cranmer hardly distinguished between the two. Church and state to him were one.

**AUTHORITIES.**—*Letters and Papers of Henry VIII.* vols. iv.-xx.: *Acts of the Privy Council, 1542-1556*; *Cal. of State Papers, Dom. and Foreign*; *Foxe's Acts and Monuments*; *Strype's Memorials of Cranmer* (1694); *Anecdotes and Character of Archbishop Cranmer*, by Ralph Morice, and two contemporary biographies (Camden Society's publications); *Remains of Thomas Cranmer*, by Jenkyns (1833); *Lives of Cranmer*, by Gilpin (1784), Todd (1831), Le Bas, in *Hook's Lives of the Archbishops of Canterbury*, vols. vi. and vii. (1868), by Canon Mason (1897), A. D. Innes (1900) and A. F. Pollard (1904); *Froude's History*; *R. W. Dixon's History*; *J. Gairdner's History of the Church, 1485-1558*; *Bishop Cranmer's Recantations*, ed. Gairdner (1885). R. E. Chester Waters's *Chesters of Chicheley* (1877) contains a vast amount of genealogical information about Cranmer which has only been used by one of his biographers. (A. F. P.)

**CRANNOG** (Celt. *crann*, a tree), the term applied in Scotland and Ireland to the stockaded islands so numerous in ancient times in the lochs of both countries. The existence of these lake-dwellings in Scotland was first made known by John Mackinlay, a fellow of the Society of Antiquaries of Scotland, in a letter sent to George Chalmers, the author of *Caledonia*, in 1813, describing two crannogs, or fortified islands in Bute. The crannog of Lagore, the first discovered in Ireland, was examined and described by Sir William Wilde in 1840. But it was not until after the discovery of the pile-villages of the Swiss lakes, in 1853, had drawn public attention to the subject of lake-dwellings, that the crannogs of Scotland and Ireland were systematically investigated.

The results of these investigations show that they have little in common with the Swiss lake-dwellings, except that they are placed in lakes. Few examples are known in England, although over a hundred and fifty have been examined in Ireland, and more than half that number in Scotland. As a rule they have been constructed on islets or shallows in the lochs, which have been adapted for occupation, and fortified by single or double lines of stockaded defences drawn round the margin. To enlarge the area, or raise the surface-level where that was necessary, layers of logs, brushwood, heather and ferns were piled on the shallow, and consolidated with gravel and stones. Over all there was laid a layer of earth, a floor of logs or a pavement of flagstones. In rare instances the body of the work is entirely of stones, the stockaded defence and the huts within its enclosure being the only parts constructed of timber. Occasionally a bridge of logs, or a causeway of stones, formed a communication with the shore, but often the only means of getting to and from the island was by canoes hollowed out of a single tree. Remains of huts of logs, or of wattled work, are often found within the enclosure. Three crannogs in Dowalton Loch, Wigtownshire, examined by Lord Lovaine in 1863, were found to be constructed of layers of fern and birch and hazel branches, mixed with boulders and penetrated by oak piles, while above all there was a surface layer of stones and soil. The remains of the stockade round the margin were of vertical piles mortised into horizontal bars, and secured by pegs in the mortised holes. The crannog of



Lochlee, near Tarbolton, Ayrshire, explored by Dr R. Munro in 1878, was 100 ft. in diameter, and had a double row of piles, bound by horizontal stretchers with square mortise-holes, enclosing an area 60 ft. in diameter. In the centre was a space 40 ft. square, bounded by the remains of a wooden wall and paved inside with split logs. A partition divided it into two equal parts, one of which had a doorway opening to the south, and close by it an extensive refuse-heap. In the middle of the other part was a stone-paved hearth, with remains of three former hearths underneath. The substructure was built up from the bottom of the loch, partly of brushwood but chiefly of logs and trunks of trees with the branches lopped off, placed in layers, each disposed transversely or obliquely across the one below it. A crannog in Loch-an-Dhugael, Balinakill, Argyllshire, described by the same explorer in 1893, revealed a substructure similar to that at Lochlee, with a double row of piles enclosing an area 45 to 50 ft. in diameter, within which was a circular construction 32 ft. in diameter, which had been supported by a large central post and about twenty uprights ranged round the circumference.

From their common feature of a substructure of brushwood and logs built up from the bottom, the crannogs have been classed as fascine-dwellings, to distinguish them from the typical pile-dwellings of the earlier periods in Switzerland, whose platforms are supported by piles driven into the bed of the lake. The crannog of Cloonfinlough in Connaught had a triple stockade of oak piles, connected by horizontal stretchers and enclosing an area 130 ft., in diameter, laid with trunks of oak trees. In the crannog of Lagore, county Meath, there were about 150 cartloads of bones, chiefly of oxen, deer, sheep and swine, the refuse of the food of the occupants. In the crannog of Lisnacrogghera, county Antrim, iron swords, with sheaths of thin bronze ornamented with scrolls characteristic of the Late Celtic style, iron daggers, an iron spear-head 16½ in. in length, and pieces of what are called large caldrons of iron, were found. Among the few remains of lacustrine settlements in England and Wales, some are suggestive of the typical crannog structure. The most important of these is the Glastonbury lake village, excavated by Mr A. Bulleid and Mr St George Gray. It consists of more than sixty separate dwellings, grouped within a triangular palisaded defence, formed in the midst of a marsh now partially reclaimed. The dwellings were circular, from 18 to 35 ft. in diameter, the substructure formed of logs and brushwood mingled with stones and clay, and outlined by piles driven into the bottom of the shallow lake. The walls of the houses seem to have been made of wattle-work, supported by posts sometimes not more than a single foot apart. The floors are of clay, with a hearth of stones in the centre, often showing several renewals over the original. The relics recovered show unmistakably that the occupation must be dated within the Iron Age, but probably pre-Roman, as no evidence of contact with Roman civilization has been discovered. The stage of civilization indicated is nevertheless not a low one. Besides the implements and weapons of iron there are fibulae and brooches of bronze, weaving combs and spindle-whorls, a bronze mirror and tweezers, wheel-made pottery as well as hand-made, ornamented with Late Celtic patterns, a bowl of thin bronze decorated with bosses, the nave of a wooden wheel with holes for twelve spokes, and a dug-out canoe. Another site in Holderness, Yorkshire, examined by Mr Boynton in 1881, yielded evidence of fascine construction, with suggestions of occupation in the latter part of the Bronze Age. Similar indications are adduced by Professor Boyd Dawkins from the site on Barton Mere. On the other hand, the implements and weapons found in the Scottish and Irish crannogs are usually of iron, or, if objects of bronze and stone are found, they are commonly such as were in use in the Iron Age. Crannogs are frequently referred to in the Irish annals. Under the year 848 the *Annals of the Four Masters* record the burning of the island of Lough Gabhor (the crannog of Lagore), and the same stronghold is noticed as again destroyed by the Danes in 933. Under the year 1246 it is recorded that Turlough O'Connor made his escape from the crannog of Lough Leisi, and drowned his keepers. Many other entries occur in the succeeding centuries. In the register of the privy council of

Scotland, April 14, 1608, it is ordered that "the haill houssis of defence, strongholds, and *crannokis* in the Yllis (the western isles) pertaining to Angus M'Connell of Dunnyvaig and Hector M'Cloyne of Dowart sal be delyverit to His Majestie." Judging from the historical evidence of their late continuance, and from the character of the relics found in them, the crannogs may be included among the latest prehistoric strongholds, reaching their greatest development in early historic times, and surviving through the middle ages. In Ireland, Sir William Wilde has assigned their range approximately to the period between the 9th and 16th centuries; while Dr Munro holds that the vast majority of them, both in Ireland and in Scotland, were not only inhabited, but constructed during the Iron Age, and that their period of greatest development was as far posterior to Roman civilization as that of the Swiss *Pfahlbauten* was anterior to it. (See LAKE DWELLINGS.)

**AUTHORITIES.**—Dr R. Munro, *The Lake Dwellings of Europe: being the Rhind Lectures in Archaeology for 1888* (with a bibliography of the subject) (London, 1890); *Ancient Scottish Lake-Dwellings or Crannogs* (Edinburgh, 1882); Col. W. G. Wood-Martin, *The Lake-Dwellings of Ireland, or Ancient Lacustrine Habitations of Erin, commonly called Crannogs* (Dublin, 1886); Sir W. Wilde, *Descriptive Catalogue of the Antiquities in the Museum of the Royal Irish Academy*, article "Crannogs," pp. 220-233 (Dublin, 1857); John Stuart, "Scottish Artificial Islands or Crannogs," in the *Proceedings of the Society of Antiquaries of Scotland*, vol. vi. (Edinburgh, 1865); A. Bulleid, "The Lake Village near Glastonbury," in *Proceedings of the Somersetshire Archaeological Society*, vol. xl. (1894). (J. AN.)

**CRANSAC**, a town of southern France, in the department of Aveyron, 28 m. N.W. of Rodez by rail. Pop. (1906) town, 4988; commune, 6953. The town is a coal-mining centre and has cold mineral springs, known in the middle ages. There are iron-mines in the neighbourhood. Hills to the north of the town contain disused coal-mines which have been on fire for centuries. About 5 m. to the south is the fine Renaissance chateau of Bournazel, built for the most part by Jean de Buisson, baron of Bournazel, about 1545. The barony of Bournazel became a marquisate in 1624.

**CRANSTON**, a township of Providence county, Rhode Island, U.S.A., adjoining the city of Providence on the S. Pop. (1890) 8099; (1900) 13,343; (1910) 21,171; area, 30 sq. m. It is served by the New York, New Haven & Hartford railway. The surface of the E. part is level, that of the W. part is somewhat rolling. Within the township are several villages, including Arlington, Auburn, Edgewood, Fiskeville and Oaklawn. The inhabitants of the country districts are engaged largely in the growing of hay, Indian corn, rye, oats and market-garden produce; in the several villages cotton and print goods, fuses for electrical machinery, and automatic fire-protection sprinklers are manufactured. The value of the township's factory product increased from \$1,402,359 in 1900 to \$2,130,969 in 1905, or 52%. The state has a farm of 667 acres in the S. part of the township; on this are the state prison, the Providence county jail, the state workhouse and the house of correction, the state almshouse, the state hospital for the insane, the Sockanosset school for boys, and the Oaklawn school for girls—the last two being departments of the state reform school. The post-office address of all these state institutions is Howard. Cranston was settled as a part of Providence about 1640 by associates of Roger Williams, and in 1754 was incorporated as a separate township, but in 1868, in 1873 and in 1892 portions of it were reannexed to Providence. The township is said to have been named in honour of Samuel Cranston (1659-1727), governor of Rhode Island from 1698 until his death.

**CRANTOR**, a Greek philosopher of the Old Academy, was born, probably about the middle of the 4th century B.C., at Soli in Cilicia. He was a fellow-pupil of Polemo in the school of Xenocrates at Athens, and was the first commentator on Plato. He is said to have written some poems which he sealed up and deposited in the temple of Athens at Soli (Diog. Laertius iv. 5. 25). Of his celebrated work *On Grief* (*Περὶ πένθους*), a letter of condolence to his friend Hippocles on the death of his children, numerous extracts have been preserved in Plutarch's *Consolatio ad Apollonium* and in the *De consolatione* of Cicero,

who speaks of it (*Acad.* ii. 44. 135) in the highest terms (*aureolus et ad verbum ediscendus*). Crantor paid especial attention to ethics, and arranged "good" things in the following order—virtue, health, pleasure, riches.

See F. Kayser, *De Crantore Academico* (1841); M. H. E. Meier, *Opuscula academica*, ii. (1863); F. Susemihl, *Geschichte der griechischen Litteratur in der Alexandrinerzeit*, i. (1891), p. 118.

**CRANWORTH, ROBERT MONSEY ROLFE**, BARON (1790–1868), Lord chancellor of England, elder son of the Rev. E. Rolfe, was born at Cranworth, Norfolk, on the 18th of December 1790. Educated at Bury St Edmunds, Winchester, and Trinity College, Cambridge, he was called to the bar at Lincoln's Inn in 1816, and attached himself to the chancery courts. He represented Penryn and Falmouth in parliament from 1832 till his promotion to the bench as baron of the exchequer in 1839. In 1850 he was appointed a vice-chancellor and created Baron Cranworth, and in 1852 he became lord chancellor in Aberdeen's ministry. He continued to hold the chancellorship in the administration of Palmerston until the latter's resignation in 1857. He was not reappointed when Palmerston returned to office in 1859, but on the retirement of Lord Westbury in 1865 he accepted the great seal for a second time, and held it till the fall of the Russell administration in 1866. Cranworth died in London on the 26th of July 1868. Never a very zealous law reformer, Cranworth's name is associated in the statute book with only one small measure on conveyancing. But as a judge he will continue to hold first rank. His judgments were marked by sound common sense, while he himself was remarkably free from the prejudices of his profession. Few men of his day enjoyed greater personal popularity than Cranworth. He left no issue and the title became extinct on his death.

See *The Times*, 27th of July 1868; E. Manson, *The Builders of our Law* (1904); E. Foss, *The Judges of England* (1848–1864); J. B. Atlay, *Lives of the Chancellors*, vol. ii. (1908).

**CRAPE** (an anglicized version of the Fr. *crêpe*), a silk fabric of a gauzy texture, having a peculiar crisp or crimped appearance. It is woven of hard spun silk yarn "in the gum" or natural condition. There are two distinct varieties of the textile—soft, Canton or Oriental crape, and hard or crisped crape. The wavy appearance of Canton crape results from the peculiar manner in which the weft is prepared, the yarn from two bobbins being twisted together in the reverse way. The fabric when woven is smooth and even, having no *crêpe* appearance, but when the gum is subsequently extracted by boiling it at once becomes soft, and the weft, losing its twist, gives the fabric the waved structure which constitutes its distinguishing feature. Canton crapes are used, either white or coloured, for ladies' scarves and shawls, bonnet trimmings, &c. The Chinese and Japanese excel in the manufacture of soft crapes. The crisp and elastic structure of hard crape is not produced either in the spinning or in the weaving, but is due to processes through which the gauze passes after it is woven. What the details of these processes are is known to only a few manufacturers, who so jealously guard their secret that, in some cases, the different stages in the manufacture are conducted in towns far removed from each other. Commercially they are distinguished as single, double, three-ply and four-ply crapes, according to the nature of the yarn used in their manufacture. They are almost exclusively dyed black and used in mourning dress, and among Roman Catholic communities for nuns' veils, &c. In Great Britain hard crapes are made at Braintree in Essex, Norwich, Yarmouth, Manchester and Glasgow. The crape formerly made at Norwich was made with a silk warp and worsted weft, and is said to have afterwards degenerated into bombazine. A very successful imitation of real crape is made in Manchester of cotton yarn, and sold under the name of Victoria crape.

**CRASH**, a technical textile term applied to a species of narrow towels, from 14 to 20 in. wide. The name is probably of Russian origin, the simplest and coarsest type of the cloth being known as "Russia crash." The latter is made from grey flax or tow yarns, and sometimes from boiled yarns. The simple term "crash" is given to all these narrow cloths, but the above distinction is very convenient, as also are the following: grey, boiled, bleached,

plain, twilled and fancy crash. A large variety obtains with and without fancy borders, while of late years cotton has been introduced as warp, as well as mixed and jute yarns for weft. After the cloth has passed through all the finishing operations, it is cut up into lengths of about 3 yds., the two ends sewn together and it is then ready to be placed over a suspended roller; for this reason it is often termed "roller towelling."

**CRASHAW, RICHARD** (1613–1650), English poet, styled "the divine," was born in London about 1613. He was the son of a strongly anti-papistical divine, Dr William Crashaw (1572–1626), who distinguished himself, even in those times, by the excessive acerbity of his writings against the Catholics. In spite of these opinions, however, he was attracted by Catholic devotion, for he translated several Latin hymns of the Jesuits. Richard Crashaw was originally put to school at Charterhouse, but in July 1631 he was admitted to Pembroke College, Cambridge, where he took the degree of B.A. in 1634. The publication of Herbert's *Temple* in 1633 seems to have finally determined the bias of his genius in favour of religious poetry, and next year he published his first book, *Epigrammatum sacrorum liber*, a volume of Latin verses. In March 1636 he removed to Peterhouse, was made a fellow of that college in 1637, and proceeded M.A. in 1638. It was about this time that he made the acquaintance and secured the lasting friendship of Abraham Cowley. He was also on terms of intimacy with the Anglican monk Nicholas Ferrar, and frequently visited him at his religious house at Little Gidding. In 1641 he is said to have gone to Oxford, but only for a short time; for when in 1643 Cowley left Cambridge to seek a refuge at Oxford, Crashaw remained behind, and was forcibly ejected from his fellowship in 1644. In the confusion of the civil wars he escaped to France, where he finally embraced the Catholic religion, towards which he had long been tending.

During his exile his religious and secular poems were collected by an anonymous friend, and published under the title of *Steps to the Temple* and *The Delights of the Muses*, in one volume, in 1646. The first part includes the hymn to St Teresa and the version of Marini's *Sospetto d' Herode*. This same year Cowley found him in great destitution at Paris, and induced Queen Henrietta Maria to extend towards him what influence she still possessed. At her introduction he proceeded to Italy, where he became attendant to Cardinal Palotta at Rome. In 1648 he published two Latin hymns at Paris. He remained until 1649 in the service of the cardinal, to whom he had a great personal attachment; but his retinue contained persons whose violent and licentious behaviour was a source of ceaseless vexation to the sensitive English mystic. At last his denunciation of their excesses became so public that the animosity of those persons was excited against him, and in order to shield him from their revenge he was sent by the cardinal in 1650 to Loretto, where he was made a canon of the Holy House. In less than three weeks, however, he sickened of fever, and died on the 25th of August, not without grave suspicion of having been poisoned. He was buried in the Lady chapel at Loretto. A collection of his religious poems, entitled *Carmen Deo nostro*, was brought out in Paris in 1652, dedicated at the dead poet's desire to the faithful friend of his sufferings, the countess of Denbigh. The book is illustrated by thirteen engravings after Crashaw's own designs.

Crashaw excelled in all manner of graceful accomplishments; besides being an excellent Latinist and Hellenist, he had an intimate knowledge of Italian and Spanish; and his skill in music, painting and engraving was no less admired in his lifetime than his skill in poetry. Cowley embalmed his memory in an elegy that ranks among the very finest in our language, in which he, a Protestant, well expressed the feeling left on the minds of contemporaries by the character of the young Catholic poet:—

"His faith, perhaps, in some nice tenets might  
Be wrong; his life, I'm sure, was in the right:  
And I, myself, a Catholic will be,  
So far at least, dear saint, to pray to thee!"

The poetry of Crashaw will be best appreciated by those who can with most success free themselves from the bondage of a traditional

sense of the dignity of language. The custom of his age permitted the use of images and phrases which we now justly condemn as incongruous and unseemly, and the fervent fancy of Crashaw carried this licence to excess. At the same time his verse is studded with fiery beauties and sudden felicities of language, unsurpassed by any lyrist between his own time and Shelley's. There is no religious poetry in English so full at once of gross and awkward images and imaginative touches of the most ethereal beauty. The temper of his intellect seems to have been delicate and weak, fiery and uncertain; he has a morbid, almost hysterical, passion about him, even when his ardour is most exquisitely expressed, and his adoring addresses to the saints have an effeminate falsetto that makes their ecstasy almost repulsive. The faults and beauties of his very peculiar style can be studied nowhere to more advantage than in the *Hymn to Saint Teresa*. Among the secular poems of Crashaw the best are *Music's Duel*, which deals with that strife between the musician and the nightingale which has inspired so many poets, and *Wishes to his supposed Mistress*. In his latest sacred poems, included in the *Carmen Deo nostro*, sudden and eminent beauties are not wanting, but the mysticism has become more pronounced, and the ecclesiastical mannerism more harsh and repellent. The themes of Crashaw's verses are as distinct as possible from those of Shelley's, but it may, on the whole, be said that at his best moments he reminds the reader more closely of the author of *Epipsychidion* than of any earlier or later poet.

Crashaw's works were first collected, in one volume, in 1858 by W. B. Turnbull. In 1872 an edition, in 2 volumes, was printed for private subscription by the Rev. A. B. Grosart. A complete edition was edited (1904) for the Cambridge University Press by Mr A. R. Waller. (E. G.)

**CRASSULACEAE**, in botany, a natural order of dicotyledons, containing 13 genera and nearly 500 species; of cosmopolitan distribution, but most strongly developed in South Africa. The plants are herbs or small shrubs, generally with thick fleshy stems and leaves, adapted for life in dry, especially rocky places. The fleshy leaves are often reduced to a more or less cylindrical structure, as in the stonecrops (*Sedum*), or form closely crowded rosettes as in the house-leek (*Sempervivum*). Correlated with their life in dry situations, the bulk of the tissue is succulent, forming a water-store, which is protected from loss by evaporation by a thickly cuticularized epidermis covered with a waxy secretion which gives a glaucous appearance to the plant. The flowers are generally arranged in terminal or axillary clusters, and are markedly regular with the same number of parts in each series. This number is, however, very variable, and often not

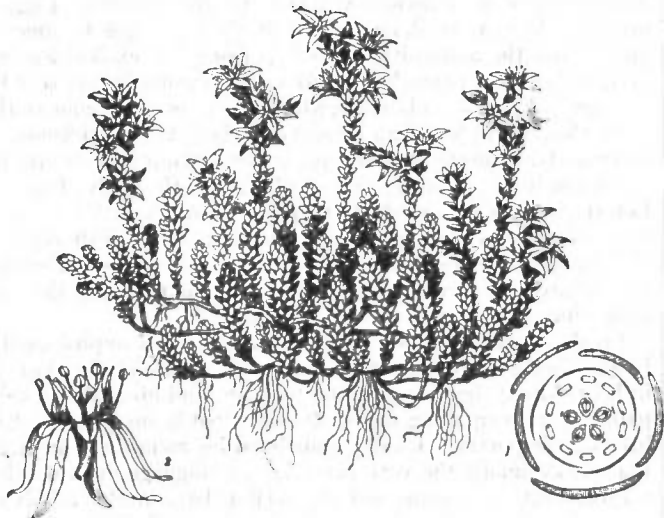

Stonecrop (*Sedum acre*) slightly reduced. 1, Horizontal plan of arrangement of flower of stonecrop; 2, flower of *Sedum rubens*.

constant in one and the same species. The sepals and petals are free or more or less united, the stamens as many or twice as many as the petals; the carpels, usually free, are equal to the petals in number, and form in the fruit follicles with two or more seeds.

Opposite each carpel is a small scale which functions as a nectary. Means of vegetative propagation are general. Many species spread by means of a creeping much-branched rootstock, or as in house-leek, by runners which perish after producing a terminal leaf-rosette. In other cases small portions of the stem or leaves give rise to new plants by budding, as in *Bryophyllum*, where buds develop at the edges of the leaf and form new plants.

The order is almost absent from Australia and Polynesia, and has but few representatives in South America; it is otherwise very generally distributed. The largest genus, *Sedum*, contains about 140 species in the temperate and colder parts of the northern hemisphere; eight occur wild in Britain, including *S. Telephium* (orpine) and *S. acre* (common stonecrop) (see fig.). The species are easily cultivated and will thrive in almost any soil. They are readily propagated by seeds, cuttings or divisions. *Crassula* has about 100 species, chiefly at the Cape. *Cotyledon*, a widely distributed genus with about 90 species, is represented in the British Isles by *C. Umbilicus*, pennywort, or navelwort, which takes its name from the succulent petate leaves. It grows profusely on dry rocks and walls, especially on the western coasts, and bears a spike of drooping greenish cup-shaped flowers. The *Echeveria* of gardens is now included in this genus. *Sempervivum* has about 50 species in the mountains of central and southern Europe, in the Himalayas, Abyssinia, and the Canaries and Madeira; *S. tectorum*, common house-leek, is seen often growing on tops of walls and house-roofs. The hardy species will grow well in dry sandy soil, and are suitable for rockeries, old walls or edgings. They are readily propagated by offsets or by seed.

The order is closely allied to Saxifragaceae, from which it is distinguished by its fleshy habit and the larger number of carpels.

**CRASSUS** (literally "dense," "thick," "fat"), a family name in the Roman gens Licinia (plebeian). The most important of the name are the following:

1. **PUBLIUS LICINIUS CRASSUS**, surnamed *Dives Mucianus*, Roman statesman, orator and jurist, consul, 131 B.C. He was the son of P. Mucius Scaevola (consul 175) and was adopted by a P. Licinius Crassus Dives. An intimate friend of Tiberius Gracchus, he was chosen after his death to take his place on the agrarian commission (see GRACCHUS). In 131 when Crassus was consul with L. Valerius Flaccus, Aristonicus, an illegitimate son of Eumenes II. of Pergamum, laid claim to the kingdom, which had been bequeathed by Attalus III. to Rome. Both consuls were anxious to obtain the command against him; Crassus was pontifex maximus, and Flaccus a flamen of Mars. Crassus declared that Flaccus could not neglect his sacred office, and imposed a conditional fine on him in the event of his leaving Rome. The popular assembly remitted the fine, but Flaccus was ordered to obey the pontifex maximus. Crassus accordingly proceeded to Asia, although in doing so he violated the rule which forbade the pontifex maximus to leave Italy. Nothing is known of his military operations. But in the following year, when he was making preparations to return, he was surprised near Leucæ. He was himself taken prisoner by a Thracian band, and provoked his captors, who were ignorant of his identity, to put him to death. Crassus does not seem to have possessed much military ability, but he was greatly distinguished for his knowledge of law and his accomplished oratory. He had acquired such a mastery of the Greek language that, when he presided over the courts in Asia, he was able to answer each suitor in ordinary Greek or any of the dialects in use.

Cicero, *De oratore*, i. 50; *Philippics*, xi. 8; Plutarch, *Tib. Gracchus*, 21; Livy, *Epit.* 59; Val. Max. iii. 2. 12, viii. 7. 6; Vell. Pat. ii. 4; Justin xxxvi. 4; Orosius v. 10.

2. **LUCIUS LICINIUS CRASSUS** (140-91 B.C.), the orator, of unknown parentage. At the age of nineteen (or twenty-one) he made his reputation by a speech against C. Papirius Carbo, the friend of the Gracchi. The law passed by him and his colleague Q. Mucius Scaevola during their consulship (95), to prevent those passing as Roman citizens who had no right to the title, was one of the prime causes of the Social War (Cicero, *Pro Balbo*, xxi., *De officiis*, iii. 11). During his censorship Crassus suppressed the newly founded schools of Latin rhetoricians (Aulus Gellius

xv. 11). He died from excitement caused by his passionate speech against the consul L. Marcius Philippus, who had insulted the Senate. Crassus is one of the chief speakers in the *De oratore* of Cicero, who has also preserved a few fragments of his speeches.

3. PUBLIUS LICINIUS CRASSUS, called *Dives*, father of the triumvir. Little is known of him before he became consul in 97, except that he proposed a law regulating the expenses of the table, which met with general approval. During his consulship the practice of magic arts was condemned by a decree of the senate, and human sacrifice was abolished. He was subsequently governor of Spain for some years, during which he gained several successes over the Lusitanians, and on his return in 93 was honoured with a triumph. After the Social War, as censor with L. Julius Caesar, he had the task of enrolling in new tribes certain of the Latins and Italians as a reward for their loyalty to the Romans, but the proceedings seem to have been interrupted by certain irregularities. They also forbade the introduction of foreign wines and unguents. Crassus committed suicide in 87, to avoid falling into the hands of the Marian party.

Plutarch, *Crassus*, 4; Aulus Gellius ii. 24; Macrobius, *Saturnalia*, ii. 13; Livy, *Epit.* 80; Pliny, *Nat. Hist.* xxx. 3; Appian, *Bell. Civ.* i. 72; Festus, under *Referris*.

4. MARCUS LICINIUS CRASSUS (c. 115–53 B.C.), the Triumvir, surnamed *Dives* (rich) on account of his great wealth. His wealth was acquired by traffic in slaves, the working of silver mines, and judicious purchases of lands and houses, especially those of proscribed citizens. The proscription of Cinna obliged him to flee to Spain; but after Cinna's death he passed into Africa, and thence to Italy, where he ingratiated himself with Sulla. Having been sent against Spartacus, he gained a decisive victory, and was honoured with a minor triumph. Soon afterwards he was elected consul with Pompey, and (70) displayed his wealth by entertaining the populace at 10,000 tables, and distributing sufficient corn to last each family three months. In 65 he was censor, and in 60 he joined Pompey and Caesar in the coalition known as the first triumvirate. In 55 he was again consul with Pompey, and a law was passed, assigning the provinces of the two Spains and Syria to the two consuls for five years. Crassus was satisfied with Syria, which promised to be an inexhaustible source of wealth. Having crossed the Euphrates he hastened to make himself master of Parthia; but he was defeated at Carrhae (53 B.C.) and taken prisoner by Surenas, the Parthian general, who put him to death by pouring molten gold down his throat. His head was cut off and sent to Orodes, the Parthian king. Crassus was a man of only moderate abilities, and owed his importance to his great wealth.

See Plutarch's *Life*; also CAESAR, GAIUS JULIUS; POMPEY; ROME: *History*, II. "The Republic."

**CRATER**, the cavity at the mouth of a volcanic duct, usually funnel-shaped or presenting the form of a bowl, whence the name, from the Gr. *κράτης*, a bowl. A volcanic hill may have a single crater at, or near, its summit, or it may have several minor craters on its flanks: the latter are sometimes called "adventitious craters" or "craterlets." Much of the loose ejected material, falling in the neighbourhood of the vent, rolls down the inner wall of the crater, and thus produces a stratification with an inward dip. The crater in an active volcano is kept open by intermittent explosions, but in a volcano which has become dormant or extinct the vent may become plugged, and the bowl-shaped cavity may subsequently be filled with water, forming a crater-lake, or as it is called in the Eifel a *Maar*. In some basaltic cones, like those of the Sandwich Islands, the crater may be a broad shallow pit, having almost perpendicular walls, with horizontal stratification. Such hollows are consequently called pit-craters. The name *caldera* (Sp. for cauldron) was suggested for such pits by Capt. C. E. Dutton, who regarded them as having been formed by subsidence of the walls. The term *caldera* is often applied to bowl-shaped craters in Spanish-speaking countries. (See VOLCANO.)

**CRATES**, Athenian actor and author of comedies, flourished about 470 B.C. He was regarded as the founder of Greek comedy proper, since he abandoned political lampoons on individuals, and introduced more general subjects and a well-developed plot

(Aristotle, *Poëtica*, 5). He is stated to have been the first to represent the drunkard on the stage (Aristophanes, *Knights*, 37 ff.).

Fragments in Meineke, *Poëtarum Comicorum Graecorum fragmenta*, i.

**CRATES**, the name of two Greek philosophers.

1. CRATES, of Athens, successor of Polemo as leader of the Old Academy.

2. CRATES, of Thebes, a Cynic philosopher of the latter half of the 4th century. He was the famous pupil of Diogenes, and the last great representative of Cynicism. It is said that he lost his ample fortune owing to the Macedonian invasion, but a more probable story is that he sacrificed it in accordance with his principles, directing the banker, to whom he entrusted it, to give it to his sons if they should prove fools, but to the poor if his sons should prove philosophers. He gave up his life to the attainment of virtue and the propagation of ascetic self-control. His habit of entering houses for this purpose, uninvented, earned him the nickname *Θυρανοικίτης* ("Door-opener"). His marriage with Hipparchia, daughter of a wealthy Thracian family, was in curious contrast to the prosaic character of his life. Attracted by the nobility of his character and undeterred by his poverty and ugliness, she insisted on becoming his wife in defiance of her father's commands. The date of his death is unknown, though he seems to have lived into the 3rd century. His writings were few. According to Diogenes Laërtius, he was the author of a number of letters on philosophical subjects; but those extant under the name of Crates (R. Hercher, *Epistolographi Graeci*, 1873) are spurious, the work of later rhetoricians. Diogenes Laërtius credits him with a short poem, *Παλγυρία*, and several philosophic tragedies. Plutarch's life of Crates is lost. The great importance of Crates' work is that he formed the link between Cynicism and the Stoics, Zeno of Citium being his pupil.

See N. Postumus, *De Cratele Cynico* (1823); F. Mullach, *Frag. Philosophorum Graecorum*, ii. (1867); E. Wellmann in Ersch and Gruber's *Allgemeine Encyclopädie*; Diog. Laërt. vi. 85–93, 96–98.

**CRATES**, of Mallus in Cilicia, a Greek grammarian and Stoic philosopher of the 2nd century B.C., leader of the literary school and head of the library of Pergamum. His principles were opposed to those of Aristarchus, the leader of the Alexandrian school. He was the chief representative of the allegorical theory of exegesis, and maintained that Homer intended to express scientific or philosophical truths in the form of poetry. About 170 B.C. he visited Rome as ambassador of Attalus II., king of Pergamum; and having broken his leg and been compelled to stay there for some time, he delivered lectures which gave the first impulse to the study of grammar and criticism among the Romans (Suetonius, *De grammaticis*, 2). His chief work was a critical and exegetical commentary on Homer.

See C. Wachsmuth, *De Cratele Mallota* (1860), containing an account of the life, pupils and writings of Crates; J. E. Sandys, *Hist. of Class. Schol.* i. 156 (ed. 2, 1906).

**CRATINUS** (c. 520–423 B.C.), Athenian comic poet, chief representative of the old, and founder of political, comedy. Hardly anything is known of his life, and only fragments of his works have been preserved. But a good idea of their character can be gained from the opinions of his contemporaries, especially Aristophanes. His comedies were chiefly distinguished by their direct and vigorous political satire, a marked exception being the burlesque *Ὀδυσσεύς*, dealing with the story of Odysseus in the cave of Polyphemus, probably written while a law was in force forbidding all political references on the stage. They were also remarkable for the absence of the parabasis and chorus. Persius calls the author "the bold," and even Pericles at the height of his power did not escape his vehement attacks, as in the *Nemesis* and *Archilochi*, the last-named a lament for the loss of the recently deceased Cimon, with whose conservative sentiments Cratinus was in sympathy. The *Panoptae* was a satire on the sophists and omniscient speculative philosophers of the day. Of his last comedy the plot has come down to us. It was occasioned by the sneers of Aristophanes and others, who declared that he was no better than a doting drunkard. Roused by the taunt, Cratinus put forth all his strength, and in 423 B.C. produced the *Πυρρίων*,

or *Bottle*, which gained the first prize over the *Clouds* of Aristophanes. In this comedy, good-humouredly making fun of his own weakness, Cratinus represents the comic muse as the faithful wife of his youth. His guilty fondness for a rival—the bottle—has aroused her jealousy. She demands a divorce from the archon; but her husband's love is not dead and he returns penitent to her side. In Grenfell and Hunt's *Oxyrhynchus Papyri*, iv. (1904), containing a further instalment of their edition of the Behnesa papyri discovered by them in 1896–1897, one of the greatest curiosities is a scrap of paper bearing the argument of a play by Cratinus,—the *Dionysalexandros* (i.e. Dionysus in the part of Paris), aimed against Pericles; and the epitome reveals something of its wit and point. The style of Cratinus has been likened to that of Aeschylus; and Aristophanes, in the *Knights*, compares him to a rushing torrent. He appears to have been fond of lofty diction and bold figures, and was most successful in the lyrical parts of his dramas, his choruses being the popular festal songs of his day. According to the statement of a doubtful authority, which is not borne out by Aristotle, Cratinus increased the number of actors in comedy to three. He wrote 21 comedies and gained the prize nine times.

Fragments in Meineke, *Fragmenta Comicorum Graecorum*, or Kock, *Comicorum Atticorum fragmenta*. A younger Cratinus flourished in the time of Alexander the Great. It is considered that some of the comedies ascribed to the elder Cratinus were really the work of the younger.

**CRATIPPUS** (fl. c. 375 B.C.), Greek historian. There are only three or four references to him in ancient literature, and his importance is due to the fact that he has been identified by several scholars (e.g. Blass) with the author of the historical fragment discovered by Grenfell and Hunt, and published by them in *Oxyrhynchus Papyri*, vol. v. It may be regarded as a fairly certain inference from a passage in Plutarch (*De Gloria Atheniensium*, p. 345 E, ed. Bernardakis, ii. p. 455) that he was an Athenian writer, intermediate in date between Thucydides and Xenophon, and that his work continued the narrative of Thucydides, from the point at which the latter historian stopped (410 B.C.) down to the battle of Cnidus (394 B.C.).

The fragments are published in C. Müller's *Fragmenta Historicorum Graecorum*. For authorities see under THEOPOMPUS.

**CRATIPPUS**, of Mitylene (1st century B.C.), Peripatetic philosopher, contemporary with Cicero, whose son he taught at Athens, and by whom he is praised in the *De officiis* as the greatest of his school. He was the friend of Pompey also and shared his flight after the battle of Pharsalia, for the purpose, it is said, of convincing him of the justice of providence. Brutus, while at Athens after the assassination of Caesar, attended his lectures. The freedom of Rome was conferred upon him by Caesar, at the request of Cicero. The only work attributed to him is a treatise on divination, but his reputation may be gauged by the fact that in 44 B.C. the Areopagus invited him to succeed Andronicus of Rhodes as scholarch. He seems to have held that, while motion, sense and appetite cannot exist apart from the body, thought reaches its greatest power when most free from bodily influence, and that divination is due to the direct action of the divine mind on that faculty of the human soul which is not dependent on the body.

Cicero, *De divinatione*, i. 3, 32, 50, ii. 48, 52; *De officiis*, i. 1, iii. 2; Plutarch, *Cicero*, 24.

**CRAU** (from a Celtic root meaning "stone"), a region of southern France, comprised in the department of Bouches-du-Rhône, and bounded W. by the canal from Arles to Port du Bouc and the Rhone, N. by the chain of the Alpines separating it from an analogous region, the Petite Crau, E. by the hills around Salon and Istres, S. by the gulf of Fos, an inlet of the Mediterranean Sea. Covering an area of about 200 sq. m., the Crau is a low-lying, waterless plain, owing its formation to a sudden inundation, according to some authorities, of the Rhone and the Durance, according to others of the Durance alone. Its surface is formed chiefly of stones varying in size from an egg to a man's head; these, mixed with a proportion of fine soil, overlies a subsoil formed of stones cemented into a hard mass by deposits of calcareous mud, beneath which lies a bed of loose stones, once the

sea-bed. Naturally sterile and poor in lime, the Crau is adapted for agriculture by the process of warping, carried out by means of the Canal de Crau, which dates from the middle of the 16th century; about one-quarter of the region in the north and east has thus been covered by the rich deposits of the waters of the Durance. The soil also responds in places to deep cultivation and the application of artificial manures. By these aids, uncultivated land, which before supplied only rough and scanty pasture for a few sheep, has been fitted for the growth of the vine, olive and other fruits; where irrigation is practicable, water-meadows have been formed. The dryness of the climate is unfavourable to the production of cereals.

**CRAUCK, GUSTAVE** (1827–1905), French sculptor, was born and died at Valenciennes, where a special museum for his works was erected in his honour. Though little known to the world at large during his long life, he ranks among the best modern sculptors of France. At Paris his "Coligny" monument is in the rue de Rivoli; his "Victory" in the Place des Arts et Métiers; and "Twilight" in the Avenue de l'Observatoire. Among his finest works is his "Combat du Centaure," on which he was engaged for thirty years, the figure of the Lapith having been modelled after the athlete, Eugene Sandow. In 1907 an exhibition of his works was held in the École des Beaux-Arts.

**CRAUFURD, QUINTIN** (1743–1819), British author, was born at Kilwinnock on the 22nd of September 1743. In early life he went to India, where he entered the service of the East India Company. Returning to Europe before the age of forty with a handsome fortune, he settled in Paris, where he gave himself to the cultivation of literature and art, and formed a good library and collection of paintings, coins and other objects of antiquarian interest. Craufurd was on intimate terms with the French court, especially with Marie Antoinette, and was one of those who arranged the flight to Varennes. He escaped to Brussels, but in 1792 he returned to Paris in the hope of rescuing the royal prisoners. He lived among the French émigrés until the peace of Amiens made it possible to return to Paris. Through Talleyrand's influence he was able to remain in Paris after the war was renewed, and he died there on the 23rd of November 1819.

He wrote, among other works, *The History, Religion, Learning and Manners of the Hindus* (1790), *Secret History of the King of France and his Escape from Paris* (first published in 1885), *Researches concerning the Laws, Theology, Learning and Commerce of Ancient and Modern India* (1817), *History of the Bastille* (1798), *On Pericles and the Arts in Greece* (1815), *Essay on Swift and his Influence on the British Government* (1808), *Notice sur Marie Antoinette* (1809), *Mémoires de Mme du Hausset* (1808).

**CRAUFURD, ROBERT** (1764–1812), British major-general, was born at Newark, Ayrshire, on the 5th of May 1764, and entered the 25th Foot in 1779. As captain in the 75th regiment he first saw active service against Tipoo Sahib in 1790–92. The next year he was employed, under his brother Charles, with the Austrian armies operating against the French. Returning to England in 1797, he soon saw further service, as a lieutenant-colonel, on Lake's staff in the Irish rebellion. A year later he was British commissioner on Suvarov's staff when the Russians invaded Switzerland, and at the end of 1799 was in the Helder expedition. From 1801 to 1805 Lieutenant-Colonel Craufurd sat in parliament for East Retford, but in 1807 he resumed active service with Whitelock in the unfortunate Buenos Aires expedition. He was almost the only one of the senior officers who added to his reputation in this affair, and in 1808 he received a brigade command under Sir John Moore. His regiments were heavily engaged in the earlier part of the famous retreat, but were not present at Corunna, having been detached to Vigo, whence they returned to England. Later in 1809, once more in the Peninsula, Brigadier-General Craufurd was three marches or more in rear of Wellesley's army when a report came in that a great battle was in progress. The march which followed is one almost unparalleled in military annals. The three battalions of the "Light Brigade" (43rd, 52nd and 95th) started in full marching order, and arrived at the front on the day after the battle of Talavera, having covered 62 m. in twenty-six hours. Beginning their career with this famous march, these regiments and their



chief, under whom served such men as Charles and William Napier, Shaw and Colborne, soon became celebrated as one of the best corps of troops in Europe, and every engagement added to their laurels. Craufurd's operations on the Coa and Agueda in 1810 were daring to the point of rashness, but he knew the quality of the men he led better than his critics did, and though Wellington censured him for his conduct, he at the same time increased his force to a division by the addition of two picked regiments of Portuguese *Caçadores*. The conduct of the renowned "Light Division" at Busaco is described by Napier in one of his most vivid passages. The winter of 1810-1811 Craufurd spent in England, and his division was commanded in the interim by another officer, who did not display much ability. He reappeared on the field of the battle of Fuentes d'Onoro amidst the cheers of his men and nothing could show his genius for war better than his conduct on this day, in covering the strange readjustment of his line which Wellington was compelled to make in the face of the enemy. A little later he obtained major-general's rank; and on the 19th of January 1812, as he stood on the glacis of Ciudad Rodrigo, directing the stormers of the Light Division, he fell mortally wounded. His body was carried out of action by his staff officer, Lieutenant Shaw of the 43rd (see SHAW KENNEDY), and, after lingering four days, he died. He was buried in the breach of the fortress where he had met his death, and a monument in St Paul's cathedral commemorates Craufurd and Mackinnon the two generals killed at the storming of Ciudad Rodrigo. The exploits of Craufurd and the Light Division are amongst the most cherished traditions of the British and Portuguese armies. One of the quickest and most brilliant, if not the very first, of Wellington's generals, he had a fiery temper, which rendered him a difficult man to deal with, but to the day of his death he possessed the confidence and affection of his men in an extraordinary degree.

His elder brother, Lieutenant-General Sir CHARLES CRAUFURD (1761-1821), entered the 1st Dragoon Guards in 1778. Made captain in the Queen's Bays in 1785, he became the equerry and intimate friend of the duke of York. He studied in Germany for some time, and with his brother Robert's assistance, translated Tielcke's book on the Seven Years' War (*The Remarkable Events of the War between Prussia, Austria and Russia from 1756 to 1763*). As aide-de-camp he accompanied the duke of York to the French War in 1793, and was at once sent as commissioner to the Austrian headquarters, with which he was present at Neerwinden, Caesar's Camp, Famars, Landrecies, &c. Major in 1793, and lieutenant-colonel in 1794, he returned to the English army in the latter year, and on one occasion distinguished himself at the head of two squadrons, taking 3 guns and 1000 prisoners. When the British army left the continent Craufurd was again attached to the Austrian army, and was present at the actions on the Lahn, the combat of Neumarkt, and the battle of Amberg. At the last battle a severe wound rendered him incapable of further service, and cut short a promising career. He succeeded his brother Robert as member of parliament for East Retford (1806-1812). He died in 1821, having become a lieutenant-general and a G.C.B.

**CRAVAT** (from the Fr. *cravate*, a corruption of "Croat"), the name given by the French in the reign of Louis XIV. to the scarf worn by the Croatian soldiers enlisted in the royal Croatian regiment. Made of linen or muslin with broad edges of lace, it became fashionable, and the name was applied both in England and France to various forms of neckerchief worn at different times, from the loosely tied lace cravat with long flowing ends, called a "Steinkirk" from the battle of 1692 of that name, to the elaborately folded and tightly starched linen or cambric neckcloth worn during the period of Beau Brummell.

**CRAVEN, PAULINE MARIE ARMANDE AGLAÉ** (1808-1891), French author, the daughter of an *émigré* Breton nobleman, was born in London on the 12th of April 1808. Her father, the comte Auguste de la Ferronnays, was a close friend of the duc de Berri, whom he accompanied on his return to France in 1814. He and his wife were attached to the court of Charles X. at the Tuileries, but a momentary quarrel with the duc de Berri made

retirement imperative to the count's sense of honour. He was appointed ambassador at St Petersburg, and in 1827 became foreign minister in Paris. Pauline was thus brought up in brilliant surroundings, but her strongest impressions were those which she derived from the group of Catholic thinkers gathered round Lamennais, and her ardent piety furnishes the key of her life. In 1828 her father was sent to Rome, and Pauline, at the suggestion of Alexis Rio, the art critic, made her first literary essay with a description of the emotions she experienced on a visit to the catacombs. At the revolution of July, M. de la Ferronnays resigned his position, and retired with his family to Naples. Here Pauline met her future husband, Augustus Craven, who was then attaché to the British embassy. His father, Keppel Richard Craven, the well-known supporter of Queen Caroline, objected to his son's marriage with a Catholic; but his scruples were overcome, and immediately after the marriage (1834) Augustus Craven was received into the Roman Catholic Church. Mrs Craven, whose family life as revealed in the *Récit d'une sœur* was especially tender and intimate, suffered several severe bereavements in the years following on her marriage. The Cravens lived abroad until 1851, when the death of Keppel Craven made his son practically independent of his diplomatic career, in which he had not been conspicuously successful. He stood unsuccessfully for election to parliament for Dublin in 1852, and from that time retired into private life. They went to live at Naples in 1853, and Mrs Craven began to write the history of the family life of the la Ferronnays between 1830 and 1836, its incidents being grouped round the love story of her brother Albert and his wife Alexandrine. This book, the *Récit d'une sœur* (1866, Eng. trans. 1868), was enthusiastically received and was awarded a prize by the French Academy. Straitened circumstances made it desirable for Mrs Craven to earn money by her pen. *Anne Stéverin* appeared in 1868, *Fleurange* in 1871, *Le Mot d'énigme* in 1874, *Le Valbriant* (Eng. trans., *Lucia*) in 1886. Among her miscellaneous works may be mentioned *La Sœur Natalie Narischkin* (1876), *Deux Incidents de la question catholique en Angleterre* (1875), *Lady Georgiana Fullerton, sa vie et ses œuvres* (1888). Mrs Craven's charming personality won her many friends. She was a frequent guest with Lord Palmerston, Lord Ellesmere and Lord Granville. She died in Paris on the 1st of April 1891. Her husband, who died in 1884, translated the correspondence of Lord Palmerston and of the Prince Consort into French.

See *Memoir of Mrs Augustus Craven* (1894), by her friend Mrs Mary Catherine Bishop; also *Paulina Craven*, by T. F. Ravaschieri Fieschi (1892). There is a biography of Mrs Craven's father, "En Emigration," in Étienne Lamy's *Témoins des jours passés* (1907).

**CRAVEN, WILLIAM CRAVEN, EARL OF** (1608-1697), eldest son of Sir William Craven, lord mayor of London, and of Elizabeth, daughter of Alderman William Whitmore, was born in June 1608, matriculated at Trinity College, Oxford, in 1623, and joined the society of the Middle Temple in 1624. He had already inherited his father's vast fortune by the latter's death in 1618, and before he came of age he had distinguished himself in the military service of the princes of Orange. Returning home he was knighted and created Baron Craven of Hampstead Marshall in Berkshire in 1627. He early showed enthusiasm for the cause of the unfortunate king and queen of Bohemia, driven from their dominions, and in 1632 joined Frederick in a military expedition to recover the Palatinate, meeting Gustavus Adolphus at Höchst, whose praise he gained by being the first, though wounded, to mount the breach at the capture of Kreuznach on the 22nd of February. The Swedish king, however, refused to allow the elector an independent command for the defence of the Palatinate, and Craven returned to England. In May 1633 he was placed on the council of Wales. In 1637 he took part in a second expedition in aid of the palatine family on the Lower Rhine, with the young elector Charles Louis and his brother Rupert, and offered as a contribution the sum of £30,000, but their forces were defeated near Wessel and Craven wounded and taken prisoner together with Rupert. He purchased his freedom in 1639, and then joined the small court of the exiled queen

Elizabeth at the Hague and at Rhenen, supplying her generously with funds on the cessation of her English pension owing to the outbreak of the Civil War. He contributed also large sums in aid of Charles I., and, after his execution, of Charles II., the amount bestowed upon the latter being alone computed at £50,000,<sup>1</sup> notwithstanding that since 1651 the greater part of his estates had been confiscated by the parliament and his house at Caversham reduced to ruins.<sup>2</sup> At the Restoration he accompanied Charles to England, regained his estates, and was rewarded with offices and honours. He was made colonel of several regiments including the Coldstream, and in 1667 lieutenant-general and also high steward of Cambridge University. In 1666 he became a privy councillor, but was not included later in 1679 in Sir William Temple's remodelled council.<sup>3</sup> In 1668 he became a governor of the Charterhouse, was appointed lord-lieutenant of Middlesex, and master of the Trinity House in 1670; and in 1673 a commissioner for Tangier. He was one of the lords proprietors of Carolina and a member of the Fishery Committee.

In March 1664 he was created viscount and earl of Craven. Meanwhile his devotion to the interests of the queen of Bohemia was unceasing, and on her return to England he offered her hospitality at his house in Drury Lane, where she remained till February 1662. At her death, within a fortnight afterwards, she bequeathed to Craven her papers and her valuable collection of portraits, but there is no foundation for the belief entertained later that she had married him. In 1682 he became the guardian of Ruperta, the natural daughter of his old comrade in arms, Prince Rupert. He was again made a privy councillor and lieutenant-general of the forces by James on his accession, and at the age of eighty was in command of the Coldstreams at Whitehall on the 17th of December 1688 when the Dutch troops arrived. He refused to withdraw them at the bidding of Count Solms, the Dutch commander, but obeyed later James's own orders to retire. His public career now closed and he filled no office after the revolution. Although his claims upon the gratitude of the Stuart royal family were immense, Craven had never been considered a possible candidate for high political place. His ability was probably small, and he is spoken of with little respect in the *Verney Papers* and by the electress Sophia in her *Memoirs*. The latter retails some foolish observations made by Craven, and Pepys was disgusted at his coarse and stupid jests at the Fishery Board, where his "very confused and very ridiculous proceedings" are also censured.<sup>4</sup> His military prowess, however, his generosity and his public spirit are undoubted. He showed great activity during the plague and fire of London. He was a patron of letters and a member of the Royal Society. He inherited Combe Abbey near Coventry from his father, and purchased Hampstead Marshall in Berkshire, where he built a house on the model of Heidelberg Castle.

He died unmarried on the 9th of April 1697, when the earldom became extinct, the barony passing by special remainder to his cousin William, 2nd Baron Craven; the present earl of Craven (the earldom being revived in 1801) is descended from John, a younger brother of the latter. The first Lord Craven's brother John, who was created Baron Craven of Ryton in Shropshire and who died in 1648, was the founder of the Craven scholarships at Oxford and Cambridge universities, of which the first was awarded in 1649.

**BIBLIOGRAPHY.**—See the article in the *Dict. of Nat. Biography* (and Errata); *Lives of the Princesses of England* (*Elizabeth, eldest daughter of James I.*), vol. vi., by M. A. E. Green (1854); *Memoirs of Elizabeth Stuart*, by Miss Benger (1825); *Memoiren der Herzogin Sophie*, ed. by A. Köcher in *Publ. aus den k. preussischen Staatsarchiven*, Bd. iv. (1879); "Briefe der Elisabeth Stuart" in *Bibliothek des literarischen Vereins* (Stuttgart, 1903), 155, 157; G. E. C.'s *Complete Peerage* (1889), ii. 404; *Lives and Characters of the Most Illustrious Persons* (1713), p. 546; Macaulay's *Hist. of England*, ii. 584 (1858); *Verney Papers* (Camden Soc., 1853); *Cal. of St. Pap. Dom.*; Tracts relating to the confiscation of his estate in *Cat. of the British Museum*. Much information also doubtless exists in the Craven MSS. at Combe Abbey. (P. C. Y.)

<sup>1</sup> *Verney Papers*, 189 note.

<sup>2</sup> Evelyn's *Diary*, June 8th, 1654.

<sup>3</sup> *Hist. MSS. Com.: Various Collections*, ii. 394.

<sup>4</sup> *Diary*, Oct. 18th and Nov. 18th, 1664, and March 10th, 1665.

**CRAWFORD, EARLS OF.** The house of Lindsay, of which the earl of Crawford is the head, traces its descent back to the barons of Crawford who flourished in the 12th century, and has included a number of men who have played leading parts in the history of Scotland. It is said that "though other families in Scotland may have been of more historic, none can in genealogical importance equal that of Lindsay," and the Lindsays claim that "the predecessors of the 1st earl of Crawford were barons at the period of the earliest parliamentary records, and that, in fact, they were never enrolled in the modern sense of the term, but were among the *pares*, of which kings are *primi*, from the commencement of recorded history." Again we are told, "the earldom of Crawford, therefore, like those of Douglas, of Moray, Ross, March and others of the earlier times of feudalism, formed a petty principality, an *imperium in imperio*." Moreover, the earls "had also a *conalium*, or petty parliament, consisting of the great vassals of the ealdom, with whose advice they acted on great and important occasions."

Sir James Lindsay (d. 1396), 9th lord of Crawford in Inverclyde, was the only son of Sir James Lindsay, the 8th lord (d. c. 1357), and was related to King Robert II.; he was descended from Sir Alexander Lindsay of Luffness (d. 1309), who obtained Crawford and other estates in 1297 and who was high chamberlain of Scotland. The 9th lord fought at Otterburn, and Froissart tells of his wanderings after the fight. He was succeeded by his cousin, Sir David Lindsay (c. 1360-1407), son of Sir Alexander Lindsay of Glenesk (d. 1382), and in 1398 Sir David, who married a daughter of Robert II., was made earl of Crawford.

The most important of the early earls of Crawford are the 4th and the 5th earls. Alexander Lindsay, the 4th earl (d. 1454), called the "tiger earl," was, like his father David the 3rd earl, who was killed in 1446, one of the most powerful of the Scottish nobles; for some time he was in arms against King James II., but he submitted in 1452. His son David, the 5th earl (c. 1440-1495), was lord high admiral and lord chamberlain; he went frequently as an ambassador to England and was created duke of Montrose in 1488, but the title did not descend to his son. Montrose fought for James III. at the battle of Sauchieburn, and his son John, the 6th earl (d. 1513), was slain at Flodden.

David Lindsay, 8th earl of Crawford (d. 1542), son of Alexander, the 7th earl (d. 1517), had a son Alexander, master of Crawford (d. 1542), called the "wicked master," who quarrelled with his father and tried to kill him. Consequently he was sentenced to death, and the 8th earl conveyed the earldom to his kinsman, David Lindsay of Edzell (d. 1558), a descendant of the 3rd earl of Crawford, thus excluding Alexander and his descendants, and in 1542 David became 9th earl of Crawford. But the 9th earl, although he had at least two sons, named the wicked master's son David as his heir, and consequently in 1558 the earldom came back to the elder line of the Lindsays, the 9th earl being called the "interpolated earl."

David Lindsay, 10th earl of Crawford (d. 1577), was a supporter of Mary Queen of Scots; he was succeeded by his son David (c. 1547-1607) as 11th earl. This David, a grandson of Cardinal Beaton, was concerned in some of the risings under James VI.; he was converted to Roman Catholicism and was in communication with the Spaniards about an invasion of England. After his death the earldom passed to his son David I. (1621), a lawless ruffian, and then to his brother, Sir Henry Lindsay or Charteris (d. 1623), who became 13th earl of Crawford. Sir Henry's three sons became in turn earls of Crawford, the youngest, Ludovic, succeeding in 1639.

Ludovic Lindsay, 16th earl of Crawford (1600-1652), took part in the strange plot of 1641 called the incident. Having joined Charles I. at Nottingham in 1642, he fought at Edgehill, at Newbury and elsewhere during the Civil War; in 1644, just after Marston Moor, the Scottish parliament deposed he had forfeited his earldom, and, following the lines laid down when this was regranted in 1642, it was given to John Lindsay, 1st earl of Lindsay. Ludovic was taken prisoner at Newcastle in 1644 and was condemned to death, but the sentence was not carried out, and in 1645 he was released by Montrose under whom he served until the surrender of the king at Nerik. Later he was in

Ireland and in Spain and he died probably in France in 1652. He left no issue.

The earl of Lindsay, who thus supplanted his kinsman, belonged to the family of Lindsay of the Byres, a branch of the Lindsays descended from Sir David Lindsay of Crawford (d. c. 1355), the grandfather of the 1st earl of Crawford. Sir David's descendant, Sir John Lindsay of the Byres (d. 1482), was created a lord of parliament as Lord Lindsay of the Byres in 1445, and his son David, the 2nd lord (d. 1490), fought for James III. at the battle of Sauchieburn. The most prominent member of this line was Patrick, 6th Lord Lindsay of the Byres (d. 1589), a son of John the 5th lord (d. 1563), who was a temperate member of the reforming party. Patrick was one of the first of the Scottish nobles to join the reformers, and he was also one of the most violent. He fought against the regent, Mary of Lorraine, and the French; then during a temporary reconciliation he assisted Mary, queen of Scots, to crush the northern rebels at Corrichie in 1562, but again among the enemies of the queen he took part in the murder of David Rizzio and signed the bond against Bothwell, whom he wished to meet in single combat after the affair at Carberry Hill in 1565. Lindsay, who was a brother-in-law and ally of the regent Murray, carried Mary to Lochleven castle and obtained her signature to the deed of abdication; he fought against her at Langside, and after Murray's murder he was one of the chiefs of the party which supported the throne of James VI. In 1578, however, he was among those who tried to drive Morton from power, and in 1582 he helped to seize the person of the king in the plot called the "raid of Ruthven," afterwards escaping to England. Lindsay had returned to Scotland when he died on the 11th of December 1589. His successor was his son, James the 7th lord (d. 1601).

Patrick's great-grandson, John Lindsay, 17th earl of Crawford and 1st earl of Lindsay (c. 1598-1678), was the son of Robert Lindsay, 9th Lord Lindsay of the Byres, whom he succeeded as 10th lord in 1616. In 1633 he was created earl of Lindsay, and having become a leader of the Covenanters he marched with the Scottish army into England in 1644 and was present at Marston Moor; in 1644 also he obtained the earldom of Crawford in the manner already mentioned. In the same year he became lord high treasurer of Scotland, and in 1645 president of the parliament. Having fought against Montrose at Kilsyth, the earl of Crawford-Lindsay, as he was called, changed sides, and in 1647 he signed the "engagement" for the release of Charles I., losing all his offices by the act of classes when his enemy, the marquess of Argyll, obtained the upper hand. After the defeat of the Scots at Dunbar, however, Crawford regained his influence in Scottish politics, but from 1651 to 1660 he was a prisoner in England. In 1661 he was restored to his former dignities, but his refusal to abjure the covenant compelled him to resign them two years later. His son, William, 18th earl of Crawford and 2nd earl of Lindsay (1644-1698), was, like his father, an ardent covenanter; in 1690 he was president of the Convention parliament. Mr Andrew Lang says this earl was "very poor, very presbyterian, and his letters, almost alone among those of the statesmen of the period, are rich in the texts and unctuous style of an older generation."

William's grandson, John Lindsay, 20th earl of Crawford and 4th earl of Lindsay (1702-1749), won a high reputation as a soldier. He held a command in the Russian army, seeing service against the Turk, and he also served against the same foe under Prince Eugene. Having returned to the English army he led the life-guards at Dettingen and distinguished himself at Fontenoy; later he served against France in the Netherlands. He left no sons when he died in December 1749, and his kinsman, George Crawford-Lindsay, 4th Viscount Garnock (c. 1723-1781), a descendant of the 17th earl, became 21st earl of Crawford and 5th earl of Lindsay. When George's son, George, the 22nd earl (1758-1808), died unmarried in January 1808, the earldoms of Crawford and Lindsay were separated, George's kinsman, David Lindsay (d. 1809), a descendant of the 4th Lord Lindsay of the Byres, becoming 7th earl of Lindsay. Both David and his successor Patrick (d. 1839) died without sons, and in 1878 the

House of Lords decided that Sir John Trotter Bethune, Bart. (1827-1894), also a descendant of the 4th Lord Lindsay of the Byres, was entitled to the earldom. In 1894 John's cousin, David Clark Bethune (b. 1832), became 11th earl of Lindsay.

The earldom of Crawford remained dormant from 1808, when this separation took place, until 1848, when the House of Lords adjudged it to James Lindsay, 7th earl of Balcarres.

The earls of Balcarres are descended from John Lindsay, Lord Menmuir (1552-1598), a younger son of David Lindsay, 9th earl of Crawford. John, who bought the estate of Balcarres in Fifeshire, became a lord of session as Lord Menmuir in 1581; he was a member of the Scottish privy council and one of the commissioners of the treasury called the Octavians. He had great influence with James VI., helping the king to restore episcopacy after he had become, in 1595, keeper of the privy seal and a secretary of state. Menmuir, a man of great intellectual attainments, left two sons, the younger, David, succeeding to the family estates on his brother's death in 1601. David (c. 1586-1641), a notable alchemist, was created Lord Lindsay of Balcarres in 1633, and in 1651 his son Alexander was made earl of Balcarres.

Alexander Lindsay, 1st earl of Balcarres (1618-1659), the "Rupert of the Covenant," fought against Charles I. at Marston Moor, at Alford and at Kilsyth, but later he joined the royalists, signing the "engagement" for the release of the king in 1647, and having been created earl of Balcarres took part in Glencairn's rising in 1653. Richard Baxter speaks very highly of the earl, who died at Breda in August 1659. His son Charles (d. 1662) became 2nd earl of Balcarres, and another son, Colin (c. 1654-1722), became 3rd earl. Colin, who was perhaps the most trusted of the advisers of James II., wrote some valuable *Memoirs touching the Revolution in Scotland, 1688-1690*; these were first published in 1714, and were edited for the Bannatyne Club by the 25th earl of Crawford in 1841. Having been allowed to return to Scotland after an exile in France, the earl joined the Jacobite rising in 1715. His successor was his son Alexander, the 4th earl (d. 1736), who was followed by another son, James, the 5th earl (1691-1768), who fought for the Stuarts at Sheriffmuir. Afterwards James was pardoned and entered the English army, serving under George II. at Dettingen. This earl wrote some *Memoirs of the Lindsays*, which were completed by his son Alexander, the 6th earl (1752-1825). Alexander was with the English troops in America during the struggle for independence, and was governor of Jamaica from 1794 to 1801, filling a difficult position with great credit to himself. He became a general in 1803, and died at Haigh Hall, near Wigan, which he had received through his wife, Elizabeth Dalrymple (1759-1816), on the 27th of May 1825. This earl did not claim the earldom of Crawford, although he became earl *de jure* in 1808, but in 1843 his son James Lindsay (1783-1869) did so, and in 1848 the claim was allowed by the House of Lords. James was thus 24th earl of Crawford and 7th earl of Balcarres; in 1826 he had been created a peer of the United Kingdom as Baron Wigan of Haigh Hall.

His son, Alexander William Crawford Lindsay, 25th earl of Crawford (1812-1880), was born at Muncaster Castle, Cumberland, on the 16th of October 1812, and educated at Eton and Cambridge. He travelled much in Europe and the East, and was most learned in genealogy and history. His more important works include *Lives of the Lindsays* (3 vols., 1849), *Letters on Egypt, Edom and the Holy Land* (1838), *Sketches of the History of Christian Art* (1847 and 1882), *Etruscan Inscriptions Analysed* (1872), and *The Earldom of Mar during 500 years* (1882). He succeeded to the title in September 1869, and died at Florence on the 13th of December 1880. A year later it was discovered that the family vault at Dunecht had been broken into and the body stolen. It was not until the 18th of July 1882 that the police, acting on the confession of an eye-witness of the desecration, found the remains, which were then reinterred at Haigh Hall, Wigan.

His only son, James Ludovic Lindsay, 26th earl of Crawford (1847- ), British astronomer and orientalist, was born at St Germain-en-Laye, France, on the 28th of July 1847. Educated at Eton and Trinity College, Cambridge, he devoted himself to

astronomy, in which he early achieved distinction. In 1870 he went to Cadiz to observe the eclipse of the sun, and, in 1874, to Mauritius to observe the transit of Venus. In the interval, with the assistance of his father, he had built an observatory at Dunecht, Aberdeenshire, which in 1888 he presented, together with his unique library of astronomical and mathematical works, to the New Royal Observatory on Blackford Hill, Edinburgh, where they were installed in 1895. His services to science were recognized by his election to the presidency of the Royal Astronomical Society in 1878 and 1879 in succession to Sir William Huggins, and to the fellowship of the Royal Society in 1878. He also received the degree of LL.D. from Edinburgh University in 1882, and in the following year was nominated honorary associate of the Royal Prussian Academy of Sciences. An enthusiastic bibliophile, he became a trustee of the British Museum, and acted for a term as president of the Library Association. To the free library of Wigan, Lancashire, he gave a series of oriental and English MSS. of the 9th to the 19th centuries in illustration of the progress of handwriting, while for the use of specialists and students he issued the invaluable *Bibliotheca Indesiana*. He represented Wigan in the House of Commons from 1874 till his succession to the title in 1880.

Another title held by the Lindsays was that of Spynie, Sir Alexander Lindsay (c. 1555-1607), created Baron Spynie in 1590, being a younger son of the 10th earl of Crawford. The 2nd Lord Spynie was Alexander's son, Alexander (d. 1646), who served in Germany under Gustavus Adolphus and assisted Charles I. in Scotland during the Civil War; and the 3rd lord was the latter's son, George. When George, a royalist who was taken prisoner at the battle of Worcester, died in 1671 this title became extinct.

The dukedom of Montrose, which had lapsed on the death of the 5th earl of Crawford in 1495 and had been revived in 1707 in the Graham family, was claimed in 1848 by the 24th earl of Crawford, but in 1853 the House of Lords gave judgment against the earl.

The Lindsays have furnished the Scottish church with several prelates. John Lindsay (d. 1335) was bishop of Glasgow; Alexander Lindsay (d. 1639) was bishop of Dunkeld until he was deposed in 1638; David Lindsay (d. c. 1641) was bishop of Brechin and then of Edinburgh until he, too, was deposed in 1638; and a similar fate attended Patrick Lindsay (1566-1644), bishop of Ross from 1613 to 1633 and archbishop of Glasgow from 1633 to 1638. Perhaps the most famous of the Lindsay prelates was David Lindsay (c. 1531-1613), a nephew of the 9th earl of Crawford. David, who married James VI. to Anne of Denmark at Upsala, was one of the leaders of the Kirk party; he became bishop of Ross under the new scheme for establishing episcopacy in 1600.

See Lord Lindsay (25th earl of Crawford), *Lives of the Lindsays* (1849); A. Jervise, *History and Traditions of the Land of the Lindsays* (1882); G. E. C(okayne), *Complete Peerage* (1887-1898); H. T. Folkard, *A Lindsay Record* (1899); and Sir J. B. Paul's edition of the *Scots Peerage* of Sir R. Douglas, vol. iii. (1906).

**CRAWFORD, FRANCIS MARION** (1854-1909), American author, was born at Bagni di Lucca, Italy, on the 2nd of August 1854, being the son of the American sculptor Thomas Crawford (q.v.), and the nephew of Julia Ward Howe, the American poet. He studied successively at St Paul's school, Concord, New Hampshire; Cambridge University; Heidelberg; and Rome. In 1879 he went to India, where he studied Sanskrit and edited the Allahabad *Indian Herald*. Returning to America he continued to study Sanskrit at Harvard University for a year, contributed to various periodicals, and in 1882 produced his first novel, *Mr Isaacs*, a brilliant sketch of modern Anglo-Indian life mingled with a touch of Oriental mystery. This book had an immediate success, and its author's promise was confirmed by the publication of *Dr Claudius* (1883). After a brief residence in New York and Boston, in 1883 he returned to Italy, where he made his permanent home. This accounts perhaps for the fact that, in spite of his nationality, Marion Crawford's books stand apart from any distinctively American current in literature. Year by year he published a number of successful novels: A

*Roman Singer* (1884), *An American Politician* (1884), *To Leeward* (1884), *Zoroaster* (1885), *A Tale of a Lonely Parish* (1886), *Marzio's Crucifix* (1887), *Saracinesca* (1887), *Paul Paloff* (1887), *With the Immortals* (1888), *Greifenstein* (1889), *Sant' Ilario* (1889), *A Cigarette-maker's Romance* (1890), *Khaled* (1891), *The Witch of Prague* (1891), *The Three Fates* (1892), *The Children of the King* (1892), *Don Orsino* (1892), *Marion Darce* (1893), *Pietro Ghisleri* (1893), *Katharine Lauderdale* (1894), *Love in Idiocy* (1894), *The Ralstons*, (1894), *Casa Braccio* (1895), *Adam Johnston's Son* (1895), *Taqisara* (1896), *A Rose of Yesterday* (1897), *Corleone* (1897), *Via Crucis* (1899), *In the Palace of the King* (1900), *Marietta* (1901), *Cecilia* (1902), *Whosoever Shall Offend* (1904), *Soprano* (1905), *A Lady of Rome* (1906). He also published the historical works, *Ave Roma Immortalis* (1898), *Rulers of the South* (1900)—renamed *Sicily, Calabria and Malta* in 1904,—and *Gleanings from Venetian History* (1905). In these his intimate knowledge of local Italian history combines with the romancist's imaginative faculty to excellent effect. But his place in contemporary literature depends on his novels. He was a gifted narrator, and his books of fiction, full of historic vitality and dramatic characterization, became widely popular among readers to whom the realism of "problems" or the eccentricities of subjective analysis were repellent, for he could unfold a romantic story in an attractive way, setting his plot amid picturesque surroundings, and gratifying the reader's intelligence by a style at once straightforward and accomplished. The *Saracinesca* series shows him perhaps at his best. *A Cigarette-maker's Romance* was dramatized, and had considerable popularity on the stage as well as in its novel form; and in 1902 an original play from his pen, *Francesca da Rimini*, was produced in Paris by Sarah Bernhardt. He died at Sorrento on the 9th of April 1909.

**CRAWFORD, THOMAS** (1814-1857), American sculptor, was born of Irish parents in New York on the 22nd of March 1814. He showed at an early age great taste for art, and learnt to draw and to carve in wood. In his nineteenth year he entered the studio of a firm of monumental sculptors in his native city; and in the summer of 1835 he went to Rome and became a pupil of Thorwaldsen. The first work which made him generally known as a man of genius was his group of "Orpheus entering Hades in Search of Eurydice," executed in 1839. This was followed by other poetical sculptures, among which were the "Babes in the Wood," "Flora," "Hebe and Ganymede," "Sappho," "Vesta," the "Dancers," and the "Hunter." Among his statues and busts are especially noteworthy the bust of Josiah Quincy, executed for Harvard University (now in the Boston Athenaeum), the equestrian statue of Washington at Richmond, Virginia, the statue of Beethoven in the Boston music hall, statues of Channing and Henry Clay, and the colossal figure of "Armed Liberty" for the Capitol at Washington. For this building he executed also the figures for the pediment and began the bas-reliefs for the bronze doors, which were afterwards completed by W. H. Rinehart. The groups of the pediment symbolize the progress of civilization in America. Crawford's works include a large number of bas-reliefs of Scriptural subjects taken from both the Old and the New Testaments. He made Rome his home, but he visited several times his native land—first in 1844 (in which year he married Louisa Ward), next in 1849, and lastly in 1856. He died in London on the 10th of October 1857.

See *Das Lincoln Monument, eine Rede des Senator Charles Sumner*, to which are appended the biographies of several sculptors, including that of Thomas Crawford (Frankfort a. M., 1868); Thomas Hicks, *Eulogy on Thomas Crawford* (New York, 1865).

**CRAWFORD, WILLIAM HARRIS** (1772-1834), American statesman, was born in Amherst county, Virginia, on the 24th of February 1772. When he was seven his parents moved into Edgefield district, South Carolina, and four years later into Columbus county, Georgia. The death of his father in 1788 left the family in reduced circumstances, and William made what he could by teaching school for six years. He then studied at Carmel Academy for two years, was principal, for a time, of one of the largest schools in Augusta, and in 1798 was admitted to the

**bar.** From 1800 to 1802, with Horatio Marbury, he prepared a digest of the laws of Georgia from 1755 to 1800. From 1803 to 1807 he was a member of the State House of Representatives, becoming during this period the leader of one of two personal-political factions in the state that long continued in bitter strife, occasioning his fighting two duels, in one of which he killed his antagonist, and in the other was wounded in his wrist. From 1807 to 1813 he was a member of the United States Senate, of which he was president *pro tempore* from March 1812 to March 1813. In 1813 he declined the offer of the post of secretary of war, but from that year until 1815 was minister to the court of France. He was then secretary of war in 1815-1816, and secretary of the treasury from 1816 to 1825. In 1816 in the congressional caucus which nominated James Monroe for the presidency Crawford was a strong opposing candidate, a majority being at first in his favour, but when the vote was finally cast 65 were for Monroe and 54 for Crawford. In 1824, when the congressional caucus was fast becoming extinct, Crawford, being prepared to control it, insisted that it should be held, but of 216 Republicans only 66 attended; of these, 64 voted for Crawford. Three other candidates, however, Andrew Jackson, John Quincy Adams, and Henry Clay, were otherwise put in the field. During the campaign Crawford was stricken with paralysis, and when the electoral vote was cast Jackson received 99, Adams 84, Crawford 41, and Clay 37. It remained for the house of representatives to choose from Jackson, Adams and Crawford, and through Clay's influence Adams became president. Crawford was invited by Adams to continue as secretary of the treasury, but declined. He recovered his health sufficiently to become (in 1827) a circuit judge in his own state, but died while on circuit, in Elberton, Georgia, on the 15th of September 1834. In his day he was undoubtedly one of the foremost political leaders of the country, but his reputation has not stood the test of time. He was of imposing presence and had great conversational powers; but his inflexible integrity was not sufficiently tempered by tact and civility to admit of his winning general popularity. Consequently, although a skilful political organizer, he incurred the bitter enmity of other leaders of his time—Jackson, Adams and Calhoun. He won the admiration of Albert Gallatin and others by his powerful support of the movement in 1811 to recharter the Bank of the United States; he earned the condemnation of posterity by his authorship in 1820 of the four-years-term law, which limited the term of service of thousands of public officials to four years, and did much to develop the "spoils system." He was a Liberal Democrat, and advised the calling of a constitutional convention as preferable to nullification or secession.

**CRAWFORDSVILLE**, a city and the county-seat of Montgomery county, Indiana, U.S.A., situated about 40 m. N.W. of Indianapolis. Pop. (1890) 6089; (1900) 6649, including 230 negroes and 221 foreign-born; (1910) 9371. It is served by the Chicago, Indianapolis & Louisville, the Cleveland, Cincinnati, Chicago & St. Louis, and the Vandalia railways, and by interurban electric lines. Wabash College, founded here in 1832 by Presbyterian missionaries but now non-sectarian, had in 1908 27 instructors, 345 students, and a library of 43,000 volumes. Among manufactures are flour, iron, wagons and carriages, acetylene lights, wire and nails, matches, brick paving blocks, and electrical machinery. North-east of the city there are valuable mineral springs, from which the city obtains its water-supply. Crawfordsville, named in honour of W. H. Crawford, was first settled about 1820, was laid out as a town in 1823, and was chartered as a city in 1863. It was for many years the home of Gen. Lew Wallace.

**CRAWFURD, JOHN** (1783-1868), Scottish orientalist, was born in the island of Islay, Scotland, on the 13th of August 1783. After studying at Edinburgh he became surgeon in the East India Company's service. He afterwards resided for some time at Penang, and during the British occupation of Java from 1811 to 1817 his local knowledge made him invaluable to the government. In 1821 he served as envoy to Siam and Cochin-China, and in 1823 became governor of Singapore. His last political service in

the East was a difficult mission to Burma in 1827. In 1861 he was elected president of the Ethnological Society. He died at South Kensington on the 11th of May 1868.

Crawfurd wrote a *History of the Indian Archipelago* (1820), *Descriptive Dictionary of the Indian Islands and Adjacent Countries* (1856), *Journal of an Embassy to the Court of Ava in 1827* (1829), *Journal of an Embassy to the Courts of Siam and Cochin-China, exhibiting a view of the actual State of these Kingdoms* (1830), *Inquiry into the System of Taxation in India, Letters on the Interior of India*, an attack on the newspaper stamp-tax and the duty on paper entitled *Taxes on Knowledge* (1836), and a valuable Malay grammar and dictionary (1852).

**CRAYER, GASPARD DE** (1582-1669), Flemish painter, was born at Antwerp, and learnt the art of painting from Raphael Coxie. He matriculated in the guild of St Luke at Brussels in 1607, resided in the capital of Brabant till after 1660, and finally settled at Ghent. Amongst the numerous pictures which he painted in Ghent, one in the town museum represents the martyrdom of St Blaise, and bears the inscription A° 1668 aet. 86. Crayer was one of the most productive yet one of the most conscientious artists of the later Flemish school, second to Rubens in vigour and below Vandyck in refinement, but nearly equalling both in most of the essentials of painting. He was well known and always well treated by Albert and Isabella, governors of the Netherlands. The cardinal-infant Ferdinand made him a court-painter. His pictures abound in the churches and museums of Brussels and Ghent; and there is scarcely a country chapel in Flanders or Brabant that cannot boast of one or more of his canvases. But he was equally respected beyond his native country; and some important pictures of his composition are to be found as far south as Aix in Provence and as far east as Amberg in the Upper Palatinate. His skill as a decorative artist is shown in the panels executed for a triumphal arch at the entry of Cardinal Ferdinand into the Flemish capital, some of which are publicly exhibited in the museum of Ghent. Crayer died at Ghent. His best works are the "Miraculous Draught of Fishes" in the gallery of Brussels, the "Judgment of Solomon" in the gallery of Ghent, and "Madonnas with Saints" in the Louvre, the Munich Pinakothek, and the Belvedere at Vienna. His portrait by Vandyck was engraved by P. Pontius.

**CRAYFISH** (Fr. *écrevisse*), the name of freshwater crustaceans closely allied to and resembling the lobsters, and, like them, belonging to the order Macrura. They are divided into two families, the *Astacidae* and *Parastacidae*, inhabiting respectively the northern and the southern hemispheres.

The crayfishes of England and Ireland (*Astacus*, or *Potamobius*, *pallipes*) are generally about 3 or 4 in. long, of a dull green or brownish colour above and paler brown or yellowish below. They

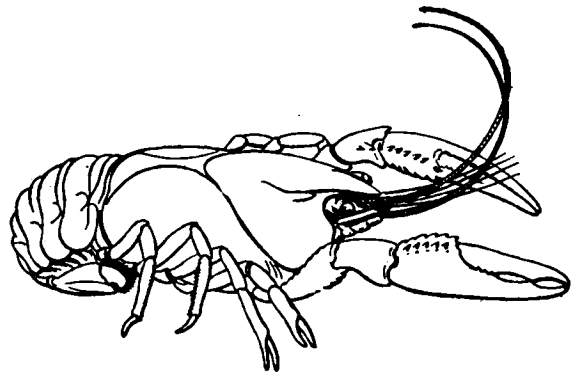

Crayfish (*Cambarus* sp.) from the Mississippi River. (After Morse.)

are abundant in some rivers, especially where the rocks are of a calcareous nature, sheltering under stones or in burrows which they dig for themselves in the banks and coming out at night in search of food. They are omnivorous feeders, killing and eating insects, snails, frogs and other animals, and devouring any carrion that comes in their way. It is stated that they sometimes come on land in search of vegetable food.

On the continent of Europe, *Astacus pallipes* occurs chiefly in the west and south, being found in France, Spain, Italy and the



Balkan Peninsula. It is known in France as *écrevisse à pattes blanches* and in Germany as *Steinkrebs*, and is little used as food. The larger *Astacus fluviatilis* (*écrevisse à pattes rouges*, *Edelkrebs*) is not found in Britain, but occurs in France and Germany, southern Sweden, Russia, &c. It is distinguished, among other characters, by the red colour of the under side of the large claws. It is the species most highly esteemed for the table. Other species of the genus are found in central and eastern Europe and as far east as Turkestan. Farther east a gap occurs in the distribution and no crayfishes are met with till the basin of the Amur is reached, where a group of species occurs, extending into northern Japan. In North America, west of the Rocky Mountains, the genus *Astacus* again appears, but east of the watershed it is replaced by the genus *Cambarus*, which is represented by very numerous species, ranging from the Great Lakes to Mexico. Several blind species inhabit the subterranean waters of caves. The best known is *Cambarus pellucidus*, found in the Mammoth Cave of Kentucky.

The area of distribution occupied by the southern crayfishes or *Parastacidae* is separated by a broad equatorial zone from that of the northern group, unless, as has been asserted, the two come into contact or overlap in Central America. None is found in any part of Africa, though a species occurs in Madagascar. They are absent also from the oriental region of zoologists, but reappear in Australia and New Zealand. Some of the Australian species, such as the "Murray River lobster" (*Astacopsis spinifer*), are of large size and are used for food. In South America crayfishes are found in southern Brazil, Argentina and Chile. (W. T. CA.)

**CRAYON** (Fr. *crayon*, chalk, from Lat. *creta*), a coloured material for drawing, employed generally in the form of pencils, but sometimes also as a powder, and consisting of native earthy and stony friable substances, or of artificially prepared mixtures of a base of pipe or china clay with Prussian blue, orpiment, vermilion, umber and other pigments. Calcined gypsum, talc and compounds of magnesium, bismuth and lead are occasionally used as bases. The required shades of tints are obtained by adding varying amounts of colouring matter to equal quantities of the base. Crayons are used by the artist to make groupings of colours and to secure landscape and other effects with ease and rapidity. The outline as well as the rest of the picture is drawn in crayon. The colours are softened off and blended by the finger, with the assistance of a stump of leather or paper; and shading is produced by cross-hatching and stippling. The art of painting in crayon or pastel is supposed to have originated in Germany in the 17th century. By Johann Alexander Thiele (1685-1752) it was carried to great perfection, and in France it was early practised with much success. Amongst the earlier pastelists may be mentioned Rosalba Carriera (1675-1757), W. Hoare (1707-1792), F. Cotes (1726-1770), and J. Russell (1744-1806); and in recent years the art has been successfully revived. (See PASTEL.)

**CREASY, SIR EDWARD SHEPHERD** (1812-1878), English historian, was born at Bexley in Kent, and educated at Eton and King's College, Cambridge. He became a fellow of King's College in 1834, and having been called to the bar at Lincoln's Inn three years later, was made assistant judge at the Westminster sessions court. In 1840 he was appointed professor of modern and ancient history in the university of London, and in 1860 became chief justice of Ceylon and a knight. Broken down in health he returned to England in 1870, and after a further but short stay in Ceylon died in London on the 27th of January 1878. Creasy's most popular work is his *Fifteen decisive Battles of the World*, which, first published in 1851, has passed through many editions. He also wrote *The History of the Ottoman Turks* (London, 1854-1856); *History of England* (London, 1869-1870); *Rise and Progress of the English Constitution* (London, 1853, and other editions); *Historical and Critical Account of the several Invasions of England* (London, 1852); a novel entitled *Old Love and the New* (London, 1870); and various other works.

**CREATIONISM AND TRADUCIANISM.** Traducianism is the doctrine about the origin of the soul which was taught by Tertullian in his *De anima*—that souls are generated from souls in the same way and at the same time as bodies from bodies:

creationism is the doctrine that God creates a soul for each body that is generated. The Pelagians taunted the upholders of original sin with holding Tertullian's opinion, and called them Traduciani (from *tradux*: *vid.* Du Cange s. *vv.*), a name which was perhaps suggested by a metaphor in *De an.* 19, where the soul is described "velut surculus quidam ex matrice Adam in propaginem deducta." Hence we have formed "tradicianist," "tradicianism," and by analogy "creationist," "creationism." Augustine denied that traducianism was necessarily connected with the doctrine of original sin, and to the end of his life was unable to decide for or against it. His letter to Jerome (*Epist. Clas.* iii. 166) is a most valuable statement of his difficulties. Jerome condemned it, and said that creationism was the opinion of the Church, though he admitted that most of the Western Christians held traducianism. The question has never been authoritatively determined, but creationism, which had always prevailed in the East, became the general opinion of the medieval theologians, and Peter Lombard's *creando infundit animas Deus et infundendo creat* was an accepted formula. Luther, like Augustine, was undecided, but Lutherans have as a rule been traducianists. Calvin favoured creationism.

Peter Lombard's phrase perhaps shows that even in his time it was felt that some union of the two opinions was needed, and Augustine's toleration pointed in the same direction, for the traducianism he thought possible was one in which God *operatur institutas administrando non novas instituendo naturas* (*Ep.* 166. 5. 11). Modern psychologists teach that while "personality" can be discerned in its "becoming," nothing is known of its origin. Lotze, however, who may be taken as representing the believers in the immanence of the divine Being, puts forth—but as a "dim conjecture"—something very like creationism (*Microcosmus*, bk. iii. chap. v. *ad fin.*). It is still, as in the days of Augustine, a question whether a more exact division of man into body, soul and spirit may help to throw light on this subject.

See indices to *Augustine*, vol. xi., and *Jerome*, vol. xi. in Migne's *Patrologia*, s.v. "Anima"; Franz Delitzsch, *Biblical Psychology*, ii. § 7; G. P. Fisher, *History of Chr. Doct.* pp. 187 ff.; A. Harnack, *History of Dogma* (*passim*; see Index); Liddon, *Elements of Religion*, Lect. iii.; Mason, *Faith of the Gospel*, iv. §§ 3, 4, 9, 10. (A. N. \*)

**CRÉBILLON, PROSPER JOLYOT DE** (1674-1762), French tragic poet, was born on the 13th of January 1674 at Dijon, where his father, Melchior Jolyot, was notary-royal. Having been educated at the Jesuits' school of the town, and at the Collège Mazarin, he became an advocate, and was placed in the office of a lawyer named Prieur at Paris. With the encouragement of his master, son of an old friend of Scarron's, he produced a *Mort des enfants de Brutus*, which, however, he failed to bring upon the stage. But in 1705 he succeeded with *Idoménée*; in 1707 his *Atrée et Thyeste* was repeatedly acted at court; *Électre* appeared in 1709; and in 1711 he produced his finest play, the *Rhadamiste et Zénobie*, which is his masterpiece and held the stage for a long period, although the plot is so complicated as to be almost incomprehensible. But his *Xerxes* (1714) was only once played, and his *Sémiramis* (1717) was an absolute failure. In 1707 Crébillon had married a girl without fortune, who had since died, leaving him two young children. His father also had died, insolvent. His three years' attendance at court had been fruitless. Envy had circulated innumerable slanders against him. Oppressed with melancholy, he removed to a garret, where he surrounded himself with a number of dogs, cats and ravens, which he had befriended; he became utterly careless of cleanliness or food, and solaced himself with constant smoking. But in 1731, in spite of his long seclusion, he was elected member of the French Academy; in 1735 he was appointed royal censor; and in 1745 Mme de Pompadour presented him with a pension of 1000 francs and a post in the royal library. He returned to the stage in 1726 with a successful play, *Pyrrhus*; in 1748 his *Catilina* was played with great success before the court; and in 1754, when he was eighty years old, appeared his last tragedy, *Le Triumvirat*. Crébillon died on the 17th of June 1754. The enemies of Voltaire maintained that Crébillon was his superior as a tragic poet. The spirit of rivalry thus provoked induced Voltaire to take the subjects of no less than five of Crébillon's tragedies—*Sémiramis*, *Électre*, *Catilina*, *Le Triumvirat*, *Atrée*—as subjects for tragedies

of his own. The so-called *Éloge de Crébillon* (1762), really a depreciation, which appeared in the year of the poet's death, is generally attributed to Voltaire, though he strenuously denied the authorship. Crébillon's drama is marked by a force too often gained at the expense of scenes of unnatural horror; his pieces show lack of culture and a want of care which displays itself even in the mechanism of his verse, though fine isolated passages are not infrequent.

There are numerous editions of his works, among which may be noticed: *Œuvres* (1772), with preface and "éloge," by Joseph de la Porte; *Œuvres* (1828), containing D'Alembert's *Éloge de Crébillon* (1775); and *Théâtre complet* (1885) with a notice by Auguste Vitu. A complete bibliography is given by Maurice Dutrait, in his *Étude sur la vie et le théâtre de Crébillon* (1895).

His only son, CLAUDE PROSPER JOLYOT CRÉBILLON (1707-1777), French novelist, was born at Paris on the 14th of February 1707. His life was spent almost entirely in Paris, but the publication of *L'Écumoire, ou Tansaï et Neadarné, histoire japonaise* (1734), which contained veiled attacks on the bull *Unigenitus*, the cardinal de Rohan and the duchesse du Maine, brought Crébillon into disgrace. He was first imprisoned and afterwards forced to live in exile for five years at Sens and elsewhere. With Alexis Piron and Charles Collé he founded in 1752 the gay society which met regularly to dine at the famous "Caveau," where many good stories were elaborated. From 1759 onwards he was to be found at the Wednesday dinners of the Pelletier, at which Garrick, Sterne and Wilkes were sometimes guests. He married in 1748 an English lady of noble family, Lady Henrietta Maria Stafford, who had been his mistress from 1744. Their life is said to have been passed in much affection and mutual fidelity; and there could be no greater contrast than that between Crébillon's private life and the tone of his novels, the immorality of which lent irony to the author's tenure of the office of censor, bestowed on him in 1759 through the favour of Mme de Pompadour. He died in Paris on the 12th of April 1777. The most famous of his numerous novels are: *Les Amours de Zéokinizul, roi des Kofirans* (1740), in which "Zéokinizul" and "Kofirans" may be translated Louis XIV. and the French respectively; and *Le Sopha, conte moral* (1740), where the moral is supplied in the title only. This last novel is given by some authorities as the reason for his imprisonment.

His *Œuvres* were collected and printed in 1772. See a notice of Crébillon prefixed to O. Uzanne's edition of his *Contes dialogués* in the series of *Conteurs du XVIII<sup>e</sup> siècle*. Crébillon's novels might be pronounced immoral to the last degree if it were not that two writers slightly later in date surpassed even his achievements in this particular. André Robert de Nerciat (1739-1800) produced under a false name a number of licentious tales, and was followed by Donatien, marquis de Sade.

**CRÈCHE** (Fr. for a "crib" or cradle), the name given to a day-nursery, a public institution for the feeding and care of infants while the mothers are engaged in work outside their homes, or are otherwise prevented from giving them proper attention. Infants are usually admitted when over a month old, and are kept till they are capable of looking after themselves. The advantages of such institutions are that the attention of skilled and trained nurses is given to the children, the food is better and more adapted to their needs than that given in their homes, the surroundings are cleaner and healthier, and habits of discipline and cleanliness are instilled, which, in many cases, react on the mothers. The nurseries are usually under medical supervision, and the small fees charged, which average in London from 3d. to 4d. a day, and on the continent of Europe about 2d., are much less than the cost to the mother who places her young children under the care of neighbours when at work or away from home. Institutions of this kind were started in France in 1844, and have been established in the majority of the large towns on the continent of Europe. In the industrial centres of France and Germany they have helped to check infantile mortality. The state or municipality in nearly every case grants subsidies, but few are maintained entirely by public authorities; voluntary contributions are depended upon for the main support, and the organization and management are left in the hands of private societies and charitable institutions, although some outside

official supervision with regard to the number of infants admitted to each institution, air-space, and ventilation and general hygienic conditions is considered useful. In Great Britain the establishment of such institutions has been left almost entirely to private initiative; and in comparison with the continent the provision is inadequate and unsatisfactory, Paris having nearly double the proportion of accommodation for infants to the population that is provided in London. The National Society of Day Nurseries was founded in 1901 for the purpose of providing a bureau where information may be found of good methods of founding and managing a crèche.

See the *Report of the Consultative Committee upon the School Attendance of Children below the Age of Five*, issued by the Board of Education (1908).

**CRÉCY** (Cressy), a town of northern France, in the department of Somme, on the Maye, 12 m. N. by E. of Abbeville by road. It is famous in history for the great victory gained here on the 26th of August 1346 by the English under Edward III. over the French of King Philip of Valois. After its campaign in northern France, the English army retired into Ponthieu, and encamped on the 25th of August at Crécy, the French king in the meantime marching from Abbeville on Braye. Early on the 26th Edward's army took up its position for battle, and Philip's, hearing of this, moved to attack him, though the French army marched in much disorder, and on arrival formed only an imperfect line of battle. The English lay on the forward slope of a hillside, with their right in front of the village of Crécy, their left resting on Wadicourt. Two of the three divisions or "battles" were in first line, that of the young prince of Wales (the Black Prince) on the right, that of the earls of Northampton and Arundel on the left;

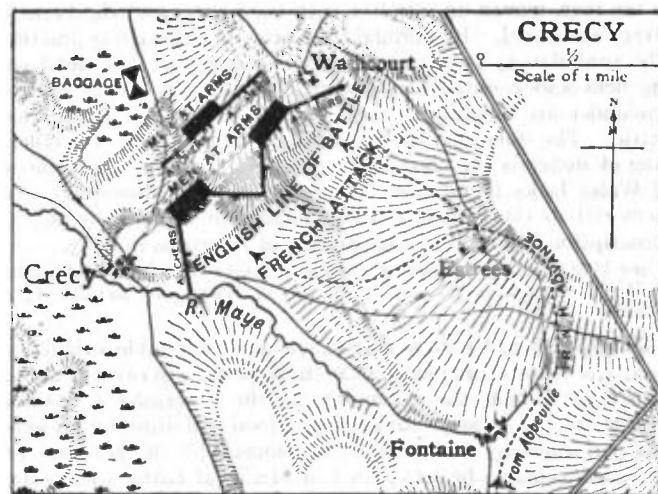

the third, under the king's own command, in reserve, and the baggage was packed to the rear. Each battle consisted of a centre of dismounted knights and men-at-arms, and two wings of archers. The total force was 3900 men-at-arms, 11,000 English archers, and 5000 Welsh light troops (Froissart, first edition, the second gives a different estimate). The French were far stronger, having at least 12,000 men-at-arms, 6000 mercenary crossbowmen (Genoese), perhaps 20,000 of the *milice des communes*, besides a certain number of foot of the feudal levy. Along with these served a Luxemburg contingent of horse under John, king of Bohemia, and other feudatories of the Holy Roman Empire, and the whole force was probably about 60,000 strong.

The day was far advanced when the French came upon the English position. Philip, near Estrées, decided to halt and bivouac, deferring the battle until the army was better closed up, but the indiscipline of his army committed him to an immediate action, and he ordered forward the Genoese crossbowmen, while a line of men-at-arms deployed for battle behind them; the rest of the army was still marching in an irregular column of route along the road from Abbeville. A sudden thunderstorm caused a short delay, then the archers and the crossbowmen opened the battle. Here, for the first time in continental warfare, the English

long-bow proved its worth. After a brief contest the crossbowmen, completely outmatched, were driven back with enormous loss. Thereupon the first line of French knights behind them charged down upon the "faint-hearted rabble" of their own fugitives, and soon the first two lines of the French were a mere mob of horse and foot struggling with each other. The archers did not neglect the opportunity, and shot coolly and rapidly into the helpless target in front of them. The second attack was made by another large body of knights which had arrived, and served but to increase the number of the casualties, though here and there a few charged up to the English line and fell near it, among them the blind king of Bohemia, who with a party of devoted knights penetrated, and was killed amongst, the ranks of the prince of Wales's men-at-arms. The battle was now one long series of desperate but ill-conducted charges, a fresh onslaught being made as each new corps of troops appeared on the scene. The English archers on the flanks of the two first line battles had been wheeled up, the centres of dismounted men-at-arms held back, so that the whole line resembled a "horse" or harrow with three points formed by the archers (see sketch). Each successive body of the French sought to come to close quarters with the men-at-arms, and exposed themselves therefore at short range to the arrows on either flank. Under these circumstances there could be but one issue of the battle. Though sixteen distinct attacks were made, and the fighting lasted until long after dark, no impression was made on the English line. At one moment the prince was so far in danger that his barons sent to the king for aid. Even then Edward was not disquieted and he sent a mere handful of knights to the prince's battle, saying, "Let the boy win his spurs." The left battle of the English, hitherto somewhat to the rear, moved up into line with the prince, and the French attack slackened. By midnight the army of France was practically annihilated; 1542 men of gentle blood were left dead on the field and counted by Edward's heralds, the losses of the remainder are unknown. Some fifty of the victors fell in the battle. The story that the Black Prince adopted from the fallen king of Bohemia the crest and motto now borne by the princes of Wales lacks foundation (see JOHN, King of Bohemia). A memorial to the French and their allies was erected, by public subscription in France, Luxemburg and Bohemia, in 1905.

See H. B. George, *Battles of English History* (London, 1895), and C. W. C. Oman, *A History of the Art of War; The Middle Ages* (London, 1898).

**CREDESCENCE**, or CREDESCENCE TABLE, a small side-table, originally an article of furniture placed near the high table in royal or noble houses, at which the ceremony of the *praegustatio*, Italian *credenziare*, the "assay" or tasting of food and drink for poisons was performed by an official of the household, the *praegustator* or *credentiarius* as he was called in Medieval Latin. Both the ceremony and the table were known as *credentia* (Lat. *credere*, to believe, trust), Ital. *credenza*, Fr. *credence*. After the need for the ceremony had disappeared the name still survived, and the table developed a back and several shelves for the display of plate, and gradually merged into the buffet (*q.v.*). It is, however, as an article of ecclesiastical furniture that the credence table is most familiar. It takes the form of a small table of wood or stone, sometimes fixed and sometimes merely a shelf above or near the piscina. It usually stands on the south or Epistle side of the altar, and on it are placed, in the Roman Catholic Church, the cruets containing the wine and water, the chalice, the candlesticks to be carried by the acolytes, and other objects to be used in the ceremony of the Mass. The use of such a table, to which earlier the name of *paratorium* or *oblationarium* was given, appears to have come into use when the personal presentation of the oblations at the Mass became obsolete. When the pope celebrates Mass a special credence table on the Gospel side of the altar is used, and the ceremony of tasting for poison in the unconsecrated elements is still observed. In some churches in England the old credence tables still exist, as at the church of St Cross near Winchester, where there is a fine stone 15th-century example; more frequent are examples of the stone shelf near the piscina. There are some carved wooden ones surviving, one type being

with a semicircular top and three legs placed in a triangle with a lower shelf. The formal use of the credence table for the unconsecrated elements and the holy vessels before the celebration has been revived in the English Church.

**CREDENTIALS** (*lettres de créance*), a document which ambassadors, ministers plenipotentiary, and *chargés d'affaires* hand to the government to which they are accredited, for the purpose, chiefly, of communicating to the latter the envoy's diplomatic rank. It also contains a request that full credence be accorded to his official statements. Until his credentials have been presented and found in proper order, an envoy receives no official recognition. The credentials of an ambassador or minister plenipotentiary are signed by the chief of the state, those of a *chargé d'affaires* by the foreign minister.

**CREDI, LORENZO DI** (1459-1537), Italian artist, whose surname was Barducci, was born at Florence. He was the least gifted of three artists who began life as journeymen with Andrea del Verrocchio. Though he was the companion and friend of Leonardo da Vinci and Perugino, and closely allied in style to both, he had neither the genius of the one nor the facility of the other. We admire in Da Vinci's heads a heavenly contentment and smile, in his technical execution great gloss and smoothness of finish. Credi's faces disclose a smiling beatitude; his pigments have the polish of enamel. But Da Vinci imparted life to his creations and modulation to his colours, and these are qualities which hardly existed in Credi. Perugino displayed a well-known form of tenderness in heads, moulded on the models of the old Umbrian school. Peculiarities of movement and attitude become stereotyped in his compositions; but when put on his mettle, he could still exhibit power, passion, pathos. Credi often repeated himself in Perugino's way; but being of a pious and resigned spirit, he generally embodied in his pictures a feeling which is yielding and gentle to the verge of coldness. Credi had a respectable local practice at Florence. He was consulted on most occasions when the opinion of his profession was required on public grounds, e.g. in 1491 as to the fronting, and in 1498 as to the lantern of the Florentine cathedral, in 1504 as to the place due to Michelangelo's "David." He never painted frescoes; at rare intervals only he produced large ecclesiastical pictures. The greater part of his time was spent on easel pieces, upon which he expended minute and patient labour. But he worked with such industry that numbers of his Madonnas exist in European galleries. The best of his altar-pieces is that which represents the Virgin and Child with Saints in the cathedral of Pistoia. A fine example of his easel rounds is in the gallery of Mainz. Credi rivalled Fra Bartolommeo in his attachment to Savonarola; but he felt no inclination for the retirement of a monastery. Still, in his old age, and after he had outlived the perils of the siege of Florence (1527), he withdrew on an annuity into the hospital of Santa Maria Nuova, where he died. The National Gallery, London, has two pictures of the Virgin and Child by him.

**CREDIT** (Lat. *credere*, to believe), in a general sense, belief or trust. The word is used also to express the repute which a person has, or the estimation in which he is held. In a commercial sense credit is the promise to pay at a future time for valuable consideration in the present: hence, a reputation of solvency and ability to make such payments is also termed credit. In book-keeping credit is the side of the account on which payments are entered; hence, sometimes, the payments themselves.

The part which credit plays in the production and exchange of wealth is discussed in all economic text-books, but special reference may be made to K. Knies, *Geld und Kredit* (1873-1879), and H. D. Macleod, *Theory of Credit* (1889-1891). See also Hartley Withers, *The Meaning of Money* (1909).

**CRÉDIT FONCIER**, in France, an institution for advancing money on mortgage of real securities. Due to a great extent to the initiative of the economist L. Wolowski, it was created by virtue of a governmental decree of the 28th of February 1852. This decree empowered the issue of loans at a low rate of interest, secured by mortgage bonds, extending over a long period, and repayable by annuities, including instalments of capital. On its inception it had a capital of 25,000,000 francs and took the title

of Banque Foncière de Paris. The parent institution in Paris was followed by similar institutions in Nevers and Marseilles. These two were afterwards amalgamated with the first under the title of Crédit Foncier de France. The capital was increased to 60,000,000 francs, the government giving a subvention of 10,000,000 francs, and exercising control over the bank by directly appointing the governor and two deputy-governors. The administration was vested in a council chosen by the shareholders, but its decisions have no validity without the approval of the governor. The Crédit Foncier has the right to issue bonds, repayable in fifty or sixty years, and bearing a fixed rate of interest. A certain number of the bonds carry prizes. The loans must not exceed half the estimated value of the property mortgaged, upon which the bank has the first mortgage. The bank also makes advances to local bodies, departmental and communal, for short or long periods, and with or without mortgage. Its capital amounts to £13,500,000. Its charter was renewed in 1881 for a period of ninety-nine years.

In 1860 the Crédit Foncier lent its support to the foundation of an organization for supplying capital and credit for agricultural and allied industries. This Crédit Agricole rendered but trifling services to agriculture, however, and soon threw itself into speculation. Between 1873 and 1876 it lent enormous sums to the Egyptian government, obtaining the money by opening credit with the Crédit Foncier and depositing with it the securities of the Egyptian government. On the failure of the Egyptian government to meet its payments the Crédit Agricole went into liquidation, and the Crédit Foncier suffered severely in consequence. The impracticability of the credit system to aid agriculture as worked by the Crédit Agricole was very marked, and, as a consequence, the financing of agricultural associations is now entirely in the hands of the Banque de France.

The *Crédit Mobilier* is an institution for advancing loans on personal or movable estate. It was constituted in 1871, on the liquidation of the Société Générale de Crédit Mobilier, founded in 1852, which it absorbed.

**CRÉDIT MOBILIER OF AMERICA**, a construction company whose operations in connexion with the building of the Union Pacific Railroad gave rise to the most serious political scandal in the history of the United States Congress. The company was originally chartered as the Pennsylvania Fiscal Agency in 1859. In March 1864 a controlling interest in the stock was secured by Thomas Durant, vice-president of the Union Pacific Railroad Company, and the Pennsylvania legislature authorized the adoption of the name Crédit Mobilier of America. Durant proposed to utilize it as a construction company, pay it an extravagant sum for the work, and thus secure for the stockholders of the Union Pacific, who now controlled the Crédit Mobilier, the bonds loaned by the United States government. The net proceeds from the government and the first mortgage bonds issued to the construction company were \$50,863,172.05, slightly more than enough to pay the entire cost of construction. According to the report of the Wilson Congressional Committee, the Crédit Mobilier received in addition, in the form of stock, income bonds, and land grant bonds, \$23,000,000—a profit of about 48%. The defenders of the company assert that several items of expense were not included in this report, and that the real net profit was considerably smaller, although they admit that it was still unusually large. The work extended over the years 1865–1867. During the winter of 1867–1868, when adverse legislation by Congress was feared, it is alleged that Oakes Ames (*q. v.*), a representative from Massachusetts and principal promoter of the Crédit Mobilier, distributed a number of shares among congressmen and senators to influence their attitude. Shares were sold at par when a few dividends repaid a purchaser at this price. Some in fact received dividends without any initial outlay at all. As the result of a lawsuit between Ames and H. S. McComb, some private letters were brought out in September 1872 which gave publicity to the entire proceedings. The House appointed two investigating committees, the Poland and the Wilson committees, and on the report of the former (1873) Ames and James Brooks of New York were formally censured by the

House, the former for disposing of the stock and the latter for improperly using his official position to secure part of it. Charges were also made against Schuyler Colfax, then vice-president but Speaker of the House at the time of the transaction, James A. Garfield, William D. Kelley (1814–1880), John A. Logan, and several other members either of the House or of the Senate. The Senate later appointed a special committee to investigate the charges against its members. This committee, on the 27th of February 1873, recommended the expulsion from the Senate of James W. Patterson, of New Hampshire; but as his term expired within five days no action was taken. The evidence was exaggerated by the Democrats for partisan purposes, but the investigation showed clearly that many of those accused were at least indiscreet if not dishonest. The company itself was merely a type of the construction companies by which it was the custom to build railways between 1860 and about 1880.

See J. B. Crawford, *The Crédit Mobilier of America* (Boston, 1880), and R. Hazard, *The Crédit Mobilier of America* (Providence, 1881), both of which defend Ames; also the histories of the Union Pacific Railroad Company by J. P. Davis (Chicago, 1894) and H. K. White (Chicago, 1895); and for a succinct and impartial account, James Ford Rhodes, *History of the United States*, vol. vii. (New York, 1906). The Poland and Wilson reports are to be found in *House of Representatives Reports*, 42nd Congress, 3rd session, Nos. 77 and 78, and the report of the Senate Committee in *Senate Reports*, 42nd Congress, 3rd session, No. 519.

**CREDITON**, a market town in the South Molton parliamentary division of Devonshire, England, 8 m. N.W. of Exeter by the London & South-Western railway. Pop. of urban district (1901) 3974. It is situated in the narrow vale of the river Creedy near its junction with the Exe, between two steep hills, and is divided into two parts, the east or old town and the west or new town. The church of Holy Cross, formerly collegiate, is a noble Perpendicular building with Early English and other early portions, and a fine central tower. The grammar school, founded by Edward VI. and refounded by Elizabeth, has exhibitions to Oxford and Cambridge universities. Shoe-making, tanning, agricultural trade, tin-plating, and the manufacture of confectionery and cider have superseded the former large woollen and serge industries. In 1897 Crediton was made the seat of a suffragan bishopric in the diocese of Exeter.

The first indication of settlement at Crediton (*Credington*, *Crydton*, *Kirton*) is the tradition that Winfrith or Boniface was born there in 680. Perhaps in his memory (for the great extent of the parish shows that it was thinly populated) it became in 909 the seat of the first bishopric in Devonshire. It was probably only a village in 1049, when Leofric, bishop of Crediton, requested Leo IX. to transfer the see to Exeter, as Crediton was "an open town and much exposed to the incursions of pirates." At the Domesday Survey much of the land was still uncultivated, but its prosperity increased, and in 1269 each of the twelve prebends of the collegiate church had a house and farmland within the parish. The bishops, to whom the manor belonged until the Reformation, had difficulty in enforcing their warren and other rights; in 1351 Bishop Grandison obtained an exemplification of judgments of 1282 declaring that he had pleas of withernam, view of frank pledge, the gallows and assize of bread and ale. Two years later there was a serious riot against the increase of copyhold. Perhaps it was at this time that the prescriptive borough of Crediton arose. The jury of the borough are mentioned in 1275, and Crediton returned two members to parliament in 1306–1307, though never afterwards represented. A borough seal dated 1469 is extant, but the corporation is not mentioned in the grant made by Edward VI. of the church to twelve principal inhabitants. The borough and manor were granted by Elizabeth to William Killigrew in 1595, but there is no indication of town organization then or in 1630, and in the 18th century Crediton was governed by commissioners. In 1231 the bishop obtained a fair, still held, on the vigil, feast and morrow of St Lawrence. This was important as the wool trade was established by 1249 and certainly continued until 1630, when the market for kersies is mentioned in conjunction with a saying "as fine as Kirton spinning."

See Rev. Preb. Smith, "Early History of Credition," in *Devonshire Association for the Advancement of Science, Literature and Art, Transactions*, vol. xiv. (Plymouth, 1882); Richard J. King, "The Church of St Mary and of the Holy Cross, Credition," in *Exeter Diocesan Architectural Society, Transactions*, vol. iv. (Exeter, 1878).

**CREDNER, CARL FRIEDRICH HEINRICH** (1809-1876), German geologist, was born at Waltershausen near Gotha, on the 13th of March 1809. He investigated the geology of the Thüringer Waldes, of which he published a map in 1846. He was author of a work entitled *Über die Gliederung der oberen Juraformation und der Wealden-Bildung im nordwestlichen Deutschland* (Prague, 1863), also of a geological map of Hanover (1865). He died at Halle on the 28th of September 1876.

His son, **CARL HERMANN CREDNER** (1841- ), was born at Gotha on the 1st of October 1841, educated at Breslau and Göttingen, and took the degree of Ph.D. at Breslau in 1864. In 1870 he was appointed professor of geology in the university of Leipzig, and in 1872 director of the Geological Survey of Saxony. He is author of numerous publications on the geology of Saxony, and of an important work, *Elemente der Geologie* (2 vols., 1872; 7th ed., 1891), regarded as the standard manual in Germany. He has also written memoirs on Saurians and Labyrinthodonts.

**GREE**, a tribe of North American Indians of Algonquian stock. They are still a considerable tribe, numbering some 15,000, and living chiefly in Manitoba and Assiniboia, about Lake Winnipeg and the Saskatchewan river. They gave trouble by their constant attacks upon the Sioux and Blackfeet, but are now peaceable and orderly.

See *Handbook of American Indians* (Washington, 1907).

**CREECH, THOMAS** (1659-1700), English classical scholar, was born at Blandford, Dorsetshire, in 1659. He received his early education from Thomas Curgenvin, master of Sherborne school. In 1675 he entered Wadham College, Oxford, and obtained a fellowship in 1683 at All Souls'. He was headmaster of Sherborne school from 1694 to 1696, and in 1699 he received a college living, but in June 1700 he hanged himself. The immediate cause of the act was said to be a money difficulty, though according to some it was a love disappointment; both of these circumstances no doubt had their share in a catastrophe primarily due to an already pronounced melancholia. Creech's fame rests on his translation of Lucretius (1682) in rhymed heroic couplets, in which, according to Otway, the pure ore of the original "somewhat seems refined." He also published a version of Horace (1684), and translated the *Idylls of Theocritus* (1684), the *Thirteenth Satire of Juvenal* (1693), the *Astronomicon of Manilius* (1697), and parts of Plutarch, Virgil and Ovid.

**CREEDS** (Lat. *credo*, I believe), or CONFESSIONS OF FAITH. We are accustomed to regard the whole conception of creeds, i.e. reasoned statements of religious belief, as inseparably connected with the history of Christianity. But the new study of comparative religion has something to teach us even here. The saying *lex orandi lex credendi* is true of all times and of all peoples. And since we must reckon praise as the highest form of prayer, such an early Christian hymn as is found in 1 Tim. iii. 16 must be acknowledged to be of the nature of a creed: "He who was manifested in the flesh, justified in the spirit, seen of angels, preached among the nations, believed on in the world, received up in glory." It justifies the expansion of the second article of the developed Christian creed from the standpoint of the earliest Christian tradition. It also supplies a reason for including in our survey of creeds some reference to pre-Christian hymns and beliefs. The pendulum has swung back. Rather than despise the faulty presentation of truth which we find in heathen religions and their more or less degraded rites, we follow the apostle Paul in his endeavour to trace in them attempts "to feel after God" (Acts vii. 27). Augustine, the great teacher of the West, was true to the spirit of the great Alexandrians, when he wrote (*Ep.* 166): "Let every good and true Christian understand that truth, wherever he finds it, belongs to his Lord."

We are not concerned with the question whether the earliest forms of recorded religious consciousness such as animism, or totemism, or fetishism, were themselves degradations of a

primitive revelation or not.<sup>1</sup> We are only concerned with the fact of experience that the human soul yearns to express its belief. The hymn to the rising and setting sun in the *Book of the Dead* (ch. 15), which is said by Egyptologists to be the oldest poem in the world, carries us back at once to the dawn of history.

"Hail to thee, Ra, the self-existent . . . Glorious is thine uprising from the horizon. Both worlds are illumined by thy rays . . . Hail to thee, Ra, when thou returnest home in renewed beauty, crowned and almighty."

In a later hymn Amen-Ra is confessed as "the good god beloved, maker of men, creator of beasts, maker of things below and above, lord of mercy most loving." A similar note is struck in the Indian Vedas. In the more ethical religion of the Avesta the creator is more clearly distinguished from the creature: "I desire to approach Ahura and Mithra with my praise, the lofty eternal, and the holy two."<sup>2</sup> The Persian poet is not far from the kingdom into which Hebrew psalmists and prophets entered.

The whole history of the Jewish religion is centred in the gradual purification of the idea of God. The morality of the Jews did not outgrow their religion, but their interest was always ethical and not speculative. The highest strains of the psalmists and the most fervent appeals of the prophets were progressively directed to the great end of praising and preaching the One true God, everlasting, with sincere and pure devotion. The creed of the Jew, to this day, is summed up in the well-remembered words, which have been ever on his lips, living or dying: "Hear, O Israel, the Lord our God is one Lord" (Deut. vi. 4).

The definiteness and persistence of this creed, which of course is the strength also of Mahomedanism, presents a contrast to the fluid character of the statements in the Vedas, and to the chaos of conflicting opinions of philosophers among the Greeks and Romans. As Dr J. R. Illingworth has said very concisely: "The physical speculations of the Ionians and Atomists rendered a God superfluous, and the metaphysical and logical reasoning of the Eleatics declared Him to be unknowable."<sup>3</sup> Plato regarding the world as an embodiment of eternal, archetypal ideas, which he groups under the central idea of Good, identified with the divine reason, at the same time uses the ordinary language of the day, and speaks of God and the gods, feeling his way towards the conception of a personal God, which, to quote Dr Illingworth again, neither he nor Aristotle could reach because they had not "a clear conception of human personality." They were followed by an age of philosophizing which did little to advance speculation. The Stoics, for example, were more successful in criticizing the current creed than in explaining the underlying truth which they recognized in polytheism. The final goal of Greek philosophy was only reached when the great thinkers of the early Christian Church, who had been trained in the schools of Alexandria and Athens, used its modes of thought in their analysis of the Christian idea of God. "In this sense the doctrine of the Trinity was the synthesis, and summary, of all that was highest in the Hebrew and Hellenic conceptions of God, fused into union by the electric touch of the Incarnation."<sup>4</sup>

Space does not permit enlargement on this theme, but enough has been said to introduce the direct study of the ancient creeds of Christendom.

**I. THE ANCIENT CREEDS OF CHRISTENDOM.**—The three creeds which may be called oecumenical, although the measure of their acceptance by the universal church has not been uniform, represent three distinct types provided for the use of the catechumen, the communicant, and the church teacher respectively. The Apostles' Creed is the ancient baptismal creed, held in common both by East and West, in its final western form. The Nicene Creed is the baptismal creed of an eastern church enlarged in order to combine theological interpretation with the facts of the historic faith. Its use in the Eucharist of the undivided Church has been continued since the great schism, although the Eastern Church protests against the interpolation

<sup>1</sup> Jevons, *Introd. to the History of Religion*, p. 394.

<sup>2</sup> *Sacred Books of the East*, xxxi.

<sup>3</sup> *Personality, Human and Divine* (cheap edition), p. 36.

<sup>4</sup> *Ib.* p. 38.



of the words "And the Son" in clause 9. The Athanasian Creed is an instruction designed to confute heresies which were current in the 5th century.

1. *The Apostles' Creed.*—The increased interest which has been shown in the history of all creed-forms since the latter part of the 19th century is due in a great measure to the work of the veteran pioneer, Professor P. Caspari of Christiania, who began the herculean task of classifying the enormous number of creed-forms which have been recovered from obscure pages of early Christian literature. In England we owe much to Professors C. A. Heurtley and Swainson. In Germany the monumental work of Professor Kattenbusch has overshadowed all other books on the subject, providing even his most ardent critics with an indispensable record of the literature of the subject.

The majority of critics agree that the only trace of a formal creed in the New Testament is the simple confession of Jesus as the Lord, or the Son of God (Rom. x. 9; 1 Cor. xii. 3). While the apostles were agreed on an outline of teaching (Rom. vi. 17) which included the doctrine of God, the person and work of Christ, and the person and work of the Holy Spirit, it does not appear that they provided any summary, which would cover this ground, as an authoritative statement of their belief. The tradition which St Paul received included, so to speak, the germ of the central prayer in the Eucharist (1 Cor. xi. 23 ff.), and no doubt included also teaching on conduct, "the way of a Christian life" (1 Thess. iv. 1; Gal. v. 21). The creed in all its forms lies behind worship, which it preserves from idolatry, and behind ethics, to which it supplies a motive power which the pre-Christian system so manifestly lacked. Whether the first creed of the primitive Church was of the simple Christological character which confession of Jesus as the Lord expresses, or of an enlarged type based on the baptismal formula (Matt. xxviii. 19), makes no difference to the statement that the faith which overcame the world derived its energy from convictions which strove for utterance. "With the heart man believeth unto righteousness, and with the mouth confession is made unto salvation" (Rom. x. 10).

When St Paul reminds Timothy (1 Tim. vi. 13) of his confession before many witnesses he does not seem to imply more than confession of Christ as king. He calls it "the beautiful confession" to which Christ Jesus had borne witness before Pontius Pilate, and charges Timothy before God, who quickeneth all things, to keep this commandment. Some writers, notably Professor Zahn,<sup>1</sup> piecing together this text with 2 Tim. i. 13, ii. 8, iv. 1, 2, reconstructs a primitive Apostles' Creed of Antioch, the city from which St Paul started on his missionary journeys. But there is no mention of a third article in the creed, beyond a reference to the Holy Ghost in the context of 2 Tim. i. 14, which would prove the apostolic use of a Trinitarian confession imaginable as the parent of the later Eastern and Western forms. The eunuch's creed interpolated in Acts viii. 57, "I believe that Jesus is the Son of God," since the reading was known to Irenaeus, probably represents the form of baptismal confession used in some church of Asia Minor, and supplies us with the type of a primitive creed. This theory is confirmed by the evidence of the Johannine epistles (1 John iv. 15, v. 5; cf. Heb. iv. 14).

From this point of view it is easy to explain the occurrence of creed-like phrases in the New Testament as fragments of early hymns (1 Tim. iii. 16) or reminiscences of oral teaching (1 Cor. xv. 1 ff.). The following form which Seeberg gives as the creed of St Paul is an artificial combination of fragments of oral teaching, which naturally reappear in the teaching of St Peter, but finds no attestation in the later creeds of particular churches which would prove its claim to be their parent form:

"The living God who created all things sent His Son Jesus Christ, born of the seed of David, who died for our sins according to the scriptures, and was buried, who was raised on the third day according to the scriptures, and appeared to Cephas and the XII., who sat at the

right hand of God in the heavens, all rule and authority and power being made subject unto Him, and is coming on the clouds of heaven with power and great glory."

The evidence of the apostolic fathers is disappointing. Clement (*Cor.* lviii. 2) supplies only parallels to the baptismal formula (Matt. xxviii. 19). Polycarp (*Ep.* 7) echoes St John. But Ignatius might seem to offer in the following passage some confirmation of Zahn's theory of a primitive creed of Antioch (*Trall.* 9): "Be ye deaf, therefore, when any man speaketh to you apart from Jesus Christ, who was of the race of David, who was the Son of Mary, who was truly born and ate and drank, was truly persecuted under Pontius Pilate, was truly crucified and died in the sight of those in heaven and those on earth and those under the earth; who, moreover, was truly raised from the dead, His Father having raised Him, who in the like fashion will so raise us also who believe on Him—His Father, I say, will raise us—in Christ Jesus, apart from whom we have not true life."

The differences, however, which divide this from the later creed forms are scarcely less noticeable than their agreement, and the evidence of the Ignatian epistles generally (*Eph.* xviii.; *Smyrn.* i.), while it confirms the conclusion that instruction was given in Antioch on all points characteristic of the developed creed, e.g. the Miraculous Birth, Crucifixion, Resurrection, the Catholic Church, forgiveness of sins, the hope of resurrection, does not prove that this teaching was as yet combined in a Trinitarian form which classified the latter clauses under the work of the Holy Ghost.

At this point a word must be said on the important question of interpretation. While we may hope for eventual agreement on the history of the different types of creed forms, there can be no hope of agreement on the interpretation of the words Holy Spirit between Unitarian and Trinitarian critics. Writers who follow Harnack explain "holy spirit" as the gift of impersonal influence, and between wide limits of difference agree in regarding Christ as Son of God by adoption and not by nature. Amid the chaos of conflicting opinions as to the original teaching of Jesus, the Gospel within the Gospel, the central question "What think ye of Christ?" emerges as the test of all theories. "No man can say that Jesus is the Lord save in the Holy Ghost" (1 Cor. xii. 3). Belief in the fact of the Incarnation of the eternal Word, as it is stated in the words of Ignatius quoted above, or in any of the later creeds, stands or falls with belief in the Holy Ghost as the guide alike of their convictions and destinies, no mere impersonal influence, but a living voice.

If the essence of Christianity is winnowed down to a bare imitation of the Man Jesus, and his religion is accepted as Buddhists accept the religion of Buddha, still it cannot be denied that the early Christians put their trust in Christ rather than his religion. "I am the life," not "I teach the life," "I am the truth," not merely "I teach the truth," are not additions of Johannine theology but the central aspect of the presentation of Christ as the good physician, healer of souls and bodies, which the most rigid scrutiny of the Synoptic Gospels leaves as the residuum of accepted fact about Jesus of Nazareth. To say more would be out of place in this article, but enough has been said to introduce the exhaustive discussion by Kattenbusch (ii. 471-728) of the meaning of the theological teaching both of the New Testament and of the earliest creeds.

To return within our proper limits. Kattenbusch, with whom Harnack is in general agreement, regards the Old Roman Creed, which comes to light in the 4th century, as the parent of all developed forms, whether Eastern or Western. Marcellus, the exiled bishop of Ancyra, is quoted by Epiphanius as presenting it to Bishop Julius of Rome c. A.D. 340. Ussher's recognition of the fact that this profession of faith by Marcellus was the creed of Rome, not of Ancyra, is the starting-point of modern discussions of the history of the creeds. Some sixty years later Rufinus, a priest of Aquileia, wrote a commentary on the creed of his native city and compared it with the Roman Creed. His Latin text is probably as ancient as the Greek text of Marcellus, because the Roman Church must always have been bilingual in its early days. It was as follows:

<sup>1</sup> *Der Katechismus der Urchristenheit*, p. 85. Zahn's reasoned argument stands in contrast to the blind reliance on tradition shown by Macdonald, *The Symbol of the Apostles*, and the fanciful reconstruction of the primitive creed by Baeumer, Harnack or Seeberg.

- I. 1. I believe in God (the) Father almighty;  
 II. 2. And in Christ Jesus His only Son our Lord,  
 3. who was born of the Holy Spirit and the Virgin Mary,  
 4. crucified under Pontius Pilate and buried  
 5. the third day He rose from the dead,  
 6. He ascended into heaven,  
 7. sitteth at the right hand of the Father,  
 8. thence He shall come to judge living and dead.  
 III. 9. And in the Holy Ghost,  
 10. (the) holy Church,  
 11. (the) remission of sins,  
 12. (the) resurrection of the flesh.

This Old Roman Creed may be traced back in the writings of Bishops Felix and Dionysus (3rd century), and in the writings of Tertullian in the 2nd century.

Tertullian calls the creed the "token" which the African Church shares with the Roman (*de Praescr.* 36): "The Roman Church has made a common token with the African Churches, has recognized one God, creator of the universe, and Christ Jesus, of the Virgin Mary, Son of God the Creator, and the resurrection of the flesh." The reference is to the earthenware token which two friends broke in order that they might commend a stranger for hospitality by sending with him the broken half. Their creed became the passport by which Christians in strange cities could obtain admission to assemblies for worship and to common meals. The passage quoted is obviously a condensed quotation of the Roman Creed, which reappears also in the following (*de Virg. vel. i.*):

"The rule of faith is one altogether . . . of believing in one God Almighty, maker of the world, and in His Son Jesus Christ, born of Mary the Virgin, crucified under Pontius Pilate; the third day raised from the dead, received in the heavens, sitting now at the right hand of the Father, about to come and judge quick and dead through the resurrection also of the flesh."

There are many references in Tertullian to the teaching of the Gnostic Marcion, whose breach with the Roman Church may be dated A.D. 145. He seems to have still held to the Roman creed interpreted in his own way. An ingenious conjecture by Zahn enables us to add the words "holy Church" to our reconstruction of the creed from the writings of Tertullian. In his revised New Testament Marcion speaks of "the covenant which is the mother of us all, which begets us in the holy Church, to which we have vowed allegiance." He uses a word used by Ignatius of the oath taken on confession of the Christian faith. It follows that the words "holy Church" were contained in the Roman Creed.<sup>1</sup>

While all critics agree in tracing back this form to the earliest years of the 2nd century, and regard it as the archetype of all similar Western creeds, there is great diversity of opinion on its relation to Eastern forms. Kattenbusch maintains that the Roman Creed reached Gaul and Africa in the course of the 2nd century, and perhaps all districts of the West that possessed Christian congregations, also the western end of Asia Minor possibly in connexion with Polycarp's visit to Rome A.D. 154. He finds that materials fail for Pontus, Galatia, Cappadocia, Syria, Palestine, Egypt. Further, he holds that all the Eastern creeds which are known to us as existing in the 4th century, or may be traced back to the 3rd, lead to Antioch as their starting-point. He concludes that the Roman Creed was accepted at Antioch after the fall of Paul of Samosata in A.D. 272, and was adapted to the dogmatic requirements of the time, all the later creeds of Palestine, Asia Minor and Egypt being dependent on it.

On the other hand, Kunze, Loofs, Sanday, and Zahn find evidence of the existence of an Eastern type of creed of equal or greater antiquity and distinguished from the Roman by such phrases as "One" (God), "Maker of heaven and earth," "suffered," "shall come again in glory." Thus Kunze reconstructs a creed of Antioch for the 3rd century, and argues that it is independent of the Roman Creed.

*Creed of Antioch.*

- I. I. I believe in one and one only true God, Father Almighty, maker of all things, visible and invisible.

<sup>1</sup> McGiffert, on the other hand, argues that the Roman Creed was composed to meet the errors of Marcion, p. 58 ff. He omits, however, to mention this, which is Zahn's strongest argument.

- II. 2. And in our Lord Jesus Christ, His Son, the only-begotten and first born of all creation, begotten of Him before all the ages, through whom also the ages were established, and all things came into existence;  
 3. Who for our sakes, came down, and was born of Mary the Virgin.  
 4. And crucified under Pontius Pilate, and buried,  
 5. And the third day rose according to the scriptures,  
 6. and ascended into heaven.  
 7.  
 8. And is coming again to judge quick and dead.  
 9. [The beginning of the third article has not been recorded.]  
 10.  
 11. Remission of sins.  
 12. Resurrection of the dead, life everlasting.

Along similar lines Loofs selects phrases as typical of creeds which go back to a date preceding the Nicene Council.

- A. Creed of Eusebius of Caesarea, presented to the Nicene Council.  
 B. Revised Creed of Cyril of Jerusalem.  
 C. Creed of Antioch quoted by Cassian.  
 D. Creed of Antioch quoted in the Apostolic Constitutions.  
 E. Creed of Lucian the Martyr (Antioch).  
 F. Creed of Arius (Alexandria).  
 1. One (God), A, B, C, D, E, F.  
 Maker of heaven and earth and of all things visible and invisible (or a like phrase), A, B, C, D, E.  
 2. Lord Jesus Christ, His Son, the only begotten (or a like phrase), A, B, C, D, E, F.  
 3. Crucified under Pontius Pilate, B, C, D (A, E, F omit because they are theological creeds. Loofs thinks that the baptismal creeds on which they are based may have contained the words).  
 5. Rose the third day, A, B, D, E (F omits "the third day" being a theological creed; the translation of C is uncertain).  
 6. Went up, A, B, D, E, F.  
 +and . . . and . . . and, A, B, C, D, E, F.  
 8. And is coming, B, C, D, E, F; and is about to come, A; +again, A, C, D, E, F(B?); +in glory, A, B; with glory, D, E.  
 10. +Catholic, B, D, F (A, C, E?)  
 12. +life eternal, B, C; +life of the age to come, D, F.

Sanday (*Journal Theol. Studies*, iii. 1) does not attempt a reconstruction on this elaborate scale, but contents himself with pointing out evidence, which Kattenbusch seems to him to have missed, for the existence of creeds of Egypt, Cappadocia and Palestine before the time of Aurelian. He criticizes Harnack's theory that there existed in the East, that is, in Asia Minor, or in Asia Minor and Syria as far back as the beginning of the 2nd century, a Christological instruction (*μάθημα*) organically related to the second article of the Roman Creed, and formulas which taught that the "One God" was "Creator of heaven and earth," and referred to the holy prophetic spirit, and lasted on till they influenced the course of creed-development in the 4th century. He asks, is it not simpler to believe that there was a definite type in the background?

Another English student, the Rev. T. Barns, engaged specially in work upon the history of the creed of Cappadocia, points out the importance of the extraordinary influence of Firmilian of Caesarea in the affairs of the church of Antioch in the early part of the 3rd century. He is led to argue that the creed of Antioch came rather from Cappadocia than Rome. Whether his conclusion is justified or not, it helps to show how strongly the trend of contemporary research is setting against the theory of Kattenbusch that the Roman Creed when adopted at Antioch became the parent of all Eastern forms. It does not, however, militate against the possibility that the Roman Creed was carried from Rome to Asia Minor and to Palestine in the 2nd century. It is evidently impossible to arrive at a final decision until much more spade work has been done in the investigation of early Eastern creeds. Connolly's study of the early Syrian creed (*Zeitschrift für die neutestamentliche Wissenschaft*, 1906, p. 202) deserves careful consideration. His reconstruction of the creed of Aphraates is interesting in relation to the other traces of a Syriac creed form existing prior to the 4th century.

[I believe] in God the Lord of all, that made the heavens and the earth and the seas and all that in them is; [And in our Lord Jesus

Christ] [the Son of God,] God, Son of God, King, Son of the King, Light from Light, (Son and Counsellor, and Guide, and Way, and Saviour, and Shepherd, and Gatherer, and Door, and Pearl, and Lamp,) and first-born of all creatures, who came and put on a body from Mary the Virgin (of the seed of the house of David, from the Holy Spirit), and put on our manhood, and suffered, or and was crucified, went down to the place of the dead, or to Sheol, and lived again, and rose the third day, and ascended to the height, or to heaven, and sat on the right hand of His Father, and He is the Judge of the dead and of the living, who sitteth on the throne; [And in the Holy Spirit;] [And I believe] in the coming to life of the dead; [and] in the mystery of Baptism (of the remission of sins).

The probable battle-ground of the future between the opposing theories lies in the writings of Irenaeus. He has most of the characteristic expressions of the Eastern creeds. He inserts "one" in clause 1 and 2. He has the phrases "Maker of heaven and earth," "suffered," and "crucified," with "under Pontius Pilate" after instead of before it. Probably also he had "in glory" in clause 8. But there is always the possibility to be faced that Irenaeus drew his creed from Rome rather than Asia Minor. Kattenbusch does not shrink from suggesting that he shows acquaintance with the Roman Creed, and that Justin Martyr also knew it, in which case all the so-called Eastern characteristics have been imprinted on the original Roman form, and are not derived from an Eastern archetype. But the ordinary reader need not feel concern about the future victory of either theory. The plain fact is that the same facts were taught in Palestine, Asia Minor and Gaul, whether gathered up in a parallel creed form or not. The contrast which Rufinus draws between the Roman Creed and others, both of the East and the West, is justified. In comparison with them it was guarded more carefully from change.<sup>1</sup> We have yet to inquire how it received the additions which distinguish the derived form now in use as the baptismal creed of all Western Christendom. Some had already found an entrance into Western creeds. We find "suffered" in the creed of Milan, "descended into hell" in the creed of Aquileia, the Danubian lands and Syria; the words "God" and "almighty" were shortly added to clause 7 in the Spanish creed; "life everlasting" had stood from an early date in the African creed. The creed of Caesarius of Arles (d. 543) proves that these variations had all been united in one Gallican creed together with "catholic" and "communion of saints," but this Gallican form still lacked "Maker of heaven and earth" and the additions in clause 7.

Two newly-discovered creeds help us greatly to narrow down the limits of the problem. The creed of Niceta of Remesiana in Dacia proves that c. A.D. 400 the Dacian church had added to the Roman Creed "maker of heaven and earth," "suffered," "dead," "Catholic," "communion of saints" and "life everlasting." Parallel to it is the Faith of St Jerome discovered in 1903 by Dom. Morin.<sup>2</sup>

*The Faith of St Jerome.*

"I believe in one God the Father almighty, maker of things visible and invisible. I believe in one Lord Jesus Christ, the Son of God, born of God, God of God, Light of Light, almighty of almighty, true God of true God, born before the ages, not made, by whom all things were made in heaven and in earth. Who for our salvation descended from heaven, was conceived of the Holy Ghost, born of the Virgin Mary, suffered by suffering under Pontius Pilate, under Herod the King, crucified, buried, descended into hell, trod down the sting of death, rose again the third day, appeared to the apostles. After this He ascended into heaven, sitteth at the right of God the Father, thence shall come to judge the quick and the dead. And I believe in the Holy Ghost, God not unbegotten nor begotten, not created nor made, but co-eternal with the Father and the Son. I believe (that there is) remission of sins in the holy catholic church, communion of saints, resurrection of the flesh unto eternal life. Amen."

This creed may be the form which Jerome mentions in one of his letters (*Ep.* 17, n. 4) as sent to Cyril of Jerusalem. It is important as connecting the creeds of East and West. Since Jerome was born in Pannonia we may conjecture that he is inserting Nicene phrases from the Jerusalem creed into his baptismal creed, and

<sup>1</sup> It is probable that "one" has dropped out of the first clause. Zahn acutely suggests that it was omitted in the time of Zephyrinus to counteract Monarchian teaching such as the formula: "believe in one God, Jesus Christ."

<sup>2</sup> *Anecdota Maredsolana*, iii. iii. p. 199.

that this form added to Niceta's creed proves that the creed of the Danube lands possessed the clauses "maker of heaven and earth" and "communion of saints."

The first occurrence of the completed form is in a treatise (*Scarapsus*) of the Benedictine missionary Pirminius, abbot of Reichenau (c. A.D. 730). The difficulty hitherto has been to trace the source from which the clause "maker of heaven and earth" has come into it. It has been known that the forms in use in the south of France approximated to it but without those words. In the 6th century we find creed forms in use in Gaul which include them, but include also other variations distinguishing them from the form which we seek. The missing link which has hitherto been lacking in the evidence has been found by Barns in the influence of Celtic missionaries who streamed across from Europe until they came in touch with the remnants of the Old Latin Christianity of the Danube. The chief documents of the date A.D. 700, which contain forms almost identical with the received text, are connected with monasteries founded by Columban and his friends: Bobbio, Luxeuil, S. Gallen, Reichenau. From one of these monasteries the received text seems to have been taken to Rome. Certainly it was from Rome that it was spread. We can trace the use of the received text along the line of the journeys both of Pirminius and Boniface, and there is little doubt that they received it from the Roman Church, with which Boniface was in frequent communication. Pope Gregory II. sent him instructions to use what seems to have been an official Roman order of Baptism, which would doubtless include a Roman form of creed. Pirminius, who was far from being an original writer, made great use of a treatise by Martin of Braga, but substituted a Roman form of Renunciation, and refers to the Roman rite of Unction in a way which leads us to suppose that the form of creed which he substituted for Martin's form was also Roman. It seems clear, therefore, that the received text was either made or accepted in Rome, c. A.D. 700, and disseminated through the Benedictine missionaries. At the end of the 8th century Charlemagne inquired of the bishops of his empire as to current forms. The reply of Amalarius of Trier is important because it shows that he not only used the received text, but also connected it with the Roman order of Baptism. The emperor's wish for uniformity doubtless led in a measure to its eventual triumph over all other forms.

2. *The Nicene Creed* of the liturgies, often called the Constantinopolitan creed, is the old baptismal creed of Jerusalem revised by the insertion of Nicene terms. The idea that the council merely added to the last section has been disproved by Hort's famous dissertation in 1876.<sup>3</sup> The text of the creed of the Nicene Council was based on the creed of Eusebius of Caesarea, and a comparison of the four creeds side by side proves to demonstration their distinctness, in spite of the tendency of copyists to confuse and assimilate the forms.<sup>4</sup>

*Creed of Eusebius, A.D. 325 (Caesarea).*

We believe

- I. 1. In one God the Father Almighty, the maker of all things visible and invisible.
- II. 2. And in one Lord Jesus Christ, the Word of God.

God of God, Light of Light, (Life of Life,) only begotten Son (first-born of all creation, before all worlds begotten of God the Father), by whom all things were made;

*Revision by the Council of Nicaea, A.D. 325.*

We believe

- I. 1. In one God the Father Almighty, the maker of all things visible and invisible.
- II. 2. And in one Lord Jesus Christ, the Son of God, begotten of the Father, only begotten, that is of the substance of the Father, God of God, Light of Light, very God of very God, begotten not made, of one substance with the Father, by whom all things were made, both those in heaven and those on earth.

<sup>3</sup> Dörholt has shown that Petavius (d. 1652) was the first to remark that the so-called Constantinopolitan form was quoted by Epi-phanus before the Council met, but was not able to explain the fact.

<sup>4</sup> Burn, "Note on the Old Latin text," *Journal of Theol. Studies*.

3. Who for our salvation was incarnate (and lived as a citizen amongst men),
  4. And suffered,
  5. And rose the third day,
  6. And ascended (to the Father),
  7. And shall come again (in glory) to judge quick and dead.
- III. 8. And (we believe) in (one) Holy Ghost.

*Creed of Jerusalem, A.D. 348.*

I (or We) believe

- I. 1. In one God the Father, Almighty, maker of heaven and earth, and of all things visible and invisible.
  - II. 2. And in one Lord Jesus Christ, the only begotten Son of God, begotten of His Father, very God before all worlds, by whom all things were made;
  3. who for us men and for our salvation came down from heaven and was incarnate of the Holy Ghost and the Virgin Mary, and was made Man,
  4. Crucified and buried,
  5. Rose again the third day,
  6. And ascended into heaven and sat on the right hand of the Father,
  7. And shall come in glory to judge the quick and the dead, whose kingdom shall have no end.
- III. 8. And in *One* Holy Ghost, *the Paraclete*, who spake in the Prophets,
9. And in one baptism of repentance for remission of sins,
  10. And in one holy Catholic Church,
  11. And in resurrection of the flesh,
  12. And in life eternal.

3. Who for us men and for our salvation came down and was incarnate, was made man,
4. And suffered,
5. And rose the third day,
6. Ascended into Heaven,
7. Is coming to judge quick and dead.

III. 8. And in the Holy Ghost. *Revision by Cyril, A.D. 362. Council of Constantinople, A.D. 381. Council of Chalcedon, A.D. 451.*

We believe

- I. 1. In one God the Father Almighty, maker of heaven and earth, and of all things visible and invisible.
  - II. 2. And in one Lord Jesus Christ, the only begotten Son of God, begotten of His Father before all worlds, [God of God,] Light of Light, very God of very God, begotten, not made, being of one substance with the Father, by whom all things were made; Who for us men and for our salvation came down from heaven and was incarnate of the Holy Ghost and the Virgin Mary, and was made Man.
  4. And was crucified also for us under Pontius Pilate, and suffered and was buried, and
  5. He rose again the third day, according to the Scriptures,
  6. And ascended into heaven and sitteth on the right hand of the Father,
  7. And He shall come again to judge the quick and the dead, whose kingdom shall have no end.
- III. 8. And in the Holy Ghost, the Lord and Giver of Life, who proceedeth from the Father [and the Son], who with the Father and the Son together is worshipped and glorified, who spake by the Prophets,
9. In the Catholic and Apostolic Church.
  10. We acknowledge one baptism for remission of sins.
  11. We look for the resurrection of the dead,
  12. And the life of the world to come.

communion with the champions of Nicaea, and other phrases and clauses adapted for impressing on the people positive truth." Some of Cyril's personal preferences expressed in his catechetical lectures find expression, e.g. "resurrection of the dead" for "flesh."

The weak point in Hort's theory was the suggestion that the creed was brought before the council by Cyril in self justification. The election of Meletius of Antioch as the first president of the council carried with it the vindication of his old ally Cyril. Kunze's suggestion is far more probable that it was used at the baptism of Nektarius, praetor of the city, who was elected third president of the council while yet unbaptized. Unfortunately the acts of the council have been lost, but they were quoted at the council of Chalcedon in A.D. 451, and the revised Jerusalem Creed was quoted as "the faith of the 150 Fathers," that is, as confirmed in some way by the council of Constantinople, while at the time it was distinguished from "the faith of the 318 Fathers" of Nicaea. One of the signatories of the Definition of Faith made at Chalcedon, in which both creeds were quoted in full, Kalemikus, bishop of Apamea in Bithynia, refers to the council of Constantinople as having been held at the ordination of the most pious Nektarius the bishop. Obviously there was some connexion in his mind between the creed and the ordination.

The reasons which brought the revised creed into prominence at Chalcedon are still obscure. It is possible that Leo's letter to Flavian gave the impulse to put it forward because it contained a parallel to words which Leo quoted from the Old Roman Creed, "born of the Holy Ghost and the Virgin Mary," "crucified and buried," which do not occur in the first Nicene Creed. If, as is probable, it was from the election of Nektarius the baptismal creed of Constantinople, we may even ask whether the pope did not refer to it when he wrote emphatically of the "common and indistinguishable confession" of all the faithful. Kattenbusch supposes that Anatolius, bishop of Constantinople, or his archdeacon Aetius, who read the creed at the 2nd session of the council, took up the idea that through its likeness to the Roman Creed it would be a useful weapon against Eutyches and others who were held to interpret the Nicene Creed in an Apollinarian sense. But Kunze thinks that it was not used as a base of operations against Eutyches because there is some evidence that Monophysites were willing to accept it. Certainly it won its way to general acceptance in the East as the creed of the church of the imperial city; regarded as an improved recension of the Nicene Faith. The history of the introduction of the creed into liturgies is still obscure. Peter Fullo, bishop of Antioch, was the first to use it in the East, and in the West a council held by King Reccared at Toledo in 589. The theory of Probst that it had been used in Rome before this time has not been confirmed. King Reccared's council is usually credited with the introduction of the words "And the Son" into clause 9 of the creed. But some MSS.<sup>1</sup> omit them in the creed-text while inserting them in a canon of the faith drawn up at the time. Probably they were interpolated in the creed by mistake of copyists. When attention was called to the interpolation in the 9th century it became one cause of the schism between East and West. Charlemagne was unable to persuade Pope Leo III. to alter the text used in Rome by including the words. But it was so altered by the pope's successor.

The interpolation really witnessed to a deep-lying difference between Eastern and Western theology. Eastern theologians expressed the mysterious relationship of the Holy Spirit to the Father and the Son in such phrases as "Who proceedeth from the Father and receiveth from the Son," rightly making the Godhead of the Father the foundation and primary source of the eternally derived Godhead of the Son and the Spirit. Western theologians approached the problem from another point of view. Hilary, starting from the thought of Divine self-consciousness<sup>1</sup> e.g. Cod. Escorial J.c. 12, saec. x. xi. In Cod. Matritensis, p. 21 (1872), saec. x. xi., and Cod. Matritensis 10041 (begun in the year A.D. 948), the words are omitted under the heading council of Constantinople but inserted under the heading council of Toledo, in the former MS., above the line and in a later hand, which shows conclusively how the interpolation crept in.

The revised Jerusalem Creed was quoted by Epiphanius in his treatise *The Anchored One*, c. A.D. 374, some years before the council of Constantinople (A.D. 381). We gather that it had already been introduced into Cyprus as a baptismal creed. Hort's identification of it as the work of Cyril of Jerusalem is now generally accepted. On his return from exile in A.D. 362 Cyril would find "a natural occasion for the revision of the public creed by the skilful insertion of some of the conciliar language, including the term which proclaimed the restoration of full

as the explanation of the coinherence of the Father in the Son and the Son in the Father, says that the Spirit receives of both. Augustine teaches that the Father and the Son are the one principle of the Being of the Spirit. From this it is a short step to say with the *Quicumque vult* that the Spirit proceeds from the Son, while guarding the idea that the Father is the one fountain of Deity. Since Eastern theologians would be willing to say "proceeds from the Father through the Son," it is clear that the two views are not irreconcilable.

3. *The Athanasian Creed*, so called because in many MSS. it bears the title "The Faith of S. Athanasius," is more accurately designated by its first words *Quicumque vult*.<sup>1</sup> Its history has been the subject of much controversy for years past, but no longer presents an insoluble problem.

Critics indeed agree on the main outline. Until 1870 the standard work on the subject was Waterland's *Critical History of the Athanasian Creed*, first published in 1723. Having traced "the opinions of the learned moderns" from Gerard Vossius, A.D. 1642, "who led the way to a more strict and critical inquiry," Waterland passed in review all the known MSS. and commentaries, and after a searching investigation concluded that the creed was written in Gaul between 420 and 430, probably by Hilary of Arles.

In 1870 the controversy on the use of the creed in the Book of Common Prayer led to fresh investigation of the MSS., and a theory known as the "Two-portion theory" was started by C. A. Swainson, developed by J. R. Lumby, and adopted by Harnack. Swainson thought that the *Quicumque* was brought into its present shape in the 9th century. The so-called profession of Denebert, bishop-elect of Worcester, in A.D. 798 presented to the archbishop of Canterbury (which includes clauses 1, 3-6, 20-22, 24, 25), and the Trèves fragment (a portion of a sermon in *Paris bibl. nat. Lat.* 3836, *saec.* viii., which quoted clauses 27-34, 36-40), seemed to him to represent the component parts of the creed as they existed separately. He conjectured that they were brought together in the province of Rheims c. 860.

This theory, however, depended upon unverified assumptions, such as the supposed silence of theologians about the creed at the beginning of the 9th century; the suggestion that the completed creed would have been useful to them if they had known it as a weapon against the heresy of Adoptianism; the assertion that no MS. containing the complete text was of earlier date than c. 813. This was Lumby's revised date, but the progress of palaeographical studies has made it possible to demonstrate that MSS. of the 8th century do exist which contain the complete creed.

The two-portion theory was vigorously attacked by G. D. W. Ommanney, who was successful in the discovery of new documents, notably early commentaries, which contained the text of the creed embedded in them, and thus supplied independent testimony to the fact that the creed was becoming fairly widely known at the end of the 8th century. Other new MSS. and commentaries were found and collated by the Rev. A. E. Burn and Dom Morin. In 1897 Loofs, summing up the researches of 25 years in his article *Athanasianum* (*Realencyclopädie f. prot. Theol. u. Kirche*, 3rd ed. ii. p. 177), declared that the two-portion theory was dead.

This conclusion has never been seriously challenged. It has been greatly strengthened by the discovery of a MS. which was presented by Bishop Leidrad of Lyons with an autograph inscription to the altar of St Stephen in that town, some time before 814. As M. Delisle at once pointed out (*Notices et extraits des manuscrits*, 1898), this MS. supplies a fixed date from which palaeographers can work in dating MSS. The *Quicumque* occurs in a collection of materials forming an introduction to the psalter. The suggestion has been made that Leidrad intended to use the *Quicumque* in his campaign against the Adoptianists in 798. But the phrases of the creed seem to have needed sharpening

<sup>1</sup>The first person who doubted the authorship seems to have been Joachim Camerarius, 1551, who was so fiercely attacked in consequence that he omitted the passage from his Latin edition. *Zeitschrift für K.G.* x. (1889), p. 497.

against the Nestorian tendency of the Adoptianists. It is more probable that Leidrad was interested in the growing use of the creed as a canticle, and was consulted in the preparation of the famous Golden Psalter, now at Vienna, which contains the same collection of documents as an introduction. This MS. may now without hesitation be assigned to the date 772-788. The earliest known MS. is at Milan (*Cod. Ambros. O.* 212, *sup.*), and is dated by Traube as early as c. 700.

There is a reference to the *Quicumque* in the first canon of the fourth council of Toledo of the year 633, which quotes part or the whole of clauses 4, 20-22, 28 f., 31, 33, 35 f., 40. The council also quoted phrases from the so-called *Creed of Damasus*, a document of the 4th century, which in some cases they preferred to the phrases of the *Quicumque*. Their quotations form a connecting link in the chain of evidence by which the use of the creed may be traced back to the writings of Caesarius, bishop of Arles (503-543). Dom Morin has now demonstrated ("Le Symbole d'Athanase et son premier témoin S. Césaire d'Arles," *Rev. Benedictine*, Oct. 1901) that Caesarius used the creed continually as a sort of elementary catechism. The fact that it exactly reproduces both the qualities and the literary defects of Caesarius is a strong argument in favour of Morin's suggestion that he may have been the author. Further, Caesarius was in the habit of putting some words of a distinguished writer at the head of his compositions, which would account for the fact that the name of Athanasius was subsequently attached to the creed.

The use, however, of the *Quicumque* by Caesarius as a catechism may be explained by the suggestion that it had been taught him in his youth, so that his style had been moulded by it. He was not an original thinker. Moreover, the creed is quoted by his rival Avitus, bishop of Vienne 490-523, who quotes clause 22, as from the Rule of Catholic Faith, but was not likely to value a composition of Caesarius so highly. Morin does not deal fully with the arguments from internal evidence which point back to the beginning of the 5th century as the date of the creed. If the creed-phrases needed sharpening against the revived Nestorian error of the Adoptianists, it is scarcely likely to have been written during the generation following the condemnation of Nestorius in 431. Burn suggests that it was written to meet the Sabellian and Apollinarian errors of the Spanish heretic Priscillian, possibly by Honoratus, bishop of Arles (d. 429). He suggests further that the *Creed of Damasus* was the reply of that pope to Priscillian's appeal. This would explain the quotation of the two documents together by the council of Toledo, since the heresy lasted on for a long time in Spain. But the theory has been carried to extravagant lengths by Künstle, who thinks that the creed was written in Spain in the 5th century, and soon taken to the monastery of Lerins. There are phrases in the writings of Vincentius of Lerins and of Faustus, bishop of Riez, which are parallel to the teaching of the creed, though they cannot with any confidence be called quotations. They tend in any case to prove that the *Quicumque* comes to us from the school of Lerins, of which Honoratus was the first abbot, and to which Caesarius also belonged.

The earliest use of the *Quicumque* was in sermons, in which the clauses were quoted, as by the council of Toledo without reference to the creed as a whole. From the 8th century, if not from earlier times, commentaries were written on it. The writer of the Oratorian Commentary (Theodulf of Orleans?) addressing a synod which instructed him to provide an exposition of this work on the faith, writes of it, as "here and there recited in our churches, and continually made the subject of meditation by our priests." It was soon used as a canticle. Angilbert, abbot of St Riquier (c. 814), records that it was sung by his school in procession on rogation days. It passed into the office of Prime, apparently first at Fleury. In the first Prayer Book of Edward VI. it was "sung or said" after the Benedictus on the greater feasts, and this use was extended in the second Prayer Book. In 1662 the rubric was altered and it was substituted for the Apostles' Creed. It has no place in the offices of the Eastern Orthodox Church, but is found, without the words "And the Son" of clause 22, in the appendix of many modern



editions. In the Russian service books it appears at the beginning of the psalter.

The controversy on its use in modern times has turned mainly on the interpretation of the warning clauses. No new translation can put an end to the difficulty. While it is true that the Church has never condemned individuals, and that the warnings refer only to those who have received the faith, and do not touch the question of the unbaptized, there is a growing feeling that they go beyond the teaching of Holy Scripture on the responsibility of intellect in matters of faith.<sup>1</sup>

On the other hand the creed is a valuable statement of Catholic faith on the Trinity and the Incarnation, and its use for students and teachers at least is by no means obsolete. The special characteristic of its theology is in the first part where it owes most to the teaching of Augustine, who in his striving after self-knowledge analysed the mystery of his own triune personality and illustrated it with psychological images, "I exist and I am conscious that I exist, and I love the existence and the consciousness; and all this independently of any external influence." Such a ripper analysis of the mystery of his own personality enabled him to arrive at a clearer conception of the idea of divine personality, "whose triunity has nothing potential or unrealized about it; whose triune elements are eternally actualized, by no outward influence, but from within; a Trinity in Unity."<sup>2</sup>

II. MODERN CONFESSIONS OF FAITH.—The second great creed-making epoch of Church history opens in the 16th century with the Confession of Augsburg. The famous theses which Luther nailed to the door of the church at Wittenberg in 1517 cannot be called a confession, but they expressed a protest which could not rest there. Some reconstruction of popular beliefs was needed by many consciences. There is a striking contrast between the crudeness of much and widely accepted medieval theology and the decrees of the council of Trent. Even from the Roman Catholic standpoint such a need was felt. Luther himself had a gift of words which through his catechisms made the reformed theology popular in Germany. In 1530 it became necessary to define his position against both Romanists and Zwinglians.

1. *The Confession of Augsburg* was drawn up by Melancthon, revised by Luther, and presented to the emperor Charles V. at the diet of Augsburg. Some 21 of its articles dealt with doctrine, 7 with ecclesiastical abuses. It expounded in terse and significant teaching the doctrine (1) of God, (2) of original sin, (3) of the Son of God, (4) of justification . . . , (21) of the worship of saints. The abuses which it was maintained had been corrected by Lutheranism were discussed in articles (1) on Communion in both kinds, (2) on the marriage of clergy, (3) on the Mass, &c. (see AUGSBURG, CONFESSION OF).

The main difference between these, the first of a long series of articles of religion and the ancient creeds, lies in the fact that they are manifestoes embodying creeds and answering more than one purpose. This is the reason of their frequent failure to convey any sense of proportion in the expression of truth. The disciplinary question of clerical marriage is not of the same primary importance as the doctrinal questions involved in the restoration of the cup to the laity, or discussed in the subsequent article on the mass. As has been well said by a learned Baptist theologian, Dr Green: "It was by a true divine instinct that the early theologians made Christ Himself, in His divine-human personality, their centre of the creeds."<sup>3</sup> The fundamental questions of Christianity, exhibited in the Apostles' Creed, should be marked

<sup>1</sup> In response to an invitation issued by the archbishop of Canterbury, acting on a resolution of the Lambeth Conference of 1908, a committee of eminent scholars met in April and May 1909 for the purpose of preparing a new translation. Their report, issued on the 18th of October, stated that they had "endeavoured to represent the Latin original more exactly in a large number of cases." The general effect of the new version is to make the creed more comprehensible, e.g. by the substitution of "infinite" and "reasoning" for such archaisms as "incomprehensible" and "reasonable." The sense of the damnatory clauses has, however, not been weakened. [Ed.]

<sup>2</sup> Illingworth, *Personality, Human and Divine*, p. 40.

<sup>3</sup> *The Christian Creed and the Creeds of Christendom*, p. 181.

off as standing on a higher plane than others. In this respect catechisms of modern times, from Luther's down to the recent Evangelical catechism of the Free Churches, and including from their respective points of view both the catechism of the Church of England and the catechism of the council of Trent, are markedly superior to articles and synodical decrees. The failure of the latter was really inevitable. In the 16th century a spirit of universal questioning was rife, and it is this utter unsettlement of opinion which is reflected in the discussions of doubts on matters only remotely connected with "the faith once for all delivered unto the saints" (Jude 3). Moreover, fresh complications arose from the confusion in which the question of the duties and rights of the civil power was entangled. In an age when the foundations of the system on which society had rested for centuries were seriously shaken, such subjects as the right of the magistrate to interfere with the belief of the individual, and the limits of his authority over conscience, naturally assumed a prominence hitherto unknown.<sup>4</sup>

2. *Other Lutheran Formularies*.—For the purpose of classification it will be convenient to discuss Lutheran, Zwinglian and Calvinistic confessions separately.

An elaborate *Apology* for the confession of Augsburg was drawn up by Melancthon in reply to Roman Catholic criticisms. This, together with the confession, the articles of *Lutheran*. Schmalkalden, drawn up by Luther in 1536, Luther's catechisms, and the Formula of Concord which was an attempt to settle doctrinal divisions promulgated in 1580, sum up what is called "the confessional theology of Lutheranism." Of less influence in the subsequent history of Lutheranism, but of interest as used by Archbishop Parker in the preparation of the Elizabethan articles of 1563, is the confession of Württemberg. It was presented to the council of Trent by the ambassador of the state of Württemberg in 1552. Its thirty-five articles contain a moderate statement of Lutheran teaching.

3. *Zwinglian and Calvinistic Confessions*.—The confession of the Four Cities, Strassburg, Constance, Memmingen and London, was drawn up by M. Bucer and was presented to Charles V. at Augsburg in 1530. These cities were inclined to follow Zwingli in his sacramental teaching which was more fully expressed in the Confession of Basel (1534) and the First Helvetic Confession (1536). Calvin's views were expressed in the Gallican Confession, containing forty articles, which was drawn up in 1559, and was presented both to Francis II. of France and to Charles IX. On the same lines the Belgian Confession of 1561, written by Guido de Brès in French, and translated into Dutch was widely accepted in the Netherlands and confirmed by the synod of Dort (1619). The second Helvetic Confession was the work of Bullinger, published at the request of the Elector Palatine Frederick III. in 1566, and was held in repute in Switzerland, Poland and France as well as the Palatinate. It was sanctioned in Scotland and was well received in England.

These confessions teach the root idea of Calvin's theology, the immeasurable awfulness of God, His eternity, and the immutability of His decrees. Such strict Calvinism was the strength also of the Westminster Confession (see below), but was soon weakened in Germany. This same Elector Frederick invited two young divines, Zacharias Ursinus and Caspar Olevianus, to prepare the afterwards celebrated Heidelberg catechism, which in 1563 superseded Calvin's catechism in the Palatinate. While Calvin began sternly with the question, "What is the chief end of human life?" Ans.: "That men may know God by whom they were created,"—the Heidelberg catechism has: "What is thy only comfort in life and death?" Ans.: "That I with body and soul, both in life and death, am not my own, but belong to my faithful Saviour Jesus Christ." This catechism has been called the charter of the German Reformed Church. It contains three divisions dealing with (1) man's sin, misery, redemption, (2) the Trinity, (3) thankfulness, under which is included all practical Christian life lived in gratitude for mercies received.

<sup>4</sup> Gibson, *The Thirty-nine Articles*, p. 2.

4. *English Articles of Religion*.—The ten articles of 1536 were drawn up by Convocation at the bidding of Henry VIII.

*Articles of Religion.*

“to stablysh Christian Quietnes and Unitie.” They exhibit a traditional character, a compromise between the old and the new learning. Thus the doctrine of the Real Presence is asserted, but no mention is made of Transubstantiation. Medieval ceremonies are described as useful but without power to remit sins. Two years later, after negotiations with the Lutheran princes, a conference on theological matters was held at Lambeth with Lutheran envoys. Thirteen articles were drawn up, which, though never published (they were found among Cranmer’s papers at the beginning of the 19th century), had some influence on the forty-two articles. Some of them were taken from the confession of Augsburg, but the sections on Baptism, the Eucharist and penance, show that the English theologians desired to lay more emphasis on the character of sacraments as channels of grace. The Statute of the Six Articles (1539), “the whip with six strings,” was the outcome of the retrograde policy which distinguished the latter years of Henry VIII.

With the accession of Edward VI. liturgical reforms were set on foot before an attempt was made to systematize doctrinal teaching. But as early as 1549 Cranmer had in hand “Articles of Religion” to which he required all preachers and lecturers to subscribe. In 1552 they were revised by other bishops and were laid before the council and the royal chaplains. They were then published as “Articles agreed on by the bishops and other learned men in the Synod of London.” But there is considerable doubt whether they really received the sanction of Convocation (Gibson, p. 15). They were not devised as a complete scheme of doctrine, but only as a guide in dealing with current errors of (i.) the Medievalists and (ii.) the Anabaptists. Under (i.) they condemned the doctrine of the school authors on congruous merit (Art. xii.), the doctrine of grace *ex opere operato* (xxvi.). Transubstantiation (xxix.). Under (ii.) they laid stress on the fundamental articles of the faith (Art. i.-iv.), affirmed the Three Creeds (vii.), since many Anabaptists held Arian and Socinian opinions which were rife in Switzerland, Italy and Poland, condemning also their views on original sin (viii.), community of goods (xxxvii.), and on other subjects in articles which do not mention them by name.

The revision undertaken in 1563 by Archbishop Parker, aided by Edm. Guest, bishop of Rochester, shows “an attempt to give greater completeness to the formulary,” and to make clearer the Catholic position of the Church of England. For the clause (Art. xxviii.) which denied the Real Presence was substituted one by Guest with the desire “not to deny the reality of the presence of the Body of Christ in the Supper, but only the grossness and sensibleness in the receiving thereof.” At the same time the substitution of “Romish doctrine” for “doctrine of School authors” (Art. xxii.) marks an effort to define the line of the Church of England sharply against current Roman teaching. The revision was passed by Convocation and again revised in 1571, when the queen had been excommunicated by papal bull, and an act was passed ordering all clergy to subscribe to them. They have remained unchanged ever since, though the terms of subscription have been modified.

An attempt was made to add nine articles of a strong Calvinistic tone, which were drawn up by Dr Whitaker, regius professor of divinity at Cambridge, and submitted to Archbishop Whitgift. They were rejected both by Queen Elizabeth, and, after the Hampton Court Conference petitioned about them, by King James I.

The first Scottish confession dates from 1560. It is a memorial of the intellectual power and enthusiasm of John Knox. It exhibits the leading features of the Reformed theology, but “disclaims Divine authority for any fixed form of church government or worship.” It also asks that “if anyone shall note in this our confession any articles or sentence repugnant of God’s Holy Word, that it would please him of his gentleness and for Christian charity’s sake, to admonish of the same in writing,” promising that if the teaching cannot be proved, to reform it. Between this and the Westminster Confession must be noted the first Baptist confession, published in Amsterdam in 1611.

It shows the influence of Arminian theology against Calvinism, which was vigorously upheld in the *Quin-particular* formula, put forward by the synod of Dort in 1619 to uphold the five points of Calvinism, after heated discussion, in which English delegates took part, of the problems of divine omniscience and human free-will.

5. *The Westminster Confession* (1648), with its two catechisms, is perhaps the ablest of the reformed confessions from the standpoint of Calvinism. Its keynote is sovereignty.

*Westminster Confession.*

“The Decrees of God are His eternal Purpose according to the Counsel of His Will, whereby for His Own Glory He hath foreordained whatsoever comes to pass.”

Man’s part is to accept them with submission. As the Anglican divines soon ceased to attend the assembly, and the Independents were few in number, it was the work of Presbyterians only, the Scottish members carrying their proposal to make it an independent document and not a mere revision of the Thirty-nine Articles. After discussions lasting for two years it was debated in parliament, finished on the 22nd of March 1648, and was adopted by the Scottish parliament in the following year. It is the only confession which has been imposed by authority of parliament on the whole of the United Kingdom. This lasted in England for ten years. In Scotland its influence has continued to the present day, contributing not a little to mould the high qualities of religious insight and courage and perseverance which have honourably distinguished Scottish Presbyterians all the world over. This was the last great effort in constructive theology of the Reformation period. When Cromwell before his death in 1658 allowed a conference to prepare a new confession of faith for the whole commonwealth, the Westminster Confession was accepted as a whole with an added statement on church order and discipline. We must note, however, that the Baptist divines who were excluded from the Westminster Assembly issued a declaration of their principles under the title, “A Confession of Faith of seven Congregations or Churches in London which are commonly but unjustly called Anabaptists, for the Vindication of the Truth and Information of the Ignorant.”

Two other declarations may be quoted to show how necessary such confessions are even to religious societies which refuse to be bound by them. In 1675 Robert Barclay published an “Apology for the Society of Friends,” in which he declared what they held concerning revelation, scripture, the fall, redemption, the inward light, freedom of conscience.

In 1833 the Congregational Union published a Declaration or Confession of Faith, Church Order and Discipline. It was prepared by Dr George Redford or Worcester, and was presented, not as a scholastic or critical confession of faith, but merely such a statement as any intelligent member of the body might offer as containing its leading principles. It deals with the Bible as the final appeal in controversy, the doctrines of God, man, sin, the Incarnation, the Resurrection of our Lord Jesus Christ, “both the Son of man and the Son of God,” the work of the Holy Spirit, justification by faith, the perpetual obligation of Baptism and the Lord’s Supper, final judgment, the law of Christian fellowship. The same principles have been lucidly stated in the Evangelical Free Church catechism.

6. *Confessions in the Eastern Orthodox Church*.—The Eastern Church has no general doctrinal tests beyond the Nicene Creed, but from time to time synods have approved expositions of the faith such as the Athanasian Creed

*Greek church.*

(without the words “And the Son”), and the Orthodox Confession of the Catholic and Apostolic Eastern Church. This was the work of Petrus Mogilas, metropolitan of Kiev, and other theologians. It was written in 1640 in Russian, was translated into Greek, and approved by the council of Jassy and the patriarchs of Constantinople, Alexandria, Antioch and Jerusalem. It was affirmed by the council of Jerusalem in 1672, which also affirmed the Confession of Dositheus, patriarch of Jerusalem. Both of these confessions were drawn up to confute the teaching of a remarkable man who had been patriarch of Constantinople, Cyril Lucar. He was a student of Western theology, a correspondent of Archbishop Laud, and had travelled in Germany and Switzerland. In 1629 he

published a confession in which he attempted to incorporate ideas of the reformers while preserving the leading ideas of Eastern traditional theology. The controversy chiefly turned on the question of the necessity of episcopacy. Dositheus taught that the existence of bishops is as necessary to the Church as "breath to a man and the sun to the world." Christ is the universal and perpetual Head of the Church, but he exercises his rule by means of "the holy Fathers," that is, the bishops whom the Holy Ghost has appointed to be in charge of local churches.

Mention may also be made of the longer catechism of the Orthodox Catholic Church compiled by Philaret, metropolitan of Moscow, revised and adopted by the Russian Holy Synod in 1839. The Church is defined as "a divinely-instituted community of men, united by the orthodox faith, the law of God, the hierarchy and the sacraments."

7. *Roman Catholic Formularies.*—For our present purpose the distinctive features of Roman Catholicism may be said to be summed up in the decrees of the council of Trent and the creed of Pope Pius IV. The council sat at intervals from 1545–1563, but there was a marked divergence between the opinions advocated by prominent members of the council and its final decrees. Cardinal Pole had to leave the council because he advocated the doctrine of justification by faith. Even at the later sessions the cardinal of Lorraine with the French prelates supported the German representatives in requests for the cup for the laity, the permission of the marriage of priests, and the revision of the breviary. Finally the decisions of the council were promulgated in a declaration of XII. articles, usually called the Creed of Pius IV., which reaffirmed the Nicene Creed, and dealt with the preservation of the apostolic and ecclesiastical traditions, the interpretation of the Holy Scriptures "according to the sense which our Holy Mother Church has held," the seven sacraments, the offering of the mass, transubstantiation, purgatory, the veneration of saints, relics, images, the efficacy of indulgences, the supremacy of the Roman Church and of the bishop of Rome as vicar of Christ. To this summary of doctrine should be added the dogmas of the immaculate conception of the Blessed Virgin declared in 1854, and of papal infallibility decreed by the Vatican council of 1870.

*Conclusion.*—In this survey of Christian confessions it has been impossible to do more than barely name many which deserve discussion. This is a subject which has grown in importance and is likely to grow further. The very intensity of that phase of modern thought which declaims fervently against all creeds, and would maintain what George Eliot called "the right of the individual to general haziness," is likely to draw all Christian thinkers nearer to one another in sympathy through acceptance of the Apostles' Creed as the common basis of Christian thought. In the words of Hilary of Poitiers, "Faith gathers strength through opposition."

The question at once arises, Can the simple historic faith be maintained without adding theological interpretations, those arid wastes of dogma in which the springs of faith and reverence run dry? The answer is No. We cannot ask to be as if through nineteen centuries no one had ever asked a question about the relation of the Lord Jesus Christ to the Father and the Holy Spirit. If we could come back to the Bible and use biblical terms only, as Cyril of Jerusalem wished in his early days, we know from experience that the old errors would reappear in the form of new questions, and that we should have to pass through the dreary wilderness of controversy from implicit to explicit dogma, from "I believe that Jesus is the Lord" to the confession that the Only Begotten Son is "of one substance with the Father." In the words of Hilary again:

"Faithful souls would be contented with the word of God which bids us: 'Go teach all nations, baptizing them in the name of the Father and of the Son and of the Holy Ghost.' But also we are drawn by the faults of our heretical opponents to do things unlawful, to scale heights inaccessible, to speak out what is unspeakable, to presume where we ought not. And whereas it is by faith alone that we should worship the Father and reverence the Son, and be filled with the Spirit, we are now obliged to strain our weak human language in the utterance of things beyond its scope; forced into

this evil procedure by the evil procedure of our foes. Hence what should be matter of silent religious meditation must now needs be imperilled by exposition in words."

The province of reverent theology is to aid accurate thinking by the use of metaphysical or psychological terms. Its definitions are no more an end in themselves than an analysis of good drinking water, which by itself leaves us thirsty but encourages us to drink. So the Nicene Creed is the analysis of the river of the water of life of which the Sermon on the Mount is a description, flowing on from age to age, freely offered to the thirsty souls of men.

This justification of the ancient creeds carries with it the justification of later confessions so far as they answered questions which would be fatal to religion if they were not answered. As Principal Stewart puts it very clearly: "The answer given is based on the philosophy or science of the period. It does not necessarily form part of the religion itself, but is the best which with the materials at its command, in its own defence and in its love for truth, the religion (and its advocates) can give. But the answers may be superseded by better answers, or they may be rendered unnecessary because the questions are no longer asked. Thus the Calvinism of the 16th and 17th centuries elaborated answers to questions, which if no attempt had been made to answer them, would have perplexed earnest souls and condemned the system; but many parts of the system are now obsolete, because the conditions which suggested the questions which they sought to answer no longer exist or have no longer any interest or importance."

LITERATURE.—See J. Pearson, *Exposition of the Creed* (new ed., 1849); A. E. Burn, *Introduction to the Creeds* (1899), and *The Athanasian Creed* in vol. iv. of *Texts and Studies* (1896); H. B. Swete, *The Apostles' Creed* (1899); F. Kattenbusch, *Das apostolische Symbol* (1894–1900); C. A. Heurtley, *Harmonia Symbolica* (1858); C. P. Caspari, *Quellen zur Geschichte des Taufsymbols und der Glaubensregel* (Christiania, 1866); and *Alle und neue Quellen* (1879); T. Zahn, *Das apostolische Symbolum* (1893); C. A. Swainson, *The Nicene and Apostles' Creed* (1875); G. D. W. Ommanney, *The Athanasian Creed* (1897); B. F. Westcott, *The Historic Faith* (1882); J. Jayne, *The Athanasian Creed* (1905); J. A. Robinson, *The Athanasian Creed* (1905); E. C. S. Gibson, *The Three Creeds* (1908); F. J. A. Hort, *Two Dissertations* (1876); D. Waterland, *Crit. Hist.* edited by E. King (Oxford, 1870); F. Loofs and A. Harnack articles in *Herzog-Hauck's Realencyklopädie* ("Athanasianum" and "Konstantinopolitanisches Symbol") (1896), &c.; K. Künstle, *Antipriscillianiana* (Freiburg i. B., 1905); A. Stewart, *Croall Lectures* (in the press); S. G. Green, *The Christian Creed* (1898); P. Hall, *Harmony of Protestant Confessions* (London, 1842); F. Kattenbusch, *Confessionskunde* (Freiburg i. B., 1890); Winex's *Confessions of Christendom* (Eng. trans., Edinburgh, 1865); A. Seeberg, *Der Katechismus der Urchristenheit* (Leipzig, 1903); F. Wiegand, *Die Stellung des apostolischen Symbols* (Leipzig, 1899); H. Goodwin, *The Foundations of the Creed* (London, 1889); T. H. Bindley, *The Oecumenical Documents of the Faith* (London, 1906); J. Kunze, *Das nicänisch-konstantinopolitanische Symbol*; S. Baeumer, *Das apostolische Glaubensbekenntnis* (Mainz, 1893); B. Döxholt, *Das Taufsymbol der alten Kirche* (Paderborn, 1898); L. Hahn, *Bibliothek der Symbole u. Glaubensregeln* (Breslau, 1897); A. C. McGiffert, *The Apostles' Creed* (Edinburgh, 1902); and F. Loofs, *Symbolik* (Leipzig, 1902). (A. E. B.)

**CREEK** (Mid. Eng. *crike* or *creke*, common to many N. European languages), a small inlet on a low coast, an inlet in a river formed by the mouth of a small stream, a shallow narrow harbour for small vessels. In America and Australia especially there are many long streams which can be everywhere forded and sometimes dry up, and are navigable only at their tidal estuaries, mere brooks in width which are of great economic importance. They form complete river-systems, and are the only supply of surface water over many thousand square miles. They are at some seasons a mere chain of "water-holes," but occasionally they are strongly flooded. Since exploration began at the coast and advanced inland, it is probable that the explorers, advancing up the narrow inlets or "creeks," used the same word for the streams which flowed into these as they followed their courses upward into the country. The early settlers would use the same word for that portion of the stream which flowed through their own land, and in Australia particularly the word has the same local meaning as brook in England. On a map the whole system is called a river, e.g. the river Wakefield in South Australia gives

its name to Port Wakefield, but the stream is always locally called "the creek."

**CREEK** or **MUSKOGEE** (**MUSCOGEE**) **INDIANS** (Algonquin *maskoki*, "creeks," in reference to the many creeks and rivulets running through their country), a confederacy of North American Indians, who formerly occupied most of Alabama and Georgia. The confederacy seems to have been in existence in 1540, and then included the Muskogee, the ruling tribe, whose language was generally spoken, the Alabama, the Hitchiti, Koasati and others of the Muskogean stock, with the Yuchi and the Natchez, a large number of Shawano and the Seminoles of Florida as a branch. The Creeks were agriculturists living in villages of log houses. They were brave fighters, but during the 18th century only had one struggle, of little importance, with the settlers. The Creek War of 1813-14 was, however, serious. The confederacy was completely defeated in three hard-fought battles, and the peace treaty which followed involved the cession to the United States government of most of the Creek country. In the Civil War the Creeks were divided in their allegiance and suffered heavily in the campaigns. The so-called Creek nation is now settled in Oklahoma, but independent government virtually ceased in 1906. In 1904 they numbered some 16,000, some two-thirds being of pure or mixed Creek blood.

**CREETOWN**, a seaport of Kirkcudbrightshire, Scotland. Pop. (1901) 991. It is situated near the head of Wigtown Bay, 18 m. W. of Castle Douglas, but 23½ m. by the Portpatrick and Wigtownshire Railway. The granite quarries in the vicinity constitute the leading industry, the stone for the Liverpool docks and other public works having been obtained from them. The village dates from 1785, and it became a burgh of barony in 1792. Sir Walter Scott laid part of the scene of *Guy Mannering* in this neighbourhood. Dr Thomas Brown, the metaphysician (1778-1820), was a native of the parish (Kirkmabreck) in which Creetown lies.

**CREEVEY, THOMAS** (1768-1838), English politician, son of William Creevey, a Liverpool merchant, was born in that city in March 1768. He went to Queen's College, Cambridge, and graduated as seventh wrangler in 1789. The same year he became a student at the Inner Temple, and was called to the bar in 1794. In 1802 he entered parliament through the duke of Norfolk's nomination as member for Thetford, and married a widow with six children, Mrs Ord, who had a life interest in a comfortable income. Creevey was a Whig and a follower of Fox, and his active intellect and social qualities procured him a considerable intimacy with the leaders of this political circle. In 1806, when the brief "All the Talents" ministry was formed, he was given the office of secretary to the Board of Control; in 1830, when next his party came into power, Creevey, who had lost his seat in parliament, was appointed by Lord Grey treasurer of the ordnance; and subsequently Lord Melbourne made him treasurer of Greenwich hospital. After 1818, when his wife died, he had very slender means of his own, but he was popular with his friends and was well looked after by them; Greville, writing of him in 1829, remarks that "old Creevey is a living proof that a man may be perfectly happy and exceedingly poor. I think he is the only man I know in society who possesses nothing." He died in February 1838. He is remembered through the *Creevey Papers*, published in 1903 under the editorship of Sir Herbert Maxwell, which, consisting partly of Creevey's own journals and partly of correspondence, give a lively and valuable picture of the political and social life of the late Georgian era, and are characterized by an almost Pepysian outspokenness. They are a useful addition and correction to the *Croker Papers*, written from a Tory point of view. For thirty-six years Creevey had kept a "copious diary," and had preserved a vast miscellaneous correspondence with such people as Lord Brougham, and his step-daughter, Elizabeth Ord, had assisted him, by keeping his letters to her, in compiling material avowedly for a collection of Creevey Papers in the future. At his death it was found that he had left his mistress, with whom he had lived for four years, his sole executrix and legatee, and Greville notes in his *Memoirs* the anxiety of Brougham and others to get the papers into their

hands and suppress them. The diary, mentioned above, did not survive, perhaps through Brougham's success, and the papers from which Sir Herbert Maxwell made his selection came into his hands from Mrs Blackett Ord, whose husband was the grandson of Creevey's eldest step-daughter.

**CREFELD**, or **KREFELD**, a town of Germany, in the Prussian Rhine province, on the left side of and 3 m. distant from the Rhine, 32 m. N.W. from Cologne, and 15 m. N.W. from Düsseldorf, with which it is connected by a light electric railway. Pop. (1875) 62,905; (1905) 110,410. The town is one of the finest in the Rhine provinces, being well and regularly built, and possessing several handsome squares and attractive public gardens. A striking point about the inner town is that it forms a large rectangle, enclosed by four wide boulevards or "walls." This feature, rare in German towns, is due to the fact that Crefeld was always an "open place," and that therefore the circular form of a fortress town could be dispensed with. It has six Roman Catholic and four Evangelical churches (of which the Gothic Friedenskirche with a lofty spire, and the modern church of St Joseph, in the Romanesque style, are alone worth special mention); there are also a Mennonite and an Old Catholic church. The town hall, decorated with frescoes by P. Janssen (b. 1844), and the Kaiser Wilhelm Museum are the most noteworthy secular buildings. In the promenades are monuments to Moltke, Bismarck and Karl Wilhelm, the composer of the *Wacht am Rhein*. Among the schools and scientific institutions of the town the most important is the higher grade technical school for the study of the textile industries, which is attended by students from all parts of the world. Connected with this are subsidiary schools, notably one for dyeing and finishing.

Crefeld is the most important seat of the silk and velvet manufactures in Germany, and in this industry the larger part of the population of town and neighbourhood is employed. There are upwards of 12,000 silk power-looms in operation, and the value of the annual output in this branch alone is estimated at £3,000,000. A special feature is the manufacture of silk for covering umbrellas; while of its velvet manufacture that of velvet ribbon is the chief. The other industries of the town, notably dyeing, stuff-printing and stamping, are very considerable, and there are also engineering and machine shops, chemical, cellulose, soap, and other factories, breweries, distilleries and tanneries. The surrounding fertile district is almost entirely laid out in market gardens. Crefeld is an important railway centre, and has direct communication with Cologne, Rheydt, München-Gladbach and Holland (via Zevenaar).

Crefeld is first mentioned in records of the 12th century. From the emperor Charles IV. it received market rights in 1361 and the status of a town in 1373. It belonged to the counts of Mörs, and was annexed to Prussia, with the countship, in 1702. It remained a place of little importance until the 17th century, when religious persecution drove to it a number of Calvinists and Separatists from Jülich and Berg (followed later by Mennonites), who introduced the manufacture of linen. The number of such immigrants still further increased in the 18th century, when, the silk industry having been introduced from Holland, the town rapidly developed. The French occupation in 1795 and the resulting restriction of trade weighed for a while heavily upon the new industry; but with the termination of the war and the re-establishment of Prussian rule the old prosperity returned.

**CREIGHTON, MANDELL** (1843-1901), English historian and bishop of London, was born at Carlisle on the 5th of July 1843, being the eldest son of Robert Creighton, a well-to-do upholsterer of that city. He was educated at Durham grammar school and at Merton College, Oxford, where he was elected to a postmastership in 1862. He obtained a first-class in *literae humaniores*, and a second in law and modern history in 1866. In the same year he became tutor and fellow of Merton. He was ordained deacon, on his fellowship, in 1870, and priest in 1873; in 1872 he had married Louise, daughter of Robert von Glehn, a London merchant (herself a writer of several successful books of history). Meanwhile he had published several small historical works; but his college and university duties left little time for writing,

and in 1875 he accepted the vicarage of Embleton, a parish on the coast of Northumberland, near Dunstanburgh, with an ancient and beautiful church and a fortified parsonage house, and within reach of the fine library in Bamburgh Keep. Here he remained for nearly ten years, acquiring that experience of parochial work which afterwards stood him in good stead, taking private pupils, studying and writing, as well as taking an active part in diocesan business. Here too he planned and wrote the first two volumes of his chief historical work, the *History of the Papacy*; and it was in part this which led to his being elected in 1884 to the newly-founded Dixie professorship of ecclesiastical history at Cambridge, where he went into residence early in 1885. At Cambridge his influence at once made itself felt, especially in the reorganization of the historical school. His lectures and conversation classes were extraordinarily good, possessing as he did the rare gift of kindling the enthusiasm without curbing the individuality of his pupils. In 1886 he combined with other leading historians to found the *English Historical Review*, of which he was editor for five years. Meanwhile the vacations were spent at Worcester, where he had been nominated a canon residentiary in 1885. In 1891 he was made canon of Windsor; but he never went into residence, being appointed in the same year to the see of Peterborough. He threw himself with characteristic energy into his new work, visiting, preaching and lecturing in every part of his diocese. He also found time to preach and lecture elsewhere, and to deliver remarkable speeches at social functions; he worked hard with Archbishop Benson on the Parish Councils Bill (1894); he became the first president of the Church Historical Society (1894), and continued in that office till his death; he took part in the Laud Commemoration (1895); he represented the English Church at the coronation of the tsar (1896). He even found time for academical work, delivering the Hulsean lectures (1893-1894) and the Rede lecture (1894) at Cambridge, and the Romanes lecture at Oxford (1896).

In 1897, on the translation of Dr Temple to Canterbury, Bishop Creighton was transferred to London. During Dr Temple's episcopate ritual irregularities of all kinds had grown up, which left a very difficult task to his successor, more especially in view of the growing public agitation on the subject, of which he had to bear the brunt. As was only natural, his studied fairness did not satisfy partisans on either side; and his efforts towards conciliation laid him open to much misunderstanding. His administration, none the less, did much to preserve peace. He strained every nerve to induce his clergy to accept his ruling on the questions of the reservation of the Sacrament and of the ceremonial use of incense in accordance with the archbishop's judgment in the Lincoln case; but when, during his last illness, a prosecutor brought proceedings against the clergy of five recalcitrant churches, the bishop, on the advice of his archdeacons, interposed his veto. One other effort on behalf of peace may be mentioned. In accordance with a vote of the diocesan conference, the bishop arranged the "Round Table Conference" between representative members of various parties, held at Fulham in October 1900, on "the doctrine of the Holy Eucharist and its expression in ritual," and a report of its proceedings was published with a preface by him. The true work of his episcopate was, however, positive, not negative. He was an excellent administrator; and his wide knowledge, broad sympathies, and sound common sense, though they placed him outside the point of view common to most of his clergy, made him an invaluable guide in correcting their too often indiscreet zeal. He fully realized the special position of the English Church in Christendom, and firmly maintained its essential teaching. Yet he was no narrow Anglican. His love for the English Church never blinded him to its faults, and no man was less insular than he. As he was a historian before he became a bishop, so it was his historical sense which determined his general attitude as a bishop. It was this, together with a certain native taste for ecclesiastical pomp, which made him—while condemning the unhistorical extravagances of the ultraritualists—himself a ritualist. He was the first bishop of London,

since the Reformation, to "pontificate" in a mitre as well as the cope, and though no man could have been less essentially "sacerdotal" he was always careful of correct ceremonial usage. His interests and his sympathies, however, extended far beyond the limits of the church. He took a foremost part in almost every good work in his diocese, social or educational, political or religious; while he found time also to cultivate friendly relations with thinking men and women of all schools, and to help all and sundry who came to him for advice and assistance. It was this multiplicity of activities and interests that proved fatal to him. By degrees the work, and especially the routine work, began to tell on him. He fell seriously ill in the late summer of 1900, and died on the 14th of January 1901. He was buried in St Paul's cathedral, where a statue surmounts his tomb.

He was a man of striking presence and distinguished by a fine courtesy of manner. His irrespressible and often daring humour, together with his frank distaste for much conventional religious phraseology, was a stumbling-block to some pious people. But beneath it all lay a deep seriousness of purpose and a firm faith in what to him were the fundamental truths of religion.

Bishop Creighton's principal published works are: *History of the Papacy during the Period of the Reformation* (5 vols., 1882-1897, new ed.); *History of the Papacy from the Great Schism to the Sack of Rome* (6 vols., 1897); *The Early Renaissance in England* (1895); *Cardinal Wolsey* (1895); *Life of Simon de Montfort* (1876, new ed. 1895); *Queen Elizabeth* (1896). He also edited the series of *Epochs of English History*, for which he wrote "The Age of Elizabeth" (13th ed., 1897); *Historical Lectures and Addresses by Mandell Creighton, &c.*, edited by Mrs Creighton, were published in 1903.

See *Life and Letters of Mandell Creighton, &c.*, by his wife (2 vols., 1904); and the article "Creighton and Stubbs" in *Church Quarterly Review* for Oct. 1905.

**CREIL**, a town of northern France, in the department of Oise, 32 m. N. of Paris on the Northern railway, on which it is an important junction. Pop. (1906) 9234. The town is situated on the Oise, on which it has a busy port. The manufacture of machinery, heavy iron goods and nails, and copper and iron founding, are important industries, and there are important metallurgical and engineering works at Montataire, about 2 m. distant; bricks and tiles and glass are also manufactured, and the Northern railway has workshops here. The church (12th to 15th centuries) is in the Gothic style. There are some traces of a castle in which Charles VI. resided during the period of his madness. Creil played a part of some importance in the wars of the 14th, 15th and 16th centuries.

**CRELL** (or **KRELL**), **NICHOLAS** (c. 1551-1601), chancellor of the elector of Saxony, was born at Leipzig, and educated at the university of his native town. About 1580 he entered the service of Christian, the eldest son of Augustus I., elector of Saxony, and when Christian succeeded his father as elector in 1586, became his most influential counsellor. Crell's religious views were Calvinistic or Crypto-Calvinistic, and both before and after his appointment as chancellor in 1589 he sought to substitute his own form of faith for the Lutheranism which was the accepted religion of electoral Saxony. Calvinists were appointed to many important ecclesiastical and educational offices; a translation of the Bible with Calvinistic annotations was brought out; and other measures were taken by Crell to attain his end. In foreign politics, also, he sought to change the traditional policy of Saxony, acting in unison with John Casimir, administrator of the Rhenish Palatinate, and promising assistance to Henry IV. of France. These proceedings, coupled with the jealousy felt at Crell's high position and autocratic conduct, made the chancellor very unpopular, and when the elector died in October 1591 he was deprived of his offices and thrown into prison by order of Frederick William, duke of Saxe-Altenburg, the regent for the young elector Christian II. His trial was delayed until 1595, and then, owing partly to the interference of the imperial court of justice (*Reichskammergericht*), dragged on for six years. At length it was referred by the emperor Rudolph II. to a court



of appeal at Prague, and sentence of death was passed. This was carried out at Dresden on the 9th of October 1601.

See A. V. Richard, *Der kurfürstliche sächsische Kanzler Dr Nikolaus Krell* (Frankfort, 1860); B. Bohnenstädt, *Das Prozessverfahren gegen den kursächsischen Kanzler Dr Nikolaus Krell* (Halle, 1901); F. Brandes, *Der Kanzler Krell, ein Opfer des Orthodoxismus* (Leipzig, 1873); and E. L. T. Henke, *Caspar Peucer und Nicolaus Krell* (Marburg, 1865).

**CREMA**, a town and episcopal see of Lombardy, Italy, in the province of Cremona, 26 m. N.E. by rail from the town of Cremona. Pop. (1901) town, 8027; commune, 9609. It is situated on the right bank of the Serio, 240 ft. above sea-level, in the centre of a rich agricultural district. The cathedral has a fine Lombard Gothic façade of the second half of the 14th century; the campanile belongs to the same period; the rest of the church has been restored in the baroque style. The clock tower opposite dates from the period of Venetian dominion in the 16th and 17th centuries. The castle, which was one of the strongest in Italy, was demolished in 1809. The church of S. Maria,  $\frac{3}{4}$  m. E. of the town, was begun in 1490 by Giov. Batt. Battaggio; it is in the form of a Greek cross, with a central dome, and the exterior is a fine specimen of polychrome Lombard work (E. Gussalli in *Rassegna d' arte*, 1905, p. 17).

The date of the foundation of Crema is uncertain. In the 10th century it appears to have been the principal place of the territory known as Isola Fulcheria. In the 12th century it was allied with Milan and attacked by Cremona, but was taken and sacked by Barbarossa in 1160. It was rebuilt in 1185. It fell under the Visconti in 1338, and joined the Lombard republic in 1447; but was taken by the Venetians in 1449, and, except from 1509 to 1529, remained under their dominion until 1797.

**CREMATION** (Lat. *cremare*, to burn), the burning of human corpses. This method of disposal of the dead may be said to have been the general practice of the ancient world, with the important exceptions of Egypt, where bodies were embalmed, Judaea, where they were buried in sepulchres, and China, where they were buried in the earth. In Greece, for instance, so well ascertained was the law that only suicides, unteethed children, and persons struck by lightning were denied the right to be burned. At Rome, one of the XII. Tables said, "Hominem mortuum in urbe ne sepelito, neve urito"; and in fact, from the close of the republic to the end of the 4th Christian century, burning on the pyre or *rogus* was the general rule.<sup>1</sup> Whether in any of these cases cremation was adopted or rejected for sanitary or for superstitious reasons, it is difficult to say. Embalming would probably not succeed in climates less warm and dry than the Egyptian. The scarcity of fuel might also be a consideration. The Chinese are influenced by the doctrine of Feng-Shui, or incomprehensible wind water; they must have a properly placed grave in their own land, and with this view their corpses are sent home from long distances abroad. Even the Jews used cremation in the vale of Tophet when a plague came; and the modern Jews of Beriin and the Spanish and Portuguese Jews at Mile End cemetery were among the first to welcome the lately revived process. Probably also, some nations had religious objections to the pollution of the sacred principle of fire, and therefore practised exposure, suspension, throwing into the sea, cave-burial, desiccation or envelopment.<sup>2</sup> Some at least of these methods must obviously have been suggested simply by the readiest means at hand. Cremation is still practised over a great part of Asia and America, but not always in the same form. Thus, the ashes may be stored in urns, or buried in the earth, or thrown to the wind, or (as among the Digger Indians) smeared with gum on the heads of the mourners. In one case the three processes of embalming, burning and burying are gone through; and in another, if a member of the tribe die at a great distance from home, some of his money and clothes are nevertheless burned by the family. As food, weapons, &c., are sometimes

buried with the body, so they are sometimes burned with the body, the whole ashes being collected.<sup>3</sup> The Siamese have a singular institution, according to which, before burning, the embalmed body lies in a temple for a period determined by the rank of the dead man,—the king for six months, and so downwards. If the poor relatives cannot afford fuel and the other necessary preparations, they bury the body, but exhume it for burning when an opportunity occurs.

There can be little doubt that the practice of cremation in modern Europe was at first stopped, and has since been prevented in great measure, by the Christian doctrine of the resurrection of the body; partly also by the notion that the Christian's body was redeemed and purified.<sup>4</sup> Some clergymen, however, as the late Mr Haweis in his *Ashes to Ashes, a Cremation Prelude* (London, 1874), have been prominent in favour of cremation. The objection of the clergy was disposed of by the philanthropist Lord Shaftesbury when he asked, "What would in such a case become of the blessed martyrs?" The very general practice of burying bodies in the precincts of a church in order that the dead might take benefit from the prayers of persons resorting to the church, and the religious ceremony which precedes both European burials and Asiatic cremations, have given the question a religious aspect. It is, however, in the ultimate resort, really a sanitary one. The disgusting results of pit-burial made cemeteries necessary. But cemeteries are equally liable to overcrowding, and are often nearer to inhabited houses than the old churchyards. It is possible, no doubt, to make a cemetery safe approximately by selecting a soil which is dry, close and porous, by careful drainage, and by rigid enforcement of the rules prescribing a certain depth (8 to 10 ft.) and a certain superficies (4 yds.) for graves. But a great mass of sanitary objections may be brought against even recent cemeteries in various countries. A dense clay, the best soil for preventing the levitation of gas, is the worst for the process of decomposition. The danger is strikingly illustrated in the careful planting of trees and shrubs to absorb the carbonic acid. Vault-burial in metallic coffins, even when sawdust charcoal is used, is still more dangerous than ordinary burial. It must also be remembered that the cemetery system can only be temporary. The soil is gradually filled with bones; houses crowd round; the law itself permits the reopening of graves at the expiry of fourteen years. We shall not, indeed, as Browne says, "be knaved out of our graves to have our skulls made drinking bowls and our bones turned into pipes!" But on this ground of sentiment cremation would certainly prevent any interruption of that "sweet sleep and calm rest" which the old prayer that the earth might lie lightly has associated with the grave. And in the meantime we should escape the horror of putrefaction and of the "small cold worm that fretteth the enshrouded form."

In Europe Christian burial was long associated entirely with the ordinary practice of committing the corpse to the grave. But in the middle of the 19th century many distinguished physicians and chemists, especially in Italy, began prominently to advocate cremation. In 1874, a congress called to consider the matter at Milan resolved to petition the Chamber of Deputies for a clause in the new sanitary code, permitting cremation under the supervision of the syndics of the commune. In Switzerland Dr Vegmann Ercolani was the champion of the cause (see his *Cremation the most Rational Method of Disposing of the Dead*, 4th ed., Zurich, 1874). So long ago as 1797 cremation was seriously discussed by the French Assembly under the Directory, and the events of the Franco-Prussian War again brought the subject under the notice of the medical press and the sanitary authorities. The military experiments at Sedan, Chalons and Metz, of burying large numbers of bodies with quicklime, or pitch and straw, were not successful, but very dangerous. The matter was considered by the municipal council of Paris in connexion with the new cemetery at Méry-sur-Oise; and the prefect

<sup>1</sup> Macrobius says it was disused in the reign of the younger Theodosius (Gibbon v. 411).

<sup>2</sup> The Colchians, says Sir Thos. Browne, made their graves in the air, i.e. on trees.

<sup>3</sup> In the case of a great man there was often a burnt offering of animals and even of slaves (see Caesar, *De bell. Gall.* iv.).

<sup>4</sup> A temple of the Holy Ghost (see Tertullian, *De anima*, c. 51, cited in Müller, *Lex. des Kirchenrechts*, s.v. "Begräbniss").

of the Seine in 1874 sent a circular asking information to all the cremation societies in Europe. In Britain the subject had slumbered for two centuries, since in 1658 Sir Thomas Browne published his quaint *Hydriotaphia, or Urn-burial*, which was mainly founded on the *De funere Romanorum* of the learned Kirchmannus. In 1817 Dr J. Jamieson gave a sketch of the "Origin of Cremation" (*Proc. Royal Soc. Edin.*, 1817), and for many years prior to 1874 Dr Lord, medical officer of health for Hampstead, continued to urge the practical necessity for the introduction of the system.

It was Sir Henry Thompson, however, who first brought the question prominently before the public. Thompson's problem was—"Given a dead body, to resolve it into carbonic acid, water and ammonia, rapidly, safely and not unpleasantly." To solve this problem, experiments were made by Dr Polli at the Milan gas works, fully described in Dr Pietra Santa's book, *La Crémation des morts en France et à l'étranger*, and by Professor Brunetti, who exhibited an apparatus at the Vienna Exhibition of 1873, and who stated his results in *La Cremazione dei cadaveri* (Padua, 1873). Polli obtained complete incineration or calcination of dogs by the use of coal-gas mixed with atmospheric air, applied to a cylindrical retort of refracting clay, so as to consume the gaseous products of combustion. The process was complete in two hours, and the ashes weighed about 5% of the weight before cremation. Brunetti used an oblong furnace of refracting brick with side-doors to regulate the draught, and above a cast-iron dome with movable shutters. The body was placed on a metallic plate suspended on iron wire. The gas generated escaped by the shutters, and in two hours carbonization was complete. The heat was then raised and concentrated, and at the end of four hours the operation was over; 180 lb of wood costing 2s. 4d. sterling was burned. In a reverberating furnace used by Sir Henry Thompson a body, weighing 144 lb, was reduced in fifty minutes to about 4 lb of lime dust. The noxious gases, which were undoubtedly produced during the first five minutes of combustion, passed through a flue into a second furnace and were entirely consumed. In the ordinary Siemens regenerative furnace (which was adapted by Reclam in Germany for cremation, and also by Sir Henry Thompson) only the hot-blast was used, the body supplying hydrogen and carbon; or a stream of heated hydrocarbon mixed with heated air was sent from a gasometer supplied with coal, charcoal, peat or wood,—the brick or iron-cased chamber being thus heated to a high degree before cremation begins.

Steps were at once taken to form an English society to promote the practice of cremation. A declaration of its objects was drawn up and signed on the 13th January 1874 by the following persons—Shirley Brooks, William Eassie, Ernest Hart, the Rev. H. R. Haweis, G. H. Hawkins, John Cordy Jeaffreson, F. Lehmann, C. F. Lord, W. Shaen, A. Strahan, (Sir) Henry Thompson, Major Vaughan, Rev. C. Voysey and (Sir) T. Spencer Wells; and they frequently met to consider the necessary steps in order to attain their object. The laws and regulations having been thoroughly discussed, the membership of the society was constituted by an annual contribution for expenses, and a subscription to the following declaration:—

"We disapprove the present custom of burying the dead, and desire to substitute some mode which shall rapidly resolve the body into its component elements by a process which cannot offend the living, and shall render the remains absolutely innocuous. Until some better method is devised, we desire to adopt that usually known as cremation."

Finally, on 29th April a meeting was held, a council was formed, and Sir H. Thompson was elected president and chairman. Mr Eassie (who in 1875 published a valuable work on *Cremation of the Dead*) was at the same time appointed honorary secretary.<sup>1</sup> In 1875 the following were added:—Mrs Rose Mary Crawshay, Mr Higford Burr, Rev. J. Long, Mr W. Robinson and the Rev. Brooke Lambert. Subsequently followed Lord Bramwell, Sir Chas. Cameron, Dr Farquharson, Sir Douglas Galton, Lord Playfair, Mr Martin Ridley Smith, Mr James A.

<sup>1</sup> This was the first society formed in Europe for the promotion of cremation.

Budgett, Mr Edmund Yates, Mr J. S. Fletcher, Mr J. C. Swinburne-Hanham, the duke of Westminster (on Lord Bramwell's death), and Sir Arthur Arnold. These may be considered the pioneers of the movement for reform.

On account of difficulties and prejudices<sup>2</sup> the council was unable to purchase a freehold until 1878, when an acre was obtained at Woking, not far distant from the cemetery. At this time the furnace employed by Professor Gorini of Lodi, Italy, appeared to be the best for working with on a small scale; and he was invited to visit England to superintend its erection. This was completed in 1879, and the body of a horse was cremated rapidly and completely without any smoke or effluvia from the chimney. No sooner was this successful step taken than the president received a communication from the Home Office, which resulted in a personal interview with the home secretary; the issue of which was that if the society desired to avoid direct hostile action, an assurance must be given that no cremation should be attempted without leave first obtained from the minister. This of course was given, no further building took place, and the society's labours were confined to employing means to diffuse information on the subject. Sir Spencer Wells brought it before the annual meeting of the British Medical Association in 1880, when a petition to the home secretary for permission to adopt cremation was largely signed by the leading men in town and country, but without any immediate result. The next important development was an application to the council in 1882, by Captain Hanham in Dorsetshire, to undertake the cremation of two deceased relatives who had left express instructions to that effect. The home secretary was applied to, and refused. The bodies were preserved, and Captain Hanham erected a crematorium on his estate, and the cremation took place there. He himself, dying a year later, was cremated also; in both cases the result was attained under the supervision of Mr J. C. Swinburne-Hanham, who succeeded Mr Eassie in 1888 as honorary secretary to the society. The government took no notice. But in 1883 a cremation was performed in Wales by a man on the body of his child, and legal proceedings were taken against him. Mr Justice Stephen, in February 1884, delivered his well-known judgment at the Assizes there, declaring cremation to be a legal procedure, provided no nuisance were caused thereby to others. The council of the society at once declared themselves absolved from their promise to the Home Office, and publicly offered to perform cremation, laying down strict rules for careful inquiry into the cause of death in every case. They stated that they were fully aware that the chief practical objection to cremation was that it removed traces of poison or violence which might have caused death. Declining to trust the very imperfect statement generally made respecting the cause of death in the ordinary death certificate (unless a coroner's inquest had been held), they adopted a system of very stringent inquiry, the result of which in each case was to be submitted to the president, to be investigated and approved by him before cremation could take place, with the right to decline or require an inquest if he thought proper; and this course has been followed ever since the first cremation.

It was on 26th March 1885 that the first cremation at Woking took place, the subject being a lady.<sup>3</sup> In 1888 it became necessary, nearly 100 bodies having been by this date cremated, to build a large hall for religious service, as well as waiting-rooms, in connexion with the crematorium there. The dukes of Bedford and Westminster headed the appeal for funds, each with £105. The former (the 9th duke of Bedford) especially took great interest in the progress of the society, and offered to furnish further donations to any extent necessary. During the next two years he generously defrayed costs to the amount of £3500, and built a smaller crematorium adjacent for himself and family. The latter building was first used on the 18th of January 1891, a few days after the duke's own death. The number of cremations

<sup>2</sup> For a full account of these, see *Modern Cremation: Its History and Practice to the Present Date*, by Sir H. Thompson, Bart., F.R.C.S., &c. (4th ed., Smith, Elder, Waterloo Place, 1901).

<sup>3</sup> *The Times*, 27th March 1885.

slowly increased year by year, and the total at the end of 1900 was 1824. Many of these were persons of distinction—by rank, or by attainments in art, literature and science, or in public life.

The council next turned their attention to the need for a national system of death certification, to be enforced by law as an essential and much-needed reform in connexion with cremation. On the 6th of January 1893 the duke of Westminster introduced a deputation to the secretary of state for the home department, Mr Asquith, and the president of the Cremation Society opened the case, showing that no less than 7% of the burials in England took place without any certificate, while in some districts it was far greater. In consequence of this the home secretary appointed a select committee of the House of Commons, which was presided over by Sir Walter Foster, of the Local Government Board, to "inquire into the sufficiency of the existing law as to the disposal of the dead . . . and especially for detecting the causes of death due to poison, violence, and criminal neglect." After a prolonged inquiry and careful consideration of the evidence, a full report and conclusions drawn therefrom were unanimously agreed to, and published as a blue-book in the autumn of 1893.<sup>1</sup>

The following conclusions are quoted from this volume:—Page iii. "So far as affording a record of the true cause of death and the detection of it in cases where death may have been due to violence, poison, or where criminal neglect is concerned, the class of certified deaths leaves much to be desired." Page iv. Certification is extremely important as a deterrent of crime, and numerous proofs are given at length in support of the statement. . . . "Contrast this class with that of uncertified deaths, when the result is such as to force upon your Committee the conviction that vastly more deaths occur annually from foul play and criminal neglect than the law recognizes." Page viii. Great uncertainty in resorting to the coroner's court, and want of system in connexion with the practice of it, are affirmed to exist. Page x. It is stated that the opportunity for perpetrating crime is great in the considerable class of uncertified cases. . . . "in short, the existing procedure plays into the hands of the criminal classes." "Your Committee are much impressed with the serious possibilities implied in a system which permits death and burial to take place without the production of satisfactory medical evidence of the cause of death." Page xii. "Your Committee have arrived at the conclusion that the appointment of medical officials, who should investigate all cases of death which are not certified by a medical practitioner in attendance, is a proposal which deserves their support."

In considering cremation, the committee reported as follows:—Page xxii. "Your Committee are of opinion that there is only one question in connexion with this method of disposing of a dead body to which it is necessary for them to refer. That question is the supposed danger to the community arising from the fact that with the destruction of the body the possibility of obtaining evidence of the cause of death by *post-mortem* examination also disappears." The mode of proceeding adopted by the Cremation Society of England having been described, "your Committee are of opinion that with the precautions adopted in connexion with cremation, as carried out by the Cremation Society, there is little probability that cases of crime would escape detection, but inasmuch as these precautions are purely voluntary, your Committee consider that in the interests of public safety such regulations should be enforced by law."

The Cremation Society felt that this report much strengthened the case for legislation amending the law of death certification. In August 1894 the president of the society laid the results of the select committee before the British Medical Association at Bristol, and a unanimous vote was obtained in favour of the suggestions made by it. In November a second deputation waited on Mr Asquith, in which the president of the society begged him to carry out the system recommended. The home secretary replied that the business belonged to the department of the Local Government Board, and that it was already dealing with the question and bringing it to a satisfactory solution. Soon afterwards, however, the government changed, other questions became pressing and further consideration of the subject was postponed.

With reference to the recommendations of the select committee before mentioned, the regulations necessary for registration of death and the disposal of the dead may be outlined as follows:—

<sup>1</sup> *Reports on Death Certification* (1893), Eyre & Spottiswoode, London (373,472).

(1) That no body should be buried, cremated, or otherwise disposed of without a medical certificate of death signed, after personal knowledge and observation, or by information obtained after investigation made by a qualified medical officer appointed for the purpose. (2) A qualified medical man should be appointed as official certifier in every parish, or district of neighbouring parishes, his duty being to inquire into all cases of death and report the cause in writing, together with such other details as may be deemed necessary. This would naturally fall within the duties of the medical officer of health for the district, and registration should be made at his office. (3) If the circumstances of death obviously demand a coroner's inquest, the case should be transferred to his court and the cause determined, with or without autopsy. If there appears to be no ground for holding an inquest, and autopsy be necessary to the furnishing of a certificate, the official certifier should make it, and state the result in his report. (4) No person or company should be henceforth permitted to construct or use an apparatus for cremating human bodies without license from the Local Government Board or other authority. (5) No crematory should be so employed unless the site, construction, and system of management have been approved after survey by an officer appointed by government for the purpose. But the licence to construct or use a crematory should not be withheld if guarantees are given that the conditions required are or will be complied with. All such crematories to be subject at all times to inspection by an officer appointed by the government. (6) The burning of a human body, otherwise than in an officially recognized crematory, should be illegal, and punishable by penalty. (7) No human body should be cremated unless the official examiner added the words "Cremation permitted." This he should be bound to do if, after due inquiry, he can certify that the deceased has died from natural causes, and not from ill-treatment, poison or violence.

The Cremation Act 1902 (2 Ed. VII. ch. 8), and the regulations<sup>2</sup> made thereunder by the home secretary, have since given legislative effect to some of the foregoing recommendations and have laid down a code of laws applicable and binding where cremation is resorted to. But the amendments in the law of death certification generally, so long pressed for by the Cremation Society of England and recommended by the select committee, are none the less necessary.

Undoubtedly in populous communities and in crowded districts the burial of dead bodies is liable to be a source of danger to the living. As early as 1840 a commission had been appointed, including some of the earliest authorities on sanitary science,—namely, Drs Southwood Smith, Chadwick, Milroy, Sutherland, Waller Lewis and others,—to conduct a searching inquiry into the state of the burial-grounds of London and large provincial towns. By the report<sup>3</sup> the existence of such a danger was strikingly demonstrated, and intramural interments were in consequence made illegal. The advocates of burial then declared that interment in certain light soils would safely and efficiently decompose the putrefying elements which begin to be developed the moment death takes place, and which rapidly become dangerous to the living, still more so in the case of deaths from contagious disease. But these light dry soils and elevated spots are precisely those best adapted for human habitation; to say nothing of their value for food-production. Granted the efficiency of such burial, it only effects in the course of a few years what exposure to a high temperature accomplishes with absolute safety in an hour. In a densely populated country the struggle between the claims of the dead and the living to occupy the choicest sites becomes a serious matter. All decaying animal remains give off effluvia—gases—which are transferred through the medium of the atmosphere to become converted into vegetable growth of some kind—trees, crops, garden produce, grass, &c. Every plant absorbs these gases by its leaves, each one of which is provided with hundreds of stomata—open mouths—by which they fix or utilize the carbon to form woody fibre, and give off free oxygen to the atmosphere. Thus it is that the air we breathe is kept pure by the constant interaction between the animal and vegetable kingdoms. It may be taken as certain that the gaseous products arising from a cremated body—amounting, although invisible, to no less than 97% of its weight, 3% only remaining as solids, in the form of a pure white ash—

<sup>2</sup> *Statutory Rules and Orders*, 1903, No. 286, Eyre & Spottiswoode.

<sup>3</sup> *A Special Inquiry into the Practice of Interment in Towns*, by Edwin Chadwick (London, 1843), is replete with evidence, and should be read by those who desire to pursue the inquiry further.

become in the course of a few hours integral and active elements in some form of vegetable life. The result of this reasoning has been that, by slow degrees, crematoria have been constructed at many of the populous cities in Great Britain and abroad (see *Statistics* below).

The subject of employing cremation for the bodies of those who die of contagious disease is a most important one. Sir H. Thompson advocated this course in a paper read before the International Congress of Hygiene held in London in 1891; and a resolution strongly approving the practice was carried unanimously at a large meeting of experts and medical officers of health. Such diseases are small-pox, scarlet fever, diphtheria, consumption, malignant cholera, enteric, relapsing and puerperal fevers, the annual number of deaths from which in the United Kingdom is upwards of 80,000. Complete disinfection takes place by means of the high temperature to which the body is exposed. At the present day it is compulsory to report any case in the foregoing list, whenever it occurs, to the medical officer of health for the district; and it is customary to disinfect the rooms themselves, as well as the clothes and furniture used by the patient if the case be fatal; but the body, which is the source and origin of the evil, and is itself loaded with the germs of a specific poison, is left to the chances which attach to its preservation in that condition, when buried in a fit or unfit soil or situation.

The process of preparing a body for cremation requires a brief notice. The plan generally adopted is to place it (in the usual shroud) in a light pine shell, discarding all heavy oak or other coffin, and to introduce it into the furnace in that manner. Thus there is no handling or exposure of the body after it reaches the crematorium. The type of furnace in general use is on the reverberatory principle, the body being consumed in a separate chamber heated to over 2000° Fahr. by a coke fire. In a few instances a furnace burning ordinary illuminating gas instead of coke is in use. (H. Th.)

*Statistics.*—The following statistics show the history of modern cremation and its progress at home and abroad:—

*Foreign Countries.*—The first experiment in Italy was made by Brunetti in 1869, his second and third in 1870. Gorini and Polli published their first cases in 1872. Brunetti exhibited his at Vienna in 1873. All were performed in the open air. The next in Europe was a single case at Breslau in 1874. Soon after, an English lady was cremated in a closed apparatus (Siemens) at Dresden. The next cremation in a closed receptacle took place at Milan in 1876. In the same year a Cremation Society was formed, a handsome building was erected, and two Gorini furnaces were at work in 1880. In 1899 the total number of cremations was 1355. In Italy 28 crematoria exist, viz. at Alessandria, Asti, Bologna, Bra, Brescia, Como, Cremona, Florence, Genoa, Leghorn, Lodi, Mantua, Milan, Modena, Novara, Padua, Perugia, Pisa, Pistoia, Rome, San Remo, Siena, Spezia, Turin, Udine, Verona and Venice. The total number of cremations in Italy in 1906 was 440.

In Germany the first crematorium was erected at Gotha; it was opened in 1878, and the total cremations down to September 1st, 1907, numbered 4584. At Ohlsdorf, Hamburg, the crematorium was opened in November 1892, and the total cremations down to September 1st, 1907, numbered 2521. At Heidelberg the crematorium was opened in 1891, and the total cremations down to September 1st, 1907, numbered 1741. Throughout the German empire there are, in addition to the above, crematoria at Bremen, Eisenach, Jena, Karlsruhe, Mannheim, Mainz, Offenbach, Heilbronn, Ulm, Chemnitz and Stuttgart, besides over eighty societies for promoting cremation. The total number of cremations which took place in Germany in 1906 was 2057, making a total of 13,614 down to September 1st, 1907.

Other societies exist in Denmark, Holland, Belgium, Sweden, Norway and Switzerland. At the crematorium at Copenhagen 77 bodies were cremated in 1906, the total being 500. The Stockholm crematorium was opened in October 1887, and the cremations in 1906 numbered 56. The Gothenburg crematorium (also in Sweden) was opened in January 1890, and the cremations there in 1906 were 14. Switzerland has four crematoria, viz. at Basel, Geneva, Zurich and St Gallen—524 cremations took place in that country in 1906.

In Paris a cremation society was founded in 1880, and in 1886–1887 a large crematorium was constructed by the municipal council at Père Lachaise, containing three Gorini furnaces. It was first used in October 1887 for two men who died of small-pox. The demand became large; an improved furnace was soon devised, the unclaimed bodies at the hospitals and the remains at the dissecting

rooms being cremated there, besides a large number of embryos. In 1906 the number, including the last-named class, was 6906. The total number of incinerations at Père Lachaise down to December 31st, 1906 (including both classes) was 86,962; but the employment of cremation for the purposes named has deterred a resort to it by many. Had a separate establishment been organized for the public, its success would have been greater. A magnificent edifice has been constructed by the municipality of Paris for the conservation of the ashes of persons who have been cremated. Crematoria have been established also at Rouen, Rheims and Marseilles, and the construction of crematoria in other of the great provincial centres of France was in contemplation.

In Buenos Aires, since 1844, the bodies of all persons dying of contagious disease are cremated, and there is also a separate establishment for the use of the public.

At Tokio in Japan no fewer than 22 crematoria exist, and about an equal number of cremations and burials in earth take place.

At Calcutta a crematorium was opened in 1906.

At Montreal, Canada, there is a crematorium which began operations in 1902, and completed 44 cremations up to the 31st of December 1905.

*United States.*—There were 33 crematoria in the United States on September 1st, 1907. At Fresh Pond, New York, erected in 1885, the total number of cremations to December 31st, 1906, being 8514. At Buffalo, N.Y., the first cremation taking place in 1885, and the total number down to December 31st, 1905, being 787. At Troy (Earl Crematorium), N.Y., the first cremation taking place in 1890, and the total number down to December 31st, 1905, 249. At Swinburne Island, N.Y., cremations beginning in 1890, total to December 31st, 1905, 123. At Waterville, N.Y., cremations beginning in 1893, total to December 31st, 1906, 62. At St Louis, Missouri, cremations beginning in 1888, total to September 1st, 1907, 2151. At Philadelphia, Penn., cremations beginning in 1888, total to September 1st, 1907, 1685. At San Francisco, Cal., "Odd Fellows," opened in 1895, total to December 31st, 1906, 6151. Also at San Francisco, Cal., "Cypress Lawn," opened in 1893, total to December 31st, 1905, 1492. At Los Angeles, Cal., No. 1, Rosedale, opened in 1887, total to December 31st, 1905, 866; No. 2, Evergreen, opened in 1902, total to December 31st, 1905, 413; No. 3, Gower Street, opened in 1907 with 54 down to September 1st. At Boston, Mass., opened in 1893, total to September 1st, 1907, 2493. At Cincinnati, Ohio, opened in 1887, total to September 1st, 1907, 1245. At Chicago, opened in 1893, total to September 1st, 1907, 2188. At Detroit, Michigan, opened in 1887, total to December 31st, 1905, 689. At Pittsburg, Penn., opened in 1886, total to September 1st, 1907, 377. At Baltimore, opened in 1889, total to December 31st, 1905, 263. At Lancaster, Penn., opened in 1884, total to December 31st, 1906, 106. At Davenport, Iowa, opened in 1891, total to September 1st, 1907, 331. At Milwaukee, opened in 1896, total to October 1905, 442. At Washington, opened in 1897, total to December 31st, 1905, 275. The Le Moyne (Washington, Pa.) crematory, the first in the United States, was erected by Dr F. Julius le Moyne in 1876, for private use. The first cremation was that of the baron de Palin, of New York, December 6th, 1876. Dr F. Julius le Moyne died October 1879, and his remains were cremated in his own crematory. Total number of cremations (to 1907) 41. At Pasadena, Cal., opened in 1895, total to September 1st, 1907, 491. At St. Paul, Minn., opened in 1897, total to December 31st, 1905, 145. At Fort Wayne, Ind., opened in 1897, total to September 1st, 1907, 41. At Cambridge, Mass., opened in 1900, total to September 1st, 1907, 1090. At Cleveland, Ohio, opened in 1901, total to December 31st, 1905, 283. At Denver, Col., opened in 1904, total to December 31st, 1905, 109. At Indianapolis, opened in 1904, total to December 31st, 1905, 32. At Oakland, Cal., opened in 1902, total to September 1st, 1907, 2196. At Portland, Ore., opened in 1901, total to December 31st, 1905, 327. At Seattle, Washington, opened in 1905, with 21 to the end of that year.

*United Kingdom.*—There were 13 crematoria in operation in the United Kingdom on September 1st, 1907. The oldest is that at Woking, Surrey, which was first used for the cremation of human remains in 1885. In that year three cremations took place there, the number gradually increasing each year until in 1901 301 bodies were cremated. Up to September 1st, 1907, the total number of cremations at Woking was 2939. Then followed the crematorium at Manchester, opened in 1892 with 90 in 1906 and a total of 1085; at Glasgow, opened in 1895 with 45 in 1906 and a total of 252; at Liverpool, opened in 1896, with 46 in 1906 and a total of 374; at Hull, opened in 1901 (the first municipal crematorium), with 17 in 1906 and a total of 116; at Darlington, also opened in 1901, with 13 in 1906 and a total of 33. The Leicester Corporation crematorium was opened in 1902, with 12 in 1906 and a total of 50. Next in order came the Golder's Green crematorium, Hampstead, London, which was opened in December 1902. In 1906 298 cremations took place there, making a total of 1091. After this followed the Birmingham crematorium, opened in 1903, with 21 in 1906 and a total of 84; the City of London crematorium at Little Ilford, opened in 1905, with 23 for 1906 and a total of 46; the Leeds crematorium, opened in 1905, with 15 in 1906 and a total of 42; the Bradford Corporation crematorium, opened in 1905, with 13 in 1906, and a total of 20; and the Sheffield Corporation crematorium, opened in 1905, with

6 in 1906 and a total of 26. Thus there were 739 cremations in the United Kingdom in 1906, making a total at the above crematoria down to September 1st, 1907, of 6158. The Golder's Green crematorium, situated on the northern boundary of Hampstead Heath, stands in its own grounds of 12 acres, and is but 35 minutes' drive from Oxford Circus. London thus has two crematoria within driving distance of its centre, and the Woking crematorium within easy reach of the south-west suburbs. (J. C. S.-H.)

**CREMER, JAKOBUS JAN** (1837-1880), Dutch novelist, born at Arnhem in September 1837, started life as a painter, but soon exchanged the brush for the pen. The great success of his first novelettes (*Betuwsche Novellen* and *Overbetuwsche Novellen*), published about 1855—reprinted many times since, and translated into German and French—showed Cremer the wisdom of his new departure. These short stories of Dutch provincial life are written in the quaint dialect of the Betuwe, the large flat Gelderland island, formed by the Rhine, the name recalling the presumed earliest inhabitants, the Batavi. Cremer is strongest in his delineation of character. His picturesque humour, coming out, perhaps, most forcibly in his numerous readings of the Betuwe novelettes, soon procured him the name of the "Dutch Fritz Reuter." In his later novels Cremer abandons both the language and the slight love-stories of the Betuwe, depicting the Dutch life of other centres in the national tongue. The principal are: *Anna Rooze* (1867), *Dokter Helmond en zijn Vrouw* (1870), *Hanna de Freule* (1873), *Daniel Sils*, &c. Cremer was less successful as a playwright, and his two comedies, *Peasant and Nobleman* and *Emma Bertholt*, did not enhance his fame; nor did a volume of poems, published in 1873. He died at the Hague in June 1880. His collected novels have appeared at Leiden. An English novel, founded by Albert Vandam upon *Anna Rooze*, considered by many his best work, was published in London (1877, 3 vols.) under the title of *An Everyday Heroine*.

**CREMERA** (mod. *Fosso della Valchetta*), a small stream in Etruria which falls into the Tiber about 6 m. N. of Rome. The identification with the Fosso della Valchetta is fixed as correct by the account in Livy ii. 49, which shows that the Saxa Rubra were not far off, and this we know to be the Roman name of the post station of Prima Porta, about 7 m. from Rome on the Via Flaminia. It is famous for the defeat of the three hundred Fabii, who had established a fortified post on its banks.

**CRÉMIEUX, ISAAC MOÏSE** [known as ADOLPHE] (1796-1880), French statesman, was born at Nîmes, of a rich Jewish family. He began life as an advocate in his native town. After the revolution of 1830 he came to Paris, formed connexions with numerous political personages, even with King Louis Philippe, and became a brilliant defender of Liberal ideas in the law courts and in the press,—witness his *Éloge funèbre* of the bishop Grégoire (1830), his *Mémoire* for the political rehabilitation of Marshal Ney (1833), and his plea for the accused of April (1835). Elected deputy in 1842, he was one of the leaders in the campaign against the Guizot ministry, and his eloquence contributed greatly to the success of his party. On the 24th of February 1848 he was chosen by the Republicans as a member of the provisional government, and as minister of justice he secured the decrees abolishing the death penalty for political offences, and making the office of judge immovable. When the conflict between the Republicans and Socialists broke out he resigned office, but continued to sit in the constituent assembly. At first he supported Louis Napoleon, but when he discovered the prince's imperial ambitions he broke with him. Arrested and imprisoned on the 2nd of December 1851, he remained in private life until November 1869, when he was elected as a Republican deputy by Paris. On the 4th of September 1870 he was again chosen member of the government of national defence, and resumed the ministry of justice. He then formed part of the Delegation of Tours, but took no part in the completion of the organization of defence. He resigned with his colleagues on the 14th of February 1871. Eight months later he was elected deputy, then life senator in 1875. He died on the 10th of February 1880. Crémieux did much to better the condition of the Jews. He was president of the Universal Israelite Alliance, and while in the government of the national defence he secured the franchise for the Jews in

Algeria. This famous *Décret Crémieux* was the origin of the anti-Semitic movement in Algiers. Crémieux published a *Recueil* of his political cases (1869), and the *Actes de la délégation de Tours et de Bordeaux* (2 vols., 1871).

**CREMONA, LUIGI** (1830-1903), Italian mathematician, was born at Pavia on the 7th of December 1830. In 1848, when Milan and Venice rose against Austria, Cremona, then only a lad of seventeen, joined the ranks of the Italian volunteers, and remained with them, fighting on behalf of his country's freedom, till, in 1849, the capitulation of Venice put an end to the hopeless campaign. He then returned to Pavia, where he pursued his studies at the university under Francesco Brioschi, and determined to seek a career as teacher of mathematics. His first appointment was as elementary mathematical master at the gymnasium and lyceum of Cremona, and he afterwards obtained a similar post at Milan. In 1860 he was appointed to the professorship of higher geometry at the university of Bologna, and in 1866 to that of higher geometry and graphical statics at the higher technical college of Milan. In this same year he competed for the Steiner prize of the Berlin Academy, with a treatise entitled "Memoria sulle superficie de terzo ordine," and shared the award with J. C. F. Sturm. Two years later the same prize was conferred on him without competition. In 1873 he was called to Rome to organize the college of engineering, and was also appointed professor of higher mathematics at the university. Cremona's reputation had now become European, and in 1879 he was elected a corresponding member of the Royal Society. In the same year he was made a senator of the kingdom of Italy. He died on the 10th of June 1903.

As early as 1856 Cremona had begun to contribute to the *Annali di scienze matematiche e fisiche*, and to the *Annali di matematica*, of which he became afterwards joint editor. Papers by him have appeared in the mathematical journals of Italy, France, Germany and England, and he has published several important works, many of which have been translated into other languages. His manual on *Graphical Statics* and his *Elements of Projective Geometry* (translated by C. Leudesdorf), have been published in English by the Clarendon Press. His life was devoted to the study of higher geometry and reforming the more advanced mathematical teaching of Italy. His reputation mainly rests on his *Introduzione ad una teoria geometrica delle curve piane*, which proclaims him as a follower of the Steinerian or synthetical school of geometers. He notably enriched our knowledge of curves and surfaces.

**CREMONA**, a city and episcopal see of Lombardy, Italy, the capital of the province of Cremona, situated on the N. bank of the Po, 155 ft. above sea-level, 60 m. by rail S.E. of Milan. Pop. (1901) town, 31,655; commune, 39,344. It is oval in shape, and retains its mediæval fortifications. The line of the streets is as a rule irregular, but the town as a whole is not very picturesque.

The finest building is the cathedral, in the Lombard Romanesque style, begun in 1107 and consecrated in 1190. The wheel window of the main façade dates from 1274. The transepts, added in the 13th and 14th centuries (before 1370), have picturesque brick façades, with fine terra-cotta ornamentation. The great Torrazzo, a tower 397 ft. high, which stands by the cathedral, and is connected with it by a series of galleries, dates from 1267-1291. It is square below, with an octagonal summit of a slightly later period. The main façade of the cathedral was largely altered in 1491, to which date the statues upon it belong; the portico in front was added in 1497. The building would be much improved by isolation, which it is hoped may be effected. The interior is fine, and is covered with frescoes by Cremonese masters of the 16th century (Boccaccio Boccaccino, Romanino, Pordenone, the Campi, &c.), which are not of first-rate importance. The choir has fine stalls of 1489-1490, upon one of which there is a view of the façade of the cathedral before its alteration in 1491. The treasury contains a richly worked silver crucifix 9 ft. high, of 1478, the base of which was added in 1774-1775. It contains 408 statues and busts altogether, the central three of which belong to an earlier cross of 1231. Adjacent to the



cathedral is the octagonal baptistery of 1167, 92 ft. in height and 75 ft. in external diameter, also in the Lombard Romanesque style. The so-called Campo Santo, close to the baptistery, contains a mosaic pavement with emblematic figures belonging probably to the 8th and 9th centuries, and running under the cathedral. Of the other churches, S. Michele has a simple and good Lombard Romanesque 13th-century façade, and a plain interior of the 10th century; and S. Agata a good campanile in the former style. Many of them contain paintings by the later Cremonese masters, especially Galeazzo Campi (d. 1536) and his sons Giulio and Antonio. The latter are especially well represented in S. Sigismondo, 1½ m. outside the town to the E. On the side of the Piazza del Comune opposite to the cathedral are two 13th-century Gothic palaces in brick, the Palazzo Comunale and the former Palazzo dei Giureconsulti, now the seat of the commissioners for the water regulation of the district. Another palace of the same period is now occupied by the Archivio Notarile. The modern Palazzo Ponzoni contains a museum and a technical institute. In front of it is a statue of the composer Amilcare Ponchielli, who was a native of Cremona. The Palazzo Fodri, now the Monte di Pietà, has a beautiful 15th-century frieze of terra-cotta bas-reliefs, as have some other palaces in private hands.

Cremona was founded by the Romans in 218 B.C. (the same year as Placentia) as an outpost against the Gallic tribes. It was strengthened in 190 B.C. by the sending of 6000 new settlers and soon became one of the most flourishing towns of upper Italy. It probably acquired municipal rights in 90 B.C., but Augustus, owing to the fact that it did not support him, assigned a part of its territory to his veterans in 41 B.C., and henceforth it is once more called *colonia*. It remained prosperous (we may note that Virgil came here to school from Mantua) until it was taken and destroyed by the troops of Vespasian after the second battle of Betriacum (Bedriacum) in A.D. 69; the temple of Mefitis alone being left standing (see Tacitus, *Hist.* iii. 15 seq.). One of the bronze plates which decorated the exterior of the war-chest of the *legio III. Macedonica*, one of the legions which had been defeated at Betriacum, has been found near Cremona itself (F. Barnabei in *Notiz. scavi*, 1887, p. 210). Vespasian ordered its immediate reconstruction, but it never recovered its former prosperity, though its position on the N. bank of the Po, at the meeting-point of roads from Placentia, Mantua (the Via Postumia in both cases), Brixellum (where the roads from Cremona and Mantua to Parma met and crossed the river), Laus Pompeia and Brixia, still gave it considerable importance. It was destroyed once more by the Lombards under Agilulf in A.D. 605, and rebuilt in 615, and was ruled by dukes; but in the 9th century the bishops of Cremona began to acquire considerable temporal power. Landulf, a German to whom the see was granted by Henry II., was driven out in 1022, and his palace destroyed, but other Germans were invested with the see afterwards. The commune of Cremona is first mentioned in a document of 1098, recording its investiture by the countess Matilda with the territory known as Isola Fulcheria. It had to sustain many wars with its neighbours in order to maintain itself in its new possessions. In the war of the Lombard League against Barbarossa, Cremona, after having shared in the destruction of Crema in 1160 and Milan in 1162, finally joined the league, but took no part in the battle of Legnano, and thus procured itself the odium of both sides. In the Guelph and Ghibelline struggles Cremona took the latter side, and defeated Parma decisively in 1250. It was during this period that Cremona erected its finest buildings. There was, however, a Guelph reaction in 1264; the city was taken and sacked by Henry VII. in 1311, and was a prey to struggles between the two parties, until Galeazzo Visconti took possession of it in 1322. In 1406 it fell under the sway of Cabrino Fondulo, who received with great festivities both the emperor Sigismund and Pope John XXIII., the latter on his way to the council at Constance; he, however, handed it over to Filippo Maria Visconti in 1419. In 1499 it was occupied by Venetians, but in 1512 it came under Massimiliano Sforza. In 1535, like the rest of Lombardy, it fell under Spanish domina-

tion, and was compelled to furnish large money contributions. The population fell to 10,000 in 1668. The surprise of the French garrison on the 2nd of February 1702, by the Imperialists under Prince Eugene, was a celebrated incident of the War of the Spanish Succession. The Imperialists were driven from Cremona after a sharp struggle, but captured Marshal Villeroi, the French commander. Hence the celebrated verse:

" Français, rendons grâce à Bellone;  
Notre bonheur est sans égal;  
Nous avons conservé Cremonée,  
Et perdu notre général."

In the 18th century the prosperity of Cremona revived. In the Italian republic it was the capital of the department of the upper Po. Like the rest of Lombardy it fell under Austria in 1814, and became Italian in 1859.

See *Guida di Cremona* (Cremona, 1904).

(T. As.)

**CREMORNE GARDENS**, formerly a popular resort by the side of the Thames in Chelsea, London, England. Originally the property of the earl of Huntingdon (c. 1750), father of Steele's "Aspasia," who built a mansion here, the property passed through various hands into those of Thomas Dawson, Baron Dartrey and Viscount Cremorne (1725-1813), who greatly beautified it. It was subsequently sold and converted into a proprietary place of entertainment, being popular as such from 1845 to 1877. It never, however, acquired the fashionable fame of Vauxhall, and finally became so great an annoyance to residents in the neighbourhood that a renewal of its licence was refused; and the site of the gardens was soon built over. The name survives in Cremorne Road.

**CRENELLE** (an O. Fr. word for "notch," mod. *crêneau*; the origin is obscure; cf. "cranny"), a term generally considered to mean an embrasure of a battlement, but really applying to the whole system of defence by battlements. In medieval times no one could "crenellate" a building without special licence from his supreme lord.

**CREODONTA**, a group of primitive early Tertiary Carnivora, characterized by their small brains, the non-union in most cases of the scaphoid and lunar bones of the carpus, and the general absence of a distinct pair of "sectorial" teeth (see **CARNIVORA**). In many respects the Lower Eocene creodonts come very close to the primitive ungulates, or Condylarthra (see **PHENACODUS**), from which, however, they are distinguished by the approximation in the form of the skull to the carnivorous type, the more trenchant teeth (at least in most cases) and the more claw-like character of the terminal joints of the toes. The general character of the dentition in the more typical forms, such as *Hyaenodon* (see fig.), recalls that of the carnivorous marsupials, this being especially the case with the Patagonian species, which have been

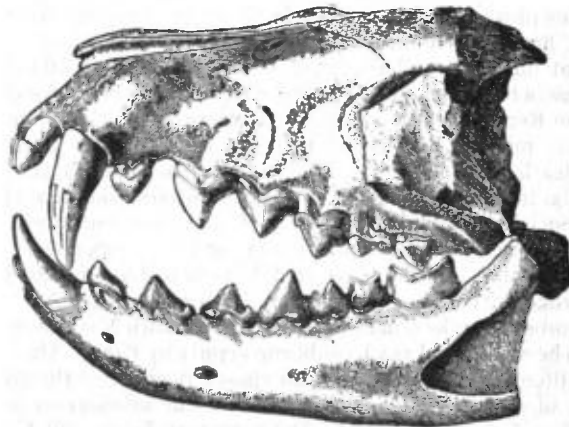

Dentition of *Hyaenodon leptorhynchus*, from the Lower Oligocene of France. The last upper molar is concealed by the penultimate tooth.

separated as a distinct group under the name of Sparassodonta (*q.v.*). The skull, however, is not of the marsupial type, and in the European forms at any rate there is a complete replacement of the milk-molars by pre-molars, while the minute structure of

the enamel of the teeth is of the carnivorous as distinct from the marsupial type. The head is large in proportion to the body, the lumbar region is unusually rigid, owing to the complexity of the articulations, and the tail and hind-limbs are relatively long and powerful. In life the tail probably passed almost imperceptibly into the body, as in the Tasmanian thylacine.

That the Creodonta are the ancestors of the modern Carnivora is now generally admitted. They are apparently the most generalized and primitive of all (placental?) mammals, and probably the direct descendants of the mammal-like anomodont or theromorphous reptiles of the Triassic epoch; the evolution from that group having perhaps taken place in Africa or in the lost area connecting that continent with India. The relationship of the creodonts to the carnivorous marsupials is not yet determined, but it seems scarcely probable that the remarkable resemblance existing between the teeth of the two groups can be solely due to parallelism; and it has been suggested by Dr L. Wortman that both creodonts and marsupials are descended from a common non-placental stock. In other words, the latter are a side-branch from the anomodont-creodont line of descent. Dr C. W. Andrews has pointed out that certain of the Egyptian creodonts appear to have been aquatic or subaquatic in their habits; and it is possible that from such types are derived the true seals, or *Phocidae*.

With the exception of Australasia, and perhaps South Africa, creodonts (on the supposition that the Patagonian forms are rightly included) appear to have had a nearly world-wide distribution. In Europe and North America they date from the Lowest Eocene and lived till the early Oligocene, while in India they apparently survived till a much later epoch. Some of the Oligocene forms, alike as regards dentition, the union of the scaphoid and lunar of the carpus, and the complexity of the brain, approximated to modern Carnivora.

As regards classification Mr W. D. Matthew includes in the typical family *Hyaenodontidae* not only the widely spread genera *Hyaenodon* and *Pterodon*, but likewise *Sinopa* (*Stypolophus*), *Cynohyaenodon* and *Proviverra*; but *Viverravus* (*Didymictis*) and *Vulpavus* (*Miacis*) are assigned to a separate family (*Viverravidae*). It is these latter forms which come nearest to modern Carnivora, most of them being of Oligocene age. The American and European *Oxyaena* apparently represents a family by itself, as does the American *Oxyclaena*; and *Palaeonictis* and *Patriofelis* are assigned to yet another family; while the North American Lower Eocene and Eocene *Arctocyon* typifies a family characterized by the somewhat bear-like type of dentition. *Mesonyx* is also a very distinct type, from the North American Eocene and Oligocene. Some of the species of *Patriofelis* and *Hyaenodon* attained the size of a tiger, although with long civet-like skulls. In the earlier forms the claws often retained somewhat of a hoof-like character.

The South American *Borhyaenidae* include *Borhyaena*, *Prothylacinus*, *Amphiproviverra*, and allied forms from the Santa Cruz beds of Patagonia, and have been referred to a distinct group, the Sparassodonta, mainly on account of the alleged replacement of some only of the milk-molars by premolars. By their first describer, Dr F. Ameghino, they were regarded as nearly related to the marsupials, to which group they were definitely referred in 1905 by Mr W. J. Sinclair, by whom they are considered near akin to *Thylacinus*, but this view seems to be disproved by the investigations of Mr C. S. Tomes into the structure of the dental enamel.

It should be added that Dr J. L. Wortman transfers *Viverravus* and its allies, together with *Palaeonictis*, to the true Carnivora, the latter genus being regarded as the ancestral type of the sabre-toothed cats (see MACHAERODUS).

AUTHORITIES.—J. L. Wortman, "Eocene Mammalia in the Peabody Museum, pt. i. Carnivora," *Amer. J. Sci.* vols. xi-xiv. (1901-1902); W. D. Matthew, "Additional Observations on the Creodonta," *Bull. Amer. Mus.* vol. xiv. p. i. (1901); C. W. Andrews, *Descriptive Catalogue of the Tertiary Vertebrata of the Fayum*, British Museum (1906); W. J. Sinclair, "The Marsupial Fauna of the Santa Cruz Beds," *Proc. Amer. Phil. Soc.* vol. xlix. p. 73 (1905). (R. L. \*)

**CREOLE** (the Fr. form of *criollo*, a West Indian, probably a negro corruption of the Span. *criadillo*, the dim. of *criado*, one bred or reared, from *criar*, to breed, a derivative of the Lat. *creare*, to create), a word used originally (16th century) to denote persons born in the West Indies of Spanish parents, as distinguished from immigrants direct from Spain, aboriginals, negroes or mulattos. It is now used of the descendants of non-aboriginal races born and settled in the West Indies, in various parts of the American mainland and in Mauritius, Reunion and some other places colonized by Spain, Portugal, France, or (in the case of the West Indies) by England. In a similar sense the name is used of animals and plants. The use of the word by some writers as necessarily implying a person of mixed blood is totally erroneous; in itself "creole" has no distinction of colour; a creole may be a person of European, negro, or mixed extraction—or even a horse.

Local variations occur in the use of the word as applied to people. In the West Indies it designates the descendants of any European race; in the United States the French-speaking native portion of the white race in Louisiana, whether of French or Spanish origin. The French Canadians are never termed creoles, nor is the word now used of the South Americans of Spanish or Portuguese descent, but in Mexico whites of pure Spanish extraction are still called creoles. In all the countries named, when a non-white creole is indicated the word negro is added. In Mauritius, Reunion, &c., on the other hand, creole is commonly used to designate the black population, but is also occasionally used of the inhabitants of European descent. The difference in type between the white creoles and the European races from whom they have sprung, a difference often considerable, is due principally to changed environment—especially to the tropical or semi-tropical climate of the lands they inhabit. The many patois founded on French and Spanish, and used chiefly by creole negroes, are spoken of as creole languages, a term extended by some writers to include similar dialects spoken in countries where the word creole is rarely used.

See G. W. Cable, *The Creoles of Louisiana* (1884); A. Coelho, "Os Dialetos românicos on neo latinos na Africa, Asia e America," *Bol. Soc. Geo. Lisboa* (1884-1886), with bibliography. For the Creole French of Haiti see an article by Sir H. H. Johnston in *The Times*, April 10th, 1909.

**CREON**, in Greek legend, son of Lycaethus, king of Corinth and father of Glauce or Creusa, the second wife of Jason.

**CREON**, in Greek legend, son of Menoeceus, king of Thebes after the death of Laius, the husband of his sister Jocasta. Thebes was then suffering from the visitation of the Sphinx, and Creon offered his crown and the hand of the widowed queen to whoever should solve the fatal riddle. Oedipus, the son of Laius, ignorant of his parentage, successfully accomplished the task and married Jocasta, his mother. By her he had two sons, Eteocles and Polyneices, who agreed after their father's death to reign in alternative years. Eteocles first ascended the throne, being the elder, but at the end of the year refused to resign, whereupon his brother attacked him at the head of an army of Argives. The war was to be decided by a single combat between the brothers, but both fell. Creon, who had resumed the government during the minority of Leodamas, the son of Eteocles, commanded that the Argives, and above all Polyneices, the cause of all the bloodshed, should not receive the rites of sepulture, and that any one who infringed this decree should be buried alive. Antigone, the sister of Polyneices, refused to obey, and sprinkled dust upon her brother's corpse. The threatened penalty was inflicted; but Creon's crime did not escape unpunished. His son, Haemon, the lover of Antigone, killed himself on her grave; and he himself was slain by Theseus. According to another account he was put to death by Lycus, the son or descendant of a former ruler of Thebes (Euripides, *Herc. Fur.* 31; Apollodorus iii. 5, 7; Pausanias ix. 5).

**CREOPHYLUS** of Samos, one of the earliest Greek epic poets. According to an epigram of Callimachus (quoted in Strabo xiv. p. 638) he was the author of a poem called *Οὐχάλιας ἀλώεως*, which told the story of the conquest of Oechalia by Heracles. Creophylus was said to have been a friend or relative

of Homer, who, according to another tradition, was himself the author of the *ἄλωσις*, and presented it to Creophylus in return for the latter's hospitality.

See F. G. Welcker, *Der epische Cyclus* (1865-1882).

**CREOSOTE**, CREASOTE or KREASOTE (from Gr. *κρέας*, flesh, and *σώζω*, to preserve), a product of the distillation of coal, bone oil, shale oil, and wood-tar (more especially that made from beech-wood). The creosote is extracted from the distillate by means of alkali, separated from the filtered alkaline solution by sulphuric acid, and then distilled with dilute alkali; the distillate is again treated with alkali and acid, till its purification is effected; it is then redistilled at 200° C., and dried by means of calcium chloride. It is a highly refractive, colourless, oily liquid, and was first obtained in 1832 by K. Reichenbach from beech-wood tar. It consists mainly of a mixture of phenol, cresol, guaiacol, creosol, xylenol, dimethyl guaiacol, ethyl guaiacol, and various methyl ethers of pyrogallol. Creosote has a strong odour and hot taste, and burns with a smoky flame. It dissolves sulphur, phosphorus, resins, and many acids and colouring matters; and is soluble in alcohol, ether, and carbon disulphide, and in 80 parts by volume of water. It is distinguished from carbolic acid by the following properties:—it rotates the plane of polarized light to the right, forms with collodion a transparent fluid, and is nearly insoluble in glycerin; whereas carbolic acid has no effect on polarized light, gives with about two-thirds of its volume of collodion a gelatinous mass, and is soluble in all proportions in glycerin; further, alcohol and ferric chloride produce with creosote a green solution, turned brown by water, with carbolic acid a brown, and on the addition of water a blue solution. Creosote, like carbolic acid, is a powerful antiseptic, and readily coagulates albuminous matter; wood-smoke and pyroligneous acid or wood-vinegar owe to its presence their efficacy in preserving animal and vegetable substances from putrefaction.

*Creosote oil* is the name generally applied to the fraction of the coal tar distillate which boils between 200° and 300° C. (see COAL TAR). It is a greenish-yellow fluorescent liquid, usually containing phenol, cresol, naphthalene, anthracene, pyridine, quinoline, acridine and other substances. Its chief use is for the preservation of timber.

*Pharmacology and Therapeutics.*—Creosote derived from wood-tar is given medicinally in doses of from one to five minims, either suspended in mucilage, or in capsules. It should always be administered after a meal, when the gastric contents dilute it and prevent irritation. Creosote and carbolic acid (*q.v.*) have a very similar pharmacology; but there is one conspicuous exception. Beech-wood creosote alone should be used in medicine, as its composition renders it much more valuable than other creosotes. Its constituents circulate unchanged in the blood and are excreted by the lungs. Although carbolic acid has no value in phthisis (pulmonary tuberculosis) or in any other bacterial condition of the lungs, creosote, having volatile constituents which are excreted in the expired air and which are powerfully antiseptic, may well be of much value in these conditions. In phthisis creosote is now superseded by both its carbonate (creosotal)—given in the same doses—which causes less gastric disturbance, and by guaiacol itself, which may be given in doses up to thirty minims in capsules. The phosphate (phosote or phosphote), phosphite (phosphotal), and valerianate (eosote) also find application. Similarly the carbonate of guaiacol may be given in doses even as large as a drachm. Creosote may also be used as an inhalation with a steam atomizer. It is applicable not only in phthisis but in bronchiectasis, bronchitis, broncho-pneumonia, lobar pneumonia and all other bacterial lung diseases. Like carbolic acid, creosote may be used in toothache, and the local antiseptic and anaesthetic action which it shares with that substance is often of value in relieving gastric pain due to simple ulcer or cancer, and in those forms of vomiting which are due to gastric irritation.

For the determination and separation of the various constituents of creosote see F. Tiemann, *Ber.* (1881), 14, p. 2005; A. Béhal and C. Choay, *Comptes rendus* (1893), 116, p. 197; and L. F. Kebler, *Amer. Jour. Pharm.* (1899), p. 409.

**CREPUSCULAR** (from Lat. *crepusculum*, twilight), of or belonging to the twilight, hence indistinct or glimmering; in zoology the word is used of animals that appear before sunrise or nightfall.

**CRÉQUY**, a French family which originated in Picardy, and took its name from a small lordship in the present Pas-de-Calais. Its genealogy goes back to the 10th century, and from it originated the noble houses of Blécourt, Canaples, Heilly and Royon. Henri de Créquy was killed at the siege of Damietta in 1240; Jacques de Créquy, marshal of Guienne, was killed at Agincourt with his brothers Jean and Raoul; Jean de Créquy, lord of Canaples, was in the Burgundian service, and took part in the defence of Paris against Joan of Arc in 1429, received the order of the Golden Fleece in 1431, and was ambassador to Aragon and France; Antoine de Créquy was one of the boldest captains of Francis I., and died in consequence of an accident at the siege of Hesdin in 1523. Jean VIII., sire de Créquy, prince de Poix, seigneur de Canaples (d. 1555), left three sons, the eldest of whom, Antoine de Créquy (1535-1574), inherited the family estates on the death of his brothers at St Quentin in 1557. He was raised to the cardinalate, and his nephew and heir, Antoine de Blanchefort, assumed the name and arms of Créquy.

Charles I. de Blanchefort, marquis de Créquy, prince de Poix, duc de Lesdiguières (1578-1638), marshal of France, son of the last-named, saw his first fighting before Laon in 1594, and was wounded at the capture of Saint Jean d'Angély in 1621. In the next year he became a marshal of France. He served through the Piedmontese campaign in aid of Savoy in 1624 as second in command to the constable, François de Bonne, duc de Lesdiguières, whose daughter Madeleine he had married in 1595. He inherited in 1626 the estates and title of his father-in-law, who had induced him, after the death of his first wife, to marry her half-sister Françoise. He was also lieutenant-general of Dauphiné. In 1633 he was ambassador to Rome, and in 1636 to Venice. He fought in the Italian campaigns of 1630, 1635, 1636 and 1637, when he helped to defeat the Spaniards at Monte Baldo. He was killed on the 17th of March 1638 in an attempt to raise the siege of Crema, a fortress in the Milanese. He had a quarrel extending over years with Philip, the bastard of Savoy, which ended in a duel fatal to Philip in 1599; and in 1620 he defended Saint-Aignan, who was his prisoner of war, against a prosecution threatened by Louis XIII. Some of his letters are preserved in the Bibliothèque Nationale in Paris, and his life was written by N. Chorier (Grenoble, 1683).

His eldest son, François, comte de Sault, duc de Lesdiguières (1600-1677), governor and lieutenant-general of Dauphiné, took the name and arms of Bonne. The younger, Charles II. de Créquy, seigneur de Canaples, was killed at the siege of Chambéry in 1630, leaving three sons—Charles III., sieur de Blanchefort, prince de Poix, duc de Créquy (1623?-1687); Alphonse de Créquy, comte de Canaples (d. 1711), who became on the extinction of the elder branch of the family in 1702 duc de Lesdiguières, and eventually succeeded also to his younger brother's honours; and François, chevalier de Créquy and marquis de Marines, marshal of France (1625-1687).

The last-named was born in 1625, and as a boy took part in the Thirty Years' War, distinguishing himself so greatly that at the age of twenty-six he was made a *maréchal de camp*, and a lieutenant-general before he was thirty. He was regarded as the most brilliant of the younger officers, and won the favour of Louis XIV. by his fidelity to the court during the second Fronde. In 1667 he served on the Rhine, and in 1668 he commanded the covering army during Louis XIV.'s siege of Lille, after the surrender of which the king rewarded him with the marshalate. In 1670 he overran the duchy of Lorraine. Shortly after this Turenne, his old commander, was made marshal-general, and all the marshals were placed under his orders. Many resented this, and Créquy, in particular, whose career of uninterrupted success had made him over-confident, went into exile rather than serve under Turenne. After the death of Turenne and the retirement of Condé, he became the most important general officer in the army, but his over-confidence was punished

by the severe defeat of Conzer Brück (1675) and the surrender of Trier and his own captivity which followed. But in the later campaigns of this war (see DUTCH WARS) he showed himself again a cool, daring and successful commander, and, carrying on the tradition of Turenne and Condé, he was in his turn the pattern of the younger generals of the stamp of Luxembourg and Villars. He died in Paris on the 3rd of February 1687.

Alphonse de Créquy had not the talent of his brothers, and lost his various appointments in France. He went to London in 1672, where he became closely allied with Saint Évremond, and was one of the intimates of King Charles II.

Charles III. de Créquy served in the campaigns of 1642 and 1645 in the Thirty Years' War, and in Catalonia in 1649. In 1646, after the siege of Orbitello, he was made lieutenant-general by Louis. By faithful service during the king's minority he had won the gratitude of Anne of Austria and of Mazarin, and in 1652 he became duc de Créquy and a peer of France. The latter half of his life was spent at court, where he held the office of first gentleman of the royal chamber, which had been bought for him by his grandfather. In 1659 he was sent to Spain with gifts for the infanta Maria Theresa, and on a similar errand to Bavaria in 1680 before the marriage of the dauphin. He was ambassador to Rome from 1662 to 1665, and to England in 1677; and became governor of Paris in 1675. He died in Paris on the 13th of February 1687. His only daughter, Madeleine, married Charles de la Trémoille (1655-1709).

The marshal François de Créquy had two sons, whose brilliant military abilities bade fair to rival his own. The elder, François Joseph, marquis de Créquy (1662-1702), already held the grade of lieutenant-general when he was killed at Luzzara on the 13th of August 1702; and Nicolas Charles, sire de Créquy, was killed before Tournai in 1696 at the age of twenty-seven.

A younger branch of the Créquy family, that of Hémont, was represented by Louis Marie, marquis de Créquy (1705-1741), author of the *Principes philosophiques des saints solitaires d'Égypte* (1779), and husband of the marquise separately noticed below, and became extinct with the death in 1801 of his son, Charles Marie, who had some military reputation.

For a detailed genealogy of the family and its alliances see Moreri, *Dictionnaire historique; Annuaire de la noblesse française* (1856 and 1867). There is much information about the Créquys in the *Mémoires* of Saint-Simon.

**CRÉQUY, RENÉE CAROLINE DE FROULLAY, MARQUISE DE** (1714-1803), was born on the 19th of October 1714, at the château of Monfieux (Mayenne), the daughter of Lieutenant-General Charles François de Froullay. She was educated by her maternal grandmother, and married in 1737 Louis Marie, marquis de Créquy (see above), who died four years after the marriage. Madame de Créquy devoted herself to the care of her only son, who rewarded her with an ingratitude which was the chief sorrow of her life. In 1755 she began to receive in Paris, among her intimates being D'Alembert and J. J. Rousseau. She had none of the frivolity generally associated with the women of her time and class, and presently became extremely religious with inclinations to Jansenism. D'Alembert's visits ceased when she adopted religion, and she was nearly seventy when she formed the great friendship of her life with Sénac de Meilhan, whom she met in 1781, and with whom she carried on a correspondence (edited by Édouard Fournier, with a preface by Sainte-Beuve in 1856). She commented on and criticized Meilhan's works and helped his reputation. She was arrested in 1793 and imprisoned in the convent of Les Oiseaux until the fall of Robespierre (July 1794). The well-known *Souvenirs de la marquise de Créquy* (1710-1803), printed in 7 volumes, 1834-1835, and purporting to be addressed to her grandson, Tancrède de Créquy, was the production of a Breton adventurer, Cousin de Courchamps. The first two volumes appeared in English in 1834 and were severely criticized in the *Quarterly Review*.

See the notice prefixed by Sainte-Beuve to the *Lettres*; P. L. Jacob, *Énigmes et découvertes bibliographiques* (Paris, 1866); Quérard, *Supercheries littéraires*, s.v. "Créquy"; *L'Ombre de la marquise de Créquy aux lecteurs des souvenirs* (1836) exposes the forgery of the *Mémoires*.

**CRESCAS, HASDAI BEN ABRAHAM** (1340-1410), Spanish philosopher. His work, *The Light of the Lord* ('Or Adonai), deeply affected Spinoza, and thus his philosophy became of wide importance. Maimonides (q.v.) had brought Jewish thought entirely under the domination of Aristotle. The work of Crescas, though it had no immediate success, ended in effecting its liberation. He refused to base Judaism on speculative philosophy alone; there was a deep emotional side to his thought. Thus he based Judaism on love, not on knowledge; love was the bond between God and man, and man's fundamental duty was love as expressed in obedience to God's will. Spinoza derived from Crescas his distinction between attributes and properties; he shared Crescas's views on creation and free will, and in the whole trend of his thought the influence of Crescas is strongly marked. See E. G. Hirsch, *Jewish Encyclopaedia*, iv. 350. (I. A.)

**CRESCENT** (Lat. *crescens*, growing), originally the waxing moon, hence a name applied to the shape of the moon in its first quarter. The crescent is employed as a charge in heraldry, with its horns vertical; when they are turned to the dexter side of the shield, it is called increscent, when to the sinister, decrescent. A crescent is used as a difference to denote the second son of a house; thus the earls of Harrington place a crescent upon a crescent, as descending from the second son of a second son. An order of the crescent was instituted by Charles I. of Naples and Sicily in 1268, and revived by René of Anjou in 1464. A Turkish order or decoration of the crescent was instituted by Sultan Selim III. in 1799, in memory of the diamond crescent which he had presented to Nelson after the battle of the Nile, and which Nelson wore on his coat as if it were an order.

The crescent is the military and religious symbol of the Ottoman Turks. According to the story told by Hesychius of Miletus, during the siege of Byzantium by Philip of Macedon the moon suddenly appeared, the dogs began to bark and aroused the inhabitants, who were thus enabled to frustrate the enemy's scheme of undermining the walls. The grateful Byzantines erected a statue to "torch-bearing" Hecate, and adopted the lunar crescent as the badge of the city. It is generally supposed that it was in turn adopted by the Turks after the capture of Constantinople in 1453, either as a badge of triumph, or to commemorate a partial eclipse of the moon on the night of the final attack. In reality, it seems to have been used by them long before that event. Ala ud-din, the Seljuk sultan of Iconium (1245-1254), and Ertoghul, his lieutenant and the founder of the Ottoman branch of the Turkish race, assumed it as a device, and it appeared on the standard of the janissaries of Sultan Orkhan (1326-1360). Since the new moon is associated with special acts of devotion in Turkey—where, as in England, there is a popular superstition that it is unlucky to see it through glass—it may originally have been adopted in consequence of its religious significance. According to Professor Ridgeway, however, the Turkish crescent, like that seen on modern horse-trappings, has nothing to do with the new moon, but is the result of the base-to-base conjunction of two claw or tusk amulets, an example of which has been brought to light during the excavations of the site of the temple of Artemis Orthia at Sparta (see *Athenaeum*, March 21, 1908). There is nothing distinctively Turkish in the combination of crescent and star which appears on the Turkish national standard; the latter is shown by coins and inscriptions to have been an ancient Illyrian symbol, and is of course common in knightly and decorative orders. It is doubtful whether any opposition between crescent and cross, as symbols of Islam and Christianity, was ever intended by the Turks; and it is an historical error to attribute the crescent to the Saracens of crusading times or the Moors in Spain.

Crescent is also the name of a Turkish musical instrument. In architecture, a crescent is a street following the arc of a circle; the name in this sense was first used in the Royal Crescent at Bath.

**CRESCIMBENI, GIOVANNI MARIO** (1663-1728), Italian critic and poet, was born at Macerata in 1663. Having been educated by a French priest at Rome, he entered the Jesuits' college of his native town, where he produced a tragedy on the

story of Darius, and versified the *Pharsalia*. In 1679 he received the degree of doctor of laws, and in 1680 he removed again to Rome. The study of Filicaja and Leonico having convinced him that he and all his contemporaries were working in a wrong direction, he resolved to attempt a general reform. In 1690, in conjunction with fourteen others, he founded the celebrated academy of the Arcadians, and began the contest against false taste and its adherents. The academy was most successful; branch societies were opened in all the principal cities of Italy; and the influence of Marini, opposed by the simplicity and elegance of such models as Costanzo, soon died away. Crescimbeni officiated as secretary to the Arcadians for thirty-eight years. In 1705 he was made canon of Santa Maria; in 1715 he obtained the chief curacy attached to the same church; and about two months before he died (1728) he was admitted a member of the order of Jesus.

His principal work is the *Istoria della volgar poesia* (Rome, 1698), an estimate of all the poets of Italy, past and contemporary, which may yet be consulted with advantage. The most important of his numerous other publications are the *Commentarij* (5 vols., Rome, 1702-1711), and *La Bellezza della volgar poesia* (Rome, 1700).

**CRESILAS**, a Cretan sculptor of Cydonia. He was a contemporary of Pheidias, and one of the sculptors who vied in producing statues of amazons at Ephesus (see GREEK ART) about 450 B.C. As his amazon was wounded (*volnerata*; Pliny, *Nat. Hist.* xxxiv. 75), we may safely identify it with the figure, of which several copies are extant, who is carefully removing her blood-stained garment from a wound under the right breast. Another work of Cresilas of which copies survive is the portrait of Pericles, the earliest Greek portrait which has been with certainty identified, and which fully confirms the statement of ancient critics that Cresilas was an artist who idealized and added nobility to men of noble type. An extant portrait of Anacreon is also derived from Cresilas.

**CRESOLS** or METHYL PHENOLS,  $C_7H_8O$  or  $C_6H_4 \cdot CH_3 \cdot OH$ . The three isomeric cresols are found in the tar obtained in the destructive distillation of coal, beech-wood and pine. The crude cresol obtained from tar cannot be separated into its different constituents by fractional distillation, since the boiling points of the three isomers are very close together. The pure substances are best obtained by fusion of the corresponding toluene sulphonic acids with potash.

Ortho-cresol,  $CH_3(1) \cdot C_6H_4 \cdot OH(2)$ , occurs as sulphate in the urine of the horse. It may be prepared by fusion of ortho-toluene sulphonic acid with potash; by the action of phosphorus pentoxide on carvacrol; or by the action of zinc chloride on camphor. It is a crystalline solid, which melts at  $30^\circ C.$  and boils at  $190.8^\circ C.$  Fusion with alkalis converts it into salicylic acid.

Meta-cresol,  $CH_3(1) \cdot C_6H_4 \cdot OH(3)$ , is formed when thymol (para-isopropyl-meta-cresol) is heated with phosphorus pentoxide. Propylene is liberated during the reaction, and the phosphoric acid ester of meta-cresol which is formed is then fused with potash. It can also be prepared by distilling meta-oxyvitic acid with lime, or by the action of air on boiling toluene in the presence of aluminium chloride (C. Friedel and J. M. Crafts, *Ann. Chim. Phys.*, 1888 [6], 14, p. 436). It solidifies in a freezing mixture, on the addition of a crystal of phenol, and then melts at  $3^\circ-4^\circ C.$  It boils at  $202.8^\circ C.$  Its aqueous solution is coloured bluish-violet by ferric chloride.

Para-cresol,  $CH_3(1) \cdot C_6H_4 \cdot OH(4)$ , occurs as sulphate in the urine of the horse. It is also found in horse's liver, being one of the putrefaction products of tyrosine. It may be prepared by the fusion of para-toluene sulphonic acid with potash; by the action of nitrous acid on para-toluidine; or by heating para-oxyphenyl acetic acid with lime. It crystallizes in prisms which melt at  $36^\circ C.$  and boil at  $201.8^\circ C.$  It is soluble in water, and the aqueous solution gives a blue coloration with ferric chloride. When treated with hydrochloric acid and potassium chlorate, no chlorinated quinones are obtained (M. S. Southworth, *Ann.* (1873), 168, p. 271), a behaviour which distinguishes it from ortho- and meta-cresol.

On the composition of commercial cresylic acid see A. H. Allen, *Jour. Soc. Chem. Industry* (1890), 9, p. 141. See also CREOSOTE.

**CRESPI, DANIELE** (1590-1630), Italian historical painter, was born near Milan, and studied under Giovanni Battista Crespi and Giulio Procaccini. He was an excellent colourist; his drawing was correct and vigorous, and he grouped his compositions with much ability. His best work, a series of pictures from the life of Saint Bruno, is in the monastery of the Carthusians at Milan. Among the most famous of his paintings is a "Stoning of St Stephen" at Brera, and there are several excellent examples of his work in the city of his birth and at Pavia.

**CRESPI, GIOVANNI BATTISTA** (1557-1663), called Il Cerano, Italian painter, sculptor, and architect, was born at Cerano in the Milanese. He was a scholar of considerable attainments, and held a position of dignity in his native city. He was head of the Milanese Academy founded by Cardinal Frederigo Borromeo, and he was the teacher of Guercino. He is most famous as a painter; and, though his figures are neither natural nor graceful, his colouring is good, and his designs full of ideal beauty.

**CRESPI, GIUSEPPE MARIA** (1665-1747), Italian painter, called "Lo Spagnuolo" from his fondness for rich apparel, was born at Bologna, and was trained under Angelo Toni, Domenico Canuti and Carlo Cignani. He then went through a course of copying from Correggio and Barocci; this he followed up with a journey to Venice for the sake of Titian and Paul Veronese; and late in life he proclaimed himself a follower of Guercino and Pietro da Cortona. He was a good colourist and a facile executant, and was wont to employ the camera obscura with great success in the treatment of light and shadow; but he was careless and unconscientious. He was a clever portrait-painter and a brilliant caricaturist; and his etchings after Rembrandt and Salvator are in some demand. His greatest work, a "Massacre of the Innocents," is at Bologna; but the Dresden gallery possesses twelve examples of him, among which is his celebrated series of the Seven Sacraments.

**CRESS**, in botany. "Garden Cress" (*Lepidium sativum*) is an annual plant (nat. ord. Cruciferae), known as a cultivated plant at the present day in Europe, North Africa, western Asia and India, but its origin is obscure. Alphonse de Candolle (*L'Origine des plantes cultivées*) says its cultivation must date from ancient times and be widely diffused, for very different names for it exist in the Arab, Persian, Albanian, Hindustani and Bengali tongues. He considered the plant to be of Persian origin, whence it may have spread after the Sanskrit epoch (there is no Sanskrit name for it) into the gardens of India, Syria, Greece and North Africa. It is used in salads, the young plants being cut and eaten while still in the seed-leaf, forming, along with plants of the white mustard in the same stage of growth, what is commonly called "small salad." The seeds should be sown thickly broadcast or in rows in succession every ten or fourteen days, according to the demand. The sowings may be made in the open ground from March till October, the earliest under hand-glasses, and the summer ones in a cool moist situation, where water from trees, shrubs, walls, &c., cannot fall on or near them. The grit thrown up by falling water pierces the tender tissues of the cress, and cannot be thoroughly removed by washing. During winter they must be raised on a slight hotbed, or in shallow boxes or pans placed in any of the glass-houses where there is a temperature of  $60^\circ$  or  $65^\circ$ . Cress is subject to the attack of a fungus (*Pythium de-Baryanum*) if kept too close and moist. The pest very quickly infects a whole sowing. There is no cure for it; preventive measures should therefore be taken by keeping the sowings fairly dry and well ventilated. The seed should be sown on new soil, and should not be covered.

The "Golden" or "Australian" cress is a dwarf, yellowish-green, mild-flavoured sort, which is cut and eaten when a little more advanced in growth but while still young and tender. It should be sown at intervals of a month from March onwards, the autumn sowing, for winter and spring use, being made in a sheltered situation.

The "curled" or "Normandy" cress is a very hardy sort, of good flavour. In this, which is allowed to grow like parsley, the leaves are picked for use while young; and, being finely cut



and curled, they are well adapted for garnishing. It should be sown thinly, in drills, in good soil in the open borders, in March, April and May, and for winter and spring use at the foot of a south wall early in September, and about the middle of October.

*Water-cress*.—“Water-cress” (*Nasturtium officinale*) is a member of the same natural order, and a native of Great Britain. Although now so largely used, it does not appear to have been cultivated in England prior to the 19th century, though in Germany, especially near Erfurt, it had been grown long previously. Its flavour is due to an essential oil containing sulphur. Water-cress is largely cultivated in shallow ditches, prepared in wet, low-lying meadows, means being provided for flooding the ditches at will. Where the amount of water available is limited, the ditches are arranged at successively higher levels, so as to allow of the volume admitted to the upper ditch being passed successively to the others. The ditches are usually puddled with clay, which is covered to the depth of 9 to 12 in. with well-manured soil.

A stock of plants may be raised in two ways—by cuttings, and by seeds. If a stock is to be raised from cuttings, the desired quantity of young shoots is gathered—those sold in bunches for salad serve the purpose well—and reduced where necessary to about 3 in. in length, the basal and frequently rooted portion being rejected. They are dibbled thickly into one of the ditches, and only enough water admitted to just cover the soil. If the start is made in late spring, the cuttings will be rooted in a week. They are allowed to remain for another week or two, and are then taken up and dropped about 9 in. apart into the other ditches, which have been slightly flooded to receive them. There is no need to plant them—the young roots will very soon be securely anchored. The volume of water is increased as the plants grow. If raised from seed, the seed-bed is prepared as for cuttings, and seed sown either in drills or broadcast. No flooding is done until the seedlings are up. Water is then admitted, the level being raised as the plants grow. When 5 or 6 in. high, they are taken up and dropped into their permanent quarters precisely like those raised from cuttings.

Cultivated as above described, the plants afford frequent cuttings of large clean cress of excellent flavour for market purposes. Sooner or later growth will become less vigorous and flowering shoots will be produced. This will be accompanied by a pronounced deterioration of the remaining vegetative shoots. These signs will be interpreted by the grower to mean that his plants, as a market crop, are worn out. He will therefore take steps to repeat the routine of culture above described. In the winter the ditches are flooded to protect the cress from frost.

The best-flavoured water-cress is produced in the pure water of running streams over chalk or gravel soil. Should the water be contaminated by sewage or other undesirable matter, the plants not only absorb some of the impurities but also serve to anchor much of the solid particles washed as scum among them. This is extremely difficult to dislodge by washing, and renders the cress a source of danger as food.

Water-cress for domestic use may be raised as a kitchen-garden crop if frequently watered overhead. Beds to afford cress during the summer should be made in broad trenches on a border facing north. It may also be raised in pots or pans stood in saucers of water and frequently watered overhead.

In recent years in America attention has been paid to the injury done to water-cress beds by the “water-cress sow-bug” (*Mancaellus brachyurus*), and the “water-cress leaf-beetle” (*Phaedon aeruginosa*). Another species of *Phaedon* is known in England as “blue beetle” or “mustard beetle,” and is a pest also of mustard, cabbage and kohlrabi (see F. H. Chittenden, in *Bulletin* 66, part ii. of Bureau of Entomology, United States Department of Agriculture, 1907).

The name “nasturtium” is applied in gardens, but incorrectly, to species of *Tropaeolum*.

**CRESSANT, CHARLES** (1685–1768), French furniture-maker, sculptor and *fondeur-ciseleur*. As the second son of François Cressant, *sculpteur du roi*, and grandson of Charles Cressant, a furniture-maker of Amiens, who also became a sculptor, he

inherited the tastes and aptitudes which were likely to make a finished designer and craftsman. Even more important perhaps was the fact that he was a pupil of André Charles Boulle. Trained in such surroundings, it is not surprising that he should have reached a degree of achievement which has to a great extent justified the claim that he was the best decorative artist of the 18th century. Cressant's distinction is closely connected with the regency, but his earlier work had affinities with the school of Boulle, while his later pieces were full of originality. He was an artist in the widest sense of the word. He not only designed and made furniture, but created the magnificent gilded enrichments which are so characteristic of his work. He was likewise a sculptor, and among his plastic work is known to have been a bronze bust of Louis, duc d'Orléans, the son of the regent, for whom Cressant had made one of the finest examples of French furniture of the 18th century—the famous *médaillier* now in the Bibliothèque Nationale. Cressant's bronze mounts were executed with a sharpness of finish and a grace and vigour of outline which were hardly excelled by his great contemporary Jacques Caffieri. His female figures placed at the corners of tables are indeed among the most delicious achievements of the great days of the French metal worker. Much of Cressant's work survives, and can be identified; the Louvre and the Wallace collection are especially rich in it, and his commode at Hertford House with gilt handles representing Chinese dragons is perhaps the most elaborate piece he ever produced. The work of identification is rendered comparatively easy in his case by the fact that he published catalogues of three sales of his work. These catalogues are highly characteristic of the man, who shared in no small degree the personal *bravoure* of Cellini, and could sometimes execute almost as well. He did not hesitate to describe himself as the author of “a clock worthy to be placed in the very finest cabinets,” “the most distinguished bronzes,” or pieces of “the most elegant form adorned with bronzes of extra richness.” He worked much in marqueterie, both in tortoiseshell and in brilliant coloured woods. He was indeed an artist to whom colour appealed with especial force. The very type and exemplar of the “feeling” of the regency, he is worthy to have given his own name to some of the fashions which he deduced from it.

**CRESSWELL, SIR CRESSWELL** (1794–1863), English judge, was a descendant of an old Northumberland family, and was born at Newcastle in 1794. He was educated at the Charterhouse and at Emmanuel College, Cambridge. He graduated B.A. in 1814, and M.A. four years later. Having chosen the profession of the law he studied at the Middle Temple, and was called to the bar in 1819. He joined the northern circuit, and was not long in earning a distinguished position among his professional brethren. In 1837 he entered parliament as Conservative member for Liverpool, and he soon gained a reputation as an acute and learned debater on all constitutional questions. In January 1842 he was made a judge of the court of common pleas, being knighted at the same time; and this post he occupied for sixteen years. When the new court for probate, divorce and matrimonial causes was established (1858), Sir Cresswell Cresswell was requested by the Liberal government to become its first judge and undertake the arduous task of its organization. Although he had already earned a right to retire, and possessed large private wealth, he accepted this new task, and during the rest of his life devoted himself to it most assiduously and conscientiously, with complete satisfaction to the public. In one case only, out of the very large number on which he pronounced judgment, was his decision reversed. His death was sudden. By a fall from his horse on the 11th of July 1863 his knee-cap was injured. He was recovering from this when on the 29th of the same month he died of disease of the heart.

See Foss's *Lives of the Judges*; E. Manson, *Builders of our Law* (1904).

**CRESSY, HUGH PAULINUS DE** (c. 1605–1674), English Benedictine monk, whose religious name was Serenus, was born at Wakefield, Yorkshire, about 1605. He went to Oxford at the age of fourteen, and in 1626 became a fellow of Merton College. Having taken orders, he rose to the dignity of dean of Leighlin,

Ireland, and canon of Windsor. He also acted as chaplain to Lord Wentworth, afterwards the celebrated earl of Strafford. For some time he travelled abroad as tutor to Lord Falmouth, and in 1646, during a visit to Rome, joined the Roman Catholic Church. In the following year he published his *Exomologesis* (Paris, 1647), or account of his conversion, which was highly valued by Roman Catholics as an answer to William Chillingworth's attacks. Cressy entered the Benedictine Order in 1649, and for four years resided at Somerset House as chaplain to Catherine of Braganza, wife of Charles II. He died at West Grinstead on the 10th of August 1674. Cressy's chief work, *The Church History of Brittany or England, from the beginning of Christianity to the Norman Conquest* (1st vol. only published, Rouen, 1668), gives an exhaustive account of the foundation of monasteries during the Saxon heptarchy, and asserts that they followed the Benedictine rule, differing in this respect from many historians. The work was much criticized by Lord Clarendon, but defended by Antony à Wood in his *Athenae Oxoniensis*, who supports Cressy's statement that it was compiled from original MSS. and from the *Annales Ecclesiae Britannicae* of Michael Alford, *Dugdale's Monasticon*, and the *Decem Scriptores Historiae Anglicanae*. The second part of the history, which has never been printed, was discovered at Douai in 1856. To Roman Catholics Cressy's name is familiar as the editor of Walter Hilton's *Scale of Perfection* (London, 1659); of Father A. Baker's *Sancta Sophia* (2 vols., Douai, 1657); and of Juliana of Norwich's *Sixteen Revelations on the Love of God* (1670). These books, which would have been lost but for Cressy's zeal, have been frequently reprinted, and have been favourably regarded by a section of the Anglican Church.

For a complete list of Cressy's works see J. Gillow's *Bibl. Dict. of Eng. Catholics*, vol. i.

**CREST**, a town of south-eastern France, in the department of Drôme, on the right bank of the Drôme, 20 m. S.S.E. of Valence by rail. Pop. (1906) town, 3971; commune, 5660. It carries on silk-worm breeding, silk-spinning, and the manufacture of woollens, paper, leather and cement. There is trade in truffles. On the rock which commands the town stands a huge keep, the sole survival of a castle (12th century) to which Crest was indebted for its importance in the middle ages and the Religious Wars. The rest of the castle was destroyed in the first half of the 17th century, after which the keep was used as a state prison. Crest ranked for a time as the capital of the duchy of Valentinois, and in that capacity belonged before the Revolution to the prince of Monaco. The communal charter, graven on stone and dating from the 12th century, is preserved in the public archives. Ten miles south-east of Crest lies the picturesque Forest of Saon.

**CREST** (Lat. *crista*, a plume or tuft), the "comb" on an animal's head, and so any feathery tuft or excrescence, the "cone" of a helmet (by transference, the helmet itself), and the top or summit of anything. In heraldry (*q.v.*) a crest is a device, originally borne as a cognizance on a knight's helmet, placed on a wreath above helmet and shield in armorial bearings, and used separately on a seal or on articles of property.

*Cresting*, in architecture, is an ornamental finish in the wall or ridge of a building, which is common on the continent of Europe. An example occurs at Exeter cathedral, the ridge of which is ornamented with a range of small *fleurs-de-lis* in lead.

**CRESTON**, a city and the county-seat of Union county, Iowa, U.S.A., about 60 m. S.W. of Des Moines, at the crossing of the main line and two branches of the Chicago, Burlington & Quincy railway. Pop. (1890) 7200; (1900) 7752; (1905, state census) 8382 (753 foreign-born); (1910) 6924. The city is on the crest of the divide between the Mississippi and the Missouri basins at an altitude of about 1310 ft.—whence its name. It is situated in a fine farming and stock-raising region, for which it is a shipping point. The site was chosen in 1869 by the Burlington & Missouri River Railroad Company (subsequently merged in the Chicago, Burlington & Quincy Railroad Company) for the location of its shops. Creston was incorporated as a town in 1869, and was chartered as a city in 1871.

**CRESWICK, THOMAS** (1811–1869), English landscape-painter, was born at Sheffield, and educated at Hazelwood, near Birmingham. At Birmingham he first began to paint. His earliest appearance as an exhibitor was in 1827, at the Society of British Artists in London; in the ensuing year he sent to the Royal Academy the two pictures named "Llyn Gwynant, Morning," and "Carnarvon Castle." About the same time he settled in London; and in 1836 he took a house in Bayswater. He soon attracted some attention as a landscape-painter, and had a career of uniform and encouraging, though not signal success. In 1842 he was elected an associate, and in 1850 a full member of the Royal Academy, which, for several years before his death, numbered hardly any other full members representing this branch of art. In his early practice he set an example, then too much needed, of diligent study of nature out of doors, painting on the spot all the substantial part of several of his pictures. English and Welsh streams may be said to have formed his favourite subjects, and generally British rural scenery, mostly under its cheerful, calm and pleasurable aspects, in open daylight. This he rendered with elegant and equable skill, colour rather grey in tint, especially in his later years, and more than average technical accomplishment; his works have little to excite, but would, in most conditions of public taste, retain their power to attract. Creswick was industrious and extremely prolific; he produced, besides a steady outpouring of paintings, numerous illustrations for books. He was personally genial—a dark, bulky man, somewhat heavy and graceless in aspect in his later years. He died at his house in Bayswater, Linden Grove, on the 28th of December 1869, after a few years of declining health. Among his principal works may be named "England" (1847); "Home by the Sands, and a Squally Day" (1848); "Passing Showers" (1849); "The Wind on Shore, a First Glimpse of the Sea, and Old Trees" (1850); "A Mountain Lake, Moonrise" (1852); "Changeable Weather" (1865); also the "London Road, a Hundred Years ago"; "The Weald of Kent"; the "Valley Mill" (a Cornish subject); a "Shady Glen"; the "Windings of a River"; the "Shade of the Beech Trees"; the "Course of the Greta"; the "Wharfe"; "Glendalough," and other Irish subjects, 1836 to 1840; the "Forest Farm." Frith for figures, and Ansdell for animals, occasionally worked in collaboration with Creswick.

In 1873 T. O. Barlow, the engraver, published a catalogue of Creswick's works.

**CRESWICK**, a borough of Talbot county, Victoria, Australia, 85½ m. by rail N.W. of Melbourne. Pop. (1901) 3060. It is the centre of a mining, pastoral and agricultural district. Gold is found both in alluvial and quartz formations, the quartz being especially rich. The surrounding country is fertile and well-timbered, and there is a government plantation and nursery in connexion with the forests department.

**CRETACEOUS SYSTEM**, in geology, the group of stratified rocks which normally occupy a position above the Jurassic system and below the oldest Tertiary deposits; therefore it is in this system that the closing records of the great Mesozoic era are to be found. The name furnishes an excellent illustration of the inconvenience of employing a local lithological feature in the descriptive title of a wide-ranging rock-system. The white chalk (Lat. *creta*), which gives its name to the system, was first studied in the Anglo-Parisian basin, where it takes a prominent place; but even in this limited area there is a considerable thickness and variety of rocks which are not chalky, and the Cretaceous system as a whole contains a remarkable diversity of types of sediment.

*Classification.*—The earlier subdivisions of the Cretaceous rocks were founded upon the uncertain ground of similarity in lithological characters, assisted by observed stratigraphical sequence. This method yielded poor results even in a circumscribed area like Great Britain, and it breaks down utterly when applied to the correlation of rocks of similar age in Europe and elsewhere. Study of the fossils, however, has elicited the fact that certain forms characterize certain "zones," which are preceded and succeeded by other zones each bearing a peculiar species or

distinctive assemblage of species. By these means the Cretaceous rocks of the world have now been correlated zone with zone, with a degree of exactitude proportional to the palaeontological information gained in the several areas of occurrence.

The Cretaceous system falls naturally into two divisions, an upper and a lower, in all but a few limited regions. In the table on page 288 the names of the principal stages are enumerated; these are capable of world-wide application. The sub-stages are of more local value, and too much importance must not be attached to them for the correlation of distant deposits. The general table is designed to show the relative position in the system of some of the more important and better-known formations; but it must be remembered that the Cretaceous rocks of Europe can now be classified in considerable detail

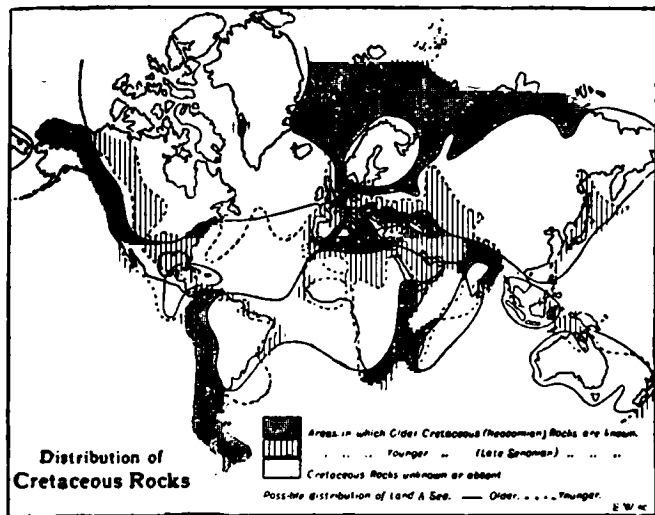

by their fossils, the most accurate group for this purpose being the cephalopods. The smaller table was compiled by T. C. Chamberlin and R. D. Salisbury to show the main subdivisions of the North American Cretaceous rocks. The correlation of the minor subdivisions of Europe and America are only approximate.

*Relation of the Cretaceous Strata to the Systems above and below.*

—In central and northern Europe the boundary between the Cretaceous and Tertiary strata is sharply defined by a fairly general unconformity, except in the Danian and Montian beds, where there is a certain commingling of Tertiary with Cretaceous fossils. The relations with the underlying Jurassic rocks are not so clearly defined, partly because the earliest Cretaceous rocks are obscured by too great a thickness of younger strata, and partly because the lowest observable rocks of the system are not the oldest, but are higher members of the system that have overlapped on to much older rocks. However, in the south of England, in the Alpine area, and in part of N.W. Germany the passage from Jurassic to Cretaceous is so gradual that there is some divergence of opinion as to the best position for the line of separation. In the Alpine region this passage is formed by marine beds, in the other two by brackish-water deposits. In a like manner the Potomac beds of N. America grade downwards into the Jurassic; while in the Laramie formation an upward passage is observed into the Eocene deposits. There is a very general unconformity and break between the Lower and Upper Cretaceous; this has led Chamberlin and Salisbury to suggest that the Lower Cretaceous should be regarded as a separate period with the title "Comanchean."

*Physiographical Conditions and Types of Deposit.*—With the opening of the Cretaceous in Europe there commenced a period of marine transgression; in the central and western European region this took place from the S. towards the N., slow at first and local in effect, but becoming more decided at the beginning of the upper division. During the earlier portion of the period, S. England, Belgium and Hanover were covered by a great series of estuarine sands and clays, termed the Wealden formation (*q.v.*), the delta of a large river or rivers flowing probably from the N.W.

Meanwhile, in the rest of Europe alternations of marine and estuarine deposits were being laid down; but over the Alpine region lay the open sea, where there flourished coral reefs and great banks of clam-like molluscs. The sea gradually encroached upon the estuarine Wealden area, and at the time of the Aptian deposits uniform marine conditions prevailed from western Europe through Russia into Asia. This extension of the sea is illustrated in England by the overlap of the Gault over the Lower Greensand on to the older rocks, and by similar occurrences in N. France and Germany.

Almost throughout the Upper Cretaceous period the marine invasion continued, varied here and there by slight movements in the opposite sense which did not, however, interfere with the quiet general advance of the sea. This marine extension made itself felt over the old central plateau of France, the N. of Great Britain, the Spanish peninsula, the Armorican peninsula, and also in the Bavarian Jura and Bohemia; it affected the northern part of Africa and East Africa; in N. America the sea spread over the entire length of the Rocky Mountain region; and in Brazil, eastern Asia and western Australia, Upper Cretaceous deposits are found resting directly upon much older rocks. Indeed, at this time there happened one of the greatest changes in the distribution of land and water that have been recorded in geological history.

We have seen that in early Cretaceous times marine limestones were being formed in southern Europe, while estuarine sands and muds were being laid down in the Anglo-German delta, and that beds of intermediate character were being made in parts of N. France and Germany. During later Cretaceous times this striking difference between the northern and southern facies was maintained, notwithstanding the fact that the later deposits were of marine origin in both regions. In the northern region the gradual deepening and accompanying extension of the sea caused the sandy deposits to become finer grained in N.W. Europe. The sandy beds and clays then gave way to marly deposits, and in these early stages glauconitic grains are very characteristically present both in the sand and in the marls. In their turn these marly deposits in the Anglo-Parisian basin were succeeded gradually and somewhat intermittently by the purer, soft limestone of the chalk sea, and by limestones, similar in character, in N. France, extra-Alpine Germany, S. Scandinavia, Denmark and Russia. Meanwhile, the S. European deposits maintained the characters already indicated; limestones (not chalk) prevailed, except in certain Alpine and Carpathian tracts where detrital sandstones were being laid down.

The great difference between the lithological characters of the northern and southern deposits is accompanied by an equally striking difference between their respective organic contents. In the north, the genera *Inoceramus* and *Belemnitella* are particularly abundant. In the south, the remarkable, large, clam-like, aberrant pelecypods, the *Hippuritidae*, *Rudistes*, *Caprotina*, &c., attained an extraordinary development; they form great lenticular banks, like the clam banks of warm seas, or like our modern oyster-beds; they appear in successive species in the different stages of the Cretaceous system of the south, and can be used for marking palaeontological horizons as the cephalopods are used elsewhere. Certain genera of ammonites, *Haploceras*, *Lyloceras*, *Phylloceras*, rare in the north, are common in the south; and the southern facies is further characterized by the peculiar group of swollen belemnites (*Dumontia*), by the gastropods *Actionella*, *Nerinea*, &c., and by reef-building corals. The southern facies is far more widespread and typical of the period than is the chalk; it not only covers all southern Europe, but spreads eastwards far into Asia and round the Mediterranean basin into Africa. It is found again in Texas, Alabama, Mexico, the West Indies and Colombia; though limestones of the chalk type are found in Texas, New Zealand, and locally in one or two other places. The marine deposits are organically formed limestones, in which foraminifera and large bivalve mollusca play a leading part, marls and sandstones; dolomite and oolitic and pisolitic limestones are also known.

The Cretaceous seas were probably comparatively shallow;

CRETACEOUS SYSTEM

	European Classification.		Britain.	Germany, &c., several other parts of Europe.	Alpine Region.	Africa.	India.	Australia.	New Zealand.	S. America.	Japan.	Greenland.		
	Stages.	Sub-stages.												
Upper Cretaceous. Senonian.	Montian.	(placed by some in the Tertiary).	Chalk of Trimmingham.	Marls and pisolitic Limestone of Meudon. Limestone of Saltholm and Faxø (Denmark).	Cretaceous Flysch. . . . . Carpathian and Vienna Sandstones, Gosau formation of E. Alps. Seewan beds of N. Alps. Scaglia of S. Alps.	N. Africa and Syria.	Pondoland Beds S. Africa.	Desert Sandstone.	Waipara Beds and Limestones, Chalk, with Flints, Marls and Greensand.	San Martin Series.	Izumi Sandstone and Hokkaido Series.	Atani Group. Patoot Group (part).		
	Danian.												Upper Chalk with Flints.	Upper Quader Sandstone.
	Aturian.													
	Emscherian.		Grey Chalk. Chalk marl. Cambridge Greensand.	Lr. Pläner and Lr. Quader.										
	Turonian.												Carentonian. Rothomagian.	Tourtia of Mons, &c.
	Cenomanian.		Selbornian.	Flammen mergel. Clay of N. Germany.										
Lower Cretaceous.	Albian.	Gault.	Gault and Upper Greensand.	Hippurite limestones of Southern France and Mediterranean Region. . . . . Cretaceous Flysch. . . . . Aptychenkalk in E. Alps. . . . . Biancone of S. Alps.	Nubian Sandstone of . . . . .	Uitenhage Beds S. Africa.	Oomia and Utatur Group.	Rolling Down Formation.	Thick conglomeratic Series with Bituminous coals.	Belgrano. . . . .	Torinosa Limestone and Ryoseki Series.†	Kome Group.		
	Aptian.	Gargasian. Bedoulian.	Lower Greensand.										Urgonian Requienia (caprotina) Kalk or Schrattenkalk.	
	Barremian.	Hauterivian.	Weald Clay and Hastings sands.										North German Hills formation.	
	Neocomian.	Valangian. Berriasian.	Marine Beds of Specton.											

Note to Table.

Montian	from	Mons in Belgium.
Danian	"	Denmark = <i>Garumnien</i> of Leymerie.
Aturian	"	Adour.
Maestrichtian	"	Maestricht.
Campanian	"	Champagne.
Emscherian	"	Emscher river in Westphalia.
Santonian	"	Saintonge.
Coniacian	"	Cognac.
Senonian	"	Sens in department of Yonne.
Turonian	"	Touraine.
Angoumian	"	Angoumois.
Ligerian	"	the Loire.
Cenomanian	"	Le Mans (Cenomanum).
Carentonian	"	Charente.
Rothomagian	"	Rouen ( <i>Rothomagus</i> ).
Albian	"	dept. of Aube.
Selbornian	"	Sptorne in Hampshire.
Aptian	"	Apt in Vaucluse.
Gargasian	"	Gargas near Apt.
Bedoulian	"	la Bedoule (Var) = <i>Rhodanien</i> of Renevier.
Barremian	"	Barrême in Basses Alpes.
Hauterivian	"	Hauterive on Lake of Neuchâtel.
Valangian	"	Château de Valengin near Neuchâtel.
Neocomian	"	Neuchâtel ( <i>Neocomum</i> ).
Berriasian	"	Berrias (Ardèche) near Besseges.
Urgonian	"	Orgon near Arles.

this was certainly the case where the deposits are sandy, and in the regions occupied by the hippuritic fauna. Much discussion has taken place as to the depth of the chalk sea. Stress has been laid upon the resemblance of this deposit to the modern deep-sea globigerina-ooze; but on the whole the evidence is in favour of moderate depth, perhaps not more than 1000 fathoms; the freedom of the deposit from detrital matter being regarded as due to the low elevation of the surrounding land, and the main lines of drainage being in other directions. Sandy and shore deposits are common throughout the system in every region. Besides the Weald, there were great lacustrine and terrestrial deposits in N. America (the Potomac, Kootenay, Morrison, Dakota and Laramie formations) as well as in N. Spain, and in parts of Germany, &c. The general distribution of land and sea is indicated in the map.

*Earth Movements and Vulcanicity.*—During the greater part of the Cretaceous period crustal movements had been small and local in effect, but towards the close a series of great deformative movements was inaugurated and continued into the next period. These movements make it possible to discriminate between the Cretaceous and Tertiary rocks, because the conditions of sedimentation were profoundly modified by them, and in most

	Atlantic Coast.	Eastern Gulf Region.	Western Gulf Region.	Western Interior.	Pacific Coast.	European.
CRETACEOUS Upper Cretaceous.	Manasquan.	.....	.....	Denver, Livingstone, &c. (possibly Eocene).	Not differentiated or wanting.	Danian.
	Rancocas.			Laramie.		
	Monmouth.	Ripley.	Montana Series. Navarro.	Montana Series. 2. Fox Hills. 1. Fort Pierre and Belly River.	Chico.	Senonian.
	Matawan.	Eutaw.	Colorado Series. 2. Austin. 1. Eagle Ford.	Colorado Series. 2. Niobrara. 1. Benton.		Turonian.
.....	.....	Dakota. Woodbine.	Dakota.	Cenomanian. Albian. Unconformity in places.		
COMANCHEAN Lower Cretaceous.	Potomac Series. 4. Raritan. 3. Patapsco.  2. Arundel } 1. Patuxent } Jurassic?	Tuscaloosa Series.	Washita.	Kootenay and Morrison (or Como).	Horsetown } Knoxville } Shastan.	Aptian.
			Fredericksburg.			Trinity.
						Neocomian. Wealden.

parts of the world there resulted a distinct break in the sequence of fossil remains. Great tracts of our modern continental land areas gradually emerged, and several mountainous tracts began to be elevated, such as the Appalachians, parts of the Cordilleras, and the Rocky Mountains, and their northern continuation, and indeed the greater part of the western N. American continent was intensely affected; the uplifting was associated with extensive faulting. Volcanic activity was in abeyance in Europe and in much of Asia, but in America there were many eruptions and intrusions of igneous rock towards the close of the period. Diabases and peridotites had been formed during the Lower Cretaceous in the San Luis Obispo region. Great masses of ash and conglomerate occur in the Crow's Nest Pass in Canada; porphyries and porphyritic tuffs of later Cretaceous age are important in the Andes; while similar rocks are found in the Lower Cretaceous of New Zealand. It is, however, in the Deccan lava flows of India that we find eruptions on a scale more vast than any that have been recorded either before or since. These outpourings of lava cover 200,000 sq. m. and are from 4000 to 6000 ft. thick. They lie upon an eroded Cenomanian surface and are to some extent interbedded with Upper Cretaceous sediments.

**Economic Products of Cretaceous Rocks.**—Coal is one of the most important products of the rocks of this system. The principal Cretaceous coal-bearing area is in the western interior of N. America, where an enormous amount of coal—mostly lignitic, but in places converted into anthracite—lies in the rocks at the foot of the Rocky Mountains; most of this is of Laramie age. Similar beds occur locally in Montana. Coal seams of Lower Cretaceous age are found in the Black Hills (S. Dakota), Alaska, Greenland, and in New Zealand; and the "Upper Quader" of Löwenberg in Silesia also contains coal seams. Coals also occur in the brackish and fresh-water deposits of Carinthia, Dalmatia and Istria, while unimportant lignitic beds are known in many other regions. The Fort Pierre beds are oil-bearing at Boulder, Colorado; and the Trinity formation bears asphalt and bitumen. Important clay deposits are worked in the Raritan formation of New Jersey, &c., and pottery clays are found in the Löwenberg district in Germany. The Washita beds yield the well-known hone stone. Great beds of gypsum exist in the Cretaceous rocks of S. America. Near Salzburg a variety of the hippuritic lime-

stone is quarried for marble. Lithographic stone occurs in the Pyrenees. The economic products peculiar to the chalk are mentioned in the article CHALK. Beds of iron ore are found in the Lower Cretaceous of Germany and England.

**The Life of the Cretaceous Period.**—The fossils from the Cretaceous series comprise marine, fresh-water and terrestrial animals and plants. Foremost in interest and importance is the appearance in the Lower Potomac (Lower Cretaceous) of eastern and central N. America of the earliest representatives of angiospermous dicotyledons, and undoubted monocotyledons, the progenitors of our modern flowering plants. The angiosperms spread outward from the Atlantic coast region of N. America, and first appeared in Europe in the Aptian of Portugal; towards the close of the Lower Cretaceous period they occupied parts of Greenland, the remaining land areas of N. America, and were steadily advancing in every quarter of the globe. At first the Jurassic plants, the Cycads, ferns and conifers, lived on and were the dominant plant forms. Gradually, however, they took a subordinate place, and by the close of the Cretaceous period the angiosperms had gained the upper hand. The earliest of these fossil angiosperms is not in a true sense a primitive form, and no records of such types have yet been discovered. Some of the early forms of the Lower Cretaceous are distinctly similar to modern genera, such as *Ficus*, *Sassafras* and *Aralia*; others bore leaves closely resembling our elm, maple, willow, oak, eucalyptus, &c. Before the close of the period many other representatives of living genera had appeared, beech, walnut, tamarisk, plane, laurel (*Laurus*), cinnamon, ivy, ilex, viburnum, buckthorn, breadfruit, oleander and others; there were also junipers, thujas, pines and sequoias and monocotyledons such as *Potamogeton* and *Arundo*. This flora was widely spread and uniform; there was great similarity between that of Europe and N. America, and in parts of the United States (Virginia and Maryland) the plants were very like those in Greenland. The general aspect of the flora was sub-tropical; the eucalyptus and other plants then common in Europe and N. America are now confined to the southern hemisphere.

The marine fauna comprised foraminifera which must have swarmed in the Chalk and some of the limestone seas; their shells have formed great thickness of rock. Common forms are



the genera *Alveolina*, *Cristellaria*, *Rotalia*, *Textularia*, *Orbitolina* *Globigerina*. Radiolarians were doubtless abundant, but their remains are rare. Sponges with calcareous (*Peronidilla*, *Barroisia*) and siliceous skeletons (*Siphonia*, *Coelopychium*, *Ventriculites*) were very numerous in certain of the Cretaceous waters. Corals were comparatively rare, *Trochosmia*, *Parasmilia*, *Holocystis* being typical genera; reefs were formed in the Maestricht beds of Denmark and Faxoe, in the Neocomian and Turonian of France, in the Turonian of the Alps and Pyrenees, and also in the Gosau beds and in the Utatur group of India. Sea-urchins were a conspicuous feature, and many nearly allied forms are still living; *Cidaris*, *Micraster*, *Discoidea* are examples. Crinoids were represented by *Marsupites*, *Uintacrinus* and *Bourgueticrinus*; starfish (*Calliderma* and *Pentagonaster*) were not uncommon. Polyzoa were abundant; brachiopods were fairly common, though subordinate to the pelecypods; they were mostly rhynchonellids and terebratulids, which lived side by side with the ancient forms, like *Crania* and *Discina*. The bivalve mollusca were very important during this period, *Inoceramus*, *Ostrea*, *Spondylus*, *Gervillia*, *Exogyra*, *Pecten*, *Trigonia* being particularly abundant in the northern seas, while in the southern waters the remarkable *Hippurites*, *Radiolites*, *Caprotina*, *Caprina*, *Monopleura* and *Requienia* prevailed. Gasteropods were well represented and included many modern genera. Cephalopods were important as a group, but the ammonites, so vigorous in the foregoing period, were declining and were assuming curious degenerate forms, often with a tendency to uncoil the shell; *Baculites*, *Hoplites*, *Turrilites*, *Ptychoceras*, *Hamites* are some of the typical genera, while *Belemnites* and *Belemniteella* were abundant in the northern seas.

The vertebrate fauna of the Cretaceous period differed in many features from that of the present day; mammals appear to have been only poorly represented by puny forms, related to Triassic and Jurassic types; they were mainly marsupials (*Batodon*, *Cimolestes*) with a few monotreme-like forms; carnivores, rodents and ungulates were still unknown. As in Jurassic times, reptiles were the dominant forms, and not a few genera lived on from the former period into the Cretaceous; but, on the whole, the reptilian assemblage was no longer so varied, and most of the distinctive mesozoic types had passed away before the close of this period. Dinosaurs were represented by herbivorous and carnivorous genera as in the Jurassic period, but the latter were less abundant than before. The *Iguanodon* of the Sussex-Weald and Bernissart in Belgium is perhaps the best-known genus; but there were many others, their remains being particularly abundant and well-preserved in the Cretaceous deposits of N. America. *Titanosaurus*, *Acanthopholis*, *Megalosaurus* and *Hypsilophodon* may be mentioned, some of these being of great size, while *Diclonius* was a curious duck-billed creature; but most remarkable in appearance must have been the horned Dinosaurs, *Ceratops* and *Triceratops*, gross, unwieldy creatures, 25 to 30 ft. long, whose huge heads were grotesquely armed with horns and bony frills.

Coincident, perhaps, with the widespread extension of the sea was the development of aquatic habits and structures suitable thereto amongst all the reptilian groups including also the birds. The foremost place was undoubtedly taken by the pythonomorphs or sea-serpents, including *Mosasaurus* and many others; these were enormously elongated creatures, reaching up to 75 ft., with swimming flappers and powerful swimming tails, and they lived a predatory life in the open sea. Ichthyosaurs soon disappeared from Cretaceous waters; but the plesiosaurians (*Cimoliosaurus* and others) reached their maximum development in this period. The remarkable flying lizards, pterosaurs, likewise attained their great development and then passed away; they ranged in size from that of a pigeon to creatures with a wing-spread of 25 ft.; notable genera are *Pteranodon*, *Ornitho-*

*cheirus*, *Nyctiosaurus*. Ordinary lizard-like forms were represented by *Coniosaurus*, *Dolichosaurus*, &c.; and true crocodiles, *Goniopholis*, *Suchosaurus*, appeared in this period, and continued to approximate to modern genera. The earliest known river turtles are found in the Belly River deposits of Canada; marine turtles also made their first appearance and were widely represented, some of them, *Archelon* and *Protostega*, being of great size. True snakes appeared later in the period.

The birds, as far as existing evidence goes, were aquatic; some, like *Ichthyornis*, were built for powerful flight; others, like *Hesperornis*, were flightless. *Enaliornis* is a form well known from the Cambridge Greensand. They were toothed birds having structural affinities with the Dinosaurs and Pterodactyles.

Fish remains of this period show that a marked change was taking place; teleosteans (with bony internal skeleton) were taking a more prominent place, and although ganoids were still represented (*Macropoma*, *Lepidotus*, *Amiopris*, &c.) they had quite ceased to be the dominant types before the close of Cretaceous times. Sharks and rays were of the modern types, though distinct in species. Amongst the early forms of Cretaceous teleosteans may be mentioned *Elopopsis*, *Ichthyodectes*, *Diplomystus* (herring), *Haplopteryx* and *Urenchelys* (eel).

For further information see the articles CHALK; GREENSAND; WEALDEN. Sir A. Geikie's *Text-book of Geology*, vol. ii. (4th ed., 1903), contains in addition to a full general account of the system very full references to the literature.

**CRETE** (Gr. *Kρήνη*; Turk. *Kırid*, Ital. *Candia*), after Sicily and Sardinia the largest island in the Mediterranean, situated between 34° 50' and 35° 40' N. lat. and between 23° 30' and 26° 20' E. long. Its north-eastern extremity, Cape Sidero, is distant about 110 m. from Cape Krio in Asia Minor, the interval being partly filled by the islands of Carpathos and Rhodes; its north-western, Cape Grabusa, is within 60 m. of Cape Malea in the Morea. Crete thus forms the natural limit between the Mediterranean and the Archipelago. The island is of elongated form; its length from E. to W. is 160 m., its breadth from N. to S. varies from 35 to 7½ m., its area is 3330 sq. m. The northern coast-line is much indented. On the W. two narrow mountainous promontories, the western terminating in Cape Grabusa or Busa

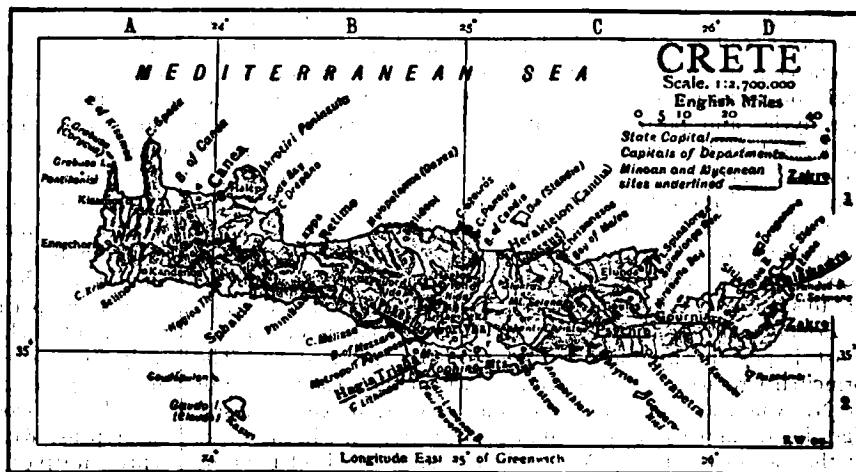

(ancient Corycus), the eastern in Cape Spada, shut in the Bay of Kisamos; beyond the Bay of Canea, to the E., the rocky peninsula of Akrotiri shelters the magnificent natural harbour of Suda (8½ sq. m.), the only completely protected anchorage for large vessels which the island affords. Farther E. are the bays of Candia and Malea, the deep Mirabello Bay and the Bay of Sitia. The south coast is less broken, and possesses no natural harbours, the mountains in many parts rising almost like a wall from the sea; in the centre is Cape Lithinos, the southernmost point of the island, partly sheltering the Bay of Messará on the W. Immediately to the E. of Cape Lithinos is the small bay of Kali Liménes or Fair Havens, where the ship conveying St Paul took refuge (Acts xxvii. 8). Of the islands in the neighbourhood of the Cretan coast the largest is Gavdo (ancient Clauda, Acts

xxvii. 16), about 25 m. from the south coast at Sphakia, in the middle ages the see of a bishop. On the N. side the small island of Dia, or Standia, about 8 m. from Candia, offers a convenient shelter against northerly gales. Three small islands on the northern coast—Grabusa at the N.W. extremity, Suda, at the entrance to Suda harbour, and Spinalonga, in Mirabello Bay—remained for some time in the possession of Venice after the conquest of Crete by the Turks. Grabusa, long regarded as an impregnable fortress, was surrendered in 1692, Suda (where the flags of Turkey and the four protecting powers are now hoisted) and Spinalonga in 1715.

**Natural Features.**—The greater part of the island is occupied by ranges of mountains which form four principal groups. In the western portion rises the massive range of the White Mountains (*Aspra Vosma*), directly overhanging the southern coast with spurs projecting towards the W. and N.W. (highest summit, Hagios Theodoros, 7882 ft.). In the centre is the smaller, almost detached mass of Psiloriti (*Ψιλορείον*, ancient Ida), culminating in Stavros (8193 ft.), the highest summit in the island. To the E. are the Lassithi mountains with Aphenti Christos (7165 ft.), and farther E. the mountains of Sitia with Aphenti Kavousi (4850 ft.). The Kophino mountains (3888 ft.) separate the central plain of Messará from the southern coast. The isolated peak of Iuktas (about 2700 ft.), nearly due S. of Candia, was regarded with veneration in antiquity as the burial-place of Zeus. The principal groups are for the greater part of the year covered with snow, which remains in the deeper clefts throughout the summer; the intervals between them are filled by connecting chains which sometimes reach the height of 3000 ft. The largest plain is that of Monofatsi and Messará, a fertile tract extending between Mt. Psiloriti and the Kophino range, about 37 m. in length and 10 m. in breadth. The smaller plain, or rather slope, adjoining Canea and the valley of Alikianú, through which the Platanos (ancient Iardanos) flows, are of great beauty and fertility. A peculiar feature is presented by the level upland basins which furnish abundant pasturage during the summer months; the more remarkable are the Omalo in the White Mountains (about 4000 ft.) drained by subterranean outlets (*καράβωπα*), Nida (*εὐς τῆς Ἴδας*) in Psiloriti (between 5000 and 6000 ft.), and the Lassithi plain (about 3000 ft.), a more extensive area, on which are several villages. Another remarkable characteristic is found in the deep narrow ravines (*φαράγγια*), bordered by precipitous cliffs, which traverse the mountainous districts; into some of these the daylight scarcely penetrates. Numerous large caves exist in the mountains; among the most remarkable are the famous Idaean cave in Psiloriti, the caves of Melidoni, in Mylopotamo, and Sarchu, in Malevisi, which sheltered hundreds of refugees after the insurrection of 1866, and the Dictæan cave in Lassithi; the birth-place of Zeus. The so-called Labyrinth, near the ruins of Gortyna, was a subterranean quarry from which the city was built. The principal rivers are the Metropoli Potamos and the Anapothiari, which drain the plain of Monofatsi and enter the southern sea E. and W. respectively of the Kophino range; the Platanos, which flows northwards from the White Mountains into the Bay of Canea; and the Mylopotamo (ancient Oaxes) flowing northwards from Psiloriti to the sea E. of Retimo.

**Geology.**—The metamorphic rocks of western Crete form a series some 9000 to 10,000 ft. in thickness, of very varied composition. They include gypsum, dolomite, conglomerates, phyllites, and a basic series of eruptive rocks (gabbros, peridotites, serpentines). Glauconiferous rocks are widely spread. In the centre of the folds fossiliferous beds with crinoids have been found, and the black slates at the top of the series contain *Myophoria* and other fossils, indicating that the rocks are of Triassic age. It is, however, not impossible that the metamorphic series includes also some of the Lias. The later beds of the island belong to the Jurassic, Cretaceous and Tertiary systems. At the western foot of the Ida massif calcareous beds with corals, brachiopods (*Rhynchonella inconstans*, &c.) have been found, the fossils indicating the horizon of the Kimmeridge clay. Lower Cretaceous limestones and schists, with radiolarian cherts, are extensively developed; and in many parts of the island Upper Creta-

ceous limestones with *Rudistes* and Eocene beds with nummulites have been found. All these are involved in the earth movements to which the mountains of the island owe their formation, but the Miocene beds (with *Clypeaster*) and later deposits lie almost undisturbed upon the coasts and the low-lying ground. With the Jurassic beds is associated an extensive series of eruptive rocks (gabbro, peridotite, serpentine, diorite, granite, &c.); they are chiefly of Jurassic age, but the eruptions may have continued into the Lower Cretaceous.

The structure of the island is complex. In the west the folds run from north to south, curving gradually westward towards the southern and western coasts; but in the east the folds appear to run from west to east, and to be the continuation of the Dinaric folds of the Balkan peninsula. The structure is further complicated by a great thrust-plane which has brought the Jurassic and Lower Cretaceous beds upon the Upper Cretaceous and Eocene beds.

**Vegetation.**—The forests which once covered the mountains have for the most part disappeared and the slopes are now desolate wastes. The cypress still grows wild in the higher regions; the lower hills and the valleys, which are extremely fertile, are covered with olive woods. Oranges and lemons also abound, and are of excellent quality, furnishing almost the whole supply of continental Greece and Constantinople. Chestnut woods are found in the Selino district, and forests of the valonia oak in that of Retimo; in some parts the carob tree is abundant and supplies an important article of consumption. Pears, apples, quinces, mulberries and other fruit-trees flourish, as well as vines; the Cretan wines, however, no longer enjoy the reputation which they possessed in the time of the Venetians. Tobacco and cotton succeeded well in the plains and low grounds, though not at present cultivated to any great extent.

**Animals.**—Of the wild animals of Crete, the wild goat or *agrimi* (*Capra aegagrus*) alone need be mentioned; it is still found in considerable numbers on the higher summits of Psiloriti and the White Mountains. The same species is found in the Caucasus and Mount Taurus, and is distinct from the ibex or bouquetin of the Alps. Crete, like several other large islands, enjoys immunity from dangerous serpents—a privilege ascribed by popular belief to the intercession of Titus, the companion of St Paul, who according to tradition was the first bishop of the island, and became in consequence its patron saint. Wolves also are not found in the island, though common in Greece and Asia Minor. The native breed of mules is remarkably fine.

**Population.**—The population of Crete under the Venetians was estimated at about 250,000. After the Turkish conquest it greatly diminished, but afterwards gradually rose, till it was supposed to have attained to about 260,000, of whom about half were Mahomedans, at the time of the outbreak of the Greek revolution in 1821. The ravages of the war from 1821 to 1830, and the emigration that followed, caused a great diminution, and the population was estimated by Pashley in 1836 at only about 130,000. In the next generation it again materially increased; it was calculated by Spratt in 1865 as amounting to 210,000. According to the census taken in 1881, the complete publication of which was interdicted by the Turkish authorities, the population of the island was 279,165, or 35·78 to the square kilometre. Of this total, 141,602 were males, 137,563 females; 33,173 were literate, 242,114 illiterate; 205,010 were orthodox Christians, 73,234 Moslems, and 921 of other religious persuasions. The Moslem element predominated in the principal towns, of which the population was—Candia, 21,368; Canea, 13,812; Retimo, 9274. According to the census taken in June 1900, the population of the island was 301,273, the Christians having increased to 267,266, while the Moslems had diminished to 33,281. The Moslems, as well as the Christians, are of Greek origin and speak Greek.

**Towns.**—The three principal towns are on the northern coast and possess small harbours suitable for vessels of light draught. Candia, the former capital and the see of the archbishop of Crete (pop. in 1900, 22,501), is officially styled Herákleion; it is surrounded by remarkable Venetian fortifications and possesses a museum with a valuable collection of objects found at Cnossus. Phaestus, the Idaean cave and elsewhere. It has been occupied since 1897 by British troops. Canea (Xaviá), the seat of government since 1840 (pop. 20,972), is built in the Italian style; its

<sup>1</sup> See L. Cayeux, "Les Lignes directrices des plissements de l'île de Crète." *C.R. IX. Cong. géol. internat. Vienna*, pp. 383-392 (1904).

walls and interesting galley-slips recall the Venetian period. The residence of the high commissioner and the consulates of the powers are in the suburb of Halepa. Retimo (Ρέθυμνος) is, like Canea, the see of a bishop (pop. 9311). The other towns, Hierapetra, Sitia, Kisamos, Selino and Sphakia, are unimportant.

*Production and Industries.*—Owing to the volcanic nature of its soil, Crete is probably rich in minerals. Recent experiments lead to the conclusion that iron, lead, manganese, lignite and sulphur exist in considerable abundance. Copper and zinc have also been found. A large number of applications for mining concessions have been received since the establishment of the autonomous government. The principal wealth of the island is derived from its olive groves; notwithstanding the destruction of many thousands of trees during each successive insurrection, the production is apparently undiminished, and will probably increase very considerably owing to the planting of young trees and the improved methods of cultivation which the Government is endeavouring to promote. The orange and lemon groves have also suffered considerably, but new varieties of the orange tree are now being introduced, and an impulse will be given to the export trade in this fruit by the removal of the restriction on its importation into Greece. Agriculture is still in a primitive condition; notwithstanding the fertility of the arable land the supply of cereals is far below the requirements of the population. A great portion of the central plain of Monofatsi, the principal grain-producing district, is lying fallow owing to the exodus of the Moslem peasantry. The cultivation of silk cocoons, formerly a flourishing industry, has greatly declined in recent years, but efforts are now being made to revive it. There are few manufactures. Soap is produced at fifteen factories in the principal towns, and there are two distilleries of cognac at Candia.

*Commerce.*—The expansion of Cretan commerce has been retarded by many drawbacks, such as the unsatisfactory condition of the harbours, the want of direct steamship lines to England and other countries, and the deficiency of internal communications. The total value of imports in the four years 1901–1904 was £1,756,888, of exports £1,386,777; excess of imports over exports, £370,111. Exports in 1904 were valued at £419,642, the principal items being agricultural products (oranges, lemons, carobs, almonds, grapes, valonia, &c.), value £153,858, olives and products of olives (oil, soap, &c.), £134,788, and wines and liquors, £48,544. The countries which accept the largest share of Cretan produce are Turkey, England, Egypt, Austria and Russia. Imports in 1904 were valued at £549,665, including agricultural products (mainly flour and corn), value £162,535, and textiles, £129,349. Cereals are imported from the Black Sea and Danube ports, ready-made clothing from Austria and Germany, articles of luxury from Austria and France, and cotton textiles from England. Imports are charged 8%, exports 1% *ad valorem* duty. According to a law published in 1899, Turkish merchandise became subjected to the same rates as that of foreign nations.

*Constitution and Government.*—During the past half-century the affairs of Crete have repeatedly occupied the attention of Europe. Owing to the existence of a strong Mussulman minority among its inhabitants, the warlike character of the natives, and the mountainous configuration of the country, which enabled a portion of the Christian population to maintain itself in a state of partial independence, the island has constantly been the scene of prolonged and sanguinary struggles in which the numerical superiority of the Christians was counterbalanced by the aid rendered to the Moslems by the Ottoman troops. This unhappy state of affairs was aggravated and perpetuated by the intrigues set on foot at Constantinople against successive governors of the island, the conflicts between the Palace and the Porte, the duplicity of the Turkish authorities, the dissensions of the representatives of the great powers, the machinations of Greek agitators, the rivalry of Cretan politicians, and prolonged financial mismanagement. A long series of insurrections—those of 1821, 1833, 1841, 1858, 1866–1868, 1878, 1889 and 1896 may be especially mentioned—culminated in the general rebellion of 1897, which led to the interference of Greece, the intervention of the great powers, the expulsion of the Turkish authorities, and the establishment of an autonomous Cretan government under the suzerainty of the sultan. According to the autonomous constitution of 1899 the supreme power was vested in Prince George of Greece, acting as high commissioner of the protecting powers. The authority thus conferred was confided exclusively to the prince, and was declared liable to modification by law in the case of his successor. The modified constitution of February 1907 curtailed the large exceptional legislative and administrative powers then accorded. The high commissioner is irresponsible,

but his decrees, except in certain specified cases, must be countersigned by a member of his council. He convokes, prorogues and dissolves the chamber, sanctions laws, exercises the right of pardon in case of political offences, represents the island in its foreign relations and is chief of its military forces. The chamber (βουλή), which is elected in the proportion of one deputy to every 5000 inhabitants, meets annually for a session of two months. New elections are held every two years. The chamber exercises a complete financial control, and no taxes can be imposed without its consent. The high commissioner is aided in the administration by a cabinet of three members, styled "councillors" (σύμβουλοι), who superintend the departments of justice, finance, education, public security and the interior. The councillors, who are nominated and dismissed by the high commissioner, are responsible to the chamber, which may impeach them before a special tribunal for any illegal act or neglect of duty.

In general the Cretan constitution is characterized by a conservative spirit, and contrasts with the ultra-democratic systems established in Greece and the Balkan States. A further point of difference is the more liberal payment of public functionaries in Crete. For administrative purposes the departmental divisions existing under the Turkish government have been retained. There are 5 *nomoi* or prefectures (formerly *sanjaks*) each under a prefect (νομάρχος), and 23 eparchies (formerly *kazas*) each under a sub-prefect (ἐπαρχος). All these functionaries are nominated by the high commissioner. The prefects are assisted by departmental councils. The system of municipal and communal government remains practically unchanged. The island is divided into 86 communes, each with a mayor, an assistant-mayor, and a communal council elected by the people. The councils assess within certain limits the communal taxes, maintain roads, bridges, &c., and generally superintend local affairs. Public order is maintained by a force of gendarmerie (χωροφυλακή) organized and at first commanded by Italian officers, who were replaced by Greek officers in December 1906. The constitution authorizes the formation of a militia (πολιτοφυλακή) to be enrolled by conscription, but in existing circumstances the embodiment of this force seems unnecessary.

*Justice.*—The administration of justice is on the French model. A supreme court of appeal, which also discharges the functions of a court of cassation, sits at Canea. There are two assize courts at Canea and Candia respectively with jurisdiction in regard to serious offences (κακούργηματα). Minor offences (πλημμέληματα) and civil causes are tried by courts of first instance in each of the five departments. There are 26 justices of peace, to whose decision are referred slight contraventions of the law (πταίσματα) and civil causes in which the amount claimed is below 600 francs. These functionaries also hold monthly sessions in the various communes. The judges are chosen without regard to religious belief, and precautions have been taken to render them independent of political parties. They are appointed, promoted, transferred or removed by order of the council of justice, a body composed of the five highest judicial dignitaries, sitting at Canea. An order for the removal of a judge must be based upon a conviction for some specified offence before a court of law. The jury system has not been introduced. The Greek penal code has been adopted with some modifications. The Ottoman civil code is maintained for the present, but it is proposed to establish a code recently drawn up by Greek jurists which is mainly based on Italian and Saxon law. The Mussulman cadis retain their jurisdiction in regard to religious affairs, marriage, divorce, the wardship of minors and inheritance.

*Religion and Education.*—The vast majority of the Christian population belongs to the Orthodox (Greek) Church, which is governed by a synod of seven bishops under the presidency of the metropolitan of Candia. The Cretan Church is not, strictly speaking, autocephalous, being dependent on the patriarchate of Constantinople. There were in 1907 3500 Greek churches in the island with 53 monasteries and 3 nunneries; 55 mosques, 4 Roman Catholic churches and 4 synagogues. Education is nominally compulsory. In 1907 there were 547 primary schools (527 Christian and 20 Mahomedan), and 31 secondary schools

(all Christian). About £20,000 is granted annually by the state for the purposes of education.

*Finance.*—Owing to the havoc wrought during repeated insurrections, the impoverishment of the peasants, the desolation of the districts formerly inhabited by the Moslem agricultural population, and the drain of gold resulting from the sale of Moslem lands and emigration of the former proprietors, together with other causes, the financial situation has been unsatisfactory. Notwithstanding the advance of £160,000 made by the four protecting powers after the institution of autonomous government and the profits (£61,937) derived from the issue of a new currency in 1900, there was at the beginning of 1906 an accumulated deficit of £23,470, which represents the floating debt. In addition to the above-mentioned debt to the powers, the state contracted a loan of £60,000 in 1901 to acquire the rights and privileges of the Ottoman Debt, to which the salt monopoly has been conceded for 20 years. In the budgets for 1905 and 1906 considerable economies were effected by the curtailment of salaries, the abolition of various posts, and the reduction of the estimates for education and public works. The estimated revenue and expenditure for 1906 were as follows:—

Revenue.		Expenditure.	
Drachmæ (gold).		Drachmæ (gold).	
Direct taxes	1,494,000	High Commissioner	200,000
Indirect taxes	1,715,000	Financial administration.	694,670
Stamp dues	351,700	Interior (including gendarmerie)	1,678,566
Other sources	780,967	Education and Justice	1,453,500
	<u>4,341,667</u>		<u>4,026,736</u>

The salary of the high commissioner was reduced in 1907 to 100,000 drachmæ.

Improved communications are much needed for the transport of agricultural produce, but the state of the treasury does not admit of more than a nominal expenditure on road-making and other public works. On these the average yearly expenditure between 1898 and 1905 was £13,404. The prosperity of the island depends on the development of agriculture, the acquirement of industrious habits by the people, and the abandonment of political agitation. The Cretans were in 1906 more lightly taxed than any other people in Europe. The tithe had been replaced by an export tax on exported agricultural produce levied at the custom-houses, and the smaller peasant proprietors and shepherds of the mountainous districts were practically exempt from any contribution to the state. The communal tax did not exceed on the average two francs annually for each family. The poorer communes are aided by a state subvention.

(J. D. B.)

*Archæology.*

The recent exploration and excavation of early sites in Crete have entirely revolutionized our knowledge of its remote past, and afforded the most astonishing evidence of the existence of a highly advanced civilization going far back behind the historic period. Great "Minoan" palaces have been brought to light at Cnossus and Phaestus, together with a minor but highly interesting royal abode at Hagia Triada near Phaestus. "Minoan" towns, some of considerable extent, have been discovered at Cnossus itself, at Gournia, Palaikastro, and at Zakro. The cave sanctuary of the Dictæan Zeus has been explored, and throughout the whole length and breadth of the island a mass of early materials has now been collected. The comparative evidence afforded by the discovery of Egyptian relics shows that the Great Age of the Cretan palaces covers the close of the third and the first half of the second millennium before our era. But the contents of early tombs and dwellings and indications supplied by such objects as stone vases and seal-stones show that the Cretans had already attained to a considerable degree of culture, and had opened out communication with the Nile valley in the time of the earliest Egyptian dynasties. This more primitive phase of the indigenous culture, of which several distinct stages are traceable, is known as the Early Minoan, and roughly corresponds with the first half of the third millennium B.C. The succeeding period, to which the first palaces are due and to which the name of Middle Minoan is appropriately given, roughly coincides with the Middle Empire of Egypt. An extraordinary perfection was at this time attained in many branches of art, notably in the painted pottery, often with polychrome decoration, of a class known as "Kamares" from its first discovery in a cave of that name on

Mount Ida. Imported specimens of this ware were found by Flinders Petrie among XIIIth Dynasty remains at Kahun. The beginnings of a school of wall painting also go back to the Middle Minoan period, and metal technique and such arts as gem engraving show great advance. By the close of this period a manufactory of fine faience was attached to the palace of Cnossus. The succeeding Late Minoan period, best illustrated by the later palace at Cnossus and that at Hagia Triada, corresponds in Egypt with the Hyksos period and the earlier part of the New Empire. In the first phase of this the Minoan civilization attains its acme, and the succeeding style already shows much that may be described as rococo. The later phase, which follows on the destruction of the Cnossian palace, and corresponds with the diffused Mycenaean style of mainland Greece and elsewhere, is already partly decadent. Late Minoan art in its finest aspect is best illustrated by the animated ivory figures, wall paintings, and *gesso duro* reliefs at Cnossus, by the painted stucco designs at Hagia Triada, and the steatite vases found on the same site with zones in reliefs exhibiting life-like scenes of warriors, toreadors, gladiators, wrestlers and pugilists, and of a festal throng perhaps representing a kind of "harvest home." Of the more conventional side of Late Minoan life a graphic illustration is supplied by the remains of miniature wall paintings found in the palace of Cnossus, showing groups of court ladies in curiously modern costumes, seated on the terraces and balustrades of a sanctuary. A grand "palace style" of vase painting was at the same time evolved, in harmony with the general decoration of the royal halls.

It had been held till lately that the great civilization of prehistoric Greece, as first revealed to us by Schliemann's discoveries at Mycenæ, was not possessed of the art of writing. In 1893, however, Arthur Evans observed some signs on seal-stones from Crete which led him to believe that a hieroglyphic system of writing had existed in Minoan times. Explorations carried out by him in Crete from 1894 onwards, for the purpose of investigating the prehistoric civilization of the island, fully corroborated this belief, and showed that a linear as well as a semi-pictorial form of writing was diffused in the island at a very early period ("Cretan Pictographs and Pae-Phoenician Script," *Journ. of Hellenic Studies*, xiv. pt. 11). In 1895 he obtained a libation-table from the Dictæan cave with a linear dedication in the prehistoric writing ("Further Discoveries," &c., *J.H.S.* xvii.). Finally in 1900 all scepticism in the learned world was set at rest by his discovery in the palace of Cnossus of whole archives consisting of clay tablets inscribed both in the pictographic (hieroglyphic) and linear forms of the Minoan script (Evans, "Palace of Knossos," *Reports of Excavation, 1900-1905; Scripta Minoa*, vol. i., 1909). Supplementary finds of inscribed tablets have since been found at Hagia Triada (F. Halbherr, *Rapporto, &c., Monumenti antichi*, 1903) and elsewhere (Palaikastro, Zakro and Gournia). It thus appears that a highly developed system of writing existed in Minoan Crete some two thousand years earlier than the first introduction under Phoenician influence of Greek letters. In this, as in so many other respects, the old Cretan tradition receives striking confirmation. According to the Cretan version preserved by Diodorus (v. 74), the Phoenicians did not invent letters but simply altered their forms.

There is evidence that the use in Crete of both linear and pictorial signs existed in the Early Minoan period, contemporary with the first Egyptian dynasties. It is, however, during the Middle Minoan age, the centre point of which corresponds with the XIIth Egyptian dynasty, according to the Sothic system of dating, c. 2000-1850 B.C., that a systematized pictographic or hieroglyphic script makes its appearance which is common both to signets and clay tablets. During the Third Middle Minoan period, the lower limits of which approach 1600 B.C., this pictographic script finally gives way to a still more developed linear system—which is itself divided into an earlier and a later class. The earlier class (A) is already found in the temple repositories of Cnossus belonging to the age immediately preceding the great remodelling of the

*Minoan script.*

*Earlier pictographic script.*

palace, and this class is specially well represented in the tablets of Hagia Triada (M.M. iii. and L.M. i.). The later class (B) of the linear script is that used on the great bulk of the clay tablets of the Cnossian palace, amounting in number to nearly 2000.

These clay archives are almost exclusively inventories and business documents. Their general purport is shown in many cases by pictorial figures relating to various objects which appear on them—such as chariots and horses, ingots and metal vases, arms and implements, stores of corn, &c., flocks and herds. Many showing human figures apparently contain lists of personal names. A decimal system of numeration was used, with numbers going up to 10,000. But the script itself is as yet undeciphered, though it is clear that certain words have changing suffixes, and that there were many compound words. The script also recurs on walls in the shape of graffiti, and on vases, sometimes ink-written; and from the number of seals originally attached to perishable documents it is probable that parchment or some similar material was also used. In the easternmost district of Crete, where the aboriginal "Eteocretan" element survived to historic times (Praesus, Palaikastro), later inscriptions have been discovered belonging to the 5th and succeeding centuries B.C., written in Greek letters but in the indigenous language (Comparetti, *Mon. Ant.* iii. 451 sqq.; R. S. Conway, *British School Annual*, viii. 125 sqq. and *ib.* xl.). In 1908 a remarkable discovery was made by the Italian Mission at Phaestus of a clay disk with imprinted hieroglyphic characters belonging to a non-Cretan system and probably from W. Anatolia.

The remains of several shrines within the building, and the religious element perceptible in the frescoes, show that a considerable part of the Palace of Cnossus was devoted to purposes of cult. It is clear that the rulers, as so commonly in ancient states, fulfilled priestly as well as royal functions. The evidence supplied by this and other Cretan sites shows that the principal Minoan divinity was a kind of *Magna Mater*, a Great Mother or nature goddess, with whom was associated a male satellite. The cult in fact corresponds in its main outlines with the early religious conceptions of Syria and a large part of Anatolia—a correspondence probably explained by a considerable amount of ethnic affinity existing between a large section of the primitive Cretan population and that of southern Asia Minor. The Minoan goddess is sometimes seen in her chthonic form with serpents, sometimes in a more celestial aspect with doves, at times with lions. One part of her religious being survives in that of the later Rhea, another in that of Aphrodite, one of whose epithets, *Ariadne* (=the exceeding holy), takes us back to the earliest Cnossian tradition. Under her native name, Britomartis (=the sweet maiden) or Dictynna, she approaches Artemis and Leto, again associated with an infant god, and this Cretan virgin goddess was worshipped in Aegina under the name of Aphaea. It is noteworthy that whereas, in Greece proper, Zeus attains a supreme position, the old superiority of the Mother Goddess is still visible in the Cretan traditions of Rhea and Dictynna and the infant Zeus.

Although images of the divinities were certainly known, the principal objects of cult in the Minoan age were of the aniconic class; in many cases these were natural objects, such as rocks and mountain peaks, with their cave sanctuaries, like those of Ida or of Dicte. Trees and curiously shaped stones were also worshipped, and artificial pillars of wood or stone. These latter, as in the well-known case of the Lion's Gate at Mycenae, often appear with guardian animals as their supporters. The essential feature of this cult is the bringing down of the celestial spirit by proper incantations and ritual into these fetish objects, the dove perched on a column sometimes indicating its descent. It is a primitive cult similar to that of Early Canaan, illustrated by the pillow stone set up by Jacob, which was literally "Bethel" or the "House of God." The story of the *baetylus*, or stone swallowed by Saturn under the belief that it was his son, the Cretan Zeus, seems to cover the same idea and has been derived from the same Semitic word.

A special form of this "baetylic" cult in Minoan Crete was the

representation of the two principal divinities in their fetish form by double axes. Shrines of the Double Axes have been found in the palace of Cnossus itself, at Hagia Triada, and in a small palace at Gournia, and many specimens of the sacred emblem occurred in the Cave Sanctuary of Dicte, the mythical birthplace of the Cretan Zeus. Complete scenes of worship in which libations are poured before the Sacred Axes are, moreover, given on a fine painted sarcophagus found at Hagia Triada.

The same cult survived to later times in Caria in the case of Zeus Labrandeus, whose name is derived from *labrys*, the native name for the double axe, and it had already been suggested on philological grounds that the Cretan "labyrinthos" was formed from a kindred form of the same word. The discovery that the great Minoan foundation at Cnossus was at once a palace and a sanctuary of the Double Axe and its associated divinities has now supplied a striking and it may well be thought an overwhelming confirmation of this view. We can hardly any longer hesitate to recognize in this vast building, with its winding corridors and subterranean ducts, the Labyrinth of later tradition; and as a matter of fact a maze pattern recalling the conventional representation of the Labyrinth in Greek art actually formed the decoration of one of the corridors of the palace. It is difficult, moreover, not to connect the repeated wall-paintings and reliefs of the palace illustrating the cruel bull sports of the Minoan arena, in which girls as well as youths took part, with the legend of the Minotaur, or bull of Minos, for whose grisly meals Athens was forced to pay annual tribute of her sons and daughters. It appears certain from the associations in which they are found at Cnossus, that these Minoan bull sports formed part of a religious ceremony. Actual figures of a monster with a bull's head and man's body occurred on seals of Minoan fabric found on this and other Cretan sites.

It is abundantly evident that whatever mythic element may have been interwoven with the old traditions of the spot, they have a solid substratum of reality. With such remains before us it is no longer sufficient to relegate Minos to the regions of sun-myths. His legendary presentation as the "Friend of God," like Abraham, to whom as to Moses the law was revealed on the holy mountain, calls up indeed just such a priest-king of antiquity as the palace-sanctuary of Cnossus itself presupposes. It seems possible even that the ancient tradition which recorded an earlier or later king of the name of Minos may, as suggested above, cover a dynastic title. The earlier and later palaces at Cnossus and Phaestus, and the interrupted phases of each, seem to point to a succession of dynasties, to which, as to its civilization as a whole, it is certainly convenient to apply the name "Minoan." It is interesting, as bringing out the personal element in the traditional royal seat, that an inscribed sealing belonging to the earliest period of the later palace of Cnossus bears on it the impression of two official signets with portrait heads of a man and of a boy, recalling the "associations" on the coinage of imperial Rome. It is clear that the later traditions in many respects accurately summed up the performances of the "Minoan" dynast who carried out the great buildings now brought to light. The palace, with its wonderful works of art, executed for Minos by the craftsman Daedalus, has ceased to belong to the realms of fancy. The extraordinary architectural skill, the sanitary and hydraulic science revealed in details of the building, bring us at the same time face to face with the power of mechanical invention with which Daedalus was credited. The elaborate method and bureaucratic control visible in the clay documents of the palace point to a highly developed legal organization. The powerful fleet and maritime empire which Minos was said to have established will no doubt receive fuller illustration when the sea-town of Cnossus comes to be explored. The appearance of ships on some of the most important seal-impressions is not needed, however, to show how widely Minoan influence made itself felt in the neighbouring Mediterranean regions.

The Nilotic influence visible in the vases, seals and other fabrics of the Early Minoan age, seems to imply a maritime

Character  
of Minoan  
religion.

Labyrinth  
and  
Minotaur.

Historic  
sub-  
stratum of  
Cretan  
myths.



activity on the part of the islanders going back to the days of the first Egyptian dynasties. In a deposit at Kahun, belonging to the XIIth Dynasty, c. 2000 B.C., were already found

*Early relations with Egypt.*

imported polychrome vases of "Middle Minoan" fabric. In the same way the important part played by Cretan enterprise in the days of the New Egyptian empire is illustrated by repeated finds of Late Minoan pottery on Egyptian sites. A series of monuments, moreover, belonging to the early part of the XVIIIth Dynasty show the representatives of the Kefts or peoples of "The Ring" and of the "Lands to the West" in the fashionable costume of the Cnossian court, bearing precious vessels and other objects of typical Minoan forms. Farther to the east

*The Kefts and Philistines.*

the recent excavations on the old Philistine sites like Gezer have brought to light swords and vases of Cretan manufacture in the later palace style. The principal Philistine tribe is indeed known in the biblical records as the Cherethims or Cretans, and the Minoan name and the cult of the Cretan Zeus were preserved at Gaza to the latest classical days. Similar evidence of Minoan contact, and indeed of wholesale colonization from the Aegean side, recurs in Cyprus. The culture of the more northerly Aegean islands, best revealed to us by the excavations of the British School at Phylakopi in Melos, also attest a growing influence from the Cretan side, which, about the time of the later palace at Cnossus, becomes finally predominant.

*Early relations with Cyprus and N. Aegean.*

Turning to the mainland of Greece we see that the astonishing remains of a highly developed prehistoric civilization, which Schliemann first brought to light in 1876 at Mycenae, and which from those discoveries received the general name of "Mycenaean," in the main represent a general marine offshoot from the Minoan stock. The earlier remains both at Mycenae and Tiryns, still imperfectly investigated, show that this Cretan influence goes back to the Middle Minoan age, with its characteristic style of polychrome vase decoration. The contents of the royal tombs, on the other hand, reveal a wholesale correspondence with the fabrics of the first, and, to a less degree, the second Late Minoan age, as illustrated by the relics belonging to the Middle Period of the later palace at Cnossus and by those of the royal villa at Hagia Triada. The chronological centre of the great beehive tombs seems to be slightly lower. The ceiling of that of Orchomenos, and the painted vases and gold cups from the Vaphio tomb by Sparta, with their marvellous reliefs showing scenes of bull-hunting, represent the late palace style at Cnossus in its final development.

*Minoan influence on mainland of Greece.*

The leading characteristics of this mainland civilization are thus indistinguishable from the Minoan. The funeral rites are similar, and the religious representations show an identical form of worship. At the same time the local traditions and conditions differentiate the continental from the insular branch. In Crete, in the later period, when the rulers could trust to the "wooden walls" of the Minoan navy, there is no parallel for the massive fortifications that we see at Tiryns or Mycenae. The colder winter climate of mainland Greece dictated the use of fixed hearths, whereas in the Cretan palaces these seem to have been of a portable kind, and the different usage in this respect again reacted on the respective forms of the principal hall or "Megaron."

The Minoan culture under its mainland aspect left its traces on the Acropolis at Athens,—a corroboration of the tradition which made the Athenians send their tribute children to Minos. Similar traces extend through a large part of northern Greece from Cephallenia and Leucadia to Thessaly, and are specially well marked at Iolcus (near mod. Volo), the legendary embarking place of the Argonauts. This circumstance deserves attention owing to the special connexion traditionally existing between the Minyans of Iolcus and those of Orchomenos, the point of all others on this side where the early Cretan influence seems most to have taken root. The Minoan remains at Orchomenos which are traceable to the latest period go far to substantiate the philological comparison between the name of Minyas, the traditional ancestor of this ancient race, and that of Minos.

Minoan culture under its mainland aspect left its traces on the Acropolis at Athens,—a corroboration of the tradition which made the Athenians send their tribute children to Minos.

*Minoan influences in N. Greece.*

Similar traces extend through a large part of northern Greece from Cephallenia and Leucadia to Thessaly, and are specially well marked at Iolcus (near mod. Volo), the legendary embarking place of the Argonauts. This circumstance deserves attention owing to the special connexion traditionally existing between the Minyans of Iolcus and those of Orchomenos, the point of all others on this side where the early Cretan influence seems most to have taken root. The Minoan remains at Orchomenos which are traceable to the latest period go far to substantiate the philological comparison between the name of Minyas, the traditional ancestor of this ancient race, and that of Minos.

Still farther to the north-west a distinct Minoan influence is perceptible in the old Illyrian lands east of the Adriatic, and its traces reappear in the neighbourhood of Venice. It is well marked throughout southern Italy from Taranto to Naples. It was with Sicily, however, that the later history of Minos and his great craftsman Daedalus was in a special way connected by ancient tradition. Here, as in Crete, Daedalus executed great works like the temple of Eryx, and it was on Sicilian soil that Minos, engaged in a western campaign, was said to have met with a violent death at the hands of the native king Kokalos (Cocalus) and his daughters. His name is preserved in the Sicilian Minoa, and his tomb was pointed out in the neighbourhood of Agrigentum, with a shrine above dedicated to his native Aphrodite, the lady of the dove; and in this connexion it must be observed that the cult of Eryx perpetuates to much later times the characteristic features of the worship of the Cretan Nature goddess, as now revealed to us in the palace of Cnossus and elsewhere. These ancient indications of a Minoan connexion with Sicily have now received interesting confirmation in the numerous discoveries, principally due to the recent excavations of P. Orsi, of arms and painted vases of Late Minoan fabric in Bronze Age tombs of the provinces of Syracuse and Girgenti (Agrigentum) belonging to the late Bronze Age. Some of these objects, such as certain forms of swords and vases, seem to be of local fabric, but derived from originals going back to the beginning of the Late Minoan age.

*Adriatic and Italian extension.*

The abiding tradition of the Cretan aborigines, as preserved by Herodotus (vii. 171), ascribes the eventual settlement of the Greeks in Crete to a widespread desolation that had fallen on the central regions. It is certain that by the beginning of the 14th century B.C., when the signs of already decadent Minoan art are perceptible in the imported pottery found in the palace of Akhenaton at Tell el-Amarna, some heavy blows had fallen on the island power. Shortly before this date the palaces both of Cnossus and Phaestus had undergone a great destruction, and though during the ensuing period both these royal residences were partially reoccupied it was for the most part at any rate by poorer denizens, and their great days as palaces were over for ever. Elsewhere at Cnossus, in the smaller palace to the west, the royal villa and the town houses, we find the evidence of a similar catastrophe followed by an imperfect recovery, and the phenomenon meets us again at Palaikastro and other early settlements in the east of Crete. At the same time, to whatever cause this serious setback of Minoan civilization was owing, it would be very unsafe to infer as yet any large displacement of the original inhabitants by the invading swarms from the mainland or elsewhere. The evidence of a partial restoration of the domestic quarter of the palace of Cnossus tends to show a certain measure of dynastic continuity. There is evidence, moreover, that the script and with it the indigenous language did not die out during this period, and that therefore the days of Hellenic settlement at Cnossus were not yet. The recent exploration of a cemetery belonging to the close of the great palace period, and in a greater degree to the age succeeding the catastrophe, has now conclusively shown that there was no real break in the continuity of Minoan culture. This third Late Minoan period—the beginning of which may be fixed about 1400—is an age of stagnation and decline, but the point of departure continued to be the models supplied by the age that had preceded it. Art was still by no means extinct, and its forms and decorative elements are simply later derivatives of the great palace style. Not only the native form of writing, but the household arrangements, sepulchral usages, and religious rites remain substantially the same. The third Late Minoan age corresponds generally with the Late Mycenaean stage in the Aegean world (see AEGEAN CIVILIZATION). It is an age indeed in which the culture as a whole, though following a lower level, attains the greatest amount of uniformity. From Sicily and even the Spanish coast to the Troad, southern Asia Minor, Cyprus and Palestine,—from the Nile valley to the mouth of the Po, very similar forms were now diffused. Here and there, as in Cyprus, we watch the development of some local schools. How far Crete

*Minoan crisis: c. 1400 B. C.*

itself continued to preserve the hegemony which may reasonably be ascribed to it at an earlier age must remain doubtful. It is certain that towards the close of this third and concluding Late Minoan period in the island certain mainland types of swords and safety-pins make their appearance, which are symptomatic of the great invasion from that side that was now impending or had already begun.

#### *Principal Minoan Sites.*

It will be convenient here to give a general view of the more important Minoan remains recently excavated on various Cretan sites.

**Cnossus.**—The palace of Cnossus is on the hill of Kephala about 4 m. inland from Candia. As a scene of human settlement this site is of immense antiquity. The successive "Minoan" strata, which go well back into the fourth millennium B.C., reach down to a depth of about 17 ft. But below this again is a human deposit, from 20 to 26 ft. in thickness, representing a long and gradual course of Neolithic or Later Stone-Age development. Assuming that the lower strata were formed at approximately the same rate as the upper, we have an antiquity of from 12,000 to 14,000 years indicated for the first Neolithic settlement on this spot. The hill itself, like a Tell of Babylonia, is mainly formed of the debris of human settlements. The palace was approached from the west by a paved Minoan Way communicating with a considerable building on the opposite hill. This road was flanked by magazines, some belonging to the royal armoury, and abutted on a paved area with stepped seats on two sides (theatral area). The palace itself approximately formed a square with a large paved court in the centre. It had a N.S. orientation. The principal entrance was to the north, but what appears to have been the royal entrance opened on a paved court on the west side. This entrance communicated with a corridor showing frescoes of a processional character. The west side of the palace contained a series of 18 magazines with great store jars and cists and large boards of clay documents. A remarkable feature of this quarter is a small council chamber with a gypsum throne of curiously Gothic aspect and lower stone benches round. The walls of the throne room show frescoes with sacred griffins confronting each other in a Nile landscape, and a small bath chamber—perhaps of ritual use—is attached. This quarter of the palace shows the double axe sign constantly repeated on its walls and pillars, and remains of miniature wall-paintings showing pillar shrines, in some cases with double axes stuck into the wooden columns. Here too were found the repositories of an early shrine containing exquisite faience figures and reliefs, including a snake goddess—another aspect of the native divinity—and her votaries. The central object of cult in this shrine was apparently a marble cross. Near the north-west angle of the palace was a larger bath chamber, and by the N. entrance were remains of great reliefs of bull-hunting scenes in painted *gesso duro*. South of the central court were found parts of a relief in the same material, showing a personage with a fleur-de-lis crown and collar. The east wing of the palace was the really residential part. Here was what seems to have been the basement of a very large hall or "Megaron," approached directly from the central court, and near this were found further reliefs, fresco representations of scenes of the bull-ring with female as well as male toredors, and remains of a magnificent gaming-board of gold-plated ivory with intarsia work of crystal plaques set on silver plates and blue enamel (*cyanus*). The true domestic quarter lay to the south of the great hall, and was approached from the central court by a descending staircase, of which three flights and traces of a fourth are preserved. This gives access to a whole series of halls and private rooms (halls "of the Colonnades," "of the Double Axes," "Queen's Megaron" with bath-room attached and remains of the fish fresco, "Treasury" with ivory figures and other objects of art), together with extensive remains of an upper storey. The drainage system here, including a water-closet, is of the most complete and modern kind. Near this domestic quarter was found a small shrine of the Double Axes, with cult objects and offertory vessels in their places. The traces of an earlier "Middle Minoan" palace beneath the later floor-levels are most visible on the east side, with splendid ceramic remains. Here also are early magazines with huge store jars. At the foot of the slope on this side, forming the eastern boundary of the palace, are massive supporting walls and a bastion with descending flights of steps, and a water-channel devised with extraordinary hydraulic science (Evans, "Palace of Knossos," "Reports of Excavations 1900-1905," in *Annual of British School at Athens*, vi. sqq.; *Journ. R.I.B.A.* (1902), pt. iv. For the palace pottery see D. Mackenzie, *Journ. of Hellenic Studies*, xxiii.). The palace site occupies nearly six acres. To the N.E. of it came to light a "royal villa" with staircase, and a basilica-like hall (Evans, *B.S. Annual*, ix. 130 seq.). To the N.W. was a dependency containing an important hoard of bronze vessels (*ib.* p. 112 sqq.). The building on the hill to the W. approached by the Minoan paved way has the appearance of a smaller palace (*B.S. Annual*, xii., 1906). Many remains of private houses belonging to the prehistoric town have also come to light (Hogarth, *B.S.A.* vi. [1900], p. 70 sqq.). A little N. of the town, at a spot called Zafer

Papoura, an extensive Late Minoan cemetery was excavated in 1904 (Evans, *The Prehistoric Tombs of Knossos*, 1906), and on a height about 2 m. N. of this, a royal tomb consisting of a square chamber, which originally had a pointed vault of "Cyclopaean" structure approached by a forehall or rock-cut passage. This monumental work seems to date from the close of the Middle Minoan age, but has been re-used for interments at successive periods (Evans, *Archaeologia*, 1906, p. 136 sqq.). It is possibly the traditional tomb of Idomeneus. (For later discoveries see further CNOSSUS.)

**Phaestus.**—The acropolis of this historic city looks on the Libyan Sea and commands the extensive plain of Messara. On the eastern hill of the acropolis, excavations initiated by F. Halbherr on behalf of the Italian Archaeological Mission and subsequently carried out by L. Pernier have brought to light another Minoan palace, much resembling on a somewhat smaller scale that of Cnossus. The plan here too was roughly quadrangular with a central court, but owing to the erosion of the hillside a good deal of the eastern quarter has disappeared. The Phaestian palace belongs to two distinct periods, and the earlier or "Middle Minoan" part is better preserved than at Cnossus. The west court and entrance belonging to the earlier building show many analogies with those of Cnossus, and the court was commanded to the north by tiers of stone benches like those of the "theatral area" at Cnossus on a larger scale. Magazines with fine painted store jars came to light beneath the floor of the later "propylaeum." The most imposing block of the later building is formed by a group of structures rising from the terrace formed by the old west wall. A fine paved corridor running east from this gives access to a line of the later magazines, and through a columnar hall to the central court beyond, while to the left of this a broad and stately flight of steps leads up to a kind of entrance hall on an upper terrace. North of the central court is a domestic quarter presenting analogies with that of Cnossus, but throughout the later building there was a great dearth of the frescoes and other remains such as invest the Cnossian palace with so much interest. There are also few remaining traces here of upper storeys. It is evident that in this case also the palace was overtaken by a great catastrophe, followed by a partial reoccupation towards the close of the Late Minoan age (L. Pernier, *Scavi della missione italiana a Phaestos; Monumenti antichi*, xii. and xiv.).

About a kilometre distant from the palace of Phaestus near the village of Kalyvia a Late Minoan cemetery was brought to light in 1901, belonging to the same period as that of Cnossus (Savignoni, *Necropoli di Phaestos*, 1905).

**Hagia Triada.**—On a low hill crowned by a small church of the above name, about 3 m. nearer the Libyan Sea than Phaestus, a small palace or royal villa was discovered by Halbherr and excavated by the Italian Mission. In its structure and general arrangements it bears a general resemblance to the palace of Phaestus and Cnossus on a smaller scale. The buildings themselves, with the usual halls, bath-rooms and magazines, together with a shrine of the Mother Goddess, occupy two sides of a rectangle, enclosing a court at a higher level approached by flights of stairs. Repositories also came to light containing treasure in the shape of bronze ingots. In contrast to the palace of Phaestus, the contents of the royal villa proved exceptionally rich, and derive a special interest from the fact that the catastrophe which overwhelmed the building belongs to a somewhat earlier part of the Late Minoan age than that which overwhelmed Cnossus and Phaestus. Clay tablets were here found belonging to the earlier type of the linear script (Class A), together with a great number of clay sealings with religious and other devices and incised countermarks. Both the signet types and the other objects of art here discovered display the fresh naturalism that characterizes in a special way the first Late Minoan period. A remarkable wall-painting depicts a cat creeping over ivy-covered rocks and about to spring on a pheasant. The steatite vases with reliefs are of great importance. One of these shows a ritual procession, apparently of reapers singing and dancing to the sound of a *sistrum*. On another a Minoan warrior prince appears before his retainers. A tall funnel-shaped vase of this class, of which a considerable part has been preserved, is divided into zones showing bull-hunting scenes, wrestlers and pugilists in gladiatorial costume, the whole executed in a most masterly manner. The small palace was reconstructed at a later period, and at a somewhat higher level. To a period contemporary with the concluding age of the Cnossian palace must be referred a remarkable sarcophagus belonging to a neighbouring cemetery. The chest is of limestone coated with stucco, adorned with life-like paintings of offertory scenes in connexion with the sacred Double Axes of Minoan cult. There have also come to light remains of a great domed mortuary chamber of primitive construction containing relics of the Early Minoan period (Halbherr, *Monumenti Antichi*, xiii. (1903), p. 6 sqq., and *Memorie del istituto lombardo*, 1905; Paribeni, *Lavori eseguiti della missione italiana nel Palazzo e nella necropoli di Hagia Triada; Rendiconti*, &c., xi. and xii.; Savignoni, *Il Vaso di Hagia Triada*).

**Palatkaastro.**—Near this village, lying on the easternmost coast of Crete, the British School at Athens has excavated a section of a considerable Minoan town. The buildings here show a stratification analogous to that of the palace of Cnossus. The town was traversed by a well-paved street with a stone sewer, and contained several important private houses and a larger one which seems to have been

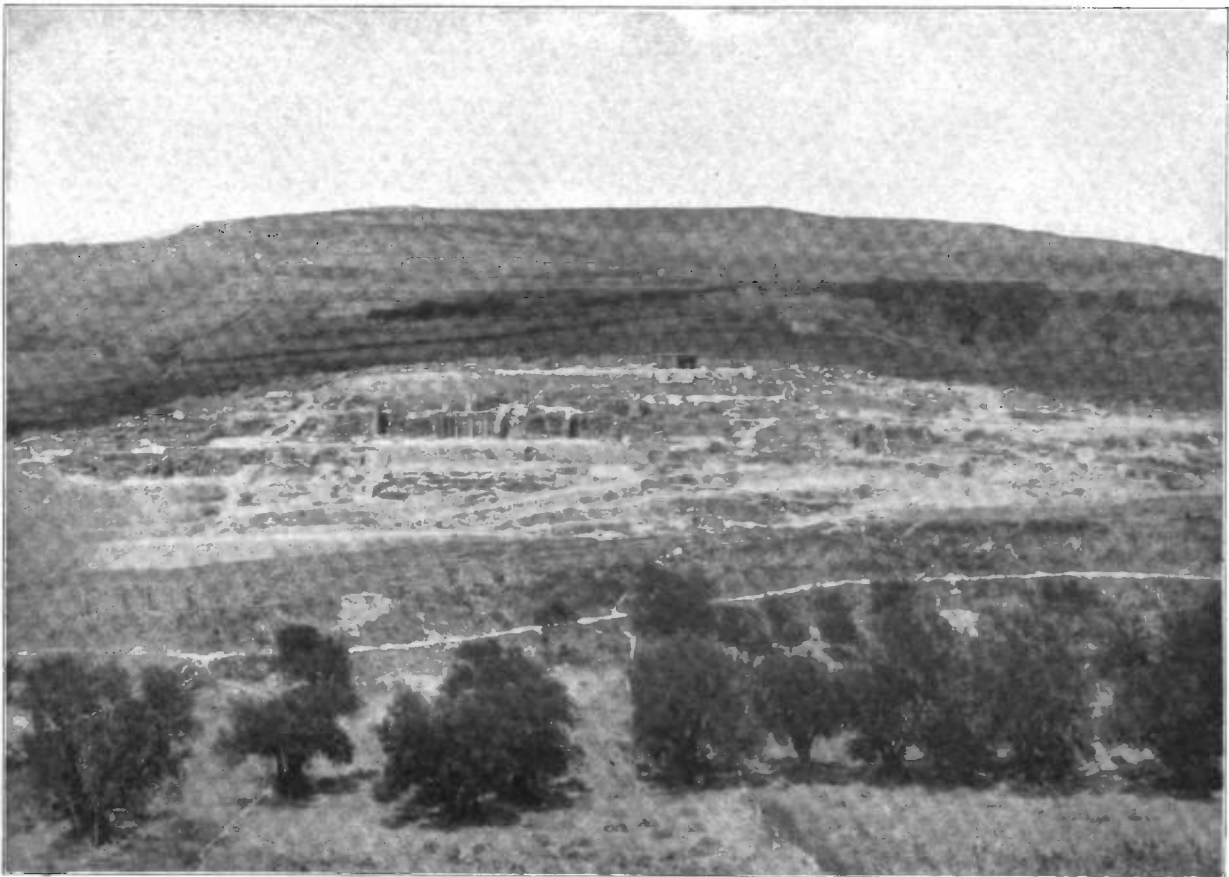

FIG. 1.—PALACE OF CNOSSUS. GENERAL VIEW OF THE SITE FROM THE EAST.

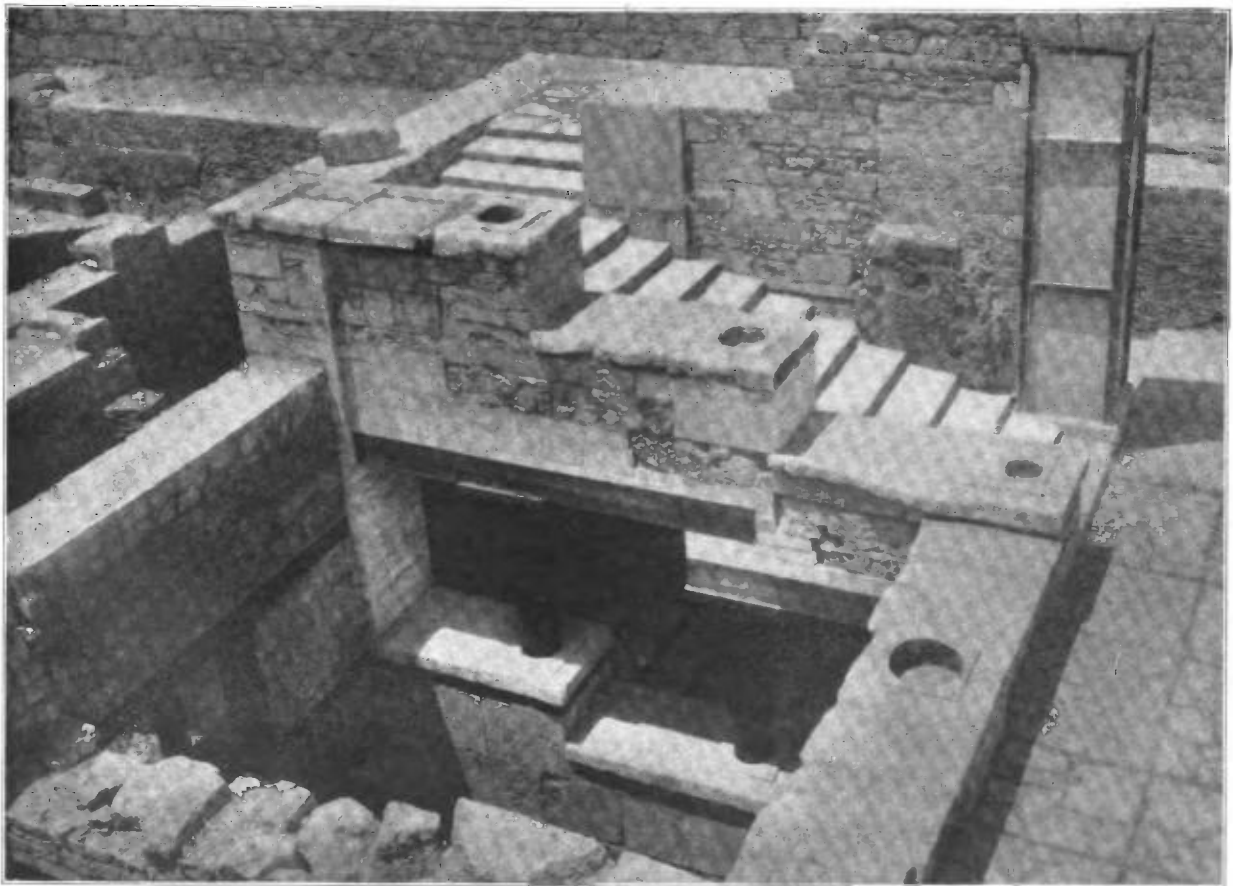

FIG. 2.—VIEW OF PART OF GRAND STAIRCASE AND HALL OF COLONNADES  
(WOODEN COLUMNS RESTORED) (CNOSSUS).  
*(By permission of Dr A. J. Evans.)*



FIG. 3.—LARGE OIL-JARS IN EAST MAGAZINES (CNOSSUS).



FIG. 4.—GYPSUM THRONE (FRESCO PAINTING VISIBLE ON WALL) (CNOSSUS).



FIG. 5.—BASE OF WEST WALL NEAR ROYAL ENTRANCE (CNOSSUS).

(By permission of Dr A. J. Evans.)



a small palace. Among the more interesting relics found were ivory figures of Egyptian or strongly Egyptianizing fabric. On an adjacent hill were the remains of what seems to have been in later times a temple of the Dictæan Zeus, and from the occurrence of rich deposits of Minoan vases and sacrificial remains at a lower level, the religious tradition represented by the later temple seems to go back to prehistoric times. On the neighbouring height of Petsofa, by a rock-shelter, remains of another interesting shrine were brought to light dating from the Middle Minoan period, and containing interesting votive offerings of terra-cotta, many of them apparently relating to cures or to the warding off of diseases (R. C. Bosanquet, *British School Annual*, viii. 286 sqq., ix. 274 sqq.; R. M. Dawkins, *ibid.* ix. 290 sqq., x.; J. L. Myres, *ibid.* ix. 356 sqq.).

**Gournia.**—Near this hamlet on the coast of the Gulf of Mirabello in east Crete, the American archaeologist Miss Harriet Boyd has excavated a great part of another Minoan town. It covers the sides of a long hill, its main avenue being a winding roadway leading to a small palace. It contained a shrine of the Cretan snake goddess, and was rich in minor relics, chiefly in the shape of bronze implements and pottery for household use. The bulk of the remains belong here, as at Hagia Triada, to the beginning of the Late Minoan period, but there are signs of reoccupation in the decadent Minoan age. The remains supply detailed information as to the everyday life of a Cretan country town about the middle of the second millennium B.C. (H. Boyd, *Excavations at Gournia*).

**Zakro.**—Near the lower hamlet of that name on the S.E. coast important remains of a settlement contemporary with that of Gournia were explored by D. G. Hogarth, consisting of houses and pits containing painted pottery of exceptional beauty and a great variety of seal impressions. The deep bay in which Zakro lies is a well-known port of call for the fishing fleets on their way to the sponge grounds of the Libyan coast, and doubtless stood in the same stead to the Minoan shipping (D. G. Hogarth, *Annual of the British School*, vii. 121 sqq., and *Journal of Hellenic Studies*, xxii. 76 sqq. and 333 sqq.).

**Dictæan Cave.**—Near the village of Psychro on the Lassithi range, answering to the western Dicte, opens a large cave, identified with the legendary birthplace of the Cretan Zeus. This cavern also shared with that of Ida the claim to have been that in which Minos, Moses-like, received the law from Zeus. The exploration begun by the Italian Mission under Halbherr and continued by Evans, who found here the inscribed libation table (see above), was completed by Hogarth in 1900. Besides the great entrance hall of the cavern, which served as the upper shrine, were descending vaults forming a lower sanctuary going down deep into the bowels of the earth. Great quantities of votive figures and objects of cult, such as the fetish double-axes and stone tables of offering, were found both above and below. In the lower sanctuary the natural pillars of stalagmite had been used as objects of worship, and bronze votive objects thrust into their crevices (Halbherr, *Museo di antichità classica*, ii. pp. 906-910; Evans, *Further Discoveries*, &c., p. 350 sqq., *Myc. Tree and Pillar Cult*, p. 14 sqq.; Hogarth, "The Dictæan Cave," *Annual of British School at Athens*, vi. 94 sqq.).

**Pseira and Mochlos.**—On these two islets on the northern coast of E. Crete, R. Seager, an American explorer, has found striking remains of flourishing Minoan settlements. The contents of a series of tombs at Mochlos throw an entirely new light on the civilization of the Early Minoan age.

The above summary gives, indeed, a very imperfect idea of the extent to which the remains of the great Minoan civilization are spread throughout the island. The "hundred cities" ascribed to Crete by Homer are in a fair way of becoming an ascertained reality. The great days of Crete lie thus beyond the historic period. The period of decline referred to above (Late Minoan III.), which begins about the beginning of the 14th century before our era, must, from the abundance of its remains, have been of considerable duration. As to the character of the invading elements that hastened its close, and the date of their incursions, contemporary Egyptian monuments afford the best clue. The Keftiu who represented Minoan culture in Egypt in the concluding period of the Cnossian palace (Late Minoan II.) cease to appear on Egyptian monuments towards the end of the XVIIIth Dynasty (c. 1350 B.C.), and their place is taken by the "Peoples of the Sea." The Achæans, under the name *Akaiusha*, already appear among the piratical invaders of Egypt in the time of Rameses III. (c. 1200 B.C.) of the XXth Dynasty (see H. R. Hall, "Keftiu and the Peoples of the Sea," *Annual of British School at Athens*, viii. 157 sqq.).

About the same time the evidences of imports of Late Minoan or "Mycenaean" fabrics in Egypt definitely cease. In the *Odyssey* we already find the Achæans together with Dorians settled in central Crete. In the extreme east and west of the island the aboriginal

"Eteocretan" element, however, as represented respectively by the Praesians or Cydonians, still held its own, and inscriptions written in Greek characters show that the old language survived to the centuries immediately preceding the Christian era.

The mainland invasions which produced these great ethnic changes in Crete are marked archaeologically by signs of widespread destruction and by a considerable break in the continuity of the insular civilization. New burial customs, notably the rite of cremation in place of the older corpse-burial, are introduced, and in many cases the earlier tombs were pillaged and re-used by new comers. The use of iron for arms and implements now finally triumphed over bronze. Northern forms of swords and safety-pins are now found in general use. A new geometrical style of decoration, like that of contemporary Greece largely supplants the Minoan models. The civic foundations which belong to this period, and which include the greater part of the massive ruins of Goulas and Anavlachos in the province of Mirabello and of Hyrtakina in the west, affect more or less precipitous sites and show a greater tendency to fortification. The old system of writing now dies out, and it is not till some three centuries later that the new alphabetic forms are introduced from a Semitic source. The whole course of the older Cretan civilization is awhile interrupted, and is separated from the new by the true dark ages of Greece.

It is nevertheless certain that some of the old traditions were preserved by the remnants of the old population now reduced to a subject condition, and that these finally leavened the whole lump, so that once more—this time under a Hellenic guise—Crete was enabled to anticipate mainland Greece in nascent civilization. Already in 1883 A. Milchhöfer (*Anfänge der Kunst*) had called attention to certain remarkable examples of archaic Greek bronze-work, and the subsequent discovery of the votive bronzes in the cave of Zeus on Mount Ida, and notably the shields with their fine embossed designs, shows that by the 8th century B.C. Cretan technique in metal not only held its own beside imported Cypro-Phoenician work, but was distinctly ahead of that of the rest of Greece (Halbherr, *Bronzi delantro di Zeus Ideo*). The recent excavations by the British School on the site of the Dictæan temple at Palaikastro bear out this conclusion, and an archaic marble head of Apollo found at Eleutherna shows that classical tradition was not at fault in recording the existence of a very early school of Greek sculpture in the island, illustrated by the names of Dipoenos and Scyllis.

The Dorian dynasts in Crete seem in some sort to have claimed descent from Minos, and the Dorian legislators sought their sanction in the laws which Minos was said to have received from the hands of the Cretan Zeus. The great monument of Gortyna discovered by Halbherr and Fabricius (*Monumenti antichi*, iii.) is the most important monument of early law hitherto brought to light in any part of the Greek world.

Among other Greek remains in the island may be mentioned, besides the great inscription, the archaic temple of the Pythian Apollo at Gortyna, a plain square building with a *pronaos* added in later times, excavated by Halbherr, 1885 and 1887 (*Mon. Ant.* iii. 2 seqq.), the Hellenic bridge and the vast rock-cut reservoirs of Eleutherna, the city walls of Itanos, Aptera and Polyrrhenia, and at Phalasarua, the rock-cut throne of a divinity, the port, and the remains of a temple. The most interesting record, however, that has been preserved of later Hellenic civilization in the island is the coinage of the Cretan cities (J. N. Svoronos, *Numismatique de la Crète ancienne*; W. Wroth, *B. M. Coin Catalogue, Crete, &c.*; P. Gardner, *The Types of Greek Coins*), which during the good period display a peculiarly picturesque artistic style distinct from that of the rest of the Greek world, and sometimes indicative of a revival of Minoan types. But in every case these artistic efforts were followed at short intervals by gross relapses into barbarism which reflect the anarchy of the political conditions.

Under the *Pax Romana* the Cretan cities again enjoyed a large measure of prosperity, illustrated by numerous edifices still existing at the time of the Venetian occupation. A good

The dark ages.

Greek remains.



account of these is preserved in a MS. description of the island drawn up under the Venetians about 1538, and existing in the library of St Mark (published by Falkener, *Museum Romanum*, of *Classical Antiquities*, ii. pp. 263-303). Very little of all this, however, has escaped the Turkish conquest and the ravages caused by the incessant insurrections of the last two centuries. The ruin-field of Gortyna still evokes something of the importance that it possessed in Imperial days, and at Lebena on the south coast are remains of a temple of Aesculapius and its dependencies which stood in connexion with this city. At Cnossus, save some blocks of the amphitheatre, the Roman monuments visible in Venetian times have almost wholly disappeared. Among the early Christian remains of the island far and away the most important is the church of St Titus at Gortyna, which perhaps dates from the Constantinian age.

**LITERATURE.**—See the authorities already quoted, for further details. Previous to the extensive excavations referred to above, Crete had been carefully examined and explored by Tournefort, Pococke, Olivier and other travellers, e.g. Pashley (*Travels in Crete*, 2 vols., London, 1837) and Captain Spratt (*Travels and Researches in Crete*, 2 vols., London, 1865). A survey sufficiently accurate as regards the maritime parts was also executed, under the orders of the British admiralty, by Captain Graves and Captain (afterwards Admiral) Spratt. Most that can be gathered from ancient authors concerning the mythology and early history of the island is brought together by Meursius (*Crete*, &c., in the 3rd vol. of his works) and Hoeck (*Kreta*, 3 vols., Göttingen, 1823-1829), but the latter work was published before the researches which have thrown so much light on the topography and antiquities of the island. Much new material, especially as to the western provinces of Crete, has been recently collected by members of the Italian Archaeological Mission (*Monumenti Antichi*, vol. vi. 154 seqq., ix. 286, 1899; xi. 286 seqq.). (A. J. E.)

#### History.

**Ancient.**—Lying midway between three continents, Crete was from the earliest period a natural stepping-stone for the passage of early culture from Egypt and the East to mainland Greece. On all this the recent archaeological discoveries (see the section on *Archaeology*) have thrown great light, but the earliest written history of Crete, like that of most parts of continental Greece, is mixed up with mythology and fable to so great an extent as to render it difficult to arrive at any clear conclusions concerning it. The Cretans themselves claimed for their island to be the birthplace of Zeus, as well as the parent of all the other divinities usually worshipped in Greece as the Olympian deities. But passing from this region of pure mythology to the semi-mythic or heroic age, we find almost all the early legends and traditions of the island grouped around the name of Minos. According to the received tradition, Minos was a king of Cnossus in Crete; he was a son of Zeus, and enjoyed through life the privilege of habitual intercourse with his divine father. It was from this source that he derived the wisdom which enabled him to give to the Cretans the excellent system of laws and governments that earned for him the reputation of being the greatest legislator of antiquity. At the same time he was reported to have been the first monarch who established a naval power, and acquired what was termed by the Greeks the *Thalassocracy*, or dominion of the sea.

This last tradition, which was received as an undoubted fact both by Thucydides and Aristotle, has during the last few years received striking confirmation. The remarkable remains recently brought to light on Cretan soil tend to show that already some 2000 years before the Dorian conquest the island was exercising a dominant influence in the Aegean world. The great palaces now excavated at Cnossus and Phaestus, as well as the royal villa of Hagia Triada, exhibit the successive phases of a brilliant primitive civilization which had already attained mature development by the date of the XIIth Egyptian dynasty. To this civilization as a whole it is convenient to give the name "Minoan," and the name of Minos itself may be reasonably thought to cover a dynastic even more than a personal significance, in much the same way as such historic terms as "Pharaoh" or "Caesar."

The archaeological evidence outside Crete points to the actual existence of Minoan plantations as far afield on one side as Sicily and on the other as the coast of Canaan. The historic

tradition which identifies with the Cretans the principal element of the Philistine confederation, and places the tomb of Minos himself in western Sicily, thus receives remarkable confirmation. Industrial relations with Egypt are also marked by the occurrence of a series of finds of pottery and other objects of Minoan fabric among the remains of the XVIIIth, XIIth and even earlier dynasties, while the same seafaring enterprise brought Egyptian fabrics to Crete from the times of the first Pharaohs. Even in the Homeric poems, which belong to an age when the great Minoan civilization was already decadent, the Cretans appear as the only Greek people who attempted to compete with the Phoenicians as bold and adventurous navigators. In the Homeric age the population of Crete was of a very mixed character, and we are told in the *Odyssey* (xix. 175) that besides the Eteocretes, who, as their name imports, must have been the original inhabitants, the island contained Achaeans, Pelasgians and Dorians. Subsequently the Dorian element became greatly strengthened by fresh immigrations from the Peloponnesus, and during the historical period all the principal cities of the island were either Dorian colonies, or had adopted the Dorian dialect and institutions. It is certain that at a very early period the Cretan cities were celebrated for their laws and system of government, and the most extensive monument of early Greek law is the great Gortyna inscription, discovered in 1884. The origin of the Cretan laws was of course attributed to Minos, but they had much in common with those of the other Dorian states, as well as with those of Lycurgus at Sparta, which were, indeed, according to one tradition, copied in great measure from those already existing in Crete.<sup>1</sup>

It is certain that whatever merits the Cretan laws may have possessed for the internal regulation of the different cities, they had the one glaring defect, that they made no provision for any federal bond or union among them, or for the government of the island as a whole. It was owing to the want of this that the Cretans scarcely figure in Greek history as a people, though the island, as observed by Aristotle, would seem from its natural position calculated to exercise a preponderating influence over Greek affairs. Thus they took no part either in the Persian or in the Peloponnesian War, or in any of the subsequent civil contests in which so many of the cities and islands of Greece were engaged. At the same time they were so far from enjoying tranquillity on this account that the few notices we find of them in history always represent them as engaged in local wars among one another; and Polybius tells us that the history of Crete was one continued series of civil wars, which were carried on with a bitter animosity exceeding all that was known in the rest of Greece.

In these domestic contests the three cities that generally took the lead, and claimed to exercise a kind of *hegemony* or supremacy over the whole island, were Cnossus, Gortyna and Cydonia. But besides these three, there were many other independent cities, which, though they generally followed the lead of one or other of these more powerful rivals, enjoyed complete autonomy, and were able to shift at will from one alliance to another. Among the most important of these were—Lyttus or Lyctus, in the interior, south-east of Cnossus; Rhaucus, between Cnossus and Gortyna; Phaestus, in the plain of Messara, between Gortyna and the sea; Polyrrhenia, near the north-west angle of the island; Aptera, a few miles inland from the Bay of Suda; Eleutherna and Axus, on the northern slopes of Mount Ida; and Lappa, between the White Mountains and the sea. Phalasarua on the west coast, and Chersonesus on the north, seem to have been dependencies, and served as the ports of Polyrrhenia and Lyttus. Elyrus stood at the foot of the White Mountains, just

<sup>1</sup> Among the features common to the two were the *syssitia*, or public tables, at which all the citizens dined in common. Indeed, the Cretan system, like that of Sparta, appears to have aimed at training up the young, and controlling them, as well as the citizens of more mature age, in all their habits and relations of life. The supreme governing authority was vested in magistrates called *Cosmi*, answering in some measure to the Spartan Ephori, but there was nothing corresponding to the two kings at Sparta. These Cretan institutions were much extolled by some writers of antiquity, but receive only qualified praise from the judicious criticisms of Aristotle (*Polit.* ii. 10).

above the south coast. In the eastern portion of the island were Praesus in the interior, and Itanus on the coast, facing the east, while Hierapytna on the south coast was the only place of importance on the side facing Africa, and on this account rose under the Romans to be one of the principal cities of the island.

(A. J. E.)

*Medieval to 19th Century.*—Though it was continually torn by civil dissensions, the island maintained its independence of the various Macedonian monarchs by whom it was surrounded; but having incurred the enmity of Rome, first by an alliance with the great Mithradates, and afterwards by taking active part with their neighbours, the pirates of Cilicia, the Cretans were at length attacked by the Roman arms, and, after a resistance protracted for more than three years, were finally subdued by Q. Metellus, who earned by this success the surname of Creticus (67 B.C.). The island was now reduced to a Roman province, and subsequently united for administrative purposes with the district of Cyrenaica or the Pentapolis, on the opposite coast of Africa. This arrangement lasted till the time of Constantine, by whom Crete was incorporated in the prefecture of Illyria. It continued to form part of the Byzantine empire till the 9th century, when it fell into the hands of the Saracens (823). It then became a formidable nest of pirates and a great slave mart; it defied all the efforts of the Byzantine sovereigns to recover it till the year 960, when it was reconquered by Nicephorus Phocas. In the partition of the Greek empire after the capture of Constantinople by the Latins in 1204, Crete fell to the lot of Boniface, marquis of Montferrat, but was sold by him to the Venetians, and thus passed under the dominion of that great republic, to which it continued subject for more than four centuries.

Under the Venetian government Candia, a fortress originally built by the Saracens, and called by them "Khandax," became the seat of government, and not only rose to be the capital and chief city of the island, but actually gave name to it, so that it was called in the official language of Venice "the island of Candia," a designation which from thence passed into modern maps. The ancient name of Kreta or Kriti was, however, always retained in use among the Greeks, and is gradually resuming its place in the usage of literary Europe. The government of Crete by the Venetian aristocracy was, like that of their other dependencies, very arbitrary and oppressive, and numerous insurrections were the consequence. Daru, in his history of Venice, mentions fourteen between the years 1207 and 1365, the most important being that of 1361-1364,—a revolt not of the natives against the rule of their Venetian masters, but of the Venetian colonists against the republic. But with all its defects their administration did much to promote the material prosperity of the country, and to encourage commerce and industry; and it is probable that the island was more prosperous than at any subsequent time. Their Venetian masters at least secured to the islanders external tranquillity, and it is singular that the Turks were content to leave them in undisturbed possession of this opulent and important island for nearly two centuries after the fall of Constantinople. The Cretans themselves, however, were eager for a change, and, disappointed in the hope of a Genoese occupation, were ready, as is stated in the report of a Venetian commissioner, to exchange the rule of the Venetians for that of the Turks, whom they fondly expected to find more lenient, or at any rate less energetic, masters. It was not till 1645 that the Turks made any serious attempt to effect the conquest of the island; but in that year they landed with an army of 50,000 men, and speedily reduced the important city of Canea. Retimo fell the following year, and in 1648 they laid siege to the capital city of Candia. This was the longest siege on record, having been protracted for more than twenty years; but in 1667 it was pressed with renewed vigour by the Turks under the grand vizier Ahmed Kuprili, and the city was at length compelled to surrender (September 1669). Its fall was followed by the submission of the whole island. Venice was allowed to retain possession of Grabusa, Suda and Spinalonga on the north, but in 1718 these three strongholds reverted to the Turks, and the island was finally lost to Venice.

From this time Crete continued subject to Ottoman rule without interruption till the outbreak of the Greek revolution. After the conquest a large part of the inhabitants embraced Mahomedanism, and thus secured to themselves the chief share in the administration of the island. But far from this having a favourable effect upon the condition of the population, the result was just the contrary, and according to R. Pashley (*Travels in Crete*, 1837) Crete was the worst governed province of the Turkish empire. In 1770 an abortive attempt at revolt, the hero of which was "Master" John, a Sphakiot chief, was repressed with great cruelty. The regular authorities sent from Constantinople were wholly unable to control the excesses of the janissaries, who exercised without restraint every kind of violence and oppression. In 1813 the ruthless severity of the governor-general, Haji Osman, who obtained the co-operation of the Christians, broke the power of the janissaries; but after Osman had fallen a victim to the suspicions of the sultan, Crete again came under their control. When in 1821 the revolution broke out in continental Greece, the Cretans, headed by the Sphakiots, after a massacre at Canea at once raised the standard of insurrection. They carried on hostilities with such success that they soon made themselves masters of the whole of the open country, and drove the Turks and Mussulman population to take refuge in the fortified cities. The sultan then invoked the assistance of Mehemet Ali, pasha of Egypt, who despatched 7000 Albanians to the island. Hostilities continued with no decisive result till 1824, when the arrival of further reinforcements enabled the Turkish commander to reduce the island to submission. In 1827 the battle of Navarino took place, and in 1830 (3rd of February) Greece was declared independent. The allied powers (France, England and Russia) decided, however, that Crete should not be included amongst the islands annexed to the newly-formed kingdom of Greece; but recognizing that some change was necessary, they obtained from the sultan Mahmud II. its cession to Egypt, which was confirmed by a firman of the 20th of December 1832. This change of masters brought some relief to the unfortunate Cretans, who at least exchanged the licence of local misrule for the oppression of an organized despotism; and the government of Mustafa Pasha, an Albanian like Mehemet Ali, the ruler of the island for a considerable period (1832-1852), was more enlightened and intelligent than that of most Turkish governors. He encouraged agriculture, improved the roads, introduced an Albanian police, and put down brigandage. The period of his administration has been called the "golden age" of Crete.

In 1840 Crete was again taken from Mehemet Ali, and replaced under the dominion of the Turks, but fortunately Mustafa still retained his governorship until he left for Constantinople to become grand vizier in 1852. Four years later an insurrection broke out, owing to the violation of the provisions of an imperial decree (February 1856), whereby liberty of conscience and equal rights and privileges with Mussulmans had been conferred upon Christians. The latter refused to lay down their arms until a firman was issued (July 1858), confirming the promised concessions. These promises being again repudiated, in 1864 the inhabitants held an assembly and a petition was drawn up for presentation at Constantinople by the governor. The sultan's reply was couched in the vaguest terms, and the Cretans were ordered to render unquestioning obedience to the authorities. After a period of great distress and cruel oppression, in 1866, on the demand for reforms being again refused, a general insurrection took place, which was only put down by great exertions on the part of the Porte. It was followed by the concession of additional privileges to the Christians of the island and of a kind of constitutional government and other reforms embodied in what is known as the "Organic Statute" of 1868. (J. H. F.)

*Modern Constitutional.*—Cretan constitutional history may be said to date from 1868, when, after the suppression of an insurrection which had extended over three years, the Turkish government consented to grant a certain measure of autonomy to the island. The privileges now accorded were embodied in what is known as the Organic Statute, an instrument which eventually obtained a somewhat wider importance, being proposed by

Article XXIII. of the Berlin Treaty as a basis of reforms to be introduced in other parts of the Ottoman empire. Various privileges already acquired by the Christian population were confirmed; a general council, or representative body, was brought into existence, composed of deputies from every district in the island; mixed tribunals were introduced, together with a highly elaborate administrative system, under which all the more important functionaries, Christian and Mussulman, were provided with an assessor of the opposite creed. The new constitution, however, proved costly and unworkable, and failed to satisfy either section of the population. The Christians were ready for another outbreak, when, in 1878, the Greek government, finding Hellenic aspirations ignored by the treaty of San Stefano, gave the signal for agitation in the island. During the insurrection which followed, the usual barbarities were committed on both sides; the Christians betook themselves to the mountains, and the Mussulman peasants crowded into the fortified towns. Eventually the Cretan chiefs invoked the mediation of England, which Turkey, exhausted by her struggle with Russia, was ready to accept, and the convention known as the *Pact of Halepa* was drawn up in 1878 under the auspices of Mr Sandwith, the British consul, and Adossides Pasha, both of whom enjoyed the confidence of the Cretan population. The privileges conferred by the Organic Statute were confirmed; the cumbersome and extravagant judicial and administrative systems were maintained; the judges were declared independent of the executive, and an Assembly composed of forty-nine Christian and thirty-one Mussulman deputies took the place of the former general council. A parliamentary régime was thus inaugurated, and party warfare for a time took the place of the old religious antagonism, the Moslems attaching themselves to one or other of the political factions which now made their appearance among the Christians. The material interests of the island were neglected in the scramble for place and power; the finances fell into disorder, and the party which came off worst in the struggle systematically intrigued against the governor-general of the day and conspired with his enemies at Constantinople. A crisis came about in 1889, when the "Conservative" leaders, finding themselves in a minority in the chamber, took up arms and withdrew to the mountains. Though the outbreak was unconnected with the religious feud, the latent fanaticism of both creeds was soon aroused, and the island once more became a scene of pillage and devastation. Unlike the two preceding movements, the insurrection of 1889 resulted unfavourably for the Christians. The Porte, having induced the Greek government to persuade the insurgents not to oppose the occupation of several strategic posts, despatched a military governor to the island, proclaimed martial law, and issued a firman abrogating many important provisions of the Halepa Pact. The mode of election to the assembly was altered, the number of its members reduced, and the customs revenue, which had hitherto been shared with the island, was appropriated by the Turkish treasury. The firman was undoubtedly illegal, as it violated a convention possessing a quasi-international sanction, but the Christians were unable to resist, and the powers abstained from intervention. The elections held under the new system proved a failure, the Christians refusing to go to the polls, and for the next five years Crete was governed absolutely by a succession of Mahomedan Valis. The situation went from bad to worse, the deficit in the budget increased, the gendarmery, which received no pay, became insubordinate, and crime multiplied. In 1894 the Porte, at the instance of the powers, nominated a Christian, Karatheodory Pasha, to the governorship, and the Christians, mollified by the concession, agreed to take part in the assembly which soon afterwards was convoked; no steps, however, were taken to remedy the financial situation, which became the immediate cause of the disorders that followed. The refusal of the Porte to refund considerable sums which had been illegally diverted from the Cretan treasury or even to sanction a loan to meet immediate requirements caused no little exasperation in the island, which was increased by the recall of Karatheodory (March 1895). Before that event an Epitropé, or

"Committee of Reform," had appeared in the mountains—the harbinger of the prolonged struggle which ended in the emancipation of Crete. The Epitropé was at first nothing more than a handful of discontented politicians who had failed to find places in the administration, but some slight reverses which it succeeded in inflicting on the Turkish troops brought thousands of armed Christians to its side, and in April 1896 it found itself strong enough to invest the important garrison town of Vamos. The Moslem peasantry now flocked to the fortified towns and civil war began. Serious disturbances broke out at Canea on the 24th of May, and were only quelled by the arrival of foreign warships. The foreign consuls intervened in the hope of bringing about a peaceful settlement, but the Sultan resolved on the employment of force, and an expedition despatched to Vamos effected the relief of that town with a loss of 200 men. The advance of a Turkish detachment through the western districts, where other garrisons were besieged, was marked by pillage and devastation, and 5000 Christian peasants took refuge on the desolate promontory of Spada, where they suffered extreme privations. These events, which produced much excitement in Greece, quickened the energies of the powers. An international blockade of the island was proposed by Austria but rejected by England. The ambassadors at Constantinople urged peaceful counsels on the Porte, and the Sultan, alarmed at this juncture by an Armenian outbreak, began to display a conciliatory disposition. The Pact of Halepa was restored, the troops were withdrawn from the interior, financial aid was promised to the island, a Christian governor-general was appointed, the assembly was summoned, and an imperial commissioner was despatched to negotiate an arrangement. The Christian leaders prepared a moderate scheme of reforms, based on the Halepa Pact, which, with a few exceptions, were approved by the powers and eventually sanctioned by the sultan.

On the 4th of September 1896 the assembly formally accepted the new constitution and declared its gratitude to the powers for their intervention. The Moslem leaders acquiesced in the arrangement, which the powers undertook to guarantee, and, notwithstanding some symptoms of discontent at Candia, there was every reason to hope that the island was now entering upon a period of tranquillity. It soon became evident, however, that the Porte was endeavouring to obstruct the execution of the new reforms. Several months passed without any step being taken towards this realization; difficulties were raised with regard to the composition of the international commissions charged with the reorganization of the gendarmery and judicial system; intrigues were set on foot against the Christian governor-general; and the presence of a special imperial commissioner, who had no place under the constitution, proved so injurious to the restoration of tranquillity that the powers demanded his immediate recall. The indignation of the Christians increased, a state of insecurity prevailed, and the Moslem peasants refused to return to their homes. A new factor now became apparent in Cretan politics. Since the outbreak in May 1896 the Greek government had loyally co-operated with the powers in their efforts for the pacification of the island, but towards the close of the year a secret society known as the *Ethniké Hetaeria* began to arrogate to itself the direction of Greek foreign policy. The aim of the society was a war with Turkey with a view to the acquisition of Macedonia, and it found a ready instrument for its designs in the growing discontent of the Cretan Christians. Emissaries of the society now appeared in Crete, large consignments of arms were landed, and at the beginning of 1897 the island was practically in a state of insurrection. On the 21st of January the Greek fleet was mobilized. Affairs were brought to a climax by a series of conflicts which took place at Canea on the 4th of February; the Turkish troops fired on the Christians, a conflagration broke out in the town, and many thousands of Christians took refuge on the foreign warships in the bay. The Greek government now despatched an ironclad and a cruiser to Canea, which were followed a few days later by a torpedo flotilla commanded by

*Insurrection of 1896-97.*

*Greek Intervention.*

Prince George. The prince soon retired to Melos, but on the night of the 14th of February a Greek expeditionary force under Colonel Vassos landed at Kolymbari, near Canea, and its commander issued a proclamation announcing the occupation of the island in the name of King George. On the same day Georgi Pasha, the Christian governor-general, took refuge on board a Russian ironclad, and, on the next, naval detachments from the warships of the powers occupied Canea. This step paralysed the movements of Colonel Vassos, who after a few slight engagements with the Turks remained practically inactive in the interior. The insurgents, however, continued to threaten the town, and their position was bombarded by the international fleet (21st February). The intervention of Greece caused immense excitement among the Christian population, and terrible massacres of Moslem peasants took place in the eastern and western districts. The forces of the powers shortly afterwards occupied Candia and the other maritime towns, while the international fleet blockaded the Cretan coast. These measures were followed by

**Decision  
of the  
powers.**

the presentation of collective notes to the Greek and Turkish governments (2nd March), announcing the decision of the powers that (1) Crete could in no case in present circumstances be annexed to Greece; (2) in view of the delays caused by Turkey in the application of the reforms Crete should now be endowed with an effective autonomous administration, intended to secure to it a separate government, under the suzerainty of the sultan. Greece was at the same time summoned to remove its army and fleet from the island, while the Turkish troops were to be concentrated in the fortresses and eventually withdrawn. The cabinet of Athens, however, declined to recall the expeditionary force, which remained in the interior till the 9th of May, when, after the Greek reverses in Thessaly and Epirus, an order was given for its return. Meantime Cretan autonomy had been proclaimed (20th March). After the departure of the Greek troops the Cretan leaders, who had hitherto demanded annexation to Greece, readily acquiesced in the decision of the powers, and the insurgent Assembly, under its president Dr Sphakianakis, a man of good sense and moderation, co-operated with the international commanders in the maintenance of order. The pacification of the island, however, was delayed by the presence of the Turkish troops and the inability of the powers to agree in the choice of a new governor-general. The prospect of a final settlement was improved by the withdrawal of Germany and Austria, which had favoured Turkish pretensions, from the European concert (April 1898); the remaining powers divided the island into four departments, which they severally undertook to administer. An attack made by the Moslems of Candia on the British garrison of that town, with the connivance of the Turkish authorities, brought home to the powers the necessity of removing the Ottoman troops, and the last Turkish soldiers quitted the island on the 14th of November 1898.

On the 26th of that month the nomination of Prince George of Greece as high commissioner of the powers in Crete for a period of three years (renewed in 1901) was formally announced, and on the 21st of December the prince landed at Suda and made his public entry into Canea amid enthusiastic demonstrations. For some time after his arrival complete tranquillity prevailed in the island, but the Moslem population, reduced to great distress by the prolonged insurrection, emigrated in large numbers. On the 27th of April 1899 a new autonomous constitution was voted by a constituent assembly, and in the following June the local administration was handed over to Cretan officials by the international authorities. The extensive powers conferred by the constitution upon Prince George were increased by subsequent enactments. In 1901 M. Venezelo, who had played a noteworthy part in the last insurrection, was dismissed from the post of councillor by the prince, and soon afterwards became leader of a strong opposition party, which denounced the arbitrary methods of the government. During the next four years party spirit ran high; in the spring of 1904 a deputation of chiefs and politicians addressed a protest to the prince, and early in the following

year a band of armed malcontents under M. Venezelo raised the standard of revolt at Theriso in the White Mountains. The insurgents, who received moral support from Dr Sphakianakis, proclaimed the union of the island with Greece (March 1905), and their example was speedily followed by the assembly at Canea. The powers, however, reiterated their decision to maintain the *status quo*, and increased their military and naval forces; the Greek flag was hauled down at Canea and Candia, and some desultory engagements with the insurgents took place, the international troops co-operating with the native gendarmerie. In the autumn M. Venezelo and his followers, having obtained an amnesty, laid down their arms. A commission appointed by the powers to report on the administrative and financial situation drew up a series of recommendations in January 1906, and a constituent assembly for the revision of the constitution met at Canea in the following June. On the 25th of July the powers announced a series of reforms, including the reorganization of the gendarmerie and militia under Greek officers, as a preliminary to the eventual withdrawal of the international troops, and the extension to Crete of the system of financial control established in Greece. On the 14th of September, under an agreement dated the 14th of August, they invited King George of Greece, in the event of the high commissionership becoming vacant, to propose a candidate for that post, to be nominated by the powers for a period of five years, and on the 25th of September Prince George left the island. He had done much for the welfare of Crete, but his participation in party struggles and his attitude towards the representatives of the powers had rendered his position untenable. His successor, M. Alexander Zaimis, a former prime minister of Greece, arrived in Crete on the 1st of October. (J. D. B.)

On the 22nd of February 1907 M. Zaimis, as high commissioner, took the oath to the new constitution elaborated after much debate by the Cretan national assembly. His position was one of singular difficulty. Apart from the rivalry of the factions within the Assembly, there was the question of the Mussulman minority, dwindling it is true,<sup>1</sup> but still a force to be reckoned with. The high commissioner, true to his reputation as a prudent statesman and astute politician, showed great skill in dealing with the situation. From the first he had taken up an attitude of great reserve, appearing little in public and careful not to identify himself with any faction. In such matters as appointments to the judicial bench, indeed, his studied impartiality offended both parties; but on the whole his administration was a marked success, and the cessation of the chronic state of disturbance in the island justified the powers in preparing for the withdrawal of their troops. In spite of the admission of their co-religionists to high office in the government, the Mussulmans, it is true, still complained of continuous ill-treatment having for its object their expatriation; but these complaints were declared by Sir Edward Grey, in answer to a question in parliament, to be exaggerated. The protecting powers had fixed the conditions preliminary to evacuation—(1) the organization of a native gendarmerie, (2) the maintenance of the tranquillity of the island, (3) the complete security of the Mussulman population. On the 20th of March 1908 M. Zaimis called the attention of the powers to the fact that these conditions had been fulfilled, and on the 11th of May the powers announced to the high commissioner their intention of beginning the evacuation at once and completing it within a year. The first withdrawal of the troops (July 27), hailed with enthusiasm by the Cretan Christians, led to rioting by the Mussulmans, who believed themselves abandoned to their fate.

Meanwhile M. Zaimis had made a further advance towards the annexation of the island to Greece by a visit to Athens, where he arranged for a loan with the Greek National Bank and engaged Greek officers for the new gendarmerie. The issue was precipitated by the news of the revolution in Turkey. On the 12th

<sup>1</sup> The Mussulman population, 88,000 in 1895, had sunk to 40,000 in 1907, and the emigration was still continuing. The loss to the country in wealth exported and land going out of cultivation has been very serious.

of October the Cretan Assembly once more voted the union with Greece, and in the absence of M. Zaimis—who had gone for a holiday to Santa Maura—elected a committee of six to govern the island in the name of the king of Greece.

Against this the Mussulman deputies protested, in a memorandum addressed to the British secretary of state for foreign affairs. His reply, while stating that his government would safeguard the interests of the Mussulmans, left open the question of the attitude of the powers, complicated now by sympathy with reformed Turkey. The efforts of diplomacy were directed to allaying the resentment of the "Young Turks" on the one hand and the ardour of the Greek unionists on the other; and meanwhile the Cretan administration was carried on peaceably in the name of King George. At last (July 13, 1909) the powers announced to the Porte, in answer to a formal remonstrance, their decision to withdraw their remaining troops from Crete by July 26 and to station four war-ships off the island to protect the Moslems and to safeguard "the supreme rights" of the Ottoman Empire. This arrangement, which was duly carried out, was avowedly "provisional" and satisfied neither party, leading in Greece especially to the military and constitutional crises of 1909 and 1910. (W. A. P.)

**AUTHORITIES.**—Pashley, *Travels in Crete* (2 vols., Cambridge and London, 1837); Spratt, *Travels and Researches in Crete* (2 vols., London, 1867); Raulin, *Description physique de l'île de Crète* (3 vols. and Atlas, Paris, 1869); W. J. Stillman, *The Cretan Insurrection of 1866-68* (New York, 1874); Edwardes, *Letters from Crete* (London, 1887); Stavrakis, *Στατιστική τοῦ πληθυσμοῦ τῆς Κρήτης* (Athens, 1890); J. H. Freese, *A Short Popular History of Crete* (London, 1897); Bickford-Smith, *Cretan Sketches* (London, 1897); Laroche, *La Crète ancienne et moderne* (Paris, 1898); Victor Berard, *Les Affaires de Crète* (Paris, 1898); *Monumenti Veneti dell' isola de Creta* (published by the Venetian Institute), vol. i. (1906), vol. ii. (1908). See also Mrs Walker, *Eastern Life and Scenery* (London, 1886), and *Old Tracks and New Landmarks* (London, 1897); H. F. Tozer, *The Islands of the Aegean* (Oxford, 1890); J. D. Bourchier, "The Stronghold of the Sphakiotas," *Fortnightly Review* (August 1890); E. J. Dillon, "Crete and the Cretans," *Fortnightly Review* (May 1897).

**CRETINISM**, the term given to a chronic disease, either sporadic or endemic, arising in early childhood, and due to absence or deficiency of the normal secretion of the thyroid gland. It is characterized by imperfect development both of mind and body. The thyroid gland is either congenitally absent, imperfectly developed, or there is definite goitre. The origin of the word is doubtful. Its southern French form *Chrestiaa* suggested to Michel a derivation from *cresta* (*crête*), the goose foot of red cloth worn by the Cagots of the Pyrenees. The Cagots, however, were not cretins. The word is usually explained as derived from *chrétien* (Christian) in the sense of "innocent." But *Christianus* (which appears in the Lombard *cristonei*; compare the Savoyard *innocents* and *gens du bon dieu*) is probably a translation of the older *cretin*, and the latter is probably connected with *creta* (*cræie*)—a sallow or yellow-earthly complexion being a common mark of cretinism.

The endemic form of cretinism prevails in certain districts, as in the valleys of central Switzerland, Tirol and the Pyrenees. In the United Kingdom cretins have been found in England at Oldham, Shalver Moor, Crompton, Duffield, Cromford (near Matlock), and other points in Derbyshire; endemic goitre has been seen near Nottingham, Chesterfield, Pontefract, Ripon, and the mountainous parts of Staffordshire and Yorkshire, the east of Cumberland, certain parts of Worcester, Warwick, Cheshire, Monmouth, and Leicester, near Horsham in Hampshire, near Haslemere in Surrey, and near Beaconsfield in Buckingham. There are cretins at Chiselborough in Somerset. In Scotland cretins and cases of goitre have been seen in Perthshire, on the east coast of Fife, in Roxburgh, the upper portions of Peebles and Selkirk; near Lanark and Dumfries, in the east of Ayrshire, in the west of Berwick, the east of Wigtown, and in Kirkcudbright. The disease is not confined to Europe, but occurs in North and South America, Australia, Africa and Asia. Wherever endemic goitre is present, endemic cretinism is present also, and it has been constantly observed that when a new family moves into a goitrous district, goitre appears in the first generation, cretinism in the second. The causation of goitre has now been shown to

be due to drinking certain waters, though the particular impurity in the water which gives rise to this condition has not been determined (see GOITRE). The causation of the sporadic form of cretinism is, however, obscure.

Cretinism usually remains unrecognized until the child reaches some eighteen months or two years, when its lack of mental development and uncouth bodily form begin to attract attention. Occasionally the child appears to be normal in infancy, but the cretinoid condition develops later, any time up to puberty. The essential point in the morbid anatomy of these cases is the absence or abnormal condition of the thyroid gland (see METABOLIC DISEASES). It may be congenitally absent, atrophied, or the seat of a goitre, though this last condition is very rare in cases of sporadic cretinism. The skeleton shows arrested growth, most marked in the case of the long bones. The skull in the endemic form of cretinism is usually brachycephalic, but in the sporadic cases it is more commonly dolichocephalic. The pathology of cretinism and its allied condition myxoedema (*q.v.*) has now been conclusively worked out, and its essential cause has been shown to be loss of function of the thyroid gland.

The condition has existed and been described in far back ages, but mingled with so many other entirely different deformities and degenerations that it is now often almost impossible to classify them satisfactorily. The following is a vivid picture by Beaupré (*Dissertation sur les crétiens*, translated in Blackie on *Cretinism*, Edin., 1859):—

"I see a head of unusual form and size, a squat and bloated figure, a stupid look, bleared hollow and heavy eyes, thick projecting eyelids, and a flat nose. His face is of a leaden hue, his skin dirty, flabby, covered with tetter, and his thick tongue hangs down over his moist livid lips. His mouth, always open and full of saliva, shows teeth going to decay. His chest is narrow, his back curved, his breath asthmatic, his limbs short, misshapen, without power. The knees are thick and inclined inward, the feet flat. The large head drops listlessly on the breast; the abdomen is like a bag."

When fully grown the height rarely exceeds 4 ft., and is often less than 3 ft. The skin feels doughy from thickening of the subcutaneous tissues, and it hangs in folds over the abdomen and the bends of the joints. Very frequently there is an umbilical hernia. The hair has a far greater resemblance to horse-hair than to that of a human being, and is usually absent on the body of an adult cretin. The temperature is subnormal, and the exposed parts tend to become blue in cold weather. The blood is usually deficient in haemoglobin, which is often only 40-50 % of the normal. The mental capacity varies within narrow limits; an intelligent adult cretin may reach the intellectual development of a child 3-4 years of age, though more often the standard attained is even below this. The child cretin learns neither to walk nor talk at the usual time. Often it is unable even to sit without support. Some years later a certain power of movement is acquired, but the gait is waddling and clumsy. Speech is long delayed, or in bad cases may be almost entirely lacking. The voice is usually harsh and unpleasant. Of the senses smell and taste are but slightly developed, more or less deafness is generally present, and only the sight is fairly normal. In the adult the genital organs remain undeveloped. If the cretin is untreated he rarely has a long life, thirty years being an exceptional age. Death results from some intercurrent disease.

Cretinism has to be distinguished from the state of a Mongolian idiot, in whom there is no thickening of the subcutaneous tissues, and much greater alertness of mind; from achondroplasia, in which condition there is usually no mental impairment; and from infantilism, which covers a group of symptoms whose only common point is that the primary and secondary sexual characteristics fail to appear at the proper time.

Before 1891 there was no treatment for this disease. The patients lived in hopeless imbecility until their death. But in that year Dr George Murray published his discovery of the effect of hypodermic injections of thyroid gland extract in cases of myxoedema. In the following year Drs Hector Mackenzie, E. L. Fox of Plymouth, and Howitz of Copenhagen, each working independently, showed the equally potent effect of the gland administered by the mouth. The remedy was soon



after applied to cretinism and its effects were found to be even more wonderful. It has to be used, however, with the greatest care and discrimination, since personal idiosyncrasy seems to be a very variable factor. Even small doses, if beyond the patient's power, may produce fever, excitement, headache, insomnia and vomiting. The administration must be persisted in throughout life, otherwise myxoedematous symptoms appear. The first most apparent results are those of growth, and this may supervene even in patients up to 25-30 years of age. Once started, 4 to 6 in. may be gained in stature in the first year's treatment, though this is usually in inverse ratio to the age of the patient, and also diminishes in later stages of treatment. In young adolescents it may be so rapid that the patient has to be kept lying down to prevent permanent bending of the long bones of the leg, softened by their rapid growth. A very typical case under Dr Hector Mackenzie, showing what can be expected from early treatment, is that of a cretin aged 11 years in 1893, when thyroid treatment was started. He grew very rapidly and became a normal child, passed through school, and in 1908 was at one of the universities.

**BIBLIOGRAPHY.**—Sardinian Commission, "Relazione della commissione di Sardegna per studiare il cretinismo" (Torino, 1848); C. Hilton Fagge, "On Sporadic Cretinism occurring in England," *Med. Chir. Trans.* (London, 1870); Vincenzo Allara, "Sulla causa del cretinismo," studio (Milano, 1892); Victor Horsley, "Remarks on the Function of the Thyroid Gland," *Brit. Med. Journ.* (1892); "The Treatment of Myxoedema and Cretinism, being a Review of the Treatment of those Diseases by Thyroid Gland," *Journ. Ment. Sc.* (London, 1893); W. Osler, "On Sporadic Cretinism in America," *Am. Journ. of Med. Sc.* (1893); C. A. Ewald, *Die Erkrankungen der Schilddrüse, Myxödeme und Cretinismus* (Wien, 1896); G. R. Murray, *Diseases of the Thyroid Gland*, part i. (1900); R. Virchow, "Über Cretinismus," *Würzburger Verhand.*; Hector Mackenzie, "Organotherapy," *Textbook of Pharmacology and Therapeutics* (1901); Weygandt, *Der heutige Stand der Lehre vom Cretinismus* (Halle, 1903); Hector Mackenzie, "Cretinism," *Allbutt & Rolleston's System of Medicine*, part iv. (1908).

**CRETONNE**, originally a strong, white fabric with a hempen warp and linen weft. The word is said to be derived from Creton, a village in Normandy where the manufacture of linen was carried on. It is now applied to a strong, printed cotton cloth, stouter than chintz but used for very much the same purposes. It is usually unglazed and may be printed on both sides and even with different patterns. Frequently the cretonne has a woven fancy pattern of some kind which is modified by the printed design. It is sometimes made with a weft of cotton waste.

**CREUSE**, a department of central France, comprising the greater portion of the old province of Marche, together with portions of Berry, Bourbonnais, Auvergne, Limousin and Poitou. Area, 2164 sq. m. Pop. (1906) 274,094. It lies on the north-western border of the central plateau and is bounded N. by the departments of Indre and Cher, E. by Allier and Puy-de-Dôme, S. by Corrèze and W. by Haute-Vienne. The surface is hilly, with a general inclination north-westward in the direction of the valley of the Creuse, sloping from the mountains of Auvergne and Limousin, branches of which project into the south of the department. The chief of these starts from the Plateau de Gentioux, and under the name of the Mountains of Marche extends along the left bank of the Creuse. The highest point is in the forest of Châteaupert (3050 ft.) in the extreme south-east of the department. Rivers, streams and lakes are numerous, but none are navigable; the principal is the Creuse, which rises on the north side of the mass of Mount Odouze on the border of the department of Corrèze, and passes through the department, dividing it into two nearly equal portions, receiving the Petite Creuse from the right, and afterwards flowing on to join the Vienne. The valleys of the head-streams of the Cher and of its tributary the Tardes, which near Évaux passes under a fine viaduct 300 ft. in height, occupy the eastern side; those of the heads of the Vienne and its tributary the Thaurion, and of the Gartempe joining the Creuse, are in the west of the department. The climate is in general cold, moist and variable; the rigorous winter covers the higher cantons with snow; rain is abundant in spring, and storms are frequent in summer, but the autumn is fine. Except in the valleys the

soil is poor and infertile, and agriculture is also handicapped by the dearth of labour, due to the annual emigration of from 15,000 to 20,000 of the inhabitants to other parts of France, where they serve as stonemasons, &c. The produce of cereals, chiefly rye, wheat, oats and buckwheat, is not sufficient for home consumption. The chestnut abounds in the north and west; hemp and potatoes are also grown. Cattle-rearing and sheep-breeding are the chief industries of the department, which supplies Poitou and Vendée with draught oxen. Coal is mined to some extent, chiefly in the basin of Ahun. There are thermal springs at Évaux in the east of the department, where remains of Roman baths are preserved. The chief industrial establishments are the manufactories of carpets and hangings and the dyeworks of Aubusson and Felletin. Saw-mills and the manufacture of wooden shoes and hats have some importance. Exports include carpets, coal, live-stock and hats; imports comprise raw materials for the manufactures and food-supplies. The department is served by the Orléans railway company, whose line from Montluçon to Périgueux traverses it from east to west. It is divided into the four arrondissements of Guéret, the capital Aubusson, Bourgneuf, and Boussac, and further into 25 cantons and 266 communes. With Haute-Vienne, Creuse forms the diocese of Limoges, where also is its court of appeal. It forms part of the académie (educational division) of Clermont and of the region of the XII. army corps. The principal towns are Guéret and Aubusson. La Souterraine, Chambon-sur-Voueize and Bénévent-l'Abbaye possess fine churches of the 12th century. At Moutier-d'Ahun there is a church, which has survived from a Benedictine abbey. The nave of the 15th century with a fine portal, and the choir with its carved stalls of the 17th century, are of considerable interest. The small industrial town of Bourgneuf has remains of a priory, including a tower (15th century) in which Zizim, brother of the sultan Bajazet II., is said to have been imprisoned.

**CREUTZ, GUSTAF FILIP, COUNT** (1729-1785), Swedish poet, was born in Finland in 1729. After concluding his studies in Åbo he received a post in the court of chancery at Stockholm in 1751. Here he met Count Gyllenberg, with whom his name is indissolubly connected. They were closely allied with Fru Nordenflycht, and their works were published in common; to their own generation they seemed equal in fame, but posterity has given the palm of genius to Creutz. His greatest work is contained in the 1762 volume, the idyll of *Atis och Camilla*; the exquisite little pastoral entitled "Daphne" was published at the same time, and Gyllenberg was the first to proclaim the supremacy of his friend. In 1763 Creutz practically closed his poetical career; he went to Spain as ambassador, and after three years to Paris in the same capacity. In 1783 Gustavus III. recalled him and heaped honours upon him, but he died soon after, on the 30th of October 1785. *Atis och Camilla* was long the most admired poem in the Swedish language; it is written in a spirit of pastoral which is now to some degree faded, but in comparison with most of the other productions of the time it is freshness itself. Creutz introduced a melody and grace into the Swedish tongue which it lacked before, and he has been styled "the last artificer of the language."

See *Creutz och Gyllenborgs Vitterhetsarbeten* (Stockholm, 1795).

**CREUZER, GEORG FRIEDRICH** (1771-1858), German philologist and archaeologist, was born on the 10th of March 1771, at Marburg, the son of a bookbinder. Having studied at Marburg and Jena, he for some time lived at Leipzig as a private tutor; but in 1802 he was appointed professor at Marburg, and two years later professor of philology and ancient history at Heidelberg. The latter position he held for nearly forty-five years, with the exception of a short time spent at the university of Leiden, where his health was affected by the Dutch climate. He was one of the principal founders of the Philological Seminary established at Heidelberg in 1807. The Academy of Inscriptions of Paris appointed him one of its members, and from the grand-duke of Baden he received the dignity of privy councillor. He died on the 16th of February 1858. Creuzer's first and most famous work was his *Symbolik und Mythologie der alten Völker*.

*besonders der Griechen* (1810–1812), in which he maintained that the mythology of Homer and Hesiod came from an Eastern source through the Pelasgians, and was the remains of the symbolism of an ancient revelation. This work was vigorously attacked by Hermann in his *Briefen über Homer und Hesiod*, and in his letter, addressed to Creuzer, *Über das Wesen und die Behandlung der Mythologie*; by J. H. Voss in his *Antisymbolik*; and by Lobek in his *Aglaophamos*. Of Creuzer's other works the principal are an edition of Plotinus; a partial edition of Cicero, in preparing which he was assisted by Moser; *Die historische Kunst der Griechen* (1803); *Epochen der griech. Literaturgeschichte* (1802); *Abriss der römischen Antiquitäten* (1824); *Zur Geschichte altrömischer Cultur am Oberrhein und Neckar* (1833); *Zur Gemmenkunde* (1834); *Das Mithreum von Neuenheim* (1838); *Zur Galerie der alten Dramatiker* (1839); *Zur Geschichte der classischen Philologie* (1854).

See the autobiographical *Aus dem Leben eines alten Professors* (Leipzig and Darmstadt, 1848), to which was added in the year of his death *Paralipomena der Lebensskizze eines alten Professors* (Frankfurt, 1858); also Starck, *Friederich Kreuzer, sein Bildungsgang und seine bleibende Bedeutung* (Heidelberg, 1875).

**CREVASSE**, a French word used in two senses. (1) In French Switzerland, and thence universally in high mountain regions, it designates a fissure in a glacier caused by gigantic cracks in the ice-mass, sometimes of great depth, into which climbers frequently fall through a light bridge of snow which conceals the crevasse. (2) Adopted from the French of Louisiana, it signifies locally a wide crack or breach in the bank of a canal or river, and particularly of the "levee" of the Mississippi.

**CREVIER, JEAN BAPTISTE LOUIS** (1693–1765), French author, was born at Paris, where his father was a printer. He studied under Rollin and held the professorship of rhetoric in the college of Beauvais for twenty years. He completed Rollin's *Histoire romaine* by the addition of six volumes (1750–1756); he also published two editions of Livy, with notes; *L'Histoire des empereurs des Romains, jusqu'à Constantin* (1749); *Histoire de l'Université de Paris*, and a *Rhétorique française*, which enjoyed much popularity.

**CREVILLENTE**, a town of eastern Spain, in the province of Alicante, and on the Murcia-Alicante railway. Pop. (1900) 10,726. Crevillente is a picturesque old town built among the eastern foothills of the Sierra de Crevillente. Its flat-roofed Moorish houses are enclosed by gardens of cactus, dwarf palm, orange and other subtropical plants, interspersed with masses of rock. The surrounding country, though naturally sterile, is irrigated from two adjacent springs, which differ in temperature by no less than 25° F. The district is famous for its melons, and also produces wine, olives, wheat and esparto grass. Local industries include the manufacture of coarse cloth, esparto fabrics, oil and flour.

**CREW, NATHANIEL CREW, 3RD BARON** (1633–1721), bishop of Durham, was a son of John Crew (1598–1679), who was created Baron Crew of Stene in 1661, and a grandson of Sir Thomas Crew (1565–1634), speaker of the House of Commons. Born on the 31st of January 1633, Nathaniel was educated at Lincoln College, Oxford, and was appointed rector of the college in 1668. He became dean and precentor of Chichester in 1669, clerk of the closet to Charles II. shortly afterwards, bishop of Oxford in 1671, and bishop of Durham in 1674. He owed his rapid preferment to James, then duke of York, whose favour he had gained by conniving at the duke's leanings to the Roman Church. After the accession of James II. Crew received the deanery of the Chapel Royal. He served in 1686 on the revived ecclesiastical commission which suspended Compton, bishop of London, and then shared the administration of the see of London with Sprat, bishop of Rochester. In 1687 he was a member of another ecclesiastical commission, which suspended the vice-chancellor of the university of Cambridge for refusing the degree of M.A. to a monk who would not take the customary oath. On the decline of James's power Crew dissociated himself from the court, and made a bid for the favour of the new government by voting for the motion that James had abdicated. He was excepted

from the general pardon of 1690, but afterwards was allowed to retain his see. He left large estates to be devoted to charitable ends, and his benefaction to Lincoln College and to Oxford University is commemorated in the annual Crewian oration. In 1697 Crew succeeded his brother Thomas as 3rd Baron Crew. He died on the 18th of September 1721, when the barony became extinct.

**CREW** (sometimes explained as a sea term of Scandinavian origin, cf. O. Icel. *krá*, a swarm or crowd, but now regarded as a shortened form of *accrue*, *accrewe*, used in the 16th century in the sense of a reinforcement, O. Fr. *acreue*, from *accrotre*, to grow, increase), a band or body of men associated for a definite purpose, a gang who jointly carry out a particular piece of work, and especially those who man a ship, exclusive of the captain, and sometimes also of the officers.

**CREWE, ROBERT OFFLEY ASHBURTON CREWE-MILNES, 1ST EARL OF** (1858– ), English statesman and writer, was born on the 12th of January 1858, being the son of Lord Houghton (q.v.), and was educated at Harrow and Trinity, Cambridge. In 1880 he married Sibyl Marcia Graham, who died in 1887, leaving him with two daughters. He inherited his father's literary tastes, and published *Stray Verses* in 1890, besides other miscellaneous literary work. A Liberal in politics, he became private secretary to Lord Granville when secretary of state for foreign affairs (1883–1884), and in 1886 was made a lord-in-waiting. In the Liberal administration of 1892–1895 he was lord-lieutenant for Ireland, having Mr John Morley as chief secretary. In 1895 he was created 1st earl of Crewe, his maternal grandfather, the 2nd Baron Crewe, having left him his heir. In 1899 he married Lady Margaret Primrose, daughter of the 5th earl of Rosebery. In 1905 he became lord president of the council in the Liberal government; and in 1908, in Mr Asquith's cabinet, he became secretary of state for the colonies and Liberal leader in the House of Lords.

**CREWE**, a municipal borough in the Crewe parliamentary division of Cheshire, England, 158 m. N.W. of London, on the main line of the London & North-Western railway. Pop. (1901) 42,074. The town was built on an estate called Oak Farm in the parish of Monk's Coppenthal, and takes its name from the original stations having been placed in the township of Crewe, in which the seat of Lord Crewe is situated. It is a railway junction where lines converge from London, Manchester, North Wales and Holyhead, North Stafford and Hereford. It is inhabited principally by persons in the employment of the London & North-Western railway company, and was practically created by that corporation, at a point where in 1841 only a farmhouse stood in open country. Crewe is not only one of the busiest railway stations in the world, but is the locomotive metropolis of the London & North-Western company, which has centred here enormous workshops for the manufacture of the material and plant used in railways. In 1901 the 4000th locomotive was turned out of the works. A series of subterranean ways extending many miles have been constructed to enable merchandise traffic to pass through without interfering with passenger trains on the surface railways. The company possesses one of the finest electric stations in the world, and electrical apparatus for the working of train signals is in operation. The station is fitted with an extensive suite of offices for the interchange of postal traffic, the chief mails to and from Ireland and Scotland being stopped here and arranged for various distributing centres. Its enormous railway facilities and its geographical situation as the junction of the great trunk lines running north and south, tapping also the Staffordshire potteries on the one side and the great mineral districts of Wales on the other, constitute Crewe station one of the most important links of railway and postal communication in the kingdom. The railway company built its principal schools, provided it with a mechanics' institute, containing library, science and art classes, reading rooms, assembly rooms, &c. Victoria Park, also the gift of the company, was opened in 1888. The municipal corporation built the technical school and school of art. The borough incorporated in 1877, is under a mayor, 7 aldermen and 21 councillors. Area, 2185 acres.

**CREWKERNE**, a market town in the southern parliamentary division of Somersetshire, England, 132 m. W.S.W. of London by the London & South-Western railway. Pop. of urban district (1901) 4226. It is pleasantly situated in a wooded hollow, in the upper valley of the river Parret. The church of St Bartholomew, one of the finest in the county, is in the Perpendicular style characteristic of the district. The ornamentation throughout is beautiful, and the west front especially notable. The grammar school dates from 1499, but occupies modern buildings. Sail-cloth, horsehair, cloth and webbing are manufactured.

**CRIB** (a word common to some Teutonic languages, cf. Dutch *krib* and Ger. *Krippe*; it has a common origin with the O. Eng. "cratch," a manger or crib, cf. Fr. *crèche*), a manger or framework receptacle for holding fodder for cattle and horses, and so, from early times in English, particularly the manger in which Jesus was laid. It is thus used of a "cradle," from which in form it should be distinguished as being a small bed with high closed-in sides. The word has many transferred meanings, as a rough, small hut or dwelling, from which comes the slang use of "crib" as a berth or situation, or, as a burglar's term for a house to be broken into; also, technically, in engineering for a timber framework for masonry constructed with a caisson in laying foundations below water, or in mining for a timber lining to a shaft. "Crib-biting" is a vicious habit in horses, probably due in the first instance to indigestion; the horse seizes the manger or other object in its teeth, and draws in the breath, known as "wind-sucking"; the habit may be checked by the use of a throat-strap. The slang meaning of the verb "crib," to steal, especially used of petty thefts, is probably derived from an obsolete use of the substantive for a small wicker basket; this meaning occurs in the expression "time-cribbing," used of an illicit increase of the hours of labour in a factory or workshop, especially by the running of machinery each day slightly beyond the time of ceasing work. "Crib" and "cribbing" in this sense are also applied to any unacknowledged appropriation or plagiarism from an author, and particularly to the secret copying by a schoolboy of another's work or from a book, and also to the secret use of a translation and to such translation itself. "Crib," in the game of cribbage, of which it is a shortened form, is the term for the cards thrown away by each player and scored by the dealer.

**CRIBBAGE**, a game of cards. A very similar game called "Noddy" was formerly played, the game being fifteen or twenty-one up, marked with counters, occasionally by means of a noddy board. Cribbage seems to be an improved form of Noddy. According to John Aubrey (*Brief Lives*) it was invented by Sir John Suckling (1609-1642).

A complete pack of fifty-two cards is required, and a cribbage board for scoring, drilled with sixty holes for each player and one hole (called "the game hole") at each end, the players usually scoring from opposite ends. Each player has two scoring pegs. The game is marked by inserting the pegs in the holes, one after the other, as the player makes a fresh score, commencing with the outer row at the game-hole end and going up the board. When the thirtieth hole is reached the player comes down the board, using the inner row of holes, until he places his foremost peg in the game-hole. If the losing player fails to obtain half the holes, his adversary wins a "lurch," or double game.

The game may be played by two players, five or six cards being dealt to each, and each putting out two for what is called "crib"; or by three players (with a triangular scoring board), five cards being dealt to each, each putting out one for crib, and a card from the top of the pack being dealt to complete the crib; or by four players (two being partners against the other two, sitting and playing as at whist, and one partner scoring for both), five cards being dealt to each, and each putting out one card for crib.

Two-handed five-card cribbage was formerly considered the most scientific game, but this verdict has now been reversed in favour of the six-card game. In six-card cribbage both hands and crib contain four cards, and 121 holes are scored.

The players cut for deal, the lowest dealing. If more than one

game is played, the winner of the last game deals. The cards rank from king (highest) to the ace (lowest). At the two-handed five-card game, the non-dealer scores three holes (called "three for last") at any time during the game, but usually while the dealer is dealing the first hand. This is not part of the six-card game, which we take as our example.

The dealer deals six cards to each, singly. The undealt cards are placed face downwards on the table. The players then look at their hands and "lay out," each putting two cards face downwards on the table, on the side of the board nearest to the dealer, for the "crib." A player must not take back into his hand a card he has laid out if the cards have been covered, nor must the crib be touched during the play of his hand.

After laying out, the non-dealer (when more than two play, the player to the dealer's left) cuts the pack, and the dealer turns up the top card of the lower packet, called the "start," or "turn-up." If this is a knave, the dealer marks two "for his heels." This score is forfeited if not marked before the dealer plays a card.

The non-dealer plays first by laying face upwards on the table on his side of the board any card from his hand; the dealer then does the same, and so on alternately. When more than two play, the player to the leader's left plays the second card, and so on. As soon as the first card is laid down the player calls out the number of pips on it; if a picture card, ten. When the second card is laid down, the player calls out the sum of the pips on the two cards played, and so on until all the cards are played, or until neither player can play without passing the number thirty-one. If one player has a card or cards that will come in and the other has not, he is at liberty to play them; at the six-card game he must play as long as they can come in, and he can score runs or make pairs, &c., with them. If one player's cards are exhausted, the adversary plays out his own, and can score with them. When more than two play, the player next in rotation is bound to play, and so on until no one can come in. At the two-handed five-card game, when neither can come in the play stops; at the other games the cards are played turned down, and the remainder of the cards are played in rotation, and so on until all are played out.

The object of the play is to make *pairs*, *fifteens*, *sequences*, and the "go," and to prevent the adversary from scoring.

*Pairs*.—If a card is put down of the same denomination as the one last played, the player pairing scores two holes. If a third card of the same denomination is next played, a "pair royal" (abbreviated to "prial") is made, and the maker scores six holes. If a fourth card of the same denomination is next played, twelve holes are scored for the "double pair royal." Kings pair only with kings, queens with queens, and so with knaves and tens, notwithstanding that they all count ten in play.

*Fifteens*.—If either player during the play reaches fifteen exactly, by reckoning the values of all the played cards, he marks two.

*Sequences*.—If during the play of the hand three or more cards are consecutively played which make an ascending or descending sequence, the maker of the sequence marks one hole for each card forming the sequence or run. King, queen, knave and ten reckon in sequence in this order, notwithstanding that they are all tenth cards in play; the other cards according to the number of their pips. The ace is not in sequence with king, queen. If one player obtains a run of three, his adversary can put down a card in sequence and mark four, and so on. And, if there is a break in the sequence, and the break is filled up during the play, without the intervention of a card not in sequence, the player of the card that fills the break scores a run. Thus the cards are played in this order: A-4, B-3, A-2, B-ace, A gets a run of three, B a run of four. Had B's last card been a five, he would similarly have scored a run of four, as there is no break. Had B's last card been a four, he would have scored a run of three. The cards need not be played in order. Thus the cards being played in this order, A-4, B-2, A-5, B-3, A-6, A-4, B-2, A-5, B-3, A-5, B-6, B takes a run of four for the fourth card played, but there is no run for any one else, as the second five intervenes. Again, if the cards at six-card cribbage are thus played, A-4, B-2, A-3, B-ace, A-5, B-2, A-4, B-ace, A takes a run of three, B a run of four, A a run of five. B then playing the deuce has no run, as the deuce previously played intervenes.

The "go," end hole or last card is scored by the player who approaches most nearly to thirty-one during the play, and entitles to a score of one. If thirty-one is reached exactly, it is a go of two instead of one. After a go no card already played can be counted for pairs or sequences.

**Compound Scores.**—More than one of the above scores can be made at the same time. Thus a player pairing with the last card that will come in scores both pair and go. Similarly a pair and a fifteen, or a sequence and a fifteen, can be reckoned together.

When the play is over, the hands are shown and counted aloud. The non-dealer has first show and scores and marks first; the dealer afterwards counts, scores and marks what he has in hand, and then takes what is in crib. In counting both hands and crib the "start" is included, so that five cards are involved.

The combinations in hand or crib which entitle to a score are fifteen, pairs or pairs royal, sequences, flushes and "his nob."

**Fifteens.**—All the combinations of cards that, taken together, make fifteen exactly, count two. For example, a ten (King, Queen, Knave or Ten) card and a five reckon two, called as "fifteen two." Another five in the hand or turned up would again combine with the ten card, and entitle to another fifteen ("fifteen four"); if the other cards were a two and a three, two other fifteens would be counted ("fifteen six," "fifteen eight")—one for the combination of the three and two with the ten card, and one for the combination of the two fives with the three and two. Similarly: two ten cards and two fives reckon eight; a nine and three threes count six; and so on for other cards.

**Pairs.**—Pairs are reckoned as in play.

**Sequences.**—Three or more cards in sequence count one for each card. If one sequence card can be substituted for another of the same denomination, the sequence reckons again. For example, 3, 4, 5 and a 3 turned up reckon two sequences of three; with another 3 there would be three sequences of three, and so on.

**Flushes.**—If all the cards in hand are of the same suit, one is reckoned for each card. If the start is also of the same suit, one is reckoned for that also. In crib, no flush is reckoned unless the start is of the same suit as the cards in crib.

**His Nob.**—If a player holds the knave of the suit turned up for the start he counts one "for his nob."

A dialogue will illustrate the technical conversation of the game, in a game at six-card cribbage. The cards for crib having been discarded, A holds knave of hearts, a four and a pair of twos; B holds a pair of nines, a six and a four. Two of hearts is turned up by B. The hand might be played thus. A lays down a two and says "Two": B plays a nine and says "Eleven": A follows with a four, saying "Fifteen two"; pegging two holes at once: B plays his four and says "Nineteen; two for a pair," and pegs: A putting on his knave, "Twenty-nine": B says "Go." A lays down his two, his last card, and says "Thirty-one; good for two." B plays his nine and six, saying "Fifteen two, and one for my last—three." The points are marked as they are made. A then counts his hand aloud. "Six for a pair-royal" or "Three twos—good for six," and "One for his nob—seven," and throws down his hand for B's inspection. B, "Fifteen two, fifteen four, fifteen six, fifteen eight, and a pair are ten." B then looks at his crib and counts it. It contains, say, king, eight, three, ace and the "start" is also reckoned. B counts "Fifteen two and a run of three—five."

After the points in hand and crib are reckoned, the cards are shuffled and dealt again, and so on alternately until the game is won.

The highest possible score in hand is 29—three fives and a knave, with a five, of the same suit as the knave, turned up.

**CRICCIETH**, a watering-place and contributory parliamentary borough of Carnarvonshire, Wales, on Cardigan Bay, served by the Cambrian railway. Pop. of urban district (1901) 1406. It is interesting for its high antiquity and the ruined castle, a fortress on an eminence where a neck of land ends, projecting into the sea. Portions of two towers are on the very verge of the rock. A double fosse and vallum, with the outer and inner court lines, can be traced. Apparently British, the castle was repaired later, probably in the time of Edward I. Across the bay is seen Harlech castle, backed by the Merionethshire hills. An old county-family mansion near Criccieth is Gwynfryn (happy hill), the seat of the Nanneys, situated near the stream Dwyfawr and within some 7 m. of Pwllheli. Not far is a tumulus, *Tomen-fawr*. At a distance of 5 m. is Tremadoc (which owes its name, Town of Madocks—as does Portmadoc—to Mr W. Madocks, of Morfa Lodge, who made the embankment here). Criccieth has become a favourite watering-place, as well as a centre of excursions. The neighbourhood is agreeable, and the Cardigan Bay shore is shelving and suitable for safe bathing. Cantref y Gwaelod (the hundred of the bottom) is the Welsh literary name of this bay, on the shores of which geological depression has certainly taken place. Mythical history relates how Seithennin's drunkenness inundated the land now covered by the bay, and how King Arthur's ship was wrecked upon Meisdiroedd Enlli near Bardsey. The *Mabinogion* tell how Harlech was a port. Similarly, in Carnarvon Bay, about 2 m. seaward, at

low water, are visible the ruins of Caerariarnhod (fortified town of the silver wheel), a submerged town—due to another geological depression.

**CRICHTON, JAMES** (1560-? 1582), commonly called the "Admirable Crichton," was the son of Robert Crichton, lord advocate of Scotland in the reign of Mary and James VI., and of Elizabeth, daughter of Sir James Stewart of Beath, through whom he claimed royal descent. He was born probably at Eliock in Dumfriesshire in 1560, and when ten years old was sent to St Salvator's College, St Andrews, where he took his B.A. in 1574 and his M.A. in 1575. In 1577 Crichton was undoubtedly in Paris, but his career on the continent is difficult to follow. That he displayed considerable classical knowledge, was a good linguist, a ready and versatile writer of verse, and above all that he possessed an astounding memory, seems certain, not only from the evidence of men of his own time, but from the fact that even Joseph Scaliger (*Prima Scaligerana*, p. 58, 1669) speaks of his attainments with the highest praise. But those works of his which have come down to us show few traces of unusual ability; and the laudation of him as a universal genius by Sir Thomas Urquhart and Aldus Manutius requires to be discounted. Urquhart (in his *Discovery of a most exquisite jewel*) states that while in Paris Crichton successfully held a dispute in the college of Navarre, on any subject and in twelve languages, and that the next day he won a tilting match at the Louvre. There is, however, no contemporary evidence for this, the only certain facts being that for two years Crichton served in the French army, and that in 1579 he arrived in Genoa. The latter event is proved by a Latin address (of no particular merit) to the Doge and Senate entitled *Oratio J. Crictonii Scoti pro Moderatorum Genuensis Reipubl. electione coram Senatu habita* . . . (Genoa, 1579). The next year Crichton was in Venice, and won the friendship of Aldus Manutius by his Latin ode *In appulsu ad urbem Venetiam de Proprio statu J. Crictonii Scoti Carmen ad Aldum Manuucium* . . . (Venice, 1580). The best contemporary evidence for Crichton's stay in Venice is a handbill printed by the Guerra press in 1580 (and now in the British Museum), giving a short biography and an extravagant eulogy of his powers; he speaks ten languages, has a command of philosophy, theology, mathematics; he improvises Latin verses in all metres and on all subjects, has all Aristotle and his commentators at his fingers' ends; is of most beautiful appearance, a soldier from top to toe, &c. This work is undoubtedly by Manutius, as it was reprinted with his name in 1581 as *Relazione della qualità di . . . Crettone*, and again in 1582 (reprinted Venice, 1831).

In Venice Crichton met and vanquished all disputants except Giacomo Mazzoni, was followed from place to place by crowds of admirers, and won the affection of the humanists Lorenzo Massa and Giovanni Donati. In March 1581 he went to Padua, where he held two great disputations. In the first he extemporized in succession a Latin poem, a daring onslaught on Aristotelian ignorance, and an oration in praise of ignorance. In the second, which took place in the Church of St John and St Paul, and lasted three days, he undertook to refute innumerable errors in Aristotelians, mathematicians and schoolmen, to conduct his dispute either logically or by the secret doctrine of numbers, &c. According to Aldus, who attended the debate and published an account of it in his dedication to Crichton prefixed to Cicero's "Paradoxa" (1581), the young Scotsman was completely successful. In June Crichton was once more in Venice, and while there wrote two Latin odes to his friends Lorenzo Massa and Giovanni Donati, but after this date the details of his life are obscure. Urquhart states that he went to Mantua, became the tutor of the young prince of Mantua, Vincenzo di Gonzaga, and was killed by the latter in a street quarrel in 1582. Aldus in his edition of Cicero's *De universitate* (1583), dedicated to Crichton, laments the 3rd of July as the fatal day; and this account is apparently confirmed by the Mantuan state papers recently unearthed by Mr Douglas Crichton (*Proc. Soc. of Antiquaries of Scotland*, 1909). Mr Sidney Lee (*Dict. Nat. Biog.*) argued against this date, on the ground that in 1584 and 1585 Crichton was alive and in Milan, as certain works of his published in that year testified, and

regarded it as probable that he died in Mantua c. 1585/6. But these later works seem to have been by another man of the same name. The epithet "admirable" (*admirabilis*) for Crichton first occurs in John Johnston's *Heroes Scoti* (1603). It is probably impossible to recover the whole truth either as to Crichton's death or as to the extent of his attainments, which were so quickly elevated into legendary magnitude.

**BIBLIOGRAPHY.**—Sir Thomas Urquhart's *Discovery of a most excellent jewel* (1652; reprinted in the Maitland Club's edition of Urquhart's Works in 1834) is written with the express purpose of glorifying Scotland. The panegyrics of Aldus Manutius require to be received with some caution, since he was given to exaggerating the merits of his friend, and uses almost the same language about a young Pole named Stanilaus Niegosevski; see John Black's *Life of Torquato Tasso*, ii. 413-451 (1810), for a criticism. The *Life of Crichton*, by P. Fraser Tytler (2nd ed., 1823), contains many extracts from earlier writers; see also "Notices of Sir Robert Crichton of Cluny and of his son James," by John Stuart, in *Proceedings Soc. of Antiquaries of Scotland*, vol. ii. pp. 103-118 (1855); and the article by Andrew Lang, "The death of the Admirable Crichton," in the *Morning Post* (London), Feb. 25, 1910. W. Harrison-Ainsworth in his novel *Crichton* (new ed., 1892) reprints and translates some documents relating to Crichton, as well as some of his poems.

**CRICKET** (*Gryllidae*), a family of saltatory Orthopterus Insects, closely related to the Locustidae. The wings when folded form long slender filaments, which often reach beyond the extremity of the body, and give the appearance of a bifid tail, while in the male they are provided with a stridulating apparatus by which the well-known chirping sound, to which the insect owes its name, is produced. The abdomen of the female ends in a long slender ovipositor, which, however, is not exerted in the mole cricket. The house cricket (*Gryllus domesticus*) is of a greyish-yellow colour marked with brown. It frequents houses, especially in rural districts, where its lively, if somewhat monotonous, chirp may be heard nightly in the neighbourhood of the fireplace. It is particularly fond of warmth, and is thus frequently found in bakeries, where its burrows are often sunk to within a few inches of the oven. In the hot summer it goes out of doors, and frequents the walls of gardens, but returns again to its place by the hearth on the first approach of cold, where, should the heat of the fire be withdrawn, it becomes dormant. It is nocturnal, coming forth at the evening twilight in search of food, which consists of bread crumbs and other refuse of the kitchen. The field cricket (*Gryllus campestris*) is a larger insect than the former, and of a darker colour. It burrows in the ground to a depth of from 6 to 12 in., and in the evening the male may be observed sitting at the mouth of its hole noisily stridulating until a female approaches, "when," says Bates, "the louder notes are succeeded by a more subdued tone, whilst the successful musician caresses with his antennae the mate he has won." The musical apparatus in this species consists of upwards of 130 transverse ridges on the under side of one of the nervures of the wing cover, which are rapidly scraped over a smooth, projecting nervure on the opposite wing. The female deposits her eggs—about 200 in number—on the ground, and when hatched the larvae, which resemble the perfect insect except in the absence of wings, form burrows for themselves in which they pass the winter. The mole cricket (*Gryllotalpa vulgaris*) owes its name to the striking analogy in its habits and structure to those of the common mole. Its body is thick and cylindrical in shape, and it burrows by means of its front legs, which are short and greatly flattened out and thickened, with the outer edge partly notched so as somewhat to resemble a hand. It prefers loose and sandy ground in which to dig, its burrow consisting of a vertical shaft from which long horizontal galleries are given off; and in making those excavations it does immense injury to gardens and vineyards by destroying the tender roots of plants, which form its principal food. It also feeds upon other insects, and even upon the weak of its own species in the absence of other food. It is exceedingly fierce and voracious, and is usually caught by inserting a stem of grass into its hole, which being seized, is retained till the insect is brought to the surface. The female deposits her eggs in a neatly constructed subterranean chamber, about the size of a hen's egg, and sufficiently near the surface to allow of the eggs being hatched by the heat of the sun.

**CRICKET.** The game of cricket may be called the national summer pastime of the English race. The etymology of the word itself is the subject of much dispute. The *Century Dictionary* connects with O. Fr. *criquet*, "a stick used as a mark in the game of bowls," and denies the connexion with A.S. *crice* or *crice*, a staff. A claim has also been made for *cricket*, meaning a stool, from the stool at which the ball was bowled, while in the wardrobe account of King Edward I. for the year 1300 (p. 126) is found an allusion to a game called *creag*. Skeat, in his *Etymological Dictionary*, states that the word is probably derived from A.S. *crice* (repudiated by the first authority quoted), the meaning of which is a staff, and suggests that the "et" is a diminutive suffix; the word is of the same origin as "crutch." Finally the *New English Dictionary* traces the O. Fr. *criquet*, defined by Littré as "*jeu d'adresse*," to M. Flem. *Krick*, *Krücke*, *baston à s'appuyer*, *quoinette*, *potence*.

**History.**—In a MS. of the middle of the 13th century, in the King's library, 14 Bv, entitled *Chronique d'Angleterre, depuis Ethelberd jusqu'à Hen. III.*, there is found a grotesque delineation of two male figures playing a game with a bat and ball. This is undoubtedly the first known drawing of what was destined to develop into the scientific cricket of modern times. The left-hand figure is that of the batsman, who holds his weapon upright in the right hand with the handle downwards. The right-hand figure shows the catcher, whose duty is at once apparent by the extension of his hands. In another portion of the same MS., however, there is a male figure pointing a bat towards a female figure in the attitude of catching, but the ball is absent. In a Bodleian Library MS., No. 264, dated the 18th of April 1344, and entitled *Romance of the Good King Alexander*, fielders for the first time appear in addition to the batsman and bowler. All the players are monks (not female figures, as Strutt misinterprets their dress in his *Sports and Pastimes*), and on the extreme left of the picture, the bowler, with his cowl up, poises the ball in the right hand with the arm nearly horizontal. The batsman comes next with his cowl down, a little way only to the right, standing sideways to the bowler with a long roughly-hewn and slightly-curved bat, held upright, handle downwards in the left hand. On the extreme right come four figures—with cowls alternately down and up, and all having their hands raised in an attitude to catch the ball. It has been argued that the bat was always held in the left hand at this date, since on the opposite page of the same MS. a solitary monk is figured with his cowl down, and also holding a somewhat elongated oval-shaped implement in his left hand; but it is unsafe to assume that the accuracy of the artist can be trusted.

The close roll of 39 Edw. III. (1365), Men. 23, disparages certain games on account of their interfering with the practice of archery, where the game of cricket is probably included among the pastimes denounced as "*ludos inhonestos, et minus utiles aut valentes*." In this instance cricket was clearly considered fit for the lower orders only, though it is evident from the entry in King Edward's wardrobe account, already mentioned, that in 1300 the game of *creag* was patronized by the nobility. Judging from the drawings, it can only be conjectured that the game consisted of bowling, batting and fielding, though it is known that there was an in-side and an out-side, for sometime during the 15th century the game was called "*Hondyn or Hondoute*," or "*Hand in and Hand out*." Under this title it was interdicted by 17 Edw. IV. c. 3 (1477-1478), as one of those illegal games which still continued to be so detrimental to the practice of archery. By this statute, any one allowing the game to be played on his premises was liable to three years' imprisonment and £20 fine, any player to two years' imprisonment and £10 fine, and the implements to be burnt. The inference that hand in and hand out was analogous to cricket is made from a passage in the Hon. Daines Barrington's *Observations on the more Ancient Statutes from Magna Charta to 21 James I. cap. 27*. Writing in 1766, he comments thus on the above statute, viz.: "This is, perhaps, the most severe law ever made against gaming, and some of these forbidden sports seem to have been manly exercises, particularly the *handyn* and *handoute*, which I should suppose



to be a kind of cricket, as the term *hands* is still retained in that game."

The word "cricket" occurs about the year 1550. In Russell's *History of Guildford* it appears there was a piece of waste land in the parish of Holy Trinity in that city, which was enclosed by one John Parish, an innholder, some five years before Queen Elizabeth came to the throne. In 35 Elizabeth (1593) evidence was taken before a jury and a verdict returned, ordering the garden to be laid waste again and disinclosed. Amongst other witnesses John Derrick, gent., and one of H.M.'s coroners for Surrey, *aetat.* fifty-nine, deposed he had known the ground for fifty years or more, and "when he was a scholler in the free school of Guildford, he and several of his fellowes did runne and play there at *crickett* and other plaies." In the original edition of Stow's *Survey of London* (1598) the word does not occur, though he says, "The ball is used by noblemen and gentlemen in tennis courts, and by people of the meaner sort in the open fields and streets."

Some noteworthy references to the game may be cited. In Giovanni Florio's dictionary *A Worlde of Wordes most Copious and Exact*, published in Italy in 1595 and in London three years later, *squillare* is defined as "to make a noise as a cricket, to play cricket-a-wicket and be merry." Sir William Dugdale states that in his youth Oliver Cromwell, who was born in 1599, threw "himself into a dissolute and disorderly course," became "famous for football, cricket, cudgelling and wrestling," and acquired "the name of royster." In Randle Cotgrave's *Dictionary of French and English*, dated 1611, *Crosse* is translated "crossier or bishop's staffe wherewith boys play at cricket," and *Crosser* "to play at cricket."

Among the earliest traces of cricket at public schools is an allusion to be found in the *Life of Bishop Ken* by William Lisle Bowles (1830). Concerning the subject of this biography, who was admitted to Winchester on the 13th of January 1650/1, it is said "on the fifth or sixth day, our junior . . . is found for the first time attempting to wield a cricket bat." In 1688 a "ram and bat" is charged in an Etonian's school bill, but it is possible this may only refer to a cudgel used for ram-baiting. In *The Life of Thomas Wilson, Minister of Maidstone*, published anonymously in 1672, Wilson having been born in 1601 and dying in or about 1653, occurs the following passage (p. 40): "Maidstone was formerly a very profane town, in as much as I have seen morrice-dancing, cudgel-playing, stool-ball, crickets, and many other sports openly and publicly indulged in on the Lord's Day." Cricket is found enumerated as one of the games of Gargantua in *The Works of Rabelais*, translated in 1653 by Sir Thomas Urquhart (Urquhart), vol. i. ch. xxii. p. 97. In a poem entitled *The Mysteries of Love and Eloquence or the Arts of Wooing and Complimenting* (1658), by Edward Phillips, John Milton's nephew, the mistress of a country bumpkin when she goes to a fair with him says "Would my eyes had been beaten out of my head with a cricket ball." The St Alban's Cricket Club was founded in 1661, one of its earliest presidents being James Cecil, 4th earl of Salisbury (1666-1694).

In 1662 John Davies of Kidwelly issued his translation of Adam Olearius' work entitled *The Voyages and Travels of the Ambassadors from the Duke of Holstein to the Grand Duke of Muscovy, and the King of Persia. Begun in the year 1633 and finished in 1639.* On page 297 is a description of the exercises indulged in by the Persian grandees in 1637, and the statement is made that "They play there also at a certain game, which the Persians call *Kuitskaukan*, which is a kind of *Mall*, or *Cricket*." In the Clerkenwell parish book of 1668 the proprietor of the Rum Inn, Smithfield, is found rated for a cricket field.

The chaplain of H.M.S., "Assistance," Rev. Henry Teonge, states in his diary that during a visit to Antioch on the 6th of May 1676, several of the ship's company, accompanied by the consul, rode out of the city early and amongst other pastimes indulged in "krickett." During the first half of the 18th century the popularity of the game increased and is frequently mentioned by writers of the time, such as Swift, who alludes sneeringly to

"footmen at cricket," D'Urfey, Pope, Soame Jenyns, Strype in his edition of Stow's *Survey of London*, and Arbuthnot in *John Bull*, iv. 4, "when he happened to meet with a football or a match at cricket."

In 1748 it was decided that cricket was not an illegal game under the statute 9 Anne, cap. 19, the court of king's bench holding "that it was a very manly game, not bad in itself, but only in the ill use made of it by betting more than ten pounds on it; but that was bad and against the law." Frederick Louis, prince of Wales, died in 1751 from internal injuries caused by a blow from a cricket ball whilst playing at Cliefden House. Games at this period were being played for large stakes, ground proprietors and tavern-keepers farming and advertising matches, the results of which were not always above suspicion. The old Artillery Ground at Finsbury was one of the earliest sites of this type of fixture. Here it was that the London Club—formed about 1700—played its matches. The president was the prince of Wales, and many noblemen were among its supporters. It flourished for more than half a century. One of the very earliest full-scores kept in the modern fashion is that of the match between Kent and All England, played on the Artillery Ground on the 18th of June 1744.

Cricket, however, underwent its most material development in the southern counties, more especially in the hop-growing districts. It was at the large hop-fairs, notably that of Weyhill, to which people from all the neighbouring shires congregated, that county matches were principally arranged.

The famous Hambledon Club lasted approximately from 1750 to 1791. Its matches were played on Broad Half-Penny and Windmill Downs, and in its zenith the club frequently contended with success against All England. The chief players were more or less retainers of the noblemen and other wealthy patrons of cricket. The original society was broken up in 1791 owing to Richard Nyren, their "general," abandoning the game, of which in consequence "the head and right arm were gone." The dispersion of the players over the neighbouring counties caused a diffusion of the best spirit of the game, which gradually extended northward and westward until, at the close of the 18th century, cricket became established as the national game, and the custom became general to play the first game of each year on Good Friday.

The M.C.C. (or Marylebone Cricket Club), which ranks as the leading club devoted to the game in any part of the globe, sprang from the old Artillery Ground Club, which played at Finsbury until about 1780, when the members migrating to White Conduit Fields became the White Conduit Cricket Club. In 1787 they were remodelled under their present title, and moved to Lord's ground, then on the site of what is now Dorset Square; thence in 1811 to Lord's second ground nearer what is now the Regent's Canal; and in 1814, when the canal was cut, to what is now Lord's ground in St John's Wood. Thomas Lord, whose family were obliged to leave their native Scotland on account of their participation in the rebellion of 1745, was born in Thirsk, Yorkshire, in 1757, and is first heard of as an attendant at the White Conduit Club, London, in 1780. Soon afterwards he selected and superintended a cricket ground for the earl of Winchelsea and other gentlemen, which was called after his name. He died in 1832 on a farm at West Meon, Hampshire, of which he took the management two years before. Lord took away the original turf of his cricket-ground at each migration and relaid it. In 1825 the pavilion was burnt down, invaluable early records of the game being destroyed; and in the same year the ground would have been broken up into building plots had not William Ward purchased Lord's interest. Dark bought him out in 1836, selling the remainder of his lease to the club in 1864. Meanwhile, in 1860, the freehold had been purchased at public auction by a Mr Marsden—*né* Moses—for £7000, and he sold it to the club six years later for nearly £18,500, a similar sum being paid in 1887 for additional ground. In 1897 the Great Central railway company conveyed a further portion to the club, making the ground complete as it now is; the total area is about 20 acres, including the site of various villas adjoining

the ground which are part of the property. The number of members now considerably exceeds five thousand.

**Laws.**—The oldest laws of cricket extant are those drawn up by the London Club in 1744. These were amended at the "Star and Garter" in Pall Mall, London, in 1755, and again in 1774, and were also revised by the M.C.C. in 1788. From this time the latter club has been regarded as the supreme authority, even though some local modifications have in recent years been effected in Australia. Alterations and additions have been frequently made, and according to the present procedure they have to be approved by a majority of two-thirds of the members present at the annual general meeting of the whole club; the administration being in the hands of a president, annually nominated by his outgoing predecessor, a treasurer and a committee composed of sixteen members, four annually retiring, in conjunction with a secretary and a large subordinate staff.

**Implements.**—Concerning the implements of the game, in the 1744 rules it was declared that the weight of the ball must be "between five and six ounces," and it was not until 1774 that it was decided that it "shall weigh not less than five ounces and a half nor more than five ounces and three-quarters," as it is to the present day. Not until 1838 however came the addition, "it shall measure not less than nine inches nor more than nine inches and a quarter in circumference." The materials out of which the old balls were made are not on record. At present a cube of cork forms the foundation, round which layers of fine twine and thin shavings of cork are accumulated till the proper size and shape are attained, when a covering of red leather is sewn on with six parallel seams. Various "compositions" have been tried as a substitute for cork and leather, but without taking their place.

For the bat, English willow has been proverbially found the best wood. The oldest extant bats resemble a broad and curved hockey stick, and it has been claimed to be an evolution of the club employed in the Irish game of "hurley." The straight blade was adopted as soon as the bowler began to pitch the ball up, an alteration which took place about 1750, but pictures show slightly curved bats almost to the time of the battle of Waterloo. The oldest were all made in one piece and were so used until the middle of the 19th century, when handles of ash were spliced into the blade, and the whole cane-handle was introduced about 1860. No limit was set to the length of the bat until 1840, though the width was restricted to 4½ in. "in the widest part" by the laws of 1788, and a gauge was made for the use of the Hambledon Club. The length of the bat is now restricted to 38 in., 36 being more generally used, as a rule the handle being 14 in. long and the blade 22 in. As to weight, though there is no restriction, 2 lb 3 oz. is considered light, 2 lb 6 oz. fairly heavy; but W. Ward (1787-1849) used a bat weighing 4 lb.

At present the wicket consists of three stumps (round straight pieces of wood) of equal thickness, standing 27 in. upright out of the ground. On the top are two "bails," short pieces of wood which fit into grooves made in the top of the stumps so as not to project more than half an inch above them. But the evolution of the wicket has been very gradual, and the history of it is very obscure, since different types of wickets seem to have existed simultaneously. If early pictures are to be trusted, no wicket was required in primitive times: the striker was either caught out, or run out, the fieldsman having to put the ball into a hole scooped in the ground, before the batsman could put his bat into it. A single stump, it is supposed, was sometimes substituted for the hole to save collision between the bat and the fieldsman's fingers. In due course, but at an unknown date, a wicket—a "skeleton gate"—was raised over the hole; it consisted of two stumps each 12 in. high, set 24 in. apart, with a third laid on the top of them. John Nyren, however, writing in 1833, and discussing some memoranda given him by Mr W. Ward, says apropos of these dimensions, "There must be a mistake in this account of the width of the wicket." Undoubtedly such wickets were all against the bowler, who must have bowled over or through the wicket twenty times for every

occasion when he succeeded in hitting either the uprights or the cross stump. In pictures of cricket played about 1743 we find only two stumps and a cross stump, or bail, the wicket varying apparently both in height and width. In a picture, the property of H.M. the King, entitled "A Village Match in 1768," three stumps and a bail are distinctly shown. Two stumps are shown as used in 1779, afterwards three always with one exception. Two prints, advertisements, representing matches played between women on consecutive days in 1811, show, one of them a wicket of three stumps, the other a wicket of two. The addition of the third stump, as is universally agreed, was due to an incident which occurred in a match of the Hambledon Club in 1775. "It was observed at a critical point in the game, that the ball passed three times between Mr Small's two stumps without knocking off the bail; and then, first a third stump was added, and seeing that the new style of balls which rise over the bat also rise over the wicket, then but 1 ft. high, the wicket was altered to the dimensions of 22 in. by 8, and to its present dimensions of 27 in. by 8 in 1817." So writes the Rev. J. Pycroft (1813-1895), quoting fairly closely from Nyren, who wrote many years after the event; but Pycroft is wrong in writing 22 by 8, which should really be 22 by 6. It is hard to believe that the 12 by 24 wicket lasted as long as 1775, for in the laws issued after the meeting held at the "Star and Garter," Pall Mall, where many "noblemen and gentlemen" attended "finally to settle" the laws of the game, we read that the stumps are to be 22 in. and the bail 6. "N.B.—It is lately settled to use three stumps instead of two to each wicket, the bail the same length as before." Regarding all the circumstances one is tempted to believe that Small defended a wicket of two stumps, 22 in. high and 6 in. apart, strange as is the circumstance that the ball should thrice in a short innings—for Small only made 14 runs—pass through them without dislodging the bail, even though the diameter of the ball is a trifle less than 3 in. Allusion is also found to a wicket 12 in. by 6, but it is hard to believe in its existence, unless it was used as a form of handicap. It should be recorded that in advertisements of matches about this time (1787) the fact that three stumps will be used "to shorten the game" is especially mentioned, and that the *Hampshire Chronicle* of the 15th of July 1797 records that "The earl of Winchilsea has made an improvement in the game of cricket, by having four stumps instead of three, and the wickets 2 in. higher. The game is thus rendered shorter by easier bowling out." In 1788, however, when the M.C.C. revised the laws, reference is made to stumps (no number given, but probably three) 22 in. high and a bail of 6 in. Big scoring in 1796 caused the addition next year of 2 in. to the height and of 1 to the breadth, making the wicket 24 in. by 7. That three stumps were employed is shown by a print of the medallion of the Oxfordshire County C.C. 1797, forming the frontispiece to Taylor's *Annals of Lord's* (1903). In 1817 the dimensions now in use were finally settled, three stumps 27 in. high, and a wicket 8 in. wide. Larger wickets have occasionally been used by way of handicap or experiment. The distance between the wickets seems always, or at least as far back as 1700, to have been 22 yds.—one chain.

**The Game.**—Cricket is defined in the *New English Dictionary* as "an open-air game played with bats, ball and wickets by two sides of eleven players each; the batsman defends his wicket against the ball which is bowled by a player of the opposing side, the other players of this side being stationed about the field in order to catch or stop the ball." The laws define that the score shall be reckoned by runs. The side which scores the greatest number of runs wins the match. Each side has two innings taken alternately, except that the side which leads by 150 runs in a three days' match or by 100 runs in a two days' match or by 75 runs in a one day match shall have the option of requiring the other side to "follow their innings." In England cricket is invariably played on turf wickets, but in the Colonies matting wickets are often employed, and sometimes matches have taken place on sand, earth and other substances. The oldest form of the game is probably single wicket, which consists of one

batsman defending one wicket, but this has become obsolete, though it was very popular in the time when matches were played for money with only one or two, or perhaps four or five, players on a side. Matches between an unequal number of players are still sometimes arranged, but mainly in the case of local sides against touring teams, or "colts" playing against eleven experienced cricketers. In any case two umpires are always appointed, and for English first-class county cricket these are now annually chosen beforehand by the county captains. Two scorers are officially recognized. All the arrangements as to scoreboards, and accommodation for players, members of the club and general spectators, vary considerably according to local requirements. Between six and seven acres forms the most suitable area for a match, but the size of a cricket ground has never been defined by law.

The wickets are pitched opposite and parallel to one another at a distance of 22 yds.; the "bowling crease" being marked with whitewash on the turf on a line with the stumps 8 ft. 8 in. in length, with short "return creases" at right angles to it at each end; but the "popping crease," marked parallel to the wicket and 4 ft. in front of it, is deemed of unlimited length. The captains of the opposing sides toss for choice of innings, and the winner of the toss, though occasionally, owing to the condition of the ground or the weather prospects, electing to put his adversaries in first, as a general rule elects for his own side to bat first. The captain of the batting side sends his eleven (or whatever the number of his team may be) in to bat in any order he thinks best, and much judgment is used in deciding what this order shall be. Two batsmen with strong defensive powers and good nerve are usually selected to open the innings, the most brilliant run-getters immediately following them, and the weakest batsmen going in last. As there must always, except in the obsolete single-wicket cricket, be two batsmen in together, it follows that when ten of the side (in a side of eleven) have been put out, one of the final pair must be "not out"; that is to say, his innings is terminated without his getting out because there is none of his side left to become his partner. The batsman who is thus "not out" is said to "carry his bat," a phrase that recalls a period when two bats sufficed for the whole side, each retiring batsman leaving the implement on the ground for the use of his successor, till at the close of the innings the "not out" man carried it back to the tent or pavilion. As the phrase is not also applied to the last batsman to get out, who would of course have carried the second bat off the ground, it was possibly at one time restricted to a player who going in first survived through the whole innings. It should be observed that the term "wicket" is used by cricketers in a number of different senses. Besides being the name given to the set of three stumps with their two bails when pitched for a match, it is in an extended sense applied to that portion of the ground, also called the "pitch," on which the stumps are pitched, as when it is described as being "a fast wicket," a "sticky wicket" and so forth. It also in several idiomatic expressions signifies the getting out of a batsman and even the batsman himself, as in the phrases: "Grace lost his wicket without scoring," "Grace went in first wicket down," "when Grace got out England lost their best wicket," "England beat Australia by two wickets."

The umpires are required to decide questions arising in the course of play and to call the "overs," the "over" being a series of successive deliveries of the ball (usually six) by the bowler from one end of the pitch, the rest of the "out" side, or fielders, being stationed in various positions in the field according to well-defined principles. When an "over" has been bowled from one end a different bowler then bowls an "over" from the opposite end, the alternation being continued without interruption throughout the innings, and the bowlers being selected and changed from time to time by the captain of their side at his discretion. At the end of every over the fielders "change over" or otherwise rearrange their places to meet the batting from the other end. An over from which no runs are made off the bat is called a "maiden." A "run" is made when the two

batsmen change places, each running from his own to the opposite wicket without being "run out." The aim of the batting side is to make as many runs as possible, while the object of the fielding side is to get their opponents out, and to prevent their making runs while in.

There are nine ways in which the batsman, or "striker," can be put out. Of these the following five are the most important. (1) The striker is "bowled" out if the bowler hits the wicket with the ball, when bowling, and dislodges the bail; (2) he is "caught" out if the ball after touching his bat or hand be held by any member of the fielding side before it touches the ground; (3) he is "stumped" out if the wicket-keeper dislodges the bail with the ball, or with his hand holding the ball, at a moment when the striker in playing at the ball has no part of his person or bat in contact with the ground behind the popping crease, *i.e.* when the batsman is "out of his ground"; (4) he is out "l.b.w." (leg before wicket) if he stops with any part of his person other than his hand, or arm below the elbow, a ball which in the umpire's judgment pitched straight between the wickets and would have bowled the striker's wicket; (5) if when the batsmen are attempting to make a run a wicket is put down (*i.e.* the bail dislodged) by the ball, or by the hand of any fieldsmen holding the ball, at a moment when neither batsman has any part of his person or bat on the ground behind the popping crease, the nearer of the two batsmen to the wicket so put down is "run out." The remaining four ways in which a batsman may be dismissed are (6) hit wicket, (7) handling the ball, (8) hitting the ball more than once "with intent to score," and (9) obstructing the field.

The positions of the fieldsmen are those which experience proves to be best adapted for the purpose of saving runs and getting the batsmen caught out. During the middle of the 19th century these positions became almost stereotyped according to the pace of the bowler's delivery and whether the batsmen were right or left handed. A certain number of fielders stood on the "on" side, *i.e.* the side of the wicket on which the batsman stands, and a certain number on the opposite or "off" side, towards which the batsman faces. "Point" almost invariably was placed square with the striker's wicket some ten or a dozen yards distant on the "off" side; "cover point" to the right of "point" (as he is looking towards the batsman) and several yards deeper; "mid on" a few yards to the right of the bowler, and "mid off" in a corresponding position on his left, and so forth. Good captains at all times exercised judgment in modifying to some extent the arrangement of the field according to circumstances, but in this respect much was learnt from the Australians, who on their first visit to England in 1878 varied the positions of the field according to the idiosyncrasies of the batsmen and other exigencies to a degree not previously practised in England. The perfection of wicket-keeping displayed by the Australian, McCarthy Blackham (*b.* 1855), taught English cricketers that on modern grounds the "long stop" could be altogether dispensed with; and this position, which in former days was considered a necessary and important one, has since been practically abolished. In many matches at the present day, owing to the character of modern bowling, no more than a single fieldsmen is placed on the "on" side, while the number and positions of those "in the slips," *i.e.* behind the wicket on the "off" side, are subject to no sort of rule, but vary according to the nature of the bowling, the state of the ground, or any other circumstances that may influence the judgment of the captain of the fielding side. Charts such as were once common, showing the positions of the fielders for fast, slow and medium bowling respectively, would therefore to-day give no true idea of the actual practice; and much of the skill of modern captaincy is shown in placing the field.

The score is compiled by runs made by the batsman and by the addition of "extras," the latter consisting of "byes," "leg-byes," "wides" and "no-balls." All these are included in the designation "runs," of which the total score is composed, though neither "wides" nor "no-balls" involve any actual run on the part of the batsmen. They are called by the umpire on his own

initiative, in the one case if the bowler's delivery passes the batsman beyond the reach of his bat ("wide"), and in the other if he delivers the ball without having either foot touching the ground behind the "bowling crease" and within the "return crease," or if the ball be jerked or thrown instead of being *bona fide* "bowled." "Wides" and "no-balls" count as one "run" each, and all "extras" are added to the score of the side without being credited to any individual batsman. The batsman may, however, hit a "no-ball" and make runs off it, the runs so made being scored to the striker's credit instead of the "no-ball" being entered among the "extras." The batsman may be "run out" in attempting a run off a "no-ball," but cannot be put out off it in any other way. "Byes" are runs made off a ball which touches neither the bat nor the person of the batsman, "leg-byes" off a ball which, without touching the bat or hand, touches any other part of his person. With the exception of these "extras" the score consists entirely of runs made off the bat.

Batting is the most scientific feature of the game. Proficiency in it, as in golf and tennis, depends in the first instance to a great extent on the player assuming a correct attitude for making his stroke, the position of leg, shoulder and elbow being a matter of importance; and although a quick and accurate eye may occasionally be sufficient by itself to make a tolerably successful run-getter, good style can never be acquired, and a consistently high level of achievement can seldom be gained, by a batsman who has neglected these rudiments. Good batting consists in a defence that is proof against all the bowler's craft, combined with the skill to seize every opportunity for making runs that the latter may inadvertently offer. If the batsman's whole task consisted in keeping the ball out of his wicket, the accomplishment of his art would be comparatively simple; it is the necessity for doing this while at the same time he must prevent the ball from rising off his bat into the air in the direction of any one of eleven skilfully-placed fielders, each eager to catch him out, that offers scope for the science of a Grace, a MacLaren or a Trumper. In early days when the wickets were low and the ball was trundled along the ground, the curved bats of the old pictures were probably well adapted for hitting, defence being neglected; but when the height of the wickets was raised, and bowlers began to pitch the ball closer to the batsman so that it would reach the wicket on the first bound, defence of the wicket became more necessary and more difficult. Hence the modern straight-bladed bat was produced, and a more scientific method of batting became possible. Batting and bowling have in fact developed together, a new form of attack requiring a new form of defence. One of the first principles a young batsman has to learn is to play with a "straight bat" when defending his wicket against straight balls. This means that the whole blade of the bat should be equally opposite to the line on which the ball is travelling towards him, in order that the ball, to whatever height it may bound from the ground, may meet the bat unless it rises altogether over the batsman's hands; the tendency of the untutored cricketer being on the contrary to hold the bat sloping outwards from the handle to the point, as the golf-player holds his "driver," so that the rise of the ball is apt to carry it clear of the blade. Standing then in a correct position and playing with a straight bat, the batsman's chief concern is to calculate accurately the "length" of the ball as soon as he sees it leave the bowler's hand. The "length" of the ball means the distance from the batsman at which it pitches, and "good length" is the first essential of the bowler's art. The distance that constitutes "good length" is not, however, to be defined by precise measurement; it depends on the condition of the ground, and on the reach of the batsman. A "good-length ball" is one that pitches too far from the batsman for him to reach out to meet it with the bat at the moment it touches the ground or immediately it begins to rise, in the manner known as "playing forward"; and at the same time not far enough from him to enable him to wait till after it has reached the highest point in its bound before playing it with the bat, *i.e.* "playing back." When, owing to the good length of the ball, the batsman is unable to play it in either of these two ways, but is compelled to play at it in the middle of its

rise from the ground, he is almost certain, if he does not miss it altogether, to send it up in the air with the danger of being caught out. If through miscalculation the batsman plays forward to a short-pitched ball, he will probably give a catch to the bowler or "mid off," if he plays back to a well-pitched-up ball, he will probably miss it and be bowled out. The bowler is therefore continually trying to pitch balls just too short for safe forward play, while the batsman defends his wicket by playing forward or back as his judgment directs so long as the bowling is straight and of approximately good length, and is ready the instant he receives a bad-length ball, or one safely wide of the wicket, to hit it along the ground clear of the fieldsmen so as to make as many runs as he and his partner can accomplish before the ball is returned to the wicket-keeper or the bowler. But even those balls off which runs are scored are not to be hit recklessly or without scientific method. A different stroke is brought into requisition according to the length of the ball and its distance wide of the wicket to the "off" or "on" as the case may be; and the greatest batsmen are those who with an almost impregnable defence combine the greatest variety of strokes, which as occasion demands they can make with confidence and certainty. There are, however, comparatively few cricketers who do not excel in some particular strokes more than in others. One will make most of his runs by "cuts" past "point," or by wrist strokes behind the wicket, while others, like the famous Middlesex Etonian C. I. Thornton, and the Australian C. J. Bonnor, depend mainly on powerful "drives" into the deep field behind the bowler's wicket. Some again, though proficient in all-round play, develop exceptional skill in some one stroke which other first-class players seldom attempt. A good illustration is the "glance stroke" off the legs which K. S. Ranjitsinhji made with such ease and grace. All great cricketers in fact, while observing certain general principles, display some individuality of style, and a bowler who is familiar with a batsman's play is often aware of some idiosyncrasy of which he can take advantage in his attack.

Bowling is, indeed, scarcely less scientific than batting. It is not, however, so systematically taught to young amateurs, and it may be partly in consequence of this neglect that amateur bowling is exceedingly weak in England as compared with that of professionals. The evolution of the art of bowling, for it has been an evolution, is an interesting chapter in the history of cricket which can only be briefly outlined here. The fundamental law as to the proper mode of the bowler's delivering the ball is that the ball must be bowled, not thrown or jerked. When bowling underhand along the ground was superseded by "length bowling," it was found that the ball might be caused, by jerking, to travel at a pace which on the rough grounds was considered dangerous; hence the law against jerking, which was administered practically by chalking the inside of the bowler's elbow; if a chalk mark was found on his side, the ball was not allowed as fair. The necessity of keeping the elbow away from the side led gradually to the extension of the arm horizontally and to round-arm bowling, the invention of which is usually attributed to John Wills (or Willes; b. 1777) of Kent and Sussex. Nyren, however, says "Tom Walker (about 1790) began the system of throwing instead of bowling now so much the fashion"; and, "The first I recollect seeing revive this fashion was Wills, a Sussex man," the date of the revival being 1807. Walker was no-balled. Beldham (1766-1862) says, "The law against jerking was owing to the frightful pace Tom Walker put on, and I believe that he afterwards tried something more like the modern throwing-bowling. Willes was not the inventor of that kind, or round-arm bowling. He only revived what was forgotten or new to the young folk." Curiously enough, Beldham also writes of the same Tom Walker that he was "the first lobbing slow bowler" he ever saw, and that he "did feel so ashamed of such baby bowling, but after all he did more than even David Harris himself." Round-arm bowling was long and vigorously opposed, especially in 1826 when three matches were arranged between England and Sussex, the Sussex bowlers being round-arm bowlers. When England had lost the first two matches, nine of the professionals refused

to take part in the third, "unless the Sussex bowlers bowl fair, that is, abstain from throwing." Five of them did play and Sussex lost, but the new style of bowling had indicated its existence. In 1844 the M.C.C.'s revised law reads, "The ball must be bowled, not thrown or jerked, and the hand must not be above the shoulder in delivery." Round-arm bowling was thenceforth legal. In 1862 Willsher (1828-1885), the Kent bowler, was no-balled by the umpire (Lillywhite) for raising his hand too high, amid a scene of excitement that almost equalled a tumult. Overhand bowling was legalized on the 10th of June 1864 after strenuous opposition. In early days much importance was attached to great pace, but the success of the slow lobbing bowling (pitched up underhand) led to its cultivation; in both styles some of the best performers delivered the ball with a curious high action, thrusting the ball, as it were, from close under the arm-pit. When the advantages of bias (or twist, or break) were first known is not closely recorded, but we read of one Lamborn who (about 1800) could make the ball break from leg so that "the Kent and Surrey men could not tell what to make of that cursed twist of his." Whatever the pace of bowling, accuracy is the essential point, or, more correctly, the power of accurately varying pace, pitch and direction, so that the batsman is never at peace. If the bowler is a mere machine, the batsman soon becomes his master; but the question as to which of the two is supreme depends very largely on the condition of the turf, whether it be hard and true, soft and wet, hard and rough or soft and drying: the first pair of conditions favour the batsmen, the second pair the bowler.

The immense amount of labour and expense devoted to the preparation and care of cricket grounds has produced during the past quarter of a century a perfection of smoothness in the turf which has materially altered the character of the game. On the rough and fiery pitches of earlier days, on which a "long stop" was indispensable, the behaviour of the ball could not be reckoned upon by the batsman with any degree of confidence. The first ball of an "over" might be a "shooter," never rising as much as an inch off the ground, the next might bound over his head, and the third pursue some equally eccentric course. But on the best grounds of to-day, subject to the well-understood changes due to weather, the bound of the ball is so regular as to be calculable with reasonable certainty by the batsman. The result has been that in fine weather, when wickets are true and fast, bowlers have become increasingly powerless to defeat the batsmen. In other words the defence has been strengthened out of proportion to the attack. Bowlers have consequently to a great extent abandoned all attempt to bowl the wicket down, aiming instead at effecting their purpose by bowling close to but clear of the wicket, with the design of getting the batsman to give catches. Many batsmen of the stubbornly defensive type, known in cricket slang as "stonewallers," retaliated by leaving such balls alone together, or stopping them deliberately with the legs instead of the bat.

These tactics caused the game to become very slow; over after over was bowled without an attempt being made to score a run and without apparent prospect of getting a wicket. This not only injured the popularity of the game from the spectator's point of view, but, in conjunction with the enormous scores that became common in dry seasons, made it so difficult to finish a match within the three days to which first-class matches in England are invariably limited, that nearly 70% of the total number of fixtures in some seasons were drawn. Cricketers of an older generation have complained that the cause of this is partly to be found in the amount of time wasted by contemporary cricketers. These critics see no reason why half of a summer's day should be allowed to elapse before cricket begins, and they comment with some scorn on the interval for tea, and the fastidiousness with which play is frequently interrupted on account of imperfect light or for other unimperative reasons. Various suggestions have been made, including proposals for enlarging the wicket, for enabling the attack to hold its own against the increasing strength of the defence. But the M.C.C., the only recognized source of cricket legislation, has displayed

a cautious but wise conservatism, due to the fact that its authority rests on no sanction more formal than that of prestige tacitly admitted by the cricketing world; and consequently no drastic changes have been made in the laws of the game, the only important amendments of recent years being that which now permits a side to close its innings voluntarily under certain conditions, and that which, in substitution for the former hard and fast rule for the "follow on," has given an option in the matter to the side possessing the requisite lead on the first innings.

*Early Players.*—If the era of the present form of cricket can very properly be dated from the visit of the first Australian team to England in 1878, some enumeration must be made of a few of the cricketers who took part in first-class matches in the earlier portion of the 19th century. Among amateurs should be noted the two fast bowlers, Sir F. H. Bathurst (1807-1881; Eton, Hampshire), and Harvey Fellowes (b. 1826; Eton); the batsman N. Felix (1804-1876; Surrey and Kent), who was a master of "cutting" and one of the earliest to adopt batting gloves; the cricketing champion of his time Alfred Mynn (1807-1861; Kent); and the keen player F. P. Miller (1828-1875; Surrey). The three Marshams, Rev. C. D. Marsham (b. 1835), R. H. B. Marsham (b. 1833) and G. Marsham (b. 1849), all of Eton and Oxford, were as famous as the Studds in the 'eighties; and R. Hankey (1832-1886; Harrow and Oxford) was a great scorer. In the next generation one of the greatest bats of his own or any time was R. A. H. Mitchell (1843-1905; Eton, Oxford, Hants). A very attractive run-getter was C. F. Buller (b. 1846; Harrow, Middlesex); an all too brief career was that of C. J. Ottaway (1850-1878; Eton, Oxford, Kent and Middlesex); whilst A. Lubbock (b. 1845; Eton, Kent) was a sound bat, and D. Buchanan (1830-1900; Rugby and Cambridge) a destructive bowler, as was also A. Appleby (1843-1902; Lancashire).

Of the professionals, Fuller Pilch (1803-1870) and E. G. Wenman (1803-1897) were great bats; T. Box (1808-1876) the most skilled wicket-keeper of his time; W. Lillywhite (1792-1854), one of the first round-arm bowlers, renowned for the accuracy of his pitch, and W. Clark (1798-1856) possessed wonderful variety of pace and pitch. It was the last-named who organized the All England Eleven, and he was not chosen to represent the players until he had reached the age of forty-seven. George Parr (1826-1891), the greatest leg-hitter in England, had no professional rival until the advent of Richard Daft (1835-1900). J. Dean (1816-1891) was the finest long-stop, Julius Caesar (1830-1878) a hard clean hitter, as was G. Anderson (1826-1902), and T. Lockyer (1826-1869) seems to have been the first prominent wicket-keeper who took balls wide on the leg-side. Of bowlers, E. Willsher (1828-1885) would seem to have been the most difficult, W. Martingell (1818-1897) being a very good medium-paced bowler, and J. Wisden (1826-1884) a very fast bowler but short in his length. Four famous bowlers of a later date are George Freeman (1844-1895), J. Jackson (1833-1901), G. Tarrant (1838-1870) and G. Wootton (b. 1834). With them must be mentioned the great batsmen, T. Hayward (1835-1876) and R. Carpenter (1830-1901), as well as two other keen cricketers, H. H. Stephenson (1833-1896) and T. Hearne (1826-1900).

Since the first half of the 19th century the sort of cricket to engage public attention has very greatly changed, and the change has become emphasized since the exchange of visits between Australian and English teams has become an established feature of first-class cricket. First-class cricket has become more formal, more serious and more spectacular. The contest for the county championship has introduced an annual competition, closely followed by the public, between standing rivals familiar with each other's play and record; an increased importance has become attached to "averages" and "records," and it is felt by some that the purely sporting side of the game has been damaged by the change. Professionalism has increased, and it is an open secret that not a few players who appear before the public as amateurs derive an income under some pretext or other from the game. Cricket on the village green has in many parts of the country almost ceased to exist, while immense crowds congregate



to watch county matches in the great towns; but this must no doubt be in part attributed to the movement of population from the country districts; and some compensation is to be found in league cricket (see below), and in the numerous clubs for the employees of business firms and large shops, and for the members of social institutes of all kinds, which play matches in the suburbs of London and other cities. At an earlier period two great professional organizations, "The All England," formed in 1846, and "The United All England," toured the country, mainly for profit, playing local sides in which "given men," generally good professional players, figured. They did much good work in popularizing the game, and an annual match between the two at Lord's on Whit-Monday was once a great feature of the season; but the increase of county cricket led eventually to their disbandment.

At this period, and much later, the first-class matches of "M. C. C. and ground" (i.e. ground-staff, or professionals attached to the club) occupied a far greater amount of importance than is at present the case. In recent years over 150 minor matches of the utmost value in propagating the best interests of cricket are annually played by the leading club. League cricket has of late become exceedingly popular, especially in the North of England, a number of clubs—about twelve to sixteen—combining to form a "League" and playing home-and-home matches, each one with each of the others in turn; points are scored according as each club wins, loses, or draws matches, the championship of the "League" being thus decided.

*English County Cricket.*—The first English inter-county match which is recorded was played on Richmond Green in 1730 between Surrey and Middlesex; but for very many years, though counties played counties, there was no systematic organization, matches often being played at odds or with "given" players, who had no county connexion with the side they represented. This was the natural outcome of the custom of playing for stakes. It was not till 1872 that any real effort was made to organize county cricket. In that year the M. C. C. took the initiative by offering a cup for competition between the counties, six of which were to be selected by the M. C. C., the matches to be played at Lord's, but the scheme fell through owing to the coolness of the counties themselves. It was only in 1890 that the counties were formally and officially classified, Notts (the county club dating from 1859), Lancashire (1864), Surrey (1845), Kent (1842), Middlesex (1864), Gloucestershire (1869), Yorkshire (1862), and Sussex (1839), being regarded as "first-class," and by degrees other counties were promoted to this class; Somerset in 1893; Derbyshire, Essex, Leicestershire, Warwickshire in 1894; Hampshire in 1895; Worcestershire in 1899; Northamptonshire in 1905.

In 1887 the County Cricket Council had been formed, working with and not against the Marylebone Club, for the management of county cricket, but the council dissolved itself in 1890, and it was then arranged that the county secretaries and delegates should meet and discuss such matters, and request the M. C. C. to consider the result of their deliberations, and practically to act as patron and arbitrator. In 1905 an Advisory Cricket Committee was formed "with the co-operation of the counties, with a view to improve the procedure in dealing with important matters arising out of the development of cricket, the effect of which will be" (the quotation is from the annual report of M. C. C. in 1905) "to bring the counties into closer touch with the M. C. C." Various methods have been tried as to the assignment of points or marks, the following being the list of champion counties up to 1909:—

1864	Surrey	1873	Surrey
1865	Notts	1874	Gloucestershire
1866	Middlesex	1875	Notts
1867	Yorkshire	1876	Gloucestershire
1868	Yorkshire	1877	Gloucestershire
1869	Notts	1878	Notts
1870	Yorkshire	1879	Lancashire } equal
1871	Notts		Notts
1872	Surrey	1880	Notts
	Gloucestershire } equal	1881	Lancashire

1882	Lancashire } equal	1895	Surrey
	Notts	1896	Yorkshire
1883	Yorkshire	1897	Lancashire
1884	Notts	1898	Yorkshire
1885	Notts	1899	Surrey
1886	Notts	1900	Yorkshire
1887	Surrey	1901	Yorkshire
1888	Surrey } equal	1902	Yorkshire
	Notts	1903	Middlesex
1889	Lancashire } equal	1904	Lancashire
	Surrey	1905	Yorkshire
1890	Surrey	1906	Kent
1891	Surrey	1907	Notts
1892	Surrey	1908	Yorkshire
1893	Yorkshire	1909	Kent
1894	Surrey		

English county cricket is now the most firmly established cricketing institution in the world, but in its earlier stages it owed much in different counties to enthusiastic individuals and famous cricketing families whose energies were devoted to its encouragement and support. To Gloucestershire belongs the honour of the greatest name in the history of the game. Dr W. G. Grace (q.v.) was not only the most brilliant all-round cricketer in the world, but he remained supreme after reaching an age when most cricketers have long abandoned the game. He and his two famous brothers, E. M. Grace (b. 1841) and G. F. Grace (1850-1880), rendered invaluable service to their county for many years; and not to their county alone, for the great part they played for a generation in first-class cricket did much to increase the growing popularity of the county fixtures. A separate article is devoted to Dr W. G. Grace, whose name as the champion of the game will always be associated with its history. And of Dr E. M. Grace it may be mentioned that, besides being the most daring field at "point" ever seen, he altogether took 11,092 wickets and scored 75,625 runs. In more recent years some excellent cricketers have been associated with Gloucestershire, such as F. Townsend, and the professional Board; but foremost stands G. L. Jessop, a somewhat "unorthodox" batsman famous for his powers of hitting.

What W. G. Grace did for Gloucestershire, Lord Harris (b. 1851) did for Kent, and his services are not to be estimated by his performances in the field alone, great as they were. His influence was always exerted to impart a spirit of sportsmanship and honourable distinction to the national game. Kent had been a home of cricket since the first half of the 18th century, but it was Lord Harris more than any other individual who made it a first-class county, celebrated for the number of distinguished amateurs who have taken part in its matches. The Hon. Ivo Bligh, afterwards Lord Darnley (b. 1859), and F. Marchant (b. 1864), both Etonians like Lord Harris himself; the two Harrovians, W. H. Patterson (b. 1859) and M. C. Kemp (b. 1862), and the Wykehamist J. R. Mason (b. 1874) are names that show the place taken by public school men in the annals of Kent cricket, while the family of Hearnès supplied the county with some famous professionals. Amateur batsmen like W. Rashleigh, C. J. Burnup, E. W. Dillon and A. P. Day have been prominent in the Kent eleven; and in Fielder and Blythe they have had two first-class professional bowlers. The "Kent nursery" at Tonbridge has proved a valuable institution for training young professional players, and contributed not a little to the rising reputation of Kent, which justified itself when the county won the championship in 1906, largely owing to the admirable batting of the amateur K. L. Hutchings.

Middlesex and Lancashire, not less than Kent, have been indebted to the great public schools, and especially to Harrow, which provided both counties with famous captains who directed their fortunes for an uninterrupted period of over twenty years. I. D. Walker, the most celebrated of seven cricketing brothers, all Harrovians, who founded the Middlesex County Club, handed on the captaincy, after a personal record of astonishing brilliancy, to a younger Harrow and Oxford cricketer, A. J. Webbe, who was one of the finest leg-hitters and one of the safest out-fielders of his day, and a captain of consummate judgment and knowledge of the game. A. N. Hornby, a contemporary at Harrow of I. D. Walker, was for many years the soul of Lancashire cricket, and was succeeded in the captaincy of the county by the still more famous Harrovian, A. C. MacLaren, one of the greatest batsmen in the history of cricket, whose record for England in test matches against Australia was almost unrivalled. In 1895, when he headed the batting averages, MacLaren made the highest individual score in a first-class match, viz. 424 against Somersetshire. Middlesex has also the distinction of having produced the two greatest amateur wicket-keepers in the history of English cricket, namely, the Hon. Alfred Lyttelton (b. 1857) and Gregor MacGregor, both of whom, after playing for Cambridge University, gave their services to the Metropolitan county; while Lancashire can boast of the greatest professional wicket-keeper in Richard Pilling (1855-1891), whose reputation has not been eclipsed by that of the most proficient of more recent years. Another famous Cambridge University cricketer, a contemporary of Lyttelton, who was invaluable to Lancashire for

*The Graces and Gloucestershire.*

*Kent.*

*Middlesex and Lancashire.*

some years when he was one of the very finest all-round cricketers in the country, was A. G. Steel (b. 1858), equally brilliant as a batsman and as a slow bowler; and other names memorable in Lancashire cricket were R. G. Barlow (b. 1859), whose stubborn batting was a striking contrast to the rapid run-getting of Hornby and the perfect style of Steel; John Briggs (1862-1902), whose slow left-hand bowling placed him at the head of the bowling averages in 1890; John Crossland (1853-1903) and A. Mold (b. 1865), both of whom were destructive fast bowlers; J. T. Tyldesley and R. H. Spooner, both among the most brilliant batsmen of a later generation; and W. Brearley, the amateur fast bowler.

Middlesex, like Kent, has been better served by amateurs than professionals. Indeed, with the notable exceptions of J. T. Hearne, who headed the bowling averages in 1891, 1896 and 1898, and of the imported Australian A. E. Trott, few professionals of high merit are conspicuously associated with the history of the county cricket. Trott, in 1899 and again in 1900, performed the previously unprecedented feat of taking over two hundred wickets and scoring over one thousand runs in the same season. And in his "benefit match" in May 1907 at Lord's he achieved the "hat trick" twice in one innings, taking first four and then three wickets with successive balls. But if there has been a dearth of professionals in Middlesex cricket, the county has produced an abundance of celebrated amateurs. In addition to the Walkers and A. J. Webbe, the metropolitan county was the home of the celebrated hitter, C. I. Thornton, and of the Studd family, who learnt their cricket at Eton and Cambridge University. C. T. Studd, one of the most polished batsmen who ever played cricket, was at the same time an excellent medium-paced bowler, and his brother C. B. Studd is remembered especially for his fielding, though like his elder brother, J. E. K. Studd, he was an all-round cricketer of the greatest value to a county team. Sir T. C. O'Brien, who made his reputation by a fine innings for Oxford University against the Australian team of 1882, sustained it in the following years by many brilliant performances for Middlesex. A. E. Stoddart for several years was the best run-getter in the Middlesex eleven; and W. J. Ford and his younger brother, F. G. J. Ford, were conspicuous among many prominent Middlesex batsmen. In more recent times the Oxonian P. F. Warner (b. 1873), both as captain and as batsman, did splendid work; and B. J. T. Bosanquet, besides assisting powerfully with the bat, became famous for inaugurating a new style of curly bowling ("googlies") of a very effective type.

A glance at the table given above shows the high place occupied by Surrey in the past. Surrey county cricket can be traced as far back as 1730. Pycroft observes that "the name of Surrey as one united county club is quite lost in the annals of cricket from 1817 to 1845." But before that date two of the most celebrated cricketers, William Lillywhite and Fuller Pilch, had occasionally played for the county, and so also had James Broadbridge (1796-1843) and W. Lambert (1779-1851). Kenning Oval became the Surrey county ground in 1845, the property being leased from the duchy of Cornwall; and in the years immediately following the county team included H. H. Stephenson (1833-1896), Caffyn (b. 1828), N. Felix, and Lockyer (1826-1869); among a later generation appeared such well-remembered names as Jupp, Southerton, Pooley and R. Humphrey. After being champion county in 1873, Surrey did not again attain the same position for fourteen years, but for the next ten years maintained an almost uninterrupted supremacy. The greatest credit was due to the energetic direction of J. Shuter (b. 1855), who kept together a remarkable combination of cricketers, such as W. W. Read (1855-1906), Maurice Read (b. 1859), George Lohmann (1865-1901), and Robert Abel (b. 1859), all of whom were among the greatest players of their period. Lohmann in 1885-1890 would alone have made any side famous; and in the same years when he was heading the bowling averages and proving himself the most deadly bowler in the country, W. W. Read was performing prodigies of batting. No sooner did the latter begin to decline in power than Abel took his place at the head of the batting averages, scoring with astonishing consistency in 1897-1900. In 1899 he made 357 not out in an innings against Somersetshire, and in 1901 his aggregate of 3309 was the largest then compiled. The Oxonian K. J. Key was another famous batsman whose services as captain were also exceedingly valuable to the county. An almost inexhaustible supply of professionals of the very highest class has been at Surrey's service. W. Lockwood (b. 1868) became almost as deadly a bowler as Lohmann, and Tom Richardson (b. 1870) was the terror of all Surrey's opponents for several seasons after 1893. Richardson took in all no less than 1340 wickets at the cost of 20,000 runs. Tom Hayward (b. 1867), nephew of the renowned Cambridge professional of the same name, succeeded Abel as the leading Surrey batsman, his play in the test matches of 1899, when he averaged 65, being superb. During the following years his reputation was fully maintained, and in 1906 he had a particularly successful season. Key was followed in the captaincy by D. L. A. Jephson, but the county did not in the opening years of the 20th century maintain the high place it occupied during the last quarter of the 19th. It possessed some excellent professionals, however, in Hayes, Hobbs and Lees, and the season of 1906, under the captaincy of Lord Dalmeny, showed a revival, a new fast bowler being found in N. A. Knox, and a fine batsman and bowler in J. N. Crawford.

Several of the celebrated cricketers of early times already mentioned as having played for the Surrey club were more closely associated with the adjoining county of Sussex, whose records go back as far as 1734, in which year a match was played against Kent, the chief promoters of which were the duke of Richmond and Sir William Gage. One of the earliest famous cricketers, Richard Newland (d. 1791), was a Sussex man; and James Broadbridge, W. Lambert, Tom Box, and the great Lillywhite family were all members of the Sussex county team. Lambert, in a match against Epsom, played at Lord's in 1817, made a "century" (one hundred runs) in each innings, a feat not repeated in first-class cricket for fifty years; and the occasion was the first when the aggregate of a thousand runs was scored in a match. Broadbridge played for Sussex in five reigns, while Box (1808-1876) kept wicket for the county for twenty-four years without missing a match. Notwithstanding this distinguished history, Sussex never attained the highest place in the county rivalry, and for a number of years towards the end of the 19th century the left-handed batting of F. M. Lucas (1860-1887) alone saved the county from complete insignificance. A revival came when W. L. Murdoch (b. 1855), of Australian celebrity, qualified for Sussex; and at a still later date the fortunes of the county were raised by the inclusion in its eleven of Kumar Shri Ranjitsinhji, afterwards H.H. the Jam of Nawanagar (b. 1872), the Indian prince, who had played for Cambridge University. Ranjitsinhji's dexterity, grace and style were unrivalled. He scored 2780 runs in 1896, averaging 57, while in county matches in 1899 his aggregate was 2555, with an average of 75. Even this performance was beaten in 1900 when he scored a total of 2563 runs, giving an average for the season of 83. In all matches his aggregates were 3159 in 1899, and 3065 in 1900. Not less remarkable was the cricket of C. B. Fry (b. 1872), who came from Oxford University to become a mainstay of Sussex cricket, and who in 1901 performed the unparalleled feat of scoring in successive innings 106, 209, 149, 105, 140 and 105, his aggregate for the season being 3147 with an average of 78. In 1905 his average for Sussex was 85, but in the following year an accident kept him out of the cricket field throughout the season; and in 1909 he transferred his services to Hampshire.

If Kent and Middlesex may be described as the counties of amateurs, Yorkshire and Nottinghamshire should be called the counties of famous professionals. Between 1861 and 1889 Nottinghamshire was champion county twelve times and the county eleven was as a rule composed almost entirely of professional players, among whom have been many of the greatest names in the history of the game. Richard Daft (1835-1900), after playing as an amateur, became a professional in preference to abandoning the game, scorning to resort to any of the pretexts by which cricketers have been known to accept payment for their services while continuing to cling to the status of the amateur. William Osceoff (1843-1905) was one of Nottinghamshire's early batting heroes, and in Alfred Shaw (b. 1842) and F. Morley (1850-1884) the county possessed an invaluable pair of bowlers. William Gunn (b. 1858), besides being a magnificent fielder "in the country," was an exceptionally able batsman; but his performances did not equal those of his greater contemporary, Arthur Shrewsbury, who in six years between 1885 and 1892 headed the English batting averages. Shrewsbury's perfect style combined with inexhaustible patience placed him in the front rank of the "classical" batsmen of English cricket. Of the batsmen nicknamed "stonewallers," who at one time endangered the popularity of first-class cricket, was W. Scotton (1850-1893); and among the other numerous professionals whose cricket contributed to the renown of Nottinghamshire were Barnes (1852-1899), at times a most formidable bat; Flowers (b. 1856), always useful both with the bat and the ball; W. Attewell (b. 1861), a remarkably steady bowler who bowled an abnormal number of maiden overs; Mordecai Sherwin (b. 1851), an excellent successor to T. Plumb (b. 1833) and F. Wild (1847-1893) as wicket-keeper for the county; and among more recent players, J. Iremonger (b. 1877) and John Gunn, both of whom proved themselves cricketers worthy of the Notts traditions. J. A. Dixon (b. 1861), one of the few amateurs of the Nottinghamshire records, was for some time captain of the county team; and he was succeeded by A. O. Jones (b. 1873), a dashing batsman, who in 1899 was partner with Shrewsbury when the pair scored 391 for the first wicket in a match against Gloucestershire.

The history of Yorkshire cricket is modern in comparison with that of Surrey, Sussex or Kent. The county club only dates from 1861, and for some years the team was composed entirely of professionals. But though Yorkshire attained the Yorkshire championship three times during the first ten years of the county club's existence, thirteen years elapsed after 1870 before it again occupied the place of honour. In the ten years 1896-1906 Yorkshire was no less than six times at the head of the list, this position of supremacy being in no small measure due to the captaincy of Lord Hawke (b. 1860), who played continuously for the county from his university days for more than twenty years, and whose influence on Yorkshire cricket was unique. But before his time Yorkshire had already produced some notable cricketers, such as George Ulyett (1857-1898), who headed the batting averages in 1878, and who was also a fine fast bowler; Louis Hall (b. 1852), a patient bat; and another excellent scorer, Ephraim Lockwood (b. 1845). William

Bates (1855-1900), too, was effective both as batsman and bowler; and Tom Emmett (1841-1904), long proverbial for bowling "a wide and a wicket," was deservedly popular. To the earlier period belonged two fast bowlers, George Freeman (1844-1895) and Allan Hill (b. 1845), and the eminent wicket-keeper Pincher (1841-1903), who was succeeded by J. Hunter (1857-1891), and later by his brother Daniel Hunter (b. 1862). The full effect of Lord Hawke's energetic captaincy was seen in 1900, when Yorkshire played through a programme of twenty-eight fixtures without sustaining a defeat; and the county's record was but little inferior in both the following years and again in 1905, in each of which years it retained the championship. It was during this period that as notable a group of cricketers wore the Yorkshire colours as ever appeared in county matches. Edmund Peate (1856-1900), one of the finest bowlers in his day, did not survive to take part in the later triumphs of his county; but the period beginning in 1890 saw J. T. Brown, J. Tunnicliffe, R. Peel, W. Rhodes, George Hirst and the Hon. F. S. Jackson in the field. The two first named became famous for their first wicket partnerships. In 1896 in a match against Middlesex at Lord's these two batsmen scored 139 before being separated in the first innings, and in the second knocked off the 147 required to win the match. In the following year they made 378 for the first wicket against Surrey, and during their careers they scored over a hundred for the first wicket on no less than fifteen occasions, the greatest feat of all being in 1898, when they beat the world's record by staying together till 554 runs had been compiled. Peel was for many years an untiring bowler, and Yorkshire was fortunate in discovering a successor of even superior skill in Wilfrid Rhodes, who in 1900 took over 200 wickets at a cost of 12 runs each in county matches alone, and was also an excellent bat. Hirst and Jackson were the two finest all-round cricketers in England about 1905. The Hon. F. S. Jackson (b. 1870), like his fellow-Harrovian A. C. MacLaren, had a wonderful record in test matches against Australia; he captained the England eleven in 1905, and his wonderful nerve enabled him to extricate his side when in a difficulty, and to render his best service at an emergency. Hirst (b. 1871) in 1904 and in 1905 scored over 2000 runs and took more than 100 wickets; and in 1906 he surpassed all previous records by scoring over 2000 runs and taking over 200 wickets during the season. A concourse of 78,000 people watched his "benefit" match (Yorkshire against Lancashire) in August 1904. Besides cricketers like these, such fine players were included in the team as Wainwright (b. 1865), Haigh (b. 1871), Denton (b. 1874), and E. Smith (b. 1869); with such material the Yorkshire eleven had no "tail," and was able to win the championship six times in a decade.

Somersetshire hardly fulfilled the promise held out by the success achieved in the closing decade of the 19th century; this had been largely owing to the captaincy and brilliant batting of **Somerset-**  
**shire.** H. T. Hewett (b. 1864), who in partnership with L. C. H. Palaret (b. 1870), famous for his polished style, scored 346 for the first wicket in a match against Yorkshire in 1892. Hewett was succeeded in the command of the county eleven by the Cambridge fast bowler, S. M. J. Woods (b. 1868); and among other members of the eleven the most valuable was L. C. Braund (b. 1876), a professional who excelled as an all-round cricketer.

The counties above referred to are those which have figured most prominently in the history of county cricket. Individual players of the highest excellence are, however, to be found from time to time in all parts of the country. **Minor**  
**counties.** Warwickshire, for example, can boast of having had in A. A. Lilley (b. 1867) the best wicket-keeper of his day, who represented England against Australia in the test matches; while Worcestershire produced one of the best all-round professionals in the country for a number of years in Arnold (b. 1877), and a batsman of extreme brilliancy in R. E. Foster, a member of a cricketing family to whom belongs the credit of raising Worcestershire into a cricketing county of the first class. Derbyshire, similarly, can claim some well-known cricket names, the bowler W. Mycroft (1841-1894), W. Chatterton (b. 1863), and W. Storer (b. 1868), a first-class wicket-keeper. Essex possesses at Leyton one of the best county grounds in the country, and the club was helped over financial difficulties by the munificent support of an old Uppingham and Cambridge cricketer, C. E. Green. It has produced a fair number of excellent players, notably the batsmen P. Perrin, C. MacGahay, and the fast bowler C. J. Kortright; and A. P. Lucas, afterwards a member of the county club, was a famous cricketer who played for England in 1880 in the first Australian test match. Hampshire had a fine batsman in Captain E. G. Wynyard, and its annals are conspicuous for the phenomenal scores made during the single season of 1899 by Major R. M. Poore; these two put together 411 against Somersetshire in that year before being separated. Among the later Hants professionals, Llewellyn was most prominent.

The distribution of cricketing ability in England might be the subject of some interesting speculation. In the first forty years of the annual competition for the championship six counties alone gained the coveted distinction, and three of these, Surrey, Notts and Yorkshire, won it thirty-four times between them. Why, it may be asked, is it that one county excels in the game while another has no place whatever in the history of cricket? How comes it that great names recur continually in the annals of Surrey and Yorkshire, for

example, while those of Berkshire and Lincolnshire are entirely barren? No doubt proximity to great centres of population favours the cultivation of the game, but in this respect Kent and Sussex are no better situated than Hertfordshire, nor does it account for Nottinghamshire having so illustrious a record while Staffordshire has none at all, nor for Somersetshire having outclassed Devon. It is strange, moreover, that while the universities are the chief training-grounds for amateur cricketers, neither Oxfordshire nor Cambridgeshire has made any mark among the counties. The influence of individuals and families, such as the Graces in Gloucestershire, the Walkers in Middlesex, and in recent times the Fosters in Worcestershire, has of course been of inestimable benefit to cricket in those counties; but Buckinghamshire and Norfolk and Cheshire send their sons to the public schools and universities no less than Lancashire or Kent. It is difficult, therefore, to understand why county cricket should so persistently confine itself to a small number of counties; but such is the fact.

Cricket has never flourished vigorously in Scotland, Ireland or Wales, a fact that may partly be accounted for by the comparative difficulty of obtaining good grounds in those parts of the kingdom, and by the inferiority, for the purpose of cricket, of their climate. In the south of Scotland, and especially in the neighbourhood of Edinburgh, there are clubs which keep the game alive; and Scotland, though it has produced no great cricketers, either amateur or professional, has sent a few players to the English university elevens who have found places in English county teams. In Ireland cricket is fairly popular, especially in those parts of the island where local sides can obtain assistance from soldiers quartered in the neighbourhood. One or two counties play annual matches, that between Kildare and Cork in particular exciting keen rivalry. Trinity College, Dublin, has turned out some excellent players; and the Phoenix and Leinster clubs in Dublin, and the North of Ireland club in Belfast, play a full programme of matches every season. D. N. Trotter, who played for county Meath for many years towards the close of the 19th century, was a batsman who would have found a place in any English county eleven; so also would William Hone, one of several brothers all of whom were keen and skilful cricketers. About the same period Lieutenant Dunn scored so many centuries in Irish cricket that he was played, though without any great success, for his native county of Surrey. More recently L. H. Gwynn (1873-1902) batted in a style and with a success that proved him capable of great things. Sir T. C. O'Brien, though an Irishman, belongs as a cricketer to Middlesex; but T. C. Ross, who was chosen to play for Gentlemen v. Players at Lord's in 1902, was a bowler who played regularly for county Kildare.

**Gentlemen v. Players.**—The most important match of the year as far as purely English cricket is concerned is the match between the gentlemen and players (amateurs and professionals) played at Lord's. For many years a match played between sides similarly composed at the Oval excited equal interest, but latterly county cricket has rather starved this particular game, though it still continues as a popular fixture. Other matches with the same title have been played in London on Prince's Ground (now built over), and at Brighton, Hastings and Scarborough and elsewhere, but those games in no way rank with the London matches.

The Lord's fixture was first established in 1806, in which year two matches were played; it became annual in 1819, but in those days the amateurs, being no match for their opponents, generally received odds, while in 1832 they defended wickets 22 in. by 6, and in 1837 the professionals stood in front of wickets of four stumps, measuring in all 36 in. by 12 in. This match was known as "The Barndoor Match" or "Ward's Folly," and the professionals won by an innings and 10 runs. Odds were not given after 1838, the gentlemen having then won eight matches and lost thirteen. From 1839 to 1866 the gentlemen only won 7 matches as compared with 21 losses. In 1867 the tide turned, for the brothers Grace, especially Dr W. G. Grace, became a power in the cricket-field, and from 1867 to 1884 the gentlemen, winning fifteen matches, only lost one. From 1885 the balance swung round, and by 1903 the professionals had won eleven matches and lost but four. The gentlemen won on nine successive occasions between 1874 and 1884, a draw intervening; while beginning with 1854 the professionals won eleven matches "off the reel." The professionals won in 1860 by an innings and no less than 181 runs; in 1900 they only won by two wickets, but to do so had to make, and did make, 501 runs in the last innings of the match. In 1903 the gentlemen, heavily in arrears after each side had played an innings, actually scored 500 in their second innings with only two men out. In 1904 the gentlemen won by two wickets after being 156 runs behind on the first innings, thanks to fine play by K. S. Ranjitsinhji and A. O. Jones. J. H. King had scored a century in each innings, a feat previously only performed by R. E. Foster in 1900. C. B. Fry's 232 not out in 1903 was the largest innings scored in the match. Dr W. G. Grace, who is credited with eight centuries, is the only cricketer who exceeded the hundred more than twice at Lord's in the fixture, 164 by J. T. Brown being the highest innings by a professional. There were seven instances before 1864 of two bowlers being unchanged in the match, and the Hon. F. S. Jackson and S. M. J. Woods repeated this in 1894. The Oval match was first played in 1857. The amateurs effected their first win in 1866, and though several games were drawn the professionals did not win again

till 1880. As at Lord's, it was the era of Grace, but from this point the amateurs could only win two matches, and by the narrowest of margins, till 1903, this making their sum of victories up to then thirteen, as opposed to twenty-three. In 1879 the gentlemen won in one innings by 126 runs, the heaviest beating that one side had inflicted on the other. The highest individual score was Robert Abel's 247, and the next Dr W. G. Grace's 215. Hayward scored 203 in 1904; A. G. Steel and A. H. Evans bowled unchanged in 1879.

*School and Club Cricket.*—Cricket is the standing summer game at every English private and public school, where it is taught as carefully and systematically as either classics or mathematics. There are also numbers of amateur clubs which possess no grounds of their own and are connected with no particular locality, but which are in fact mere associations of cricketers who play matches against the universities, schools or local teams, or against each other. Of these the best known, perhaps, is I Zingari (The Wanderers), popularly known as I.Z., whose well-known colours, red, yellow and black stripes, are prized rather as a social than as a cricketing distinction. This club was founded in 1845 by Lorraine Baldwin and Sir Spencer Ponsonby-Fane. The first rule of the club humorously declares that "the entrance fee shall be nothing, and the annual subscription shall not exceed the entrance fee." It is a rule of the club that no member shall play on the opposing side. I.Z. has long been connected with the social festivities forming a feature of the "Canterbury Week," a cricket festival held at Canterbury during the first week in August, of the Scarborough week, and of the Dublin horse-show. Dr W. G. Grace, who almost invariably appeared in the cricket field wearing the red and yellow stripes of the M.C.C., and some other notable amateurs, never belonged to I.Z. or any similar club; but Dr Grace was instrumental in the formation of the London county club, whose ground was at the Crystal Palace at Sydenham. Other amateur clubs, similar to I Zingari, are the Free Foresters, Incogniti, Etceteras, and in Ireland Na Shuler; while the Eton Ramblers, Harrow Wanderers, Old Wykehamists, and others are clubs whose membership is restricted to "old boys."

The Oxford and Cambridge universities match was first played in 1827, but was not an annual fixture till 1838. Five matches, those of 1829, 1843, 1846, 1848 and 1850, were played at Oxford, the rest at Lord's. The "Varsity match," and that between the two great public schools, Eton and Harrow, are great "society" events at Lord's every summer. Up to 1909 Eton won thirty times, and Harrow on thirty-five occasions. D. C. Boles by scoring 183 in 1904 set up a new record for this match, beating the 152 obtained in 1841 by Emilius Bayley (afterwards the Rev. Sir John Robert Laurie); and in 1907 the Harrow captain, M. C. Bird, established a further record by scoring over a hundred runs in each innings. Of the contests between Oxford and Cambridge, the latter (up to 1909) had lost thirty-one and won thirty-five. Oxford's 503 in 1900 and Cambridge's 392 in the same match furnished the highest aggregates. The largest individual innings was 172 not out by J. F. Marsh in 1904; but as a feat of batting it was intrinsically inferior to the 171 by R. E. Foster in 1900. Of the thirty centuries scored up to 1909, Oxford was credited with sixteen. Eustace Crawley (b. 1868) made a hundred both in the Eton v. Harrow and Oxford v. Cambridge matches. In the match of 1870 F. C. Cobden (b. 1849) took the last three Oxford wickets with consecutive balls, winning the match for Cambridge by 2 runs.

*Australian Cricket.*—Naturally popular in a British colony, cricket made but little progress in Australia before the arrival of an English professional eleven in 1861-1862, which carried all before it. Subsequent visits, and the coaching of imported professionals, so promoted the game that in 1878 a representative eleven of Australians visited England. The visits were repeated biennially till 1890, and then triennially. The visits of the Australian teams to England aroused unparalleled interest and acted as an immense incentive to the game. A great sensation was caused when the first team, captained by D. W. Gregory, on the 27th of May 1878, defeated a powerful M.C.C. eleven in a single day, disposing of them for 33 and 19, the fast bowler F. R. Spofforth (b. 1853) taking 6 wickets for 4 runs, and H. F. Boyle (b. 1847) 5 for 3. Their prowess was well maintained when in September 1880 Australia for the first time met the whole strength of England, such matches between representatives of Australia and England being known as "test matches," a term that was applied later to matches between England and South Africans also. Although in 1880 the old country won by 5 wickets, the honours were fairly divided, especially as Spofforth could not play. Dr W. G. Grace with a score of 152 headed the total of 420, but even finer was the Australian captain W. L. Murdoch's imperturbable display, when he carried his bat for 153. From 1882 onwards the Colonials, with two exceptions, at Blackpool and Skegness, only played eleven-a-side matches. Such bowlers as Spofforth, Boyle, G. E. Palmer (b. 1861), T. W. Garrett (b. 1858), and G. Giffen (1859) became household names. Nor was the batting less admirable, for Murdoch was supported by H. H. Massie (b. 1854), P. S. McDonnell (1860-1896), A. C. Bannerman (b. 1859), T. Horan (b. 1855), C. J. Bonnor (b. 1855), and S. P. Jones (b. 1861), whilst the wicket-keeper was McCarthy Blackham (b. 1855). This visiting side in 1882 was the greatest team of all; 23 matches were won, only 4 lost, and England was defeated at the Oval by 7 runs. In

1884 English cricket had improved, and the visiting record was hardly so good. The match against England at the Oval will not soon be forgotten. The Colonials scored 551 (Murdoch 211, McDonnell 103, Scott 102), and England responded with 346, Scotton and W. W. Read adding 151 for the ninth wicket.

The team of H. J. H. Scott (b. 1858) in 1886 proved less successful, for all three test matches were lost, and eight defeats had to be set against nine victories, but Giffen covered himself with distinction. This was the first tour under the auspices of the Melbourne Club. McDonnell's team in 1888 marked the appearance of the bowlers C. T. B. Turner (b. 1862) and J. J. Ferris (1867-1900). The former took 314 wickets for 11 runs each, and the latter 220 for 14 apiece. To all appearance they redeemed a poor tour, 19 matches being won and 14 lost. The 1890 tour, though Murdoch reappeared as captain, proved disappointing, both the test matches being lost and defeats for the first time exceeding victories, though the two bowlers again performed marvellously well. After an interval of three years, M. Blackham captained the seventh team, which was moderately fortunate. H. Graham (b. 1870) and S. E. Gregory (b. 1870) batted admirably, and the 149 of J. J. Lyons (b. 1863) in the match against M.C.C. was an extraordinary display of punishing cricket. In 1896, though they did not win the rubber of test matches, the colonials were most successful, 19 matches being victories and only 6 lost. S. E. Gregory, J. Darling (b. 1870), F. A. Iredale (b. 1867), G. Giffen, C. Hill (b. 1877), and G. H. S. Trott (1866-1905) were the best bats, and the last-named made an admirable captain. H. Trumble (1867) kept an excellent length, and E. Jones (1869) was deadly with his fast bowling.

The Australian representatives in 1899 demonstrated that they were the best since 1882, 16 successes and only 3 defeats (v. Essex, Surrey and Kent) being emphasized by a victory over England at Lord's by 10 wickets, the only one of the five test matches brought to a conclusion. M. A. Noble (b. 1873) and Victor Trumper (b. 1877), both newcomers, batted superbly. The latter, v. Sussex, made 300, the largest individual score hitherto made by an Australian in England, the previous best having been 286 by Murdoch in the corresponding match in 1882. H. Trumble scored 1183 runs and took 142 wickets for 18 runs apiece, and Darling not only made a judicious captain, but scored the biggest aggregate, 1941, up to then obtained by any batsman touring with a colonial eleven in England. On the home side, Hayward did sound service with the bat, and his stand with F. S. Jackson in the fifth test match yielded 185 runs for the first wicket.

In 1902 another fine Australian eleven, captained by Darling, won 23 and lost only 2 matches. They won the rubber of test matches at Manchester by 3 runs, but lost the final at the Oval by one wicket after an even more remarkable struggle, G. L. Jessop having scored 104 in an hour and a quarter. The other defeat was by Yorkshire by 5 wickets, when they were dismissed for 23 by Hirst and Jackson. The rest of the tour was characterized by brilliant batting. The performance of Trumper in making 2570 runs (with an average of 48) surpassed anything previously seen; R. A. Duff (b. 1878) also proved a brilliant run-getter. W. W. Armstrong (b. 1879) was useful in all departments, and J. V. Saunders (b. 1876) proved a successful left-handed bowler.

In 1905 there was a marked falling-off, as England won two and drew the other three test matches; but only one other defeat, by Essex by 19 runs, had to be set against 16 Australian victories. The persistent bowling off the wicket by Armstrong, and the inability to finish games within three days, were the chief drawbacks. Armstrong eclipsed all previous colonial records in England by heading both tables of averages, scoring 2002 (average 48) and taking 130 wickets at a cost of 17 runs each. He also compiled the largest individual score (303 not out v. Somerset) ever made on an Australian tour. M. A. Noble also exceeded 2000 runs. For a long time the fast bowler, A. Cotter (b. 1882, N.S.W.), failed, but eventually "came off," just as F. Laver (b. 1869), who had taken many wickets in the earlier part of the tour, was becoming less formidable. Duff saved the colonials by a great innings in the fifth test match; Trumper was less certain than formerly, and Clement Hill more reckless; whilst J. J. Kelly (b. 1867) on his fifth tour was better than ever before with the gloves.

The Australians who visited England under the leadership of M. A. Noble in 1909 were generally held to be a weaker team than most of their predecessors, but they greatly improved as the season advanced, proving that the side included several cricketers of the highest merit, and as a captain Noble has seldom been surpassed in consummate generalship. Their record of thirteen wins to four defeats offered little evidence of inferiority, while the large number of twenty-one drawn matches was accounted for by the cold wet weather that largely prevailed throughout the summer. Two out of the five test matches were unfinished, and Australia won the rubber by two matches to one. In all the test matches England was under the command of A. C. MacLaren, but the great Harrovian was no longer the batsman he had been some years earlier; Jackson had abandoned first-class cricket; Hirst and Hayward were becoming veterans; and, speaking generally, the English batting was decidedly inferior, and it collapsed feebly in three of the test matches. England's failure, for which poor fielding and missed catches were also responsible, was the more disappointing since they began well by winning the first test match at Birmingham by ten wickets.



C. B. Fry and Hobbs knocking off the 105 runs required to win in the second innings without the loss of a wicket. In the third test match, at Leeds, England was deprived of the services of Hayward and Blythe through illness, and an accident to Jessop during the match compelled the side to play a man short. It was in bowling that the Australians were thought to be least strong; but Laver's analysis in the Manchester test match, when he took 8 wickets for 31 runs in England's first innings, was the most notable feature of the match; and although his record at the head of the bowling averages for the tour, 70 wickets at an average cost of 14.9 runs, had frequently been beaten in earlier Australian tours in England, it proved him a worthy successor of Spofforth, Boyle and Turner. Armstrong, although he did not equal his record of 1905, again scored over 1000 runs and took over 100 wickets, his exact figures being 1439 runs and 120 wickets. The most remarkable Australian batting was that of two young left-handed players who on this occasion visited England for the first time, W. Bardsley (b. 1884) and Vernon Ransford (b. 1885), the latter of whom headed the averages both for test matches (58.8) and for the whole tour (45.5), his principal achievement being an innings of 143 not out in the test match at Lord's. Bardsley, who was second in the test matches averages (39.6), fell into the third place slightly below Armstrong in the averages for the tour; but he alone scored over 200 in an innings, which he accomplished twice, and over 2000 in aggregate for the tour, and he established a test match "record" by scoring 136 and 130 in the match at the Oval. Of the twenty-two "centuries" scored by Australians during the season Bardsley and Ransford each made six. Trumper and Noble each scored over a thousand runs, and Macartney was an invaluable member of the side both in batting and bowling. As a wicket-keeper Carter worthily filled the place of Kelly, and the fielding of the Colonials fully maintained the brilliant Australian standard of former years.

The following "records" of Australian cricket in England up to 1909 are of interest:—Highest total by an Australian team: 843 v. Past and Present of Oxford and Cambridge Universities in 1893. Highest total against an Australian team: 576 by England at the Oval in 1899. Lowest total by an Australian team: 18 v. M.C.C. in 1896. Lowest total against an Australian team: 17 by Gloucestershire in 1896. Highest individual Australian score in one innings: 303 not out by W. W. Armstrong v. Somersetshire in 1905. Highest individual Australian aggregate in a tour: 2570 by V. T. Trumper in 1902. Two centuries in a match: V. T. Trumper 109 and 119 v. Essex in 1902; W. Bardsley 136 and 130 v. England in 1909 (test match record).

The following table shows the Australians who headed the batting and bowling averages respectively in tours in England up to 1909.

*Batting.*

Year:		Inn.	Not out.	Runs.	Most.	Aver.
1878	C. Bannerman, N.S.W.	31	1	723	133	24.10
1880	W. L. Murdoch, N.S.W.	19	1	465	*153	25.80
1882	W. L. Murdoch, N.S.W.	61	5	1711	*286	30.50
1884	W. L. Murdoch, N.S.W.	50	5	1378	211	30.60
1886	G. Giffen, S.A.	63	9	1453	119	26.90
1888	P. M'Donnell, V.	62	1	1393	105	22.50
1890	W. L. Murdoch, N.S.W.	64	2	1459	*158	23.33
1893	H. Graham, V.	55	3	1492	219	28.36
1896	S. E. Gregory, N.S.W.	48	2	1464	154	31.38
1899	J. Darling, S.A.	56	9	1941	167	41.29
1902	V. T. Trumper, N.S.W.	53	0	2570	128	48.49
1905	W. W. Armstrong, V.	48	7	2002	*303	48.82
1909	V. S. Ransford	43	4	1778	190	45.58

\* Not out.

*Bowling.*

Year.		O.	M.	R.	W.	Aver.
1878	T. W. Garrett, N.S.W.	296.2	144	394	38	10.30
1880	F. R. Spofforth, N.S.W.	240.8	82	396	46	8.60
1882	H. F. Boyle, V.	1200.14	525	1680	144	11.60
1884	F. R. Spofforth, N.S.W.	1544.32	649	2642	216	12.20
1886	G. Giffen, S.A.	1693.26	722	2711	159	17.05
1888	C. T. B. Turner, N.S.W.	2589.3	1222	3492	314	11.38
1890	C. T. B. Turner, N.S.W.	1651.1	724	2725	215	12.45
1893	C. T. B. Turner, N.S.W.	1148	450	2202	160	13.12
1896	T. R. M'Kibbin, N.S.W.	647.1	198	1441	101	14.27
1899	H. Trumble, V.	1249.1	431	2618	142	18.43
1902	H. Trumble, V.	948	305	1998	140	14.27
1905	W. W. Armstrong, V.	1027	308	2288	130	17.60
1909	F. Laver	495.5	161	1048	70	14.97

The first English team to visit Australia was organized in 1862, and was captained by H. H. Stephenson. George Parr (1826-1891) took out the next in 1864, Dr E. M. Grace being the only amateur. In 1873 the Melbourne Club invited Dr W. G. Grace to take out an

eleven, and three years later James Lillywhite conducted a team of professionals. On this tour for the first time colonials contended on equal terms, one match v. Australia being won by 4 wickets and the other lost by 45 runs. Lord Harris in the autumn of 1878 took a team of amateurs assisted by Ulyett and Emmett, winning 2 and losing 3 eleven-a-side encounters, Emmett's 137 wickets averaging 8 runs each. Shaw, Shrewsbury and Lillywhite jointly organized the expedition of 1881, when Australia won the second test match by 5 wickets. The Hon. Ivo Bligh (afterwards Lord Darnley) in 1882 took a fine team, which was crippled owing to an injury sustained by the bowler F. Morley. Four victories could be set against three defeats; Australia winning the only test match, owing to the batting of Blackham. Shaw's second tour in 1884 showed Barnes heading both batting and bowling averages, while six victories counterbalanced two defeats. In the third tour Shrewsbury became captain, but the English for the first time encountered the bowling of C. T. B. Turner, who took 27 wickets for 113 runs in two matches. Australia was twice defeated, the English captain batting in fine form. On this tour was played the Smokers v. Non-Smokers, when the latter scored 803 for 9 wickets (Shrewsbury 236, W. Bruce 131, Gunn 150), against the bowling of Briggs, Boyle, Lohmann, Palmer and Flowers. The winter of 1887 saw two English teams in Australia, one under Lord Hawke and G. F. Vernon, the other under Shrewsbury and Lillywhite. Both teams played well, the batting being headed by W. W. Read with an average of 65, and Shrewsbury with 58. The ill-success of Lord Sheffield's team in two out of three test matches did not disprove the great merits of his eleven. Dr W. G. Grace headed the averages with 44, and received the best support from Abel and A. E. Stoddart, whilst Attewell, Briggs and Lohmann all possessed fine bowling figures. A. E. Stoddart's first team (in 1894) achieved immense success and was the best of all. In the first test match they went in against 586 runs and ultimately won by 10 runs, Ward making 75 and 117. Stoddart himself averaged 51, scoring 173 in the second test match, and A. C. MacLaren (who made 228 v. Victoria), Brown and Ward all averaged over 40. The last tour conducted by Stoddart proved less satisfactory, four of the five test matches being lost, and some friction being caused by various incidents. K. S. Ranjitsinhji, who averaged 60 and made 175 in a test match and 189 v. South Australia, and A. C. MacLaren, who scored five hundreds and averaged 54, were prominent, Hayward also doing good work; but the bowling broke down. Weakness in bowling was the cause of the ill success of A. C. MacLaren's side in 1901. After a brilliant victory by an innings and 124 runs at Sydney, the other four test matches were all lost. MacLaren himself batted magnificently, and so did Hayward and Tyldesley. Braund stood alone as an all-round man. The M.C.C. in 1903 officially despatched a powerful side led by P. F. Warner, and in every sense except the financial the success was complete. Three test matches were won and two lost, while two new records were set up, one by Rhodes obtaining 15 wickets at Melbourne, the other by R. E. Foster, who in seven hours of brilliant batting compiled 287. Tyldesley and Hayward both did good work as batsmen; Rhodes and Braund both bowled consistently. The catch-phrase about "bringing back the ashes" became almost proverbial; its origin is to be found in the *Sporting Times* in 1882 after Australia had defeated England at the Oval.

*New Zealand.*—Although cricket has not attained a degree of perfection in New Zealand commensurate with that in Australia, it is keenly played. Lord Hawke sent out from England a team in 1902-1903 which won all the eighteen matches arranged.

*Cricket in India.*—Not only the English who live in India, but the natives also—Parsees, Hindus and Mahomedans alike—play cricket. A Parsee eleven visited England in 1884 and 1888.

*South Africa.*—South African cricketers visiting England are handicapped by playing on turf instead of on the matting wickets used in South Africa. The side which came over during the Boer War in 1901 won 13, lost 9, and drew 2 matches, playing a tie with Worcestershire, and showing marked improvement on the team which had visited England in 1894. E. A. Halliwell (b. 1864) proved a fine wicket-keeper, J. H. Sinclair (b. 1876) a good all-round cricketer, J. J. Kotze (b. 1879) a very fast bowler, and G. A. Rowe (b. 1872) clever with the ball. In 1904 more decided success was achieved, for on a more ambitious programme ten victories could be set against two defeats by Worcestershire and Kent, with a tie with Middlesex. The most important success was a victory by 189 runs over a powerful England eleven at Lord's, when R. O. Schwarz (b. 1875) scored 102 and 26, and took 8 wickets for 106, dismissing Ranjitsinhji twice. Kotze and Sinclair again bore the brunt of the attack. Of the English teams visiting South Africa, that taken by Lord Hawke in 1894 did not meet with such important opposition as the one he led in 1900, yet the side came back undefeated, having won all three test matches. P. F. Warner and F. Mitchell, with Tyldesley, were the chief run-getters, Haigh, Trott and Cuttell bowling finely. In the winter of 1905 the M.C.C. sent out a side under P. F. Warner, but it lost four out of the five test matches, F. L. Fane and J. N. Crawford being the most successful of the Englishmen, and G. C. White (1882) and A. D. Nourse proving themselves great colonial batsmen. In 1907 a representative South African team came to England, and their improved status in the cricketing world was shown by the arrangement of test matches. In the winter of 1909-1910 an English



team under Mr Leveson Gower went to South Africa, and played test matches.

**West Indies.**—West Indian cricketers toured in England in 1900, winning 5 matches and losing 8. The best batsman was C. A. Olivier (b. 1876), who subsequently qualified for Derbyshire. The brunt of the bowling devolved on S. Woods and T. Burton (b. 1878). In 1897 teams under Lord Hawke and A. Priestly (b. 1865) both visited West Indies, Trinidad defeating both powerful combinations. R. S. Lucas (b. 1867) had in 1895 taken out a successful side. A much weaker combination in 1902 suffered five defeats but won 13 matches. B. J. T. Bosanquet, E. R. Wilson (b. 1879) and E. M. Dowson (b. 1880) were the chief performers. In 1906 another West Indian side visited England, but were not particularly successful.

**America.**—In the United States cricket has always had to contend with the popularity of baseball, and in Canada with the rival attractions of lacrosse. Nevertheless it has grown in popularity, Philadelphia being the headquarters of the game in the New World.

The Germantown, Belmont, Merion and Philadelphia Clubs play annually for the Halifax Cup, and the game is controlled by the Associated Cricket clubs of Philadelphia. In the neighbourhood of New York matches are arranged by the Metropolitan District Cricket League and the New York Cricket Association; similar organizations are the Northwestern, the California and the Massachusetts associations, while the Intercollegiate Cricket League consists of college teams representing Harvard, Pennsylvania and Haverford. R. S. Newhall (b. 1852) and D. S. Newhall (b. 1849) may almost claim to be the fathers of cricket in the United States; while D. W. Saunders (b. 1862) did much for the game in Canada. Other eminent names in American cricket are A. M. Wood; H. Livingston, of the Pittsburg Club, who scored three centuries in one week in 1907; H. V. Hordern, University of Pennsylvania, a very successful bowler; J. B. King, who in 1906 made 344 not out for Belmont v. Merion, and who as a fast bowler proved most effective during two tours in England. At San Francisco in 1894 W. Robertson and A. G. Sheath compiled a total of 340 without the loss of a wicket, the former scoring 206 not out, and the latter 118 not out. A large number of English cricket teams have visited the United States and Canada. The first county to do so was Kent in 1904, in which year the Philadelphians also made a tour in England, in the course of which J. B. King (b. 1873) took 93 wickets at an average cost of 14 runs, and proved himself the best all-round man on the side. P. H. Clark (b. 1873), a clever fast bowler, and J. A. Lester (b. 1872), the captain of the team, also showed themselves to be cricketers of merit, while N. Z. Graves (b. 1880) and F. H. Bohlen (b. 1868) were quite up to English county form. The team did not, however, include G. S. Patterson (b. 1868), one of the best batsmen in America. The Philadelphians again visited Great Britain in 1908, when they won 7 out of 14 matches, one being drawn. On this tour King surpassed his former English record by taking 115 wickets, and Wood, who played one fine innings of 132, was the most successful of the American batsmen.

**Other Countries.**—The English residents of Portugal support the game, but were no match for a moderate English team that visited them in 1898. In Holland, chiefly at the Hague and Haarlem, cricket is played to a limited extent on matting wickets. Dutch elevens have visited England, and English elevens have crossed to Holland, the most important visit being that of the gentlemen of the M.C.C. in 1902, the Englishmen winning all the matches.

**Professionalism.**—The remuneration of the first-class English professionals is £6 per match, out of which expenses have to be paid; a man engaged on a ground to bowl receives from £2, 10s. to £3, 10s. a week when not away playing matches. A professional player generally receives extra reward for good batting or bowling, the amount being sometimes a fixed sum of £1 for every fifty runs, more frequently a sum awarded by the committee on the recommendation of the captain. Some counties give their men winter pay, others try to provide them with suitable work when cricket is over. A few get cricket in other countries during the English winter. For international matches professional players and "reserves" receive £20 each, though before 1896 the fee was only £10; players (and reserves) in Gentlemen v. Players at Lord's are paid £10. A good county professional generally receives a "benefit" after about ten years' service; but the amount of the proceeds varies capriciously with the weather, the duration of the match, and the attendance. In the populous northern counties of England benefits are far more lucrative than in the south, but £800 to £1000 may be regarded as a good average result. County clubs generally exercise some control over the sums received. Umpires are paid £6 a match; in minor games they receive about £1 a day.

**Records.**—Records other than those already cited may be added for reference. A schoolboy named A. E. J. Collins, at Clifton College in 1899, excited some interest by scoring 628 not out in a boy's match, being about seven hours at the wicket. C. J. Eady (b. 1870) scored 566 for Break o' Day v. Wellington in eight hours in 1902, the total being 911. A. E. Stoddart made 485 for Hampstead v. Stoics in 1886. In first-class cricket the highest individual score for a batsman is A. C. MacLaren's 424 for Lancashire v. Somerset at Taunton in 1895. Melbourne University scored 1094 against Essendon in March 1898, this being the highest authenticated total on record. M.C.C. and Ground made 735 v. Wiltshire in 1888, the highest total at Lord's.

In the match between A. E. Stoddart's team and New South Wales at Sydney in 1898, 1739 runs were scored, an aggregate unparalleled in first-class cricket. The highest total for an innings in a first-class match is 918 for N.S.W. v. South Australia in January 1901. Yorkshire scored 887 v. Warwickshire at Birmingham in May 1896. The lowest total in a first-class match is 12 by Northamptonshire v. Gloucestershire in June 1907. The record for first wicket is 472 by S. Colman and P. Coles at Eastbourne in 1892. The longest partnership on record is 623 by Captain Oates and Fitzgerald at the Curragh in 1895. The best stand that has been made for the last wicket in a first-class match is 230 runs, which was run up by R. W. Nicholls and Roche playing for Middlesex v. Kent at Lord's in 1899.

The "averages" of individual players for batting and bowling annually excite a good deal of interest, and there is a danger that some players may think too much of their averages and too little of the sporting side of the game. Any comparison of the highest averages during a series of years would be misleading, owing to improvements in grounds, difference of weather, and the variations in the number of innings.

The following table of aggregates, compiled from the figures to the end of 1905, affords a summary of the records of a select list of historic cricketers; it will serve to supplement some details already given above about them and others.

#### Batting.

	Innings.	Not Out.	Runs.	Most.	Aver.
K. S. Ranjitsinhji	448	57	22,277	285	56.3
C. B. Fry	481	29	22,865	244	50.4
T. Hayward	667	61	25,225	315	41.3
J. T. Tyldesley	491	38	18,683	250	41.1
Dr W. G. Grace	1463	103	54,073	344	39.1
A. Shrewsbury	784	88	25,819	267	37.6
R. Abel	964	69	32,810	357	36.5
A. C. MacLaren	526	37	17,364	424	35.2
G. H. Hirst	626	92	18,615	341	34.4
Hon. F. S. Jackson	490	35	15,498	160	34.2
W. Gunn	821	66	25,286	273	33.3
W. W. Read	739	53	22,919	328	33.2
A. E. Stoddart	513	16	16,081	221	32.2

#### Bowling.

	Overs.	Maid.	Runs.	Wkts.	Aver.
A. Shaw	22,830	12,803	21,887	1916	11.8
F. R. Spofforth	5,342	2,168	8,773	682	12.5
C. T. B. Turner	5,388	2,396	8,419	649	12.6
T. Emmett	14,672	6,870	20,811	1523	13.1
G. Lohmann	15,196	6,508	23,958	1734	13.1
F. Morley	12,610	6,239	15,938	1213	13.1
E. Peate	11,669	5,593	14,299	1061	13.5
W. Rhodes	11,014	3,476	23,336	1564	14.1
W. Attewell	22,461	11,408	28,671	1874	15.5
J. Briggs	20,300	8,275	34,411	2161	15.2
R. Peel	18,255	7,856	27,795	1733	16.6
S. Haigh	7,749	2,279	18,516	1102	16.8
J. T. Hearne	19,895	7,395	40,532	2350	17.5
W. H. Lockwood	8,733	2,241	22,981	1273	18.6
T. Richardson (1904)	14,474	3,835	38,126	2081	18.6
Dr W. G. Grace (1904)	28,502	10,892	50,441	2730	18.1
G. H. Hirst	11,586	3,525	27,028	1377	19.8

**BIBLIOGRAPHY.**—The chief works on cricket are, apart from well-known annuals:—H. Bentley's *Scores from 1786 to 1822* (published in 1823); John Nyren's *Young Cricketer's Tutor* (1833); N. Wanostrucht's *Felix on the Bat* (various editions, 1845–1855); F. Lillywhite's *Cricket Scores and Biographies, 1746 to 1840* (1862); Rev. J. Pycroft's *Cricket Field* (various editions, 1862–1873); C. Box's *Theory and Practice of Cricket* (1868); F. Gale's *Echoes from Old Cricket Fields* (1871, new ed. 1896); *Marylebone Cricket Club Scores and Biographies* (1876), a continuation of Lillywhite's *Scores and Biographies*; C. Box's *English Game of Cricket* (1877); *History of a Hundred Centuries*, by W. G. Grace (1895); *History of the Middlesex County Cricket Club*, by W. J. Ford (1900); *History of the Cambridge University Cricket Club*, by W. J. Ford (1902); *History of Yorkshire County Cricket*, by R. S. Holmes (1904); *History of Kent County Cricket*, ed. by Lord Harris, (1907); *Annals of Lord's*, by A. D. Taylor (1903); *Curiosities of Cricket*, by F. S. Ashley Cooper (1901); "Cricket," by Lord Hawke, in *English Sport*, by A. E. T. Watson (1903); *Cricket*, edited by H. G. Hutchinson (1903); *Cricket Form at a Glance*, by Home Gordon (1903); *Cricket* (Badminton Library), by A. G. Steel and Hon. R. H. Lyttleton (1904); *Old English Cricketers*, by Old Ebot (1900); *Cricket in Many Climes*, by P. F. Warner (1903); *How We Recovered the Ashes*, by P. F. Warner (1904); *England v. Australia*, by J. N. Pentelov (records from 1877 to 1904) (1904); *The Jubilee Book of Cricket*, by K. S. Ranjitsinhji (1897).

**CRICKHOWELL**, a market town of Brecknockshire, Wales, 14 m. E. of Brecon, beautifully situated on the left bank of the Usk, which divides it from Llangattock. Pop. (1901) 1150. The nearest railway stations are Govilon (5 m.) and Gilwern (4 m.) on the London & North-Western railway, but a mail and passenger motor service running between Abergavenny and Brecon passes through the town. It is also served by the Brecon & Newport Canal, which passes through Llangattock about a mile distant. Agriculture is almost the sole industry of the district. The town derives its name from a British fortress, Crûg Hywel, commonly called Table Mountain, about 2 m. N.N.E. of the town. Crickhowell Castle, of which only a tower remains, probably dated from the Norman conquest of the country. The manor of Crickhowell used to be regarded as a borough by prescription, but there is no record of its ever having possessed any municipal institutions. The church is in transitional Decorated style.

**CRICKLADE**, a market town in the Cricklade parliamentary division of Wiltshire, England; 9 m. N.W. of Swindon, on the Midland & South-Western Junction railway. Pop. (1901) 1517. It is pleasantly situated in the plain which borders the south bank of the Thames, not far from the Thames & Severn Canal. The cruciform church of St Sampson is mainly Perpendicular, with a fine ornate tower, and an old rood-stone in its churchyard. The small church of St Mary has an Early English tower, Perpendicular aisles and a Norman chancel-arch. There is some agricultural trade.

Legend makes Cricklade the abode of a school of Greek philosophers before the Roman conquest, and the name is given as "Greeklade" in Drayton's *Polyolbion*. It owed its importance in Saxon times to its position at the passage of the Thames. During the revolt of Æthelwald the Ætheling in 905 he and his army "harried all the Mercian's land until they came to Cricklade and there they went over the Thames" (Anglo-Sax. Chron. *sub anno*), and in 1016 Canute came with his army over the Thames into Mercia at Cricklade (*ibid.*). There was a mint at Cricklade in the time of Edward the Confessor and William I., and William of Dover fortified a castle here in the reign of Stephen. In the reign of Henry III. a hospital dedicated to St John the Baptist was founded at Cricklade, and placed under the government of a warden or prior. Cricklade was a borough by prescription at least as early as the Domesday Survey, and returned two members to parliament from 1295 until disfranchised by the Redistribution Act of 1885. The borough was never incorporated, but certain liberties, including exemption from toll and passage, were granted to the townsmen by Henry III. and confirmed by successive sovereigns. In 1257 Baldwin de Insula obtained a grant of a Thursday market, and an annual three days' fair at the feast of St Peter ad Vincula. The market was subsequently changed to Saturday, and was much frequented by dealers in corn and cattle, but is now inconsiderable. During the 14th century Cricklade formed part of the dowry of the queens of England. In the reign of Henry VI. the lordship was acquired by the Hungerford family, and in 1427 Sir Walter Hungerford granted the reversion of the manor to the dean and chapter of Salisbury cathedral to aid towards the repair of their belfry.

**CRIEFF**, a police burgh of Perthshire, Scotland, capital of Strathearn, 17½ m. W. of Perth by the Caledonian railway. Pop. (1901) 5208. Occupying the southern slopes of a hill on the left bank of the Earn, here crossed by a bridge, it practically consists of a main street, with narrower streets branching off at right angles. Its climate is the healthiest in mid-Scotland, the air being pure and dry. Its charter is said to date from 1218, and it was the seat of the courts of the earls of Strathearn till 1747, when heritable jurisdictions were abolished. A Runic sculptured stone, believed to be of the 8th century, and the old town cross stand in High Street, but the great cattle fair, for which Crieff was once famous, was removed to Falkirk in 1770. It was probably in connexion with this market that the "kind gallows of Crieff" acquired their notoriety, for they were mostly used for the execution of Highland cattle-stealers. The principal

buildings are the town hall, tolbooth, public library, assembly rooms, mechanics' institute, Morison's academy (founded in 1859), and Strathearn House, a hydropathic establishment built on an eminence at the back of the town, and itself sheltered by the Knock of Crieff (911 ft. high). The industries consist of manufactures of cotton, linen, woollens and worsteds, and leather. Drummond Castle, about 3 m. S., is celebrated for its gardens. They cover an area of 10 acres, are laid out in terraces, and illustrate Italian, Dutch and French styles. They were planned by the 2nd earl of Perth (d. 1662), and take rank with the most magnificent in the United Kingdom. The keep of the castle dates from 1490, and much of the original building was demolished in 1689, a few years after its siege by Cromwell. The present structure was erected subsequent to the extinction of the Jacobite rebellion.

**CRIME** (Lat. *crimen*, accusation), the general term for offences against the CRIMINAL LAW (*q.v.*). Crime has been defined as "a failure or refusal to live up to the standard of conduct deemed binding by the rest of the community." Sir James Stephen describes it as "some act or omission in respect of which legal punishment may be inflicted on the person who is in default whether by acting or omitting to act." Such action or neglect of action may be injurious or hurtful to society. It is a wrong or tort, to be prevented and corrected by the strong arm of the law.

Crimes vary in character with times and countries. Under different circumstances of place and custom, that which at one time is denounced as a crime, at another passes as a meritorious act. It was once an imperative duty for the family to avenge the death of a kinsman, and the blood feud had a sanction that made killing no murder. Again, among primitive tribes to make away with parents at an advanced age or suffering from an incurable disease was a filial duty. Polyandry was sometimes encouraged, and cannibalism practised with general approval; religious sentiment elevated into heinous crimes, blasphemy, heresy, sacrilege, sorcery and even science when it ran counter to accepted dogmas of the church. Offences multiplied when people gathered into communities and the rights of property and of personal security were understood and established. The law of the strongest might still interfere with individual ownership; the weakest went to the wall; authority, whether exercised by one master or by the combined government of the many, was resisted, and this resistance constituted crime. As civilization spread and the bulk of the population settled into orderliness, society, for its own comfort, convenience and protection, would not tolerate the infraction of its rules, and rising against all law-breakers decreed reprisals against them as the common enemy. Then began that constant warfare between criminals and the forces of law and order which has been continuously waged through the centuries with varying degrees of bitterness.

The combat with crime was long waged with great cruelty. Extreme penalties were thought to constitute the best deterrent, and the principle of vengeance chiefly inspired the penal law. The harshness of ancient codes makes a more humane age shudder. It was the custom to hang or decapitate, or otherwise take life in some more or less barbarous fashion, on the smallest excuse. The final act was preceded by hideous torture. It was performed with the utmost barbarity. Victims were put to death by breaking on the wheel, burning at the stake, by dismemberment and flaying or boiling alive. These were the aggravations of the original idea of riddance, of checking crime by the absolute removal of the offender. Only slowly and gradually milder methods came into force. Revenge and retaliation were no longer the chief aims, the law had a larger mission than to coerce the criminal and force him by severity to mend his ways. To withdraw him for a lengthened period from the sphere of his baneful activity was something; to subject him to more or less irksome processes, to solitary confinement upon short diet, deprived of all the solaces of life, with severe labour, were sharp lessons limited in effect to those actually subjected to them, but too remote to deter the outside crowd of potential wrongdoers. The higher duty of the administrator

is to utilize the period of detention by labouring to reform the criminal subjects and send them out from gaol reformed characters. If no very remarkable success has been achieved in this direction, it is obviously the right aim, and it is being more and more steadfastly pursued. But it is generally accepted in principle that to eradicate criminal proclivities and cut off recruits from the permanent army of crime the work must be undertaken when the subject is of an age susceptible of reform; hence the extreme value attaching to the more enlightened treatment of crime in embryo, a principle becoming more and more largely accepted in practice among civilized nations.

It may safely be asserted that the germ of crime is universally present in mankind, ever ready to show under conditions favourable to its growth. Children show criminal tendencies in their earliest years. They exhibit evil traits, anger, resentment, mendacity; they are often intensely selfish, are strongly acquisitive, greedy of gain, ready to steal and secrete things at the first opportunity. Happily the fatal consequences that would otherwise be inevitable are checked by the gradual growth of inhibitory processes, such as prudence, reflection, a sense of moral duty, and in many cases the absence of temptation. From this Dr Nicholson deduces that "in proportion as this development is prevented or stifled, either owing to an original brain defect or by lack of proper education or training, so there is the risk of the individual lapsing into criminal-mindedness or into actual crime." In the lowest strata of society this risk is largely increased from the conditions of life. The growth of criminals is greatly stimulated where people are badly fed, morally and physically unhealthy, infected with any forms of disease and vice. In such circumstances, moreover, there is too often the evil influence of heredity and example. The offspring of criminals are constantly impelled to follow in their parents' footsteps by the secret springs of nature and pressure of childish imitateness. The seed is thrown, so to speak, into a hot-bed where it finds congenial soil in which to take root and flourish.

Wherever crime shows itself it follows certain well-defined lines and has its genesis in three dominant mental processes, the result of marked propensities. These are malice, acquisitiveness and lust. Malicious crimes may be amplified into offences against the person originating in hatred, resentment, violent temper, and rising from mere assaults into manslaughter and murder. Crimes of greed and acquisitiveness cover the whole range of thefts, frauds and misappropriation; of larcenies of all sorts; obtaining by false pretences; receiving stolen goods; robberies; house-breaking, burglary, forgery and coining. Crimes of lust embrace the whole range of illicit sexual relations, the result of ungovernable passion and criminal depravity. The proportions in which these three categories are manifested have been worked out in England and Wales to give the following figures. The percentage in any 100,000 of the population is:—

Crimes of malice . . . . .	15%
Crimes of greed . . . . .	75%
Crimes of lust . . . . .	10%

The members of these categories do not form distinct classes; their crimes are interdependent and constantly overlap. Crime in many is progressive and passes through all the stages from minor offences to the worst crimes. Murder—the culminating point of malice—is constantly preceded by petty larceny; theft by forcible entry; and robbery is associated with violence and armed resistance to capture. Criminality rising into its highest development shows itself under many forms. It is instinctive, passionate, accidental, deliberate and habitual, the outcome of abnormal appetite, of weak and disordered moral sense. The causation of crime varies, but a predominating motive is idleness, leading to the predatory instincts of gain easily acquired without the labour of continuous effort. To deprive the more industrious or more happily placed of their hard-won earnings or possessions, inspires the bulk of modern serious crime. It no doubt has produced one peculiar feature in modern crime: the extensive scale on which it is carried out. The greatest frauds are now commonly perpetrated; great robberies

are planned in one capital and executed in another. The whole is worked by wide associations of cosmopolitan criminals.

Other features of modern crime are especially interesting. It is extraordinarily precocious. Children of quite tender years commit murders, and boys and girls are frequently to be met with as professional thieves. Again, the comparative proportions of crime in the two sexes may be considered. Everywhere women are less criminal than men. Naturally they have fewer facilities for committing crimes of violence, although they have offences peculiar to their sex, such as infanticide, and are more frequently guilty of poisoning than men by 70% against 30%. Statistics presented to the Prison Congress at Stockholm fix the percentage of female criminals at 3% in Japan, the East generally, South America and some parts of North America. In some states of the American Union it is 10%; in China, 20%; in Europe generally it varies between 10% and 21%. In France the proportion of accused women is fifteen to eighty-five men. In Great Britain it is now one in four, but has been less. The total sentenced in 1905-1906 to penal servitude and imprisonment was 139,389 men and 44,294 women, the balance being made up by summary convictions. The curious fact in female crime is that one-seventh of the women committed to prison had already been convicted from eleven to twenty times. It has been well said from the above proportions that women are less criminal according to the figures, because when a woman wants a crime committed she can generally find a man to do it for her.

It has often been debated whether or not prison methods react upon the criminality of the country; whether, in other words, severity of treatment *deters*, while milder methods encourage the wrongdoers to despise the penalties imposed by the law. Evidence for and against the verdict may be drawn from the whole civilized world. In England, as judged by the increase or decrease of the prison population, it might be supposed that the prison system was at one time effective in diminishing crime. Between 1878 and 1891 there was a steady decrease in numbers because of it. More recently there has been an appreciable increase in the number of crimes and proportionately of those imprisoned. The figures for 1906 showed a distinct increase in criminality for that year as compared with the years immediately preceding. The proportion of indictable offences had increased in 1906 from 59,079 as against 50,494 in 1899, or in the proportion of 171.01 per 100,000 of the population as against 158.97, a very marked increase over earlier years. Nevertheless the figures for 1906, although high, are by no means the highest, as on eight occasions during the fifty odd years for which statistics were available in 1909 the total crimes exceeded 60,000, and in the quinquennial period 1860-1864 the annual average was 280 per 100,000 as compared with 171.01 for 1906 and 175 for the quinquennial period 1902-1906. The quality of the crime varied, and while offences against property have increased, those against the person have constantly fallen. Quite half the whole number of crimes were committed by old offenders (see RECIDIVISM).

Statistics have not been kept with the same care in all other countries, but some authentic figures may be quoted for France, where the number of thefts increased while offences against the person diminished. In Belgium there has been a satisfactory decrease in recent years. In Prussia the prison population has on the whole increased, but there has been a slight diminution in more serious crime. Some very noticeable figures are forthcoming from the United States, and comparison is possible of the relative amount of crime in the two countries, America and England. Here the want of statistics covering a large period is much to be regretted. On the general question serious crime in the ten years between 1880 and 1890 slightly increased, while petty crime was very considerably less during the period. Charges for homicide have been much more numerous. There were in 1880, 4608, or a ratio of 9.1 to 100,000 of the population; but in 1890 these offences rose to 7351, or a ratio of 11.7. Comparing America with England, it has been calculated in round numbers that the proportion of prisoners to the general population was in the United States as 1 to every 759, and in England 1 to every 1764 persons. As regards the more serious crimes

the number in English convict prisons was as 1 to 10,000, and in the American state prisons (the corresponding institutions) the ratio was 1 to every 1358. In the lesser prisons, *i.e.* the English local prisons and the American city or county gaols, the numbers more nearly approximate, being in England 1 to 2143 and in America 1 to 1721. It has been argued that much of the crime in America is attributable to the preponderance of foreign immigrants, but the ratio of native born prisoners is that of 1237 to the million, of foreign born prisoners 1777 to the million.

**AUTHORITIES.**—A. MacDonald, *Criminology* (New York, 1893); A. Drähms, *The Criminal* (New York, 1900); E. Ferri, *La Sociologie criminelle*, trans. Ferrier (Paris, 1905); all these contain extensive bibliographies. See also under **CRIMINOLOGY**. (A. G.)

**CRIMEA** (ancient *Tauris* or Tauric Chersonese, called by the Russians by the Tatar name *Krym* or *Crim*), a peninsula on the north side of the Black Sea, forming part of the Russian government of Taurida, with the mainland of which it is connected by the Isthmus of Perekop (3.4 m. across). It is rudely rhomboid in shape, the angles being directed towards the cardinal points, and measures 300 m. between 44° 23' and 46° 10' N., and 110 m. between 38° 30' and 36° 40' E. Its area is 9700 sq. m.

Its coasts are washed by the Black Sea, except on the north-east, where is the Sivash or Putrid Sea, a shallow lagoon separated from the Sea of Azov by the Arabat spit of sand. The shores are broken by several bays and harbours—on the west side of the Isthmus of Perekop by the Bay of Karkinit; on the south-west by the open Bay of Kalamita, on the shores of which the allies landed in 1854, with the ports of Eupatoria, Sevastopol and Balaklava; by the Bay of Arabat on the north side of the Isthmus of Yenikale or Kerch; and by the Bay of Kaffa or Feodosiya (Theodosia), with the port of that name, on the south side of the same. The south-east coast is flanked at a distance of 5 to 8 m. from the sea by a parallel range of mountains, the Yaila-dagh, or Alpine Meadow mountains, and these are backed, inland, by secondary parallel ranges; but 75% of the remaining area consists of high arid prairie lands, a southward continuation of the Pontic steppes, which slope gently north-westwards from the foot of the Yaila-dagh. The main range of these mountains shoots up with extraordinary abruptness from the deep floor of the Black Sea to an altitude of 2000 to 2500 ft., beginning at the south-west extremity of the peninsula, Cape Fiolente (anc. *Parthenium*), supposed to have been crowned by the temple of Artemis in which Iphigeneia officiated as priestess. On the higher parts of this range are numerous flat mountain pastures (Turk. *yailas*), which, except for their scantier vegetation, are analogous to the *almen* of the Swiss Alps, and are crossed by various passes (*bogaz*), of which only six are available as carriage roads. The most conspicuous summits in this range are the Demir-kapu or Kemal-egherek (5040 ft.), Roman-kosh (5060 ft.), Chatyr-dagh (5000 ft.), and Karabi-yaila (3975 ft.). The second parallel range, which reaches altitudes of 1500 to 1900 ft., likewise presents steep crags to the south-east and a gentle slope towards the north-west. In the former slope are thousands of small caverns, probably inhabited in prehistoric times; and several rivers pierce the range in picturesque gorges. A valley, 10 to 12 m. wide, separates this range from the main range, while another valley 2 to 3 m. across separates it from the third parallel range, which reaches altitudes of only 500 to 850 ft. Evidences of a fourth and still lower ridge can be traced towards the south-west.

A number of short streams, none of them anywhere navigable, leap down the flanks of the mountains by cascades in spring, *e.g.* the Chernaya, Belbek, Kacha and Alma, to the Black Sea, and the Salghir, with its affluent, the Kara-su, to the Sivash lagoon.

In point of climate and vegetation there exist marked differences between the open steppes and the south-eastern littoral, with the slopes of the Yaila-dagh behind it. The former, although grasses and Liliaceae grow on them in great variety and luxuriance in the early spring, become completely parched up by July and August, while the air is then filled with clouds

of dust. There also high winds prevail, and snowstorms, hailstorms and frost are of common occurrence. Nevertheless this region produces wheat and barley, rye and oats, and supports numbers of cattle, sheep and horses. Parts of the steppes are, however, impregnated with salt, or studded with saline lakes; there nothing grows except the usual species of *Artemisia* and *Salsola*. As a rule water can only be obtained from wells sunk 200 to 300 ft. deep, and artesian wells are now being bored in considerable numbers. All over the steppes are scattered numerous *kurgans* or burial-mounds of the ancient Scythians. The picture which lies behind the sheltering screen of the Yaila-dagh is of an altogether different character. Here the narrow strip of coast and the slopes of the mountains are smothered with greenery. This Russian Riviera stretches all along the south-east coast from Cape Sarych (extreme S.) to Feodosiya (Theodosia), and is studded with summer sea-bathing resorts—Alupka, Yalta, Gursuv, Alushta, Sudak, Theodosia. Numerous Tatar villages, mosques, monasteries, palaces of the Russian imperial family and Russian nobles, and picturesque ruins of ancient Greek and medieval fortresses and other buildings cling to the acclivities and nestle amongst the underwoods of hazel and other nuts, the groves of bays, cypresses, mulberries, figs, olives and pomegranates, amongst the vineyards, the tobacco plantations, and gardens gay with all sorts of flowers; while the higher slopes of the mountains are thickly clothed with forests of oak, beech, elm, pines, firs and other Coniferae. Here have become acclimatized, and grow in the open air, such plants as magnolias, oleanders, tulip trees, bignonias, myrtles, camellias, mimosas and many tender fruit-trees. Vineyards cover over 19,000 acres, and the wine they yield (3½ million gallons annually) enjoys a high reputation. Fruits of all kinds are produced in abundance. In some winters the tops of the mountains are covered with snow, but snow seldom falls to the south of them, and ice, too, is rarely seen in the same districts. The heat of summer is moderated by breezes off the sea, and the nights are cool and serene; the winters are mild and healthy. Fever and ague prevail in the lower-lying districts for a few weeks in autumn. Dense fogs occur sometimes in March, April and May, but seldom penetrate inland. The difference of climate between the different parts of the Crimea is illustrated by the following data: annual mean, at Melitopol, on the steppe N. of Perekop, 48° Fahr.; at Simferopol, just within the mountains, 50°; at Yalta, on the south-east coast, 56.5°; the respective January means being 20°, 31° and 39.5°, and the July means 74°, 70° and 75.5°. The rainfall is small all over the peninsula, the annual average on the steppes being 13.8 in., at Simferopol 17.5, and at Yalta 18 in. It varies greatly, however, from year to year; thus at Simferopol it ranges between the extremes of 7.5 and 26.4 in.

Other products of the Crimea, besides those already mentioned, are salt, porphyry and limestone, and ironstone has recently been brought to light at Kerch. Fish abound all round the coast, such as red and grey mullet, herring, mackerel, turbot, soles, plaice, whiting, bream, haddock, pilchard, a species of pike, whitebait, eels, salmon and sturgeon. Manufacturing industries are represented by shipbuilding, flour-mills, ironworks, jam and pickle factories, soap-works and tanneries. The Tatars excel in a great variety of domestic industries, especially in the working of leather, wool and metal. A railway, coming from Kharkov, crosses the peninsula from north to south, terminating at Sevastopol and sending off branch lines to Theodosia and Kerch.

The bulk of the population consist of Tatars, who, however, are racially modified by intermarriage with Greeks and other ethnic elements. The remainder of the population is made up of Russians, Germans, Karaite Jews, Greeks and a few Albanians. The total in 1897 was 853,900, of whom only 150,000 lived in the towns. Simferopol is the chief town; others of note, in addition to those already named, are Eupatoria and Bakhchisarai, the old Tatar capital.

**History.**—The earliest inhabitants of whom we have any authentic traces were the Celtic Cimmerians, who were expelled

by the Scythians during the 7th century B.C. A remnant, who took refuge in the mountains, became known subsequently as the Tauri. In that same century Greek colonists began to settle on the coasts, e.g. Dorians from Heraclea at Chersonesus, and Ionians from Miletus at Theodosia and Panticapaeum (also called Bosporus). Two centuries later (438 B.C.) the archon or ruler of the last-named assumed the title of king of Bosporus, a state which maintained close relations with Athens, supplying that city with wheat and other commodities. The last of these kings, Paerisades V., being hard pressed by the Scythians, put himself under the protection of Mithradates VI., king of Pontus, in 114 B.C. After the death of this latter sovereign his son Pharnaces, as a reward for assistance rendered to the Romans in their war against his father, was (63 B.C.) invested by Pompey with the kingdom of Bosporus. In 15 B.C. it was once more restored to the king of Pontus, but henceforward ranked as a tributary state of Rome. During the succeeding centuries the Crimea was overrun or occupied successively by the Goths (A.D. 250), the Huns (376), the Khazars (8th century), the Byzantine Greeks (1016), the Kipchaks (1050), and the Mongols (1237). In the 13th century the Genoese destroyed or seized the settlements which their rivals the Venetians had made on the Crimean coasts, and established themselves at Eupatoria, Cembalo (Balaklava), Soldaia (Sudak), and Kaffa (Theodosia), flourishing trading towns, which existed down to the conquest of the peninsula by the Ottoman Turks in 1475. Meanwhile the Tatars had got a firm footing in the northern and central parts of the peninsula as early as the 13th century, and after the destruction of the Golden Horde by Tamerlane they founded an independent khanate under a descendant of Jenghiz Khan, who is known as Hadji Ghirai. He and his successors reigned first at Solkhat (Eski-krym), and from the beginning of the 15th century at Bakhchi-sarai. But from 1478 they ruled as tributary princes of the Ottoman empire down to 1777, when having been defeated by Suvarov they became dependent upon Russia, and finally in 1783 the whole of the Crimea was annexed to the Russian empire. Since that date the only important phase of its history has been the Crimean War of 1854-56, which is treated of under a separate article. At various times, e.g. after the acquisition by Russia, after the Crimean War of 1854-56, and in the first years of the 20th century, the Tatars emigrated in large numbers to the Ottoman empire.

See *Antiquités du Bosphore cimmérien* (3 vols., St Petersburg, 1854); C. Bossoll, *The Beautiful Scenery of the Crimea* (52 large drawings, London, 1855-1856); P. Brunn, *Notices hist. et topogr. concernant les colonies italiennes en Gazarie* (St Petersburg, 1866); J. B. Telfer, *The Crimea and Transcaucasia* (2 vols., London, 2nd ed., 1877); F. Remy, *Die Krim in ethnographischer, landschaftlicher und hygienischer Beziehung* (Leipzig, 1872); Joseph, Baron von Hammer-Purgstall, *Geschichte der Chane der Krim unter osmanischer Herrschaft* (Vienna, 1856); M. G. Canale, *Della Crimea e dei suoi dominatori dalle sue origini fino al trattato di Parigi* (3 vols., Genoa, 1855-1856); and Sir Evelyn Wood, *The Crimea in 1854 and 1864* (London, 1895). (See also BOSPORUS CIMMERIUS.) (P. A. K.; J. T. BE.)

**CRIMEAN WAR.** The war of 1853-56, usually known by this name, arose from causes the discussion of which will be found under the heading **TURKEY: History**. When Turkey, after a period of irregular fighting, declared war on Russia in October 1853, Great Britain and France (subsequently assisted by Sardinia) intervened in the quarrel. At first this intervention was represented merely by the presence of an allied squadron in the Bosporus, but the storm of indignation aroused in Great Britain and France by the destruction of the Turkish fleet at Sinope (30th November) soon impelled these powers to more active measures. On the 27th of January 1854 they declared war on the tsar, and prepared to carry their armaments to the Danube. In this, the main, theatre of war, the Turks had hitherto proved quite capable of holding their own. The Russian commander, Prince Michael Gorchakov, had crossed the Pruth with two corps early in July 1853, and had overrun Moldavia and Wallachia without difficulty. Omar Pasha, however, disposing of superior forces, was able to check any further advance. During October, November and December the Turks won a succession of actions, of which that at Oltenitza

(Nov. 4th) may be particularly mentioned, and a little later Gorchakov found himself compelled to fight at Cetatea (Tchetati) before reinforcements could come up. The defeat he sustained was for the time being decisive (6th Jan. 1854). Three months later, the Russians, now under command of the veteran Prince Paskievich, took the offensive in great force. Crossing the Danube near its mouth at Galatz and Braila, they advanced through the Dobrudja and closed upon the fortress of Silistria, which offered a strong and steady resistance, with an effect all the greater as the Turks from the side of Shumla, now supported by the leading British and French brigades at Varna, prevented a close investment. The Turks, however, avoided a decisive encounter, and the stormers stood ready in the trenches before Silistria, when the siege was suddenly raised. The decision had passed into other hands. The tsar had learned that the Austrian army of observation in Transylvania, 50,000 strong under Feldzeugmeister Hess, was about to enforce the wishes of the "Four Powers." The Russian offensive was at an end, the



army hastily fell back, and on the 2nd of August 1854 the last man recrossed the Pruth. The principalities were at once occupied by Hess.

*The Invasion of the Crimea.*—The primary object of the war had thus easily been obtained. But Great Britain and France were by no means content with a triumph that left untouched the vast resources of an enemy who was certain to employ them at the next opportunity. The two nations felt that Sevastopol, the home of the Black Sea fleet, the port whence Admiral Nachimov had sailed for Sinope, must be crippled for some years at least, and as early as June 20th Lord Raglan and Marshal Saint Arnaud, the allied commanders of England and France, had received instructions to "concert measures for the siege of Sevastopol." Dynastic considerations reinforced the arguments of policy and popular opinion in the case of France; in Great Britain soldier and civilian alike saw the menace of a Russian Mediterranean fleet in the unfinished forts and busy dockyards. The popular strategy for once coincided with the views of the responsible leaders. Yet there is no sign that either the commanders on the spot or their governments realized the magnitude of the undertaking. Few but the most urgently necessary preparations were made, and cholera, breaking out virulently amongst the French at this time, reduced the army



at Varna, and even the fleet at sea, to impotence. The troops were so weakened that, even in September, the five-mile march from camp to transport exhausted most of the men. Heavy weather still further delayed the start, and it was not until the 7th of September that the expedition began to cross the Black Sea. One hundred and fifty war-vessels and transports conveyed the army, which, guarded on all sides by the fighting fleet, crossed without incident and drew up on the Crimean coast on September 13th. Tactical considerations prevailed in the choice of place. The landlocked harbours south of Sevastopol were for the time being neglected, and a spot known as Old Fort preferred, because the long beach, the heavy metal of the ships' broadsides, and a line of lagoons covering the front offered singularly favourable conditions for the delicate operation of disembarkation. Still, on this side of Sevastopol there was no good harbour, and it is quite open to question whether in this case the strategic necessities of the situation were not neglected in favour of purely tactical and temporary advantages. As a matter of fact no opposition was offered to the landing, but the weather prevented the disembarkation being completed until the 18th. St Arnaud and Raglan had at this time under their orders 51,000 British, French and Turkish infantry, 1000 British cavalry, and 128 guns, and on the 19th this force (less some detachments) began the southward march in order of battle, the British (who alone had their cavalry present) on the exposed left flank, the French next the sea, the fleet moving in the same direction parallel to the troops.

*The Alma.*—Old Fort was beyond the reach of Menshikov, the Russian commander, but, as the fortress communicated with the interior of Russia via Kerch and Simferopol, it was to be expected that he would either accept battle on the Sevastopol road, or cover Simferopol by a flank attack on Lord Raglan. Both these contingencies were provided for by the order of march, and in due course it was ascertained that the Russians adopted the former alternative, and barred the Sevastopol road on the heights of the river Alma. Menaced by the guns of the fleet, Menshikov had wheeled back his left, and at the same time he strengthened his right in order to cover the Simferopol road. From this it followed naturally that the brunt of the attack fell upon the British divisions, whilst the French, nearer the sea, struck to some extent *dans le vide*. The two commanders, after a reconnaissance, decided upon their plan. The French divisions in echelon from the right were to cross the river and force Menshikov inwards, whilst the British were to move straight to their front against the strongest part of the Russian line. Substantially this plan was carried out on the 20th of September. Owing to want of men (he had but 36,400 against over 50,000) Menshikov was unable to hold his left wing very strongly, and the French were scarcely checked save by physical obstacles; but opposite the British force the ground sloped glacis-wise up to the Russian line, and nothing but their iron discipline, the best heritage of the Peninsular War, brought them victorious to the crest of Kurghane hill. The Russians had no option but to retreat, which they did without molestation. The allies lost about 3000 men, mostly British (though Prince Napoleon's men also suffered heavily); the Russians reported 5709 casualties.

*The March on Sevastopol.*—On the 23rd of September the advance was resumed, and by the 25th Sevastopol was in full view of the allied outposts. It was now that the necessary consequences of the choice of Old Fort as the landing-place presented themselves as a problem for instant solution. Whatever chance there had been of assaulting the north side of Sevastopol was now gone. Menshikov had sacrificed some ships in order to seal up the harbour mouth, and naval co-operation in attack was now impossible, while the other Russian ships could in safety aid the defenders with their heavy guns. A siege, based on the beach of Old Fort or the open roads of Kacha, was out of the question, as was re-embarkation for a fresh landing. There remained only a flank march by Mackenzie's farm and the river Chernaya. Once established on the south side, the allies could use the excellent harbours of Kamiesh and Balaklava; this could almost certainly be effected without

fighting, while in besieging Sevastopol itself and not merely the north side, the allies would be striking at the heart. But a flank march is almost always in itself a hazardous undertaking, and in this case the invaders were required further to abandon their line of retreat on Old Fort. In point of fact, the army, covered by a division opposite the Russian works, successfully accomplished the task. At the same moment Menshikov, after providing for the defence of Sevastopol, had marched out with a field army towards Bakhchiserai, and on the 25th of September each army, without knowing it, actually crossed the other's front. On arrival at Balaklava the allies regained contact with the fleet, and the detachment left on the north side, its mission being at an end, followed the same route and rejoined the main body. The French now took possession of Kamiesh, the British of Balaklava.

*Beginning of the Siege.*—Thus secured, the allies closed upon the south side of the fortress. A siege corps was formed, and the British army and General Bosquet's French corps covered its operations against interruption from the Russian field army. The harbour of Sevastopol, formed by the estuary of the Chernaya, was protected against attack by sea not only by the Russian war-vessels, afloat and sunken, but also by heavy granite forts on the south side and by the works which had defied the allies on



the north. For the town itself and the Karabelnaya suburb the trace of the works had been laid down for years. The Malakoff, a great tower of stone, covered the suburb, flanked on either side by the Redan and the Little Redan. The town was covered by a line of works marked by the Flagstaff and central bastions, and separated from the Redan by the inner harbour. Lieut.-Col. Todleben, the Russian chief engineer, had very early begun work on these sites, and daily re-creating, rearming and improving the fortifications, finally connected them by a continuous enceinte. Yet Sevastopol was not, early in October 1854, the towering fortress it afterwards became, and Todleben himself maintained that, had the allies immediately assaulted, they would have succeeded in taking the place. There were, however, many reasons against so decided a course, and it was not until the 17th of October that the first attack took place. All that day a tremendous artillery duel raged. The French siege corps lost heavily and its guns were overpowered. The fleet engaged the harbour batteries close inshore, and suffered a loss of 500 men, besides severe damage to the ships. On the other hand the British siege batteries silenced the Malakoff and its annexes, and, if failure had not occurred at the other points of attack, an assault might have succeeded. As it was, Todleben, by daybreak, had repaired and improved the damaged works. Meanwhile General Canrobert had succeeded St Arnaud (who died on the 29th of September) in the joint leadership of

the allies. It was not long before Menshikov and the now augmented field army from Bakhchiserai appeared on the Chernaya and moved towards the Balaklava lines and the British base.

*Balaklava.*—A long line of works on the upland secured the siege corps from interference, and the Balaklava lines themselves were strong, but the low Vorontsov ridge between the two was weakly held, and here the Russian commander hoped to sever the line of communications. On the 25th of October Liprandi's corps carried its slight redoubts at the first rush. But the British cavalry stationed at the foot of the upland was situated on their flank, and as the Russian cavalry moved towards Kadikoï, the "Heavy Brigade" under General Scarlett charged home with such effect that Menshikov's troopers only rallied behind their field batteries near Traktir bridge. At the same time some of the Russian squadrons, coming upon the British 93rd regiment outside the Balaklava lines, were completely broken by the steady volleys of the "thin red line." The "Light Brigade" of British cavalry, farther north, had hitherto remained inactive, even when the Russians, broken by the "Heavies," fled across their front. The cavalry commander, Lord Lucan, now received orders to prevent the withdrawal of the guns taken by Liprandi. The aide-de-camp who carried the order was killed by the first shell, and the whole question of responsibility for what followed is wrapped in obscurity. Lord Cardigan led the Light Brigade straight at the Russian field batteries, behind which the enemy's squadrons had re-formed. From the guns in front, on the Fedukhin heights, and on the captured ridge to their right, the advancing squadrons at once met a deadly converging fire, but the gallant troopers nevertheless reached the guns and cut down the artillerymen. Small parties even charged the cavalry behind, and at least two unbroken squadrons struck out right and left with success, but the combat could only end in one way. The 4th Chasseurs d'Afrique relieved the British left by a dashing charge. The "Heavies" made as if to advance, but came under such a storm of fire that they were withdrawn. By twos and threes the gallant survivors of the "Light Brigade" made their way back. Two-thirds of its numbers were left on the field, and the day closed with the Russians still in possession of the Vorontsov ridge.

*Inkerman.*—If the heights lost in this action were not absolutely essential to the safety of the allies, the point selected for the next attempt at relief was of vital importance. The junction of the covering army and the siege corps near Inkerman was the scene of a slight action on the day following Balaklava, and the battle of Inkerman followed on the 5th of November. By that time the French had made good the losses of the 17th of October, their approaches were closing upon Flagstaff bastion, and the British batteries daily maintained their superiority over the Malakoff. On the 5th there was to have been a meeting of generals to fix the details of an assault, but at dawn the Russian army, now heavily reinforced from Odessa, was attacking with the utmost fury the British divisions guarding the angle between Bosquet and the siege corps. The battle of Inkerman defies description; every regiment, every group of men bore its own separate part in the confused and doubtful struggle, save when leaders on either side obtained a momentary control over its course by means of reserves which, carrying all before them with their original impetus, soon served but to swell the mêlée. It was a "soldiers' battle" pure and simple. After many hours of the most desperate fighting the arrival of Bosquet (hitherto contained by a force on the Balaklava ground) confirmed a success won by supreme tenacity against overwhelming odds, and Menshikov sullenly drew off his men, leaving over 12,000 on the field. The allies had lost about 3300 men, of whom more than two-thirds belonged to the small British force on which the strain of the battle fell heaviest. Their losses included several generals who could ill be spared, but they had held their ground, which was all that was required of them, with almost unrivalled tenacity. Lord Raglan was promoted to be field marshal after the battle.

*The Winter of 1854-1855.*—It was now obvious that the army

must winter in the Crimea, and preparations in view of this were begun betimes. But on the night of November 14th a violent storm arose which wrecked nearly thirty vessels with their precious cargoes of treasure, medical comforts, forage, clothing and other necessaries. After so grave a calamity it was to be expected that the troops would be called upon to undergo great hardships. But the direct cause of sufferings that have become a byword for the utmost depths of misery was the loss of twenty days' forage in the great storm. Of food and clothing enough was in store to tide over temporary difficulties, but the only paved road from Balaklava to the British camps was now in Russian hands, and the few starving transport animals were utterly inadequate for the work of drawing wagons over the miry plain; things went from bad to worse with Raglan's troops, until from the outposts before the Redan to the hospitals at Scutari a state of the utmost misery prevailed, relieved only by the example of devotion and self-sacrifice set by officers and men. The British hospital returns showed eight thousand sick at the end of November. Even the French, whose base of Kamiesh had escaped the storm, were not unhurt by the severity of the winter, but Napoleon III. sent freely all the men his general asked, while the Russians in Sevastopol, who had made long painful marches from the interior, were the survivors of the fittest. Canrobert took over the lines before the Malakoff to relieve the British. He had at the end of January 1855 78,000 men for duty; Raglan could barely muster 12,000. But, with the advent of spring, paved roads and a railway were promptly taken in hand, and during the remainder of the war the British troops were so well cared for that their death-rate was lower than at home, while the hospitals in rear, thanks to the energy and devotion of Florence Nightingale and her nurses, became models of good management.

*Course of the Siege.*—Meanwhile the siege works were making but slow progress, and the fortress grew day by day under the skilful direction of Todleben. Rifle-pits pushed out in front of the defenders' lines were connected so as to form a veritable envelope. Beyond the left wing a new line, the "White Works," sprang up in a single night, and the hill of the Mamelon was suddenly crowned with a lunette to cover the still defiant Malakoff. But the absence of bomb-proof cover exposed the huge working parties necessary for these defences to an almost incessant *feu d'enfer*, by which the Russians every week suffered the losses of a pitched battle. Meanwhile the field army was idle, Menshikov had been replaced by Prince Michael Gorchakov, Liprandi's corps had withdrawn from the Vorontsov ridge, and Omar Pasha, with a detachment of the troops he had led at Oltenitza and Cetatea, repulsed a Russian attack on Eupatoria (Feb. 17th). The besiegers steadily approached the White Works, Mamelon, Redan and Flagstaff bastion, and as spring arrived the logistic and material advantages of the allies returned. On Easter Sunday (April 8th, 1855) another terrific bombardment began, which lasted almost uninterruptedly for ten days. The White Works and the Mamelon were practically destroyed, and the Russians, drawn up in momentary expectation of assault, lost between six and seven thousand men.

But the bombardment ceased, and assault did not follow. For, at the allied headquarters and at Paris, grave differences of opinion on the conduct of the war had developed. Napoleon III. wished active operations to be undertaken against the Simferopol field army, whereas the leaders on the spot, while admitting the theoretical soundness of the French emperor's views, considered that they were wholly beyond the means of the two armies. The discussions culminated in Canrobert's resignation of the chief command, though he would not leave the army, and took a subordinate post, which he filled with great distinction to the end of the war. His successor, General Péllissier, was a soldier trained in the hard school of Algerian warfare, and endowed, as was soon evident, with the most inflexible resolution of character. He did not hesitate to take up and maintain a position of decided opposition to his sovereign's views; and the capture of Kerch (24th May 1855), carried out by a joint expedition, was the first earnest of new vigour in the

operations. This success served all the purposes of a complete investment of Sevastopol, the want of which had greatly troubled the allied generals. The line of communication and supply between Sevastopol and the interior was cut, vast stores intended for the fortress were destroyed, and the sea of Azov was cleared of shipping. On the 25th Canrobert established himself on the Fedukhin heights, his right continued along the Chernaya by General la Marmora's newly arrived Sardinians, 15,000 strong, while masses of Turks occupied the Vorontsov ridge and the old Balakhava battlefield.

As June approached, Raglan and Pélissier, who, unlike most allied commanders, were in complete accord and sympathy, initiated very vigorous methods of attack. They decided that the works west of Flagstaff could be comparatively neglected, and the full weight of the bombardment once more fell upon the Mamelon and the Malakoff. Once more these works were reduced to ruins, but the rest of the defences still held out.

*The Assault of the Redan.*—On the 7th of June 1855 the French stormed the Mamelon and the White Works, the British captured and maintained some quarries close to the Redan, and next morning the whole of Todleben's envelope had become a siege-parallel. The losses were, as usual, heavy, 8500 to the Russians, 6883 to the allies. This was merely a preliminary to the great assault fixed for the 18th, the fortieth anniversary of Waterloo. But meanwhile Pélissier's temper and Raglan's health had been strained to breaking-point by continued dissensions with Paris and London. The telegraph, a new strategic factor, daily tormented the unfortunate commanders with the latest ideas of the Paris strategists, and on the fateful day the two armies rushed on to failure. The French attack on the Malakoff dwindled away into a meaningless fire-fight: the British, attacking the Redan in face of a cross-fire of one hundred heavy guns, at first succeeded in entering the work, but in the end sustained a bloody and disastrous repulse. Of the six generals who led the two attacks, four were killed and one wounded, and on the 17th and 18th the losses to the Russians were 5400, to the allies 4000. But the defenders' resources were almost at an end, and the bombardment reopened at once with increased fury. On the 20th Todleben was wounded, and soon afterwards Nakhimov, the victor of Sinope, found a grave by the side of three other admirals who had fallen in the defence. Pélissier resolutely clung to his plans, in spite of the failure of the 18th, against ever-increasing opposition at home. Raglan, worn out by his troubles and heartbroken at the Redan failure, died on the 28th, mourned by none more deeply than by his stern colleague.

*The Storming of the Malakoff.*—During July the Russians lost on an average 250 men a day, and at last it was decided that Gorchakov and the field army must make another attack at the Chernaya—the first since Inkerman. On the 16th of August the corps of Generals Liprandi and Read furiously attacked the 37,000 French and Sardinian troops on the heights above Traktir Bridge. The assailants came on with the greatest determination, but the result was never for one moment doubtful. At the end of the day the Russians drew off baffled, leaving 260 officers and 8000 men on the field. The allies only lost 1700. With this defeat vanished the last chance of saving Sevastopol. On the same day (Aug. 16th) the bombardment once more reduced the Malakoff and its dependencies to impotence, and it was with absolute confidence in the result that Pélissier planned the final assault. On the 8th of September 1855 at noon, the whole of Bosquet's corps suddenly swarmed up to the Malakoff. The fighting was of the most desperate kind. Every casemate, every traverse, was taken and retaken time after time, but the French maintained the prize, and though the British attack on the Redan once more failed, the Russians crowded in that work became at once the helpless target of the siege guns. Even on the far left, opposite Flagstaff and Central bastions, there was severe hand-to-hand fighting, and throughout the day the bombardment mowed down the Russian masses along the whole line. The fall of the Malakoff was the end of the siege. All night the Russians were filing over the bridges to the north side, and on

the 9th the victors took possession of the empty and burning prize. The losses in the last assault had been very heavy, to the allies over 10,000 men, to the Russians 13,000. No less than nineteen generals had fallen on that day. But the crisis was surmounted. With the capture of Sevastopol the war loses its absorbing interest. No serious operations were undertaken against Gorchakov, who with the field army and the remnant of the garrison held the heights at Mackenzie's Farm. But Kinburn was attacked by sea, and from the naval point of view the attack is interesting as being the first instance of the employment of ironclads. An armistice was agreed upon on the 26th of February and the definitive peace of Paris was signed on the 30th of March 1856.

*Decisive Importance of the Victory.*—The importance of the siege of Sevastopol, from the strategical point of view, lies beneath the surface. It may well be asked, why did the fall of a place, at first almost unfortified, bring the master of the Russian empire to his knees? At first sight Russia would seem to be almost invulnerable to a sea power, and no first success, however crushing, could have humbled Nicholas I. Indeed the capture of Sevastopol in October 1854 would have been far from decisive of the war, but once the tsar had decided to defend to the last this arsenal, the necessity for which he was in the best position to appreciate, the factor of unlimited resources operated in the allies' favour. The sea brought to the invaders whatever they needed, whilst the desert tracks of southern Russia were marked at every step with the corpses of men and horses who had fallen on the way to Sevastopol. The hasty nature, too, of the fortifications, which, daily crushed by the fire of a thousand guns, had to be re-created every night, made huge and therefore unprotected working parties necessary, and the losses were correspondingly heavy. The double cause of loss completely exhausted even Russia's resources, and, when large bodies of militia appeared in line of battle at Traktir Bridge, it was obvious that the end was at hand. The novels of Tolstoy give a graphic picture of the war from the Russian point of view: the miseries of the desert march, the still greater miseries of life in the casemates, and the almost daily ordeal of manning the lines under shell-fire to meet an assault that might or might not come; and no student of the siege can leave it without feeling the profoundest respect for the courage, discipline and stubborn loyalty of the defenders.

*Minor Operations.*—A few words may be added on the minor operations of the war. The Asiatic frontier was the scene of severe fighting between the Turks and the Russians. Hindered at first by Shamyl and his Caucasian mountaineers, the Russians stood on the defensive during 1853, but next year they took the offensive, and, while their coast column won an action on the 16th of June at the river Churuk, another force from Erivan gained an important success on the Araxes and took Bayazid, and General Bebutov completely defeated a Turkish column from Kars at Kuruk Dere (July 31st, 1854). Next year Count Muraviev completely isolated the garrison of Kars, which made a magnificent defence, inspired by Fenwick Williams Pasha and other British officers. In one assault alone 7000 Russians were killed and wounded, and it was not until the 26th of November 1855 that the fortress was forced to surrender. The naval operations in the Baltic furnish many interesting examples for the study of naval war. The allied fleet in 1854, after a first repulse, succeeded in landing a French force under Baraguay d'Hilliers before Bomarsund, and the place fell after an eight days' siege. In 1855 seventy allied warships appeared before Kronstadt, which defied them. Reinforced they attacked Sveaborg, but after two days' fighting had to draw off baffled.

The numbers engaged in the Crimean War and the cost in men and money is stated in round numbers below. In May 1855 the Crimean theatre of war occupied 174,500 allies (of whom 32,000 were British) and 170,000 Russians. The losses in battle were: allies 70,000 men, Russians 128,700; and the total losses, from all causes and in all theatres of the war: allies 252,600 (including 45,000 English), Russians 256,000 men (Berndt, *Die Zahl im Kriege*, p. 35). In the siege of Sevastopol the Russians are stated by Berndt to have lost 102,670 men dead, wounded and missing.

Mulhall (*Dict. of Statistics*, 1903 ed., pp. 586-587) gives much greater losses to each of the four powers principally engaged. The cost of the war in money is stated by Mulhall to have been £69,000,000 to Great Britain, £93,000,000 to France, £142,000,000 to Russia.

**AUTHORITIES.**—Of the many works on the Crimean War those of the greatest value are the following. English: the official work on the *Siege of Sebastopol*; A. W. Kinglake, *The Invasion of the Crimea* (London, 1863; "Student's edition" by Sir G. S. Clarke); Sir E. B. Hamley, *The War in the Crimea* (London, 1891); (Sir) W. H. Russell, *The War in the Crimea* (London, 1855-1856); Sir Evelyn Wood, *The Crimea in 1854 and in 1854* (London, 1895); Sir D. Lysons, *The Crimean War from First to Last* (London, 1895); Col. A. Lake, *The Defence of Kars* (London, 1857). French: Official, *Guerre de l'Orient, Hist. de l'artillerie* (Paris, 1859); (Marshal Niel), *Siège de Sébastopol* (official account of engineer operations, Paris, 1858), and *Atlas historique et topographique de la guerre de Crimée* (see also the map of Russia by the French staff, sheets 56 and 57); Baron C. de Bazancourt, *L'Expédition de Crimée* (Paris, 1856); C. Rousset, *Histoire de la guerre de Crimée* (Paris, 1877). Russian: the work of Todleben, *Die Vertheidigung von Sebastopol* (St Petersburg, 1864); *Défense de Sébastopol* (St Petersburg, 1863); Anitschkoff, *Feldzug in der Krim* (German trans., Berlin, 1857); Bogdanovitch, *Der Orientkrieg* (St Petersburg, 1876); Petroff, *Der Donaufeldzug Russlands gegen Türkei* (German trans., Berlin, 1891). Of German works the most useful are: Kunz, *Die Schlachten und Treffen des Krimkrieges* (Berlin, 1889); *Der Feldzug in der Krim; Sammlung der Berichte beider Parteien* (Leipzig, 1855-1856). (C. F. A.)

**CRIMINAL LAW.** By criminal, or penal, law is now understood the law as to the definition, trial and punishment of crimes, i.e. of acts or omissions forbidden by law which affect injuriously public rights, or constitute a breach of duties due to the whole community. The sovereign is taken to be the person injured by the crime, as he represents the whole community, and prosecutions are in his name. Criminal law includes the rules as to the prevention, the investigation, prosecution and punishment of crime (*q.v.*). It lays down what constitutes a criminal offence, what proof is necessary to establish the fact of a criminal offence and the culpability of the offender, what excuse or justification for the act or omission can be legally admitted, what procedure should be followed in a criminal court, what degrees and kinds of punishment should be imposed for the various offences which come up for trial. Finally, it regulates the constitution of the tribunals established for the trial of offences according to the gravity of the infraction of law, and deals with the organization of the police and the proper management of prisons, and the maintenance of prison discipline. (See EVIDENCE; PRISON; POLICE.)

Many acts or omissions, which are technically criminal and classified as offences and punished by fine or imprisonment, cannot be said to have a strictly criminal character, since they do not fall within the popular conception of crime. To this class belong such matters as stopping up a highway under claim of right, or failing to repair it, or allowing a chimney to emit black smoke in excessive quantities, or to catch fire from being unswep, or breach of building by-laws, or driving a motor car on a highway at a speed in excess of the legal limit. Such breaches of law are under the French law described as *contraventions*. In England most of them are described as petty misdemeanours or offences punishable on summary conviction, or less happily as "summary offences," and some writers speak of them as *mala prohibita* as distinguished from *mala in se*, i.e. as not involving any breach of ordinary morality other than a breach of positive regulations. Continental jurists at times speak of crimes *de droit commun* (i.e. offences common to all systems of law as distinguished from offences which are crimes only by a particular municipal law). To this class of crimes *de droit commun* belong most of the offences included in extradition treaties.

Criminal and civil law overlap, and many acts or omissions are not only "wrongs" for which the person injured is entitled to recover compensation for his own personal injury or damage, but also "offences" for which the offender may be prosecuted and punished in the interest of the state. In non-English European systems care is taken to prevent civil remedies from being extinguished by punishment: it is quite usual for the civil and criminal remedies to be pursued concurrently, the

individual appearing as *partie civile* and receiving an award of compensation by the judgment which determines the punishment to be inflicted for the offence against the state. Under English law it is now exceptional to allow civil and criminal remedies to be pursued concurrently or in the same proceeding, or to award compensation to the injured party in criminal proceedings, and he is usually left to seek his remedy by action. Among the exceptions are the restitution of stolen goods on conviction of the thief if the prosecution has been at the instance or with the aid of the owner of the goods (Larceny Act 1861, § 100), and the award of compensation to persons who have suffered injury to property by felony (Forfeiture Act 1870).

As Sir Henry Maine says (*Ancient Law*, ed. 1906, p. 381), "All civilized systems of law agree in drawing a distinction between offences against the state or community (crimes or *crimina*) and offences against the individual (wrongs, *torts* or *delicta*)." But the process of historical development by which this distinction has been ultimately established has given great occasion for study of early laws and institutions by eminent men, whose researches have disclosed the extremely gradual evolution of the modern notion of criminal law enforced by the state from the primitive conceptions and customs of barbarous or semi-civilized communities. Of the oldest codes or digests of customs which are available to the student it has been said the more archaic a code the fuller and minuter is its penal legislation: but this penal legislation is not true criminal law; it is the law, not of crimes, but of wrongs. The intervention of the community or tribe is in the first instance to persuade or compel the wronged person or his family or tribe to abandon private vengeance or a blood feud and to accept compensation for the wrong collectively or individually sustained; and in the tariffs of compensation preserved in early laws the importance of the injured person was the measure of the compensation or vengeance which he was recognized to be entitled to exact, and the scales of punishment or compensation are fixed from this point of view.

The laws of Khammurabi (2285-2242), the oldest extant code, contain definite schemes and scales of offences and punishments, and indicate the existence of tribunals to try the offences and to award the appropriate remedy. The punishments are very severe. It is not distinctly indicated whether the proceedings were at the instance of the state or the person wronged, but compensation and penalty could be awarded in the same proceeding, and the provisions as to the *lex talionis* and scale of compensation for injuries tend to show that the procedure was on private complaint and not on behalf of the state (see further BABYLONIAN LAW). Babylon.

Of the early criminal laws of Greece only fragments survive, e.g. those of Solon and Draco. In Athens in early times crime was dealt with in the Areopagus from the point of view of religion and by the archons from the point of view of compensation: and it was only when the state interests were directly affected that proceedings by way of *εσαγγελια* or impeachment were taken. In classical times crimes fell to be tried by panels of jurors or judges drawn from the assembly and described as *δικαστήρια*. Greece.

The earliest materials for ascertaining the criminal law of Rome are to be found in the Twelve Tables, Table VIII. The criminal law of imperial Rome is collected in books 47 and 48 of the Digest. The classification of crimes therein is capricious and anomalous. "In the early Roman law the idea of legislative power was so fully grasped and that of judicial power so little understood that the criminal jurisdiction arose in the form of a legislative enactment applicable to particular cases." Crimes were classified according to the mode of prosecution into:

1. *Publica judicia*, dealing with crimes specifically forbidden by definite laws, which took the place of the standing commissions (*quaestiones perpetuae*) of the time of the republic. In the earlier stages of Roman law the state only interfered to punish offences which gravely affected it, and did so by *privilegia*, which correspond to impeachment or Bill of Pains and Penalties.

Develop-  
ment of  
modern  
criminal  
law.

Babylon.

Greece.

Rome.

2. *Extraordinaria crimina*, crimes for which no special procedure or punishment was provided: the punishment being, within limits, left to the discretion of the judge and the prosecution to the injured party.

3. *Privata delicta*, offences for which a special form of action was open to the injured party, e.g. *actio furti*.

The multiplicity of tribunals under the republic was replaced under the empire by a complete organisation of the judiciary throughout the districts (dioceses) under the supervision of the emperor in his privy council (see Maine, *Ancient Law*, ed. 1906, p. 393). Public prosecution under the empire began by arrest of the accused, who was taken before an *cirenarcha*, who examined him (by torture in the case of a slave or parricide) and sent him on for trial before the *praeses* of the diocese (*diocesis*). Private prosecution followed, a procedure closely resembling that of civil actions, beginning with *citatio* (summons), followed by *libellus* or accusation, and appointment of a day for hearing. The right of either party to call witnesses was very imperfectly established.

The early laws of the Celtic races are preserved as to Wales in the laws of Hywel Dda, and as to Ireland in the Book of Aicill and other Brehon law tracts, which are professional collections of precedents and formulae made by the hereditary law caste (Brehons), whose business it was "to pass sentence from precedents and commentaries." (See BREHON LAWS.) The development of Celtic law was arrested by the Saxon and Anglo-Norman conquest: but the materials preserved indicate an origin common with that of Germanic law.

The special characteristics of Irish criminal law, if it can be so called, were:—

1. The law was customary and theoretically unchangeable, and no legislative or judicial authority existed to alter or enforce it.

2. All crimes were treated as wrongs, for which compensation was made by assessment of damages by a consensual tribunal whose power to make awards depended on submission of the parties and the ultimate sanction of public opinion or custom. A customary tariff for compensation existed for all offences from wilful murder downwards. No crime was unamendable. The Irish law recognized a body price or compensation (*S. bot*) and an honour price or *eric* (*S. wer*), for which the family or tribe of the offender was collectively liable; but there is no clearly ascertained equivalent to the Saxon *wite*, or fine to the chief.

The laws of the Germanic tribes, so far as preserved in the *Germania* of Tacitus, and in the compilations of customs known as the Salic and Ripuarian laws, the *Leges Barbarorum*, the *Dooms of Æthelberht* and the collections of Anglo-Saxon law and custom (to be found in Thorpe's *Ancient Laws and Institutes of England*), do not indicate any adequate or definite division between crimes and causes of civil action, but, like the laws of Babylon, recognize the system and contain the tariffs of compensation for wrongs. The idea of the compensation was originally to put an end (*finis*) to blood feuds and private war or vengeance.

These laws formed the foundation of the criminal law of Germany, including the Netherlands, of England and of Scandinavia. But in each country the development of criminal law has been affected by influences other than Germanic, mainly consisting in an infusion more or less great of ideas derived from Roman law. In England under Alfred some part of the Levitical law (Exod. xxi. 12-15) was incorporated, just as in 1567 the criminal law as to incest in Scotland was taken bodily from Leviticus xviii.

The stage which the development of criminal law had reached in England by the reign of Edward the Confessor is thus described by Pollock and Maitland (*Hist. Eng. Law*, ii. 447):

"On the eve of the Norman Conquest what we may call the criminal law of England (but it was also the law of torts or civil wrongs) contained four elements which deserve attention: Its past history had in the main consisted of the varying relations between them. We have to speak of outlawry, of the blood feud (*faidus*), of the tariffs of *wer* and *wite*

(*fredus* or *friede*), and *bot*, of punishment in life and limb. As regards the malefactor the community may assume one of four attitudes: it may make war on him; it may have him exposed to the vengeance of those whom he has wronged; it may suffer him to make atonement; it may inflict on him a determinate punishment, death, mutilation or the like." The *wite* or sum paid to the king or lord is now thought to have been originally not a penalty but a fee for time and trouble taken in hearing and determining a controversy. But at an early stage fines for breach of peace were imposed. An evil result from the public point of view followed from the system of atoning for crime by pecuniary mulct. "Criminal jurisdiction became a source of revenue." So early as Canute's time certain crimes were pleas of the crown; but grants of criminal jurisdiction, with the attendant forfeitures, were freely made to prelates, towns and lords of manors, and some traces of this jurisdiction still survive (e.g. the criminal jurisdiction of the justices of the *soke* (*soc*) of Peterborough, and the rights of some boroughs, e.g. Nottingham, to forfeitures). Outlawry soon ceased to be a mode of punishment, and became, as it still is, a process to compel submission to justice (Crown Office Rules, 1906, rules 88-110). Certain crimes, such as murder, rape, arson and burglary, became unamendable or bootless, i.e. placed the offender's life, limb, lands and goods at the king's mercy. These crimes came to be generally described by the name felony (*q.v.*). Other crimes became punishable by fines which took the place of *wites*. These were styled trespasses and correspond to what is now called misdemeanour (*q.v.*).

Minor acts of violence, dishonesty or nuisance, were dealt with in seigniorial and borough courts by presentment of the jurors of courts baron and courts leet, and punished by fine or in some cases by pillory, tumbrel or stocks. Grave acts were dealt with by the sheriff as breaches of the peace. He sat with the freeholders in the county court, which sat twice a year, or in the hundred court, which sat every four weeks. So far as this involved dealing with pleas of the crown the sheriff's jurisdiction was abolished and was ultimately replaced by that of the justices or conservators of the peace. The sheriff then ceased to be a judge in criminal cases, but remained and still is in law responsible for the peace of his county, and is the officer for the execution of the law. The royal control over crime was effectually established by the itinerant justices sent regularly throughout the realm, who not only dealt with the ordinary proprietary and fiscal rights of the crown but also with the graver crimes (treason and felony), and ultimately were commissioned to deal with the less grave offences now classed as indictable misdemeanours. The change resulted from the strengthening of royal authority throughout England, which enabled the crown gradually to enlarge the pleas of the crown and to weaken and finally to supersede the criminal jurisdiction, notably of the sheriff, but also of prelates and lords in ecclesiastical and other manors and franchises. "In the early English laws and constitution there existed a national sovereignty and original criminal jurisdiction, but the ideas of legislative power and crime were very slowly developed." During the 13th century the criminal law was affected by the influence of the church, which introduced into it elements from the Canon and Mosaic laws, and also by the memory of the Roman empire and the renewed study of the Roman law, which enabled lawyers to draw a clearer distinction than had before been recognized between the criminal (*dolus*) and civil (*culpa*) aspect of wrongful acts. The Statute of Treasons (1351) is to a large extent an admixture of Roman with feudal law; and to the same source is probably due the more careful analysis of the mental elements necessary to create criminal responsibility, summed up in the somewhat misleading expression *nemo reus est nisi mens sit rea*.

In the 14th century justices of the peace and quarter sessions were established to deal with offences not sufficiently important for the king's judges, and from that time the course of criminal justice in England has run substantially on the same lines, with the single and temporary interruption caused by the court of star chamber.

Celtic law.

Germanic law.

Anglo-Saxon law.

Anglo-Norman period.



The penal laws of modern states classify crimes somewhat differently, but in the main on the same general principles, dividing them into:—

*Classification of crimes.*  
1. Offences against the external and internal order and security of the state.

2. Offences against the administration of police and against public authority.

3. Acts injurious to the public in general.

4. Offences against the person (life, health, liberty and reputation), and conjugal and parental rights and duties.

5. Offences relating to property and contracts (including theft, fraud, forgery and malicious damage).

The terminology by which crimes are described by reference to their comparative gravity varies considerably. In many continental codes distinctions are drawn between crimes (Ger. *Verbrechen*); Norse *vorbrydelse*; Span. *crimenes*; Ital. *reato*), delicts (Ger. *Vergehen*; Ital. *delitti*; Span. *delitos*), and contraventions (Ital. *contravvenzioni*; Span. *faltas*).

The classification adopted by English law is peculiar to itself, "treason," "felony" and "misdemeanour," with a tentative fourth class described as "summary offences." The particular distinctions between these three classes are dealt with under the titles TREASON; FELONY; MISDEMEANOUR, &c. Here it is enough to say that the distinction is a result of history and is marked for abolition and reclassification. Treason and most felonies and some misdemeanours would under foreign codes fall under the head of crime. Misdemeanour, roughly but not exactly, corresponds to the French *délit*, and summary offence to *contravention*.

*Elements of criminal responsibility.* In all systems of criminal law it is found necessary to determine the criterion of criminal responsibility, the mental elements of crime, the degrees of criminality and the point at which the line is to be drawn between intention and commission.

The full definition of every crime contains expressly or by implication a proposition as to a state of mind, and in all systems of criminal law, competent age, sanity and some degree of freedom from coercion, are assumed to be essential to criminality; and it is also generally recognized that an act does not fall within the sanction of the criminal law if done by pure accident or in an honest and reasonable belief in circumstances which if true would make it innocent; e.g. when a married person marries again in the honest and reasonable but mistaken belief that the former spouse is dead. Honest and reasonable mistake of fact stands on the same footing as absence of the reasoning faculty, as in infants, or perversion of that faculty, as in lunatics.

Besides the elements essential to constitute crime generally, particular mental elements, which may differ widely, are involved in the definition of particular crimes; and in the case of statutory offences adequately and carefully defined, the mental elements necessary to constitute the crime may be limited by the definition so as to make the prohibition of the law against a particular act absolute for all persons who are not infants or lunatics. As a general rule of English law, it is enough to prove that the acts alleged to constitute a crime were done by the accused, and to leave him to rebut the presumption that he intended the natural consequences of the acts by showing facts justifying or excusing him or otherwise making him not liable. Children are conclusively presumed to be incapable of crime up to seven years of age; and from seven to fourteen the presumption is against the capacity, but is not absolute.

Under the common law, insanity was an absolute answer to an accusation of crime. Since 1883, where insanity is proved to have existed at the date of the commission of the incriminated acts, the accused is found guilty of the acts but insane when he did them, and is relegated to a criminal lunatic asylum. There was also at common law a presumption that a married woman committing certain crimes in the presence of her husband did so under his coercion. But under modern decisions and practice the presumption has become feeble almost to inanition (*R. v. Mary Baines*, 1900, 69 L.J. Q.B. 681). Distinctions are also drawn between degrees of guilt or complicity.

English criminal law punishes attempts to commit crime if the attempt passes from the stage of resolution or intention to the stage of action, when the completion of the full offence is frustrated by something other than the will of the accused. Except in the case of attempt to commit murder, which is a felony, attempts to commit a crime are punished as misdemeanours. It also punishes the solicitation or incitement of others to commit crime, as a separate offence if the incitement fails, as the offence of being accessory before the fact or abettor if the offence is committed as a result of the incitement; and it punishes persons who, after a more serious crime—felony—has been committed, do any act to shield the offender from justice. In the case of the crimes described as felonies the law distinguishes between principals in the first or second degree and accessories before or after the fact. In the case of misdemeanours the same punishment is incurred by the principal offenders, and by persons who are present aiding and abetting the commission of the offence, or who, though not present, counselled or procured the commission of the offence (see ACCESSORY). Besides these degrees of crime there is one almost peculiar to English law known as conspiracy, i.e. an agreement to commit crime or to do illegal acts (including interference with the due course of justice), which is punishable even if the conspiracy does not get beyond the stage of agreement. The exact nature of this form of crime and the propriety of abolishing it or limiting its scope have been the subject of much controversy, especially with reference to combinations by trade unions.

The English law does not, but most European laws do, allow the jury to reduce the penalty of an offence by finding in their verdict that the commission of the offence was attended by extenuating circumstances; but when the jury recommend to mercy a person whom they find guilty the judge may give effect to the recommendation or report it to the Home Office.

In systems of criminal law derived from England the forms of crime or degrees of complicity above stated reappear with or without modification, but as to conspiracy with a good deal of alteration. In the Indian penal code, for instance, conspiracy is limited to cases of treason (§ 121 A), and when it goes beyond agreement in the case of other offences it is merely a form of abetment or participation (§ 107).

The criminal law of England<sup>1</sup> is not codified, but is composed of a large number of enactments resting on a basis of common law. A very large part is reduced to writing in statutes. The unwritten portion of the law includes (1) principles relating to the excuse or justification of acts or omissions which are *prima facie* criminal, (2) the definitions of many offences, e.g. murder, assault, theft, forgery, perjury, libel, riot, (3) parts of the law relating to procedure. The law is very rich in principles and rules embodied in judicial decisions and is extremely detailed and explicit, leaving to the judges very little latitude of interpretation or expression. So far as the legislature is concerned there is an absence of systematic arrangement. The definitions of particular crimes are still to be sought in the common law and the decisions of the judges. The Consolidation Acts of 1861 for the most part leave definitions as they stood, e.g. the Larceny Act 1861 does not define the crime of larceny. The consequence is that exact definitions are very difficult to frame, and the technical view of a crime sometimes includes more, sometimes less, than it ought. Thus the crime of murder, as settled by the existing law, would include offences of such very different moral gravity as killing

<sup>1</sup> "It is founded," said Sir J. Fitzjames Stephen, writing in 1863, "on a set of loose definitions and descriptions of crimes, the most important of which are as old as Bracton. Upon this foundation there was built, principally in the course of the 18th century, an entire and irregular superstructure of acts of parliament, the enactments of which were for the most part intended to supply the deficiencies of the original system. These acts have been re-enacted twice over in the present generation—once between 1826 and 1832 and once in 1861; besides which they were all amended in 1837. Finally, every part of the whole system has been made the subject of judicial comments and constructions occasioned by particular cases, the great mass of which have arisen within the last fifty years." (*View of the Criminal Law of England*, by J. Fitzjames Stephen.)

a man deliberately for the sake of robbing him, and killing a man accidentally in an attempt to rob him. On the other hand, offences which ought to have been criminal were constantly declared by the judges not to fall within the definition of the particular crimes alleged, and the legislature has constantly had to fill up the *lacunae* in the law as interpreted by the judges.

The jurisdiction to deal with crime is primarily territorial, and can be exercised only as to acts done within the territory

*Juris-*  
*dictio.*

or territorial waters, or on the ships of the law-giver. *Extra territorium jus dicenti impune non paretur.* No state will enforce the penal laws of another nor permit

the officer of another state to execute its laws outside its own territory. But international law recognizes the competence of a state to make its criminal law binding on its own subjects wherever they are, and perhaps even to punish foreigners who outside its territory do acts which menace its internal or external security, e.g. by dynamite plots or falsification of coin. Apart from extradition arrangements the national law cannot reach such persons, be they citizens or aliens, until they come within the territory of the state whose law has been broken.

The codes of France, Germany and Italy make the penal law national or personal and not territorial. In some British colonies whose legislatures have a derived and limited legislative authority, indirect methods have been taken to deal within the colony with persons who commit offences outside its territory.

Throughout the development of the English criminal law it showed and retains one particular characteristic that crime was treated as local, which means not merely that the common law of England was limited to English soil, but that an offence on English soil could be "inquired of, dealt with, tried, determined and punished" only in the particular territorial division of England in which it was committed, which was and is known as the *venue* (*q.v.*). Each township was responsible for crimes within its boundaries, a responsibility made effective by the "view of frankpledge," now obsolete, and the guilt or innocence of every man had to be determined by his neighbours. This rule excluded from trial by the courts of common law, treasons, &c. committed by Englishmen abroad and piracy; and it was not till Henry VIII.'s reign (1536, 1544) that the common-law mode of trial was extended to these offences. The legislature has altered the common law as to numerous offences, but on no settled plan, and except for a bill introduced about 1888, at the instance of the 3rd marquess of Salisbury, no attempt has been made to make the English criminal law apply generally to subjects when outside the realm; and in view of the complicated nature of the British empire and the absence of a common criminal code it has been found desirable to remain content with extradition in the case of crimes abroad, and with the provisions of the Fugitive Offenders Act 1881 in the case of criminals who flee from one part to another of the empire.

The localization in England of crime, and the procedure for punishing it, differ largely from the view taken in France and most European countries. The French theory is that a Frenchman owes allegiance to the French state, and commits a breach of that allegiance whenever he commits a crime against French law, even although he is not at the time within French territory. In modern days this theory has been extended so as to allow French and German courts to punish their subjects for crimes committed in foreign countries, and by reason of this power certain countries refuse to extradite their subjects who have committed crimes in other states.

The principle of the French law, though not expressly recognized in England, must be invoked to justify two departures

*Offences*  
*on the*  
*high seas.*

from the English principle—(1) as regards offences on the high seas, and (2) as regards certain offences committed outside the United Kingdom. In early

days offences committed by Englishmen on the high seas were punished by the lord high admiral, and he encroached so much on the ordinary courts as to render it necessary to pass an act in Richard II.'s reign (15 Rich. II. st. 2, c. 3) to restrain him.

In the time of Henry VIII. (1536, 28 Hen. VIII. c. 19) an act was passed stating that, as the admiral tried persons according to the course of civil law, they could not be convicted unless either they confessed or they or the witnesses were submitted to torture, and that therefore it was expedient to try the offences according to the course of the common law. Under that act a special commission of oyer and terminer was issued to try these offences at the Old Bailey, and English law was satisfied by permitting the indictment to state that the offence was committed on board a ship on the high seas, to wit in the county of Middlesex. Since 1861 these special commissions have been rendered unnecessary by the provision (contained in each of the Criminal Law Consolidation Acts of that year) that all offences committed on the high seas may be tried as if they had been committed in England. As regards offences on land, it was found necessary as early as the reign of Henry VIII. (1544) to provide for the trial in England of treasons and murders committed on land outside England. This was largely due to the constant presence in France of the king and many of his nobles and knights, but the aid of this statute had to be invoked in 1903 in the case of Lynch, tried for treason in South Africa. The latest legislation on the subject was in 1861 (Offences against the Person Act, § 9), and any murder or manslaughter committed on land out of the United Kingdom, whether within the king's dominions or without, and whether the person killed were a subject of His Majesty or not, may be dealt with in all respects as if it were committed in England.

*Offences*  
*committed*  
*on land*  
*outside*  
*England.*

The jurisdiction has been extended to a few other cases such as slave trade, bigamy, perjury, committed with reference to proceedings in an English court, and offences connected with explosives. But these offences must be committed on land and not on board a foreign ship, because if a man takes service on board a foreign ship he is treated for the time as being a member of the foreign state to which that ship belongs. The principle has been also extended to misdemeanours (but not to felonies) committed by public officers out of Great Britain, whether within or without the British dominions. Thus a governor or an inferior officer of a colony, if appointed by the British government, may be prosecuted for any misdemeanour committed by him by virtue of his office in the colony; and cases have occurred where governors have been so prosecuted, such as that of General Picton at the beginning of the 19th century, and of Governor Eyre of Jamaica in 1865, and the attempt to prosecute Governor MacCallum of Natal in 1906. As a corollary to the system of "capitulations" applied to certain non-Christian states in Asia and Africa; it has been necessary to take powers for punishing under English law offences by British subjects in those states, which would otherwise go unpunished either by the law of the land where the offence was committed or by the law of the state to which the offender belonged (Jenkyns, *Foreign Jurisdiction of the Crown*).

*Misdemeanours*  
*committed*  
*by public*  
*officers in*  
*colonies.*

An essential part of the criminal law is the punishment or sanction by which the state seeks to prevent or avenge offences. See also under CRIMINOLOGY. Here it is enough to say that during the 19th century great changes have been made throughout the world in the modes of punishing crime.

*Punish-*  
*ment.*

In England until early in the 19th century, punishments for crime were ferocious. The severity of the law was tempered by the rule as to benefit of clergy and by the rigid adherence of the judges (*in favorem vitae*) to the rules of correct pleading and proof, whereby the slightest error on the part of the prosecution led to an acquittal. Bentham pointed out that certainty of punishment was more effective than severity, that severe punishments induced juries to acquit criminals, and that thus the certainty of punishment was diminished. But his arguments and the eloquence of Sir Samuel Romilly produced no effect until after the reform of parliament in 1832, shortly after which statutes were passed abolishing the death sentence for all felonies where benefit of clergy existed. The severity of capital sentences had already been modified by the pardoning power of the crown;

which pardoned convicts under sentence of death on their consenting to be transported to convict settlements in the colonies. (See DEPORTATION.) For some years this was only done by the consent of the convict, who agreed to be transported if his death sentence was remitted, but in 1824, when a convict refused to give this consent, parliament authorized the crown to substitute transportation for a death sentence, and the same course was adopted in Ireland in 1851 when some treason-felony prisoners refused commutation of their sentence to transportation.

The punishments now in use under the English law for indictable offences are:—

1. Death, inflicted by hanging, with a provision that other modes of execution may be authorized by royal warrant in cases of high treason.

2. Penal servitude, which in 1853 was substituted for transportation to penal settlements outside the United Kingdom. The minimum term of penal servitude is three years (Penal Servitude Act 1891), and the sentence is carried out in a convict prison, in the United Kingdom, but there is still power to send the convicts out of the United Kingdom.

3. Imprisonment in a local prison, which must be without hard labour unless a statute specially authorizes a sentence of hard labour. At common law there is no limit to a term of imprisonment for misdemeanour; but for many offences (both felonies and misdemeanours) the term is limited by statute to two years, and in practice this limit is not exceeded for any offence. The treatment of prisoners is regulated by the prison acts and rules.

4. Police supervision, on conviction or indictment of felony and certain misdemeanours after a previous conviction of such offences. Prevention of Crimes Act, c. 112, §§ 8, 20.

5. Pecuniary fine, a punishment appropriate only to misdemeanours and never imposed for a felony except under statutory authority, e.g. manslaughter (Offences against the Person Act, § 5). The amount of the fine is in the discretion of the judge, subject to the directions of Magna Carta and the Bill of Rights and of any statute limiting the maximum for a particular offence.

6. Whipping was a common law punishment for misdemeanours of either sex. Under the present law the whipping of females is prohibited, and the punishment is not inflicted on males except under statutory authority, which is given in the case of certain assaults on the sovereign, of certain forms of robbery with violence or assaults with intent to commit felony (Garrotters Act 1863), of incorrigible rogues, larceny and malicious damage, and certain other offences by youthful offenders.

7. Recognizances (caution) to keep peace and be of good behaviour, i.e. a bond with or without sureties creating a debt to the crown not enforceable unless the conditions as to conduct therein made are broken. This bond may be taken from any misdemeanant, and, under statutory authority, from persons convicted of any felony (except murder) falling within the Criminal Law Consolidation Acts of 1861.

8. In the case of any offence which is not capital the court, if it is a first offence or if any other grounds for mercy appear, may simply bind the offender over to come up for judgment when required, intimating to him that if his conduct is good no further steps will be taken to punish him.

Except in the case of the death penalty, the court of trial has a discretion as to the *quantum* of a particular punishment, no minimum being fixed. In the case of offences punishable on summary conviction the maximum punishment is always fixed by statute. It consists of imprisonment with or without hard labour, or a fine of a limited amount, or both. The imprisonment in very few cases may exceed six months. If the maximum exceeds three months the accused must be informed that he has a right, if he so elects, to be tried by a jury.

Where power is given to deal summarily with offences which under ordinary circumstances would be tried on indictment, the punishments are as follows (Summary Jurisdiction Act 1879):—

(a) In the case of adults pleading guilty, imprisonment not exceeding six months without the option of a fine.

(b) In the case of adults (consenting to be summarily tried), where the offence affects property not worth over forty shillings, imprisonment not over three months, or fine not exceeding £20.

(c) In the case of young persons, between twelve and sixteen years, imprisonment not over three months, or fine not exceeding £10.

(d) In the case of children under twelve, imprisonment not over one month, or fine not exceeding forty shillings.

If the offence is trifling, the accused may be discharged without punishment, and under the First Offenders Act (1887) the justices have a discretionary power to forgo punishment. The justices have also the power, under the Prevention of Crime Act 1908, in lieu of passing a sentence of penal servitude or imprisonment, to commit persons between the ages of sixteen and twenty-one to a Borstal institution, for a period of detention ranging from one to three years (see JUVENILE OFFENDERS).

In the criminal law of Europe the scale of punishments is on similar lines in most states, and is more elaborate than that of England, and less is left to the discretion of the court of trial. The following examples will indicate the kind of punishments awarded under the French penal code. Punishments are classified as (1) *afflictives et infamantes*, including death, *travaux forcés à perpétuité ou à temps*, *déportation*, *détention*, *reclusion*; (2) *infamantes*, viz. banishment and civil degradation; (3) *peines en matière correctionnelle*, viz. imprisonment in a house of correction (six days to five years), interdiction from certain civic rights, and fine. The punishments in no case have any effect to extinguish the civil claims of individuals who have suffered by the offence (arts. 6 and 55). Special provisions are made for *récidivistes*, police supervision and first offenders (*Loi Béranger*).

In the German code of 1872 the legal punishments are: (1) death; (2) penal servitude for life or for a term not exceeding fifteen years nor less than one year; (3) imprisonment with labour for a term not exceeding five years nor less than one day; (4) confinement in a fortress (terms same as for penal servitude but involving only withdrawal of freedom and supervision); (5) arrest for not more than six weeks nor less than one day; (6) fine (not less than three marks in the case of crimes or delicts nor one mark in case of petty offences). Sentence of imprisonment is in certain cases followed by liability to be placed under police supervision for a term after release. In the case of a sentence of death or of penal servitude, the court may order forfeiture of civil privileges, and a condemnation to penal servitude permanently disqualifies for service in the army and public office (Code pt. 1, chap. 1, arts. 13-40).

Under the Italian code of 1889 (arts. 11-30) the punishments are (1) *ergastolo* (for life); (2) *reclusione* (from three days to twenty-four years), which involves hard labour and cellular confinement; (3) *detenzione* (like term), which involves labour and at night separate confinement; (4) *confino* (one month to three years), a form of banishment from the commune of origin or residence of the offender; (5a) fine (*multa*), from ten to ten thousand lire; (5b) *amende*, from one to two thousand lire; (6) arrest (one day to two years); (7) interdiction from public office; (8) suspension from professional calling. Punishments (5b), (6) and (8) are applied only to contraventions, the others to crimes (*delitti*).

The Spanish law (*Código Penal*, title 3, chaps. 2 and 3) contains a general scale of punishments classified as afflictive, correctional, light and accessory. The first class begins with death and runs down through many forms of imprisonment to disqualification (*inhabilitacion*). The second includes forms of imprisonment, (*presidio* and *prisión*), and arrest, public censure and suspension from the exercise of certain offices or callings. The slight punishments are minor arrest and private censure. Offenders in any of the three classes may also be fined or put under recognizance (*caución*). The accessory punishments include payment of costs, degradation, civil interdiction.

In England indictable offences (i.e. offences which must be tried by a judge and jury) are thus dealt with:—

1. Courts of assize (sitting under old commissions known as

commissions of assize, oyer and terminer, and general gaol delivery) are held twice or oftener in every year in each county and also in some large cities and boroughs. They are the lineal successors of the justices *in eyre*<sup>1</sup> of the middle ages; but they are now integral parts of the High Court of Justice. These courts can try any indictable offence presented by a grand jury for the district in which they sit.

2. For the counties of London and Middlesex and certain adjoining districts, a special court of assize known as the central criminal court sits monthly.

3. In all counties and many boroughs the justices of the peace sit quarterly or oftener under the commission of the peace to try the minor indictable offences. (See QUARTER SESSIONS, COURT OF.)

4. The High Court of Justice in the king's bench division tries a few special offences in its original jurisdiction, and where justice requires may transfer indictments from other courts for trial before itself.

5. The court of criminal appeal has been instituted by the Criminal Appeal Act 1907; to it all persons convicted on indictment have a right of appeal. (See APPEAL.)

The substantive law as to crime applies in England to all persons except the reigning sovereign, and criminal procedure is the same for all subjects alike, except in the case of peers or peeresses charged with felony, who have the right of trial by their peers in the House of Lords if it be sitting, or in the court of the lord high steward.

There are in England no courts of a special character, such as exist in some foreign countries, for the determination of disputes between the governing classes themselves or with the governed classes, whether of a civil or criminal character. There are a few exceptional courts with criminal jurisdiction. The court of chivalry, which used to punish offences committed within military lines outside the kingdom, is obsolete. Special tribunals exist for trying naval or military offences committed by members of the navy and army, but those members are not exempt from being tried by the ordinary tribunals for offences against the ordinary law, as though they were civilians. The naval courts can be held only on board a ship, and can as a general rule try only persons entered on the books of a king's ship. The military courts can only try persons who are actually members of the army at the time, and their authority is annually renewed by parliament, in consequence of the jealousy still felt against the trial of any man except by the ordinary courts of law. Military and naval courts can try in any part of the world, and whenever the forces are in active service can try followers of the camp as if they were actual members of the forces. (See MILITARY LAW; MARTIAL LAW.)

The ecclesiastical courts, which were formerly very powerful in England, and punished persons for various offences, such as perjury, swearing, and sexual offences, have now almost fallen into disuse. Their authority over Protestant dissenters from the established church was taken away by statute; their authority over lay members of the Church of England has disappeared by disuse. Occasionally suits are instituted in them against the clergy for offences either against morality or against doctrine or ritual. In these cases their sentences are enforced by penalties, such as suspension, or deprivation of benefice, or by imprisonment, which has replaced the old punishment of excommunication.

A system of procedure, with the judicial machinery required to work it, may be created either by the direct legislative action of the supreme power or by custom and the action of the courts. Both at Rome and in England it was through usage and by the courts themselves that the earlier system was slowly moulded: both at Rome and in England it was direct legislation that established the later system. (See Bryce, *Studies in History and Jurisprudence*, 1901, ii. 334.)

The characteristics of English criminal procedure which most

<sup>1</sup> i.e. Itinerant justices. From the Latin *in itinere*, on a journey.

distinguish it from the procedure of other countries are as follows:—

1. It is litigious or accusatory and not inquisitorial (Stephen, *Prel. View Cr. Law*). It is for the prosecutor to prove by evidence the commission of the alleged offence. No power exists to interrogate the accused unless he consents to be sworn as a witness in his own defence, which since 1898 he may do. The right to cross-examine him even when he is so sworn is limited by law, with the object of excluding inquiry into his past character or into past offences not relevant to the particular charge on which he is being tried.

2. The forms of criminal pleading still in use are in substance framed on the lines of the old system of pleading at common law in civil cases, which was swept away by the judicature acts. Criminal pleadings have, however, one peculiarity. Indictments, being in form the presentment of a grand jury, could not be amended until provision for that purpose was made in 1851. (See INDICTMENT.)

3. Criminal prosecutions are ordinarily undertaken by the individuals who have suffered by a crime. There is not in England, as in Scotland and all European countries, a public department concerned to deal with all prosecutions for crime. The result is that the prosecution of most ordinary crime is left to individual enterprise or the action of the local police force or the justices' clerk.

The attorney-general has always represented the crown in criminal matters, and in state prosecutions appears in person on behalf of the crown, and when he so appears has certain privileges as respects the reply to the prisoner's defence and the mode of trial. In the Prosecution of Offences Acts of 1879, 1884 and 1908 there is to be found the nucleus of a system of public prosecution such as obtains in other countries in case of crime. Under these acts the director of public prosecutions (up to 1908 an office conjoint with that of solicitor to the Treasury) acts under the attorney-general; but unless specially directed he only undertakes a limited number of prosecutions, e.g. for murder, coining and serious crimes affecting the government.

4. Where an indictable offence is supposed to have been committed the accused is arrested, with or without the warrant of a justice, according to the nature of the offence, or is summoned by a justice before him. On his appearance a preliminary inquiry is held for the purpose of ascertaining whether there is a prima facie case against him. The procedure is regulated by the Indictable Offences Act 1848, and is entirely different from the procedure for summary offences. It may be, though usually it is not, held in private; it is an inquiry and not a trial; the justices have to consider not whether the man is guilty, but whether there is such a prima facie case against him that he ought to be tried. If they think that there is, they commit him to prison to wait his trial, or require him to give security, with or without sureties, to the amount named by them, for appearing to take his trial. If they think the charge unsubstantial they discharge the accused at once. The prosecutor in cases of felony may if he likes go before the grand jury whether the case has or has not been the subject of a preliminary inquiry, but in the case of many misdemeanours it is obligatory first to have a preliminary inquiry, as a protection against vexatious indictments.

Whether there has or has not been a preliminary inquiry before a magistrate, no person can be tried for any of the graver crimes, treason or felony, except upon indictment found by a grand jury of the county or place where the offence is said to have been committed or is by statute made cognizable. In olden days, and even now in theory, the grand jury inquire of their own knowledge, by the oath of good and lawful men of the neighbourhood, into the crime of the county, but in practice the charges against the accused persons are always first submitted to the proper officer of the court. The grand jurors are instructed as to their inquisition by a charge from the judge, as regards the indictments concerning which they are called upon to enquire whether there is a prima facie case to send them for trial to the petty jury. The

*The grand jury.*

grand jury must consist of not less than twelve, nor more than twenty-three, good and lawful men of the county. But any person who prefers an indictment is entitled to have it presented to the grand jury. Officers of the court lay the indictments before the grand jury. The charges are then called bills, and if the grand jury considers that there is no prima facie case the foreman endorses the bill with the words "no true bill," and it is then presented to the judge. The jury are then said to have ignored the bill, and if the person charged is in custody he is released, but is liable to be indicted again on better evidence.

As a means of constitutional protection in times of monarchical aggression this practice had no doubt a great value, but in the present day, when few offenders are tried without a preliminary inquiry by justices, the functions of a grand jury are of secondary importance, and the jurors' time is perhaps needlessly occupied. The institution of the grand jury prevented the crown in the days of its great power from removing a person whom it wished to get rid of from among his neighbours, and placing him on trial in a strange place where the influence of the crown was greater. This is still true to a certain extent, as great injustice may be caused to a man by removing him from his neighbours and trying him at a distance from his friends, and from the witnesses whom he might call for his defence. In Ireland, for instance, the greatest injustice might be done by removing an Orangeman from Belfast and trying him in a Roman Catholic county or vice versa. But it has its evils where the area from which the jurors are drawn is small, such as a town of a few thousand inhabitants. In that case a man charged, say, with fraud, may be protected by his friends from being properly punished for that fraud. But where justice requires, an order may be made for the trial of the offence in another county or at the central criminal court.

In many colonies the Scottish system has been adopted, by which the ordinary form of accusation is by indictment framed by the public prosecutor, and a grand jury is only impanelled in cases where an individual claims to prosecute an offence as to which the public officials decline to proceed. In England criminal informations by the attorney-general, or by leave of the court without the intervention of a grand jury, are permitted in cases of misdemeanour, but are now rarely preferred.

If a coroner's jury, on inquiring into any sudden death, finds that murder or manslaughter has been committed, that finding has the same effect as an indictment by a grand jury, and the man charged may be tried by the petty jury accordingly. The law and procedure of the coroner's courts are now regulated by the Coroners Act 1887. When there is a dead body of a person lying within the area of his jurisdiction, and there is reasonable cause to suspect that such person died a violent or unnatural death, or a sudden death of which the cause is unknown, or has died in prison, the coroner is entitled to hold an inquest, and if the verdict or inquisition finds murder or manslaughter, it is followed by trial in the same way as if the person accused had been indicted.

When an indictment is found by the grand jury (twelve at least must concur) the person charged is brought before the court, the indictment is read to him, he is asked whether he is guilty or not guilty. If he pleads guilty he is then sentenced by the court; if he pleads not guilty, a petty jury of twelve is formed from the panel or list of jurors who have been summoned by the sheriff to attend the court. He is tried by these jurors in open court. The common law method of trial of crimes by a jury of twelve, native to English law, has been in modern times transplanted to European countries. It was not the original form of trial, for it was preceded by wager of battle (which was not finally abolished till 1819); and by ordeal, which was suppressed as to criminal trials in 1219 in consequence of the decree of the Lateran Council (1216). The first was allowed only on an appeal by an individual accuser; the second was resorted to on an accusation by public fame, which the accused was allowed to meet by submitting to the ordeal. It was after 1219 that trial by the jury of twelve (known

as trial in pais) began to develop. At the outset the accused used to be asked how he would be tried, and could not be directly compelled to plead to the charge or to accept trial by a jury; which led to the indirect pressure known as the *peine forte et dure*, which fell into disuse after the Revolution and was formally abolished in 1772. But it was not until 1827 that refusal to plead was treated as a plea of not guilty, entailing a trial by a jury, and some old-fashioned officials still ask the old question "How will you be tried?" to which the old answer was "By God and my country."

The original trial jury or inquest certainly acted on its own knowledge or inquiries without necessarily having evidence laid before it in court. The impartiality of the jurors was to some extent secured by the power of challenge. The exact time when the jury came into its present position is difficult accurately to define. On the trial before the petty jury the procedure and the rules of evidence differ in very few points from an ordinary civil case. The proceedings as already stated are accusatory. The prosecutor must begin to prove his case. Confessions (which are the object sought by French procedure) are regarded with some suspicion, and admissions alleged to have been made by the accused are not admitted unless it is clear that they were not extracted by inducements of a temporal nature held out by persons in authority over him. During the spring assizes of 1877 a prisoner was charged with having committed a murder twenty years before, and the counsel for the prosecution, with the consent of the judge, withdrew from the case because the only evidence, besides the prisoner's own confession, was that of persons who either had never known him personally or could not identify him. The accused may not be interrogated by the judge or the prosecuting counsel unless he consents to be sworn as a witness. In this respect the contrast between a criminal trial in England and a criminal trial in France is very striking. The interrogation and browbeating of the prisoner by the judge, consistent as it may be with the inquisitorial theory of their procedure, is strange to English lawyers, accustomed to see in every criminal trial a fair fight between the prisoner and the prosecution, and not a contest between the judge and the prisoner. The accused may, if he choose, be defended by counsel, and if poor may get legal aid at the public expense if the court certify for it. He is entitled to cross-examine the witnesses for the prosecution and to call witnesses in his defence. At the conclusion of the evidence and speeches the judge sums up to the jury both as to the facts and the law, and the jury by their verdict acquit or convict. Immediate discharge follows on acquittal; sentence by the judge on conviction.

Justices of the peace may under many statutes convict in a summary manner (without the intervention of a jury) for offences of minor importance. The procedure for punishing summary offences is before two justices, or a stipendiary magistrate. This proceeding must not be confused with the preliminary inquiry already mentioned before justices for an indictable offence, nor with the procedure before justices in relation to civil matters, such as the recovery of small sums of money. The proceeding begins either by the issue of a warrant for the arrest of the person charged, in which case a sworn information must be filed, or by a summons directing the person charged to appear on a certain day to answer the complaint made by the prosecutor. The justices hear the case in open court; the person charged can make his defence either in person or by his solicitor or counsel, he can cross-examine the witnesses for the prosecution, call his own witnesses, and address the justices in his defence. The justices, after hearing the case, either acquit or convict him, and in case of conviction award the sentence. If the sentence is a fine, and the fine is not paid, the person convicted is liable to be imprisoned for the term fixed by the justices, not exceeding a scale fixed by an act of 1879, the maximum of which is one month. The imprisonment may be with or without hard labour.

Of late years this summary jurisdiction of the justices has received very large extensions, and many offences which were

Coroner's courts.

Trial by jury.

Summary trials.

Procedure for summary offences.



formerly prosecuted as serious offences by an indictment before the court of assize or quarter sessions have, where the offence was a trivial one, been made punishable, on summary proceedings before justices, by a small fine or a short term of imprisonment.

The extension of the jurisdiction of the justices is open to the observation that it deprives a person charged of the protection of a jury, and also that it throws upon him, if convicted, and upon the prosecution if there is no conviction, the cost of the proceedings. The former objection is much mitigated by the enactment made in 1879, that a person liable on conviction to be sentenced to imprisonment for more than three months, or to a fine exceeding £100, can claim to be tried by a jury. But the objection as to the costs remains, and the payment of costs is often a very serious addition to the trivial fine; and it is anomalous that a person convicted of a trifling offence should bear the cost of the prosecution, while if he is convicted before a superior tribunal of the most serious offence he does not pay the costs.

In English law until 1907, where a criminal case had been tried by a jury the verdict of the jury of guilt or innocence was final and there was no appeal on the facts. Any considerable defect or informality in the procedure might be the subject of a writ of error. And if any question of law arose at the trial, the judge might, if he chose, reserve it for the opinion of the court for the consideration of crown cases reserved, by whom the conviction might be either quashed or confirmed.

By the Criminal Appeal Act 1907, a new court was established, to which any person convicted on indictment might appeal. (See APPEAL.)

The expenses of prosecution for crime in England are dealt with in the following manner. Prosecutions for high treason and the cognate offence known as treason-felony are at the expense of the state, which alone undertakes such prosecutions. In the case of all other felonies and of many misdemeanours the expense of the prosecution falls on the local rate. In the case of other misdemeanours the expense falls on the prosecutor. Where an offence is summarily prosecuted the costs are in the discretion of the court, which may order the accused to pay them, if convicted, or the prosecutor to pay on acquittal, or may leave the parties to pay their own expenses. On charges of felony and a few misdemeanours the court may order the accused person to pay the expenses of his prosecution in relief of the local rate. In a few cases, chiefly where the prosecution is vexatious, the court may order the prosecution to pay the expenses of the defence. The expenses of witnesses for the defence in any indictable offence may be paid out of the local rate when they have been called at the preliminary inquiry; and where the court in the case of a poor prisoner has certified that he should have legal aid, the expenses of the defence may be charged to the local rate. The local rate upon which the expenses fall is usually that of the county or borough in which the offence was committed; but sometimes is that of the place where the offence is tried.

Between 1852 and 1888 parliament reimbursed to the local authorities the expense imposed on the local rate. In 1888 the proceeds of certain taxes were set aside and handed over to the local authorities as a set-off to the expense incurred in prosecutions. In one class of case, offences committed in the admiralty jurisdiction, i.e. outside England, the treasury directly reimburses to the local authorities the expense incurred.

Under most, if not all, European codes, the state pays for the prosecution, subject to reimbursement by the accused, if the court so orders.

The English system of criminal procedure is the basis of that of most of the states which form the United States of America, and, with few exceptions, of the procedure throughout the British empire.

The French penal code and code of criminal procedure are substantially the model of all systems of continental criminal law. They were promulgated in 1811 by Napoleon I., and although he called in the aid of the greatest French jurists, he guided, and occasionally even revised, their labours. The French codes have been improved upon by later

European codes, and more especially by the Italian penal code. All European codes have an opening chapter where the general principles of criminal law in its practical application are enunciated, such as, for instance, the rules that—(1) no person is liable to punishment for any act not expressly declared to be an offence; (2) no person can be punished for an act which by virtue of a subsequent law is declared not to be an offence; (3) whoever commits an offence within the kingdom is tried and punished according to the criminal law of the kingdom, and by the tribunals created for the administration of justice, to the exclusion of special tribunals created for temporary purposes. This rule really lays down that no citizen can be deprived of his own judges when he is accused of a criminal offence. (4) A citizen, although he may have been tried in a foreign country for an offence committed within the kingdom, can be retried according to the law of the kingdom. (5) Extradition only applies to foreigners, not to citizens. The preliminary chapter is followed by the classification of offences according to the importance of the punishments the law assigns to them. The lowest degree of offence is denominated "contravention." It applies mainly to the pettiest offences, or to infractions of police regulations, and can be punished by fine or by imprisonment under a week, or by both fine and imprisonment, limited to a week. Next comes the "*délit*," which includes all offences punished by imprisonment over a week and under five years. Then, finally, we arrive at the "*crime*," the highest form of offence in French criminal law. It includes all offences subject to a more severe sentence than the punishment assigned to a *délit*. All cases are held to be crimes where death, life-imprisonment with or without hard labour, deportation out of the kingdom, detention or seclusion in a fortress or other expressly assigned place, are the punishments mentioned by the law. A certain number of explanatory definitions follow, of which the most important concern *attempts* to commit offences, and in "crimes" they are punishable if the execution of the attempt was only prevented by circumstances beyond the will of the offender, whilst in "*délits*" an attempt is not punishable as an offence unless the law specially provides that it should be punished. As regards "contraventions," attempts not carried out are not held to be offences at all. Accomplices are generally subject to the same punishment as the principal. Old offenders (*récidivistes*) are subject to severer punishments. The usual exceptions as regards responsibility for crime, such as madness and extreme youth and *force majeure*, are to be found in all codes. The excuse of youth extends to all offenders under the age of sixteen, when the tribunal decides whether the offender has acted without "discernment," and acquits where the discernment is not found, whilst one-half of the usual punishment is inflicted where discernment is found. Foreign codes differ from the English law in allowing the injured party to claim damages in the criminal suit, appearing as *partie civile*. On another question there is a wide divergence on the continent of Europe from English law. According to the law of England there is no prescription in criminal law (with a few exceptions created by statute). An offender is always liable to punishment whatever time may have elapsed since the committal of the offence. On the continent of Europe the limitation of a judgment and sentence for a crime is twenty years; five years for a *délit*, and for a contravention two years. No proceedings can be taken as regards a crime after a lapse of ten years, whilst as regards a *délit* the limit is three years, and two years for a contravention.

There are three main differences between English criminal procedure and European criminal procedure.

1. A criminal prosecution directed on European criminal procedure at once passes into the hands of the state as an infringement of law which must be repressed, on the ground that the whole community bases its security on obedience to law. In England the repression of all minor crime is left to the injured party.

2. In England every criminal trial from beginning to end is, and has always been, public. Preliminary inquiries into an

indictable offence may be, but rarely if ever are, conducted in private. On the continent of Europe, with rare exceptions, all preliminary proceedings in a criminal charge are secret. Outside English-speaking countries this secret investigation continues more or less. But of the two systems, accusatory or inquisitorial—the first meaning the right of the accused to defend himself, the second meaning the right of the state to examine any legal offence in private in order to ensure the safety of society,—the accusatory is gaining ground in every country. In English-speaking countries it is an established law that an accused person should have the right of publicity of the proceedings and the right to defend himself by counsel and by witnesses. In Europe the inquisitorial system is gradually being abandoned. Perhaps the best code of criminal procedure in Europe is that promulgated in Austria in 1873. It followed a fundamental law of the Empire which laid down *inter alia* that all legal proceedings, civil or criminal, should be oral and public, and that the accusatory system in criminal cases should be adopted. Germany followed this example. Italy, Holland, Switzerland and Spain have followed Austria and Germany as regards the preliminary investigation; Italy and Belgium have surrounded the accused with guarantees against arbitrary confinement before trial; Holland has conferred upon the accused the right of seeing the adverse testimony and of being confronted with the witnesses, and, further, has formally insisted that no insidious questions, such as questions assuming a fact as true which is not known to be true, should be allowed. Other countries still remain on the old lines. But everywhere, whether reform has actually been accomplished or not, there is a demand for even-handed justice, and a growing conviction that the accused should have all his rights, now that society is no longer in danger from undiscovered criminals and unpunished crime. Even in France, the champion of the inquisitorial system, a change is being made. Up to 1897 secrecy was imposed invariably in the preliminary investigation of crime, and was held necessary for the discovery and punishment of the offender. The *Loi de l'instruction contradictoire*, December 8, 1897, however, was a long step towards complete justice in the treatment of the accused in the preliminary inquiry. The main reform is that the accused, after he has once appeared before the judge and a formal charge has been made against him, is entitled to the assistance of counsel, either chosen by himself or assigned to him if he is poor. If he is in prison he is allowed to communicate freely with his counsel, who is entitled to see all the proceedings, and in every appearance before the judge his counsel accompanies him. There are, however, certain limitations. The counsel cannot address the judge without leave, which may be refused, nor can he insist on any proceeding he thinks necessary in his client's interest. He can only solicit. He has no right to be present at the examination of witnesses, who continue to be interrogated by the judge alone and not in the presence of the accused; but he must receive twenty-four hours' notice of every appearance of the accused, and he is entitled to be present whenever his client, after the first formal appearance, comes before the judge. In England, as already pointed out, although the prosecution is in the name of the crown, and although a public prosecutor has been appointed, still as a rule it is conducted by the person injured as the person injured, or by the police.

3. In England the single-judge system is universal, save in appeal; on the continent of Europe plurality of judges is insisted upon, save in the most trivial cases, where the punishment is insignificant. In most countries of the continent of Europe the whole machinery for the prevention, investigation and punishment of crime, is conducted by what is called the *parquet*, which represents society as a collective unit and not the individual injured. The head of the whole *parquet* in France is the *procureur-général*, who holds equal rank with the members of the supreme court. Under him there are *procureurs-généraux* attached to each of the courts of appeal, of which in France there are twenty-six, and under each of these subordinate *procureurs* there are *procureurs* (prosecutors) of a lesser degree. The next stage

to the *parquet* is the *juge d'instruction*, who corresponds to the English magistrate, and is the most formidable personage in the whole system of French criminal law. He can detain and accuse a person in prison, can send for him at any time and ask him such questions as he pleases.

After the first examination the prisoner is entitled, in most European countries, to the assistance of counsel, but the powers of counsel are so limited that the *juge d'instruction* has a complete discretionary power regarding the investigation of the case. The natural consequence of this procedure is that the preliminary investigation really decides the ultimate result, and the final trial becomes more or less a solemn form.

The criminal law of Ireland is to a great extent the same as that of England, resting on the same common law and on statutes which extend to both countries or are in almost the same terms, and is administered by courts of assize Ireland. and quarter sessions, and by justices, as in England. In a few instances statutes passed for England or Great Britain before the Union have not been extended to Ireland, or statutes passed by the Irish parliament before the Union or by the British parliament since the Union create offences not known to English law. In Ireland the system of prosecution is nominally the same as in England, but in practice almost all prosecutions are instituted and conducted under the direction of the attorney-general for Ireland, who is a member of the government of the day, and so responsible to parliament, as in the case of the lord advocate. In Ireland, owing to the police being a centralized force, under the management of commissioners residing in Dublin, any prosecution which in England might be conducted by the local police, would in Ireland be conducted under the direction of the chief of the police in Dublin, who is necessarily in close communication with and under the control of the attorney-general.

In Scotland hardly any crimes are constituted by statute law, the common law being to the effect that if a judge will direct any act to be a crime, and a jury will convict, Scotland. that act is a crime. This great elasticity of the common law to include every sort of new crime which might arise was in times past very dangerous to political liberty, as it greatly enlarged the power of the crown to oppress political opponents, but in modern days it has its convenience in facilitating the punishment of persons committing crimes for the punishment of which in England a new act of parliament may be necessary. Criminal procedure in Scotland is regulated by an act of 1887 which greatly simplified indictments and proceedings. The prosecution of crime is in the hands of public officers, procurators fiscal, under the control of the lord advocate. Private prosecutions are possible, but rare. Except in the case of the law of treason, imported from England at the Union, no grand jury is required, and the indictments are filed by the public officer.

The criminal law of England forms the basis of the criminal law of all British possessions abroad, with a few exceptions, *e.g.* the Channel Islands (still subject to the custom of Other British possessions. Normandy) and the anomalous case of Cyprus, where Mahommedan law is to some extent in force. As to India, see *infra*.

In many British colonies the criminal law has been codified or at the least consolidated. Criminal codes have been passed in Canada, New Zealand (1893), Queensland (1899) and W. Australia (1901). Many crown colonies have codes framed on the model prepared by the late Sir R. S. Wright for Jamaica and revised in 1901, and in British Guiana opportunity was taken (in 1893) to abolish the remnants of Roman-Dutch criminal law.

The criminal law of South Africa, which is based on the Roman-Dutch law, including the *Constitutio Criminalis Carolina* (1532), is not codified. In the Transvaal and Orange River colonies codes of criminal procedure are in force, drawn mainly from the common and statute law of the Cape Colony with the addition of provisions borrowed from English and colonial legislation.

In Mauritius the criminal law is comprised in a penal code of 1838 and a procedure code of 1853, which, with the incorporated amendments, are to be found in the *Revised Laws of Mauritius*

(1903-1904), ii. 466 et seq. The penal code is based on the Code Napoléon.

"Criminal law has everywhere grown out of custom, and has in all civilized states been largely dealt with by direct legislation.

In most civilized states (including Japan) it has been codified by statute, to the general satisfaction of the people; and the conspicuous success of the Indian penal code shows that English criminal law is susceptible of being so treated" (Bryce, *Studies*, ii. 34).

The expediency, if not the necessity, of codifying the criminal law of England has long been apparent. The writings of Bentham drew attention to many of its substantial defects, and the efforts of Romilly and Mackintosh led to certain improvements embodied in what are known as Peel's Acts (1826 to 1832). In 1833, at the instance of Lord Chancellor Brougham, a royal commission was appointed to deal with the criminal law. The nature of the instructions indicate the crudity of the ideas then ruling as to codification. The commissioners were directed to digest into one statute all enactments touching crimes and the punishment thereof, and into another statute the provisions of the common unwritten law touching the same. The commission was renewed in 1836 and 1837, and in 1843 a second commission was appointed. Numerous and voluminous reports were published, including (1848) a bill for consolidating and amending the law as to crimes and punishments, and (1849) a like bill for criminal procedure, indicating that the commissioners had in the meantime learned the distinction between substantive and adjective law. Lord Brougham in 1848 unsuccessfully introduced the first bill, and in the end the only fruit of the reports has been certain amendments of procedure in 1851 and the passing of the seven Criminal Law Consolidation Acts of 1861, which deal with the statute law as to theft, forgery, malicious injuries to property, coinage offences and offences against the person. The reports, however, proved of value in the revision of Macaulay's draft of the Indian penal code, and led to the formation of the Statute Law Committee, which has relieved the statute book of much dead matter. On his return from India, impressed by the success of the Indian penal code, Sir J. Stephen made a strong effort to obtain codification. In 1878, at the instance of Lord Cairns, he prepared a draft code (based on his well-known *Digest of the Criminal Law*), which was laid before parliament and then submitted to judicial criticism and revision. As a result of this revision a code bill was introduced in 1880; but a dissolution intervened and no serious effort was then made. The obstacle in the way is not lack of reports or digests on which to frame a code, but the incapacity of parliament to do the work itself, and its unwillingness to trust the work to other hands.

The Indian penal code and criminal procedure code, by their history, their form, and the extent and diversity of the races and peoples to which they apply, are perhaps the most important codes in the whole world. While the East India Company was merely a trading company holding certain forts and trading ports in India and elsewhere, such criminal justice as was administered under its auspices was in the main based on the English criminal law, said to have been introduced to some extent by the company's charter of 1661, but reintroduced into the presidency laws by later charters of 1726, 1753 and 1774. (See *Nuncomar and Impey*, by Sir J. Stephen.) From 1771 until 1860 the criminal law administered was the Mahomedan law. When in 1771 the East Indian Company determined to stand forth as diwan, Warren Hastings required the courts of the mofussil (provinces), as distinct from those of the presidency town of Fort William, to be guided in the administration of criminal justice by Mahomedan law, which under the Moguls had been used in criminal cases to the exclusion of Hindu law. Difficulties arose in administration, from the definition of crime, the nature of punishments, and in matters of procedure, which were removed by regulations and by enactments on English lines, especially in Bombay (1827); and great delays and considerable injustice were caused by the want of unity in judicial organization.

Between 1834 and 1837 Macaulay with three other com-

missioners, Macleod, Anderson and Millet, prepared a draft penal code for India, for which they drew not only upon English and Indian laws and regulations but also upon Livingstone's Louisiana code and the Code Napoléon. Little or nothing was taken from the Mahomedan law. A revised draft of the penal code by Sir B. Peacock, Sir J. W. Colville and others was completed in 1856. In framing it the reports of the English criminal law commissioners (published after Macaulay's draft code) were considered. The draft was presented to the legislative council in 1856, but owing to the mutiny and to objections from missionaries, &c., its passing was delayed till the 6th of October 1860. A draft scheme of criminal procedure was prepared in India in 1847-1848, which, after submission to a commission in England in 1853 (Government of India Act 1853), was moulded into a draft code which passed the India legislative council in 1861 (Act No. XXV.) and came into force in 1862. It has been re-enacted with amendments in 1872 (Act X.), 1882 (Act X.) and 1898 (Act V.).

The result is that in India the criminal law is the law of the conqueror, though for many civil purposes the law of race, religion and caste governs. Under the codes, one set of courts has been established throughout the country, composed of well-paid, well-educated judges, most of the higher judicial appointments being held by Englishmen; all those who hold subordinate judicial posts at the same time are subjected to a combined system of appeal and revision. The arrangement of the Indian penal code is natural as well as logical; its basis is the law of England stripped of technicality and local peculiarities, whilst certain modifications are introduced to meet the exigencies of a country such as British India. It opens with a chapter of general explanations, and interpretations of the terms used throughout the code. It then describes the various punishments to which offenders are liable; follows with a list of the exceptions regarding criminal responsibility under which a person who otherwise would be liable to punishment is exempted from the penal consequences of his act, such as offences committed by children, by accident or misfortune without any criminal intention, offences committed by lunatics, offences committed in the exercise of the right of private defence. It may be worth while to add, as an innovation on English law, that an act which results in harm so slight that no person of ordinary sense and temper would complain of such harm is not considered an offence under the code. Then follows a chapter on abetment, in other words, the instigation of a person to do a wrongful act. The next chapters deal with offences against the public, including the state, the army and navy, public tranquillity, public servants, contempts of the lawful authority of public servants, perjury; offences relating to coin and government stamps, to weights and measures; offences affecting the public health, safety, convenience, decency and morals; offences relating to religion; and offences relating to the human body, from murder down to the infliction of any hurt. The code then passes on to offences against property; offences relating to forgery, including trade marks, criminal breach of contracts for service; offences relating to marriage, defamation, criminal intimidation, insult and annoyance. Under this last head is included an attempt to cause a person to do anything which that person is not legally bound to do, by inducing him to believe that he would otherwise become subject to Divine displeasure. The last chapter deals with attempts to commit offences punishable by the code with transportation or imprisonment, and the punishment is limited to one-half of the longest term provided for the offence had it been carried out.

One peculiarity of the Penal Code which has proved eminently successful lies in the system of illustration of the offence declared in every section by a brief statement of some concrete case. For instance, as illustration of the offence of an attempt to commit an offence the following examples are given:—

I. "A. makes an attempt to steal some jewels by breaking open a box, and finds on opening the box there is no jewel in it. He has done an act towards the commission of theft, and therefore is guilty under this section.

II. "A. makes an attempt to pick the pocket of Z. by thrusting

his hand into Z.'s pocket. A. fails in the attempt in consequence of Z. having nothing in his pocket. A. is guilty under this section."

Passing on to the system of criminal procedure which is set forth in detail in the Code of Criminal Procedure as amended in 1898, it is no doubt modelled on the English system, but with considerable modifications. The principal steps are—(1) arrest by the police and inquiries by the police; (2) the issue of summons or warrant by the magistrate; (3) the mode of procedure before the magistrate, who may either try the accused himself or commit him to the sessions or the High Court, according to the importance of the case; (4) procedure before the court of session; (5) appeals, reference and revision by the High Court.

Elaborate provision is made for the prevention of offences, as regards security for keeping the peace and for good behaviour, the dispersion of unlawful assemblies, the suppression of nuisances, disputes as to immovable property, which in all Oriental countries constitute one of the most frequent causes of a breach of the peace.

Ample provision is thus made for the prevention of offences, and the code next deals with the mode of prosecution of offences actually committed.

As a general rule, every offence is inquired into and tried by the court within the local limits of whose jurisdiction it was committed. Differing from the practice of continental countries, all offences, even attempts, may be prosecuted after any lapse of time. As in England, there is no statutory limitation to a criminal offence.

A simple procedure is provided for what are called summons cases, as distinguished from warrant cases—the first being offences for which a police officer may arrest without warrant, the second being offences where he must have a warrant, or, in other words, minor offences and important offences. In summons cases no formal charge need be framed. The magistrate tells the accused the particulars of the offence charged; if he admits his guilt, he is convicted; if he does not, evidence is taken, and a finding is given in accordance with the facts as proved. When the complaint is frivolous or vexatious, the magistrate has the power to fine the complainant. The code gives power of criminal appeal which goes much further than the system in England.

In cases tried by a jury, no appeal lies as to matters of fact, but it is allowed as to matters of law; in other cases, criminal appeal is admitted on matters of law and fact.

In addition to the system of appeal, the superior courts are entrusted with a power of revision, which is maintained automatically by the periodical transmission to the High Courts of calendars and statements of all cases tried by the inferior courts; and at the same time, whenever the High Court thinks fit, it can call for the record of any trial and pass such orders as it deems right. All sentences of death must be confirmed by the High Court. No appeal lies against an acquittal in any criminal case. This system of appeal, superintendence and revision would be totally inapplicable to England, but it has proved eminently successful as applied to the present social condition of the inhabitants of India. The appeals keep the judges up to their work, revision corrects all grave mistakes, superintendence is necessary as a kind of discipline over the conduct of judges, who are not subjected, as in England, to the criticism of enlightened public opinion.

These Indian codes form the basis of the penal, &c., codes in force in Ceylon (superseding there the Roman-Dutch law), the Straits Settlements, the Sudan and the East Africa protectorates.

It has already been stated that most European states have codified their criminal law. The earliest of continental codes

is that of Charles V., promulgated in 1532, and known as *Constitutio Criminalis Carolina*. Austria made further codes in 1768 (*Constitutio Criminalis Theresiana*) and 1787 (Emperor Joseph's code). A new code was framed in 1803, and amended in 1852 by reference to the Code Napoléon; and in 1906 a completely new code existed in draft. The Hungarian penal code dates from 1880. The Bavarian code

Foreign codes.

of 1768 of Maximilian, revised in 1861, and the Prussian code of 1780, have been superseded by the German penal code of 1872.

The most important of the continental criminal codes are those of France, the *Code Pénal* (1810) and the *Code d'Instruction Criminelle* (1808)—the work of Napoleon the Great and his advisers, which professedly incorporate much of the Roman law.

The Belgian codes (1867), and the Dutch penal code (1880), closely follow the French model. In Spain the penal code dates from 1870, the procedure code from 1886. The Spanish American republics for the most part also have codes. Portugal has a penal code (1852). In Italy the procedure code and the penal code, perhaps the completest yet framed, are of 1890. The Swedish code dates from 1864. The Norwegian code was passed in May 1902, and came into force in 1905. Japan has a code based on a study of European and American models; and Switzerland is framing a federal criminal code.

In the United States no federal criminal code is possible; but most states, following the lead of Louisiana, have digested their criminal law and procedure more or less effectually into penal codes.

(W. F. C.)

**CRIMINOLOGY**, the name given to a new branch of social science, devoted to the discussion of the genesis of crime (*q.v.*), which has received much attention in recent years. The expression is one of modern coinage, and originated with the speculative theories first advanced by the school of sociologists which had the Italian savant, Professor Lombroso, at its head. He discovered or was supposed to have discovered a criminal type, the "instinctive" or "born" criminal, a creature who had come into the world predestined to evil deeds, and who could be surely recognized by certain stigmata, certain facial, physical, even moral birthmarks, the possession of which, presumably ineradicable, foredoomed him to the commission of crime. Dr Lombroso, in his ingenious work *L'Uomo delinquente*, found many attentive and appreciative, not to say bigoted followers. Large numbers of dissentients exist, however, and the conclusions of the Italian school have been warmly contested and on very plausible grounds. If the doctrines be fully accepted the whole theory of free-will breaks down, and we are faced with the paradox that we have no right to punish an irresponsible being who is impelled to crime by congenital causes, entirely beyond his control. The "instinctive" criminal, under this reasoning, must be classed with the lunatic whom we cannot justly, and practically never do, punish. There are other points on which proof of the existence of the criminal type fails absolutely. The whole theory illustrates a modern phase of psychological doctrine, and the subject has exercised such a potent effect on modern thought that the claims and pretensions of the Lombroso school must be examined and disposed of.

The alleged discovery of the "born-criminal" as a separate and distinct genus of the human species was first published by Dr Lombroso in 1876 as the result of long continued investigation and examination of a number of imprisoned criminals. The personality of this human monster was to be recognized by certain inherent moral and physical traits, not all displayed by the same individual but generally appearing in conjunction and then constituting the type. These traits have been defined as follows:—various brain and cerebral anomalies; receding foreheads; massive jaws, prognathous chins; skulls without symmetry; ears long, large and projecting (the ear *ad ansa*); noses rectilinear, wrinkles strongly marked, even in the young and in both sexes, hair abundant on the head, scanty on the cheeks and chin; eyes feline, fixed, cold, glassy, ferocious; bad repellent faces. Much stress is laid upon the physiognomy, and it is said that it is independent of nationality; two natives of the same country do not so nearly resemble each other as two criminals of different countries. Other peculiarities are:—great width of the extended arms (*l'envergure* of the French), extraordinary ape-like agility; left-handedness as well as ambi-dexterism; obtuse sense of smell, taste and sometimes of hearing, although the eyesight is superior to that of normal people. "In general," to quote Lombroso, "the born criminal has projecting ears, thick

hair and thin beard, projecting frontal eminences, enormous jaws, a square and protruding chin, large cheek bones and frequent gesticulation." So much for the anatomical and physiological peculiarities of the criminal. There remain the psychological or mental characteristics, so far as they have been observed. Moral insensibility is attributed to him, a dull conscience that never pricks and a general freedom from remorse. He is said to be generally lacking in intelligence, hence his stupidity, the want of proper precautions, both before and after an offence, which leads so often to his detection and capture. His vanity is strongly marked and shown in the pride taken in infamous achievements rather than personal appearance.

No sooner was this new theory made public than the very existence of the supposed type was questioned and more evidence demanded. A French savant declared that Lombroso's portraits were very similar to the photographs of his friends. Save for the dirt, the recklessness, the weariness and the misery so often seen on it, the face of the criminal does not differ from that of an honest man's. It was pointed out that if certain traits denoted the criminal, the converse should be seen in the honest man. A pertinent objection was that the deductions had been made from insufficient premises. The criminologists had worked upon a comparatively small number of criminals, and yet made their discoveries applicable to the whole class. The facts were collected from too small an area and no definite conclusions could be based upon them. Moreover, the criminologists were by no means unanimous. They differed amongst themselves and often contradicted one another as to the characteristics exhibited.

The controversy was long maintained. Many eminent persons have been arrayed on either side. In Italy Lombroso was supported by Colajanni, Ferri, Garofalo; in France by J. A. Lacassagne. In Germany Lombroso has found few followers; Dr Naëcke of Hubertusburg near Leipzig, one of the most eminent of German alienists, declined to admit there was any special animal type. Van Hamel of Amsterdam gives only a qualified approval. In England it stands generally condemned, because it gives no importance to circumstance and passing temptation, or to domestic or social environment, as affecting the causation of crime. Dr Nicholson of Broadmoor has said that "if the criminal is such by predestination, heredity or accidental flaws or anomalies in brain or physical structure, he is such for good and all; no cure is possible, all the plans and processes for his betterment, education, moral training and disciplinary treatment are nugatory and vain." No weight can then be attached to evil example, or unfavourable social surroundings, in moulding and forming character, particularly during the more plastic periods of childhood and youth.

The pertinent question remains, has the study and development of criminology served any useful purpose? Little perhaps can come of it in its restricted sense, but it has taken a wider meaning and embraces larger researches. It has inquired into the sources and causes of crime, it has collected criminal statistics and deduced valuable lessons from them, it has sought and obtained guidance in the best methods of prevention, repression, and forms of procedure. The champions of law and order have been greatly aided by the criminologist in carrying on the continual combat with crime, and in dealing with the most complicated of social phenomena. The new science has, in fact, by accumulating a number of curious details, in recording the psychology, the secret desires, the springs of the criminal's nefarious actions, his corrigibility or the reverse, "prepared the way to his sociological explanation" (Tarde). Thanks to the labours of the criminologist we are moving steadily forward to a future improved treatment of the criminal, and may thus arrive at the increased morality and greater safety of society. Very appreciable advance has been made in the increased attention paid to juvenile and adult crime, the acceptance of the theory, now well established, that there is an especially criminal age, a period when the moral fibre is weaker and more yielding to temptation to crime, when happily human nature is more malleable and susceptible to improvement and reform.

The study of criminology has, however, gone far to satisfy

us that the true genesis of crime is not to be sought in the anatomical anomalies of individuals, or in the fact that there are people who under "any social conditions whatever and of any nationality at no matter what epoch, would have undoubtedly become murderers and thieves." On the contrary it may be safely assumed that many such would have done no wrong if they had, e.g., been born rich, had been free from the pressing needs that drove them into crime, and had escaped the evil influences of their surroundings. The criminologists have strengthened the hands of administrators, have emphasized the paramount importance of child-rescue and judicious direction of adults, have held the balance between penal methods, advocating the moralizing effect of open-air labour as opposed to prolonged isolation, and have insisted upon the desirability of indefinite detention for all who have obstinately determined to wage perpetual war against society by the persistent perpetration of crime.

**AUTHORITIES.**—See A. Weingart, *Kriminaltaktik, ein Handbuch für das Untersuchen von Verbrechen* (Leipzig, 1904); F. H. Wines, *Punishment and Reformation* (New York, 1895); C. Perrier, *Les Criminels* (Paris, 1905); G. Macé, *Femmes criminelles* (Paris, 1904); E. Carpenter, *Prisons, Police and Punishment* (1905); R. R. Rentoul, *Proposed Sterilization of certain Mental and Physical Degenerates* (1904); R. Sommer, *Kriminalpsychologie und strafrechtliche Psychopathologie auf naturwissenschaftlicher Grundlage* (Leipzig, 1904); R. Kitzinger, *Die internationale kriminalistische Vereinigung* (1905); Reports of Committee on the best mode of giving efficiency to Secondary Punishments (1831-1832); Reports of the House of Commons Committee of 1853, of the royal commission of 1884, of the departmental committee of 1895, and the annual reports of H. M. inspectors for Great Britain and Ireland. (A. G.)

**CRIMMITZSCHAU**, or **KRIMMITSCHAU**, a town of Germany, in the kingdom of Saxony, on the Pleisse and the main Leipzig-Hof railway, 7 m. N.W. from Zwickau. Pop. (1900) 22,845. The most important industries of the town are the manufacture of buckskin, the spinning of carded yarn and vicuna-wool, and the processes of dyeing, finishing and wool-spinning connected with these. Among other manufactures are brushes, boilers and the like, machinery, metal ware generally, the cases and other parts of watches. The town has a modern school (Realschule), a commercial school, and technical schools for weaving and finishing.

**CRIMP** (possibly connected with "crimp," to draw together, or fold in parallel lines, in the sense of "confine"; the primary meaning, however, seems to be that of "agent," and the word may be a distinct one, of which the origin is lost), an agent for the supplying of soldiers and sailors, by kidnapping, drugging, decoying or other illegal means. Crimps were formerly regularly employed in the days of impressment (*q.v.*). Now the term is used, first of any one who engages to supply merchant seamen without a licence from the Board of Trade, and is not either the owner, master or mate of the ship, or is not bona fide the servant, and in the constant employment of the owner, or is not a superintendent (Merchant Shipping Act, 1894, § 111); and, with a wide application, of the extortionate lodging or boarding-house keepers, who are generally in league with the "crimp" proper.

Sections 212 to 219 inclusive of the above act provide for the protection of merchant seamen in the United Kingdom from imposition. Local authorities at seaports have power to make by-laws for the licensing and regulating of lodging-houses for sailors, and to inflict penalties for the infringement thereof. If this power be not exercised, the Board of Trade may do so. Penalties are also imposed by the act for overcharging by lodging-house keepers, for detaining of seamen's effects, and for soliciting. Unauthorized persons are prohibited from boarding a ship in port without leave. The Board of Trade officer at a port may provide money for sending a seaman to his home on discharge, and may forward his wages after deducting the expenses. Facilities are also given for having wages sent home from foreign ports at a small charge. These provisions have practically killed "crimping" in the United Kingdom. In the ports of the United States of America crimping was long prevalent, especially on the Pacific coast, and its prevention was very difficult, but state regulations as to the licensing of boarding-houses, and the limitation of the amount of so-called "blood-money" paid



by masters of vessels to the suppliers of crews to ships denuded by desertions, have reduced the abuse materially.

The term "to shanghai" is used of a more serious offence. Literally meaning "to ship to Shanghai," in China, it is applied to the drugging or rendering unconscious by violence or other means of persons, whether sailors or not, and shipping them to distant ports, in order fraudulently to obtain money in advance of wages, or for the sake of the premium paid for supplying crews.

**CRIMSON**, the name of a strong, bright red colour tinged to a greater or less degree with purple. It is the colour of the dye produced from the dried bodies of the cochineal insect (*Coccus cacti*). The word, in its earlier forms *cremesin*, *crymysyn*, also *cramoysin*, cf. "cramoisy," the name of a red cloth, is adapted from the Med. Lat. *cremesinus* for *hermesinus* or *carmesinus*, the dye produced from the insect *Kermes* (*Coccus ilicis*), Arab. *quirmiz*, which Skeat (*Etym. Dict.*, 1898) connects with the Sanskrit *krimi*, cognate with Lat. *vermis* and Eng. "worm." From the Lat. *carminus*, a shortened form of *carmesinus*, comes "carmine" (q.v.).

**CRINAGORAS**, of Mytilene, Greek epigrammatist, flourished during the reign of Augustus (Strabo xiii. p. 617). A number of epigrams appear under his name in the Greek Anthology. From inscriptions discovered at Mytilene, he appears to have been one of the ambassadors sent from that city to Rome in 45 and 26 B.C.

The epigrams have been edited by M. Rubensohn (1888).

**CRINOLINE** (a Fr. word formed of the Lat. *crinis*, hair, and *linum*, thread), a stiffening material made of horse-hair and cotton or linen thread. Substitutes for this, such as the straw-like material used in making hat shapes, are also known by the same name. From the use of the material to expand ladies' skirts the term was applied, during the third quarter of the 19th century, when the fashion of wearing greatly expanded skirts was at its height, to the whalebone and steel hoops employed to support the skirts thus worn (see COSTUME). The term is also used of structures resembling these articles, especially of the framework of booms, spars and netting forming a protection for a warship against torpedo attack.

**CRINUM**, a genus (nat. ord. Amaryllidaceae) of bulbous plants with rather broad leaves and a solid leafless stem, bearing a cluster of handsome white or red funnel-shaped regular flowers. They are well known in cultivation, and owing to the wide distribution of the genus different methods are adopted with different species. Some require the hot, moist temperature of a stove; such are *C. amabile*, a native of Sumatra, *C. amoenum* (India), *C. Balfourii* (Socotra), *C. giganteum* (West tropical Africa), *C. Kirkii* (Zanzibar), *C. latifolium* (India), *C. zeylanicum* (tropical Asia and Africa), and others. Others thrive in a greenhouse; such are *C. asiaticum*, a widely distributed plant on the sea-coast of tropical Asia, *C. capense* and *C. longiflorum*, from the Cape, and *C. Macowani* and *C. Moorei* from Natal. *C. asiaticum*, *C. capense* and *C. Macowani* will also thrive in sheltered positions in the garden.

**CRIOBOLIUM**, the sacrifice of a ram in the cult of Attis and the Great Mother. It seems to have been a special ceremony instituted after the rise, and on the analogy of the taurobolium (q.v.), which was performed in honour of the Great Mother, for the purpose of giving fuller recognition to Attis in the duality which he formed with the Mother. There is no evidence of its existence either in Asia or in Italy before the taurobolium came into prominence (after A.D. 134). When the criobolium was performed in conjunction with the taurobolium, the altar was almost invariably inscribed to both the Mother and Attis, while the inscription was to the Mother alone when the taurobolium only was performed. The celebration of the criobolium was widespread, and its importance such that it was sometimes performed in place of the taurobolium (*Corp. Inscr. Lat.* vi. 505, 506). The details and effect of the ceremony were no doubt similar to those of the taurobolium. (G. Sn.)

**CRIPPLE CREEK**, a city and the county-seat of Teller county, almost at the geographical centre of Colorado, U.S.A., one of the phenomenal mining camps of the West. Pop. (1900)

10,147 (1408 foreign-born); (1910) 6206. The city is served by three railways—the Colorado Springs & Cripple Creek District (a branch of the Colorado & Southern), the Midland Terminal (which connects at Divide, 30 m. distant by rail, with the Colorado Midland), and the Florence & Cripple Creek. Cripple Creek is situated on a mountain slope in a pocket amid the ranges, about 9600 ft. above the sea at the head of the stream after which it is named. The municipal water-supply is drawn from Pike's Peak, 10 m. distant. The interest of the city is in its extraordinary mines and their history. Cripple Creek's site was frequently prospected after 1860, and "colours" and gold "float" were always found, but not until February 1891 was the source discovered. Cripple Creek was at that time a cattle range. In 1891 the output of gold in the district was valued at \$449, in 1892 at \$583,010, and in the next three years at \$2,010,367, \$2,908,702 and \$6,879,137 respectively. From 1891 to 1906 the total production of gold was valued at \$168,584,331; in 1905<sup>1</sup> the product of gold was valued at \$15,411,724, the total for the whole state being valued at \$25,023,973; in 1906 the output for the district was valued at \$14,253,245, out of \$23,210,629 for the entire state. The development of the camp into a yellow-pine town and then into something more like a substantial city was marvellously rapid. The first railway was completed in 1894. In the same year a great strike—one of the most famous in American industrial history—threatening civil war, temporarily closed the mines; in 1896 fire almost destroyed the city; in 1903–1904 a second strike, lasting more than a year and greater than the first, occurred. The first strike, which was for an eight-hour day and \$3.00 wage, was won by the miners. The second, for the recognition outright of the union organization of the miners, secured only a reaffirmation of the former conditions. The ores are almost exclusively gold, tellurides being the most characteristic form, and occur in fissure veins. Outcroppings were very rare, as the veins were covered with loose wash, and this accounted for the late opening of the field. The field covers a district about 8×10 m. Some peculiarities of the ores have required the use of new methods in their treatment, and in general the development of mining methods and machinery is of a wonderful character. The whole surrounding country is seamed with miles of tunnels in granite, and the hillsides are dotted everywhere with enormous dumps. The most famous mines have been the "Independence" (1891) and the "Portland" (1892). The latter had in 1904 more than 25 m. of workings above the 1100-ft. level. In 1903 the El Paso drain was completed, to unwater the western half of the field to the 880-ft. level, greatly increasing many mine values and outputs; in 1906 the work of drainage was again taken up, and work on a long bore was begun in May 1907. There are smelters and cyanide extractors in the district, but the bulk of the ore product is shipped to other places for treatment. Among the towns around Cripple Creek in the same mining district is Victor, pop. (1900) 4986, incorporated in 1894, chartered as a city in 1898.

See W. Lindgren and F. L. Ransome, *Geology and Gold Deposits of the Cripple Creek District, Colorado*, with maps (Washington, 1906), being Professional Paper No. 54 of the United States Geological Survey; and Benjamin McKie Rastall, *The Labor History of the Cripple Creek District; A Study in Industrial Evolution* (Madison, Wis., 1908), a full account of the strikes of 1894 and of 1903–1904.

**CRISA**, or **CRISSA**, in ancient geography, one of the oldest cities of Greece, situated in Phocis, on one of the spurs of Parnassus. Its name occurs both in the *Iliad* and in the *Homeric Hymns*, where it is described as a powerful place, with a rich and fertile territory, reaching to the sea, and including within its limits the sanctuary of Pytho. As the town of Delphi grew up around the shrine, and the seaport of Cirrha arose on the Crisean Gulf, Crisa gradually lost much of its importance. By the ancients themselves the name of Cirrha was so often substituted for that of Crisa, that it soon became doubtful whether

<sup>1</sup> The value of gold mined in 1899–1902 was greater, annually, than the product of 1905 or 1906; up to 1905 the greatest annual value was in 1900, \$18,073,539.

these names indicated the same city or not. The question was practically settled by the investigations of H. N. Ulrichs. From its position Cirrha commanded the approach to Delphi, and its inhabitants became obnoxious to the Greeks from the heavy tolls which they exacted from the devotees who thronged to the shrine. The Amphictyonic Council declared war (the first Sacred War) against the Criseans in 595 B.C., and having taken the town, razed it to the ground, and consecrated its territory to the temple at Delphi. The plunder of the town was sold to defray the expenses of the Pythian games. In 339 the people of Amphissa began to rebuild the town of Cirrha and to cultivate the plain. This act brought on the second Sacred War, the conduct of which was entrusted by the Amphictyons to Philip of Macedon, who took Amphissa (mod. Salona) in the following year. The ruins of Crisa may be still seen where the ravine of the Pleistus joins the plain; its name is probably preserved by the modern Chryso.

See J. G. Frazer's *Pausanias*, v. 459 (note on x. 37.5).

(E. GR.)

**CRISPI, FRANCESCO** (1819-1901), Italian statesman, was born at Ribéra in Sicily on the 4th of October 1819. In 1846 he established himself as advocate at Naples. On the outbreak of the Sicilian revolution at Palermo (January 12, 1848) he hastened to the island and took an active part in guiding the insurrection. Upon the restoration of the Bourbon government (May 15, 1849) he was excluded from the amnesty and compelled to flee to Piedmont. Here he unsuccessfully applied for a situation as communal secretary of Verolengo, and eked out a penurious existence by journalism. Implicated in the Mazzinian conspiracy at Milan (February 6, 1853), he was expelled from Piedmont, and obliged to take refuge at Malta, whence he fled to Paris. Expelled from France, he joined Mazzini in London, and continued to conspire for the redemption of Italy. On the 15th of June 1859 he returned to Italy after publishing a letter repudiating the aggrandizement of Piedmont, and proclaiming himself a republican and a partisan of national unity. Twice in that year he went the round of the Sicilian cities in disguise, and prepared the insurrectionary movement of 1860.

Upon his return to Genoa he organized, with Bertani, Bixio, Mélici and Garibaldi, the expedition of the Thousand, and overcoming by a stratagem the hesitation of Garibaldi, secured the departure of the expedition on the 5th of May 1860. Disembarking at Marsala on the 11th, Crispi on the 13th, at Salemi, drew up the proclamation whereby Garibaldi assumed the dictatorship of Sicily, with the programme: "Italy and Victor Emmanuel." After the fall of Palermo, Crispi was appointed minister of the interior and of finance in the Sicilian provisional government, but was shortly afterwards obliged to resign on account of the struggle between Garibaldi and the emissaries of Cavour with regard to the question of immediate annexation. Appointed secretary to Garibaldi, Crispi secured the resignation of Depretis, whom Garibaldi had appointed pro-dictator, and would have continued his fierce opposition to Cavour at Naples, where he had been placed by Garibaldi in the foreign office, had not the advent of the Italian regular troops and the annexation of the Two Sicilies to Italy brought about Garibaldi's withdrawal to Caprera and Crispi's own resignation. Entering parliament in 1861 as deputy of the extreme Left for Castelvetrano, Crispi acquired the reputation of being the most aggressive and most impetuous member of the republican party. In 1864, however, he made at the chamber a monarchical profession of faith, in the famous phrase afterwards repeated in his letter to Mazzini: "The monarchy unites us; the republic would divide us." In 1866 he refused to enter the Ricasoli cabinet; in 1867 he worked to impede the Garibaldian invasion of the papal states, foreseeing the French occupation of Rome and the disaster of Mentana. By methods of the same character as those subsequently employed against himself by Cavallotti, he carried on the violent agitation known as the Lobbia affair, in which sundry conservative deputies were, on insufficient grounds, accused of corruption. On the outbreak of the Franco-German War he

worked energetically to impede the projected alliance with France, and to drive the Lanza cabinet to Rome. The death of Ratazzi in 1873 induced Crispi's friends to put forward his candidature to the leadership of the Left; but Crispi, anxious to reassure the crown, secured the election of Depretis. After the advent of the Left he was elected (November 1876) president of the chamber. During the autumn of 1877 he went to London, Paris and Berlin on a confidential mission, establishing cordial personal relationships with Gladstone, Granville and other English statesmen, and with Bismarck.

In December 1877 he replaced Nicotera as minister of the interior in the Depretis cabinet, his short term of office (70 days) being signalized by a series of important events. On January 9, 1878, the death of Victor Emmanuel and the accession of King Humbert enabled Crispi to secure the formal establishment of a unitary monarchy, the new monarch taking the title of Humbert I. of Italy instead of Humbert IV. of Savoy. The remains of Victor Emmanuel were interred in the Pantheon instead of being transported to the Savoy Mausoleum at Superga. On the 9th of February, 1879, the death of Pius IX. necessitated a conclave, the first to be held after the unification of Italy. Crispi, helped by Mancini and Cardinal Pecci (afterwards Leo XIII.), persuaded the Sacred College to hold the conclave in Rome, and prorogued the chamber lest any untoward manifestation should mar the solemnity of the event. The statesmanlike qualities displayed on this occasion were unavailing to avert the storm of indignation conjured up by Crispi's opponents in connexion with a charge of bigamy not susceptible of legal proof. Crispi was compelled to resign office, although the judicial authorities upheld the invalidity of his early marriage, contracted at Malta in 1853, and ratified his subsequent union with Signora Barbagallo. For nine years Crispi remained politically under a cloud, but in 1887 returned to office as minister of the interior in the Depretis cabinet, succeeding to the premiership upon the death of Depretis (July 29, 1887).

One of his first acts as premier was a visit to Bismarck, whom he desired to consult upon the working of the Triple Alliance. Basing his foreign policy upon the alliance, as supplemented by the naval *entente* with Great Britain negotiated by his predecessor, Count Robilant, Crispi assumed a resolute attitude towards France, breaking off the prolonged and unfruitful negotiations for a new Franco-Italian commercial treaty; and refusing the French invitation to organize an Italian section at the Paris Exhibition of 1889. At home Crispi secured the adoption of the Sanitary and Commercial Codes, and reformed the administration of justice. Forsaken by his Radical friends, Crispi governed with the help of the Right until, on the 31st of January 1891, an intemperate allusion to the *sante memorie* of the conservative party led to his overthrow. In December 1893 the impotence of the Giolitti cabinet to restore public order, then menaced by disturbances in Sicily and in Lunigiana, gave rise to a general demand that Crispi should return to power. Upon resuming office he vigorously suppressed the disorders, and steadily supported the energetic remedies adopted by Sonnino, minister of finance, to save Italian credit, which had been severely shaken by the bank and financial crises of 1892-1893. Crispi's uncompromising suppression of disorder, and his refusal to abandon either the Triple Alliance or the Eritrean colony, or to forsake his colleague Sonnino, caused a breach between him and the radical leader Cavallotti. Cavallotti then began against him a pitiless campaign of defamation. An unsuccessful attempt upon Crispi's life by the anarchist Lega brought a momentary truce, but Cavallotti's attacks were soon renewed more fiercely than ever. They produced so little effect that the general election of 1895 gave Crispi a huge majority, but, a year later, the defeat of the Italian army at Adowa in Abyssinia brought about his resignation. The ensuing Rudini cabinet lent itself to Cavallotti's campaign, and at the end of 1897 the judicial authorities applied to the chamber for permission to prosecute Crispi for embezzlement. A parliamentary commission, appointed to inquire into the charges against him, discovered only that Crispi, on assuming office in 1893, had found the secret service coffers empty, and

had borrowed from a state bank the sum of £12,000 for secret service, repaying it with the monthly instalments granted in regular course by the treasury. The commission, considering this proceeding irregular, proposed, and the chamber adopted, a vote of censure, but refused to authorize a prosecution. Crispi resigned his seat in parliament, but was re-elected by an overwhelming majority in April 1898 by his Palermo constituents. For some time he took little part in active politics, chiefly on account of his growing blindness. A successful operation for cataract restored his eyesight in June 1900, and notwithstanding his 81 years he resumed to some extent his former political activity. Soon afterwards, however, his health began to give way permanently, and he died at Naples on the 12th of August 1901.

The importance of Crispi in Italian public life depended less upon the many reforms accomplished under his administrations than upon his intense patriotism, remarkable fibre, and capacity for administering to his fellow-countrymen the political tonic of which they stood in constant need. In regard to foreign politics he greatly contributed to raise Italian prestige and to dispel the reputation for untrustworthiness and vacillation acquired by many of his predecessors. If in regard to France his policy appeared to lack suavity and circumspection, it must be remembered that the French republic was then engaged in active anti-Italian schemes and was working, both at the Vatican and in the sphere of colonial politics, to create a situation that should compel Italy to bow to French exigencies and to abandon the Triple Alliance. Crispi was prepared to cultivate good relations with France, but refused to yield to pressure or to submit to dictation; and in this attitude he was firmly supported by the bulk of his fellow-countrymen. The criticism freely directed against him was based rather upon the circumstances of his unfortunate private life and the misdeeds of an unscrupulous *entourage* which traded upon his name than upon his personal or political shortcomings.

See *Scritti e discorsi politici di F. Crispi, 1847-1890* (Rome, 1890); *Francesco Crispi*, by W. J. Stillman (London, 1899).

**CRISPIN** and **CRISPINIAN**, the patron saints of shoemakers, whose festival is celebrated on the 25th of October. Their history is largely legendary, and there exists no trace of it earlier than the 8th century. It is said that they were brothers and members of a noble family in Rome. They gave up their property and travelled to Soissons (Noviodunum, Augusta Suessionum), where they supported themselves by shoemaking and made many converts to Christianity. The emperor Maximianus (Herculeus) condemned them to death. His prefect Rictiovarus endeavoured to carry out the sentence, but they emerged unharmed from all the ordeals to which he subjected them, and the weapons he used recoiled against the executioners. Rictiovarus in disgust cast himself into the fire, or the caldron of boiling tar, from which they had emerged refreshed. At last Maximian had their heads cut off (c. 287-300). Their remains were buried at Soissons, but were afterwards removed, partly by Charlemagne to Osna-brück (where a festival is observed annually on the 20th of June) and partly to the chapel of St Lawrence in Rome. The abbeys of St Crépin-en-Chaye (the remains of which still form part of a farmhouse on the river Aisne, N.N.W. of Soissons), of St Crépin-le-Petit, and St Crépin-le-Grand (the site of which is occupied by a house belonging to the Sisters of Mercy), in or near Soissons, commemorated the places sanctified by their imprisonment and burial. There are also relics at Fulda, and a Kentish tradition claims that the bodies of the martyrs were cast into the sea and cast on shore on Romney Marsh (see *Acta SS. Bolland*, xi. 495; A. Butler, *Lives of the Saints*, October 25th).

Especially in France, but also in England and in other parts of Europe, the festival of St Crispin was for centuries the occasion of solemn processions and merry-making, in which guilds of shoemakers took the chief part. At Troyes, where the guild of St Crispin was reconstituted as late as 1820, an annual festival is celebrated in the church of St Urban. In England and Scotland the day acquired additional importance as the anniversary of the battle of Agincourt (cf. Shakespeare, *Henry V.* iv. 3); the

symbolical processions in honour of "King Crispin" at Stirling and Edinburgh were particularly famous.

For other examples see *Notes and Queries*, 1st series, v. 30, vi. 243; W. S. Walsh, *Curiosities of Popular Customs* (London, 1898).

**CRITIAS**, Athenian orator and poet, and one of the Thirty Tyrants. In his youth he was a pupil of Gorgias and Socrates, but subsequently devoted himself to political intrigues. In 415 B.C. he was implicated in the mutilation of the Hermae and imprisoned. In 411 he helped to put down the Four Hundred, and was instrumental in procuring the recall of Alcibiades. He was banished (probably in the democratic reaction of 407) and fled to Thessaly, where he stirred up the Penestae (the helots of Thessaly) against their masters, and endeavoured to establish a democracy. Returning to Athens he was made ephor by the oligarchical party; and he was the most cruel and unscrupulous of the Thirty Tyrants who in 404 were appointed by the Lacedaemonians. He was slain in battle against Thrasybulus and the returning democrats. Critias was a man of varied talents—poet, orator, historian and philosopher. Some fragments of his elegies will be found in Bergk, *Poetae Lyrici Graeci*. He was also the author of several tragedies and of biographies of distinguished poets (possibly in verse).

See Xenophon, *Hellenica*, ii. 3. 4. 19, *Memorabilia*, i. 2; Cornelius Nepos, *Thrasybulus*, 2; R. Lallier, *De Critiae tyranni vita ac scriptis* (1875); Nestle, *Neue Jahrb. f. d. kl. Altert.* (1903).

**CRITICISM** (from the Gr. κρίσις, a judge, κρίναι, to decide, to give an authoritative opinion), the art of judging the qualities and values of an aesthetic object, whether in literature or the fine arts.<sup>1</sup> It involves, in the first instance, the formation and expression of a judgment on the qualities of anything, and Matthew Arnold defined it in this general sense as "a disinterested endeavour to learn and propagate the best that is known and thought in the world." It has come, however, to possess a secondary and specialized meaning as a published analysis of the qualities and characteristics of a work in literature or fine art, itself taking the form of independent literature. The sense in which criticism is taken as implying censure, the "picking holes" in any statement or production, is frequent, but it is entirely unjustifiable. There is nothing in the proper scope of criticism which presupposes blame. On the contrary, a work of perfect beauty and fitness, in which no fault could possibly be found with justice, is as proper a subject for criticism to deal with as a work of the greatest imperfection. It may be perfectly just to state that a book or a picture is "beneath criticism," i.e. is so wanting in all qualities of originality and technical excellence that time would merely be wasted in analysing it. But it can never be properly said that a work is "above criticism," although it may be "above censure," for the very complexity of its merits and the fulness of its beauties tempt the skill of the analyser and reward it.

It is necessary at the threshold of an examination of the history of criticism to expose this laxity of speech, since nothing is more confusing to a clear conception of this art than to suppose that it consists in an effort to detect what is blameworthy. Candid criticism should be neither benevolent nor adverse; its function is to give a just judgment, without partiality or bias. A critic (κριτικός) is one who exercises the art of criticism, who sets himself up, or is set up, as a judge of literary and artistic merit. The irritability of mankind, which easily forgets and neglects praise, but cannot forgive the rankling poison of blame, has set upon the word *critic* a seal which is even more unamiable than that of *criticism*. It takes its most savage form in Benjamin Disraeli's celebrated and deplorable *dictum*, "the critics are the men who have failed in literature and art." It is plain that such names as those of Aristotle, Dante, Dryden, Joshua Reynolds, Sainte-Beuve and Matthew Arnold are not to be thus swept by a reckless fulmination. There have been

<sup>1</sup> It is in this general sense that the subject is considered in this article. The term is, however, used in more restricted senses, generally with some word of qualification, e.g. "textual criticism" or "higher criticism"; see the article **TEXTUAL CRITICISM** and the article **BIBLE** for an outstanding example of both "textual" and "higher."

many critics who brought from failure in imaginative composition a cavilling, jealous and ignoble temper, who have mainly exercised their function in indulging the evil passion of envy. But, so far as they have done this, they have proved themselves bad critics, and neither minute care, nor a basis of learning, nor wide experience of literature, salutary as all these must be, can avail to make that criticism valuable which is founded on the desire to exaggerate fault-finding and to emphasize censure unfairly. The examination of what has been produced by other ages of human thought is much less liable to this dangerous error than the attempt to estimate contemporary works of art and literature. There are few indeed whom personal passion can blind to the merits of a picture of the 15th or a poem of the 17th century. In the higher branches of historical criticism, prejudice of this ignoble sort is hardly possible, and therefore, in considering criticism in its ideal forms, it is best to leave out of consideration that invidious and fugitive species which bears the general name of "reviewing." This pedestrian criticism, indeed, is useful and even indispensable, but it is, by its very nature, ephemeral, and it is liable to a multitude of drawbacks. Even when the reviewer is, or desires to be, strictly just, it is almost impossible for him to stand far enough back from the object under review to see it in its proper perspective. He is dazzled, or scandalized, by its novelty; he has formed a preconceived notion of the degree to which its author should be encouraged or depressed; he is himself, in all cases, an element in the mental condition which he attempts to judge, and if not positively a defendant is at least a jurymen in the court over which he ought to preside with remote impartiality.

It may be laid down as the definition of criticism in its pure sense, that it should consist in the application, in the most competent form, of the principles of literary composition. Those principles are the general aesthetics upon which taste is founded; they take the character of rules of writing. From the days of Aristotle the existence of such rules has not been doubted, but different orders of mind in various ages have given them diverse application, and upon this diversity the fluctuations of taste are founded. It is now generally admitted that in past ages critics have too often succumbed to the temptation to regulate taste rigidly, and to lay down rules that shall match every case with a formula. Over-legislation has been the bane of official criticism, and originality, especially in works of creative imagination, has been condemned because it did not conform to existing rules. Such instances of want of contemporary appreciation as the reception given to William Blake or Keats, or even Milton, are quoted to prove the futility of criticism. As a matter of fact they do nothing of the kind. They merely prove the immutable principles which underlie all judgment of artistic products to have been misunderstood or imperfectly obeyed during the life-times of those illustrious men. False critics have built domes of glass, as Voltaire put it, between the heavens and themselves, domes which genius has to shatter in pieces before it can make itself comprehended. In critical application formulas are often useful, but they should be held lightly; when the formula becomes the tyrant where it should be the servant of thought, fatal error is imminent. What is required above all else by a critic is knowledge, tempered with good sense, and combined with an exquisite delicacy of taste. He who possesses these qualities may go wrong in certain instances, but his error cannot become radical, and he is always open to correction. It is not his business crudely to pronounce a composition "good" or "bad"; he must be able to show why it is "good" and wherein it is "bad"; he must admire with independence and blame with careful candour. He must above all be assiduous to escape from pompous generalizations, which conceal lack of thought under a flow of words. The finest criticism should take every circumstance of the case into consideration, and hold it necessary, if possible, to know the author as well as the book. A large part of the reason why the criticism of productions of the past is so much more fruitful than mere contemporary reviewing, is that by remoteness from the scene of action the critic is able to make himself familiar with all the elements of

age, place and medium which affected the writer at the moment of his composition. In short, knowledge and even taste are not sufficient for perfect criticism without the infusion of a still rarer quality, breadth of sympathy.

Criticism has been one of the latest branches of literature to reach maturity, but from very early times the instinct which induces mankind to review what it has produced led to the composition of imperfect but often extremely valuable bodies of opinion. What makes these early criticisms tantalizing is that the moral or political aspects of literature had not disengaged themselves from the purely intellectual or aesthetic.

To pass to an historical examination of the subject, we find that in antiquity Aristotle was regarded as the father and almost as the founder of literary criticism. Yet before his day, three Greek writers of eminence had examined, in more or less fulness, the principles of composition; these were Plato, Isocrates and Aristophanes. The comedy of *The Frogs*, by the latter, is the earliest specimen we possess of hostile literary criticism, being devoted to ridicule of the plays of Euripides. In the cases of Plato and Isocrates, criticism takes the form mainly of an examination of the rules of rhetoric. We reach, however, much firmer ground when we arrive at Aristotle, whose *Poetics* and *Rhetoric* are among the most valuable treatises which antiquity has handed down to us. Of what existed in the literature of his age, extremely rich in some branches, entirely empty in others, Aristotle speaks with extraordinary authority; but Mr G. Saintsbury has justly remarked that as his criticism of poetry was injuriously affected by the non-existence of the novelist, so his criticism of prose was injuriously affected by the omnipresence of the orator. This continues true of all ancient criticism. A work by Aristotle on the problems raised by a study of Homer is lost, and there may have been others of a similar nature; in the two famous treatises which remain we have nothing less important than the foundation on which all subsequent European criticism has been raised. It does not appear that any of the numerous disciples of Aristotle understood his attitude to literature, nor do the later philosophical schools offer much of interest. The Neoplatonists, however, were occupied with analysis of the Beautiful, on which both Proclus and Plotinus expatiated; still more purely literary were some of the treatises of Porphyry. There seems to be no doubt that Alexandria possessed, in the third century, a vivid school of critic-grammarians; the names of Zenodotus, of Crates and of Aristarchus were eminent in this connexion, but of their writings nothing substantial has survived. They were followed by the scholiasts, and they by the mere rhetoricians of the last Greek schools, such as Hermogenes and Aphthonius. In the 2nd century of our era, Dio Chrysostom, Aristides of Smyrna, and Maximus of Tyre were the main representatives of criticism, and they were succeeded by Philostratus and Libanius. The most modern of post-Christian Greek critics, however, is unquestionably Dionysius of Halicarnassus, who leads up to Lucian and Cassius Longinus. The last-mentioned name calls for special notice; in "the lovely and magnificent personality of Longinus" we find the most intelligent judge of literature who wrote between Aristotle and the moderns. His book *On the Sublime* (*Περὶ ὑψους*), probably written about A.D. 260, and first printed in 1554, is of extreme importance, while his intuitions and the splendour of his style combine to lift Longinus to the highest rank among the critics of the world.

In Roman literature criticism never took a very prominent position. In early days the rhetorical works of Cicero and the famous *Art of Poetry* of Horace exhaust the category. During the later Augustan period the only literary critic of importance was the elder Seneca. Passing over the valuable allusions to the art of writing in the poets, especially in Juvenal and Martial, we reach, in the Silver Age, Quintilian, the most accomplished of all the Roman critics. His *Institutes of Oratory* has been described as the fullest and most intelligent application of criticism to literature which the Latin world produced, and one which places the name of Quintilian not far below those of Aristotle and Longinus. He was followed by Aulus Gellius.

by Macrobius (whose reputation was great in the middle ages), by Servius (the great commentator on Virgil), and, after a long interval, by Martianus Capella. Latin criticism sank into mere pedantry about rhetoric and grammar. This continued throughout the Dark Ages, until the 13th century, when rhythmical treatises, of which the *Labyrinthus* of Eberhard (1212?) and the *Arts rhythmica* of John of Garlandia (John Garland) are the most famous, came into fashion. These writings testified to a growing revival of a taste for poetry.

It is, however, in the masterly technical treatise *De vulgari eloquio*, generally attributed to Dante, the first printed (in Italian) in 1529, that modern poetical criticism takes its first step. The example of this admirable book was not adequately followed; throughout the 14th and 15th centuries, criticism is mainly indirect and accidental. Boccaccio, indeed, is the only figure worthy of mention, between Dante and Erasmus. With the Renaissance came a blossoming of Humanist criticism in Italy, producing such excellent specimens as the *Sylvae* of Poliziano, the *Poetics* (1527) of Vida, and the *Poetica* of Trissino, the best of a whole crop of critical works produced, often by famous names, between 1525 and 1560. These were followed by sounder scholars and acuter theorists: by Scaliger with his epoch-making *Poetics* (1561); by L. Castelvetro, whose *Poetica* (1570) started the modern cultivation of the Unities and asserted the value of the Epic; by Tasso with his *Discorsi* (1587); and by Francesco Patrizi in his *Poetica* (1586).

In France, the earliest and for a long time the most important specimen of literary criticism was the *Défense et illustration de la langue française*, published in 1549 by Joachim du Bellay. Ronsard, also, wrote frequently and ably on the art of poetry. The theories of the Pléiade were summed up in the *Art poétique* of Vauquelin de la Fresnaye, which belongs to 1574 (though not printed until 1605).

In England, the earliest literary critic of importance was Thomas Wilson, whose *Art of Rhetoric* was printed in 1553, and the earliest student of poetry, George Gascoigne, whose *Instruction* appeared in 1575. Gascoigne is the first writer who deals intelligently with the subject of English prosody. He was followed by Thomas Drant, Harvey, Gosson, Lodge and Sidney, whose controversial pamphlets belong to the period between 1575 and 1580. Among Elizabethan "arts" or "defences" of English poetry are to be mentioned those of William Wehbe (1586), George Puttenham (1589), Thomas Campion (1602), and Samuel Daniel (1603). With the tractates of Ben Jonson, several of them lost, the criticism of the Renaissance may be said to close.

A new era began throughout Europe when Malherbe started, about 1600, a taste for the neo-classic or anti-romantic school of poetry, taking up the line which had been foreshadowed by Castelvetro. *Enfin Malherbe vint*, and he was supported in his revolution by Regnier, Vaugelas, Balzac, and finally by Corneille himself, in his famous prefatory discourses. It was Boileau, however, who more than any other man stood out at the close of the 17th century as the law-giver of Parnassus. The rules of the neo-classics were drawn together and arranged in a system by René Rapin, whose authoritative treatises mainly appeared between 1668 and 1674. It is in writings of this man, and of the Jesuits, Le Bossu and Bouhours, that the preposterous rigidity of the formal classic criticism is most plainly seen. The influence of these three critics was, however, very great throughout Europe, and we trace it in the writings of Dryden, Addison and Rymer. In the course of the 18th century, when the neo-classic creed was universally accepted, Pope, Blair, Kames, Harris, Goldsmith and Samuel Johnson were its most distinguished exponents in England, while Voltaire, Buffon (to whom we owe the phrase "the style is the man"), Marmontel, La Harpe and Suard were the types of academic opinion in France.

Modern, or more properly Romantic, criticism came in when the neo-classic tradition became bankrupt throughout Europe at the very close of the 18th century. It has been heralded in Germany by the writings of Lessing, and in France by those of

Diderot. Of the reconstruction of critical opinion in the 19th century it is impossible to speak here with any fulness, it is contained in the record of the recent literature of each European language. It is noticeable, in England, that the predominant place in it was occupied, in violent contrast with Disraeli's dictum, by those who had obviously *not* failed in imaginative composition, by Wordsworth, by Shelley, by Keats, by Landor, and pre-eminently by S. T. Coleridge, who was one of the most penetrative, original and imaginative critics who have ever lived. In France, the importance of Sainte-Beuve is not to be ignored or even qualified; after manifold changes of taste, he remains as much a master as he was a precursor. He was followed by Théophile Gautier, Saint-Marc, Girardin, Paul de Saint Victor, and a crowd of others, down to Taine and the latest school of individualistic critics, comparable with Matthew Arnold, Pater, and their followers in England.

See G. Saintsbury, *A History of Criticism* (3 vols., 1902-1904); J. E. Spingarn, *A History of Literary Criticism in the Renaissance* (2nd ed. 1908); Théry, *Histoire des opinions littéraires* (1849); J. A. Symonds, *The Revival of Learning* (1877); Matthew Arnold, *Essays in Criticism*, i. (1865), ii. (1868); Bourgois, *Les Maîtres de la critique au XVII<sup>e</sup> siècle* (1889); Paul Hamelius, *Die Kritik in der englischen Literatur* (1897); S. H. Butcher, *The Poetics of Aristotle* (1898); H. L. Havell and Andrew Lang, *Longinus on the Sublime* (1890). See also the writings of Sainte-Beuve, Matthew Arnold, F. Brunetière, Anatole France, Walter Pater, *passim*. (E. G.)

**CRITIUS** and **NESIOTES**, two Greek sculptors of uncertain school, of the time of the Persian Wars. When Xerxes carried away to Persia the statues of Harmodius and Aristogiton made by Antenor, Critius and Nesiotes were commissioned to replace them. By the help of coins and reliefs, two statues at Naples, wrongly restored as gladiators, have been identified as copies of the tyrannicides of Critius; and to them well apply the words in which Lucian (*Rhetor. praecepta*, 9) describes the works of Critius and Nesiotes, "closely knit and sinewy, and hard and severe in outline." Critius also made a statue of the armed runner Epicharinus.

**CRITOLAUS**, Greek philosopher, was born at Phaselis in the 2nd century B.C. He lived to the age of eighty-two and died probably before 111 B.C. He studied philosophy under Aristo of Ceos and became one of the leaders of the Peripatetic school by his eminence as an orator, a scholar and a moralist. There has been considerable discussion as to whether he was the immediate successor of Aristo, but the evidence is confused and unprofitable. In general he was a loyal adherent to the Peripatetic succession (cf. Cicero, *De fin.* v. 5 "C. imitari antiquos voluit"), though in some respects he went beyond his predecessors. For example, he held that pleasure is an evil (Gellius, *Noctes Atticae*, ix. 5. 6), and definitely maintained that the soul consists of aether. The end of existence was to him the general perfection of the natural life, including the goods of the soul and the body, and also external goods. Cicero says in the *Tusculans* that the goods of the soul entirely outweighed for him the other goods ("tantum propendere illam bonorum animi lancem"). Further, he defended against the Stoics the Peripatetic doctrine of the eternity of the world and the indestructibility of the human race. There is no observed change in the natural order of things; mankind re-creates itself in the same manner according to the capacity given by Nature, and the various ills to which it is heir, though fatal to individuals, do not avail to modify the whole. Just as it is absurd to suppose that man is merely earth-born, so the possibility of his ultimate destruction is inconceivable. The world, as the manifestation of eternal order, must itself be immortal. The life of Critolaus is not recorded. One incident alone is preserved. From Cicero (*Acad.* ii. 45) it appears that he was sent with Carneades and Diogenes to Rome in 156-155 B.C. to protest against the fine of 500 talents imposed on Athens in punishment for the sack of Oropus. The three ambassadors lectured on philosophy in Rome with so much success that Cato was alarmed and had them dismissed the city. Gellius describes his arguments as *scitu et teretia*.

Consult the article PERIPATETICS, and histories of ancient philosophy, e.g. Zeller.



**CRITTENDEN, JOHN JORDAN** (1787-1863), American statesman, was born in Versailles, Kentucky, on the 10th of September 1787. After graduating at the College of William and Mary in 1807, he began the practice of law in his native state. He served for three months, in 1810, as attorney-general of Illinois Territory, but soon returned to Kentucky, and during the War of 1812 he was for a time on the staff of General Isaac Shelby. In 1811-1817 he served in the state House of Representatives, being speaker in 1815-1816, and in 1817-1819 was a United States senator. Settling in Frankfort, he soon took high rank as a criminal lawyer, was in the Kentucky House of Representatives in 1825 and 1829-1832, acting as speaker in the latter period, and from 1827 to 1829 was United States district-attorney. He was removed by President Jackson, to whom he was radically opposed. In 1835, as a Whig, he was again elected to the United States Senate, and was re-elected in 1841, but resigned to enter the cabinet of President W. H. Harrison as attorney-general, continuing after President Tyler's accession and serving from March until September. He was again a member of the United States Senate from 1842 to 1848, and in 1848-1850 was governor of Kentucky. He was an ardent and outspoken supporter of Clay's compromise measures, and in 1850 he entered President Fillmore's cabinet as attorney-general, serving throughout the administration. From 1855 to 1861 he was once more a member of the United States Senate. During these years he was perhaps the foremost champion of Union in the South, and strenuously opposed the Kansas-Nebraska Bill, which he declared prophetically would unite the various elements of opposition in the North, and render the breach between the sections irreparable. Nevertheless he laboured unceasingly in the cause of compromise, gave his strong support to the Bell and Everett ticket in 1860, and in 1860-1861 proposed and vainly contended for the adoption by congress of the compromise measures which bear his name. When war became inevitable he threw himself zealously into the Union cause, and lent his great influence to keep Kentucky in the Union. In 1861-1863 he was a member of the national House of Representatives, where, while advocating the prosecution of the war, he opposed such radical measures as the division of Virginia, the enlistment of slaves and the Conscription Acts. He died at Frankfort, Kentucky, on the 26th of July 1863.

See the *Life of J. J. Crittenden*, by his daughter Mrs Chapman Coleman (2 vols., Philadelphia, 1871).

His son, **GEORGE BIBB CRITTENDEN** (1812-1880), soldier, was born in Russellville, Kentucky, on the 20th of March 1812, and graduated at West Point in 1832, but resigned his commission in 1833. He re-entered the army as a captain of mounted rifles in the Mexican War, served with distinction, and was breveted major for bravery at Contreras and Churubusco. After the war he remained in the army, and in 1856 attained the rank of lieutenant-colonel. In June 1861 he resigned, and entered the service of the Confederacy. He was commissioned major-general and given a command in south-east Kentucky and Tennessee, but after the defeat of his forces by General George H. Thomas at Mill Springs (January 9, 1862), he was censured and gave up his command. He served subsequently as a volunteer aide on the staff of Gen. John S. Williams. From 1867 to 1871 he was state librarian of Kentucky. He died at Danville, Kentucky, on the 27th of November 1880.

Another son, **THOMAS LEONIDAS CRITTENDEN** (1815-1893), soldier, was also born at Russellville, Kentucky. He studied law, and practised with his father, and in 1842 became commonwealth's attorney. He served in the Mexican War as a lieutenant-colonel of Kentucky volunteers, and was an aide on Gen. Zachary Taylor's staff at the battle of Buena Vista. From 1849 to 1853 he was United States consul at Liverpool, England. Like his father, he was a strong Union man, and in September 1861 he was commissioned by President Lincoln a brigadier-general of volunteers. He commanded a division at Shiloh, for gallantry in which battle he was promoted major-general in July 1862. He was in command of a corps in the army of the Ohio under Gen. D. C. Buell, and took part in the battles of Stone River

and Chickamauga. Subsequently he served in the Virginia campaign of 1864. He resigned his commission in December 1864, but in July 1866 entered the regular army with the rank of colonel of infantry, receiving the brevet of brigadier-general in 1867, served on the frontier and in several Indian wars, and retired in 1881. He died on the 23rd of October 1893.

**CRIVELLI, CARLO**, Venetian painter, was born in the earlier part of the 15th century. The only dates that can with certainty be given are 1468 and 1493; these are respectively the earliest and the latest years signed on his pictures—the former on an altar-piece in the church of San Silvestro at Massa near Fermo, and the latter on a picture in the Oggioni collection in Milan. Though born in Venice, Crivelli seems to have worked chiefly in the March of Ancona, and especially in and near Ascoli; there are only two pictures of his proper to a Venetian building, both of these being in the church of San Sebastiano. He is said to have studied under Jacobello del Fiore, who was painting as late at any rate as 1436; at that time Crivelli was probably only a boy. The latter always signed as "Carolus Crivellus Venetus"; from 1490 he added "Miles," having been then knighted ("Cavalière") by Ferdinand II. of Naples. He painted in tempera only, and is seen to most advantage in subject pictures of moderate size. He introduced agreeable landscape backgrounds; and was particularly partial to giving fruits and flowers (the peach is one of his favourite fruits) as accessories, often in pendent festoons. The National Gallery in London is well supplied with examples of Crivelli; the "Annunciation," and the "Beato Ferretti" (of the same family as Pope Pius IX.) in religious ecstasy, may be specified. Another of his principal pictures is in San Francesco di Matelica; in Berlin is a "Madonna and Saints" (1491); in the Vatican Gallery a "Dead Christ," and in the Brera of Milan the painter's own portrait, with other examples. Crivelli is a painter of marked individuality,—hard in form, crudely definite in contour; stern, forced, energetic, almost grotesque and repellent, in feature and expression, and yet well capable of a prim sort of prettiness; simply vigorous in his effect of detachment and relief, and sometimes admitting into his pictures objects actually raised in surface; distinct and warm in colour, with an effect at once harsh and harmonious. His pictures gain by being seen in half-light, and at some little distance; under favouring conditions they grip the spectator with uncommon power. Few artists seem to have worked with more uniformity of purpose, or more forthright command of his materials, so far as they go. It is surmised that Carlo was of the same family as the painters Donato Crivelli (who was working in 1459, and was also a scholar of Jacobello), and Vittorio Crivelli. Pietro Alamanni was his pupil.

See, along with Crowe and Cavalcaselle, Berenson, *Venetian Painters of the Renaissance* (1899); Morelli, *Italian Painters* (1892-1893); Rushforth, *Carlo Crivelli* (1900). (W. M. R.)

**CROATIA-SLAVONIA** (Serbo-Croatian *Hrvatska i Slavonija*; Hung. *Horvát-Szlavonország*; Ger. *Kroatien und Slavonien*), a kingdom of the Hungarian monarchy; bounded on the N. by Carniola, Styria and Hungary proper; E. by Hungary and Serbia; S. by Serbia, Bosnia and Dalmatia; and W. by the Adriatic Sea, Istria and Carniola. Until 1881 Croatia, in the N.W. of this region, was divided from Slavonia, in the N.E., by a section of the Austrian Military Frontier. This section is now the county of Bjelovar, and forms part of the united kingdom of Croatia-Slavonia. The river Kulpa, which bisects the county of Agram, is usually regarded as the north-eastern limit of the Balkan Peninsula; and thus the greater part of Croatia, lying south of this river, falls within the peninsular boundary, while the remainder, with all Slavonia, belongs to the continental mainland. According to the official survey of 1900, the total area of the country is 16,423 sq. m. The Croatian littoral extends for about 90 m. from Fiume to the Dalmatian frontier. A narrow strait, the Canale della Morlacca (or della Montagna), separates it from Veglia, Arbe, Pago and other Istrian or Dalmatian islands. The city and territories of Fiume, the sole important harbour on this coast, are included in Hungary proper, and controlled by the Budapest government. Westward from

Warasdin, and along the borders of Styria, Carniola, Istria, Dalmatia and north-western Bosnia, the frontier is generally mountainous and follows an irregular course. The central and eastern region, situated between the Drave and Danube on the north, and the Save on the south, forms one long wedge, with its point at Semlin.

*Physical Features.*—Croatia-Slavonia is naturally divided into two great sections, the highlands of the west and the lowlands of the east.

The plateau of the Istrian Karst is prolonged in several of the bare and desolate mountain chains between the Save and the Adriatic, notably the Great and Little Kapella (or Kapela), which link together the Karst and the Dinaric Alps, culminating in Biela Lažica (5020 ft.); the Plješevica or Piševica Planina (5410 ft.), overlooking the valley of the river Una; and the Velebit Planina, which follows the westward curve of the coast, and rises above the sea in an abrupt wall, unbroken by any considerable bay or inlet. As it skirts the Dalmatian border, this range attains its greatest altitude in the adjacent peaks of Sveto Brdo (5751 ft.), and Vakanski Vrh (5768 ft.). Large tracts of the Croatian highlands are well-nigh waterless, and it is only in the more sheltered hollows that sufficient soil collects for large trees to flourish. In northern Croatia and Slavonia the mountains are far more fertile, being often densely wooded with oaks, beeches and pines. They comprise the Uskokan Gebirge, or Uskok Mountains, named after the piratical Uskoks (*q.v.*) of Zengg, who were deported hither after the fall of their stronghold in 1617; the Warasdin Mountains, with the peak of Ivansčica (3478 ft.); the Agram Mountains, culminating in Sljeme or Slema (3306 ft.), and including the beautiful stretches of Alpine pasture known as the Zagorje, or "land beyond the hills"; the Bilo Gebirge, or White Mountains, a low range of chalk, and, farther to the south, several groups of mountains, among which Psunj (3228 ft.), Papuk (3217 ft.), Crni Vrh (2833 ft.), and the Ravna Gora (2808 ft.) are the chief summits. All these ranges, except the Uskokan Gebirge, constitute the central watershed of the kingdom, between the Drave and Save. In the east Slavonian county of Sirmia<sup>1</sup> the Fruška Gora or Vrdnik Mountains rise to a height of 1768 ft. along the southern bank of the Danube, their picturesque vineyards and pine or oak woods contrasting strongly with the plains that surround them.

The lowlands, in the valleys of the Drave, Danube, Save and Kulpa, belong partly to the great Hungarian Plains, or Alföld. Besides the sterile and monotonous steppes, valuable only as pasture, and so sparsely populated that it is possible to travel for many hours without encountering any sign of human life except a primitive artesian well or a shepherd's hut, there are wide expanses of fen-country, regularly flooded in spring and autumn. The marshes which line the Save below Sissek are often impassable except at Brod and Mitroviča, and the river is constantly scooping out fresh channels in the soft soil, only to abandon each in turn. The total area liable to yearly inundation exceeds 200 sq. m. But along the Drave and Danube the plains are sometimes strikingly fertile, and yield an abundance of grain, fruit and wine.

The main rivers of Croatia-Slavonia, the Danube, Drave and Save, are fully described under separate headings. After reaching Croatian territory 13 m. N.W. of Warasdin, the Drave flows along the northern frontier for 155 m., receiving the Bednja and Karasnica on the right, and falling, near Esseg, into the Danube, which serves as the Hungaro-Slavonian boundary for an additional 116 m. The Save enters the country 16 m. W. of Agram, and, after winding for 106 m. S.E. to Jasenovac, constitutes the southern frontier for 253 m., and meets the Danube at Belgrade. It is joined by the Sotla, Krapina, Lonja, Ilova, Pakra and Oljana, which drain the central watershed; but its only large tributaries are the Una, a Bosnian stream, which springs in the Dinaric Alps, and skirts the Croatian border for 40 m. before entering the Save at Jasenovac; and

<sup>1</sup> Also written *Sirmia* and *Sirmium*; Serbo-Croatian *Sriem*; Hungarian *Szerém*.

the Kulpa, which follows a tortuous course of 60 m. from its headwaters north of Fiume, to its confluence with the Save at Sissek. The Mrežnica, Dobra, Glina and Korana are right-hand tributaries of the Kulpa. In the Croatian Karst the seven streams of the Lika unite and plunge into a rocky chasm near Gospić, and the few small brooks of this region usually vanish underground in a similar manner. Near Fiume, the Recina, Rjeka or Fiumara falls into the Adriatic after a brief course. There is no large lake in Croatia-Slavonia, but the upland pools and waterfalls of Plitvica, near Ogulin, are celebrated for their beauty. After a thaw or heavy rain, the subterranean rivers flood the mountain hollows of the Karst; and a lake thus formed by the river Gajka, near Otočac, has occasionally filled its basin to a depth of 160 ft.

*Minerals.*—The mineral resources of the kingdom, though capable of further development, are not rich. They are chiefly confined to the mountains, where iron, coal, copper, lead, zinc, silver and sulphur are mined in small quantities. Warm mineral springs rise at Krapina, at Toplice near Warasdin, at Stubica near Agram, and elsewhere.

*Climate.*—The climate of Croatia-Slavonia varies greatly in different regions. In the Karst it is liable to sudden and violent changes, and especially to the *bora*, a fierce N.N.E. wind, which renders navigation perilous among the islands off the coast, and, in winter, blocks the roads and railway-cuttings with deep snowdrifts. The sheltered bays near Fiume enjoy an equable climate; but in all other districts the temperature in mid-winter falls regularly below zero, and the summer heats are excessive. Earthquakes are common among the mountains, and the eastern lowlands are exposed to the great winds and sandstorms which sweep down the Alföld. At Agram, during the years 1896–1900, the mean annual temperature was 52° F., with 34.6 in. of rain and snow; at Fiume, the figures for the same period were 57° and 71 in.

*Agriculture.*—The agricultural inquiry of 1895 showed that 94.5% of the country consisted of arable land, gardens, vineyards, meadows, pastures and forests; but much of this area must be set down as mountainous and swampy pasture of poor quality. The richest land occurs in the Zagorje and its neighbourhood, in the hills near Warasdin and in the northern half of Sirmia. The Karst and the fens are of least agricultural value. Indian corn heads the list of cereals, but wheat, oats, rye and barley are also cultivated, besides hemp, flax, tobacco and large quantities of potatoes. The extensive vineyards were much injured by *phylloxera* towards the close of the 19th century. The Slavonian plum orchards furnish dried prunes, besides a kind of brandy largely exported under the name of *slivovits* or *shlivovitsa*. Near Fiume the orange, lemon, pomegranate, fig and olive bear well; mulberries are planted on many estates for silkworms; and the heather-clad uplands of the central region favour the keeping of bees. Large herds of swine fatten in the oak and beech forests; and dairy-farming is a thriving industry in the highlands between Agram and Warasdin, where, during the last years of the 19th century, systematic attempts were made to replace the mountain pastures by clover and sown grass. The proportion of sheep to other live-stock is lower than in most of the South Slavonic lands, and the scarcity of goats is also noteworthy. Horsebreeding is a favourite pursuit in Slavonia; and between 1900 and 1902 many thousands of remounts were shipped to the British army in South Africa. The local administration endeavours to better the quality of live-stock by importing purer breeds, distributing prizes, and other measures; but the native farmers are slow to accept improvements.

*Forests.*—Forests, principally of oak, pine and beech, covered 3,734,000 acres in 1895, about one-fifth being state property. Especially valuable are the Croatian oak-forests, near Agram and Sissek. Timber is exported from Fiume and down the Danube.

*Industries.*—Apart from the distilleries and breweries scattered throughout the country, the rude flour-mills which lie moored in the rivers, and a few glass-works, saw-mills, silk-mills and tobacco factories, the chief industrial establishments of Croatia-Slavonia are at Agram, Fiume, Semlin, Buccari and Porto Ré. Only 8.3 of the population was, in 1900, engaged in industries other than farming, which occupied 85.2%. The exports mainly consist of foodstuffs, especially grain, of live-stock, especially pigs and horses, and of timber. The imports include textiles, iron, coal, wine and colonial products; with machinery and other finished articles. Goods in transit to and from Hungary figure largely in the official returns for Fiume<sup>2</sup> and Semlin, which are the centres of the foreign trade. In 1900 Croatia-Slavonia possessed 253 banking establishments.

*Communications.*—The commerce of the country is furthered by upwards of 2000 m. of carriage-roads, the most remarkable of these

<sup>2</sup> It is impossible to exclude Fiume from any survey of Croatian trade, although Fiume belongs politically to Hungary proper, and is the main outlet for Hungarian emigration and maritime commerce.

being the Maria Louisa, which connects Karlstadt with Fiume, and the Josephina, which passes inland from Zengg. Many excellent highways were built for strategic purposes before the abolition of the Military Frontier in 1881. The railways, which are all owned and managed by the Hungarian state, intersect most parts of the country except the mountains south of Ogulin, where there is, nevertheless, a considerable traffic over the passes into Dalmatia and Bosnia. Agram is the principal railway centre, from which lines radiate S. W. to Fiume, W. into Austria, N.N.E. to Warasdin and into Hungary, and S.E. into Bosnia by way of Kostajnica. The main line eastward from Agram passes through Brod, where it meets the Bosnian system, and on to Belgrade; throwing out two branch lines to Brčka and Samac in Bosnia, and several branches on the north, which traverse the central watershed, and cross the Hungarian frontier at Zákány, Barcs, Esseg, Erdar and Peterwardein. Above Agram the Save is used chiefly for floating rafts of timber; east of Sissek it is navigable by small steamboats, but, despite its great volume, the multitude of its perpetually shifting sandbanks interferes greatly with traffic. Steamers also ply on the Una, the Drave below Barcs, and the Danube. The marshes of Syrma are partially drained by the so-called "Canal of Probus," the one large artificial waterway in the country, said to have been cut by the Romans in the 3rd century.

**Chief Towns.**—The principal towns are Agram, the capital, with 61,002 inhabitants in 1900; Esseg, the capital of Slavonia (24,930); Semlin (15,079); Mitrovica (11,518); Warasdin (12,930); Karlstadt (7396); Brod (7310); Sissek (7047); Djakovo (6824); Karlowitz (5643); Peterwardein (5019); Zengg (3182); and Buccari (1870). These are described in separate articles. The centre of the coasting trade is Novi, and other small seaports are San Giorgio (*Sveto Juraj*), Porto Ré (*Kraljevica*) and Carlopago. Agram, Gospić (10,799), Ogulin (8699), Warasdin and Bjelovar (6056) are respectively the capitals of the five counties which belong to Croatia proper,—Agram (Hung. *Zágráb*), Modruš-Fiume, Lika-Krbava, Warasdin (*Varasd*) and Bjelovar (*Bjelodr-Körös*); while the capitals of the three Slavonian counties, Virovitica (*Veráče*), Požega (*Possega*) and Syrma (*Szerém*), are Esseg, Požega (5000) and Semlin.

**Population and National Characteristics.**—The population rose from 1,892,499 in 1881 to 2,416,304 in 1900, an increase of little less than one-third, resulting from a uniformly low death rate, with a high marriage and birth rate, and characterized by that preponderance of male over female children which is common to all the South Slavonic lands. More than 75% of the inhabitants are Croats, the bulk of the remainder being Serbs, who predominate in eastern Slavonia. Outside Croatia-Slavonia, the Croats occupy the greater part of Dalmatia and northern Bosnia. There are large Croatian settlements in the south of Hungary, and smaller colonies in Austria. The numbers of the whole nation may be estimated at 3,500,000 or 4,000,000. The distinction between Croats and Serbs is religious, and, to a less extent, linguistic. Croats and Serbs together constitute a single branch of the Slavonic race, frequently called the Serbo-Croatian branch. The literary language of the two nations is identical, but the Croats use the Latin alphabet,<sup>1</sup> while the Serbs prefer a modified form of the Cyrillic. The two nations have also been politically separated since the 7th century, if not for a longer period; but this division has produced little difference of character or physical type. Even the costume of the Croatian peasantry, to whom brilliant colours and intricate embroideries are always dear, proclaims their racial identity with the Serbs; their songs, dances and musical instruments, the chief part of their customs and folk-lore, their whole manner of life, so little changed by its closer contact with Western civilization, may be studied in Serbia (*q.v.*) itself. In both countries rural society was based on the old-fashioned household community, or *zadruga*, which still survives in the territories that formed the Military Frontier, though everywhere tending to disappear and be replaced by individual ownership. The Croatian peasantry are least prosperous in the riverside districts, where marsh-fevers prevail, and especially beside the Save. Even in many of the towns the houses are mere cabins of wood and thatch. As in Serbia, there is practically no middle class between the peasants and the educated minority; and the commercial element consists to a great extent of foreigners, especially Germans, Hungarians, Italians and Jews. Numerically this

<sup>1</sup> It is important to notice the value of the following letters and signs, which recur frequently:—*c* = *ts*; *č* = *ch* (hard); *ć* = *ch* (soft); *j* = *y*, or *j* in German; *š* = *sh*; *ž* = *zh*, or *j* in French.

alien population is insignificant. The Italians are chiefly confined to the coast; the Germans congregate at Semlin and Warasdin; the Slovenes are settled along the north-western frontier, where they have introduced their language, and so greatly modified the local dialect; the gipsies wander from city to city, as horse-dealers, metal workers or musicians; there are numerous Moravian and Bohemian settlements; and near Mitrovica there is a colony of Albanians. It is impossible to give accurate statistics of the alien population; for, in the compilation of the official figures, language is taken as a test of nationality, an utterly untrustworthy method in a country where every educated person speaks two or three languages. Croatian nationalists also maintain that official figures are systematically altered in the Hungarian interest.

**Constitution and Government.**—By the fundamental law of the 21st of December 1867 Austria-Hungary was divided, for purposes of internal government, into Cisleithania, or the Austrian empire, and Transleithania, or the kingdoms of Hungary and Croatia-Slavonia. In theory the viceroy, or *ban* of Croatia-Slavonia is nominated by the crown, and enjoys almost unlimited authority over local affairs; in practice the consent of the crown is purely formal, and the *ban* is appointed by the Hungarian premier, who can dismiss him at any moment. The provincial government is subject to the *ban*, and comprises three ministries—the interior, justice, and religion and education,—for whose working the *ban* is responsible to the Hungarian premier, and to the national assembly of Croatia-Slavonia (*Narodna Skupština*). This body consists of a single chamber, composed partly of elected deputies, partly of privileged members, whose numbers cannot exceed half those of the deputies. There are 69 constituencies, besides the 21 royal free cities which also return deputies. Electors must belong to certain professions or pay a small tax. The privileged members are the heads of the nobility, with the highest ecclesiastics and officials. As a rule, they represent the "Magyarist" section of society, which sympathizes with Hungarian policy. The chamber deals with religion, education, justice and certain strictly provincial affairs, but even within this limited sphere all its important enactments must be countersigned by the minister for Croatia-Slavonia, a member, without portfolio, of the Hungarian cabinet. At the polls, all votes are given orally, a system which facilitates corruption; the officials who control the elections depend for their livelihood on the *ban*, usually a Magyarist; and thus, even apart from the privileged members, a majority favourable to Hungary can usually be secured. The constitutional relations between Hungary and Croatia-Slavonia are regulated by the agreement, or *nagoda*, of 1868. This instrument determines the functions of the *ban*; the control of common interests, such as railways, posts, telegraphs, telephones, commerce, industry, agriculture or forests; and the choice of delegates by the chamber, to sit in the Hungarian parliament. See also below, under *History*.

For administrative purposes Croatia-Slavonia is divided into 8 rural counties, already enumerated; besides the 4 urban counties, or municipalities of Agram, Semlin, Warasdin and Esseg. These are subdivided into rural and urban communes, each with its representative council. The affairs of each rural county are managed by an assembly chosen for 6 years, which comprises not only elected members, but delegates from all the cities except Agram and Esseg, with certain high ecclesiastics and officials.

The highest judicial authority is the supreme court or Septemviral Table, which sits at Agram, and ranks above the royal courts of appeal, the county courts of first instance, and the district courts or magistracies.

Fully four-fifths of the population belong to the Roman Catholic Church, which has an archbishop at Agram and bishops at Zengg and Djakovo. There are about 12,000 Greek Catholics, with a bishop at Kreuz (*Križevac*). The Serb congregations, who had previously been classed as Orthodox Greek, were officially recognized as members of the Orthodox Church of Serbia after 1883. Their episcopal sees of Karlowitz and Pakrac depend upon the metropolitanate of Belgrade; but from 1830 to 1838 Karlowitz was itself the headquarters of the Servian Church.

During the 19th century strenuous efforts to better the state of education were made by Bishop Strossmayer (1815–1905) and other

reformers; but, although some success was achieved, only one-third of the population could read and write in 1900. Foremost among the educational institutions is the South Slavonic Academy of Sciences and Arts (*Jugoslavenska Akademija Znanosti i Umjetnosti*), founded by Strossmayer and others in 1867, as an improvement on a learned society which had existed since 1836. The academy is the headquarters of the nationalist propaganda. Its numerous publications, though sometimes biased by political passion, throw much light on Serbo-Croatian history, law, philology and kindred topics. Agram University, founded in 1874, possesses three faculties—theology, philosophy and law; but, unlike other Hungarian universities, it lacks a faculty of medicine. Its average number of students varies from 300 to 350. In 1900 there were also 19 *real-gymnasias*, teaching science, art and modern languages, as well as classics and mathematics; 1400 elementary schools; and a few special institutions, such as the naval and military academies of Fiume, ecclesiastical seminaries and commercial colleges. In almost every case the language of instruction is Serbo-Croatian. The development of higher education, without a corresponding advance of technical education, has created an intellectual class, comprising many men of letters, and several painters, musicians and sculptors, though none of great eminence; it also tends to produce many aspirants to official or professional careers, who find employment difficult to obtain. The want of a strong native middle class may partly be traced to this tendency.

### History.

Medieval historians did not use the terms Croatia and Slavonia in their present sense. The Croatia of the middle ages comprised north-western Bosnia, Turkish Croatia, and the region now known as Upper Croatia. The whole country between the Drave and Save, thus including a large part of modern Croatia, was called in Latin *Slavonia*, in German *Windisches Land*, and in Hungarian *Tótország*, to distinguish it from the territories in which the Croats were racially supreme (*Horvátország*). At the time of their conquest by the Romans (35 B.C.) both these divisions were occupied by the Pannonians, who in Slavonia had displaced an older population, the Scordisci; and both were included in the Roman province of Pannonia Inferior, although Slavonia had the distinctive name of Pannonia Savia (see PANNONIA). When the Roman dominions were broken up in A.D. 395, Croatia-Slavonia remained part of the Western empire. The Ostrogoths overran it in 489; in 535 it was annexed by Justinian; in 568 it was conquered by the Avars. These were in turn expelled from Croatia by the Croats, a Slavonic people from the western Carpathians, who, according to some authorities, had occupied the territories of the Marcomanni in Bohemia, and been driven thence in the 6th century by the Czechs. The main body of the Croats, whose tribal and racial names respectively are perpetuated in the names of Croatia and Slavonia, entered Croatia between 634 and 638, and were encouraged by the emperor Heraclius to attack the Avars. Smaller bodies had led the way southwards since 548. The Croats formed the western division of the great migratory horde of Serbo-Croats which colonized the lands between Bulgaria and the Adriatic. Contemporary chroniclers called them *Chroboti*, *Belochroboti* ("White Croats"), *Chrovati*, *Horvati*, or by some similar Latin or Byzantine variant of the Slavonic *Khrovaty*. The Croats occupied most of the region now known as Croatia-Slavonia, Dalmatia, and north-western Bosnia, displacing or absorbing the earlier inhabitants everywhere except along the Dalmatian littoral, where the Italian city-states usually maintained their independence, and in certain districts of Slavonia, where, out of a mixed population of Slavonic immigrants, Avars and Pannonians, the Slavs, and especially the Serbo-Croats, gradually became predominant. The Croats brought with them their primitive tribal institutions, organized on a basis partly military, partly patriarchal, and identical with the Zhupanates of the Serbs (see SERBIA); agriculture, war and hunting were their chief pursuits. Although they at first acknowledged no alien sovereign, they passed gradually under Italian influence in the extreme west, and under Byzantine influence in the south and south-east. In 806 the northern and north-eastern districts were added to the empire of the Franks, and thus won for the Western Church. Frankish predominance was long commemorated by the name Francochorion, given by the Byzantines

to Syrmia; it is still commemorated by the name Fruška Gora, "Mountains of the Franks," in that province.

*The Croatian Kingdom: c. 910-1091.*—In 877 the Croats were temporarily subdued by the Byzantine emperor, but after successive insurrections which tended to centralize their loosely knit tribal organization, and to place all power in the hands of a military chief, they regained their independence and founded a national kingdom about 910. It is probable that Tomislav or Timislav, who had led their armies to victory, assumed the title of king in that year. Some authorities, however, state that Tomislav only bore the title of *veliki župan* or "paramount chief," and was only one in a long line of princes which can be traced without interruption back to 818. On this view, Držislav (c. 978-1000) was the first king properly so called. But Tomislav, whatever his official style, was certainly the first of a series of independent national rulers which lasted for nearly two centuries. The records of this period, regarded by many Croats as the golden age of their country, are often scanty, and its chronology is still unsettled. Little is known of Trpimir, who preceded Držislav, or of Stephen I. (1035-1058), but a few of the kings gained a more lasting fame by their success in war and diplomacy. Among these were Krešimir I. (c. 940-946), his successor Miroslav, and especially Krešimir II., surnamed the Great (c. 1000-1035), who harried the Bulgarians, at that time a powerful nation, and conquered a large part of Dalmatia, including some of the Italian cities. Already, under his predecessors, the Croats had built a fleet, which they used first for piracy and afterwards for trade. Their skill in maritime affairs, exemplified first in the 9th century by the pagan corsairs of the Narenta (see DALMATIA: History), and later by the numerous Dalmatian and Croatian sailors who served in the navies of Venice and Austria, is remarkable in a Slavonic people, and one which had so recently migrated from central Europe. At the end of the 10th century they even for a short period exacted tribute from Venice, but their power was temporarily destroyed in 1000, when the Venetians captured and sacked Biograd or Belgrade, the Italian Zaravecchia. This Dalmatian port was not only the Croatian arsenal, but the seat of the kings, who here sought to enhance their dignity by borrowing the grandiose titles and elaborate procedure of the Byzantine court. Krešimir II. and Krešimir Peter (c. 1058-1073), the hero of many national legends and lays, restored the naval power of the Croats. After the death of Krešimir Peter, Slavic or Slaviža reigned until 1076, when he was succeeded by Zvonimir (Svinimir or Zvonimir) Demetrius. Zvonimir was crowned by the legate of Pope Gregory VII., and appears to have been regarded as a vassal of the papacy. Both he and Stephen II., a nephew of Krešimir II., died in 1089.

*Hungarian Supremacy: 1091-c. 1526.*—Amid the strife of rival claimants to the throne, Helena, the widow of Stephen, appealed for aid to her brother Ladislaus I., king of Hungary. Ladislaus took possession of the country in 1091. He founded the bishopric of Agram and introduced Hungarian law. His death in 1095 was the signal for a nationalist insurrection, but after two years the rebels were crushed by his successor Coloman. This monarch reorganized the administration on a system which has been maintained, with modifications in detail, by almost all subsequent rulers. He respected the existing institutions of the conquered territory so far as to leave its autonomy in domestic affairs intact; but delegated his own sovereignty, and especially the control of foreign affairs and war, to a governor known as the ban (*q.v.*). This office was sometimes held by princes of the royal house, often by Croatian nobles. Coloman also extended his authority over Dalmatia and the islands of the Quarnero, but the best modern authorities reject the tradition that in 1102 he was crowned king of Croatia, Slavonia and Dalmatia. In 1127 Syrmia, which had been annexed to Bulgaria from about 700 to 1018, and to the Eastern empire from 1019, was united to Slavonia. The Hungarian government left much liberty to the Croatian nobles, a turbulent and fanatical class, ever ready for civil war, rebellion or a campaign against the Bosnian heretics. Their most powerful leaders were the counts of Zrin and Bribir (or Brebir), whose surname was Šubić. This

family played an important part in local politics from the 13th century to 1670, when Peter Šubić was its last member to hold the office of ban. Paul Šubić (d. 1312) and Mladen Šubić (d. 1322) even for a short period united Croatia, Slavonia, Bosnia and part of Dalmatia under their own rule. From 1322 to 1326 the Croatian nobles successfully withstood the armies of Hungary and Bosnia; from 1337 to 1340, instigated by the Vatican, they carried on a crusade against the Bosnian Bogomils; and in the Krajina (Turkish Croatia) hostilities were resumed at intervals until the Turkish conquest.

*The Turkish Occupation: c. 1526-1718.*—Here, as elsewhere, the Ottoman invasion was facilitated by the feuds of the Christian sects. When King Matthias Corvinus undertook to defend Slavonia in 1490 it was too late; Matthias lost Syrmia and died in the same year. His successor Ladislaus of Poland (1490-1516) added Slavonia to the kingdoms named in the royal title, which now included the words "King of Dalmatia and Croatia and Slavonia" (*Rex Dalmatiae et Croatiae et Slavoniae*). But he failed to repel the Turks, who in 1526 destroyed the power of Hungary at the battle of Mohács. In 1527 the Croats were compelled to swear allegiance to Ferdinand I. of Austria, who had been elected king of Hungary. Ferdinand founded the generalcy of Karlstadt and thus laid the foundation of the military frontier. The provinces of Agram, Warasdin and Kreutz, previously included in Slavonia, were added to Croatia, to counterbalance the loss of territory in the Krajina. Throughout the century the Turks continued to extend their conquests until, in 1606, the emperor retained only western Croatia, with the cities of Agram, Karlstadt, Warasdin and Zengg. During the same period the doctrines of the Reformation had spread among the Croats; but they were forcibly suppressed in 1607-1610. The military occupation by the Turks left little permanent impression; colonization was never attempted; and the continuous wars by which the victors strove to secure or enlarge their dominions north of the Save left no time for the introduction of Moslem religion or civilization among the vanquished. Thus in the reconquest of Croatia-Slavonia there was none of the local opposition which afterwards hindered the Austrian occupation of Bosnia. The successes of Prince Eugene in 1697 led two years later to the peace of Carlowitz, by which the Turks ceded the greater part of Slavonia and Hungary to Austria; and the remainder was surrendered in 1718 by the treaty of Passarowitz. Only Turkish Croatia henceforth remained part of the Ottoman empire.

*Austrian and French Supremacy: 1718-1814.*—Austrian influence predominated throughout Croatia-Slavonia during most of the 18th century, although Slavonia was constitutionally regarded as belonging to Hungary. Despite Magyar protests the misleading name "Croatia" was popularly and even in official documents applied to the whole country, including the purely Slavonian provinces of Virovitica, Požega and Syrmia. From 1767 to 1777 Croatia, Slavonia and Dalmatia were collectively named Illyria, and governed from Vienna, but each of these divisions was subsequently declared a separate kingdom, with a separate administration, while the military frontier remained under military rule. In 1776 the Croatian seaboard, which had previously been under the same administration as the rest of the Austrian coast, was annexed to Croatia, but three years later Fiume was declared an integral part of Hungary. These administrative changes, and especially the brief existence of united "Illyria," stimulated the dormant nationalism of the Croats and their jealousy of the Magyars. In 1809 Austria was forced to surrender to Napoleon a large part of Croatia, with Dalmatia, Istria, Carinthia, Carniola, Görz and Gradisca. These territories received the name of the Illyrian Provinces, and remained under French rule until 1813. All the Croats capable of service were enrolled under the French flag; their country was divided for administrative purposes into *Croatie civile* and *Croatie militaire*. In 1814 Dalmatia was incorporated in Austria, while Istria, Carinthia, Carniola, Görz and Gradisca became the Illyrian kingdom of Austria, and retained their united government until 1849. Croatia and Slavonia were

declared appanages of the Hungarian crown—*partes adnexae*, or subject provinces, according to the Magyars; *regna sociata*, or allied kingdoms, according to their own view. Each phrase afterwards became the watchword of a political party: neither is accurate. The Croats preserved their local autonomy, the use of their language for official purposes, their elected diet and other ancient institutions, but Hungarian control was represented by the ban.

*The National Revival.*—The Croats acquiesced in their position of inferiority until 1840, when the Magyars endeavoured to introduce Hungarian as the official language. A nationalist or "Illyrist" party was formed under Count Drašković and Bishop J. Strossmayer (*q.v.*) to combat Hungarian influence and promote the union of the "Illyrian" Slavs, *i.e.* the Slovenes, Croats and Serbs. Ljudevit Gaj, the leading Croatian publicist, strongly supported the movement. The elections of 1842 were marked by a series of sanguinary conflicts between Illyrists and Magyarists, but not until 1848 were the Illyrists returned to office. One of their leaders, Baron Josef Jellachich, was appointed ban in 1848. He strongly advocated the union of Croatia with Carinthia, Carniola and Styria, but found his policy thwarted as much by the apathy of the Slovenes as by the hostility of the Magyars. A Croatian deputation was received at Innsbruck by Ferdinand V., but before its arrival the Hungarians had obtained a royal manifesto hostile to Illyrism. But failure only increased the agitation among the southern Slavs; all attempts at mediation proved unsuccessful, and on the 31st of August the Croats claimed to have convinced the king that justice was on their side. On the 11th of September the advance-guard of their army crossed the Drave under the command of Jellachich. On the 29th they were driven back from Pákozd by the Hungarians, and retired towards Vienna; they subsequently aided the Austrian army against the Hungarian revolutionaries (see JELLACHICH, JOSEF, and HUNGARY: *History*). The constitution of 1849 proclaimed Croatia and Slavonia separated from Hungary and united as a single Austrian crownland, to which was annexed the Croatian littoral, including Fiume. Austrian supremacy lasted until 1867; no ban was appointed, and owing to the suspension of local autonomy from 1850 to 1860 this period is known as "the ten years of reaction." It was ended by the celebrated "October Diploma" of the 20th of October 1860, which promised the restoration of constitutional liberty. But the so-called "Constitution of February" (21st February 1861) placed all practical power in the hands of an executive controlled by the government at Vienna. The newly elected diet was soon dissolved for its advocacy of a great South Slavonic confederation under imperial rule, and no other was elected until 1865.

From 1865 to 1867 Strossmayer and the nationalists endeavoured to secure the formation of a subordinate Austrian kingdom comprising Dalmatia, Croatia-Slavonia and the islands of the Quarnero. The Magyars had, however, resolved to subject Croatia-Slavonia to the crown of St Stephen, and in 1867 had secured control of the finances and electoral machinery. The office of ban was revived, and its holder, Baron Levin Rauch, was an ardent Magyarist. At the elections of December 1867 a majority of Hungarian partisans was easily obtained, and on the 29th of January the diet passed a resolution in favour of reunion with Hungary. The whole Opposition refused to take any part in the proceedings, as a protest against the alleged illegality of the elections; but by the 25th of June the Croatian commissioners and the Hungarian government had framed a new constitution, which was ratified in September. Besides substituting Hungarian for Austrian sovereignty, it provided that the diet and the ban should control local affairs, subject to the Croatian minister in the Hungarian cabinet, and that Croatia-Slavonia should pay 55% of its revenue to Hungary for mutual and imperial expenses, but should be represented in the Hungarian parliament by thirty-six delegates, and should continue to use Serbo-Croatian as the official language. Hungary guaranteed that the 45% retained by the territorial government should be not less than two and a half million gulden (£250,000).



In May 1870 Fiume was annexed to Hungary, but in 1873 the Croats received as compensation an increase of their guaranteed revenue to £350,000, an addition of seven to the number of their representatives at Budapest, and a promise that the military frontier should be incorporated in the existing civil provinces. In 1877 a convention with Hungary regulated the control of public estates in the military frontier, and on the 15th of July 1881 the frontier, including the district of Sichelburg claimed by Carniola, was handed over to the local administration.

Meanwhile the events of 1875-1878 in the Balkans, culminating in the Austrian occupation of Bosnia and Herzegovina, revived the agitation for a "Great Croatia." A party separate from the regular Opposition, and known as the "Party of the Right," was formed to oppose the Magyarists. Its activity resulted in the riots of 1883, which were with difficulty quelled; in 1885 its leader, N. Starčević, was condemned to imprisonment for the violence of his speeches against the ban, Count Khuen-Héderváry. In 1888 the moderate Opposition also lost its leader, Bishop Strossmayer, who was censured by the king on account of his famous Panslavist telegram to the Russian Church (see STROSSMAYER). In 1889 the financial agreement with Hungary was revised and the contribution of Croatia-Slavonia to the expenses shared with Hungary or common to the whole of the Dual Monarchy was raised by 1%. This added burden combined with bad harvests, a fall in the revenue and a deficit in the budget to heighten popular discontent. Count Khuen-Héderváry was responsible for several administrative improvements, but the prosperity of the country declined from year to year. The government was accused of illegal interference with the elections, with the use of the Hungarian arms and language in official documents, and with undue harshness in the censorship of the press. In May 1903 there were outbreaks of rioting in Agram, Sissek and other towns, besides serious agrarian disturbances directed against the Magyarist landowners; in a debate in the Reichsrath (18th May) an Austrian deputy named Bianchini unsuccessfully attempted to induce the imperial government to intervene. At the end of June Count Khuen-Héderváry was made Hungarian prime minister; Count T. Pejačević succeeded him as ban, and restored quiet by promising freedom of assembly and greater liberty of the press. Since 1898 the financial agreement had only been renewed from year to year. But the estimates for 1904 revealed another heavy deficit; and this was only paid by Hungary on condition that the agreement should be renewed until the 31st of December 1913, and the contribution of 56% maintained.

The constitutional crisis of 1905 in Hungary stimulated the nationalist agitation. A congress of Croatian and Dalmatian deputies met at Spalato to advocate Serbo-Croatian unity, and in 1906 the municipality of Agram endeavoured to petition the king in favour of union with Bosnia and Herzegovina. This propaganda was severely discouraged. Baron Rauch, appointed ban in 1908, refused to summon the diet, in which he could not command a single vote, and much excitement was caused in 1909 by the trial of 57 nationalist leaders for high treason. The policy of the nationalists, who now aimed at the political union, under the king-emperor, of all Serbo-Croats in Austria-Hungary—upwards of 4,500,000—was less visionary than the older Illyrism, and less aggressively Panslavist. It no longer sought to include Carinthia, Carniola and Styria in the proposed "Great Croatia." It was opposed by Austria as tending to create a new and formidable Slavonic nation within the Dual Monarchy, and by Hungary as a menace to Magyar predominance in Transleithania.

#### *Language and Literature.*

For the place of the Croatian dialects among Slavonic languages generally, see SLAVS. The Croatian dialects, like the Servian, have gradually developed from the Old Slavonic, which survives in medieval liturgies and biblical or apocryphal writings. The course of this development was similar in both cases, except that the Croats, owing to their dependence on Austria-Hungary, were not so deeply influenced as the Serbs by

Byzantine culture in the middle ages, and by Russian linguistic forms and Russian ideas in modern times. The Orthodox Serbs, moreover, use a modified form of the Cyrillic alphabet, while the Roman Catholic Croats use Latin characters, except in a few liturgical books which are written in the ancient Glagolitic script. As the literary language of both nations is now practically the same, and is, indeed, commonly known as "Serbo-Croatian," the reader may be referred to the article *SERVIA: Language and Literature*, for an account of its history, of its chief literary monuments up to the 19th century and inclusive of Dalmatian literature, and of the principal differences between the dialects spoken in Serbia and Croatia-Slavonia.

The three most important Croatian dialects are known as the *Čakavci*, *Čakavština* or, in Servian, *Čakavski*, spoken along the Adriatic littoral; the *Štokavci* (*Štokavština*, *Štokavski*), spoken in Serbia and elsewhere in the north-west of the Balkan Peninsula; and the *Kajkavci* (*Kajkavština*, *Kajkavski*), spoken by the partly Slovene population of the districts of Agram, Warasdin and Kreuz. This classification is based on the form, varying in different localities, of the pronoun *šta*, *što*, or *kaj*, meaning "what."

The Čakavci literature includes most of the works of the Dalmatian writers of the 15th and 16th centuries—the golden age of Serbo-Croatian literature. Its history is indissolubly interwoven with that of the Štokavci, which ultimately superseded it, and became the literary language of all the Serbo-Croats, as it had long been the language of the best national ballads and legends.

Kajkavci had from about 1550 to 1830 a distinctive literature, consisting of chronicles and histories, poems of a religious or educational character, fables and moral tales. These writings possess more philological interest than literary merit, and are hardly known outside Croatia-Slavonia and the Slovene districts of Austria.

Apart from the Kajkavci dialect, the whole body of Serbo-Croatian literature up to the 19th century may justly be regarded as the common heritage of Serbs and Croats. The linguistic and literary reforms which Dossitey Obradovich and Vuk Stefanovich Karajich carried out in Servia about the close of this period helped to stimulate among the Croats a new interest in their national history, their traditions, folk-songs and folk-tales. One result of this nationalist revival was the unsuccessful attempt made between 1814 and 1830 to raise the Čakavci dialect to the rank of a distinctive literary language for Croatia-Slavonia; but the Illyrist movement of 1840 led to the adoption of the Štokavci, which was already the vernacular of the majority of Serbo-Croats. Ljudevit Gaj (1809-1872), though he failed to create an artificial literary language by the fusion of the principal dialects spoken by Serbs, Croats and Slovenes, was by his championship of Illyrism instrumental in securing the triumph of the Štokavci. Gaj was a poet of considerable talent, and one of the founders of Croatian journalism. Among other writers of the first half of the 19th century may be mentioned Ivan Mažuranić (1813-1890), whose first poems were published in the *Danica ilirska* ("Illyrian Dawnstar"), a journal founded and for a time edited by Gaj. In 1846 Mažuranić published his *Smrt Smil' Aga Čengića* ("Death of Ismail Aga Čengić"), called by Serbo-Croats the "Epos of Hate." This remarkable poem, written in the metre of the old Servian ballads, gives a vivid description of life in Bosnia under Turkish rule, and of the hereditary border feuds between Christians and Moslems. In later life Mažuranić distinguished himself as a statesman, and became ban of Croatia from 1873 to 1880. Other writers representative of Croatian literature before 1867 were the lyric poet Stanko Vraz (1810-1851) and Dragutin Rakovac (1813-1854), the author of many patriotic songs.

With the foundation of the South Slavonic Academy at Agram, in 1867, the study of science and history received a new impetus. Under the presidency of Franko Rački (1825-1894) the academy, with its journal the *Rad jugoslovenske Akademije*, became the headquarters of an active group of savants, among whom may be mentioned Vastroslav Jagić (b. 1838), sometime editor of the

*Archiv für slavische Philologie*; the historians Šime Ljubić (1822–1896) and Vjekoslav Klaić, author of several standard works on Croatia and the Croats; the lexicographer Bogoslav Šulek (1816–1895); the ethnographer and philologist Franko Karelac (1811–1874). In Dalmatia, where the Ragusan journal *Slovinac* has served, like the Agram *Rad*, as a focus of literary activity, there have been numerous poets and prose writers, associated, in many cases, with the Illyrist or the nationalist propaganda. Among these may be mentioned Count Medo Pučić (1821–1882), and the dramatist Matija Ban (1818–1903), whose tragedy *Meyrimah* is considered by many the finest dramatic poem in the Serbo-Croatian language.

**AUTHORITIES.**—For the topography, products, inhabitants and modern condition of Croatia-Slavonia, see *Bau und Bild Österreichs*, by C. Diener, F. E. Suess, R. Hoernes and V. Uhlig (Leipzig, 1903); *Die österreich-ungarische Monarchie in Wort und Bild*, vol. xxiv., edited by J. von Weilen (Vienna, 1902); *Führer durch Ungarn, Kroatien und Slavonien*, by B. Alföldi (Vienna, 1900); *Reiseführer durch Kroatien und Slavonien*, by A. Lukšić (Agram, 1893); *Vegetationsverhältnisse von Kroatien*, by A. Neilreich (Vienna, 1868); "Die Slowenen," by J. Šuman, and "Die Kroaten," by F. Staré, in vol. x. of *Die Völker Österreich-Ungarns* (Vienna, 1881–1882); *Die Serbokroaten der adriatischen Küstenländer*, by A. Weisbach (Berlin, 1884); and the map *Zemljovid Hrvatske i Slavonije*, by M. Katzenschläger (Vienna, 1895). The only detailed history is one in Serbo-Croatian, written by a succession of the highest native authorities, and published by the South Slavonic Academy (Agram, from 1861). It is largely based on the following works: *Vetera monumenta historica Hungarum sacrum illustrantia*, containing documents from the Vatican library edited by A. Theiner (Rome, 1860); *Vetera monumenta historiam Slavorum meridionalium illustrantia*, published by the South Slavonic Academy (Agram, 1863, &c.); *Jura regni Croatiae, Dalmatiae, et Slavoniae cum privilegiis*, by J. Kukuljević (Agram, 1861–1862); *Monumenta historica Slavorum meridionalium*, by V. Makushev, in Latin and Italian, with notes in Slavonic (Belgrade, 1885); *De regno Dalmatiae et Croatiae*, by G. Lucio (Amsterdam, 1666; see DALMATIA, under bibliography); *Regno degli Slavi*, by M. Orbini (Pesaro, 1601); and, for ecclesiastical history, *Illyricum sacrum*, by D. Farlati and others (Venice, 1751–1819). See also *Hrvatska i Hrvati*, by V. Klaić (Agram, 1890, &c.); and *Slavonien vom 10. bis zum 13. Jahrhundert*, translated from the Serbo-Croatian of Klaić by J. von Vojničić (Agram, 1882). (K. G. J.)

**CROCIDOLITE**, a mineral described in 1815 by M. H. Klaproth under the name *Blauisenstein* (blue ironstone), and in 1831 by J. F. Hausmann, who gave it its present name on account of its nap-like appearance (Gr. *κροκός*, nap of cloth). It is a blue fibrous mineral belonging to the amphibole group and closely related to riebeckite; chemically it is an iron sodium silicate. Its resemblance to asbestos has gained for it the name Cape Asbestos, the chief occurrence being in Cape Colony. The mineral suffers alteration by removal of alkali and peroxidation of the ferrous iron, and further by deposition of silica between the fibres, or by their replacement by silica; a hard siliceous mineral is thus formed which when polished shows, in consequence of its fibrous structure, a beautiful chatoyance or silky lustre. This is the ornamental stone which is known when blue as "hawk's-eye," and when of rich golden brown colour as "tiger-eye." The latter, which represents the final alteration of the crocidolite, has become very fashionable as "South African cat's eye," and is often termed "crocidolite," though practically only a mixture of quartz with brown oxide of iron. The following are analyses by A. Renard and C. Klement of the unaltered crocidolite and of the blue and brown products of alteration:—

	Crocidolite.	Hawk's-eye.	Tiger-eye.
Silica . . . . .	51.89	93.45	93.05
Ferric oxide . . . . .	19.22	2.41	4.94
Alumina . . . . .	..	0.23	0.66
Ferrous oxide . . . . .	17.53	1.43	..
Magnesia . . . . .	2.43	0.22	0.26
Lime . . . . .	0.40	0.13	0.44
Soda . . . . .	7.71	..	..
Potash . . . . .	0.15	..	..
Water . . . . .	2.36	0.82	0.76
Total . . . . .	101.69	98.69	100.11

Another alteration product of the crocidolite, consisting of silica and ferric hydrate, has been called griqualandite. Crocidolite and the minerals resulting from its alteration occur in seams, associated with magnetite and other iron-ores, in the jasper-slates of the Asbestos Mountains in Griqualand West, Cape Colony. It is known also from a few other localities, but only in subordinate quantity. (See CAT'S-EYE.)

**CROCKET** (Ital. *uncinetti*, Fr. *crochet*, *crosse*, Ger. *Häklein*, *Knollen*), in architecture, an ornament running up the sides of gables, hood-moulds, pinnacles, spires; generally a winding stem like a creeping plant, with flowers or leaves projecting at intervals, and terminating in a finial.

**CROCKETT, DAVID** (1786–1836), American frontiersman, was born in Greene county, Tennessee, on the 17th of August 1786. His education was obtained chiefly in the rough school of experience in the Tennessee backwoods, where he acquired a wide reputation as a hunter, trapper and marksman. In 1813–1814 he served in the Creek War under Andrew Jackson, and subsequently became a colonel in the Tennessee militia. In 1821–1824 he was a member of the state legislature, having won his election not by political speeches but by telling stories. In 1827 he was elected to the national House of Representatives as a Jackson Democrat, and was re-elected in 1829. At Washington his shrewdness, eccentric manners and peculiar wit made him a conspicuous figure, but he was too independent to be a supporter of all Jackson's measures, and his opposition to the president's Indian policy led to administration influences being turned against him with the result that he was defeated for re-election in 1831. He was again elected in 1833, but in 1835 lost his seat a second time, being then a vigorous opponent of many distinctively Jacksonian measures. Discouraged and disgusted, he left his native state, and emigrated to Texas, then engaged in its struggle for independence. There he lost his life as one of the defenders of the Alamo at San Antonio on the 6th of March 1836.

A so-called "autobiography," which he very probably dictated or at least authorized, was published in Philadelphia in 1834; a work purporting to be a continuation of this autobiography and entitled *Colonel Crockett's Exploits and Adventures in Texas* (Philadelphia, 1836) is undoubtedly spurious. These two works were subsequently combined in a single volume, of which there have been several editions. Numerous popular biographies have been written, the best by E. S. Ellis (Philadelphia, 1884).

**CROCKETT, SAMUEL RUTHERFORD** (1860– ), Scottish novelist, was born at Duchrae, Galloway, on the 24th of September 1860, the son of a Galloway farmer. He was brought up on a Galloway farm, and graduated from Edinburgh University in 1879. After some years of travel he became in 1886 minister of Penicuik, but eventually abandoned the Free Church ministry for novel-writing. The success of Mr J. M. Barrie had created a demand for stories in the Scottish dialect when Mr Crockett published his successful story of *The Stickit Minister* in 1893. It was followed by a rapidly produced series of popular novels dealing often with the past history of Scotland, or with his native Galloway. Such are *The Raiders*, *The Lilac Sun-bonnet* and *Mad Sir Uchtred* in 1894; *The Men of the Moss Hags* in 1895; *Cleg Kelly* and *The Grey Man* in 1896; *The Surprising Adventures of Sir Toady Lion* (1897); *The Red Axe* (1898); *Kil Kennedy* (1899); *Joan of the Sword Hand* and *Little Anna Mark* in 1900; *Flower o' the Corn* (1902); *Red Cap Tales* (1904), &c.

**CROCKFORD, WILLIAM** (1775–1844), proprietor of Crockford's Club, was born in London in 1775, the son of a fishmonger, and for some time himself carried on that business. After winning a large sum of money—according to one story £100,000—either at cards or by running a gambling establishment, he built, in 1827, a luxurious gambling house at 50 St James's Street, which, to ensure exclusiveness, he organized as a club. Crockford's quickly became the rage; every English social celebrity and every distinguished foreigner visiting London hastened to become a member. Even the duke of Wellington joined, though, it is averred, only in order to be able to blackball his son, Lord Douro, should he seek election. Hazard was the favourite game, and very large sums changed hands. Crockford

retired in 1840, when, in the expressive language of Captain R. H. Gronow, he had "won the whole of the ready money of the then existing generation." He took, indeed, about £1,200,000 out of the club, but subsequently lost most of it in unlucky speculations. Crockford died on the 24th of May 1844.

See John Timbs, *Club Life of London* (London, 1866); Gronow, *Celebrities of London and Paris*, 3rd series (London, 1865).

**CROCODILE**, a name for certain reptiles, taken from ancient Gr. *κορδύλος*, signifying lizard and newt; with reduplication *κορκορδύλος*, and by metathesis ultimately *κροκόδειλος*. Herodotus makes mention of them, and tells us that the Egyptian name was *champsä*. The Arabic term is *ledschun*. The same root *kar* leads through something like *kar-kar-ta*, *glakarta* (*glazard* in Breton), to *lacerta* and to "lizard." *Lacerta* in turn has become, in Spanish, *lagarto*, which, with the article, *el lagarto*, is the origin of the term "alligator." This word is, however, artificial, although now widely used; Spanish and Portuguese-speaking people in America universally call the crocodile and the alligator simply *lagarto*, which is never intended for lizard.

The Crocodilia form a separate order of reptiles with many peculiarities. The premaxillae are short and always enclose the nostrils. The posterior nares or choanae open far behind in the roof of the mouth, in recent forms within the pterygoids. The under jaws are hinged on to the quadrate bones, which extend obliquely backwards, and are immovably wedged in between the squamosal and the lateral occipital wings. The teeth form a complete series in the under jaw, and in the upper jaw on the premaxillary and maxillary bones. They are conical and deeply implanted in separate sockets. They are often shed throughout life, the successors lying on the inner side, and with their caps partly fitting into the wide open roots of the older teeth. Especially in alligators the upper teeth overlap laterally those of the lower jaw, whilst in most crocodiles the overlapping is less marked and the teeth mostly interlock, a feature which increases with the slenderness of the snout. In old specimens some of the longer, lower teeth work their tips into deep pits, and ultimately even perforate the corresponding parts of the upper jaw. The first and second vertebrae each have a pair of long, movable ribs. There is a compound abdominal sternum. The so-called pubic bones are large and movable. There are five fingers and four toes, provided with claws, excepting the outer digits.

The tongue is flat and thick, attached by its whole under surface; its hinder margin is raised into a transverse fold, which, by meeting a similar fold from the palate, can shut off the mouth completely from the wide cavity of the throat. Dorsally the posterior nares open into this cavity. Consequently the beast can lie submerged in the water, with only the nostrils exposed, and with the mouth open, and breathe without water entering the windpipe. Within the glottis is a pair of membranous folds which serve as vocal cords; all the Crocodilia are possessed of a loud, bellowing voice.

The stomach is globular, rather muscular, with a pair of tendinous centres like those of birds; its size is comparatively small, but the digestion is so rapid and powerful that every bone of the creature's prey is dissolved whilst still being stowed away in the wide and long gullet. The anal opening forms a longitudinal slit; within it, arising from its anterior corner, is the unpaired copulatory organ. The vascular system has attained the highest state of development of all reptiles. The heart is practically quadrilocular, the right and left halves being completely partitioned, except for a small communication, the *foramen Panizzae*, between the right and left aortae where these cross each other on leaving their respective ventricles. The outer ear lies in a recess which can be closed tightly by a dorsal flap of skin. The power of hearing is acute, and so is the sight, the eyes being protected by upper and lower lids and by a nictitating membrane. The skin of the whole body is scaly, with a hard, horny, waterproof covering of the epidermis, but between these mostly flat scales the skin is soft. The scutes or dermal portions of the scales are more or less ossified, especially on the back, and form the characteristic dermal armour. The skins or

"hides" of commerce consist entirely of the tanned cutis minus, the epidermis and the horny coverings of the scutes. All the Crocodilia possess two pairs of musk-glands in the skin; one is situated on the inner side of the lower jaw. The opening of the glands is slit-like and leads into a pocket, which is filled with a smeary, strongly scented matter. The other pair lies just within the lips of the cloacal opening.

Propagation takes place by eggs, which are oval, quite white, with a very hard and strong shell. Their size varies from 2 to 4 in. in length, according to the size of the species and the age of the female. She lays several dozen eggs in a carefully prepared nest. The Nile crocodile makes a hole in white sand, which is then filled up and smoothed over; the mother sleeps upon the nest, and keeps watch over her eggs, and when these are near hatching—after about twelve weeks—she removes the 18 in. or 2 ft. of sand. Other species, especially the alligators, make a very large nest of leaves, twigs and humus, scraping together a mound about a yard high and two or more yards in diameter. The eggs, in several layers, are laid near the top. The adults frequently dig long subterranean passages into the banks of streams, and, during dry seasons, they have been found deep in the hardened mud, whence they emerge with the beginning of the rains. They spend most of their time in the water, but are also very fond of basking in the hot sun on the banks of rivers or in marshes, usually with the head turned towards the water, to which they take on the slightest alarm. They can walk perfectly well, and they do so deliberately with the whole body raised a little above the ground. When their pools dry up, or when in search of new hunting-grounds, they sometimes undertake long wanderings over land. But the water is their true element. They swim rapidly, propelled by the powerful tail and by the mostly webbed limbs, or they submerge themselves, with only the tip of the nose and the eyes showing, or sometimes also the back. They then look like floating logs; and thus they float or gently approach their prey, which consists of anything they can overpower. Many a large mammal coming to drink at its accustomed place is dragged into the water by the lurking monster. Certainly there are occasional man-eaters amongst them, and in some countries they are much feared. As a rule, however, they are so wary and suspicious that they are very difficult to approach, and their haunts are so well stocked with fish and other game that they make off and hide rather than attack a man swimming in their waters. But if a dog is sent in there will be a sudden yelp, the splash from a big tail, and a widening eddy.

Crocodile stories, not all fabulous, are plentiful, and begin with one of the oldest writings in the world, the book of Job. "Canst thou draw leviathan with a hook? or his tongue with a cord which thou lettest down? . . . Lay thine hand upon him, remember the battle, do no more." This is a very interesting passage, since it can apply only to a large-sized crocodile. Now nothing is known of the occurrence of such in Arabia, but a few specimens of rather small size seem still to exist in Syria, in the Wadi Zerka, an eastern tributary of the Jordan.

Crocodiles are caught in various ways,—for instance, with two pointed sticks, which are fastened crosswise within the bait, an animal's entrails, to which is attached a rope. When the creature has swallowed the spiked bait it keeps its jaws so firmly closed that it can be dragged out of the water. A kind of plover, *Pluvianus aegyptius*, often sits upon basking crocodiles, and, since the latter often rest with gaping mouth, it is possible that these agile birds do pick the reptiles' teeth in search of parasites. Being a very watchful bird, its cry of warning, when it flies off on the approach of danger, is probably appreciated by the crocodile. But the story of the ichneumon or mongoose is a fable. Although an inveterate destroyer of eggs, this little creature prefers those of birds and the soft-shelled eggs of lizards to the very hard and strong-shelled eggs which are deeply buried in the crocodile's nest.

Considering the interest which is taken in crocodiles and their allies, on account of their size, their dangerous nature and the sporting trophies which they yield, the following "key," based upon easily ascertained characters of the skull, is given.

I. Snout very long and slender. The mandibular symphysis extends backwards at least to the fifteenth tooth.

- (a) Nasal bones very small, and widely separated from the premaxilla (which encloses the nostrils) by the maxillaries which join each other for a long distance along the dorsal mid-line. . . . *Gavialis gangeticus* of India, the "gharial" or fish-eater.
- (b) Nasal bones long, so as to be in contact with the premaxilla at the hinder corner of the nostril groove. . . . *Tomistoma schlegeli* of Borneo, Malacca and Sumatra.

II. Snout mostly triangular or rounded off. The mandibular symphysis does not reach beyond the eighth tooth.

- (a) The fourth mandibular tooth fits into a notch in the upper jaw. Crocodiles.
1. Without a bony nasal septum between the nostrils. Crocodiles.
  2. The nasal bones project through the nasal groove, forming a bony septum. *Osteolaemus frontatus* s. *tetrapsis* of West Africa.
- (b) Fourth mandibular tooth fitting into a pit in the upper jaw. Alligators.
1. Without a bony nasal septum. . . . *Caiman*, Central and South America.
  2. Nasal bones dividing the nasal groove. . . . *Alligator*, America and China.

The genus *Crocodylus* contains seven species. *C. vulgaris* or *niloticus* of most of Africa, is found from the Senegal to Egypt and to Madagascar, reaching a length of 15 ft. It has eighteen or nineteen upper and fifteen lower teeth on each side. *C. palustris*, the "mugger" or "marsh crocodile" of India and Ceylon, extends westwards into Baluchistan, eastwards into the Malay islands. It has nineteen upper and lower teeth on either side. The scutes on the neck, six in number, are packed closely together, the four biggest forming a square. The length of 12 ft. is a fair size for a large specimen. *C. porosus* or *biporcatus* is easily recognised by the prominent longitudinal ridge which extends in front of each eye. Specimens of more than 20 ft. in length are not uncommon, and a monster of 33 ft. is on record. It is essentially an inhabitant of tidal waters and estuaries, and often goes out to sea; hence its wide distribution, from the whole coast of Bengal to southern China, to the northern coasts of Australia and even to the Fiji islands. Australians are in the habit of calling their crocodiles alligators. *C. cataphractus* is the common crocodile of West Africa, easily recognised by the slender snout which resembles that of the gaviel, but the mandibular symphysis does not reach beyond the eighth tooth. *C. johnstoni* of northern Australia and Queensland is allied to the last species mentioned, with which it agrees in the slender snout. Lastly there are two species of true crocodiles in America, *C. intermedius* of the Orinoco, allied to the former, and *C. americanus* or *acutus* of the West Indies, Mexico, Central America to Venezuela and Ecuador; its characteristic feature is a median ridge or swelling on the snout, which is rather slender.

The above list shows that the usual statement that crocodiles inhabit the Old World and alligators the New World is not strictly true. In the Tertiary epoch alligators, crocodiles and long-snouted gavials existed in Europe. (H. F. G.)

**CROCOITE**, a mineral consisting of lead chromate,  $PbCrO_4$ , and crystallizing in the monoclinic system. It is sometimes used as a paint, being identical in composition with the artificial product chrome-yellow; it is the only chromate of any importance found in nature. It was discovered at Berezovsk near Ekaterinburg in the Urals in 1766; and named crocoise by F. S. Beudant in 1832, from the Greek *κρόκος*, saffron, in allusion to its colour, a name first altered to crocoisite and afterwards to crocoite. It is found as well-developed crystals of a bright hyacinth-red colour, which are translucent and have an adamantine to vitreous lustre. On exposure to light much of the translucency and brilliancy is lost. The streak is orange-yellow; hardness 2½-3; specific gravity 6.0. In the Urals the crystals are found in quartz-veins traversing granite or gneiss; other localities which have yielded good crystallized specimens are Congonhas do Campo near Ouro Preto in Brazil, Luzon in the Philippines, and Umtali in Mashonaland. Gold is often found associated with this mineral. Crystals far surpassing in beauty any previously known have been found in the Adelaide Mine at

Dundas, Tasmania; they are long slender prisms, 3 or 4 in. in length, with a brilliant lustre and colour.

Associated with crocoite at Berezovsk are the closely allied minerals phoenicochroite and vauquelinite. The former is a basic lead chromate,  $Pb_3Cr_2O_8$ , and the latter a lead and copper phosphate-chromate,  $2(Pb,Cu)CrO_4 \cdot (Pb,Cu)_2(PO_4)_2$ . Vauquelinite forms brown or green monoclinic crystals, and was named after L. N. Vauquelin, who in 1797 discovered (simultaneously with and independently of M. H. Klaproth) the element chromium in crocoite. (L. J. S.)

**CROCUS**, a botanical genus of the natural order Iridaceae, containing about 70 species, natives of Europe, North Africa, and temperate Asia, and especially developed in the dry country of south-eastern Europe and western and central Asia. The plants are admirably adapted for climates in which a season favourable to growth alternates with a hot or dry season; during the latter they remain dormant beneath the ground in the form of a short thickened stem protected by the scaly remains of the bases of last season's leaves (known botanically as a "corm"). At the beginning of the new season of growth, new flower- and leaf-bearing shoots are developed from the corm at the expense of the food-stuff stored within it. New corms are produced at the end of the season, and by these the plant is multiplied.

These crocuses of the flower garden are mostly horticultural varieties of *C. vernus*, *C. versicolor* and *C. aureus* (Dutch crocus), the two former yielding the white, purple and striped, and the latter the yellow varieties. The crocus succeeds in any fairly good garden soil, and is usually planted near the edges of beds or borders in the flower garden, or in broadish patches at intervals along the mixed borders. The corms should be planted 3 in. below the surface, and as they become crowded they should be taken up and replanted with a refreshment of the soil, at least every five or six years. Crocuses have also a pleasing effect when dotted about on the lawns and grassy banks of the pleasure ground.

Some of the best of the varieties are:—*Purple*: David Rizzio, Sir J. Franklin, purpureus grandiflorus. *Striped*: Albion, La Majestueuse, Sir Walter Scott, Cloth of Silver, Mme Mina. *White*: Caroline Chisholm, Mont Blanc. *Yellow*: Large Dutch.

The species of crocus are not very readily obtainable, but those who make a specialty of hardy bulbs ought certainly to search them out and grow them. They require the same culture as the more familiar garden varieties; but, as some of them are apt to suffer from excess of moisture, it is advisable to plant them in prepared soil in a raised pit, where they are brought nearer to the eye, and where they can be sheltered when necessary by glazed sashes, which, however, should not be closed except when the plants are at rest, or during inclement weather in order to protect the blossoms, especially in the case of winter flowering species. The autumn blooming kinds include many plants of very great beauty. The following species are recommended:—

Spring flowering:—*Yellow*: *C. aureus*, *aureus* var. *sulphureus*, *chrysanthus*, *Olivieri*, *Korolkowi*, *Balansae*, *ancyrensis*, *Susianus*, *stellaris*. *Lilac*: *C. Imperati*, *Sieberi*, *etruscus*, *vernus*, *Tomasinianus*, *banaticus*. *White*: *C. biflorus* and vars., *candidus*, *vernus* vars. *Striped*: *C. versicolor*, *reticulatus*.

Autumn flowering:—*Yellow*: *C. Scharojani*. *Lilac*: *C. asturicus*, *cancellatus* var., *cilicicus*, *byzantinus* (*iridiflorus*), *longiflorus*, *medius*, *nudiflorus*, *pulchellus*, *Salzmanni*, *sativus* vars. *speciosus*, *zonatus*. *White*: *caspius*, *cancellatus*, *hadriaticus*, *marathonisius*.

Winter flowering:—*C. hyemaeis*, *laevigatus*, *vitellinus*.

**CROESUS**, last king of Lydia, of the Mermnad dynasty, (560-546 B.C.), succeeded his father Alyattes after a war with his half-brother. He completed the conquest of Ionia by capturing Ephesus, Miletus and other places, and extended the Lydian empire as far as the Halys. His wealth, due to trade, was proverbial, and he used part of it in securing alliances with the Greek states whose fleets might supplement his own army. Various legends were told about him by the Greeks, one of the most famous being that of Solon's visit to him with the lesson

it conveyed of the divine nemesis which waits upon overmuch prosperity (Hdt. i. 29 seq.; but see SOLON). After the overthrow of the Median empire (549 B.C.) Croesus found himself confronted by the rising power of Cyrus, and along with Nabonidos of Babylon took measures to resist it. A coalition was formed between the Lydian and Babylonian kings, Egypt promised troops and Sparta its fleet. But the coalition was defeated by the rapid movements of Cyrus and the treachery of Eurybatus of Ephesus, who fled to Persia with the gold that had been entrusted to him, and betrayed the plans of the confederates. Fortified with the Delphic oracles Croesus marched to the frontier of his empire, but after some initial successes fortune turned against him and he was forced to retreat to Sardis. Here he was followed by Cyrus who took the city by storm. We may gather from the recently discovered poem of Bacchylides (iii. 23-62) that he hoped to escape his conqueror by burning himself with his wealth on a funeral pyre, like Saracus, the last king of Assyria, but that he fell into the hands of Cyrus before he could effect his purpose.<sup>1</sup> A different version of the story is given (from Lydian sources) by Herodotus (followed by Xenophon), who makes Cyrus condemn his prisoner to be burnt alive, a mode of death hardly consistent with the Persian reverence for fire. Apollo, however, came to the rescue of his pious worshipper, and the name of Solon uttered by Croesus resulted in his deliverance. According to Ctesias, who uses Persian sources, and says nothing of the attempt to burn Croesus, he subsequently became attached to the court of Cyrus and received the governorship of Barené in Media. Fragments of columns from the temple of Artemis now in the British Museum have upon them a dedication by Croesus in Greek.

See R. Schubert, *De Croeso et Solone fabula* (1868); M. G. Radet, *La Lydie et le monde grec au temps des Mermnades* (1892-1893); A. S. Murray, *Journ. Hell. Studies*, x. pp. 1-10 (1889); for the supposition that Croesus did actually perish on his own pyre see G. B. Grundy, *Great Persian War*, p. 28; Grote, *Hist. of Greece* (ed. 1907), p. 104. Cf. CYRUS; LYDIA.

**CROFT, SIR HERBERT**, Bart. (1751-1816), English author, was born at Dunster Park, Berkshire, on the 1st of November 1751, son of Herbert Croft (see below) of Stifford, Essex. He matriculated at University College, Oxford, in March 1771, and was subsequently entered at Lincoln's Inn. He was called to the bar, but in 1782 returned to Oxford with a view to preparing for holy orders. In 1786 he received the vicarage of Prittlewell, Essex; but he remained at Oxford for some years accumulating materials for a proposed English dictionary. He was twice married, and on the day after his second wedding day he was imprisoned at Exeter for debt. He then retired to Hamburg, and two years later his library was sold. He had succeeded in 1797 to the title, but not to the estates, of a distant cousin, Sir John Croft, the fourth baronet. He returned to England in 1800, but went abroad once more in 1802. He lived near Amiens at a house owned by Lady Mary Hamilton, said to have been a daughter of the earl of Leven and Melville. Later he removed to Paris, where he died on the 26th of April 1816. In some of his numerous literary enterprises he had the help of Charles Nodier. Croft wrote the Life of Edward Young inserted in Johnson's *Lives of the Poets*. In 1780 he published *Love and Madness, a Story too true, in a series of letters between Parties whose names could perhaps be mentioned were they less known or less lamented*. This book, which passed through seven editions, narrates the passion of a clergyman named James Hackman for Martha Ray, mistress of the earl of Sandwich, who was shot by her lover as she was leaving Covent Garden in 1779 (see the Case and Memoirs of the late Rev. Mr James Hackman, 1779). *Love and Madness* has permanent interest because Croft inserted, among other miscellaneous matter, information about Thomas Chatterton gained from letters which he obtained from the poet's sister, Mrs Newton, under false pretences, and used without payment. Robert Southey, when about to publish an edition of Chatterton's works for the benefit of his family, published (November 1799) details of Croft's proceedings in the *Monthly*

<sup>1</sup> This is probably a Greek legend (cf. the Attic vase of about 500 B.C. in *Journ. of Hell. Stud.*, 1898, p. 268).

*Review*. To this attack Croft wrote a reply addressed to John Nichols in the *Gentleman's Magazine*, and afterwards printed separately as *Chatterton and Love and Madness . . .* (1800). This tract evades the main accusation, and contains much abuse of Southey. Croft, however, supplied the material for the exhaustive account of Chatterton in A. Kippis's *Biographia Britannica* (vol. iv., 1789). In 1788 he addressed a letter to William Pitt on the subject of a new dictionary. He criticized Samuel Johnson's efforts, and in 1790 he claimed to have collected 11,000 words used by excellent authorities but omitted by Johnson. Two years later he issued proposals for a revised edition of Johnson's *Dictionary*, but subscribers were lacking and his 200 vols. of MS. remained unused. Croft was a good scholar and linguist, and the author of some curious books in French.

*The Love Letters of Mr H. and Miss R. 1775-1779* were edited from Croft's book by Mr Gilbert Burgess (1895). See also John Nichols's *Illustrations . . .* (1828), v. 202-218.

**CROFT, SIR JAMES** (d. 1590), lord deputy of Ireland, belonged to an old family of Herefordshire, which county he represented in parliament in 1541. He was made governor of Haddington in 1549, and became lord deputy of Ireland in 1551. There he effected little beyond gaining for himself the reputation of a conciliatory disposition. Croft was all his life a double-dealer. He was imprisoned in the Tower for treason in the reign of Mary, but was released and treated with consideration by Elizabeth after her accession. He was made governor of Berwick, where he was visited by John Knox in 1559, and where he busied himself actively on behalf of the Scottish Protestants, though in 1560 he was suspected, probably with good reason, of treasonable correspondence with Mary of Guise, the Catholic regent of Scotland; and for ten years he was out of public employment. But in 1570 Elizabeth, who showed the greatest forbearance and favour to Sir James Croft, made him a privy councillor and controller of her household. He was one of the commissioners for the trial of Mary queen of Scots, and in 1588 was sent on a diplomatic mission to arrange peace with the duke of Parma. Croft established private relations with Parma, for which on his return he was sent to the Tower. He was released before the end of 1589, and died on the 4th of September 1590.

Croft's eldest son, Edward, was put on his trial in 1589 on the curious charge of having contrived the death of the earl of Leicester by witchcraft, in revenge for the earl's supposed hostility to Sir James Croft. Edward Croft was father of Sir Herbert Croft (d. 1622), who became a Roman Catholic and wrote several controversial pieces in defence of that faith. His son Herbert Croft (1603-1691), bishop of Hereford, after being for some time, like his father, a member of the Roman church, returned to the church of England about 1630, and about ten years later was chaplain to Charles I. and obtained within a few years a prebend's stall at Worcester, a canonry of Windsor, and the deanery of Hereford, all of which preferments he lost during the Civil War and Commonwealth. By Charles II. he was made bishop of Hereford in 1661. Bishop Croft was the author of many books and pamphlets, several of them against the Roman Catholics; and one of his works, entitled *The Naked Truth, or the True State of the Primitive Church* (London, 1675), was very celebrated in its day, and gave rise to prolonged controversy. The bishop died in 1691. His son Herbert was created a baronet in 1671, and was the ancestor of Sir Herbert Croft (q.v.), the 18th century writer.

**BIBLIOGRAPHY**.—See Richard Bagwell, *Ireland under the Tudors*, vol. i. (3 vols., London, 1885); David Lloyd, *State Worthies from the Reformation to the Revolution* (2 vols., London, 1766); John Strype, *Annals of the Reformation* (Oxford, 1824), which contains an account of the trial of Edward Croft; S. L. Lee's art. "Croft, Sir James," in *Dict. of National Biography*, vol. xiii.; and for Bishop Croft see Anthony à Wood, *Athenae Oxonienses* (ed. Bliss, 1813-1820); John Le Neve, *Fasti Ecclesiae Anglicanae* (ed. by T. D. Hardy, Oxford, 1854).

**CROFT (OR CROFTS), WILLIAM** (1678-1727), English composer, was born in 1678, at Nether Ettington in Warwickshire. He received his musical education in the Chapel Royal under Dr Blow. He early obtained the place of organist of St Anne's, Soho, and in 1700 was admitted a gentleman extraordinary of the Chapel



Royal. In 1707 he was appointed joint-organist with Blow; and upon the death of the latter in 1708 he became solo organist, and also master of the children and composer of the Chapel Royal, besides being made organist of Westminster Abbey. In 1712 he wrote a brief introduction on the history of English church music to a collection of the words of anthems which he had edited under the title of *Divine Harmony*. In 1713 he obtained his degree of doctor of music in the university of Oxford. In 1724 he published an edition of his choral music in 2 vols. folio, under the name of *Musica Sacra, or Select Anthems in score, for two, three, four, five, six, seven and eight voices, to which is added the Burial Service, as it is occasionally performed in Westminster Abbey*. This handsome work included a portrait of the composer and was the first of the kind executed on pewter plates and in score. John Page, in his *Harmonia Sacra*, published in 1800 in 3 vols. folio, gives seven of Croft's anthems. Of instrumental music, Croft published six sets of airs for two violins and a bass, six sonatas for two flutes, six solos for a flute and bass. He died at Bath on the 14th of August 1727, and was buried in the north aisle of Westminster Abbey, where a monument was erected to his memory by his friend and admirer Humphrey Wyrley Birch. Burney in his *History of Music* devotes several pages of his third volume (pp. 603-612) to Dr Croft's life, and criticisms of some of his anthems. During the earlier period of his life Croft wrote much for the theatre, including overtures and incidental music for *Courtship à la mode* (1700), *The Funeral* (1702) and *The Lying Lover* (1703).

**CROFTER**, a term used, more particularly in the Highlands and islands of Scotland, to designate a tenant who rents and cultivates a small holding of land or "croft." This Old English word, meaning originally an enclosed field, seems to correspond to the Dutch *kroft*, a field on high ground or downs. The ultimate origin is unknown. By the Crofters' Holdings (Scotland) Act 1886, a crofter is defined as the tenant of a holding who resides on his holding, the annual rent of which does not exceed £30 in money, and which is situated in a crofting parish. The wholesale clearances of tenants from their crofts during the 19th century, in violation of, as the tenants claimed, an implied security of tenure, has led in the past to much agitation on the part of the crofters to secure consideration of their grievances. They have been the subject of royal commissions and of considerable legislation, but the effect of the Crofters Act of 1886, with subsequent amending acts, has been to improve their condition markedly, and much of the agitation has now died out. A history of the legislation dealing with the crofters is given in the article SCOTLAND.

**CROKER, JOHN WILSON** (1780-1857), British statesman and author, was born at Galway on the 20th of December 1780, being the only son of John Croker, the surveyor-general of customs and excise in Ireland. He was educated at Trinity College, Dublin, where he graduated in 1800. Immediately afterwards he was entered at Lincoln's Inn, and in 1802 he was called to the Irish bar. His interest in the French Revolution led him to collect a large number of valuable documents on the subject, which are now in the British Museum. In 1804 he published anonymously *Familiar Epistles to J. F. Jones, Esquire, on the State of the Irish Stage*, a series of caustic criticisms in verse on the management of the Dublin theatres. The book ran through five editions in one year. Equally successful was the *Intercepted Letter from Canton* (1805), also anonymous, a satire on Dublin society. In 1807 he published a pamphlet on *The State of Ireland, Past and Present*, in which he advocated Catholic emancipation.

In the following year he entered parliament as member for Downpatrick, obtaining the seat on petition, though he had been unsuccessful at the poll. The acumen displayed in his Irish pamphlet led Spencer Perceval to recommend him in 1808 to Sir Arthur Wellesley, who had just been appointed to the command of the British forces in the Peninsula, as his deputy in the office of chief secretary for Ireland. This connexion led to a friendship which remained unbroken till Wellington's death. The notorious case of the duke of York in connexion with his

abuse of military patronage furnished him with an opportunity for distinguishing himself. The speech which he delivered on the 14th of March 1809, in answer to the charges of Colonel Wardle, was regarded as the most able and ingenious defence of the duke that was made in the debate; and Croker was appointed to the office of secretary to the Admiralty, which he held without interruption under various administrations for more than twenty years. He proved an excellent public servant, and made many improvements which have been of permanent value in the organization of his office. Among the first acts of his official career was the exposure of a fellow-official who had misappropriated the public funds to the extent of £200,000.

In 1827 he became the representative of the university of Dublin, having previously sat successively for the boroughs of Athlone, Yarmouth (Isle of Wight), Bodmin and Aldeburgh. He was a determined opponent of the Reform Bill, and vowed that he would never sit in a reformed parliament; his parliamentary career accordingly terminated in 1832. Two years earlier he had retired from his post at the admiralty on a pension of £1500 a year. Many of his political speeches were published in pamphlet form, and they show him to have been a vigorous and effective, though somewhat unscrupulous and often virulently personal, party debater. Croker had been an ardent supporter of Peel, but finally broke with him when he began to advocate the repeal of the Corn Laws. He is said to have been the first to use (Jan. 1830) the term "conservatives." He was for many years one of the leading contributors on literary and historical subjects to the *Quarterly Review*, with which he had been associated from its foundation. The rancorous spirit in which many of his articles were written did much to embitter party feeling. It also reacted unfavourably on Croker's reputation as a worker in the department of pure literature by bringing political animosities into literary criticism. He had no sympathy with the younger school of poets who were in revolt against the artificial methods of the 18th century, and he was responsible for the famous *Quarterly* article on Keats. It is, nevertheless, unjust to judge Croker by the criticisms which Macaulay brought against his *magnum opus*, his edition of Boswell's *Life of Johnson* (1831). With all its defects the work had merits which Macaulay was of course not concerned to point out, and Croker's researches have been of the greatest value to subsequent editors. There is little doubt that Macaulay had personal reasons for his attack on Croker, who had more than once exposed in the House the fallacies that lay hidden under the orator's brilliant rhetoric. Croker made no immediate reply to Macaulay's attack, but when the first two volumes of the *History* appeared he took the opportunity of pointing out the inaccuracies that abounded in the work. Croker was occupied for several years on an annotated edition of Pope's works. It was left unfinished at the time of his death, but it was afterwards completed by the Rev. Whitwell Elwin and Mr W. J. Courthope. He died at St Albans Bank, Hampton, on the 10th of August 1857.

Croker was generally supposed to be the original from which Disraeli drew the character of "Rigby" in *Coningsby*, because he had for many years had the sole management of the estates of the marquess of Hertford, the "Lord Monmouth" of the story; but the comparison is a great injustice to the sterling worth of Croker's character.

The chief works of Croker not already mentioned were his *Stories for Children from the History of England* (1817), which provided the model for Scott's *Tales of a Grandfather*; *Letters on the Naval War with America*; *A Reply to the Letters of Malachi Malagrowth* (1826); *Military Events of the French Revolution of 1830* (1831); a translation of Bassompierre's *Embassy to England* (1819); and several lyrical pieces of some merit, such as the *Songs of Trafalgar* (1806) and *The Battles of Talavera* (1809). He also edited the *Suffolk Papers* (1823), *Hervey's Memoirs of the Court of George II.* (1817), the *Letters of Mary Lepel, Lady Hervey* (1821-1822), and *Walpole's Letters to Lord Hertford* (1824). His memoirs, diaries and correspondence were edited by Louis J. Jennings in 1884 under the title of *The Croker Papers* (3 vols.).

**CROKER, RICHARD** (1843- ), American politician, was born at Blackrock, Ireland, on the 24th of November 1843. He was taken to the United States by his parents when two years old, and was educated in the public schools of New York

City, where he eventually became a member of Tammany Hall and active in its politics. He was an alderman from 1868 to 1870, a coroner from 1873 to 1876, a fire commissioner in 1883 and 1887, and city chamberlain from 1889 to 1890. After the fall of John Kelly he became the leader of Tammany Hall (*q.v.*), and for some time almost completely controlled the organization. His greatest political success was his bringing about the election of Robert A. van Wyck as first mayor of greater New York in 1897, and during van Wyck's administration Croker is popularly supposed to have dominated completely the government of the city. After Croker's failure to "carry" the city in the presidential election of 1900 and the defeat of his mayoralty candidate, Edward M. Shepard, in 1901, he resigned from his position of leadership in Tammany, and retired to a country life in England and Ireland. In 1907 he won the Derby with his race-horse Orby.

**CROKER, THOMAS CROFTON** (1798-1854), Irish antiquary and humorist, was born in Cork on the 15th of January 1798. He was apprenticed to a merchant, but in 1819, through the interest of John Wilson Croker, who was, however, no relation of his, he became a clerk in the Admiralty. Moore was indebted to him in the production of his *Irish Melodies* for "many curious fragments of ancient poetry." In 1825 he produced his most popular book, the *Fairy Legends and Traditions of the South of Ireland*, which he followed up by the publication of his *Legends of the Lakes* (1829), his *Adventures of Barney Mahoney* (1852), and an edition of the *Popular Songs of Ireland* (1839). In 1827 he was made a member of the Irish Academy; in 1839 and 1840 he helped to found the Camden and Percy Societies, and in 1843 the British Archaeological Association. He wrote *Narratives Illustrative of the Contests in Ireland in 1641 and 1688* (1841), for the Camden Society, *Historical Songs of Ireland, &c.* (1841), for the Percy Society, and several other works. He was also a member of the Hakluyt and the Antiquarian Society. He died in London on the 8th of August 1854.

**CROLL, JAMES** (1821-1890), Scottish man of science, was born of a peasant family at Little Whitefield, in the parish of Cargill, in Perthshire, on the 2nd of January 1821. He was regarded as an unpromising boy, but a trifling circumstance aroused a passion for reading, and he made great progress in self-education. He was apprenticed to a wheelwright at Collace in Perthshire, but being debarred by ill-health from manual labour, he became successively a shop-keeper and an insurance agent. In 1859 he was made keeper of the Andersonian Museum in Glasgow, a humble appointment, which, however, gave him congenial occupation. In 1857, being deeply impressed by the metaphysics of Jonathan Edwards, he had published an anonymous volume entitled *The Philosophy of Theism*; but his connexion with the Museum induced him to take up physical science, and from 1861 onwards he studied with such perseverance that he was enabled to contribute papers to the *Philosophical Magazine* and other journals. For that magazine in 1864 he wrote his celebrated essay "On the Physical Cause of the Changes of Climate during Geological Epochs." This led to his receiving an appointment on the Scottish Geological Survey in 1867, and for thirteen years he took charge of the Edinburgh Office. In 1875 he summed up his researches upon the ancient condition of the earth in his *Climate and Time, in their Geological Relations*, in which he contends that terrestrial revolutions are due in a measure to cosmical causes. This theory excited warm controversy. Croll's replies to his opponents are collected in his *Climate and Cosmology* (1885). He had been compelled by ill-health to withdraw from the public service in 1880; yet, working under the greatest difficulties, and harassed by the inadequacy of his retiring pension, he managed to produce *Stellar Evolution*, discussing, among other things, the age of the sun, in 1889; and *The Philosophical Basis of Evolution*, partly a critique of Herbert Spencer's philosophy, in 1890. He died on the 15th of December 1890. The soundness of Croll's astronomical theory regarding the glacial period has since been criticized by E. P. Culverwell in the *Geological Magazine* for 1895, and by others; and it is now generally abandoned. Never-

theless it must be admitted that his character as a scientific worker under great discouragements was nothing less than heroic. The hon. degree of LL.D. was conferred on him in 1876 by the university of St Andrews; and he was elected F.R.S. in the same year.

An *Autobiographical Sketch of James Croll, with Memoir of his Life and Work*, was prepared by J. C. Irons, and published in 1896.

**CROLY, GEORGE** (1780-1860), British divine and author, son of a Dublin physician, was born on the 17th of August 1780. He was educated at Trinity College, Dublin, and after ordination was appointed to a small curacy in the north of Ireland. About 1810 he came to London, and occupied himself with literary work. A man of restless energy, he claims attention by his extraordinary versatility. He wrote dramatic criticisms for a short-lived periodical called the *New Times*; he was one of the earliest contributors to *Blackwood's Magazine*; and to the *Literary Gazette* he contributed poems, reviews and essays on all kinds of subjects. In 1819 he married Margaret Helen Begbie. Efforts to secure an English living for Croly were frustrated, according to the *Gentleman's Magazine* (Jan. 1861), because Lord Eldon confounded him with a Roman Catholic of the same name. Excluding his contributions to the daily and weekly press his chief works were:—*Paris in 1815* (1817), a poem in imitation of *Childe Harold*; *Catiline* (1822), a tragedy lacking in dramatic force; *Salathiel: A Story of the Past, the Present and the Future* (1829), a successful romance of the "Wandering Jew" type; *The Life and Times of his late Majesty George the Fourth* (1830); *Marston; or, The Soldier and Statesman* (1846), a novel of modern life; *The Modern Orlando* (1846), a satire which owes something to *Don Juan*; and some biographies, sermons and theological works.

Croly was an effective preacher, and continued to hope for preferment from the Tory leaders, to whom he had rendered considerable services by his pen; but he eventually received, in 1835, the living of St Stephen's, Walbrook, London, from a Whig patron, Lord Brougham, with whose family he was connected. In 1847 he was made afternoon lecturer at the Foundling hospital, but this appointment proved unfortunate. He died suddenly on the 24th of November 1860, in London.

His *Poetical Works* (2 vols.) were collected in 1830. For a list of his works see Allibone's *Critical Dictionary of English Literature* (1859).

**CROMAGNON RACE**, the name given by Paul Broca to a type of mankind supposed to be represented by remains found by Lartet, Christy and others, in France in the Cromagnon cave at Les Eyzies, Tayac district, Dordogne. At the foot of a steep rock near the village this small cave, nearly filled with debris, was found by workmen in 1868. Towards the top of the loose strata three human skeletons were unearthed. They were those of an old man, a young man and a woman, the latter's skull bearing the mark of a severe wound. The skulls presented such special characteristics that Broca took them as types of a race. Palaeolithic man is exclusively long-headed, and the dolichocephalic appearance of the crania (they had a mean cephalic index of 73.34) supported the view that the "find" at Les Eyzies was palaeolithic. It is, however, inaccurate to state that brachycephaly appears at once with the neolithic age, dolichocephaly even of a pronounced type persisting far into neolithic times. The Cromagnon race may thus be, as many anthropologists believe it, early neolithic, a type of man who spread over and inhabited a large portion of Europe at the close of the Pleistocene period. Some have sought to find in it the substratum of the present populations of western Europe. Quatrefages identifies Cromagnon man with the tall, long-headed, fair Kabyles (Berbers) who still survive in various parts of Mauritania. He suggests the introduction of the Cromagnon from Siberia, "arriving in Europe simultaneously with the great mammals (which were driven by the cold from Siberia), and no doubt following their route."

See A. H. Keane's *Ethnology* (1896); Mortillet, *Le Préhistorique* (1900); Sergi, *The Mediterranean Race* (1901); Lord Avebury, *Prehistoric Times*, p. 317 of 1900 edition.

**CROMARTY, GEORGE MACKENZIE, 1ST EARL OF** (1630-1714), Scottish statesman, was the eldest son of Sir John Mackenzie, Bart., of Tarbat (d. 1654), and belonged to the same family as the earls of Seaforth. In 1654 he joined the rising in Scotland on behalf of Charles II. and after an exile of six years he returned to his own country and took some part in public affairs after the Restoration. In 1661 he became a lord of session as Lord Tarbat, but having been concerned in a vain attempt to overthrow Charles II.'s secretary, the earl of Lauderdale, he was dismissed from office in 1664. A period of retirement followed until 1678 when Mackenzie was appointed lord justice general of Scotland; in 1681 he became lord clerk register and a lord of session for the second time, and from 1682 to 1688 he was the chief minister of Charles II. and James II. in Scotland, being created viscount of Tarbat in 1685. In 1688, however, he deserted James and soon afterwards made his peace with William III., his experience being very serviceable to the new government in settling the affairs of Scotland. From 1692 to 1695 Tarbat was again lord clerk register, and having served for a short time as a secretary of state under Queen Anne he was created earl of Cromarty in 1703. He was again lord justice general from 1704 to 1710. He warmly supported the union between England and Scotland, writing some pamphlets in favour of this step, and he died on the 17th of August 1714. Cromarty was a man of much learning, and among his numerous writings may be mentioned his *Account of the conspiracies by the earls of Gowry and R. Logan* (Edinburgh, 1713).

The earl's grandson George, 3rd earl of Cromarty (c. 1703-1766), succeeded his father John, the 2nd earl, in February 1731. In 1745 he joined Charles Edward, the young pretender, and he served with the Jacobites until April 1746 when he was taken prisoner in Sutherlandshire. He was tried and sentenced to death, but he obtained a conditional pardon although his peerage was forfeited. He died on the 28th of September 1766.

This earl's eldest son was John Mackenzie, Lord Macleod (1727-1789), who shared his father's fortunes in 1745 and his fate in 1746. Having pleaded guilty at his trial Macleod was pardoned on condition that he gave up all his rights in the estates of the earldom, and he left England and entered the Swedish army. In this service he rose to high rank and was made Count Cromarty. The count returned to England in 1777 and was successful in raising, mainly among the Mackenzies, two splendid battalions of Highlanders, the first of which, now the Highland Light Infantry, served under him in India. In 1784 he regained the family estates and he died on the 2nd of April 1789. Macleod wrote an account of the Jacobite rising of 1745, and also one of a campaign in Bohemia in which he took part in 1757; both are printed in Sir W. Fraser's *Earls of Cromartie* (Edinburgh, 1876).

Macleod left no children, and his heir was his cousin, Kenneth Mackenzie (d. 1796), a grandson of the 2nd earl, who also died childless. The estates then passed to Macleod's sister, Isabel (1725-1801), wife of George Murray, 6th Lord Elibank. In 1861 Isabel's descendant, Anne (1829-1888), wife of George, 3rd duke of Sutherland, was created countess of Cromartie with remainder to her second son Francis (1852-1893), who became earl of Cromartie in 1888. In 1895, two years after the death of Francis, his daughter Sibell Lilian (b. 1878) was granted by letters patent the title of countess of Cromartie.

**CROMARTY**, a police burgh and seaport of the county of Ross and Cromarty, Scotland. Pop. (1901) 1242. It is situated on the southern shore of the mouth of Cromarty Firth, 5 m. E. by S. of Invergordon on the opposite coast, with which there is daily communication by steamer, and 9 m. N.E. of Fortrose, the most convenient railway station. Before the union of the shires of Ross and Cromarty, it was the county town of Cromartyshire, and is one of the Wick district group of parliamentary burghs. Its name is variously derived from the Gaelic *crom*, crooked, and *bath*, bay, or *ard*, height, meaning either the "crooked bay," or the "bend between the heights" (the high rocks, or Sutors, which guard the entrance to the Firth), and gave the title to the earldom of Cromarty. The principal buildings are the town hall and the Hugh Miller Institute. The harbour,

enclosed by two piers, accommodates the herring fleet, but the fisheries, the staple industry, have declined. The town, however, is in growing repute as a midsummer resort. The thatched house with crow-stepped gables in Church Street, in which Hugh Miller the geologist was born, still stands, and a statue has been erected to his memory. To the east of the burgh is Cromarty House, occupying the site of the old castle of the earls of Ross. It was the birthplace of Sir Thomas Urquhart, the translator of Rabelais.

Cromarty, formerly a county in the north of Scotland, was incorporated with Ross-shire in 1889 under the designation of the county of Ross and Cromarty. The nucleus of the county consisted of the lands of Cromarty in the north of the peninsula of the Black Isle. To this were added from time to time the various estates scattered throughout Ross-shire—the most considerable of which were the districts around Ullapool and Little Loch Broom on the Atlantic coast, the area in which Ben Wyvis is situated, and a tract to the north of Loch Fannich—which had been acquired by the ancestors of Sir George Mackenzie (1630-1714), afterwards Viscount Tarbat (1685) and 1st earl of Cromarty (1703). Desirous of combining these sporadic properties into one shire, Viscount Tarbat was enabled to procure their annexation to his sheriffdom of Cromarty in 1685 and 1698, the area of the enlarged county amounting to nearly 370 sq. m. (See ROSS AND CROMARTY.)

**CROMARTY FIRTH**, an arm of the North Sea, belonging to the county of Ross and Cromarty, Scotland. From the Moray Firth it extends inland in a westerly and then south-westerly direction for a distance of 19 m. Excepting at the Bay of Nigg, on the northern shore, and Cromarty Bay, on the southern, where it is about 5 m. wide (due N. and S.), and at Alness Bay, where it is 2 m. wide, it has an average width of 1 m. and a depth varying from 5 to 10 fathoms, forming one of the safest and most commodious anchorages in the north of Scotland. Besides other streams it receives the Conon, Pefferly, Skiack and Alness, and the principal places on its shores are Dingwall near the head, Cromarty near the mouth, Kiltearn, Invergordon and Kilmuir on the north. The entrance is guarded by two precipitous rocks—the one on the north 400 ft., that on the south 463 ft. high—called the Sutors from a fancied resemblance to a couple of shoemakers (*Scotice*, souter), bending over their lasts. There are ferries at Cromarty, Invergordon and Dingwall.

**CROME, JOHN** (1769-1821), English landscape painter, founder and chief representative of the "Norwich School," often called Old Crome, to distinguish him from his son, was born at Norwich, on the 21st of December 1769. His father was a weaver, and could give him only the scantiest education. His early years were spent in work of the humblest kind; and at a fit age he became apprentice to a house-painter. To this step he appears to have been led by an inborn love of art and the desire to acquaint himself by any means with its materials and processes. During his apprenticeship he sometimes painted signboards, and devoted what leisure time he had to sketching from nature. Through the influence of a rich art-loving friend he was enabled to exchange his occupation of house-painter for that of drawing-master; and in this he was engaged throughout his life. He took great delight in a collection of Dutch pictures to which he had access, and these he carefully studied. About 1790 he was introduced to Sir William Beechey, whose house in London he frequently visited, and from whom he gathered additional knowledge and help in his art. In 1805 the Norwich Society of Artists took definite shape, its origin being traceable a year or two further back. Crome was its president and the largest contributor to its annual exhibitions. Among his pupils were James Stark, Vincent, Thirtle and John Bernay (Barney) Crome (1794-1842), his son. J. S. Cotman, too, a greater artist than any of these, was associated with him. Crome continued to reside at Norwich, and with the exception of his short visits to London had little or no communication with the great artists of his own time. He first exhibited at the Royal Academy in 1806; but in this and the following twelve years he exhibited there only fourteen of his works. With very

few exceptions Crome's subjects are taken from the familiar scenery of his native county. Fidelity to nature was his dominant aim. "The bit of heath, the boat, and the slow water of the flattish land, trees most of all—the single tree in elaborate study, the group of trees, and how the growth of one affects that of another, and the characteristics of each,"—these, says Frederick Wedmore (*Studies in English Art*), are the things to which he is most constant. He still remains, says the same critic, of many trees the greatest draughtsman, and is especially the master of the oak. His most important works are—"Mousehold Heath, near Norwich," now in the National Gallery; "Clump of Trees, Hautbois Common"; "Oak at Poringland"; the "Willow"; "Coast Scene near Yarmouth"; "Bruges, on the Ostend River"; "Slate Quarries"; the "Italian Boulevards"; and the "Fishmarket at Boulogne." He executed a good many etchings, and the great charm of these is in the beautiful and faithful representation of trees. Crome enjoyed a very limited reputation during his life, and his pictures were sold at low prices; but since his death they have been more and more appreciated, and have given him a high place among English painters of landscape. He died at Norwich on the 22nd of April 1821. His son, J. B. Crome, was his assistant in teaching, and his best pictures were in the same style, his moonlight effects being much admired.

A collection of "Old" Crome's etchings, entitled *Norfolk Picturesque Scenery*, was published in 1834, and was re-issued with a memoir by Dawson Turner in 1838, but in this issue the prints were retouched by other hands.

**CROMER, EVELYN BARING, 1ST EARL (1841- )**, British statesman and diplomatist, was born on the 26th of February 1841, the ninth son of Henry Baring, M.P., by Cecilia Anne, eldest daughter of Admiral Windham of Felbrigg Hall, Norfolk. Having joined the Royal Artillery in 1858, he was appointed in 1861 A.D.C. to Sir Henry Storks, high commissioner of the Ionian Islands, and acted as secretary to the same chief during the inquiry into the Jamaica outbreak in 1865. Gazetted captain in 1870, he went in 1872 as private secretary to his cousin Lord Northbrook, Viceroy of India, where he remained until 1876, when he became major, received the C.S.I., and was appointed British commissioner of the Egyptian public debt office. Up to this period Major Baring had given no unusual signs of promise, and the appointment of a comparatively untried major of artillery as the British representative on a Financial Board composed of representatives of all the great powers was considered a bold one. Within a very short time it was recognized that the Englishman, though keeping himself carefully in the background, was unmistakably the predominant factor on the board. He was mainly responsible for the searching report, issued in 1878, of the commission of inquiry that had been instituted into the financial methods of the Khedive Ismail; and when that able and unscrupulous Oriental had to submit to an enforced abdication in 1879, it was Major Baring who became the British controller-general and practical director of the Dual Control. Had he remained in Egypt, the whole course of Egyptian history might have been altered, but his services were deemed more necessary in India, and under Lord Ripon he became financial member of council in June 1880. He remained there till 1883, leaving an unmistakable mark on the Indian financial system, and then, having been rewarded by the K.C.S.I., he was appointed British agent and consul-general in Egypt and a minister plenipotentiary in the diplomatic service.

Sir Evelyn Baring was at that time only a man of forty-two, who had gained a reputation for considerable financial ability, combined with an abruptness of manner and a certain autocracy of demeanour which, it was feared, would impede his success in a position which required considerable tact and diplomacy. It was a friendly colleague who wrote—

"The virtues of Patience are known,  
But I think that, when put to the touch,  
The people of Egypt will own, with a groan,  
There's an Evil in Baring too much."

When he arrived in Cairo in 1883 he found the administration of the country almost non-existent. Ismail had ruled with all

the vices, but also with all the advantages, of autocracy. Disorder in the finances, brutality towards the people, had been combined with public tranquillity and the outer semblance of civilization. Order, at least, reigned from the Sudan to the Mediterranean, and such trivial military disturbances as had occurred had been of Ismail's own devising and for his own purposes. Tewfik, who had succeeded him, had neither the inclination nor character to be a despot. Within three years his government had been all but overthrown, and he was only khedive by the grace of British bayonets. Government by bayonets was not in accord with the views of the House of Commons, yet Ismail's government by the kourbash could not be restored. The British government, under Mr Gladstone, desired to establish in Egypt a sort of constitutional government; and as there existed no single element of a constitution, they had sent out Lord Dufferin (the first marquess of Dufferin) to frame one. That gifted nobleman, in the delightful lucidity of his picturesque report, left nothing to be desired except the material necessary to convert the flowing periods into political entities.<sup>1</sup> In the absence of that, the constitution was still-born, and Sir Evelyn Baring arrived to find, not indeed a clean slate, but a worn-out papyrus, disfigured by the efforts of centuries to describe in hieroglyph a method of rule for a docile people.

From that date the history of Sir Evelyn Baring, who became Baron Cromer in 1892, G.C.B. in 1895, viscount in 1897, and earl in 1901, is the history of Egypt, and requires the barest mention of its salient points here. From the outset he realized that the task he had to perform could only be effected piecemeal and in detail, and his very first measure was one which, though severely criticized at the time, has been justified by events, and which in any case showed that he shirked no responsibility, and was capable of adopting heroic methods. He counselled the abandonment, at least temporarily, by Egypt of its authority in the Sudan provinces, already challenged by the mahdi. His views were shared by the British ministry of the day and the policy of abandonment enforced upon the Egyptian government. At the same time it was decided that efforts should be made to relieve the Egyptian garrisons in the Sudan and this resolve led to the mission of General C. G. Gordon (*q.v.*) to Khartum. Lord Cromer subsequently told the story of Gordon's mission at length, making clear the measure of responsibility resting upon him as British agent. The proposal to employ Gordon came from the British government and twice Sir Evelyn rejected the suggestion. Finally, mistrusting his own judgment, for he did not consider Gordon the proper person for the mission, Baring yielded to pressure from Lord Granville. Thereafter he gave Gordon all the support possible, and in the critical matter of the proposed despatch of Zobeir to Khartum, Baring—after a few days' hesitation—cordially endorsed Gordon's request. The request was refused by the British government—and the catastrophe which followed at Khartum rendered inevitable.

The Sudan crisis being over, for the time, Sir Evelyn Baring set to work to reorganize Egypt itself. This work he attacked in detail. The very first essential was to regulate the financial situation; and in Egypt, where the entire revenue is based on the production of the soil, irrigation was of the first importance. With the assistance of Sir Colin Scott Moncrieff, in the public works department, and Sir Edgar Vincent, as financial adviser, these two great departments were practically put in order before he gave more than superficial attention to the rest. The ministry of justice was the next department seriously taken in hand, with the assistance of Sir John Scott, while the army had been reformed under Sir Evelyn Wood, who was succeeded by Sir Francis (afterwards Lord) Grenfell. Education, the ministry

<sup>1</sup> In 1892 Lord Dufferin wrote to Lord Cromer: "These institutions were a good deal ridiculed at the time, but as it was then uncertain how long we were going to remain, or rather how soon the Turks might not be reinvested with their ancient supremacy, I desired to erect some sort of barrier, however feeble, against their intolerable tyranny." In 1906 Lord Cromer bore public testimony to the good results of the measures adopted on Lord Dufferin's "statesmanlike initiative." Such results were, however, only possible in consequence of the continuance of the British occupation.

of the interior, and gradually every other department, came to be reorganized, or, more correctly speaking, formed, under Lord Cromer's carefully persistent direction, until it may be said to-day that the Egyptian administration can safely challenge comparison with that of any other state. In the meantime the rule of the mahdi and his successor, the khalifa, in the temporarily abandoned provinces of the Sudan, had been weakened by internal dissensions; the Italians from Massawa, the Belgians from the Congo State, and the French from their West African possessions, had gradually approached nearer to the valley of the Nile; and the moment had arrived at which Egypt must decide either to recover her position in the Sudan or allow the Upper Nile to fall into hands hostile to Great Britain and her position in Egypt. Lord Cromer was as quick to recognize the moment for action and to act as he had fifteen years earlier been prompt to recognize the necessity of abstention. In March-September 1896 the first advance was made to Dongola under the Sirdar, Sir Herbert (afterwards Lord) Kitchener; between July 1897 and April 1898 the advance was pushed forward to the Atbara; and on the 2nd of September 1898, the battle of Omdurman finally crushed the power of the khalifa and restored the Sudan to the rule of Egypt and Great Britain. In the negotiations which resulted in the Anglo-French Declaration of the 8th of April 1904, whereby France bound herself not to obstruct in any manner the action of Great Britain in Egypt and the Egyptian government acquired financial freedom, Lord Cromer took an active part. He also successfully guarded the interests of Egypt and Great Britain in 1906 when Turkey attempted by encroachments in the Sinai Peninsula to obtain a strategic position on the Suez Canal. To have effected all this in the face of the greatest difficulties—political, national and international—and at the same time to have raised the credit of the country from a condition of bankruptcy to an equality with that of the first European powers, entitles Lord Cromer to a very high place among the greatest administrators and statesmen that the British empire has produced. In April 1907, in consequence of the state of his health, he resigned office, having held the post of British agent in Egypt for twenty-four years. In July of the same year parliament granted £50,000 out of the public funds to Lord Cromer in recognition of his "eminent services" in Egypt. In 1908 he published, in two volumes, *Modern Egypt*, in which he gave an impartial narrative of events in Egypt and the Sudan since 1876, and dealt with the results to Egypt of the British occupation of the country. Lord Cromer also took part in the political controversies at home, joining himself to the free-trade wing of the Unionist party.

Lord Cromer married in 1876 Ethel Stanley, daughter of Sir Rowland Stanley Errington, eleventh baronet, but was left a widower with two sons in 1898; and in 1901 he married Lady Katherine Thynne, daughter of the 4th marquess of Bath.

**CROMER**, a watering-place in the northern parliamentary division of Norfolk, England, 139 m. N.E. by N. from London by the Great Eastern railway; served also by the Midland and Great Northern joint line. Pop. of urban district (1901) 3781. Standing on cliffs of considerable elevation, the town has repeatedly suffered from ravages of the sea. A wall and esplanade extend along the bottom of the cliffs, and there is a fine stretch of sandy beach. There is also a short pier. The church of St Peter and St Paul is Perpendicular (largely restored) with a lofty tower. On a site of three acres stands the convalescent home of the Norfolk and Norwich hospital. There is an excellent golf course. The herring, cod, lobster and crab fisheries are prosecuted. The village of Sheringham (pop. of urban district, 2359), lying to the west, is also frequented by visitors. A so-called Roman camp, on an elevation overlooking the sea, is actually a modern beacon.

**CROMORNE**, also **CRUMHORNE**<sup>1</sup> (Ger. *Krummhorn*; Fr. *tournebout*), a wind instrument of wood in which a cylindrical

<sup>1</sup> Crumhorne need not be regarded as a corruption of the German, since the two words of which it is composed were both in use in medieval England. *Crumb* = curved; *crumbe* = hook, bend; *crome* = a staff with a hook at the end of it. See Stratmann's *Middle English Dictionary* (1891), and Halliwell, *Dictionary of Archaic and Provincial Words* (London, 1881).

column of air is set in vibration by a reed. The lower extremity is turned up in a half-circle, and from this peculiarity it has gained the French name *tournebout*. The reed of the cromorne, like that of the bassoon, is formed by a double tongue of cane adapted to the small end of a conical brass tube or crook, the large end fitting into the main bore of the instrument. It presents, however, this difference, that it is not, like that of the bassoon, in contact with the player's lips, but is covered by a cap pierced in the upper part with a raised slit against which the performer's lips rest, the air being forced through the opening into the cap and setting the reed in vibration. The reed itself is therefore not subject to the pressure of the lips. The compass of the instrument is in consequence limited to the simple fundamental sounds produced by the successive opening of the lateral holes. The length of the cromornes is inconsiderable in proportion to the deep sounds produced by them, which arises from the fact that these instruments, like all tubes of cylindrical bore provided with reeds, have the acoustic properties of the stopped pipes of an organ. That is to say, theoretically they require only half the length necessary for the open pipes of an organ or for conical tubes provided with reeds, to produce notes of the same pitch. Moreover, when, to obtain an harmonic, the column of air is divided, the cromorne will not give the octave, like the oboe and bassoon, but the twelfth, corresponding in this peculiarity with the clarinet and all stopped pipes or bourdons. In order, however, to obtain an harmonic on the cromorne, the cap would have to be discarded, for a reed only overblows to give the harmonic overtones when pressed by the lips. With the ordinary boring of eight lateral holes the cromorne possesses a limited compass of a ninth. Sometimes, however, deeper sounds are obtained by the addition of one or more keys.

By its construction the cromorne is one of the oldest wind instruments; it is evidently derived from the Gr. aulos<sup>2</sup> and the Roman tibia, which likewise consisted of a simple cylindrical pipe of which the air column was set in vibration, at first by a double reed, and, we have reason to believe, later by a single reed (see AULOS and CLARINET). The Phrygian aulos was sometimes curved (see Tib. ii. 1. 85 *Phrygio tibia curva sono*; Virgil, *Aen.* xi. 737 *curva choros indixit tibia Bacchi*).<sup>3</sup>

Notwithstanding the successive improvements that were introduced in the manufacture of wind instruments, the cromorne scarcely ever varied in the details of its construction. Such as we see it represented in the treatise by Virdung<sup>4</sup> we find it again about the epoch of its disappearance.<sup>5</sup> The cromornes existed as a complete family from the 15th century, consisting, according to Virdung, of four instruments; Praetorius<sup>6</sup> cites five—the deep bass, the bass, the tenor or alto, the cantus or soprano and the high soprano, with compass as shown. A band, or, to use the expression of Praetorius,



an "accort" of cromornes comprised 1 deep bass, 2 bass, 3 tenor, 2 cantus, 1 high soprano = 9.

Mersenne<sup>7</sup> explains the construction of the cromorne, giving careful illustrations of the instrument with and without the cap. From him we learn that these instruments were made in England, where they were played in concert in sets of four, five and six. Their scheme of construction and especially the reed and cap is very similar to that of the chalumeau of the musette (see BAG-PIPE), but its timbre is by

<sup>2</sup> See A. Howard, "Aulos or Tibia," *Harvard Studies*, iv. (Boston, 1893).

<sup>3</sup> See also A. A. Howard, *op. cit.*, "Phrygian Aulos," pp. 35-38.

<sup>4</sup> *Musica getutsch und auszerogen* (Basel, 1511).

<sup>5</sup> See Diderot and d'Alembert's *Encyclopédie* (Paris, 1751-1780), t. 5, "Lutherie," pl. ix.

<sup>6</sup> *Organographia* (Wolfenbüttel, 1618).

<sup>7</sup> *L'Harmonie universelle* (Paris, 1636-1637), book v. pp. 289 and 290. Cf. "Musette," pp. 282-287 and 305.

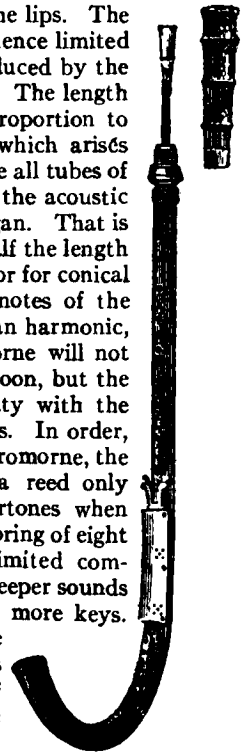

Bass Tournebout.



no means so pleasant. Mersenne's cromornes have ten fingerholes, Nos. 7 and 8 being duplicates for right and left-handed players. They were probably sometimes used, as was the case with the hautbois de Poitou (see BAG-PIPE), without the cap, when an extended compass was required.

The cromornes were in very general use in Europe from the 14th to the 17th century, and are to be found in illustrations of pageants, as for instance in the magnificent collection of woodcuts designed by Hans Burgmair, a pupil of Albrecht Dürer, representing the triumph of the emperor Maximilian,<sup>1</sup> where a bass and a tenor Krumbhorn player figure in the procession among countless other musicians. In the inventory of the wardrobe, &c., belonging to Henry VIII. at Westminster, made during the reign of Edward VI., we find eighteen crumhorns (see British Museum, Harleian MS. 1419, ff. 202b and 205). The cromornes did not always form an orchestra by themselves, but were also used in concert with other instruments and notably with flutes and oboes, as in municipal bands and in the private bands of princes. In 1685 the orchestra of the Neue Kirche at Strassburg comprised two tournebouts or cromornes, and until the middle of the 18th century these instruments formed part of the court band known as "Musique de la Grande Écurie" in the service of the French kings. They are first mentioned in the accounts for the year 1662, together with the tromba-marina, although the instrument was already highly esteemed in the 16th century. In that year five players of the cromorne were enrolled among the musicians of the Grande Écurie du Roi;<sup>2</sup> they received a yearly salary of 120 livres, which various supplementary allowances brought up to about 330 livres. In 1729 one of the cromorne players sold his appointment for 4000 francs. This was a sign of the falling popularity of the instrument. The duties of the cromorne and tromba-marina players consisted in playing in the great *divertissements* and at court functions and festivals in honour of royal marriages, births and thanksgivings.

Cromornes have become of extreme rarity and are not to be found in all collections. The Paris Conservatoire possesses one large bass cromorne of the 16th century, the Kgl. Hochschule für Musik,<sup>3</sup> Berlin, a set of seven, and the Ambrosier Sammlung, Vienna, a cromorne in E♭.<sup>4</sup> The museum of the Conservatoire Royal de Musique at Brussels has the good fortune to possess a complete family which is said to have belonged to the duke of Ferrara, Alphonso II. d'Este, a prince who reigned from 1559 to 1597. The soprano (cantus or discant) has the same compass as above, while those of the alto, the tenor (furnished with a key) and the bass are as shown.



The bass (see figure), besides having two keys, is distinguished from the others by two contrivances like small bolts, which slide in grooves and close the two holes that give the lowest notes of the instrument. The use of these bolts, placed at the extremity of the tournebout and out of reach of the fingers of the instrumentalist, renders necessary the assistance of a person whose sole mission is to attend to them during the performance. E. van der Straeten<sup>5</sup> mentions a key belonging to a large cromorne bearing the date 1537, of which he gives a large drawing. A cromorne appears in a musical scene with a trumpet in Hermann Finck's *Practica Musica*.<sup>6</sup>

The "Platerspiel," of which Viridung gives a drawing, is only a kind of cromorne. It is characterized by having, instead of a cap to cover the reed, a spherical receiver surrounding the reed, to which the tube for insufflation is adapted. The Platerspiel is also frequently classified among bagpipes. In the *Cantigas di Sante Maria*,<sup>7</sup> a MS. of the 13th century preserved in the Escorial, Madrid, two instruments of this type are represented. One of these has two straight, parallel pipes, slightly conical; the other is frankly conical with wide bore turned up at the end.

<sup>1</sup> See "Triumphzug des Kaisers Maximilian I." Beilage zum II. Band des *Jahrb. der Sammlungen des Allerhöchsten Kaiserhauses* (Vienna, 1884-1885), pl. 20. Explanatory text and part i. in Band i. of the same publication, 1883-1884. A French edition with 135 plates was also published in Vienna by A. Schmidt, and in London by J. Edwards (1796). See also Dr August Reissmann, *Illustrierte Geschichte der deutschen Musik* (Leipzig, 1881), where a few of the plates are reproduced.

<sup>2</sup> See J. Écorcheville, "Quelques documents sur la musique de la grande écurie du roi," *Sammelband d. Intern. Musik. Ges.* Jahrg. ii., Heft 4 (1901, Leipzig, London, &c.), pp. 630-632.

<sup>3</sup> Oskar Fleischer, *Führer* (Berlin, 1892), p. 29, Nos. 400 to 406.

<sup>4</sup> For an illustration see Captain C. R. Day, *Descriptive Catalogue* (London, 1891), pl. iv. E. and p. 99.

<sup>5</sup> *Histoire de la musique aux Pays-Bas avant le XIX<sup>e</sup> siècle* (Brussels, 1867-1888), vol. vii. p. 336, and description, p. 333 et seq.

<sup>6</sup> Wittenberg, 1556; reproduced by A. Reissmann, *op. cit.*, pp. 233 and 226.

<sup>7</sup> Reproduced in Riaño's *Notes on Early Spanish Music* (London, 1887), pp. 119-127.

Other instruments belonging by their most important characteristics of cylindrical bore and double reed to the same family as the cromorne, although the bore was somewhat differently disposed, are the racket bassoon and the sordine or sordelline. The latter was introduced into the orchestra by Cavaliere in his opera *Rappresentazione di anima e di corpo*, and is described by Giudotto<sup>8</sup> in his edition of the score as "Flauti ovvero due tibiae all' antica che noi chiamiamo sordelline," a description which tallies with what has been said above concerning the aulos and tibia. (V. M. and K. S.)

**CROMPTON, SAMUEL** (1753-1827), English inventor, was born on the 3rd of December 1753 at Firwood near Bolton-le-Moors, Lancashire. While yet a boy he lost his father, and had to contribute to the family resources by spinning yarn. The defects of the spinning jenny imbued him with the idea of devising something better, and for five or six years the effort absorbed all his spare time and money, including what he earned by playing the violin at the Bolton theatre. About 1779 he succeeded in producing a machine which span yarn suitable for use in the manufacture of muslin, and which was known as the muslin wheel or the Hall-in-the-Wood wheel (from the name of the house in which he and his family resided), and later as the spinning mule. After his marriage in 1780 a good demand arose for the yarn which he himself made at Hall-in-the-Wood, but the prying to which his methods were subjected drove him, in the absence of means to take out a patent, to the choice of destroying his machine or making it public. He adopted the latter alternative on the promise of a number of manufacturers to pay him for the use of the mule, but all he received was about £60. He then resumed spinning on his own account, but with indifferent success. In 1800 a sum of £500 was raised for his benefit by subscription, and when in 1809 Edmund Cartwright, the inventor of the power-loom obtained £10,000 from parliament, he determined also to apply for a grant. In 1811 he made a tour in the manufacturing districts of Lancashire and Scotland to collect evidence showing how extensively his mule was used, and in 1812 parliament allowed him £5000. With the aid of this money he embarked in business, first as a bleacher and then as a cotton merchant and spinner, but again without success. In 1824 some friends, without his knowledge, bought him an annuity of £63. He died at Bolton on the 26th of June 1827.

**CROMPTON**, an urban district of Lancashire, England, 2½ m. N. of Oldham, within the parliamentary borough of Oldham. Pop. (1901) 13,427. At Shaw, a populous village included within it, is a station on the Lancashire & Yorkshire railway. Cotton mills and the collieries of the neighbourhood employ the large industrial population.

**CROMWELL, HENRY** (1628-1674), fourth son of Oliver Cromwell, was born at Huntingdon on the 20th of January 1628, and served under his father during the latter part of the Civil War. His active life, however, was mainly spent in Ireland, whither he took some troops to assist Oliver early in 1650, and he was one of the Irish representatives in the Little, or Nominated, Parliament of 1653. In 1654 he was again in Ireland, and after making certain recommendations to his father, now lord protector, with regard to the government of that country, he became major-general of the forces in Ireland and a member of the Irish council of state, taking up his new duties in July 1655. Nominally Henry was subordinate to the lord-deputy, Charles Fleetwood, but Fleetwood's departure for England in September 1655 left him for all practical purposes the ruler of Ireland. He moderated the lord-deputy's policy of deporting the Irish, and unlike him he paid some attention to the interests of the English settlers; moreover, again unlike Fleetwood, he appears to have held the scales evenly between the different Protestant sects, and his undoubted popularity in Ireland is attested by Clarendon. In November 1657 Henry himself was made lord-deputy; but before this time he had refused a gift of property worth £1500 a year, basing his refusal on the grounds of the poverty of the country, a poverty which was not the least of his troubles. In 1657 he advised his father not to accept the office of king, although in 1654 he had supported a motion to this effect;

<sup>8</sup> See Hugo Goldschmidt, "Das Orchester der italienischen Oper im 17. Jahrh." *Sammelband der Intern. Musikgesellschaft*, Jahrg. ii., Heft 1 (Leipzig, 1900), p. 24.

and after the dissolution of Cromwell's second parliament in February 1658 he showed his anxiety that the protector should act in a moderate and constitutional manner. After Oliver's death Henry hailed with delight the succession of his brother Richard to the office of protector, but although he was now appointed lieutenant and governor general of Ireland, it was only with great reluctance that he remained in that country. Having rejected proposals to assist in the restoration of Charles II., Henry was recalled to England in June 1659 just after his brother's fall; quietly obeying this order he resigned his office at once. Although he lost some property at the Restoration, he was allowed after some solicitation to keep the estate he had bought in Ireland. His concluding years were passed at Spinney Abbey in Cambridgeshire; he was unmolested by the government, and he died on the 23rd of March 1674. In 1653 Henry married Elizabeth (d. 1687), daughter of Sir Francis Russell, and he left five sons and two daughters.

**CROMWELL, OLIVER** (1599-1658), lord protector of England, was the 5th and only surviving son of Robert Cromwell of Huntingdon and of Elizabeth Steward, widow of William Lynn. His paternal grandfather was Sir Henry Cromwell of Hinchinbrook, a leading personage in Huntingdonshire, and grandson of Richard Williams, knighted by Henry VIII., nephew of Thomas Cromwell, earl of Essex, Henry VIII.'s minister, whose name he adopted. His mother was descended from a family named Styward in Norfolk, which was not, however, connected in any way, as has been often asserted, with the royal house of Stuart. Oliver was born on the 25th of April 1599, was educated under Dr Thomas Beard, a fervent puritan, at the free school at Huntingdon, and on the 23rd of April 1616 matriculated as a fellow-commoner at Sidney Sussex College, Cambridge, then a hotbed of puritanism, subsequently studying law in London. The royalist anecdotes relating to his youth, including charges of ill-conduct, do not deserve credit, the entries in the register of St John's, Huntingdon, noting Oliver's submission on two occasions to church censure being forgeries; but it is not improbable that his youth was wild and possibly dissolute.<sup>1</sup> According to Edmund Waller he was "very well read in the Greek and Roman story." Burnet declares he had little Latin, but he was able to converse with the Dutch ambassador in that language. According to James Heath in his *Flagellum*, "he was more famous for his exercises in the fields than in the schools, being one of the chief match-makers and players at football, cudgels, or any other boisterous game or sport." On the 22nd of August 1620 he married Elizabeth, daughter of Sir James Bourchier, a city merchant of Tower Hill, and of Felstead in Essex; and his father having died in 1617 he settled at Huntingdon and occupied himself in the management of his small estate. In 1628 he was returned to parliament as member for the borough, and on the 11th of February 1629 he spoke in support of puritan doctrine, complaining of the attempt by the king to silence Dr Beard, who had raised his voice against the "flat popery" inculcated by Dr Alabaster at Paul's Cross. He was also one of the members who refused to adjourn at the king's command till Sir John Eliot's resolutions had been passed.

During the eleven years of government without parliament very little is recorded of Cromwell. His name is not connected with the resistance to the levy of ship-money or to the action of the ecclesiastical courts, but in 1630 he was one of those fined for refusing to take up knighthood. The same year he was named one of the justices of the peace for his borough; and on the grant of a new charter showed great zeal in defending the rights of the commoners, and succeeded in procuring an alteration in the charter in their favour, exhibiting much warmth of temper during the dispute and being committed to custody by the privy council for angry words spoken against the mayor, for which he afterwards apologized. He also defended the rights of the commoners of Ely threatened by the "adventurers" who had drained the Great Level, and he was nicknamed afterwards by a royalist newspaper "Lord of the Fens." He was again later the champion of the commoners of St Ives in the Long Parliament

<sup>1</sup> *Life of Sir H. Vane*, by W. W. Ireland, 222.

against enclosures by the earl of Manchester, obtaining a commission of the House of Commons to inquire into the case, and drawing upon himself the severe censure of the chairman, the future Lord Clarendon, by his "impetuous carriage" and "insolent behaviour," and by the passionate vehemence he imparted into the business. Bishop Williams, a kinsman of Cromwell's, relates at this time that he was "a common spokesman for sectaries, and maintained their part with great stubbornness"; and his earliest extant letter (in 1635) is an appeal for subscriptions for a puritan lecturer. There appears to be no foundation for the statement that he was stopped by an order of council when on the point of abandoning England for America, though there can be little doubt that the thoughts of emigration suggested themselves to his mind at this period. He viewed the "innovations in religion" with abhorrence. According to Clarendon he told the latter in 1641 that if the Grand Remonstrance had not passed "he would have sold all he had the next morning and never have seen England more." In 1631 he converted his landed property into money, and John Hampden, his cousin, a patentee of Connecticut in 1632, was on the point of emigrating. Cromwell was perhaps arrested in his project by his succession in 1636 to the estate of his uncle Sir Thomas Steward, and to his office of farmer of the cathedral tithes at Ely, whither he now removed. Meanwhile, like Bunyan and many other puritans, Cromwell had been passing through a trying period of mental and religious change and struggle, beginning with deep melancholy and religious doubt and depression, and ending with "seeing light" and with enthusiastic and convinced faith, which remained henceforth the chief characteristic and impulse in his career.

He represented Cambridge in the Short and Long Parliaments of 1640, and at once showed extraordinary zeal and audacity in his opposition to the government, taking a large share in business and serving on numerous and important committees. As the cousin of Hampden and St. John he was intimately associated with the leaders of the parliamentary party. His sphere of action, however, was not in parliament. He was not an orator, and though he could express himself forcibly on occasion, his speech was incoherent and devoid of any of the arts of rhetoric. Clarendon notes on his first appearance in parliament that "he seemed to have a person in no degree gracious, no ornament of discourse, none of those talents which use to reconcile the affections of the standers by; yet as he grew into place and authority his parts seemed to be renewed." He supported stoutly the extreme party of opposition to the king, but did not take the lead except on a few less important occasions, and was apparently silent in the debates on the Petition of Right, the Grand Remonstrance and the Militia. His first recorded intervention in debate in the Long Parliament was on the 9th of November 1640, a few days after the meeting of the House, when he delivered a petition from the imprisoned John Lilburne. He was described by Sir Philip Warwick on this occasion:—"I came into the House one morning well clad and perceived a gentleman speaking whom I knew not, very ordinarily apparelled; for it was a plain cloth suit which seemed to have been made by an ill country tailor; his linen was plain and not very clean; . . . his stature was of a good size; his sword stuck close to his side; his countenance swollen and reddish; his voice sharp and untunable and his eloquence full of fervour . . . I sincerely profess it much lessened my reverence as to that great council for he was very much hearkened unto." On the 30th of December he moved to the second reading of Strode's bill for annual parliaments. His chief interest from the first, however, lay in the religious question. He belonged to the Root and Branch party, and spoke in favour of the petition of the London citizens for the abolition of episcopacy on the 9th of February 1641, and pressed upon the House the Root and Branch Bill in May. On the 6th of November he carried a motion entrusting the train-bands south of the Trent to the command of the earl of Essex. On the 14th of January 1642, after the king's attempt to seize the five members, he moved for a committee to put the kingdom in a

*Cromwell's first parliamentary efforts.*

posture of defence. He contributed £600 to the proposed Irish campaign and £500 for raising forces in England—large sums from his small estate—and on his own initiative in July 1642 sent arms of the value of £100 down to Cambridge, seized the magazine there in August, and prevented the king's commission of array from being executed in the county, taking these important steps on his own authority and receiving subsequently indemnity by vote of the House of Commons. Shortly afterwards he joined Essex with sixty horse, and was present at Edgehill, where his troop was one of the few not routed by Rupert's charge, Cromwell himself being mentioned among those officers who "never stirred from their troops but fought till the last minute."

During the earlier part of the year 1643 the military position of Charles was greatly superior to that of the parliament. Essex was inactive near Oxford; in the west Sir Ralph Hopton had won a series of victories, and in the north Newcastle defeated the Fairfaxes at Adwalton Moor, and all Yorkshire except Hull was in his hands. It seemed likely that the whole of the north would be laid open and the royalists be able to march upon London and join Charles and Hopton there. This stroke, which would most probably have given the victory to the king, was prevented by the "Eastern Association," a union of Norfolk, Suffolk, Essex, Cambridgeshire and Hertfordshire, constituted in December 1642 and augmented in 1643 by Huntingdonshire and Lincolnshire, of which Cromwell was the leading spirit. His zeal and energy met everywhere with conspicuous success. In January 1643 he seized the royalist high sheriff of Hertfordshire in the act of proclaiming the king's commission of array at St Albans; in February he was at Cambridge taking measures for the defence of the town; in March suppressing royalist risings at Lowestoft and Lynn; in April those of Huntingdon, when he also recaptured Crowland from the king's party. In May he defeated a greatly superior royalist force at Grantham, proceeding afterwards to Nottingham in accordance with Essex's plan of penetrating into Yorkshire to relieve the Fairfaxes; where, however, difficulties, arising from jealousies between the officers, and the treachery of John Hotham, whose arrest Cromwell was instrumental in effecting, obliged him to retire again to the association, leaving the Fairfaxes to be defeated at Adwalton Moor. He showed extraordinary energy, resource and military talent in stemming the advance of the royalists, who now followed up their victories by advancing into the association; he defeated them at Gainsborough on the 28th of July, and managed a masterly retreat before overwhelming numbers to Lincoln, while the victory on the 11th of October at Winceby finally secured the association, and maintained the wedge which prevented the junction of the royalists in the north with the king in the south.

One great source of Cromwell's strength was the military reforms he had initiated. At Edgehill he had observed the inferiority of the parliamentary to the royalist horse, composed as it was of soldiers of fortune and the dregs of the populace. "Do you think," he had said, "that the spirits of such base, mean fellows will ever be able to encounter gentlemen that have honour and courage and resolution in them? You must get men of a spirit that is likely to go as far as gentlemen will go or you will be beaten still." The royalists were fighting for a great cause. To succeed the parliamentary soldiers must also be inspired by some great principle, and this was now found in religion. Cromwell chose his own troops, both officers and privates, from the "religious men," who fought not for pay or for adventure, but for their faith. He declared, when answering a complaint that a certain captain in his regiment was a better preacher than fighter, that he who prayed best would fight best, and that he knew nothing could "give the like courage and confidence as the knowledge of God in Christ will." The superiority of these men—more intelligent than the common soldiers, better disciplined, better trained, better armed, excellent horsemen and fighting for a great cause—not only over the other parliamentary troops but over the royalists, was soon observed in battle. According to Clarendon the latter, though frequently victorious in a charge,

could not rally afterwards, "whereas Cromwell's troops if they prevailed, or though they were beaten and routed, presently rallied again and stood in good order till they received new orders"; and the king's military successes dwindled in proportion to the gradual preponderance of Cromwell's troops in the parliamentary army. At first these picked men only existed in Cromwell's own troop, which, however, by frequent additions became the nucleus of a regiment, and by the time of the New Model included about 11,000 men.

In July 1643 Cromwell had been appointed governor of the Isle of Ely; on the 22nd of January 1644 he became second in command under the earl of Manchester as lieutenant-general of the Eastern Association, and on the 16th of February 1644 a member of the Committee of Both Kingdoms with greatly increased influence. In March he took Hillesden House in Buckinghamshire; in May was at the siege of Lincoln, when he repulsed Goring's attempt to relieve the town, and subsequently took part in Manchester's campaign in the north. At Marston Moor (*q.v.*) on the 2nd of July he commanded all the horse of the Eastern Association, with some Scottish troops; and though for a time disabled by a wound in the neck, he charged and routed Rupert's troops opposed to him, and subsequently went to the support of the Scots, who were hard pressed by the enemy, and converted what appeared at one time a defeat into a decisive victory. It was on this occasion that he earned the nickname of "Ironsides," applied to him now by Prince Rupert, and afterwards to his soldiers, "from the impenetrable strength of his troops which could by no means be broken or divided."

The movements of Manchester after Marston Moor were marked by great apathy. He was one of the moderate party who desired an accommodation with the king, and was opposed to Cromwell's sectaries. He remained at Lincoln, did nothing to prevent the defeat of Essex's army in the west, and when he at last advanced south to join Essex's and Waller's troops his management of the army led to the failure of the attack upon the king at Newbury on the 27th of October 1644. He delayed supporting the infantry till too late, and was repulsed; he allowed the royal army to march past his outposts; and a fortnight afterwards, without any attempt to prevent it, and greatly to Cromwell's vexation, permitted the moving of the king's artillery and the relief of Donnington Castle by Prince Rupert. "If you beat the king ninety-nine times," Manchester urged at Newbury, "yet he is king still and so will his posterity be after him; but if the king beat us once we shall all be hanged and our posterity be made slaves." "My lord," answered Cromwell, "if this be so, why did we take up arms at first? This is against fighting ever hereafter. If so let us make peace, be it ever so base." The contention brought to a crisis the struggle between the moderate Presbyterians and the Scots on the one side, who decided to maintain the monarchy and fought for an accommodation and to establish Presbyterianism in England, and on the other the republicans who would be satisfied with nothing less than the complete overthrow of the king, and the Independents who regarded the establishment of Presbyterianism as an evil almost as great as that of the Church of England. On the 25th of November Cromwell charged Manchester with "unwillingness to have the war prosecuted to a full victory"; which Manchester answered by accusing Cromwell of having used expressions against the nobility, the Scots and Presbyterianism; of desiring to fill the army of the Eastern Association with Independents to prevent any accommodation; and of having vowed if he met the king in battle he would as lief fire his pistol at him as at anybody else. The lords and the Scots vehemently took Manchester's part; but the Commons eventually sided with Cromwell, appointed Sir Thomas Fairfax general of the New Model Army, and passed two self-denying ordinances, the second of which, ordering all members of both houses to lay down their commissions within forty days, was accepted by the lords on the 3rd of April 1645.

Meanwhile Cromwell had been ordered on the 3rd of March by the House to take his regiment to the assistance of Waller, under whom he served as an admirable subordinate. "Although

*Begin-  
ning of  
Civil War.*

*Crom-  
well's  
soldiers.*

he was blunt," says Waller, "he did not bear himself with pride or disdain. As an officer he was obedient and did never dispute my orders or argue upon them." He returned on the 19th of April, and on the 23rd was sent to Oxfordshire to prevent a junction between Charles and Prince Rupert, in which he succeeded after some small engagements and the storming of Blechingdon House. His services were felt to be too valuable to be lost, and on the 10th of May his command was prolonged for forty days. On the 28th he was sent to Ely for the defence of the eastern counties against the king's advance; and on the 10th of June, upon Fairfax's petition, he was named by the Commons lieutenant-general, joining Fairfax on the 13th with six hundred horse. At the decisive battle of Naseby (the 14th

*The  
battle of  
Naseby.*

of June 1645) he commanded the parliamentary right wing and routed the cavalry of Sir Marmaduke Langdale, subsequently falling upon and defeating the royalist centre, and pursuing the fugitives as far as the outskirts of Leicester. At Langport again, on the 10th of July 1645, his management of the troops was largely instrumental in gaining the victory. As the king had no longer a field army, the war after Naseby resolved itself into a series of sieges which Charles had no means of raising. Cromwell was present at the sieges of Bridgwater, Bath, Sherborne and Bristol; and later, in command of four regiments of foot and three of horse, he was employed in clearing Wiltshire and Hampshire of the royalist garrisons. He took Devizes and Laycock House, Winchester and Basing House, and rejoined Fairfax in October at Exeter, and accompanied him to Cornwall, where he assisted in the defeat of Hopton's forces and in the suppression of the royalists in the west. On the 9th of January 1646 he surprised Lord Wentworth's brigade at Bovey Tracey, and was present with Fairfax at the fall of Exeter on the 9th of April. He then went to London to give an account of proceedings to the parliament, was thanked for his services and rewarded with the estate of the marquess of Worcester. He was present again with Fairfax at the capitulation of Oxford on the 24th of June, which practically terminated the Civil War, when he used his influence in favour of granting lenient terms. He then removed with his family from Ely to Drury Lane, London, and about a year later to King Street, Westminster.

The war being now over, the great question of the establishment of Presbyterianism or Independency had to be decided. Cromwell, without naming himself an adherent of any denomination, fought vigorously for Independency as a policy. In 1644 he had remonstrated at the removal by Crawford of an anabaptist lieutenant-colonel. "The state," he said, "in choosing men to serve it, takes no notice of their opinions. If they be willing faithfully to serve it, that satisfies. Take heed of being sharp . . . against those to whom you can object little but that they square not with you in every opinion concerning matters of religion." He had patronized Lilburne and welcomed all into his regiment, and the Independents had spread from his troops throughout the whole army. But while the sectarians were in a vast majority in the army, the parliament was equally strong in Presbyterianism and opposed to toleration. The proposed disbandment of the army in February 1647 would have placed the soldiers entirely in the power of the parliament; while the negotiations of the king, first with the Scots and then with the parliament, appeared to hazard all the fruits of victory. The petition from the army to the parliament for arrears of pay was suppressed and the petitioners declared enemies of the state. In consequence the army organized a systematic opposition, and elected representatives styled Agitators or Agents to urge their claims.

Cromwell, though greatly disliking the policy of the Presbyterians, yet gave little support at first to the army in resisting parliament. In May 1647 in company with Skippon, Ireton and Fleetwood, he visited the army, inquired into and reported on the grievances, and endeavoured to persuade them to submit to the parliament. "If that authority falls to nothing," he said, "nothing can follow but confusion." The Presbyterians, however, now engaged in

a plan for restoring the king under their own control, and by the means of a Scottish army, forced on their policy, and on the 27th of May ordered the immediate disbandment of the army, without any guarantee for the payment of arrears. A mutiny was the consequence. The soldiers refused to disband, and on the 3rd of June Cromwell, whom, it was believed, the parliament intended to arrest, joined the army. "If he would not forthwith come and lead them," they had told him, "they would go their own way without him." The supremacy of the army without a guiding hand meant anarchy, that of the Presbyterians the outbreak of another civil war.

Possession of the king's person now became an important consideration. On the 31st of May 1647 Cromwell had ordered Cornet Joyce to prevent the king's removal by the parliament or the Scots from Holmby, and Joyce by his own authority and with the king's consent brought him to Newmarket to the headquarters of the army. Cromwell soon restored order, and the representative council, including privates as well as officers chosen to negotiate with the parliament, was subordinated to the council of war. The army with Cromwell then advanced towards London. In a letter to the city, possibly written by Cromwell himself, the officers repudiated any wish to alter the civil government or upset the establishment of Presbyterianism, but demanded religious toleration. Subsequently, in the declaration of the 14th of June, arbitrary power either in the parliament or in the king was denounced, and demand was made for a representative parliament, the speedy termination of the actual assembly, and the recognition of the right to petition. Cromwell used his influence in restraining the more eager who wished to march on London immediately, and in avoiding the use of force by which nothing permanent could be effected, urging that "whatsoever we get by treaty will be firm and durable. It will be conveyed over to posterity." The army faction gradually gathered strength in the parliament. Eleven Presbyterian leaders impeached by the army withdrew of their own accord on the 26th of June, and the parliament finally yielded. Fairfax was appointed sole commander-in-chief on the 10th of July, the soldiers levied to oppose the army were dismissed, and the command of the city militia was again restored to the committee approved by the army. These votes, however, were cancelled later, on the 26th of July, under the pressure of the royalist city mob which invaded the two Houses; but the two speakers, with eight peers and fifty-seven members of the Commons, themselves joined the army, which now advanced to London, overawing all resistance, escorting the fugitive members in triumph to Westminster on the 6th of August, and obliging the parliament on the 20th to cancel the last votes, with the threat of a regiment of cavalry drawn up by Cromwell in Hyde Park.

Cromwell and the army now turned with hopes of a settlement to Charles. On the 4th of July Cromwell had had an interview with the king at Caversham. He was not insensible to Charles's good qualities, was touched by the paternal affection he showed for his children, and is said to have declared that Charles "was the uprightest and most conscientious man of his three kingdoms." The *Heads of the Proposals*, which, on Charles raising objections, had been modified by the influence of Cromwell and Ireton, demanded the control of the militia and the choice of ministers by parliament for ten years, a religious toleration, and a council of state to which much of the royal control over the army and foreign policy would be delegated. These proposals without doubt largely diminished the royal power, and were rejected by Charles with the hope of maintaining his sovereign rights by "playing a game," to use his own words, *i.e.* by negotiating simultaneously with army and parliament, by inflaming their jealousies and differences, and finally by these means securing his restoration with his full prerogatives unimpaired. On the 9th of September Charles refused once more the *Newcastle Propositions* offered him by the parliament, and Cromwell, together with Ireton and Vane, obtained the passing of a motion for a new application; but the terms asked by the parliament were higher than before and included a harsh condition—the

*Parliament and the army.*

exclusion from pardon of all the king's leading adherents, besides the indefinite establishment of Presbyterianism and the refusal of toleration to the Roman Catholics and members of the Church of England.

Meanwhile the failure to come to terms with Charles and provide a settlement appeared to threaten a general anarchy. Cromwell's moderate counsels created distrust in his good faith amongst the soldiers, who accused him of "prostituting the liberties and persons of all the people at the foot of the king's interest." The agitators demanded immediate settlement by force by the army. The extreme republicans, anticipating Rousseau, put forward the *Agreement of the People*. This was strongly opposed by Cromwell, who declared the very consideration of it had dangers, that it would bring upon the country "utter confusion" and "make England like Switzerland." Universal suffrage he rejected as tending "very much to anarchy," spoke against the hasty abolition of either the monarchy or the Lords, and refused entirely to consider the abstract principles brought into the debate. Political problems were not to be so resolved, but practically. With Cromwell as with Burke the question was "whether the spirit of the people of this nation is prepared to go along with it." The special form of government was not the important point, but its possibility and its acceptability. The great problem was to found a stable government, an authority to keep order. If every man should fight for the best form of government the state would come to desolation. He reproached the soldiers for their insubordination against their officers, and the army for its rebellion against the parliament. He would lay hold of anything "if it had but the force of authority," rather than have none. Cromwell's influence prevailed and these extreme proposals were laid aside.

Meanwhile all hopes of an accommodation with Charles were dispelled by his flight on the 11th of November from Hampton Court to Carisbroke Castle in the Isle of Wight, his object being to negotiate independently with the Scots, the parliament and the army. His action, however, in the event, diminished rather than increased his chances of success, owing to the distrust of his intentions which it inspired. Both the army and the parliament gave cold replies to his offers to negotiate; and Charles, on the 27th of December 1647, entered into the *Engagement with the Scots* by which he promised the establishment of Presbyterianism for three years, the suppression of the Independents and their sects, together with privileges for the Scottish nobles, while the Scots undertook to invade England and restore him to his throne. This alliance, though the exact terms were not known to Cromwell—"the attempt to vassalize us to a foreign nation," to use his own words—convinced him of the uselessness of any plan for maintaining Charles on the throne; though he still appears to have clung to monarchy, proposing in January 1648 the transference of the crown to the prince of Wales. A week after the signing of the treaty he supported a proposal for the king's deposition, and the vote of *No Addresses* was carried. Meanwhile the position of Charles's opponents had been considerably strengthened by the suppression of a dangerous rebellion in November 1647 by Cromwell's intervention, and by the return of troops to obedience. Cromwell's difficulties, however, were immense. His moderate and trimming attitude was understood neither by the extreme Independents nor by the Presbyterians. He made one attempt to reconcile the disputes between the army and the politicians by a conference, but ended the barren discussion on the relative merits of aristocracies, monarchies and democracies, interspersed with Bible texts, by throwing a cushion at the speaker's head and running downstairs. On the 19th of January 1648 Cromwell was accused of high treason by Lilburne. Plots were formed for his assassination. He was overtaken by a dangerous illness, and on the 2nd of March civil war in support of the king broke out.

Cromwell left London in May to suppress the royalists in Wales, and took Pembroke Castle on the 11th of July. Meanwhile behind his back the royalists had risen all over England, the

fleet in the Downs had declared for Charles, and the Scottish army under Hamilton had invaded the north. Immediately on the fall of Pembroke Cromwell set out to relieve Lambert, who was slowly retreating before Hamilton's superior forces; he joined him near Knaresborough on the 12th of August, and started next day in pursuit of Hamilton in Lancashire, placing himself at Stonyhurst near Preston, cutting off Hamilton from the north and his allies, and defeating him in detail on the 17th, 18th and 19th at Preston and at Warrington. He then marched north into Scotland, following the forces of Monro, and established a new government of the Argyle faction at Edinburgh; replying to the Independents who disapproved of his mild treatment of the Presbyterians, that he desired "union and right understanding between the godly people, Scots, English, Jews, Gentiles, Presbyterians, Anabaptists and all; . . . a more glorious work in our eyes than if we had gotten the sacking and plunder of Edinburgh . . . and made a conquest from the Tweed to the Orcades."

The incident of the Second Civil War and the treaty with the Scots exasperated Cromwell against the king. On his return to London he found the parliament again negotiating with Charles, and on the eve of making a treaty which Charles himself had no intention of keeping and regarded merely as a means of regaining his power, and which would have thrown away in one moment all the advantages gained during years of bloodshed and struggle. Cromwell therefore did not hesitate to join the army in its opposition to the parliament, and supported the Remonstrance of the troops (20th of November 1648), which included the demand for the king's punishment as "the grand author of all our troubles," and justified the use of force by the army if other means failed. The parliament, however, continued to negotiate, and accordingly Charles was removed by the army to Hurst Castle on the 1st of December, the troops occupied London on the 2nd; while on the 6th and 7th Colonel Pride "purged" the House of Commons of the Presbyterians. Cromwell was not the originator of this act, but showed his approval of it by taking his seat among the fifty or sixty Independent members who remained.

The disposal of the king was now the great question to be decided. During the next few weeks Cromwell appears to have made once more attempts to come to terms with Charles; but the king was inflexible in his refusal to part with the essential powers of the monarchy, or with the Church; and at the end of December it was resolved to bring him to trial. The exact share which Cromwell had in this decision and its sequel is obscure, and the later accounts of the regicides when on their trial at the Restoration, ascribing the whole transaction to his initiation and agency, cannot be altogether accepted. But it is plain that, once convinced of the necessity for the king's execution, he was the chief instrument in overcoming all scruples among his judges, and in resisting the protests and appeals of the Scots. To Algernon Sidney, who refused to take part in proceedings on the plea that neither the king nor any man could be tried by such a court, Cromwell replied, "I tell you, we will cut off his head with the crown upon it."

The execution of the king took place on the 30th of January 1649. This event, the turning-point in Cromwell's career, casts a shadow, from one point of view, over the whole of his future statesmanship. He himself never repented of the act, regarding it, on the contrary, as "one which Christians in after times will mention with honour and all tyrants in the world look at with fear," and as one directly ordained by God. Opinions, no doubt, will always differ as to the wisdom or authority of the policy which brought Charles to the scaffold. On the one hand, there was no law except that of force by which an offence could be attributed to the sovereign, the anointed king, the source of justice. The ordinance establishing the special tribunal for the trial was passed by a remnant of the House of Commons alone, from which all dissentients were excluded by the army. The tribunal was composed, not of judges—for all unanimously refused to sit on it—but of

*Flight of the king.*

*Cromwell supports the Remonstrance.*

*The execution of Charles I.*



fifty-two men drawn from among the king's enemies. The execution was a military and not a national act, and at the last scene on the scaffold the triumphant shouts of the soldiery could not overwhelm the groans and sobs raised by the populace. Whatever crimes might be charged against Charles, his past conduct might appear to be condoned by the act of negotiating with him. On the other hand, the execution seemed to Cromwell the only alternative to anarchy, or to a return to despotism and the abandonment of all they had fought for. Cromwell had exhausted every expedient for arriving at an arrangement with the king by which the royal authority might be preserved, and the repeated perfidy and inexhaustible shiftiness of Charles had proved the hopelessness of such attempts. The results produced by the king's execution were far-reaching and permanent. It is true that Puritan austerity and the lack of any strong central authority after Oliver's death produced a reaction which temporarily restored Charles's dynasty to the throne; but it is not less true that the execution of the king, at a later time when all over Europe absolute monarchies "by divine right" were being established on the ruins of the ancient popular constitutions, was an object lesson to all the world; and it produced a profound effect, not only in establishing constitutional monarchy in Great Britain after James II., with the dread of his father's fate before him, had abdicated by flight, but in giving the impulse to that revolt against the idea of "the divinity that doth hedge a king" which culminated in the Revolution of 1789, and of which the mighty effects are still evident in Europe and beyond.

The king and the monarchy being now destroyed in England, Cromwell had next to turn his attention to the suppression of royalism in Ireland and in Scotland. In Ireland Cromwell in Ormonde had succeeded in uniting the English and the Irish in a league against the supporters of the parliament, and only a few scattered forts held out for the Commonwealth, while the young king was every day expected to land and complete the conquest of the island. Accordingly in March 1649 Cromwell was appointed lord-lieutenant and commander-in-chief for its reduction. But before starting he was called upon to suppress disorder at home. He treated the Levellers with some severity and showed his instinctive dislike to revolutionary proposals. "Did not that levelling principle," he said, "tend to the reducing of all to an equality? What was the purport of it but to make the tenant as liberal a fortune as the landlord, which I think if obtained would not have lasted long." Equally characteristic was his treatment of the mutinous army, in which he suppressed a rebellion in May. He landed at Dublin on the 13th of August. Before his arrival the Dublin garrison had defeated Ormonde with a loss of 5000 men, and Cromwell's work was limited to the capture of detached fortresses. On the 10th of September he stormed Drogheda, and by his order the whole of its 2800 defenders were put to the sword without quarter. Cromwell, who was as a rule especially scrupulous in protecting non-combatants from violence, justified his severity in this case by the cruelties perpetrated by the Irish in the rebellion of 1641, and as being necessary on military and political grounds in that it "would tend to prevent the effusion of blood for the future, which were the satisfactory grounds of such actions which otherwise cannot but work remorse and regret." After the fall of Drogheda Cromwell sent a few troops to relieve Londonderry, and marched himself to Wexford, which he took on the 11th of October, and where similar scenes of cruelty were repeated; every captured priest, to use Cromwell's own words, being immediately "knocked on the head," though the story of the three hundred women slaughtered in the market-place has no foundation.

The surrender of Trim, Dundalk and Ross followed, but at Waterford Cromwell met with a stubborn resistance and the advent of winter obliged him to raise the siege. Next year Cromwell penetrated into Munster. Cashel, Cahir and several castles fell in February, and Kilkenny in March; Clonmel repulsing the assault with great loss, but surrendering on the 10th of May 1650. Cromwell himself sailed a fortnight later,

leaving the reduction of the island, which was completed in 1652, to his generals. The re-settlement of the conquered and devastated country was now organized on the Tudor and Straffordian basis of colonization from England, conversion to Protestantism, and establishment of law and order. Cromwell thoroughly approved of the enormous scheme of confiscation and colonization, causing great privations and sufferings, which was carried out. The Roman Catholic landowners lost their estates, all or part according to their degree of guilt, and these were distributed among Cromwell's soldiers and the creditors of the government; Cromwell also invited new settlers from home and from New England, two-thirds of the whole land of Ireland being thus transferred to new proprietors. The suppression of Roman Catholicism was zealously pursued by Cromwell; the priests were hunted down and imprisoned or exiled to Spain or Barbados, the mass was everywhere forbidden, and the only liberty allowed was that of conscience, the Romanist not being obliged to attend Protestant services.

These methods, together with education, "assiduous preaching . . . humanity, good life, equal and honest dealing with men of different opinion," Cromwell thought, would convert the whole island to Protestantism. The law was ably and justly administered, and Irish trade was admitted to the same privileges as English, enjoying the same rights in foreign and colonial trade; and no attempt was made to subordinate the interests of the former to the latter, which was the policy adopted both before and after Cromwell's time, while the union of Irish and English interests was further recognized by the Irish representation at Westminster in the parliaments of 1654, 1656 and 1659. These advantages, however, scarcely benefited at all the Irish Roman Catholics, who were excluded from political life and from the corporate towns; and Cromwell's union meant little more than the union of the English colony in Ireland with England. A just administration, too, did not compensate for unjust laws or produce contentment; the policy of conversion and colonization was unsuccessful, the descendants of many of Cromwell's soldiers becoming merged in the Roman Catholic Irish, and the union with England, political and commercial, being extinguished at the Restoration. Cromwell's land settlement—modified by the restoration under Charles II. of about one-third of the estates to the royalists—survived, and added to the difficulties with which the English government was afterwards confronted in Ireland.

Meanwhile Cromwell had hurried home to deal with the royalists in Scotland. He urged Fairfax to attack the Scots at once in their own country and to forestall their invasion; but Fairfax refused and resigned, and Cromwell was appointed by parliament, on the 26th of June 1650, commander-in-chief of all the forces of the Commonwealth. He entered Scotland in July, and after a campaign in the neighbourhood of Edinburgh which proved unsuccessful in drawing out the Scots from their fortresses, he retreated to Dunbar to await reinforcements from Berwick. The Scots under Leslie followed him, occupied Doon Hill commanding the town, and seized the passes between Dunbar and Berwick which Cromwell had omitted to secure. Cromwell was outmanœuvred and in a perilous situation, completely cut off from England and from his supplies except from the sea. But Leslie descended the hill to complete his triumph, and Cromwell immediately observed the disadvantages of his antagonist's new position, cramped by the hill behind and separated from his left wing. A stubborn struggle on the next day, the 3rd of September, gave Cromwell a decisive victory. Advancing, he occupied Edinburgh and Leith. At first it seemed likely that his victories and subsequent remonstrances would effect a peace with the Scots; but by 1651 Charles II. had succeeded in forming a new union of royalists and presbyterians, and another campaign became inevitable. Some delay was caused in beginning operations by Cromwell's dangerous illness, during which his life was despaired of; but in June he was confronting Leslie entrenched in the hills near Stirling, impregnable to attack and refusing an engagement. Cromwell determined to turn his antagonist's

*The battles of Dunbar and Worcester.*

position. He sent 14,000 men into Fifeshire and marched to Perth, which he captured on the 2nd of August, thus cutting off Leslie from the north and his supplies. This movement, however, left open the way to England, and Charles immediately marched south, in reality thus giving Cromwell the wished-for opportunity of crushing the royalists finally and decisively. Cromwell followed through Yorkshire, and uniting with Lambert and Harrison at Evesham proceeded to attack the royalists at Worcester; where on the 3rd of September after a fierce struggle the great victory, "the crowning mercy" which terminated the Civil War, was obtained over Charles.

Monk completed the subjugation of Scotland by 1654. The settlement here was made on more moderate lines than in Ireland. The estates of only twenty-four leaders of the defeated cause were forfeited by Cromwell, and the national church was left untouched though deprived of all powers of interference with the civil government, the general assembly being dissolved in 1653. Large steps were made towards the union of the two kingdoms by the representation of Scotland in the parliament at Westminster; free trade between the two countries was established, the administration of justice greatly improved, vassalage and heritable jurisdictions abolished, and security and good order maintained by the council of nine appointed by the Protector. In 1658 the improved condition of Scotland was the subject of Cromwell's special congratulation in addressing parliament. But as in Ireland so Cromwell's policy in Scotland was unpopular and was only upheld by the maintenance of a large army, necessitating heavy taxation and implying the loss of the national independence. It also vanished at the Restoration.

On the 12th of September 1651 Cromwell made his triumphal entry into London at the conclusion of his victorious campaigns; and parliament granted him Hampton Court as a residence with £4000 a year. These triumphs, however, had all been obtained by force of arms; the more difficult task now awaited Cromwell of governing England by parliament and by law. As Milton wrote:—

"Cromwell! our chief of men, who through a cloud  
Not of war only, but detractions rude,  
Guided by faith and matchless fortitude,  
To peace and truth thy glorious way hast ploughed,  
Peace hath her victories  
No less renowned than war."

Cromwell's moderation and freedom from imperiousness were acknowledged even by those least friendly to his principles. Although the idol of his victorious army, and in a position enabling him to exercise autocratic power, he laboured unostentatiously for more than a year and a half as a member of the parliament, whose authority he supported to the best of his ability. While occupied with work on committees and in administration he pressed forward several schemes of reform, including a large measure of law reform prepared by a commission presided over by Matthew Hale, and the settlement of the church; but very little was accomplished by the parliament, which seemed to be almost exclusively taken up with the maintenance and increase of its own powers; and Cromwell's dissatisfaction, and that of the army which increased every day, was intensified by the knowledge that the parliament, instead of dissolving for a new election, was seeking to perpetuate its tenure of power. At length, in April 1653, a "bill for a new representation" was discussed, which provided for the retention of their seats by the existing members without re-election, so that they would also be the sole judges of the eligibility of the rest. This measure, which placed the whole powers of the state—executive, legislative, military and judicial—in the hands of one irresponsible and permanent chamber, "the horridlest arbitrariness that ever was exercised in the world," Cromwell and the army determined to resist at all costs. On the 15th of April they proposed that the parliament should appoint a provisional government and dissolve itself. This compromise was refused by the parliament, which proceeded on the 20th to press through its last stages the "bill for a new representation." Cromwell hastened to the House, and at the last moment, on

the bill being put to the vote, whispering to Harrison, "This is the time; I must do it," he rose, and after alluding to the former good services of the parliament, proceeded to overwhelm the members with reproaches. Striding up and down the House in a passion, he made no attempt to control himself, and turning towards individuals as he hurled significant epithets at each, he called some "whoremasters," others "drunkards, corrupt, unjust, scandalous to the profession of the Gospel." "Perhaps you think," he exclaimed, "that this is not parliamentary language; I confess it is not, neither are you to expect any such from me." In reply to a complaint of his violence he cried, "Come, come, I will put an end to your prating. You are no parliament, I say you are no parliament. I will put an end to your sitting." By his directions Harrison then fetched in a small band of Cromwell's musketeers and compelled the speaker Lenthall to vacate the chair. Looking at the mace he said, "What shall we do with this hauble?" and ordered a soldier to take it away. The members then trooped out, Cromwell crying after them, "It is you that have forced me to this; for I have sought the Lord night and day that He would rather slay me than put me upon the doing this work." He then snatched the obnoxious bill from the clerk, put it under his cloak, and commanding the doors to be locked went back to Whitehall. In the afternoon he dissolved the council in spite of John Bradshaw's remonstrances, who said, "Sir, we have heard what you did at the House this morning . . . ; but you are mistaken to think that the parliament is dissolved, for no power under heaven can dissolve them but themselves; therefore take you notice of that." Cromwell had no patience with formal pedantry of this sort; and in point of strict legality "The Rump" of the Long Parliament had little better title to authority than the officers who expelled it from the House. After this Cromwell had nothing left but the army with which to govern, and "henceforth his life was a vain attempt to clothe that force in constitutional forms, and make it seem something else so that it might become something else."<sup>1</sup>

By the dissolution of the Long Parliament Cromwell as commander-in-chief was left the sole authority in the state. He determined immediately to summon another parliament. This was the "Little" or "Barebones Parliament," consisting of one hundred and forty persons selected by the council of officers from among those nominated by the congregations in each county, which met on the 4th of July 1653. This assembly, however, soon showed itself impracticable and incapable, and on the 12th of December the speaker, followed by the more moderate members, marched to Whitehall and returned their powers to Cromwell, while the rest were expelled by the army.

Cromwell, who had no desire to exercise arbitrary power and whose main object therefore was to devise some constitutional limit to the authority which circumstances had placed in his hands, now accepted the written constitution drawn up by some of the officers, called the *Instrument of Government*, the earliest example of a "fixed government" based on "fundamentals," or constitutional guarantees, and the only example of it in English history. Its authors had wished Oliver to assume the title of king, but this he repeatedly refused; and in the instrument he was named Protector, a parliament was established, limited in powers but whose measures were not restricted by the Protector's veto unless they contravened the constitution, the Protector's executive power being also limited by the council. The Protector and the council together were given a life tenure of office, with a large army and a settled revenue sufficient for public needs in time of peace; while the clauses relating to religion "are remarkable as laying down for the first time with authority a principle of toleration,"<sup>2</sup> though this toleration did not apply to Roman Catholics and Anglicans. On the 16th of December 1653 Cromwell was installed in his new office, dressed as a civilian in a plain black coat instead of in scarlet as a general, in order

<sup>1</sup> C. H. Firth, *Cromwell*, p. 324.

<sup>2</sup> John Morley, *Oliver Cromwell*, p. 393.

*Cromwell  
expels  
the Long  
Parliament*

to demonstrate that military government had given place to civil; for he approached his task in the same spirit that had prompted his declaration to the Little Parliament of his wish "to divest the sword of all power in the Civil administration."

In the interval between his nomination as Protector and the summoning of his first parliament in September 1654, Cromwell was empowered together with his council to legislate by ordinances; and eighty-two were issued in all, dealing with numerous and various reforms and including the reorganization of the treasury, the settlement of Ireland and Scotland and the union of the three kingdoms, the relief of poor prisoners, and the maintenance of the highways. These ordinances in many instances showed the hand of the true statesman. Cromwell was essentially a conservative reformer; in his attempts to purge the court of chancery of its most flagrant abuses, and to settle the ecclesiastical affairs of the nation, he showed himself anxious to retain as much of the existing system as could be left untouched without doing positive evil. He was out-voted by his council on the question of commutation of tithes, and his enlightened zeal for reforming the "wicked and abominable" sentences of the criminal law met with complete failure. Most of these ordinances were subsequently confirmed by parliament, and, "on the whole, this body of dictatorial legislation, abnormal in form as it is, in substance was a real, wise and moderate set of reforms."<sup>1</sup> His ordinances for the "Reformation of Manners," the product of the puritan spirit, had but a transitory effect. The Long Parliament had ordered a strict observance of Sunday, punished swearing severely, and made adultery a capital crime; Cromwell issued further ordinances against duelling, swearing, race-meetings and cock-fights—the last as tending to the disturbance of the public peace and the encouragement of "dissolute practices to the dishonour of God." Cromwell himself was no ascetic and saw no harm in honest sport. He was exceedingly fond of horses and hunting, leaping ditches prudently avoided by the foreign ambassadors. Baxter describes him as full of animal spirits, "naturally of such a vivacity, hilarity and alacrity as another man is when he hath drunken a cup of wine too much," and notes his "familiar rustic carriage with his soldiers in sporting." He was fond of music and of art, and kept statues in Hampton Court Gardens which scandalized good puritans. He preferred that Englishmen should be free rather than sober by compulsion. Writing to the Scottish clergy, and rejecting their claim to suppress dissent in order to extirpate error, he said, "Your pretended fear lest error should step in is like the man who would keep all wine out of the country lest men should be drunk. It will be found an unjust and unwise jealousy to deprive a man of his natural liberty upon a supposition he may abuse it. When he doth abuse it, judge." It is probable that very little of this moral legislation was enforced in practice, though special efforts were made under the government of the major-generals. Cromwell expected more results from the effects of education and culture. A part of the revenue of confiscated church lands was allotted to the maintenance of schools, and the question of national education was seriously taken in hand by the Commonwealth. Cromwell was especially interested in the universities. In 1649 he had been elected D.C.L. at Oxford, and in 1651 chancellor of the University, an office which he held till 1657, when he was succeeded by his son Richard. He founded a new readership in Divinity, and presented Greek MSS. to the Bodleian. He appointed visitors for the universities and great public schools, and defended the universities from the attacks of the extreme sectaries who clamoured for their abolition, even Clarendon allowing that Oxford "yielded a harvest of extraordinary good and sound knowledge in all parts of learning." In 1657 he founded a new university at Durham, which was suppressed at the Restoration. He patronized learning. Milton and Marvell were his secretaries. He allowed the royalists Hobbes and Cowley to return to England, and lived in friendship with the poet Waller.

<sup>1</sup> Frederic Harrison, *Oliver Cromwell*, p. 214.

Cromwell's religious policy included the maintenance of a national church, a policy acceptable to the army but much disliked by the Scots, who wanted the church to control the state, not the state the church. He improved the incomes of poor livings by revenues derived from episcopal estates and the fines of delinquents. An important feature of his church government was the appointment on the 20th of March 1654 of the "Triers," thirty-eight clerical and lay commissioners, who decided upon the qualifications of candidates for livings, and without whose recommendation none could be appointed; while an ordinance of August 1654 provided for the removal of the unfit, the latter class including besides immoral persons those holding "popish" or blasphemous opinions, those publicly using the English Prayer Book, and the disaffected to the government. Religious toleration was granted, but with the important exception that some harsh measures were enacted against Anglicans and Roman Catholics, to neither of whom was liberty of worship accorded. The acts imposing fines for recusancy, repealed in 1650, were later executed with great severity. In 1655 a proclamation was issued for administering the laws against the priests and Jesuits, and some executions were carried out. Complete toleration in fact was only extended to Protestant nonconformists, who composed the Cromwellian established church, and who now meted out to their antagonists the same treatment which they themselves were later to receive under the *Clarendon Code* of Charles II.

Cromwell himself, however, remained throughout a staunch and constant upholder of religious toleration. "I had rather that Mahommedanism were permitted amongst us," he avowed, "than that one of God's children should be persecuted." Far in advance of his contemporaries on this question, whenever his personal action is disclosed it is invariably on the side of forbearance and of moderation. It is probable, from the absence of evidence to the contrary, that much of this severe legislation was never executed, and it was without doubt Cromwell's restraining hand which moderated the narrow persecuting spirit of the executive. In practice Anglican private worship appears to have been little interfered with; and although the recusant fines were rigorously exacted, the same seems to have been the case with the private celebration of the mass. Bordeaux, the French envoy in England, wrote that, in spite of the severe laws, the Romanists received better treatment under the Protectorate than under any other government. Cromwell's strong personal inclination towards toleration is clearly seen in his treatment of the Jews and Quakers. He was unable, owing to the opposition of the divines and of the merchants, to secure the full recognition of the right to reside in England of the former who had for some time lived in small numbers and traded unnoticed and untroubled in the country; but he obtained an opinion from two judges that there was no law which forbade their return, and he gave them a private assurance of his protection, with leave to celebrate their private worship and to possess a cemetery.

Cromwell's policy in this instance was not overturned at the Restoration, and the great Jewish immigration into England with all its important consequences may be held to date practically from these first concessions made by Cromwell. His personal intervention also alleviated the condition of the Quakers, much persecuted at this time. In an interview in 1654 the sincerity and enthusiasm of George Fox had greatly moved Cromwell and had convinced him of their freedom from dangerous political schemes. He ordered Fox's liberation, and in November 1657 issued a general order directing that Quakers should be treated with leniency, and be discharged from confinement. Doctrines directly attacking Christianity Cromwell regarded, indeed, as outside toleration and to be punished by the civil power, but at the same time he mitigated the severity of the penalty ordained by the law. In general the toleration enjoyed under Cromwell was probably far larger than at any period since religion became the contending ground of political parties, and certainly greater than under his immediate successors.

*Cromwell's church policy.*

*His religious toleration.*

Lilburne and the anabaptists, and John Rogers and the Fifth Monarchy men, were prosecuted only on account of their direct attacks upon the government, and Cromwell in his broad-minded and tolerant statesmanship was himself in advance of his age and his administration. He believed in the spiritual and unseen rather than in the outward and visible unity of Christendom.

In foreign policy Cromwell's chief aims appear to have been to support and extend the Protestant faith, to promote English trade, and to prevent a Stuart restoration by foreign aid—the religious mission of England in the world, her commercial interests, and her political independence being indissolubly connected in his mind. The beginning of his rule inherited a war with France and Holland; the former consequent on Cromwell's failure to obtain terms for the Huguenots or the cession of Dunkirk, and the latter—for which he was not responsible—the result of commercial rivalry, of disputes concerning the rights of neutrals, of bitter memories of Dutch misdeeds in the East Indies, and of dynastic causes arising from the stadtholder, William II. of Orange, having married Mary, daughter of Charles I. In 1651 the Dutch completed a treaty with Denmark to injure English trade in the Baltic; to which England replied the same year by the Navigation Act, which suppressed the Dutch trade with the English colonies and the Dutch fish trade with England, and struck at the Dutch carrying trade. War was declared in May 1652 after a fight between Blake and Tromp off Dover, and was continued with signal victories and defeats on both sides till 1654. The religious element, however, which predominated in Cromwell's foreign policy inclined him to peace, and in April of that year terms were arranged by which England on the whole was decidedly the gainer. The Dutch acknowledged the supremacy of the English flag in the British seas, which Tromp had before refused; they accepted the Navigation Act, and undertook privately to exclude the princes of Orange from the command of their forces. The Protestant policy was further followed up by treaties with Sweden and Denmark which secured the passage of the Sound for English ships on the same conditions as the Dutch, and a treaty with Portugal which liberated English subjects from the Inquisition and allowed commerce with the Portuguese colonies. The two great Roman Catholic powers now both bid for Cromwell's alliance. Cromwell wisely inclined towards France, for Spain was then a greater menace than France alike to the Protestant cause and to the growth of British trade in the western hemisphere; but as no concessions could be gained from either France or Spain, the year 1654 closed without a treaty being made with either. In December 1654 Penn and Venables sailed for the West Indies with orders to attack the Spanish colonies and the French shipping; and for the first time since the Plantagenets an English fleet appeared in the Mediterranean, where Blake upheld the supremacy of the English flag, made a treaty with the dey of Algiers, destroyed the castles and ships of the dey of Tunis at Porto Farina on the 4th of April 1655, and liberated the English prisoners captured by the pirates.

The incident of the massacre of the Protestant Vaudois at this time decided Cromwell's policy in favour of France. In response to Cromwell's splendid championship of the persecuted people—which has been well described as “one of the noblest memories of England”—France undertook to put pressure upon Savoy, in consequence of which the persecution ceased for a time; but Cromwell's intervention had less practical effect than has generally been supposed, though “never was the great conception of a powerful state having duties along with interests more magnanimously realized.”<sup>1</sup> The treaty of Pinerolo withdrew the edict ordering the persecutions, but they were soon afterwards renewed, and in 1658 formed the subject of another remonstrance by Cromwell to Louis XIV. in his last extant public letter before his death. The treaty of Westminster (24th of October 1655) dealt chiefly with commercial subjects, and contained a clause promising the expulsion from France of political exiles. Meanwhile the West Indian expedition had been defeated

<sup>1</sup> John Morley, *Oliver Cromwell*, p. 483.

at Hispaniola, and war was declared by Spain, who now promised help to Charles II. for regaining his throne. Cromwell sent powerful English fleets to watch the coast of Spain and to prevent communications with the West Indies and America; on the 8th of September 1656 a fleet of treasure ships was destroyed off Cadiz by Stayner, and on the 20th of April 1657 Blake performed his last exploit in the destruction of the whole Spanish fleet of sixteen treasure ships in the harbour of Santa Cruz in Teneriffe. These naval victories were followed by a further military alliance with France against Spain, termed the treaty of Paris (the 23rd of March 1657). Cromwell furnished 6000 men with a fleet to join in the attack upon Spain in Flanders, and obtained as reward Mardyke and Dunkirk, the former being captured and handed over on the 3rd of October 1657, and the latter after the battle of the Dunes on the 4th of June 1658, when Cromwell's Ironsides were once more pitted against English royalists fighting for the Spaniards.

Such was the character of Cromwell's policy abroad. The inspiring principle had been the defence and support of Protestantism, the question with Cromwell being “whether the Christian world should be all popery.” He desired England to be everywhere the protector of the oppressed and the upholder of “true religion.” His policy was in principle the policy of Elizabeth, of Gustavus Adolphus, and—in the following generation—of William of Orange. He appreciated, without overestimating, the value of England's insular position. “You have accounted yourselves happy,” he said in January 1658, “in being environed by a great ditch from all the world beside. Truly you will not be able to keep your ditch nor your shipping unless you turn your ships and shipping into troops of horse and companies of foot, and fight to defend yourselves on *terra firma*.” He did not regard himself merely as the trustee of the national resources. These were not to be employed for the advancement of English interests alone. “God's interest in the world,” he declared, “is more extensive than all the people of these three nations. God has brought us hither to consider the work we may do in the world as well as at home.” In 1653 he had made the astonishing proposal to the Dutch that England and Holland should divide the habitable globe outside Europe between them, that all states maintaining the Inquisition should be treated as enemies by both the proposed allies, and that the latter “should send missionaries to all peoples willing to receive them, to inculcate the truth of Jesus Christ and the Holy Gospel.” Great writers like Milton and Harrington supported Cromwell's view of the duty of a statesman; the poet Waller acclaimed Cromwell as “the world's protector”; but the London tradesmen complained of the loss of their Spanish trade and regarded Holland and not Spain as the national enemy. But Cromwell's dream of putting himself at the head of European Protestantism never even approached realization. War broke out between the Protestant states of Sweden, Denmark, Holland and Brandenburg, with whom religion was entirely subordinated to individual aims and interests, and who were far from rising to Cromwell's great conceptions; while the Vaudois were soon subjected to fresh persecutions. On the other hand, Cromwell could justly boast “there is not a nation in Europe but is very willing to ask a good understanding with you.” He raised England to a predominant position among the Powers of Europe, and anticipated the triumphs of the elder Pitt. “It was hard to discover,” wrote Clarendon, “which feared him most, France, Spain or the Low Countries.” The vigour and success with which he organized the national resources and upheld the national honour, asserted the British sovereignty of the seas, defended the oppressed, and caused his name to be feared and respected in foreign courts where that of Stuart was despised and neglected, command praise and admiration equally from contemporaries and from modern critics, from his friends and from his opponents. “He once more joined us to the continent,” wrote Marvell, while Dryden describes him as teaching the British lion to roar. “Cromwell's greatness at home,” said Clarendon, “was a mere shadow of his greatness abroad.” “It is strange,” wrote Pepys in 1667 under a different régime, “how everybody nowadays reflect upon Oliver and

commend him, what brave things he did, and made all the neighbour princes fear him." To Cromwell more than to any other British ruler belongs the credit of having laid the foundation of England's maritime supremacy and of her over-sea empire.

Cromwell's colonial policy aimed definitely at the recognition and extension of the British empire. By March 1652 the whole

*Cromwell and the empire.*

of the territory governed by the Stuarts had submitted to the authority of the Commonwealth, and the Navigation Act of the 9th of October 1651, by which colonial goods could only be imported to England in British ships and all foreign trade to the colonies was restricted to products of the exporting country, sought to bind the colonies to England and to support the interests of the shipowners and merchants, and therefore of the English maritime supremacy, the act being, moreover, memorable as the first public measure which treated the colonies as a whole and as an integral part of Great Britain. The hindrance, however, to the general development of trade which the act involved aroused at once loud complaints, to which Cromwell turned a deaf ear, continuing to seize Dutch ships trading in forbidden goods. In the internal administration of the colonies Cromwell interfered very little, maintaining specially friendly relations with the New Englanders, and showing no jealousy of their desire for self-government. The war with France, Holland and Spain offered opportunities of gaining additional territory. A small expedition sent by Cromwell in February 1654 to capture New Amsterdam (New York) from the Dutch was abandoned on the conclusion of peace, and the fleet turned to attack the French colonies; Major Robert Sedgwick taking with a handful of men the fort of St John's, Port Royal or Annapolis, and the French fort on the river Penobscot, the whole territory from this river to the mouth of the St Lawrence remaining British territory till its cession in 1667. In December 1654 Cromwell despatched Penn and Venables with a fleet of thirty-eight ships and 2500 soldiers to the West Indies, their numbers being raised by recruits at the islands to 7000 men. The attack on Hispaniola, however, was a disastrous failure, and though a landing at Jamaica and the capture of the capital, Santiago de la Vega, was effected, the expedition was almost annihilated by disease; and Penn and Venables returned to England, when Cromwell threw them into the Tower. Cromwell, however, persevered, reminding Fortescue, who was left in command, that the war was one against the "Roman Babylon," that they were "fighting the Lord's battles"; and he sent out reinforcements under Sedgwick, offering inducements to the New Englanders to migrate to Jamaica. In spite of almost insuperable difficulties the colony took root, trade began, the fleet lay in wait for the Spanish treasure ships, the settlements of the Spaniards were raided, and their repeated attempts to retake the island were successfully resisted. In 1658 Colonel Edward Doyley, the governor, gained a decisive victory over thirty companies of Spanish foot, and sent ten of their flags to Cromwell. The Protector, however, did not live to witness the final triumph of his undertaking, which gave to England, as he had wished, "the mastery of those seas," ensuring the English colonies against Spanish attacks, and being maintained and followed up at the Restoration.

Meanwhile, the first parliament of the Protectorate had met in September 1654. A scheme of electoral reform had been

*Parliamentary difficulties.*

carried by which members were taken from the small and corrupt boroughs and given to the large hitherto unrepresented towns, and which provided for thirty representatives from Scotland and from Ireland. Instead, however, of proceeding with the work of practical legislation, accepting the Instrument of Government without challenge as the basis of its authority, the parliament immediately began to discuss and find fault with the constitution and to debate about "Fundamentals." About a hundred members who refused to engage not to attempt to change the form of government were excluded on the 12th of September. The rest sat on, discussing the constitution, drawing up lists of damnable heresies and of incontrovertible articles of faith, producing plans for the reduction of the army and demanding

for themselves its control. Incensed by the dilatory and factious proceedings of the House, Cromwell dismissed the parliament on the 22nd of January 1655. Various dangerous plots against his government and person were at this time rife. Vane, Ludlow, Robert Overton, Harrison and Major Wildman, the head of the Levellers, were all arrested, while the royalist rising under Penruddock was crushed in Devonshire. Other attacks upon his authority were met with the same resort to force. The judges and lawyers began to question the legality of his ordinances, and to doubt their competency to convict royalist prisoners of treason. A merchant named Cony refused to pay customs not imposed by parliament, his counsel declaring their levy by ordinance to be contrary to Magna Carta, and Chief Justice Rolle resigning in order to avoid giving judgment. Cromwell was thus inevitably drawn farther along the path of arbitrary government. He arrested the persons who refused to pay taxes, and sent Cony's lawyers to the Tower. Hitherto he had been scrupulously impartial in raising the best men to the judicial bench, including the illustrious Matthew Hale, but he now appointed compliant judges, and, alluding to Magna Carta in terms impossible to transcribe for modern readers, declared that "it should not control his actions which he knew were for the safety of the Commonwealth." The country was now divided into twelve districts each governed by a major-general, to whom was entrusted the duty of maintaining order, stamping out disaffection and plots, and executing the laws relating to public morals. They had power to transport royalists and those who could not produce good characters, and supported themselves by a special tax of 10% on the incomes of the royalist gentry. Enormous numbers of ale-houses were closed—a proceeding which excited intense resentment and was probably no slight cause of the royalist reaction. Still more serious an encroachment upon the constitution perhaps even than the institution of the major-generals was Cromwell's tampering with the municipal franchise by confiscating the charters, depriving the burgesses, now hostile to his government, of their parliamentary votes, and limiting the franchise to the corporation; thereby corrupting the national liberties at their very source, and introducing an evil precedent only too readily followed by Charles II. and James II.

*The major-generals.*

It was in these embarrassed and perilous circumstances that Cromwell summoned a new parliament in the summer of 1656. In spite of the influence and interference of the major-generals a large number of members hostile to the government were returned, of whom Cromwell's council immediately excluded nearly a hundred.

*Refusal of the crown.*

The major-generals were the object of general attack, while the special tax on the royalists was declared unjust, and the bill for its continuation rejected by a large majority. An attempt at the assassination of Cromwell by Miles Sindercombe added to the general feeling of anxiety and unrest. The military rule excited universal hostility; there was an earnest desire for a settled and constitutional government, and the revival of the monarchy in the person of Cromwell appeared the only way of obtaining it. On the 23rd of February 1657 the *Remonstrance* offering Cromwell the crown was moved by Sir Christopher Packe in the parliament and violently resisted by the officers and the army party, one hundred officers waiting upon Cromwell on the 27th to petition against his acceptance of it. On the 25th of March the *Remonstrance*, now termed the *Petition and Advice*, and including a new scheme of government, was passed by a majority of 123 to 62 in spite of the opposition of the officers; and on the 31st it was presented to Cromwell in the Banqueting House at Whitehall whence Charles I. had stepped out on to the scaffold. Cromwell replied by requesting a brief delay to ask counsel of God and his own heart. On the 8th of May about thirty officers presented a petition to parliament against the revival of the monarchy, and Fleetwood, Desborough and Lambert threatened to lay down their commissions. Accordingly Cromwell the same day refused the crown definitely, greatly to the astonishment both of his followers and his enemies, who considered his decision a fatal neglect of an opportunity of



consolidating his rule and power. In particular, his acceptance of the crown would have guaranteed his followers, under the act of Henry VII., from liability in the future to the charge of high treason for having given allegiance to himself as a *de facto* king. Cromwell himself, however, seems to have regarded the question of title as of secondary importance, as merely (to use his own words) "a feather in the hat," "a shining bauble for crowds to gaze at or kneel to." "Your father," wrote Sir Francis Russell to Henry Cromwell, "hath of late made more wise men fools than ever; he laughs and is merry, but they hang down their heads and are pitifully out of countenance."

On the 25th of May the petition was presented to Cromwell again, with the title of Protector substituted for that of King, and he now accepted it. On the 26th of June 1657 he was once more installed as Protector, this time, however, with regal ceremony in contrast with the simple formalities observed on the first occasion, the heralds proclaiming his accession in the same manner as that of the kings. Cromwell's government seemed now established on the firmer footing of law and national approval, he himself obtaining the powers though not the title of a constitutional monarch, with a permanent revenue of £1,300,000 for the ordinary expenses of the administration, the command of the forces, the right to nominate his successor and, subject to the approval of parliament, the members of the council and of the new second chamber now established, while at the same time the freedom of parliament was guaranteed in its elections. Difficulties, however, appeared immediately the parliament got to work. The republicans hostile to the Protectorate, excluded before, now returned, took the places vacated by strong supporters of Cromwell who had been removed to the Lords, and attacked the authority of the new chamber, opened communications with the disaffected in the city and army, protested against unparliamentary taxation and arbitrary imprisonment, and demanded again the supremacy of parliament. In consequence Cromwell summoned both Houses to his presence on the 4th of February 1658, and having pointed out the perils to which they were once more exposing the state, dissolved parliament, dismissing the members with the words, "let God be judge between me and you."

During the period following the dissolution Cromwell's power appeared outwardly at least to be at its height. The revolts of royalists and sectaries against his government had been easily suppressed, and the various attempts to assassinate him, contemptuously referred to by Cromwell as "little fiddling things," were anticipated and prevented by an excellent system of police and spies, and by his bodyguard of 160 men. The victory at Dunkirk increased his reputation, while Louis XIV. showed his respect for the ruler of England by the splendid reception given to the Protector's envoy, Lord Fauconberg, and by a complimentary mission despatched to England.

The great career, the incidents of which we have been following, was now, however, drawing to a close. Cromwell's health had long been impaired by the hardships of campaigning. Now at the age of 58 he was already old, and his firm, strong signature had become feeble and trembling. The responsibilities and anxieties of government unassisted by parliament, and the continued struggle against the force of anarchy, weighed upon him and exhausted his physical powers. "It has been hitherto," Cromwell said, "a matter of, I think, but philosophical discourse, that a great place, a great authority, is a great burthen. I know it is." "I can say in the presence of God, in comparison of whom we are but like poor creeping ants upon the earth, I would have lived under my woodside to have kept a flock of sheep rather than undertook such a government as this." "I doubt not to say," declared his steward Maidston, "it drank up his spirits, of which his natural constitution afforded a vast stock, and brought him to his grave."

Domestic bereavements added further causes of grief and of weakened vitality. On the 6th of February 1658 he lost his favourite daughter, Elizabeth Claypole, and he was much cast down by the shock of his bereavement and of her long sufferings. Shortly afterwards he fell ill of an intermittent fever, but seemed

to recover. On the 20th of August George Fox met him riding at the head of his guards in the park at Hampton Court, but declared "he looked like a dead man." The next day he again fell ill and was removed from Hampton Court to Whitehall, where his condition became worse. The anecdotes believed and circulated by the royalists that Cromwell died in all the agonies of remorse and fear are entirely false. On the 31st of August he seemed to rally, and one who slept in his bedchamber and who heard him praying, declared, "a public spirit to God's cause did breathe in him to the very last." *Death.* During the next few days he grew weaker and resigned himself to death. "I would," he said, "be willing to be further serviceable to God and his people, but my work is done." For the first time doubts as to his spiritual state seemed to have troubled him. "Tell me is it possible to fall from grace?" he asked the attendant minister. "No, it is not possible," the latter replied. "Then," said Cromwell, "I am safe, for I know that I was once in grace." He refused medicine to induce sleep, declaring "it is not my design to drink or to sleep, but my design is to make what haste I can to be gone." Towards the morning of the 3rd of September he again spoke, "using divers holy expressions, implying much inward consolation and peace," together with "some exceeding self-debasing words, annihilating and judging himself." He died on the afternoon of the same day, his day of triumph, the anniversary both of Dunbar and of Worcester. His body was privately buried in the chapel of Henry VII. in Westminster Abbey, the public funeral taking place on the 23rd of November, with great ceremony and on the same scale as that of Philip II. of Spain, and costing the enormous sum of £60,000. At the Restoration his body was exhumed, and on the 30th of January 1661, the anniversary of the execution of Charles I., it was drawn on a sledge from Holborn to Tyburn, together with the bodies of Ireton and Bradshaw, accompanied by "the universal outcry and curses of the people." There it was hanged on a gallows, and in the evening taken down, when the head was cut off and set up upon Westminster Hall, where it remained till as late as 1684, the trunk being thrown into a pit underneath the gallows. According to various legends Cromwell's last burial place is stated to be Westminster Abbey, Naseby Field or Newburgh Abbey; but there appears to be no evidence to support them, or to create any reasonable doubt that the great Protector's dust lies now where it was buried, in the neighbourhood of the present Connaught Square.

As a military commander Cromwell was as prompt as Gustavus, as ardent as Condé, as exact as Turenne. These, moreover, were soldiers from their earliest years. Condé's fame was established in his twenty-second year, Gustavus was twenty-seven and Turenne thirty-three at the beginning of their careers as commanders-in-chief. Cromwell, on the other hand, was forty-three when he fought in his first battle. In less than two years he had taken his rank as one of the great cavalry leaders of history. His campaigns of 1648 and 1651 placed him still higher as a great commander. Worcester, his crowning victory, has been indicated by a German critic as the prototype of Sedan. Yet his early military education could have consisted at most of the perusal of the *Swedish Intelligencer* and the practice of riding. It is not, therefore, strange that Cromwell's first essays in war were characterised more by energy than technical skill. It was some time before he realized the spirit of cavalry tactics, of which he was later so complete a master. At first he speaks with complacency of a *mêlée*, and reports that he and his men "agreed to charge" the enemy. But before long he came to understand, as no other commander of the age save Gustavus understood it, the value of true "shock-action." Of Marston Moor he writes, "we never charged but we routed them"; and thereafter his battles were decided by the shock of closed squadrons, the fresh impulse of a second and even a third line, and above all by the unquestioning discipline and complete control over their horses to which he trained his men. This gave them not merely greater steadiness, but, what was far more important, the power of rallying and reforming for a second effort. The Royalist cavalry was

*Cromwell's military genius.*

disorganized by victory as often as by defeat, and illustrated on numerous fields the now discredited maxim that cavalry cannot charge twice in one day. Cromwell shares with Frederick the Great the credit of founding the modern cavalry spirit. As a horsemaster he was far superior to Murat. His marches in the eastern campaign of 1643 show a daily average at one time of 28 m. as against the 21 of Murat's cavalry in the celebrated pursuit after Jena. And this result he achieved with men of less than two years' service, men, too, more heavily equipped and worse mounted than the veterans of the *Grande Armée*. It has been said that his battles were decided by shock action; the real emphasis should be laid upon the word "decided." The swift, unhesitating charge was more than unusual in the wars of the time, and was possible only because of the peculiar earnestness of the men who fought the English war. The professional soldiers of the Continent could rarely be brought to force a decision; but the English, contending for a cause, were imbued with the spirit of the modern "nation in arms"; and having taken up arms wished to decide the quarrel by arms. This feeling was not less conspicuous in the far-ranging rides, or raids, of the Cromwellian cavalry. At one time, as in the case of Blechingdon, they would perform strange exploits worthy of the most daring hussars; at another their speed and tenacity paralysed armies. Not even Sheridan's horsemen in 1864-65 did their work more effectively than did the English squadrons in the Preston campaign. Cromwell appreciated this feeling at its exact worth, and his pre-eminence in the Civil War was due to this highest gift of a general, the power of feeling the pulse of his army. Resolution, vigour and clear sight marked his conduct as a commander-in-chief. He aimed at nothing less than the annihilation of the enemy's forces, which Clausewitz was the first to define, a hundred and fifty years later, as the true objective of military operations. Not merely as exemplifying the tactical envelopment, but also as embodying the central idea of grand strategy, was Worcester the prototype of Sedan. The contrast between a campaign of Cromwell's and one of Turenne's is far more than remarkable, and the observation of a military critic who maintains that Cromwell's art of war was two centuries in advance of its time, finds universal acceptance.

At a time when throughout the rest of Europe armies were manœuvring against one another with no more than a formal result, the English and Scots were fighting decisive battles; and Cromwell's battles were more decisive than those of any other leader. Until his fiery energy made itself felt, hardly any army on either side actually suffered rout; but at Marston Moor and Naseby the troops of the defeated party were completely dissolved, while at Worcester the royalist army was annihilated. Dunbar attested his constancy and gave proof that Cromwell was a master of the tactics of all arms. Preston was an example like Austerlitz of the two stages of a battle as defined by Napoleon, the first *flottante*, the second *foudroyante*.

Cromwell's strategic manœuvres, if less adroit than those of Turenne or Montecuccoli, were, in accordance with his own genius and the temper of his army, directed always to forcing a decisive battle. That he was also capable of strategy of the other type was clear from his conduct of the Irish War. But his chief work was of a different kind and done on a different scale. The greatest feat of Turenne was the rescue of one province in 1674-1675; Cromwell, in 1648 and again in 1651, had two-thirds of England and half of Scotland for his theatre of war. Turenne levelled down his methods to suit the ends which he had in view. The task of Cromwell was far greater. Any comparison between the generalship of these two great commanders would therefore be misleading, for want of a common basis. It is when he is contrasted with other commanders, not of the age of Louis XIV., but of the Civil War, that Cromwell's greatness is most conspicuous. Whilst others busied themselves with the application of the accepted rules of the Dutch, the German, and other formal schools of tactical thought, Cromwell almost alone saw clearly into the heart of the questions at issue, and evolved the strategy, the tactics, and the training suited to the work to which he had set his hand.

Cromwell's career as a statesman has been already traced in its different spheres, and an endeavour has been made to show the breadth and wisdom of his conceptions and at the same time the cause of the immediate failure of his constructive policy. Whether if Cromwell had survived he would have succeeded in gradually establishing legal government is a question which can never be answered. His administration as it stands in history is undoubtedly open to the charge that after abolishing the absolutism of the ancient monarchy he substituted for it, not law and liberty, but a military tyranny far more despotic than the most arbitrary administration of Charles I. The statement of Vane and Ludlow, when they refused to acknowledge Cromwell's government, that it was "in substance a re-establishment of that which we all engaged against," was true. The levy of ship money and customs by Charles sinks into insignificance beside Cromwell's wholesale taxation by ordinances; the inquisitional methods of the major-generals and the unjust and exceptional taxation of royalists outdid the scandals of the extra-legal courts of the Stuarts; the shipment of British subjects by Cromwell as slaves to Barbados has no parallel in the Stuart administration; while the prying into morals, the encouragement of informers, the attempt to make the people religious by force, were the counterpart of the Laudian system, and Cromwell's drastic treatment of the Irish exceeded anything dreamed of by Strafford. He discovered that parliamentary government after all was not the easy and plain task that Pym and Vane had imagined, and Cromwell had in the end no better justification of his rule than that which Strafford had suggested to Charles I.,—"parliament refusing (to give support and co-operation in carrying on the government) you are acquitted before God and man." The fault was no doubt partly Cromwell's own. He had neither the patience nor the tact for managing loquacious parliamentary pedants. But the chief responsibility was not his but theirs. John Morley (*Oliver Cromwell*, p. 297) has truly observed of the execution of Charles I., that it was "an act of war, and was just as defensible or just as assailable, and on the same grounds, as the war itself." The parliamentary party took leave of legality when they took up arms against the sovereign, and it was therefore idle to dream of a formally legal sanction for any of their subsequent revolutionary proceedings. An entirely fresh start had to be made. A new foundation had to be laid on which a new system of legality might be reared. It was for this that Cromwell strove. If the Rump or the Little Parliament had in a business-like spirit assumed and discharged the functions of a constituent assembly, such a foundation might have been provided. It was only when five years had passed since the death of the king without any "settlement of the nation" being arrived at, that Cromwell at last accepted a constitution drafted by his military officers, and attempted to impose it on the parliament. And it was not until the parliament refused to acknowledge the Instrument as the required starting point for the new legality, that Cromwell in the last resort took arbitrary power into his hands as the only method remaining for carrying on the government. For much as he hated arbitrariness, he hated anarchy still more. While therefore Cromwell's administration became in practice little different from that of Strafford, the aims and ideals of the two statesmen had nothing in common. It is therefore profoundly true, as observed by S. R. Gardiner (*Cromwell*, p. 315), that "what makes Cromwell's biography so interesting in his perpetual effort to walk in the paths of legality—an effort always frustrated by the necessities of the situation. The man—it is ever so with the noblest—was greater than his work." The nature of Cromwell's statesmanship is to be seen rather in his struggles against the retrograde influences and opinions of his time, in the many political reforms anticipated though not originated or established by himself, and in his religious, perhaps fanatical, enthusiasm, than in the outward character of his administration, which, however, in spite of its despotism shows itself in its inner spirit of justice, patriotism and self-sacrifice, so immeasurably superior to that of the Stuarts.

Cromwell's personal character has been inevitably the subject of unceasing controversy. According to Clarendon he was "a brave bad man," with "all the wickedness against which damnation is pronounced and for which hell fire is prepared." Yet he cannot deny that "he had some virtues which have caused the memory of some men in all ages to be celebrated"; and admits that "he was not a man of blood," and that he possessed "a wonderful understanding in the natures and humour of men," and "a great spirit, an admirable circumspection and sagacity and a most magnanimous resolution." According to contemporary republicans he was a mere selfish adventurer, sacrificing the national cause "to the idol of his own ambition." Richard Baxter thought him a good man who fell before a great temptation. The writers of the next century generally condemned him as a mixture of knave, fanatic and hypocrite, and in 1839 John Forster endorsed Landor's verdict that Cromwell lived a hypocrite and died a traitor. These crude ideas of Cromwell's character were extinguished by Macaulay's irresistible logic, by the publication of Cromwell's letters by Carlyle in 1845, which showed Cromwell clearly to be "not a man of falsehoods, but a man of truth"; and by Gardiner, whom, however, it is somewhat difficult to follow when he represents Cromwell as "a typical Englishman." In particular that conception which regarded "ambition" as the guiding motive in his career has been dispelled by a more intimate and accurate knowledge of his life; this shows him to have been very little the creator of his own career, which was largely the result of circumstances outside his control, the influence of past events and of the actions of others, the pressure of the national will, the natural superiority of his own genius. "A man never mounts so high," Cromwell said to the French ambassador in 1647, "as when he does not know where he is going." "These issues and events," he said in 1656, "have not been forecast, but were providences in things." His "hypocrisy" consists principally in the Biblical language he employed, which with Cromwell, as with many of his contemporaries, was the most natural way of expressing his feelings, and in the ascription of every incident to the direct intervention of God's providence, which was really Cromwell's sincere belief and conviction. In later times Cromwell's character and administration have been the subject of almost too indiscriminate eulogy, which has found tangible shape in the statue erected to his memory at Westminster in 1899. Here Cromwell's effigy stands in the midst of the sanctuaries of the law, the church, and the parliament, the three foundations of the state which he subverted, and in sight of Whitehall where he destroyed the monarchy in blood. Yet Cromwell's monument is not altogether misplaced in such surroundings, for in him are found the true principles of piety, of justice, of liberty and of governance.

John Maidston, Cromwell's steward, gives the "character of his person." "His body was compact and strong, his stature under six foot (I believe about two inches), his head so shaped as you might see it a storehouse and a shop both of a vast treasury of natural parts." "His temper exceeding fiery, as I have known, but the flame of it, . . . kept down for the most part, was soon allayed with those moral endowments he had. He was naturally compassionate towards objects in distress even to an effeminate measure; though God had made him a heart wherein was left little room for fear, . . . yet did he exceed in tenderness towards sufferers. A larger soul I think hath seldom dwelt in a house of clay than his was. I believe if his story were impartially transmitted and the unprejudiced world well possessed with it, she would add him to her nine worthies." By his wife Elizabeth Bourchier, Cromwell had four sons, Robert (who died in 1639), Oliver (who died in 1644 while serving in his father's regiment), Richard, who succeeded him as Protector, and Henry. He also had four daughters. Of these Bridget was the wife successively of Ireton and Fleetwood, Elizabeth married John Claypole, Mary was wife of Thomas Belasyse, Lord Fauconberg; and Frances was the wife of Sir Robert Rich, and secondly of Sir John Russell. The last male descendant of the Protector was his great-great-grandson, Oliver Cromwell of Cheshunt, who died

in 1821. By the female line, through his children Henry, Bridget and Frances, the Protector has had numerous descendants, and is the ancestor of many well-known families.<sup>1</sup>

**BIBLIOGRAPHY.**—A detailed bibliography, with the chief authorities for particular periods, will be found in the article in the *Dict. of Nat. Biography*, by C. H. Firth (1888). The following works may be mentioned: S. R. Gardiner's *Hist. of England* (1883–1884) and of the *Great Civil War* (1886), *Cromwell's Place in History* (1897), *Oliver Cromwell* (1901), and *History of the Commonwealth and Protectorate* (1894–1903); *Cromwell*, by C. H. Firth (1900); *Oliver Cromwell*, by J. Morley (1904); *The Last Years of the Protectorate, 1656–1658*, 2 vols., by C. H. Firth (1909); *Oliver Cromwell*, by Fred. Harrison (1903); *Letters and Speeches of Oliver Cromwell*, by T. Carlyle, ed. by S. C. Lomas, with an introd. by C. H. Firth (the best edition, rejecting the spurious Squire papers, 1904); *Oliver Cromwell*, by F. Hoenig (1887); *Oliver Cromwell, the Protector*, by R. F. D. Palgrave (1890); *Oliver Cromwell . . . and the Royalist Insurrection . . . of March 1655*, by the same author (1903); *Oliver Cromwell*, by Theodore Roosevelt (1900); *Oliver Cromwell*, by R. Pauli (tr. 1888); *Cromwell, a Speech delivered at the Cromwell Tercentenary Celebration 1899*, by Lord Rosebery (1900); *The Two Protectors*, by Sir Richard Tangye (valuable for its illustrations, 1899); *Life of Sir Henry Vane*, by W. W. Ireland (1905); *Die Politik des Protectors Oliver Cromwell in der Auffassung und Tätigkeit . . . des Staatssekretärs John Thurloe*, by Freiherr v. Bischofshausen (1899); *Cromwell as a Soldier*, by T. S. Baldock (1899); *Cromwell's Army*, by C. H. Firth (1902); *The Diplomatic Relations between Cromwell and Charles X. of Sweden*, by G. Jones (1897); *The Interregnum*, by F. A. Inderwick (dealing with the legal aspect of Cromwell's rule, 1891); *Administration of the Royal Navy*, by M. Oppenheim (1896); *History of the English Church during the Civil Wars*, by W. Shaw (1900); *The Protestant Interest in Cromwell's Foreign Relations*, by J. N. Bowman (1900); *Cromwell's Jewish Intelligencies* (1891), *Crypto-Jews under the Commonwealth* (1894), *Menasseh Ben Israel's Mission to Oliver Cromwell* (1901), by L. Wolf. (P. C. Y.; C. F. A.; R. J. M.)

**CROMWELL, RICHARD** (1626–1712), lord protector of England, eldest surviving son of Oliver Cromwell and of Elizabeth Bourchier, was born on the 4th of October 1626. He served in the parliamentary army, and in 1647 was admitted a member of Lincoln's Inn. In 1649 he married Dorothy, daughter of Richard Mayor, or Major, of Hursley in Hampshire. He represented Hampshire in the parliament of 1654, and Cambridge University in that of 1656, and in November 1655 was appointed one of the council of trade. But he was not brought forward by his father or prepared in any way for his future greatness, and lived in the country occupied with field sports, till after the institution of the second protectorate in 1657 and the recognition of Oliver's right to name his successor. On the 18th of July he succeeded his father as chancellor of the university of Oxford, on the 31st of December he was made a member of the council of state, and about the same time obtained a regiment and a seat in Cromwell's House of Lords. He was received generally as his father's successor, and was nominated by him as such on his death-bed. He was proclaimed on the 3rd of September 1658, and at first his accession was acclaimed with general favour both at home and abroad. Dissensions, however, soon broke out between the military faction and the civilians. Richard's elevation, not being "general of the army as his father was," was distasteful to the officers, who desired the appointment of a commander-in-chief from among themselves, a request refused by Richard. The officers in the council, moreover, showed jealousy of the civil members, and to settle these difficulties and to provide money a parliament was summoned on the 27th of January 1659, which declared Richard protector, and incurred the hostility of the army by criticizing severely the arbitrary military government of Oliver's last two years, and by impeaching one of the major-generals. A council of the army accordingly established itself in opposition to the parliament, and demanded on the 6th of April a justification and confirmation of former proceedings, to which the parliament replied by forbidding meetings of the army council without the permission of the protector, and insisting that all officers should take an oath not to disturb the proceedings in parliament. The army now broke into open rebellion and assembled at St James's. Richard was completely in their power; he identified himself with their cause, and the same night dissolved the parliament. The Long

<sup>1</sup> Frederic Harrison, *Cromwell*, p. 34.

Parliament (which re-assembled on the 7th of May) and the heads of the army came to an agreement to effect his dismissal; and in the subsequent events Richard appears to have played a purely passive part, refusing to make any attempt to keep his power or to forward a restoration of the monarchy. On the 25th of May his submission was communicated to the House. He retired into private life, heavily burdened with debts incurred during his tenure of office and narrowly escaping arrest even before he quitted Whitehall. In the summer of 1660 he left England for France, where he lived in seclusion under the name of John Clarke, subsequently removing elsewhere, either (for the accounts differ) to Spain, to Italy, or to Geneva. He was long regarded by the government as a dangerous person, and in 1671 a strict search was made for him but without avail. He returned to England about 1680 and lived at Cheshunt, in the house of Sergeant Pengelly, where he died on the 12th of July 1712, being buried in Hursley church in Hampshire. Richard Cromwell was treated with general contempt by his contemporaries, and invidiously compared with his great father. According to Mrs Hutchinson he was "gentle and virtuous but a peasant in his nature and became not greatness." He was nevertheless a man of respectable abilities, of an irreproachable private character, and a good speaker.

**BIBLIOGRAPHY.**—See the article in the *Dict. of Nat. Biography*, and authorities there cited; Noble's *Memoirs of the Protectoral House of Cromwell* (1787); *Memoirs of the Protector . . . and of his Sons*, by O. Cromwell (1820); *The Two Protectors*, by Sir R. Tangye (1899); *Kebleland and a Short Life of Richard Cromwell*, by W. T. Warren (1900); *Letters and Speeches of O. Cromwell*, by T. Carlyle (1904); *Eng. Hist. Review*, xiii. 93 (letters) and xviii. 79; *Cal. of State Papers, Domestic, Lansdowne MSS.*; in British Museum. (P. C. Y.)

**CROMWELL, THOMAS, EARL OF ESSEX** (1485?–1540), born probably not later than 1485 and possibly a year or two earlier, was the only son of Walter Cromwell, *alias* Smyth, a brewer, smith and fuller of Putney. His grandfather, John Cromwell, seems to have belonged to the Nottinghamshire family, of whom the most distinguished member was Ralph, Lord Cromwell (1394?–1456), lord treasurer; and he migrated from Norwell, Co. Notts, to Wimbledon some time before 1461. John's son, Walter, seems to have acquired the *alias* Smyth from being apprenticed to his uncle, William Smyth, "armourer," of Wimbledon. He was of a turbulent, vicious disposition, perpetually being fined in the manor-court for drunkenness, for evading the assize of beer, and for turning more than his proper number of beasts on to Putney Common. Once he was punished for a sanguinary assault, and his connexion with Wimbledon ceased in 1514 when he "falsely and fraudulently erased the evidences and terrures of the lord." Till that time he had flourished like the bay-tree.

Under these circumstances the absence of Thomas Cromwell's name from the Wimbledon manor rolls is almost a presumption of respectability. Perhaps it would be safer to attribute it to Cromwell's absence from the manor. He is said to have quarrelled with his father—no great crime considering the father's character—and fled to Italy, where he served as a soldier in the French army at the battle of the Garigliano (Dec. 1503). He escaped from the battle-field to Florence, where he was befriended by the banker Frescobaldi, a debt which he appears to have repaid with superabundant interest later on. He is next heard of at Antwerp as a trader, and about 1510 he was induced to accompany a Bostonian to Rome in quest of some papal indulgences for a Boston gild; Cromwell secured the boon by the timely present of some choice sweetmeats to Julius II. In 1512 there is some slight evidence that he was at Middelburg, and also in London, engaged in business as a merchant and solicitor. His marriage must have taken place about the same time, judging from the age of his son Gregory. His wife was Elizabeth Wykes, daughter of a well-to-do sheerman of Putney, whose business Cromwell carried on in combination with his own.

For about eight years after 1512 we hear nothing of Cromwell. A letter to him from Cicely, marchioness of Dorset, in which he is seen in confidential business relations with her ladyship, is probably earlier than 1520, and it is possible that Cromwell owed

his introduction to Wolsey to the Dorset family. On the other hand, it is stated that his cousin, Robert Cromwell, vicar of Battersea under the cardinal, gave Thomas the stewardship of the archiepiscopal estate of York House. At any rate he was advising Wolsey on legal points in 1520, and from that date he occurs frequently not only as mentor to the cardinal, but to noblemen and others when in difficulties, especially of a financial character; he made large sums as a money-lender.

In 1523 Cromwell emerges into public life as a member of parliament. The official returns for this election are lost and it is not known for what constituency he sat, but we have a humorous letter from Cromwell describing its proceedings, and a remarkable speech which he wrote and perhaps delivered, opposing the reckless war with France and indicating a sounder policy which was pursued after Wolsey's fall. If, he said, war was to be waged, it would be better to secure Boulogne than advance on Paris; if the king went in person and were killed without leaving a male heir, he hinted there would be civil war; it would be wiser to attempt a union with Scotland, and in any case the proposed subsidy would be a fatal drain on the resources of the realm. Neither Henry nor Wolsey was so foolish as to resent this criticism, and Cromwell lost nothing by it. He was made a collector of the subsidy he had opposed—a doubtful favour perhaps—and in 1524 was admitted at Gray's Inn; but he now became the most confidential servant of the cardinal. In 1525 he was Wolsey's agent in the dissolution of the smaller monasteries which were designed to provide the endowments for Wolsey's foundations at Oxford and Ipswich, a task which gave Cromwell a taste and a facility for similar enterprises on a greater scale later on. For these foundations Cromwell drew up the necessary deeds, and he was receiver-general of cardinal's college, constantly supervising the workmen there and at Ipswich. His ruthless vigour and his accessibility to bribes earned him such unpopularity that there were rumours of his projected assassination or imprisonment. All this constituted a further bond of sympathy between him and his master, and Cromwell grew in Wolsey's favour until his fall. His wife had died in 1527 or 1528, and in July 1529 he made his will, in which one of the chief beneficiaries was his nephew, Richard Williams, *alias* Cromwell, the great-grandfather of the protector.

Wolsey's disgrace reduced Cromwell to such despair that Cavendish once found him in tears and at his prayers "which had been a strange sight in him afore." Many of the cardinal's servants had been taken over by the king, but Cromwell had made himself particularly obnoxious. However, he rode to court from Esher to "make or mar," as he himself expressed it, and offered his services to Norfolk. Possibly he had already paved the way by the pensions and grants which he induced Wolsey to make through him, out of the lands and revenues of his bishoprics and abbeys, to nobles and courtiers who were hard pressed to keep up the lavish style of Henry's court. Cromwell could be most useful to the government in parliament, and the government, represented by Norfolk, undertook to use its influence in procuring him a seat, on the natural understanding that Cromwell should do his best to further government business in the House of Commons. This was on the 2nd of November 1529; the elections had been made, and parliament was to meet on the morrow. A seat was, however, found or made for Cromwell at Taunton. He signalized himself by a powerful speech in opposition to the bill of attainder against Wolsey which had already passed the Lords. The bill was thrown out, possibly with Henry's connivance, though no theory has yet explained its curious history so completely as the statement of Cavendish and other contemporaries, that its rejection was due to the arguments of Cromwell. Doubtless he championed his fallen chief not so much for virtue's sake as for the impression it would make on others. He did not feel called upon to accompany Wolsey on his exile from the court.

Cromwell had now, according to Cardinal Pole, whose story has been too readily accepted, been converted into an "emissary of Satan" by the study of Machiavelli's *Prince*. In the one interview which Pole had with Cromwell, the latter, so Pole

wrote ten years later in 1539, recommended him to read a new Italian book on politics, which Pole says he afterwards discovered was Machiavelli's *Prince*. But this discovery was not made for some years: the *Prince* was not published until 1532, three years after the conversation; there is evidence that Cromwell was not acquainted with it until 1537 or 1539, and there is nothing in the *Prince* bearing on the precise point under discussion by Pole and Cromwell. On the other hand, the point is discussed in Castiglione's *Il Cortegiano* which had just been published in 1528, and of which Cromwell promised to lend Bonner a copy in 1530. The *Cortegiano* is the antithesis of the *Prince*; and there is little doubt that Pole's account is the offspring of an imagination heated by his own perusal of the *Prince* in 1538, and by Cromwell's ruin of the Pole family at the same time; until then he had failed to see in Cromwell the Machiavellian "emissary of Satan."

Equally fanciful is Pole's ascription of the whole responsibility for the Reformation to Cromwell's suggestion. It was impossible for Pole to realize the substantial causes of that perfectly natural development, and it was his cue to represent Henry as having acted at the diabolic suggestion of Satan's emissary. In reality the whole programme, the destruction of the liberties and confiscation of the wealth of the church by parliamentary agency, had been indicated before Cromwell had spoken to Henry. The use of *Praemunire* had been applied to Wolsey; laymen had supplanted ecclesiastics in the chief offices of state; the plan of getting a divorce without papal intervention had been the original idea, which Wolsey had induced the king to abandon, and it had been revived by Cranmer's suggestion about the universities. The root idea of the supreme authority of the king had been asserted in Tyndale's *Obedience of a Christian Man* published in 1528, which Anne Boleyn herself had brought to Henry's notice: "this," he said, "is a book for me and all kings to read," and Campeggio had felt compelled to warn him against these notions, of which Pole imagines that he had never heard until they were put into his head by Cromwell late in 1530. In the same way Cromwell's influence over the government from 1529-1533 has been grossly exaggerated. It was not till 1531 that he was admitted to the privy council nor till 1534 that he was made secretary, though he had been made master of the Jewel-House, clerk of the Hanaper and master of the Wards in 1532, and chancellor of the exchequer (then a minor office) in 1533. It is not till 1533 that his name is as much as mentioned in the correspondence of any foreign ambassador resident in London. This obscurity has been attributed to deliberate suppression: but no secrecy was made about Cranmer's suggestion, and it was not Henry's habit to assume a responsibility which he could devolve upon others. It is said that Cromwell's life would not have been safe, had he been known as the author of this policy; but that is not a consideration which would have appealed to Henry, and he was just as able to protect his minister in 1530 as he was in 1536. Cromwell, in fact, was not the author of that policy, but he was the most efficient instrument in its execution.

He was Henry's parliamentary agent, but even in this capacity his power has been overrated, and he is supposed to have invented those parliamentary complaints against the clergy, which were transmuted into the legislation of 1532. But the complaints were old enough; many of them had been heard in parliament nearly twenty years before, and there is ample evidence to show that the petition against the clergy represents the "infinite clamours" of the Commons against the Church, which the House itself resolved should be "put in writing and delivered to the king." The actual drafting of the statute, as of all the Reformation Acts between 1532 and 1539, was largely Cromwell's work; and the success with which parliament was managed during this period was also due to him. It was not an easy task, for the House of Commons more than once rejected government measures, and members were heard to threaten Henry VIII. with the fate of Richard III.; they even complained of Cromwell's reporting their proceedings to the king. That was his business rather than conveying imaginary royal orders to the House. "They be

contented," he wrote in one of these reports, "that deed and writing shall be treason," but words were only to be misprision: they refused to include an heir's rebellion or disobedience in the bill "as rebellion is already treason, and disobedience is no cause of forfeiture of inheritance." There was, of course, room for manipulation, which Cromwell extended to parliamentary elections; but parliamentary opinion was a force of which he had to take account, and not a negligible quantity.

From the date of his appointment as secretary in 1534, Cromwell's biography belongs to the history of England, but it is necessary to define his personal attitude to the revolution in which he was the king's most conspicuous agent. He was included by Foxe in his *Book of Martyrs* to the Protestant faith: more recent historians regard him as a sacrilegious ruffian. Now, there were two cardinal principles in the Protestantism of the 16th century—the supremacy of the temporal sovereign over the church in matters of government, and the supremacy of the Scriptures over the Church in matters of faith. There is no room for doubt as to the sincerity of Cromwell's belief in the first of these two articles: he paid at his own expense for an English translation of Marsiglio of Padua's *Defensor Pacis*, the classic medieval advocate of that doctrine; he had a scheme for governing England by means of administrative councils nominated by the king to the detriment of parliament; and he urged upon Henry the adoption of the maxim of the Roman civil law—*quod principi placuit legis habet vigorem*. He wanted, in his own words, "one body politic" and no rival to the king's authority; and he set the divine right of kings against the divine right of the papacy. There is more doubt about the sincerity of Cromwell's attachment to the second article; it is true that he set up a Bible in every parish church, and regarded them as invaluable; and the correspondents who unbosomed themselves to him are all of a Protestant way of thinking. But Protestantism was the greatest support of absolute monarchy. Hence its value in Cromwell's eyes. Of religious conviction there is in him little trace, and still less of the religious temperament. He was a polished representative of the callous, secular middle class of that most irreligious age. Sentiment found no place, and feeling little, in his composition; he used the axe with as little passion as the surgeon does the knife, and he operated on some of the best and noblest in the land. He saw that it was wiser to proscribe a few great opponents than to fall on humbler prey; but he set law above justice, and law to him was simply the will of the state.

In 1534 Cromwell was appointed master of the Rolls, and in 1535 chancellor of Cambridge University and visitor-general of the monasteries. The policy of the Dissolution has been theoretically denounced, but practically approved in every civilized state, Catholic as well as Protestant. Every one has found it necessary, sooner or later, to curtail or to destroy its monastic foundations; only those which delayed the task longest have generally lagged farthest behind in national progress. The need for reform was admitted by a committee of cardinals appointed by Paul III. in 1535, and it had been begun by Wolsey. Cromwell was not affected by the iniquities of the monks except as arguments for the confiscation of their property. He had boasted that he would make Henry VIII. the richest prince in Christendom; and the monasteries, with their direct dependence on the pope and their cosmopolitan organization, were obstacles to that absolute authority of the national state which was Cromwell's ideal. He had learnt how to visit monasteries under Wolsey, and the visitation of 1535 was carried out with ruthless efficiency. During the storm which followed, Henry took the management of affairs into his own hands, but Cromwell was rewarded in July 1536 by being knighted, created lord privy seal, Baron Cromwell, and vicar-general and viceregent of the king in "Spirituals."

In this last offensive capacity he sent a lay deputy to preside in Convocation, taking precedence of the bishops and archbishops, and issued his famous Injunctions of 1536 and 1538; a Bible was to be provided in every church; the *Paternoster*, Creed and Ten Commandments were to be recited by the incumbent in



English; he was to preach at least once a quarter, and to start a register of births, marriages and deaths. During these years the outlook abroad grew threatening because of the alliance, under papal guarantee, between Charles V. and Francis I.; and Cromwell sought to counterbalance it by a political and theological union between England and the Lutheran princes of Germany. The theological part of the scheme broke down in 1538 when Henry categorically refused to concede the three reforms demanded by the Lutheran envoys. This was ominous, and the parliament of 1539, into which Cromwell tried to introduce a number of personal adherents, proved thoroughly reactionary. The temporal peers were unanimous in favour of the Six Articles, the bishops were divided, and the Commons for the most part agreed with the Lords. Cromwell, however, succeeded in suspending the execution of the act, and was allowed to proceed with his one independent essay in foreign policy. The friendship between Francis and Charles was apparently getting closer; Pole was exhorting them to a crusade against a king who was worse than the Turk; and anxious eyes searched the Channel in 1539 for signs of the coming Armada. Under these circumstances Henry acquiesced in Cromwell's negotiations for a marriage with Anne of Cleves. Anne, of course, was not a Lutheran, and the state religion in Cleves was at least as Catholic as Henry's own. But her sister was married to the elector of Saxony, and her brother had claims on Guelders, which Charles V. refused to recognize. Guelders was to the emperor's dominions in the Netherlands what Scotland was to England, and had often been used by France in the same way, and an alliance between England, Guelders, Cleves and the Schmalkaldic League would, Cromwell thought, make Charles's position in the Netherlands almost untenable. Anne herself was the weak point in the argument; Henry conceived an invincible repugnance to her from the first; he was restrained from an immediate breach with his new allies only by fear of Francis and Charles. In the spring of 1540 he was reassured on that score; no attack on him from that quarter was impending; there was a rift between the two Catholic sovereigns, and there was no real need for Anne and her German friends.

From that moment Cromwell's fate was sealed; the Lords loathed him as an upstart even more than they had loathed Wolsey; he had no church to support him; Norfolk and Gardiner detested him from pique as well as on principle, and he had no friend in the council save Cranmer. As lay viceregent he had given umbrage to nearly every churchman, and he had put all his eggs in the one basket of royal favour, which had now failed him. Cromwell did not succumb without an effort, and a desperate struggle ensued in the council. In April the French ambassador wrote that he was tottering to his fall; a few days later he was created earl of Essex and lord great chamberlain, and two of his satellites were made secretaries to the king; he then despatched one bishop to the Tower, and threatened to send five others to join him. At last Henry struck as suddenly and remorselessly as a beast of prey; on the 10th of June Norfolk accused him of treason; the whole council joined in the attack, and Cromwell was sent to the Tower. A vast number of crimes was laid to his charge, but not submitted for trial. An act of attainder was passed against him without a dissentient voice, and after contributing his mite towards the divorce of Anne, he was beheaded on Tower Hill on the 28th of July, repudiating all heresy and declaring that he died in the Catholic faith.

In estimating Cromwell's character it must be remembered that his father was a blackguard, and that he himself spent the formative years of his life in a vile school of morals. A ruffian he doubtless was, as he says, in his youth, and he was the last man to need the tuition of Machiavelli. Nevertheless he civilized himself to a certain extent; he was not a drunkard nor a forger like his father; from personal immorality he seems to have been singularly free; he was a kind master, and a staunch friend; and he possessed all the outward graces of the Renaissance period. He was not vindictive, and his atrocious acts were done in no private quarrel, but in what he conceived to be the interests

of his master and the state. Where those interests were concerned he had no heart and no conscience and no religious faith; no man was more completely blighted by the 16th century worship of the state.

The authorities for the early life of Cromwell are the Wimbledon manor rolls, used by Mr John Phillips of Putney in *The Antiquary* (1880), vol. ii., and the *Antiquarian Mag.* (1882), vol. ii.; Pole's *Apologia*, i. 126; Bandello's *Novella*, xxxiv.; Chapuys' letter to Granvelle, 21 Nov. 1535; and Foxe's *Acts and Mon.* From 1522 see *Letters and Papers of Henry VIII.*, vols. iii.-xvi.; Cavendish's *Life of Wolsey*; Hall's *Chron.*; Wriothesley's *Chron.* These and practically all other available sources have been utilized in R. B. Merriman's *Life and Letters of Thomas Cromwell* (2 vols., 1902). For Cromwell and Machiavelli see Paul van Dyke's *Renaissance Portraits* (1906), App. (A. F. P.)

**CRONJE, PIET ARNOLDUS** (c. 1840- ), Boer general, was born about 1840 in the Transvaal and in 1881 took part in the first Boer War in the rank of commandant. He commanded in the siege of the British garrison at Potchefstroom, though he was unable to force their surrender until after the conclusion of the general armistice. The Boer leader was at this time accused of withholding knowledge of this armistice from the garrison (see POTCHEFSTROOM). He held various official positions in the years 1881-1899, and commanded the Boer force which compelled the surrender of the Jameson raiders at Doornkop (Jan. 2, 1896). In the war of 1899 Cronje was general commanding in the western theatre of war, and began the siege of Kimberley. He opposed the advance of the British division under Lord Methuen, and fought, though without success, three general actions at Belmont, Graspan and Modder River. At Magersfontein, early in December 1899, he completely repulsed a general attack made upon his position, and thereby checked for two months the northward advance of the British column. In the campaign of February 1900, Cronje opposed Lord Roberts's army on the Magersfontein battleground, but he was unable to prevent the relief of Kimberley; retreating westward, he was surrounded near Paardeberg, and, after a most obstinate resistance, was forced to surrender with the remnant of his army (Feb. 27, 1900). As a prisoner of war Cronje was sent to St Helena, where he remained until released after the conclusion of peace (see TRANSVAAL: *History*).

**CROOKES, SIR WILLIAM** (1832- ), English chemist and physicist, was born in London on the 17th of June 1832, and studied chemistry at the Royal College of Chemistry under A. W. von Hofmann, whose assistant he became in 1851. Three years later he was appointed an assistant in the meteorological department of the Radcliffe observatory, Oxford, and in 1855 he obtained a chemical post at Chester. In 1861, while conducting a spectroscopic examination of the residue left in the manufacture of sulphuric acid, he observed a bright green line which had not been noticed previously, and by following up the indication thus given he succeeded in isolating a new element, thallium, a specimen of which was shown in public for the first time at the exhibition of 1862. During the next eight years he carried out a minute investigation of this metal and its properties. While determining its atomic weight, he thought it desirable, for the sake of accuracy, to weigh it in a vacuum, and even in these circumstances he found that the balance behaved in an anomalous manner, the metal appearing to be heavier when cold than when hot. This phenomenon he explained as a "repulsion from radiation," and he expressed his discovery in the statement that in a vessel exhausted of air a body tends to move away from another body hotter than itself. Utilizing this principle he constructed the radiometer (*q.v.*), which he was at first disposed to regard as a machine that directly transformed light into motion, but which was afterwards perceived to depend on thermal action. Thence he was led to his famous researches on the phenomena produced by the discharge of electricity through highly exhausted tubes (sometimes known as "Crookes' tubes" in consequence), and to the development of his theory of "radiant matter" or matter in a "fourth state," which led up to the modern electronic theory. In 1883 he began an inquiry into the nature and constitution of the rare earths. By repeated

fractionations he was able to divide yttrium into distinct portions which gave different spectra when exposed in a high vacuum to the spark from an induction coil. This result he considered to be due, not to any removal of impurities, but to an actual splitting-up of the yttrium molecule into its constituents, and he ventured to draw the provisional conclusion that the so-called simple bodies are in reality compound molecules, at the same time suggesting that all the elements have been produced by a process of evolution from one primordial stuff or "protyle." A later result of this method of investigation was the discovery of a new member of the rare earths, monium or victorium, the spectrum of which is characterized by an isolated group of lines, only to be detected photographically, high up in the ultra-violet; the existence of this body was announced in his presidential address to the British Association at Bristol in 1898. In the same address he called attention to the conditions of the world's food supply, urging that with the low yield at present realized per acre the supply of wheat would within a comparatively short time cease to be equal to the demand caused by increasing population, and that since nitrogenous manures are essential for an increase in the yield, the hope of averting starvation, as regards those races for whom wheat is a staple food, depended on the ability of the chemist to find an artificial method for fixing the nitrogen of the air. An authority on precious stones, and especially the diamond, he succeeded in artificially making some minute specimens of the latter gem; and on the discovery of radium he was one of the first to take up the study of its properties, in particular inventing the spintharoscope, an instrument in which the effects of a trace of radium salt are manifested by the phosphorescence produced on a zinc sulphide screen. In addition to many other researches besides those here mentioned, he wrote or edited various books on chemistry and chemical technology, including *Select Methods of Chemical Analysis*, which went through a number of editions; and he also gave a certain amount of time to the investigation of psychic phenomena, endeavouring to effect some measure of correlation between them and ordinary physical laws. He was knighted in 1897, and received the Royal (1875), Davy (1888), and Copley (1904) medals of the Royal Society, besides filling the offices of president of the Chemical Society and of the Institution of Electrical Engineers. He married Ellen, daughter of W. Humphrey, of Darlington, and their golden wedding was celebrated in 1906.

**CROOKSTON**, a city and the county-seat of Polk county, Minnesota, U.S.A., on the Red Lake river in the Red River valley, about 300 m. N.W. of Minneapolis, and about 25 m. E. of Grand Forks, North Dakota. Pop. (1890) 3457; (1900) 5359; (1905, state census) 6794, of whom 2049 were foreign-born, including 656 from Norway (two Norwegian weeklies are published here), 613 from Canada, and 292 from Sweden. Crookston is served by the Great Northern and the Northern Pacific railways. It has a Carnegie library, and the St Vincent and Bethesda hospitals, and is the seat of a Federal Land Office and of a state agricultural high school (with an experimental farm). Dams on the Red Lake river provide a fine water-power, and among the city's manufactures are lumber, leather, flour, farm implements, wagons and bricks. The city is situated in a fertile farming region, and is a market for grain, potatoes and other agricultural products, and lumber. Crookston was settled about 1872, was incorporated in 1879, received its first city charter in 1883, and adopted a new one in 1906. It was named in honour of William Crooks, an early settler.

**CROP** (a word common in various forms, such as Germ. *Kropf*, to many Teutonic languages for a swelling, excrescence, round head or top of anything; it appears also in Romanic languages derived from Teutonic, in Fr. as *croupe*, whence the English "crupper"; and in Ital. *gropo*, whence English "group"), the *ingluvies*, or pouched expansion of a bird's oesophagus, in which the food remains to undergo a preparatory process of digestion before being passed into the true stomach. From the meaning of "top" or "head," as applied to a plant, herb or flower, comes the common use of the word for the

produce of cereals or other cultivated plants, the wheat-crop, the cotton-crop and the like, and generally, "the crops"; more particular expressions are the "white-crop," for such grain crops as barley or wheat, which whiten as they grow ripe, and "green-crop" for such as roots or potatoes which do not, and also for those which are cut in a green state, like clover (see AGRICULTURE). Other uses, more or less technical, of the word are, in leather-dressing, for the whole untrimmed hide; in mining and geology, for the "outcrop" or appearance at the surface of a vein or stratum and, particularly in tin mining, of the best part of the ore produced after dressing. A "hunting-crop" is a short thick stock for a whip, with a small leather loop at one end, to which a thong may be attached. From the verb "to crop," *i.e.* to take off the top of anything, comes "crop" meaning a closely cut head of hair, found in the name "croppy" given to the Roundheads at the time of the Great Rebellion, to the Catholics in Ireland in 1688 by the Orangemen, probably with reference to the priests' tonsures, and to the Irish rebels of 1798, who cut their hair short in imitation of the French revolutionaries.

**CROPSEY, JASPER FRANCIS** (1823-1900), American landscape painter, was born at Rossville, Staten Island, New York, on the 18th of February 1823. After practising architecture for several years, he turned his attention to painting, studying in Italy from 1847 to 1850. In 1851 he was elected a member of the National Academy of Design. From 1857 to 1863 he had a studio in London, and after his return to America enjoyed a considerable vogue, particularly as a painter of vivid autumnal effects, along the lines of the Hudson River school. He was one of the original members of the American Water Color Society. He continued actively in this profession until within a few days of his death, at Hastings-on-Hudson, New York, on the 22nd of June 1900. He made the architectural designs for the stations of the elevated railways in New York City.

**CROQUET** (from Fr. *croc*, a crook, or crooked stick), a lawn game played with balls, mallets, hoops and two pegs. The game has been evolved, according to some writers, from the *paille-maille* which was played in Languedoc at least as early as the 13th century. Under the name of *le jeu de la crosse*, or *la crosse*, a similar game was at the same period immensely popular in Normandy, and especially at Avranches, but the object appears to have been to send the ball as far as possible by driving it with the mallet (see *Sports et jeux d'adresse*, 1904, p. 203). Pall Mall, a fashionable game in England in the time of the Stuarts, was played with a ball and a mallet, and with two hoops or a hoop and a peg, the game being won by the player who ran the hoop or hoops and touched the peg under certain conditions in the fewest strokes. Croquet certainly has some resemblance to *paille-maille*, played with more hoops and more balls. It is said that the game was brought to Ireland from the south of France, and was first played on Lord Lonsdale's lawn in 1852, under the auspices of the eldest daughter of Sir Edmund Macnaghten. It came to England in 1856, or perhaps a few years earlier, and soon became popular.

In 1868 the first all-comers' meeting was held at Moreton-in-the-Marsh. In the same year the All England Croquet Club was formed, the annual contest for the championship taking place on the grounds of this club at Wimbledon.<sup>1</sup> But after being for ten years or so the most popular game for the country house and garden party, croquet was in its turn practically ousted by lawn tennis, until, with improved implements and a more scientific form of play, it was revived about 1894-1895. In 1896-1897 was formed the United All England Croquet Association, on the initiative of Mr Walter H. Peel. Under the name of the Croquet Association, with more than 2000 members and nearly a hundred affiliated clubs (1909), this body is the recognized ruling authority on croquet in the British Islands. Its headquarters are at the Roehampton Club, where the

<sup>1</sup> This was largely the work of W. T. Whitmore-Jones (1831-1872), generally known as W. Jones Whitmore, who subsequently formed the short-lived National Croquet Club, and was largely responsible for the first codification of the laws.

championship and champion cup competitions are held each year.

*The Game and its Implements.*—The requisites for croquet are a level grass lawn, six hoops, two posts or pegs, balls, mallets, and hoop-clips to mark the progress of the players. The usual game is played between two sides, each having two balls, the side consisting of two players in partnership, each playing one ball, or of one player playing both balls. The essential characteristic of croquet is the scientific combination between two balls in partnership against the other two. The balls are distinguished by being coloured blue, red, black and yellow, and are played in that order, blue and black always opposing the other two.

The ground for match play measures 35 yds. by 28 yds., and should be carefully marked out with white lines. In each corner a white spot is marked 1 yd. from each boundary. The hoops are made of round iron, not less than  $\frac{1}{2}$  in. and not more than  $\frac{3}{4}$  in. in diameter, and standing 12 in. out of the ground. For match play they are  $3\frac{1}{2}$  or 4 in. across, inside measurement. They are set up as in the accompanying diagram, the numbers and arrows indicating the order and direction in which they must

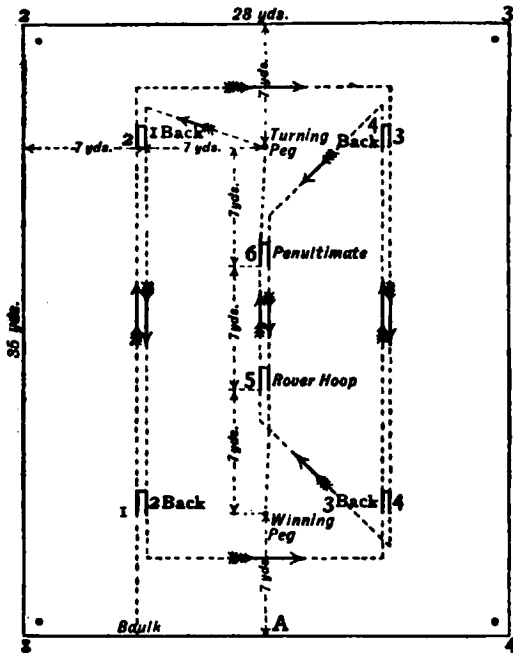

FIG. 1.—Diagram of croquet ground, showing setting of hoops and pegs, and order of play in accordance with the official Laws (1909) of the Croquet Association.

be passed. Each hoop is run twice, and each peg struck once. The pegs may be struck from any direction.

The pegs are  $1\frac{1}{2}$  in. in diameter and when fixed stand 18 in. above the ground. The balls were formerly made of boxwood (earlier still of beechwood); composition balls are now in general use for tournaments. They must be  $3\frac{1}{8}$  in. in diameter and 15 oz. to 16 $\frac{1}{2}$  oz. in weight. It will be seen that for match play the hoops are only  $\frac{1}{2}$  or at the most  $\frac{3}{4}$  in. wider than the diameter of the ball. The mallets may be of any size and weight, but the head must be made of wood (metal may be used only for weighting or strengthening purposes), and the ends must be parallel and similar. Only one mallet may be used in the course of a game, except in the case of *bona fide* damage.

The object of the player is to score the points of the game by striking his ball through each of the hoops and against each of the pegs in a fixed order; and the side wins which first succeeds in scoring all the points with both the balls of the side. A metal clip corresponding in colour with the player's ball is attached to the hoop or peg which that ball has next to make in the proper order, as a record of its progress in the game. No point is scored by passing through a hoop or hitting a peg except in the proper order. Thus, if a player has in any turn or turns driven his ball successively through hoops 1, 2, and 3, his clip is attached to

hoop 4, and the next point to be made by him will be that hoop; and so on till all the points (hoops and pegs) have been scored. Each player starts in turn from any point in a "baulk" or area 3 ft. wide along the left-hand half of the "southern" boundary, marked A on the diagram, of the lawn—till 1906, from a point 1 ft. in front of the middle of hoop 1. If he fails either to make a point or to "roquet"<sup>1</sup> (*i.e.* drive his ball against) another ball in play, his turn is at an end and the next player in order takes his turn in like manner. If he succeeds in scoring a point, he is entitled (as in billiards) to another stroke; he may then either attempt to score another point, or he may roquet a ball. Having roqueted a ball—provided he has not already roqueted the same ball in the same turn without having scored a point in the interval—he is entitled to two further strokes: first he must "take croquet," *i.e.* he places his own ball (which from the moment of the roquet is "dead" or "in hand") in contact with the roqueted ball on any side of it, and then strikes his own ball with his mallet, being bound to move or shake both balls perceptibly. If at the beginning of a turn the striker's ball is in contact with another ball, a "roquet" is held to have been made and "croquet" must be taken at once. After taking croquet the striker is entitled to another stroke, with which he may score another point, or roquet another ball not previously roqueted in the same turn since a point was scored, or he may play for safety. Thus, by skilful alternation of making points and roqueting balls, a "break" may be made in which point after point, and even all the points in the game (for the ball in play), may be scored in a single turn, in addition to 3 or 4 points for the partner ball. The chief skill in the game perhaps consists in playing the stroke called "taking croquet" (but see below on the "rush"). Expert players can drive both balls together from one end of the ground to the other, or send one to a distance while retaining the other, or place each with accuracy in different directions as desired, the player obtaining position for scoring a point or roqueting another ball according to the strategical requirements of his position. Care has, however, to be taken in playing the croquet-stroke that both balls are absolutely moved or perceptibly shaken, and that neither of them be driven over the boundary line, for in either event the player's next stroke is forfeited and his turn brought summarily to an end.

There are three distinct methods of holding the mallet among good players. A comparatively small number still adhere to the once universal "side stroke," in which the player faces more or less at right angles to the line of aim, and strikes the ball very much like a golfer, with his hands close together on the mallet shaft. The majority use "front play," in which the player faces in the direction in which he proposes to send the ball. The essential characteristic of this stroke is that eye, hand and ball should be in the same vertical plane, and the stroke is rather a swing—the "pendulum stroke"—than a hit. There are two ways of playing it. The majority of right-handed front players swing the mallet outside the right foot, holding it with the left hand as a pivot at the top of the shaft, while the right hand (about 12 in. lower down) applies the necessary force, though it must always be borne in mind that the heavy mallet-head, weighing from 3 to 3 $\frac{1}{2}$  lb or even more, does the work by itself, and the nearer the stroke is to a simple swing, like that of a pendulum, the more likely it is to be accurate. Either the right or the left foot may be in advance, and should be roughly parallel to the line of aim, the player's weight being mainly on the rear foot. Most of the best Irish and some English players swing the mallet between their feet, using a grip like that of the side player or golfer, with the hands close together, and often interlocking. It is claimed that the loss of power caused by the hampered swing—usually compensated by an extra heavy mallet—is more than counterbalanced by the greater accuracy in aim. The beginner is well advised to try all these methods, and adopt that which comes most natural to him. Skirted players, of course, are unable to use the Irish stroke; and, as

<sup>1</sup>The words "roquet" and "croquet" are pronounced as in French, with the *t* mute.

one of the most meritorious features of croquet is that it is the only out-of-door game in which men and women can compete on terms of real equality, this has been put forward as a reason for barring it, if it is actually an advantage.

When a croquet ground is thoroughly smooth and level, the game gives scope for considerable skill; a great variety of strokes may be played with the mallet, each having its own well-defined effect on the behaviour of the balls, while a knowledge of angles is essential. Skilful tactics are at least as necessary as skilful execution to enable the player so to dispose the balls on the ground while making a break that they may most effectively assist him in scoring his points. The tactics of croquet are in this respect similar to those of billiards, that the player tries to make what progress he can during his own break, and to leave the balls "safe" at the end of it; he must also keep in mind the needs of the other ball of his side by leaving his own ball, or the last player's ball, or both, within easy roqueting distance or in useful positions, and that of the next player isolated. Good judgment is really more valuable than mechanical skill. Croquet is a game of combination, partners endeavouring to keep together for mutual help, and to keep their opponents apart. It is important always to leave the next player in such a position that he will be unable to score a point or roquet a ball; a break, however profitable, which does not end by doing this is often fatal. Formerly this might be done by leaving the next player's ball in such a position that either a hoop or a peg lay between it and all the other balls ("wiring"), or so near to a hoop or peg that there was no room for a proper stroke to be taken in the required direction. Under rule 36 of the *Laws of Croquet* for 1906, a ball left in such a position, provided it were within a yard of the obstacle ("close-wired"), might at the striker's option be moved one yard in any direction. This rule left to the striker whose ball was "wired" more than a yard from the hoop or peg ("distance-wired") the possibility of hitting his ball in such a way as to jump the obstacle. The jump-shot is, however, very bad for the lawn, and in 1907 a further provision was made by which the player whose ball is left "wired" from all the other balls by the stroke of an opponent may lift it and play from the "baulk" area. This practically means that "wiring" is impossible. The most that can be done is to "close-wire" the next player from two balls and leave him with a difficult shot at the third. If, however, the next player's ball has not been moved by the adversary, the adversary is entitled to wire the balls as best he can.

The following is a specimen of elementary croquet tactics. If a player is going up to hoop 5 (diagram 1) in the course of a break, he should have contrived, if possible, to have a ball waiting for him at that hoop and another at hoop 6. With the aid of the first he runs hoop 5 and sends it on to the turning peg, stopping his ball in taking croquet close to the ball at 6. The corner hoops are the difficult ones, and after running hoop 6 the assisting ball is croqueted to 1 back, the peg being struck with the aid of the ball already there, which is again struck and driven to 2 back. If the player has been able to leave the fourth ball in the centre of the ground (known as a centre ball), he hits this after taking croquet, takes croquet, going off it to the ball at 1 back, and continues the break, leaving the centre ball where it will be useful for 3 back and 4 back. A first-class player should, however, be able to make a break with 3 balls almost as easily as with 4. A useful device, especially in a losing game, is to get rid of the opponent's advanced ball if a "rover" (*i.e.* one which has run all the hoops and is for the winning peg) by croqueting it in such a way that it hits the peg and is thus out of the game. This can be done only by a ball which is itself also a rover. The opponent has then only one turn out of every three, and may be rendered practically helpless by leaving him always in a "safe" position. Inasmuch as a skilful player can cause an opponent's ball to pass through the last two or even three hoops in the course of his turn and then peg it out, it is considered prudent to leave unrun the last three hoops until the partner's ball is well advanced. There is a perennial agitation in the croquet world for a law prohibiting the player from pegging out

his opponent's ball. Many good players also think it desirable that the four-ball break should be restricted or wholly forbidden, *e.g.* by barring the dead ball.

To "rush" a ball is to roquet it hard so that it proceeds for a considerable distance in a desired direction. This stroke requires absolute accuracy and often considerable force, which must be applied in such a way as to drive the player's ball evenly; otherwise it is very liable, especially if the ground be not perfectly smooth, to jump the object ball. The rush stroke is absolutely essential to good play, as it enables croquet to be taken (*e.g.*) close to the required hoop, whereas to croquet into position from a great distance and also provide a ball for use after running the hoop is extremely difficult, often impossible. To "rush" successfully, the striker's ball must lie near the object ball, preferably, though not necessarily, in the line of the rush. By means of the rush it is possible to accomplish the complete round with the assistance of one ball only. To "cut" a ball is to hit it on the edge and cause it to move at some desired angle. "Rolling croquet" is made either by hitting near the top of the player's ball which gives it "follow," or by making the mallet so hit the ball as to keep up a sustained pressure. The first impact must, however, result in a distinctly audible single tap; if a prolonged rattle or a second tap is heard the stroke is foul. The passing stroke is merely an extension of this. Here the player's ball proceeds a greater distance than the croqueted ball, but in somewhat the same direction. The "stop stroke" is made by a short, sharp tap, the mallet being withdrawn immediately after contact; the player's ball only rolls a short distance, the other going much farther. The "jump stroke" is made by striking downwards on to the ball, which can thus be made to jump over another ball, or even a hoop. "Peeling" (a term derived from Walter H. Peel, a famous advocate of the policy) is the term applied to the device of putting a partner's or an opponent's ball through the hoops with a view to ultimately pegging it out.

The laws of croquet, and even the arrangement of the hoops, have not attained complete uniformity wherever the game is played. Croquet grounds are not always of full size, and some degree of elasticity in the rules is perhaps necessary to meet local conditions. The laws by which matches for the championship and all tournaments are governed are issued annually by the Croquet Association; and though from time to time trifling amendments may be made, they have probably reached permanence in essentials.

See *The Encyclopaedia of Sport; The Complete Croquet Player* (London, 1896); the latest *Laws of Croquet*, published annually by the Croquet Association, and its official organ *The Croquet Gazette*. For the principles of the game and its history in England, see C. D. Locock, *Modern Croquet Tactics* (London, 1907); A. Lillie, *Croquet up to Date* (London, 1900).

*Croquet in the United States: Roque.*—Croquet was brought to America from England soon after its introduction into that country, and enjoyed a wide popularity as a game for boys and girls before the Civil War (see Miss Alcott's *Little Women*, cap. 12). American croquet is quite distinct from the modern English game. It is played on a lawn 60 ft. by 30, and preserves the old-fashioned English arrangement of ten hoops, including a central "cage" of two hoops. The balls, coloured red, white, blue and black, are  $3\frac{1}{4}$  in. in diameter, and the hoops are from  $3\frac{1}{2}$  to 4 in. wide, according to the skill of the players. This game, however, is not taken seriously in the United States; the *Official Croquet Guide* of Mr Charles Jacobus emphasizes "the ease with which the game can be established," since almost every country home has a grass plot, and "no elaboration is needed." The scientific game of croquet in the United States is known as "roque." Under this title a still greater departure from the English game has been elaborated on quite independent lines from those of the English Croquet Association since 1882, in which year the National Roque Association was formed. Roque also suffered from the popularity of lawn tennis, but since 1897 it has developed almost as fast as croquet in England. A great national championship tournament is held in Norwich, Conn.,

every August, and the game—which is fully as scientific as modern English croquet—has numerous devotees, especially in New England.

Roque is played, not on grass, but on a prepared surface something like a cinder tennis-court. The standard ground, as adopted by the National Association in 1903, is hexagonal in shape, with ten arches (hoops) and two stakes (pegs) as shown in diagram 2. The length is 60 ft., width 30, and the "corner pieces" are 6 ft. long. An essential feature of the ground is that it is surrounded by a raised wooden border, often lined with india-rubber to facilitate the rebound of the ball, and it is permissible to play a "carom" (or rebounding shot) off this border; a skilful player can often hit a ball which is wired to a direct shot. A boundary line is marked 28 in. inside the border, on which a ball coming to rest outside it must be replaced. The hoops are run in the order marked on the diagram, so that the game consists of 36 points. Red and white are always partners against blue and black, and the essential features and tactics of the game are, *mutatis mutandis*, the same as in modern English croquet—*i.e.* the skilful player goes always for a break and utilizes one or both of the opponent's balls in making it. The balls are  $3\frac{1}{4}$  in. in diameter, of hard rubber or composition, and the arches are  $3\frac{3}{8}$  or  $3\frac{1}{2}$  in. wide for first- and

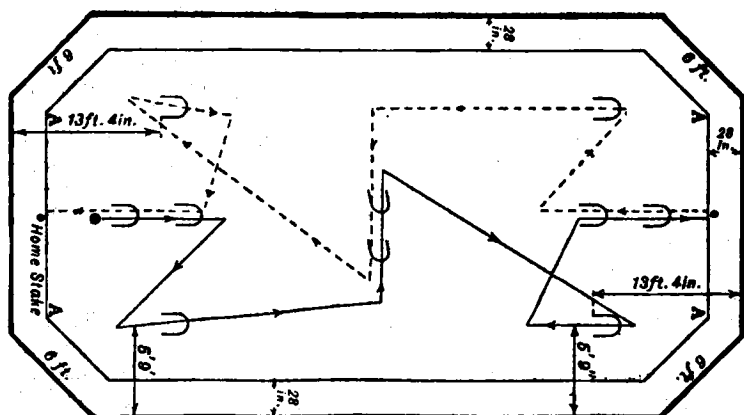

FIG. 2.—Diagram of roque ground, showing setting of arches and stakes and order of play, in accordance with the official laws (1906) of the National Roque Association.

second-class players respectively; they are made of steel  $\frac{1}{2}$  in. in diameter and stand about 8 in. out of the ground. The stakes are 1 in. in diameter and only  $1\frac{1}{2}$  in. above the ground. The mallets are much shorter than those commonly employed in England, the majority of players using only one hand, though the two-handed "pendulum stroke," played between the legs, finds an increasingly large number of adherents, on account of the greater accuracy which it gives. The "jump shot" is a necessary part of the player's equipment, as dead wiring is allowed; it is supplemented by the carom off the border or off a stake or arch, and roque players justly claim that their game is more like billiards than any other out-of-door game.

The game of roque is opened by scoring (stringing) for lead from an imaginary line through the middle wicket (cage), the player whose ball rests nearest the southern boundary line having the choice of lead and balls. The balls are then placed on the four corner spots marked A in diagram, partner balls being diagonally opposite one another, and the starting ball having the choice of either of the upper corners. The leader, say red, usually begins by shooting at white; if he misses, a carom off the border will leave him somewhere near his partner, blue. White then shoots at red or blue, with probably a similar result. Blue is then "in," with a certain roquet and the choice of laying for red or going for an immediate break himself. The general strategy of the game corresponds to that of croquet, the most important differences being that "pegging out" is not allowed, and that on the small ground with its ten arches and two stakes the three-ball break is usually adopted,

the next player or "danger ball" being wired at the earliest opportunity.

See Spalding's *Official Roque Guide*, edited by Mr Charles Jacobus (New York, 1906).

**CRORE** (Hindustani *karor*), an Anglo-Indian term for a hundred lakhs or ten million. It is in common use for statistics of trade and especially coinage. In the days when the rupee was worth its face value of 2s. a crore of rupees was exactly worth a million sterling, but now that the rupee is fixed at 15 to the £1, a crore is only worth £666,666.

**CROSBY, HOWARD** (1826-1891), American preacher and teacher, great-grandson of Judge Joseph Crosby of Massachusetts and of Gen. William Floyd of New York, a signer of the Declaration of Independence, was born in New York City on the 27th of February 1826. He graduated in 1844 from the University of the City of New York (now New York University); became professor of Greek there in 1851, and in 1859 became professor of Greek in Rutgers College, New Brunswick, New Jersey, where two years later he was ordained pastor of the first Presbyterian church. From 1870 to 1881 he was chancellor of the University of the City of New York; from 1872 to 1881 was one of the American revisers of the English version of the New Testament; and in 1873 was moderator of the general assembly of the Presbyterian Church. He took a prominent part in politics, urged excise reform, opposed "total abstinence," was one of the founders and was the first president of the New York Society for the Prevention of Crime, and pleaded for better management of Indian affairs and for international copyright. Among his publications are *The Lands of the Moslem* (1851), *Bible Companion* (1870), *Jesus: His Life and Works* (1871), *True Temperance Reform* (1879), *True Humanity of Christ* (1880), and commentaries on the book of Joshua (1875), Nehemiah (1877) and the new Testament (1885).

His son, **ERNEST HOWARD CROSBY** (1856-1907), was a social reformer, and was born in New York City on the 4th of November 1856. He graduated at the University of the City of New York in 1876 and at Columbia Law School in 1878; served in the New York Assembly in 1887-1889, securing the passage of a high-licence bill; in 1889-1894 was a judge of the Mixed Tribunal at Alexandria, Egypt, resigning upon coming under the influence of Tolstoy; and died in New York City on the 3rd of January 1907. He was the first president (1894) of the Social Reform Club of New York City, and was president in 1900-1905 of the New York Anti-Imperialist League; was a leader in settlement work and in opposition to child labour, and was a disciple of Tolstoy as to universal peace and non-resistance, and of Henry George in his belief in the "single tax" principle. His writings, many of which are in the manner of Walt Whitman, comprise *Plain Talk in Psalm and Parable* (1899), *Swords and Ploughshares* (1902), and *Broadcast* (1905), all in verse; an anti-military novel, *Captain Jinks, Hero* (1902); and essays on Tolstoy (1904 and 1905) and on Garrison (1905).

**CROSS**, and **CRUCIFIXION** (Lat. *crux, crucis*<sup>1</sup>). The meaning ordinarily attached to the word "cross" is that of a figure composed of two or more lines which intersect, or touch each other transversely. Thus, two pieces of wood, or other material, so placed in juxtaposition to one another, are understood to form a cross. It should be noted, however, that Lipsius and other writers speak of the single upright stake to which criminals were bound as a cross, and to such a stake the name of *crux simplex* has been applied. The usual conception, however, of a cross is that of a compound figure.

Punishment by crucifixion was widely employed in ancient times. It is known to have been used by nations such as those of Assyria, Egypt, Persia, by the Greeks, Carthaginians,

<sup>1</sup> Derivatives of the Latin *crux* appear in many forms in European languages, cf. Ger. *Kreuz*, Fr. *croix*, It. *croce*, &c.; the English form seems Norse in origin (O.N. *Krosse*, mod. *Kors*). The O.E. name was *rōd*, *rood* (*q.v.*).



Macedonians, and from very early times by the Romans. It has been thought, too, that crucifixion was also used by the Jews themselves, and that there is an allusion to it (Deut. xxi. 22, 23) as a punishment to be inflicted.

Two methods were followed in the infliction of the punishment of crucifixion. In both of these the criminal was first of all usually stripped naked, and bound to an upright stake, where he was so cruelly scourged with an implement, formed of strips of leather having pieces of iron, or some other hard material, at their ends, that not merely was the flesh often stripped from the bones, but even the entrails partly protruded, and the anatomy of the body was disclosed. In this pitiable state he was re clothed, and, if able to do so, was made to drag the stake to the place of execution, where he was either fastened to it, or impaled upon it, and left to die. In this method, where a single stake was employed, we have the *crux simplex* of Lipsius. The other method is that with which we are more familiar, and which is described in the New Testament account of the crucifixion of Jesus Christ. In such a case, after the scourging at the stake, the criminal was made to carry a gibbet, formed of two transverse bars of wood, to the place of execution, and he was then fastened to it by iron nails driven through the outstretched arms and through the ankles. Sometimes this was done as the cross lay on the ground, and it was then lifted into position. In other cases the criminal was made to ascend by a ladder, and was then fastened to the cross. Probably the feebleness, or state of collapse, from which the criminal must often have suffered, had much to do in deciding this. It is not quite clear which of these two plans was followed in the case of the crucifixion of Christ, but the more general opinion has been that He was nailed to the cross on the ground, and that it was then lifted into position. The contrary opinion, has, however, prevailed to some extent, and there are representations of the crucifixion which depict Him as mounting a ladder placed against the cross. Such representations may, however, have been due to a pious desire, on the part of their authors, to emphasize the voluntary offering of Himself as the Saviour of the World, rather than as being intended for actual pictures of the scene itself. It may be noted, however, that among the "Emblems of the Passion," as they are called, and which were very favourite devices in the middle ages, the ladder is not infrequently found in conjunction with the crown of thorns, nails, spear, &c.

From its simplicity of form, the cross has been used both as a religious symbol and as an ornament, from the dawn of man's civilization. Various objects, dating from periods long anterior to the Christian era, have been found, marked with crosses of different designs, in almost every part of the old world. India, Syria, Persia and Egypt have all yielded numberless examples, while numerous instances, dating from the later Stone Age to Christian times, have been found in nearly every part of Europe. The use of the cross as a religious symbol in



FIG. 1.



FIG. 2.

pre-Christian times, and among non-Christian peoples, may probably be regarded as almost universal, and in very many cases it was connected with some form of nature worship. Two of the forms of the pre-Christian cross which are perhaps most frequently met with are the tau cross, so named from its resemblance to the Greek capital letter  $\Gamma$ , and the *svastika* or *fylfot*<sup>1</sup>, also called "*Gammadion*" owing to its form being that of four Greek capital letters *gamma*  $\Gamma$  placed together. The tau cross

<sup>1</sup> The acceptance of this word as the English equivalent for this peculiar form of the cross rests only, according to the *New English Dictionary*, on a MS. of about 1500 in the Lansdowne collection, which gives details for the erection of a memorial stained-glass window, ". . . the fylfot in the nedermost pane under ther I knele . . ."; in the sketch given with the instructions a cross occupies the space indicated. It is a question, therefore, whether "fylfot" is a name for any device suitable to "fill the foot" of any design, or the name peculiar to this particular form of cross. The word is not, as was formerly accepted, a corruption of the O. Eng. *feowerfete*, four-footed.

is a common Egyptian device, and is indeed often called the Egyptian cross. The *svastika* has a very wide range of distribution, and is found on all kinds of objects. It was used as a religious emblem in India and China at least ten centuries before the Christian era, and is met with on Buddhist coins and inscriptions from various parts of India. A fine sepulchral urn found at Shropham in Norfolk, and now in the British Museum, has three bands of cruciform ornaments round it. The two uppermost of these are plain circles, each of which contains a plain cross; the lowest band is formed of a series of squares, in each of which is a *svastika*. In the Vatican Museum there is an Etruscan fibula of gold which is marked with the *svastika*, but it is a device of such common occurrence on objects of pre-Christian origin, that it is hardly necessary to specify individual instances. The cross, as a device in different forms, and often enclosed in a circle, is of frequent occurrence on coins and medals of pre-Christian date in France and elsewhere. Indeed, objects marked with pre-Christian crosses are to be seen in every important museum.

The death of Christ on a cross necessarily conferred a new significance on the figure, which had hitherto been associated with a conception of religion not merely non-Christian, but in its essence often directly opposed to it. The Christians of early times were wont to trace, in things around them, hidden prophetic allusions to the truth of their faith, and such a testimony they seem to have readily recognized in the use of the cross as a religious emblem by those whose employment of it betokened a belief most repugnant to their own. The adoption by them of such forms, for example, as the tau cross and the *svastika* or *fylfot* was no doubt influenced by the idea of the occult Christian significance which they thought they recognized in those forms, and which they could use with a special meaning among themselves, without at the same time arousing the ill-feeling or shocking the sentiment of those among whom they lived.

It was not till the time of Constantine that the cross was publicly used as the symbol of the Christian religion. Till then its employment had been restricted, and private among the Christians themselves. Under Constantine it became the acknowledged symbol of Christianity, in the same way in which, long afterwards, the crescent was adopted as the symbol of the Mahomedan religion. Constantine's action was no doubt influenced by the vision which he believed he saw of the cross in the sky with the accompanying words  $\epsilon\nu\ \tau\omicron\upsilon\tau\omega\ \nu\iota\kappa\alpha$ , as well as by the story of the discovery of the true cross by his mother St Helena in the year 326. The legend is that, when visiting the holy places in Palestine, St Helena was guided to the site of the crucifixion by an aged Jew who had inherited traditional knowledge as to its position. After the ground had been dug to a considerable depth, three crosses were found, as well as the superscription placed over the Saviour's head on the cross, and the nails with which he had been crucified. The cross of the Lord was distinguished from the other two by the working of a miracle on a crippled woman who was stretched upon it. This finding, or "invention," of the holy cross by St Helena is commemorated by a festival on the 3rd of May, called the "Invention of the Holy Cross." The legend was widely accepted as true, and is related by writers such as St Ambrose, Rufinus, Sulpicius Severus and others, but it is discounted by the existence of an older legend, according to which the true cross was found in the reign of Tiberius, and while St James the Great was bishop of Jerusalem, by Protonice, the wife of Claudius.

In recent times an attempt has been made to reconcile the two accounts, by attributing to St Helena the rediscovery of the true cross, originally found by Protonice, and which had been buried again on the spot. A change was made in 1895 in the *Diario Romano*, when the word *Ritrovamento* was substituted for that of *Invenzione*, in the name of the festival of the 3rd of May. After St Helena's discovery a church was built upon the site, and in it she placed the greater portion of the cross. The remaining portion she conveyed to Byzantium, and thence Constantine sent a piece to Rome, where it is said to be still preserved in the church of S. Croce in Gerusalemme,

which was built to receive so precious a relic. It is exposed for the veneration of the faithful on Good Friday, 3rd of May, and the third Sunday in Lent, each year.

Another festival of the holy cross is kept on the 14th of September, and is known as the "Exaltation of the Holy Cross." It seems to have originated with the dedication, in the year 335, of the churches built on the sites of the crucifixion and the holy sepulchre. The observance of this festival passed from Jerusalem to Constantinople, and thence to Rome, where it appears to have been introduced in the 7th century. By some it is thought that the feast of the Exaltation of the Cross had its origin in Constantine's vision of the cross in the sky in the year 317, but whether it originated then, or, as is more generally supposed, at the dedication of the churches at Jerusalem, there is no doubt that it was afterwards kept with much greater solemnity in consequence of the recovery of the portion of the cross St Helena had left at Jerusalem, which had been taken away in the Persian victory, and was restored to Jerusalem by Heraclitus in 627. Pope Clement VIII. (1592-1604) raised the festival of the Exaltation of the Holy Cross to the dignity, liturgically known as that of a Greater Double.

Before leaving the story of St Helena and the cross, it may be convenient to allude briefly to the superscription placed over the Saviour's head, and the nails, which it is said that she found with the cross. The earlier tradition as to the superscription is obscure, but it would seem that it ought to be considered part of the relic which Constantine sent to Rome. By some means it was entirely lost sight of until the year 1492, when it is said that it was accidentally found in a vault in the church of S. Croce in Gerusalemme at Rome. Pope Alexander III. published a bull certifying to the truth of this re-discovery of the relic, and authenticated its character.

As regards the nails, a question has arisen whether there were three or four. In the earliest pictures of the Crucifixion the feet are shown as separately nailed to the cross, but at a later period they are crossed, and a single nail fixes them. In the former case there would be four nails, and in the latter only three. Four is the number generally accepted, and it is said that one was cast by St Helena into the sea, during a storm, in order to subdue the waves, another is said (but the legend cannot be traced far back) to have been beaten out into the iron cirlet of the crown of Lombardy, while the remaining two are reputed to be preserved among the relics at Milan and Trier respectively.

The employment of the cross as the Christian symbol has been so manifold in its variety and application, and the different forms to which the figure has been adapted and elaborated are so complex, that it is only possible to deal with the outline of the subject.

We learn from Tertullian and other early Christian writers of the constant use which the Christians of those days made of the sign of the cross. Tertullian (*De Cor. Mil.* cap. iii.) says: "At each journey and progress, at each coming in and going out, at the putting on of shoes, at the bath, at meals, at the kindling of lights, at bedtime, at sitting down, whatsoever occupation engages us, we mark the brow with the sign of the cross." With so frequent an employment of the sign of the cross in their domestic life, it would be strange if we did not find that it was very frequently used in the public worship of the church. The earliest liturgical forms are comparatively late, and are without rubrics, but the allusions by different writers in early times to the ceremonial use of the sign of the cross in the public services are so numerous, and so much importance was attached to it, that we are left in no manner of doubt on the point. St Augustine, indeed, speaks of the sacraments as not duly ministered if the use of the sign of the cross were absent from their ministration (*Hom. cxviii. in S. Joan.*). Of the later liturgical use of the sign of the cross there is little need to speak, as a reference to the service books of the Greek and Latin churches will plainly indicate the frequency of, and the importance attached to, its employment. Its occasional use is retained by the Lutherans, and in the Church of England it is authori-

tatively used at baptism, and at the "sacring" or anointing of the sovereign at the coronation.

Passing from the sign to the material figures of the cross, a very usual classification distinguishes three main forms: (1) the *crux immissa*, or *capitata* † (fig. 3) known also as the Latin cross, or if each limb is of the same length, + (fig. 4) as the Greek cross; (2) the *crux decussata*, formed like the letter X, and (3) the *crux commissa* or tau cross, already mentioned. It was on a *crux immissa* that Christ is believed to have been crucified. The *crux decussata* is known as St Andrew's cross, from the tradition that St Andrew was put to death on a cross of that form. The *crux commissa* is often called St Anthony's cross, probably only because it resembles the crutch with which the great hermit is generally depicted.



FIG. 3.

FIG. 4.

The cross in one form or other appears, appropriately, on the flags and ensigns of many Christian countries. The English cross of St George is a plain red cross on a white ground, the Scottish cross of St Andrew is a plain diagonal white cross on a blue ground, and the Irish cross of St Patrick is a plain diagonal red cross on a white ground. These three crosses are combined in the Union Jack (see FLAG).

The cross has also been adopted by many orders of knighthood. Perhaps the best known of these is the cross of the knights of Malta. It is a white cross of eight points on a black ground (fig. 5) and is the proper Maltese cross, a name which is often wrongly applied to the cross *patée* (fig. 6). The knights of the Garter use the cross of St George, as do those of the order of St Michael and St George, the knights of the Thistle use St Andrew's cross, and those of St Patrick the cross of St Patrick charged with a shamrock leaf. The cross of the Danish order of the Dannebrog (fig. 7) affords a good example of this use of the cross. It is in form a white cross *patée*, superimposed upon a red one of the same form, and is surmounted by the royal cipher and crown, and has upon its surface the royal cipher repeated, and the legend, or motto, "*Gud og Kongen*" = "God and the King." (For crosses of monastic orders see COSTUME.)

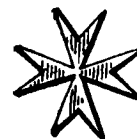

FIG. 5.



FIG. 6.

Akin to the crosses of knightly orders are those which figure as charges on coats of arms. The science of heraldry evolved a wonderful variety of cross-forms during the period it held sway in the middle ages. The different forms of cross used in heraldry are, in fact, so numerous that it is only the larger works on that subject which attempt to record them all. For such crosses see HERALDRY.

In the middle ages the cross form, in one way or another, was predominant everywhere, and was introduced whenever opportunity offered itself for doing so. The larger churches were planned on its outline, so that the ridge line of their roofs proclaimed it far and wide. This was more particularly followed in the north of Europe, but when it was first introduced is not quite certain. All the ancient cathedral churches of England and Wales are cruciform in plan, except Llandaff.

The artistic skill and ingenuity of the medieval designer has produced cross designs of endless variety, and of singular elegance and beauty. Some of the most beautiful of these designs are the gable crosses of the old churches. Fig. 8 shows the west gable cross of Washburn church, Worcestershire; fig. 9 that of the nave of Castle Acre church, Norfolk; and fig. 10 the east gable cross of Hethersett church in that county. They may be taken as good examples of a type of cross which is often of great beauty, but it is overlooked, owing to its bad position for observation.



FIG. 7.—Cross of the Dannebrog.

Other architectural crosses, of great beauty of design, are those which occur on the grave slabs of the middle ages. Instances of a plainer type occur in Saxon times, but it was not till after the 11th century that they were fashioned after the intricate and beautiful designs with which our ancient churches are, as a rule, so plentifully supplied. Sometimes these crosses are incised in the slab, and almost as often they are executed in low relief. The long shaft of the cross is most commonly plain, but there are a very large number of instances in which this is not so, and in which branches, with leaf designs, are thrown

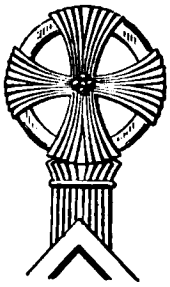

FIG. 8.

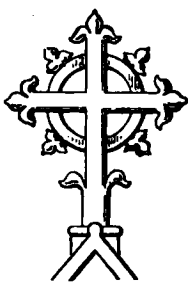

FIG. 9.

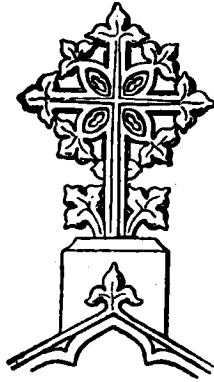

FIG. 10.

out at intervals the entire length of the shaft. In some cases the shaft rises from a series of steps at its base, and in such a case the name of a Calvary cross is applied to it. Fig. 11, from Stradsett church, Norfolk, and fig. 12 from Bosbury church, Herefordshire, are good examples of the designs at the head of sepulchral crosses. Often, by the side of the cross, an emblem or symbol is placed, denoting the calling in life of the person commemorated. Thus a sword is placed to indicate a knight or soldier, a chalice for a priest, and so forth; but it would be travelling beyond the scope of this article to enter into a discussion as to such symbols.

Of upright standing crosses, the Irish and Iona types are well known, and their great artistic beauty and elaboration and excellence of sculpture are universally recognized. These crosses are sometimes spoken of as "Runic Crosses"; and the interlacing knotwork design with which many of them are ornamented

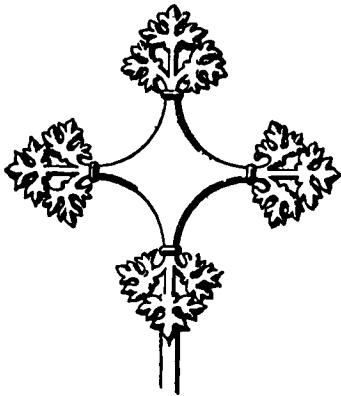

FIG. 11.

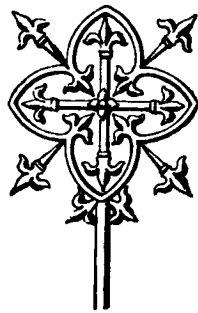

FIG. 12.

is also at times spoken of as "Runic." This is an erroneous application of the word, and has arisen from the fact that some of these crosses bear inscriptions in Runic characters. Standing crosses, of different kinds, were commonly set up in every suitable place during the middle ages, as the mutilated bases and shafts still remaining readily testify. Such crosses were erected in the centre of the market place, in the churchyard, on the village green, or as boundary stones, or marks to guide the traveller. Some, like the Black Friars cross at Hereford, were preaching stations, others, like the beautiful Eleanor crosses at Northampton, Geddington and Waltham, were commemorative in character. Of these latter crosses, which marked the places

where the funeral procession of Queen Eleanor halted, there were originally ten or more, erected between 1241 and 1294. They were placed at Lincoln, Northampton, Stony Stratford, Woburn, Dunstable, St Albans, Waltham and London (Cheapside and Charing Cross). The cross at Geddington differs in outline from those at Northampton and Waltham, and it is not recorded on the roll of accounts for the nine others, all of which are mentioned, but there is no real doubt that it commemorates the resting of the coffin of the queen in Geddington church on its way from Harby. These crosses, like the Black Friars cross at Hereford, are elaborate architectural erections, and very similar to them in this respect are the beautiful market crosses at Winchester, Chichester, Salisbury, Devizes, Shepton Mallet, Leighton Buzzard, &c. Of churchyard crosses, as distinguished from memorial crosses in churchyards, one only is believed to have escaped in a perfect condition the ravages of time, and the fanaticism of the past. It stands in the churchyard of Somerby, in Lincolnshire (Tennyson's birthplace), and is a tall shaft surmounted by a pedimented tabernacle, on one side of which is the crucifixion, and on the other the figure of the Virgin and Child. Churchyard crosses may have been used as occasional preaching stations, for reading the Gospel in the Palm Sunday procession, and generally for public proclamations, made usually at the conclusion of the chief Sunday morning service, much in the same way that market crosses were used on market days as places for proclamations in the towns.

Of the ecclesiastical use of the sign of the cross mention has already been made, and it is desirable to mention briefly one or two instances of the ecclesiastical use of the cross itself. From a fairly early period it has been the prerogative of an archbishop or metropolitan, to have a cross borne before him within the limits of his province. The question urged between the archbishops of Canterbury and York about the carrying of their crosses before them, in each other's province, was a fruitful source of controversy in the middle ages. The archiepiscopal cross must not be confused with the crozier or pastoral staff. The latter, which is formed with a crook at the end, is quite distinct, and is used by archbishops and bishops alike, who bear it with the left hand in processions, and when blessing the people. The archiepiscopal cross, on the contrary, is always borne before the archbishop, or during the vacancy of the archiepiscopal see before the guardian of the spiritualities *sede vacante*. The bishop of Dol in Brittany, of ordinary diocesan bishops, alone possessed the privilege of having a cross borne before him in his diocese. Good illustrations of the archiepiscopal cross occur on the monumental brasses of Archbishop Waldeby, of York (1397), at Westminster Abbey, and of Archbishop Cranley, of Dublin (1417) in New College chapel, Oxford.

The custom of carrying a cross at the head of an ecclesiastical procession can be traced back to the end of the 4th century. The cross was originally taken from the altar, and raised on a pole, and so borne before the procession. Afterwards a separate cross was provided for processions, but in poor churches, where this was not the case, the altar cross continued to be used till quite a late period. A direction to this effect occurs as late as 1829, in the *Rituel* published for the diocese of La Rochelle in that year. In England altar crosses were not very usual in the middle ages.

As a personal ornament the cross came into common use, and was usually worn suspended by a chain from the neck. A cross of this kind, of very great interest and beauty, was found about 1690, on the breast of Queen Dagmar, the wife of Waldemar II., king of Denmark (d. 1213). It is of Byzantine design and workmanship, and is of enamelled gold (fig. 13 shows both sides of it); on one side is the Crucifixion, and on the other side the half figure of our Lord in the centre, with the Virgin and St John the Evangelist on either side, and St Chrysostom and St Basil above and below. From the way in which such crosses were worn, hanging over the chest, they are called pectoral crosses. At the present day a pectoral cross forms part of the recognized insignia of a Roman Catholic bishop, and is worn by him over his robes, but this official use of the pectoral cross is not ancient, and no instance is known of it in England before the Reformation.

The custom appears to have taken rise in the 16th century on the continent. It was not unusual to wear cruciform reliquaries, as objects of personal adornment, and such a reliquary was found on the body of St Cuthbert, when his tomb was opened in 1827, but it was placed under, and not over his episcopal vestments, and formed no part of his bishop's attire. The custom



FIG. 13.—Dagmar Cross.

of wearing a pectoral cross over ecclesiastical robes has, curiously enough, been copied from the comparatively modern Roman Catholic usage by the Lutheran bishops and superintendents in Scandinavia and Prussia; and in Sweden the cross is now delivered to the new bishop, on his installation in office, by the archbishop of Upsala, together with the mitre and crozier. Within the last generation the use of a pectoral cross, worn over their robes as part of the insignia of the episcopal office, has been adopted by some bishops of the Church of England, but it has no ancient sanction or authority.

**AUTHORITIES.**—Mortillet, *Le Signe de la croix avant le Christianisme* (Paris, 1866); Bingham, *Antiquities of the Christian Church*; Lipsius, *De Cruce Christi*; Lady Eastlake, *History of our Lord*, vol. ii.; Cutts, *Manual of Sepulchral Slabs and Crosses*; (Anon.) *Handbook to Christian and Ecclesiastical Rome*, part ii. (London, 1897); Veldeuer, *History of the Holy Cross* (reprint, 1863). (T. M. F.)

**CROSSBILL** (Fr. *Bec-croisé*, Ger. *Kreuzschnabel*), the name given to a genus of birds, belonging to the family *Fringillidae*, or finches, from the unique peculiarity they possess among the whole class of having the horny sheaths of the bill crossing one another obliquely,<sup>1</sup> whence the appellation *Loxia* (λοξός, *obliquus*), conferred by Gesner on the group and continued by Linnaeus. At first sight this singular structure appears so like a deformity that writers have not been wanting to account it such,<sup>2</sup> ignorant of its being a piece of mechanism most beautifully adapted to the habits of the bird, enabling it to extract with the greatest ease, from fir-cones or fleshy fruits, the seeds which form its usual and almost invariable food. Its mode of using this unique instrument seems to have been first described by Townson (*Tracts on Nat. Hist.*, p. 116, London, 1799), but only partially, and it was Yarrell who, in 1829 (*Zool. Journ.*, iv. pp. 457-465, pl. xiv. figs. 1-7), explained fully the means whereby the jaws and the muscles which direct their movements become so effective in riving asunder cones or apples, while at the proper moment the scoop-like tongue is instantaneously thrust out and withdrawn, conveying the hitherto protected seed to the bird's mouth. The articulation of the mandible to the quadrate-bone is such as to allow of a very considerable amount of lateral play, and, by a particular arrangement of the muscles which move the former, it comes to pass that so soon as the bird opens its mouth the point of the mandible is brought immediately opposite to that of the maxilla (which itself is movable vertically), instead of crossing or overlapping it—the usual position when the mouth is closed. The two points thus meeting, the bill is

<sup>1</sup> This peculiarity is found as an accidental malformation in the crows (*Corvidae*) and other groups; it is comparable to the monstrosities seen in rabbits and other members of the order *Glirres*, in which the incisor teeth grow to an inordinate length.

<sup>2</sup> A medieval legend ascribes the conformation of bill and coloration of plumage to a divine recognition of the bird's pity, bestowed on Christ at the crucifixion.

inserted between the scales or into the pome, but on opening the mouth still more widely, the lateral motion of the mandible is once more brought to bear with great force to wrench aside the portion of the fruit attacked, and then the action of the tongue completes the operation, which is so rapidly performed as to defy scrutiny, except on very close inspection. Fortunately the birds soon become tame in confinement, and a little patience will enable an attentive observer to satisfy himself as to the process, the result of which at first seems almost as unaccountable as that of a clever conjuring trick.

The common crossbill of the Palaearctic region (*Loxia curvirostra*) is about the size of a skylark, but more stoutly built. The young (which on leaving the nest have not the tips of the bill crossed) are of a dull olive colour with indistinct dark stripes on the lower parts, and the quills of the wings and tail dusky. After the first moult the difference between the sexes is shown by the hens inclining to yellowish-green, while the cocks become diversified by orange-yellow and red, their plumage finally deepening into a rich crimson-red, varied in places by a flame-colour. Their glowing hues, are, however, speedily lost by examples which may be kept in confinement, and are replaced by a dull orange, or in some cases by a bright golden-yellow, and specimens have, though rarely, occurred in a wild state exhibiting the same tints. The cause of these changes is at present obscure, if not unknown, and it must be admitted that their sequence has been disputed by some excellent authorities, but the balance of evidence is certainly in favour of the above statement. Depending mainly for food on the seeds of conifers, the movements of crossbills are irregular beyond those of most birds, and they would seem to rove in any direction and at any season in quest of their staple sustenance. But the pips of apples are also a favourite dainty, and it is recorded by the old chronicler Matthew Paris (*Hist. Angl.* MS. fol. 252), that in 1251 the orchards of England were ravaged by birds, "pomorum grana, & non aliud de eisdem pomis comedentes," which, from his description, "Habebant autem partes rostri cancellatas, per quas poma quasi forcipi vel cultello dividebant," could be none other but crossbills. Notice of a like visitation in 1593 is recorded, but of late it has become evident that not a year passes without crossbills being observed in some part or other of England, while in certain localities in Scotland they seem to breed annually. The nest is rather rudely constructed, and the eggs, generally four in number, resemble those of the greenfinch, but are larger in size. This species ranges throughout the continent of Europe,<sup>3</sup> and occurs in the islands of the Mediterranean and in the fir-woods of the Atlas. In Asia it would seem to extend to Kamtschatka and Japan, keeping mainly to the forest-tracts.

Three other forms of the genus also inhabit the Old World—two of them so closely resembling the common bird that their specific validity has been often questioned. The first of these, of large stature, the parrot-crossbill (*L. pityopsittacus*), comes occasionally to Great Britain, presumably from Scandinavia, where it is known to breed. The second (*L. himalayana*), which is a good deal smaller, is only known from the Himalaya Mountains. The third, the two-barred crossbill (*L. taenioptera*), is very distinct, and its proper home seems to be the most northern forests of the Russian empire, but it has occasionally occurred in western Europe and even in England.

The New World has two birds of the genus. The first (*L. americana*), representing the common British species, but with a smaller bill, and the males easily recognizable by their more scarlet plumage, ranges from the northern limit of coniferous trees to the highlands of Mexico, or even farther. The other (*L. leucoptera*) is the equivalent of the two-barred crossbill, but smaller. It has twice occurred in England. (A. N.)

**CROSSEN**, or **KROSSEN**, a town of Germany, in the kingdom of Prussia, on the Oder, here crossed by a bridge, at the influx of the Bober, 31 m. S.E. of Frankfort-on-Oder by rail. Pop. (1900) 7369. Of the churches in the town three are Protestant

<sup>3</sup> Dr Malmgren found a small flock on Bear Island (lat. 74½° N.), but to this barren spot they must have been driven by stress of weather.

and one Roman Catholic. Besides the modern school (Realprogymnasium), there are a technical school for viniculture and fruit-growing and a dairy school. There are manufactories of copper and brass ware, cloth, &c., while in the surrounding country the chief industries are fruit and grape growing. There is a brisk shipping trade, mainly in wine, fruit and fish. Crossen was founded in 1005 and was important during the middle ages as a point of passage across the Oder. It attained civic rights in 1232, was for a time the capital of a Silesian duchy, which, on the death of Barbara of Brandenburg, widow of the last duke, passed to Brandenburg (1482). In May 1886 the town was devastated by a whirlwind.

**CROSSING**, in architecture, the term given to the intersection of the nave and transept, frequently surmounted by a tower or by a dome on pendentives.

**CROSSKEY, HENRY WILLIAM** (1826-1893), English geologist and Unitarian minister, was born at Lewes in Sussex, on the 7th of December 1826. After being trained for the ministry at Manchester New College (1843-1848), he became pastor of Friargate chapel, Derby, until 1852, when he accepted charge of a Unitarian congregation in Glasgow. In 1869 he removed to Birmingham, where until the close of his life he was pastor of the Church of the Messiah. While in Glasgow his interest was awakened in geology by the perusal of A. C. Ramsay's *Geology of the Isle of Arran*, and from 1855 onwards he devoted his leisure to the pursuit of this science. He became an authority on glacial geology, and wrote much, especially in conjunction with David Robertson, on the post-tertiary fossiliferous beds of Scotland (*Trans. Geol. Soc. Glasgow*). He also prepared for the British Association a valuable series of Reports (1873-1892) on the erratic Blocks of England, Wales and Ireland. In conjunction with David Robertson and G. S. Brady he wrote the *Monograph of the Post Tertiary Entomostraca of Scotland, &c.* for the Palaeontographical Society (1874); and he edited H. Carvill Lewis' *Papers and Notes on the Glacial Geology of Great Britain and Ireland*, issued posthumously (1894). He died at Edgbaston, Birmingham, on the 1st of October 1893.

See *H. W. Crosskey: his Life and Work*, by R. A. Armstrong (with chapter on his geological work by Prof. C. Lapworth, 1895).

**CROSS RIVER**, a river of West Africa, over 500 m. long. It rises in 6° N., 10° 30' E. in the mountains of Cameroon, and flows at first N.W. In 8° 48' E., 5° 50' N. are a series of rapids; below this point the river is navigable for shallow-draught boats. At 8° 20' E., 6° 10' N., its most northern point, the river turns S.W. and then S., entering the Gulf of Guinea through the Calabar estuary. The Calabar river, which rises about 5° 30' N., 8° 30' E., has a course parallel to, and 10 to 20 m. east of, the Cross river. Near its mouth, on its east bank, is the town of Calabar (*q.v.*). It enters the estuary in 4° 45' N. The Cross, Calabar, Kwa and other streams farther east, which rise on the flanks of the Cameroon Mountains, form a large delta. The Calabar and Kwa rivers are wholly within the British protectorate of Southern Nigeria, as is the Cross river from its mouth to the rapids mentioned. The upper course of the river is in German territory.

**CROSS-ROADS, BURIAL AT**, in former times the method of disposing of executed criminals and suicides. At the cross-roads a rude cross usually stood, and this gave rise to the belief that these spots were selected as the next best burying-places to consecrated ground. The real explanation is that the ancient Teutonic peoples often built their altars at the cross-roads, and as human sacrifices, especially of criminals, formed part of the ritual, these spots came to be regarded as execution grounds. Hence after the introduction of Christianity, criminals and suicides were buried at the cross-roads during the night, in order to assimilate as far as possible their funeral to that of the pagans. An example of a cross-road execution-ground was the famous Tyburn in London, which stood on the spot where the Oxford, Edgware and London roads met.

**CROSS SPRINGER**, in architecture, the block from which the diagonal ribs of a vault spring or start: the top of the springer is known as the skewback (see ARCH).

**CROTCH, WILLIAM** (1775-1847), English musician, was born in Green's Lane, Norwich, on the 5th of July 1775. His father was a master carpenter. The child was extraordinarily precocious, and when scarcely more than two years of age he played upon an organ of his parent's construction something like the tune of "God save the King." At the age of four he came to London and gave daily recitals on the organ in the rooms of a milliner in Piccadilly. The precocity of his musical intuition was almost equalled by a singularly early aptitude for drawing. In 1786 he went to Cambridge as assistant to Dr Randall the organist. His oratorio *The Captivity of Judah* was played at Trinity Hall, Cambridge, on the 4th of June 1789. He was then only fourteen years of age. His intention of entering the church carried him to Oxford in 1788, but the superior attractions of a musical career acquired an increasing influence over him, and in 1790 he was appointed organist of Christ Church. At the early age of twenty-two he was appointed professor of music in the university of Oxford, and there in 1799 he took his degree of doctor in that art. In 1800 and the four following years he read lectures on music at Oxford. Next he was appointed lecturer on music to the Royal Institution, and subsequently, in 1822, principal of the London Royal Academy of Music. His last years were passed at Taunton in the house of his son, the Rev. W. R. Crotch, where he died suddenly on the 29th of December 1847. He published a number of vocal and instrumental compositions, of which the best is his oratorio *Palestine*, produced in 1812. In 1831 appeared an 8vo volume containing the substance of his lectures on music, delivered at Oxford and in London. Previously, he had published three volumes of *Specimens of Various Styles of Music*. Among his didactic works is *Elements of Musical Composition and Thorough-Bass* (London, 1812). The oratorio bearing the title *The Captivity of Judah*, and produced on the occasion of the installation of the duke of Wellington as chancellor of the university of Oxford in 1834, is a totally different work from that which he wrote upon the same subject as a boy of fourteen. He arranged for the pianoforte a number of Handel's oratorios and operas, besides symphonies and quartets of Haydn, Mozart and Beethoven. The great expectations excited by his infant precocity were not fulfilled; for he manifested no extraordinary genius for musical composition. But he was an industrious student and a sound artist, and his name remains familiar in English musical history.

**CROTCHET** (from the Fr. *croche*, a hook; whence also the Anglicized "crochet," pronounced as in French, for the knitting-work done with a hook instead of on pins), properly a small hook, and so used of the hook-like *setae* or bristles found in certain worms which burrow in sand. In music, a "crotchet" is a note of half the value of a minim and double that of a quaver; it is marked by a round black head and a line without a tail or hook; the French *croche* is used of a "quaver" which has a tail, but in ancient music the *semiminima*, the modern crotchet, is marked by an open note with a hook. Derived either from an old French proverbial phrase, *il a des crochues en teste*, or from a meaning of twist or turn, as in the similar expression "crank," comes the sense of a whim, fancy or perverse idea, seen also in the adjective "crotchety" of a fussy unreasonable person.

**CROTONA, CROTO or CROTON** (Gr. *Κρότων*, mod. Cotrone) a Greek town on the E. coast of the territory of the Bruttii (mod. *Calabria*), on a promontory 7 m. N.W. of the Lacinian promontory. It was founded by a colony of Achaeans led by Myscellus in 710 B.C. Its name was, according to the legend, that of a local prince who afforded hospitality to Heracles, but was accidentally killed by him and buried on the spot. Like Sybaris, it soon became a city of power and wealth. It was especially celebrated for its successes in the Olympic games from 588 B.C. onwards, Milo being the most famous of its athletes. Pythagoras established himself here between 540 and 530 B.C. and formed a society of 300 disciples (among whom was Milo), who acquired considerable influence with the supreme council of 1000 by which the city was ruled. In 510 B.C. Crotona was strong enough to defeat the Sybarites, with whom it had



previously been on friendly terms, and raze their city to the ground. Shortly afterwards, however, an insurrection took place, by which the disciples of Pythagoras were driven out, and a democracy established. The victory of the Locrians and Phlegians over Crotona in 480 B.C. marked the beginning of its decline. It suffered after this from the attacks of Dionysius I., who became its master for twelve years, of the Bruttii, and of Agathocles, and even more from the invasion of Pyrrhus, after which in 277 the Romans obtained possession of it. Livy states that the walls had a length of 12 m. and that about half the area within them had at that time ceased to be inhabited. After the battle of Cannae Crotona revolted from Rome, and Hannibal made it his winter quarters for three years. It was made a colony by the Romans at the end of the war (194 B.C.). After that time but little is heard of it, though Petronius mentions the corrupt morals of its inhabitants; but it continues to be mentioned down to the Gothic wars. The importance of the city was mainly due to its harbour, which, though not a good one, was the only port between Tarentum and Rhegium. The original settlement occupied the hill above it (143 ft.) and later became the acropolis. Its healthy situation was famous in antiquity, and to this was ascribed its superiority in athletics; it was the seat also of a medical school which in the days of Herodotus was considered the first in Greece. Of the exact site of the ancient city and its remains practically nothing is known; a few fragments of the productions of its art preserved in private hands at Cotrone are described by F. von Duhn in *Notizie degli scavi*, 1897, 343 seq. (T. As.)

**CROTONIC ACID** ( $C_4H_6O_2$ ). Three acids of this empirical formula are known, viz. crotonic acid, isocrotonic acid and methacrylic acid; the constitutional formulae are—

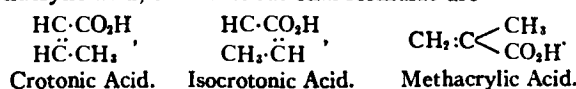

The isomerism of crotonic and isocrotonic acids is to be explained on the assumption of a different spatial arrangement of the atoms in the molecule (see STEREOCHEMISTRY).

Crotonic acid, so named from the fact that it was erroneously supposed to be a saponification product of croton oil, may be prepared by the oxidation of croton-aldehyde,  $\text{CH}_3\text{:CH}\cdot\text{CH}\cdot\text{CHO}$ , obtained by dehydrating aldol, or by treating acetylene successively with sulphuric acid and water; by boiling allyl cyanide with caustic potash; by the distillation of  $\beta$ -oxybutyric acid; by heating paraldehyde with malonic acid and acetic acid to  $100^\circ\text{C}$ . (T. Komnenos, *Ann.*, 1883, 218, p. 149).



or by heating pyruvic acid with an excess of acetic anhydride and sodium acetate to  $160\text{--}180^\circ\text{C}$ . (B. Homolka, *Ber.*, 1885, 18, p. 987). It crystallizes in needles (from hot water) which melt at  $72^\circ\text{C}$ . and boil at  $180\text{--}181^\circ\text{C}$ . It is moderately soluble in cold water. It combines directly with bromine, and, with fuming hydrobromic acid at  $100^\circ\text{C}$ ., it gives chiefly  $\alpha$ -bromobutyric acid. With hydriodic acid it gives only  $\beta$ -iodobutyric acid. Potash fusion converts it into acetic acid; nitric acid oxidizes it to acetic and oxalic acids; chromic acid mixture to acetaldehyde and acetic acid, and potassium permanganate to  $\alpha\beta$ -dioxibutyric acid.

Isocrotonic acid (Quartenylic acid) is obtained from  $\beta$ -chlorisocrotonic acid, formed when acetoacetic ester is treated with phosphorus pentachloride and the product poured into water, by the action of sodium amalgam (A. Geuther). It is an oil, possessing a smell like that of butyric acid. It boils at  $171\cdot9^\circ\text{C}$ ., with partial conversion into crotonic acid; the transformation is complete when the acid is heated to  $170\text{--}180^\circ\text{C}$ . in a sealed tube. Potassium permanganate oxidizes it to  $\beta\gamma$ -dioxibutyric acid.

Methacrylic acid was first obtained in the form of its ethyl ester by E. Frankland and B. F. Duppa (*Annalen*, 1865, 136, p. 12) by acting with phosphorus pentachloride on oxyisobutyric ester ( $\text{CH}_3)_2\text{C}(\text{OH})\cdot\text{COOC}_2\text{H}_5$ . It is, however, more readily ob-

tained by boiling citra- or meso-bromopyrotartaric acids with alkalis. It crystallizes in prisms, which are soluble in water, melt at  $16^\circ\text{C}$ ., and boil at  $160\cdot5^\circ\text{C}$ . When fused with an alkali, it forms propionic acid; with bromine it yields  $\alpha\beta$ -dibromoisobutyric acid. Sodium amalgam reduces it to isobutyric acid. A polymeric form of methacrylic acid has been described by F. Engelhorn (*Ann.*, 1880, 200, p. 70).

**CROTON OIL** (*Crotonis Oleum*), an oil prepared from the seeds of *Croton Tiglium*, a tree belonging to the natural order Euphorbiaceae, and native or cultivated in India and the Malay Islands. The tree is from 15 to 20 ft. in height, and has few and spreading branches, alternate, oval-oblong leaves, acuminate at the point, and covered when young with stellate hairs, and terminal racemes of small, downy, greenish-yellow, monoecious flowers. The male blossoms have five petals and fifteen stamens; the females have no petals but a large oblong ovary bearing three bifid styles. The fruit or capsule is obtusely three-cornered, and about the size of a hazel-nut; it contains three cells each enclosing a seed. The seeds resemble those of the castor-oil plant; they are about half an inch long, and two-fifths of an inch broad, and have a cinnamon-brown, brittle integument; between the two halves of the kernel lie the large cotyledons and radicle. The ocular distinction between the two kinds of seeds may be of great practical importance. The most obvious distinction is that the castor-oil seeds have a polished and mottled surface. The kernels contain from 50 to 60% of oil, which is obtained by pressing them, when bruised to a pulp, between hot plates. Croton oil is a transparent and viscid liquid of a brownish or pale-yellow tinge, and acrid, peculiar and persistent taste, a disagreeable odour and acid reaction. It is soluble in volatile oils, carbon disulphide, and ether, and to some extent in alcohol. It contains acetic, butyric and valeric acids, with glycerides of acids of the same series, and a volatile body,  $C_6H_8O_2$ , tiglic acid, metameric with angelic acid, and identical with methylcrotonic acid,  $\text{CH}_3\text{:CH}\cdot\text{C}(\text{CH}_3)(\text{CO}_2\text{H})$ . The odour is due to various volatile acids, which are present to the extent of about 1%. A substance called crotonal appears to be responsible for its external, but not its internal, action. The latter is probably due to crotonic acid,  $C_6H_{10}O_2$ , which has active purgative properties. The maximum dose of croton oil is two minims, one-fourth of that quantity being usually ample.

Applied to the skin, croton oil acts as a powerful irritant, inducing so much inflammation that definite pustules are formed. The destruction of the true skin gives rise to ugly scars which constitute, together with the pain caused by this application, abundant reason why croton oil should never be employed externally. Despite the pharmacopoeial liniment and the practice of a few, it may be said that this employment of croton oil is now entirely without justification or excuse.

Taken internally, even in the minute doses already detailed, croton oil very soon causes much colic and the occurrence of a fluid diarrhoea which usually recurs several times. It is characteristic of this purgative that it is a hydragogue even in minimal dose, the fluid secretions of the bowel being most markedly increased. The drug appears to act only upon the small intestine. In somewhat larger doses it produces severe gastro-enteritis. The flow of bile is somewhat increased. Such effects may all be produced, even up to the discharge of blood, by the absorption of croton oil from the skin.

The minuteness of the dose, the certainty of the action, and the large amount of fluid drained away constitute this the best drug for administration to an unconscious patient (especially in cases of apoplexy, when it is desirable to remove fluid from the body), or to insane patients who refuse to take any drug. One drop of the oil, placed on the back of the tongue, must inevitably be swallowed by reflex action. A dose should never be repeated. The characters of this drug obviously contraindicate its use in all cases of organic disease or obstruction of the bowel, in pregnancy, or in cases of constipation in children or the aged.

**CROUP**, a name formerly given to diseases characterized by distress in breathing accompanied by a metallic cough and some

hoarseness of speech. It is now known that these symptoms are often associated with diphtheria (*q.v.*), spasmodic laryngitis (*q.v.*), and a third disease, spasmodic croup, to which the term is now alone applied. This occurs most frequently in children above two years of age; the child goes to bed quite well, and a few hours later suddenly awakes with great difficulty in inspiration, the chest wall becomes markedly retracted, and there is a metallic cough. The child becomes cyanosed, and, to the inexperienced nurse, seems in an almost moribund condition. In the course of four or five minutes, normal respiration starts again, and the attack is over for the time being; but it may recur several times a day. The seizure may be accompanied by convulsions, and death has occurred from dyspnoea. The best treatment is to plunge the child into a warm bath, and sponge the back and chest with cold water. Subsequently this can be done two or three times a day. Should the cyanosis become very severe, respiration can be restarted by making the child sick, either with a dose of ipecacuanha wine, or by forcing one's finger down the throat. Generally the bowels should be attended to; and the throat carefully examined for enlarged tonsils or adenoids, which if present should be treated.

**CROUSAZ, JEAN PIERRE DE** (1663–1750), Swiss writer, was born at Lausanne. He was a many-sided man, whose numerous works on many subjects had a great vogue in their day, but are now forgotten. He has been described as an *initiateur plutôt qu'un créateur*, chiefly because he introduced at Lausanne the philosophy of Descartes in opposition to the reigning Aristotelianism, and also as a Calvinist pendant (for he was a pastor) of the French *abbés* of the 18th century. He studied at Geneva, Leyden and Paris, before becoming (1700) professor of philosophy and mathematics at the academy of Lausanne, of which he was four times rector before 1724, when the theological disputes connected with the *Consensus*<sup>1</sup> led him to accept a chair of philosophy and mathematics at Groningen. In 1726 he was appointed governor to the young prince Frederick of Hesse-Cassel, and in 1735 returned to Lausanne with a good pension. In 1737 he was reinstated in his old chair, which he retained to his death. Gibbon, describing his first stay at Lausanne (1752–1755), writes in his *Autobiography*, “the logic of de Crousaz had prepared me to engage with his master Locke and his antagonist Bayle.”

The most important of his works are: *Nouvel Essai de logique* (1712), *Géométrie des lignes et des surfaces rectilignes et circulaires* (1712), *Traité du beau* (1714), *Examen du traité de la liberté de penser d'Antoine Collins* (1718), *De l'éducation des enfants* (1722, dedicated to the then Princess of Wales), *Examen du pyrrhonisme ancien et moderne* (1733, an attack chiefly on Bayle), *Examen de l'essai de M. Pope sur l'homme* (1737, an attack on the Leibnitzian theory of that poem), *Logique* (6 vols., 1741), *De l'esprit humain* (1741), and *Réflexions sur l'ouvrage intitulé: La Belle Wolfienne* (1743). (W. A. B. C.)

**CROW** (Dutch, *kraai*, Ger. *Kräh*e, Fr. *corbeau*, Lat. *corvus*), a name most commonly applied in Britain to the bird properly called a rook (*Corvus frugilegus*), but perhaps originally peculiar to its congener, nowadays usually distinguished as the black or carrion-crow (*C. corone*). By ornithologists it is also used in a far wider sense, as under the title crows, or *Corvidae*, is included a vast number of birds from almost all parts of the world, and this family is probably the most highly developed of the whole class *Aves*. Leaving out of account the best known of these, as the raven, rook, daw, pie and jay, with their immediate allies, our attention will here be confined to the crows in general; and then the species of the family to which the appellation is more strictly applicable may be briefly considered. All authorities admit that the family is very extensive, and is capable of being parted into several groups, but scarcely any two agree. Especially must reserve be exercised as regards the group *Streperinae*, or piping crows, belonging to the Australian Region, and referred by some writers to the shrikes (*Laniidae*); and the jays too have been erected into a distinct family (*Garrulidae*),

<sup>1</sup> The “*Consensus ecclesiarum Helveticarum reformatarum*” was a document drawn up in 1675 and imposed in 1722—as a test of strict Protestant orthodoxy as to the doctrine of grace—by Bern on its subjects in Lausanne and Vaux.

though it seems hardly possible to separate them even as a subfamily from the pies (*Pica* and its neighbours), which lead almost insensibly to the typical crows (*Corvinae*). Dismissing these subjects for the present, it will perhaps be most convenient to treat of the two groups which are represented by the genera *Pyrrhacorax* or choughs, and *Corvus* or true crows in the most limited sense.

*Pyrrhacorax* comprehends at least two very good species, which have been needlessly divided generically. The best known of them is the Cornish chough (*P. graculus*), formerly a denizen of the precipitous cliffs of the south coast of England, of Wales, of the west and north coasts of Ireland, and some of the Hebrides, but now greatly reduced in numbers, and only found in such places as are most free from the intrusion of man or of daws (*Corvus monedula*), which last seem to be gradually dispossessing it of its sea-girt strongholds, and its present scarcity is probably in the main due to its persecution by its kindred. In Britain, indeed, it would appear to be only one of the survivors of a more ancient fauna, for in other countries where it is found it has been driven inland, and inhabits the higher mountains of Europe and North Africa. In the Himalayas a larger form occurs, which has been specifically distinguished (*P. himalayanus*), but whether justifiably so may be doubted. The general colour is a glossy black, and it has the bill and legs bright red. The remaining species (*P. alpinus*) is altogether a mountaineer, and does not affect a sea-shore life. Otherwise it frequents much the same kind of localities, but it does not occur in Britain. The alpine chough is somewhat smaller than its congener, and is easily distinguished by its shorter and bright yellow bill. Remains of both have been found in French caverns the deposits in which were formed during the “Reindeer Age.” Commonly placed by systematists next to *Pyrrhacorax* is the Australian genus *Corcorax*, represented by a single species (*C. melanorhamphus*), but this assignment of the bird, which is chiefly a frequenter of woodlands, cannot be admitted without hesitation.

Coming now to what may be literally considered crows, our attention is mainly directed to the black or carrion-crow (*Corvus corone*) and the grey, hooded or Royston crow (*C. cornix*). Both these inhabit Europe, but their range and the time of their appearance are very different. The former is, speaking generally, a summer visitant to the south-western part of Europe, and the latter occupies the north-eastern portion—an irregular line drawn diagonally from about the Firth of Clyde to the head of the Adriatic roughly marking their respective distribution. But both are essentially migrants, and hence it follows that when the black crow, as summer comes to an end, retires southward, the grey crow moves downward, and in many districts replaces it during winter. Further than this, it has been incontrovertibly proved that along or near the boundary where these two birds march they not infrequently interbreed, and it is believed that the hybrids, which sometimes wholly resemble one or other of the parents and at other times assume an intermediate plumage, pair indiscriminately among themselves or with the pure stock. Hence it has seemed to many ornithologists who have studied the subject, that these two birds, so long unhesitatingly regarded as distinct species, are only local races of one and the same dimorphic species. No structural difference—or indeed any difference except that of range (already spoken of) and colour—can be detected, and the problem they offer is one of which the solution is exceedingly interesting if not important to zoologists in general.<sup>2</sup> Almost omnivorous in their diet, there is little edible that comes amiss to them, and, except in South America, they are mostly omnipresent. The fish-crow of North America (*C. ossifragus*) demands a few words, since it betrays a taste for maritime habits beyond that of other species, but the crows of Europe are not averse on occasion to prey cast up by the waters. The house-crow of India (*C. splendens*) is not very nearly allied to its European namesakes, from which

<sup>2</sup> As bearing upon this question may be mentioned the fact that the crow of Australia (*C. australis*) is divisible into two forms or races, one having the irides white, the other of a dark colour. It is stated that they keep apart and do not intermix.

it can be readily distinguished by its smaller size and the lustrous tints of its darkest feathers, while its confidence in the human race has been so long encouraged by its intercourse with an unarmed and inoffensive population that it becomes a plague to the European abiding or travelling where it is abundant. Hardly a station or camp in British India is free from a crowd of feathered followers of this species, ready to dispute with the kites and the crows the very meat at the fire. (A. N.)

**CROWBERRY**, or **CRABERRY**, the English name for a low-growing heath-like shrub, found on heaths and rocks in Scotland, Ireland and mountainous parts of England. It is known botanically as *Empetrum nigrum*, and has slender, wiry, spreading branches covered with short, narrow, stiff leaves, the margins of which are recurved so as to form a hollow cylinder concealing the hairy under face of the leaf—a device to avoid excessive loss of water from the leaf under the exposed conditions in which the plant grows. The minute flowers are succeeded by black, edible, berry-like fruits, one-fourth to one-third of an inch in diameter. The plant has a wide distribution, occurring in suitable localities throughout the north temperate zone, and on the Andes of South America.

**CROWD**, **CROUTH**, **CROWTH** (Welsh *crwth*; Fr. *crouth*; Ger. *Chrotta*, *Hrotta*), a medieval stringed instrument derived from the lyre, characterized by a sound-chest having a vaulted back and an open space left at each side of the strings to allow the hand to pass through in order to stop the strings on the finger-board. The Welsh *crwth*, which survived until the end of the



FIG. 1.—Welsh Crwth, 18th century.

18th century, is best represented by a specimen of that date preserved in the Victoria and Albert Museum, and described and illustrated by Carl Engel.<sup>1</sup> The instrument consists of a rectangular sound-chest 22 in. long, 9½ in. wide and 2 in. deep; the body is scooped out of a single block, the flat belly being glued on. Right through the sound-chest on each side of the finger-board is the characteristic open space left for the hand to pass through. There are two circular sound-holes; the left foot of the flat bridge, which lies obliquely across the belly, passes through the left sound-hole and rests inside on the back of the instrument. Six catgut strings fastened to a tail-piece are wound round pegs at the top of the *crwth*; four of these strings lie over the sound-board and bridge, and are set in vibration by means of a bow, while the two others, used as drones and stretched across the left-hand aperture, are twanged by the thumb of the left hand. The shape and shallowness of the bridge make it impossible to sound a single string with the bow; the arrangement of the strings suggests that they were intended to be sounded in pairs. The instrument is

tuned thus: 

At the beginning of the 19th century, William Bingley<sup>2</sup> heard a Welsh peasant playing national airs on a *crwth* strung as follows:—

 Sir John Hawkins<sup>3</sup> relates

that in his time there was still a Welshman living in Anglesea who understood how to play the *crwth* according to traditional usage. Edward Jones<sup>4</sup> and Daines Barrington<sup>5</sup> both give an account of the Welsh *crwth* of the 18th century which agrees substantially with Engel's; the illustration communicated by Daines Barrington shows the strings of the *crwth* drawn through holes at the top, and fastened on the back, as on the Persian *rebab* and other Oriental stringed instruments. On these somewhat scanty authentic records of the instrument, several historians of music

<sup>1</sup> See *Early History of the Violin Family* (London, 1883), pp. 24-36.

<sup>2</sup> See *A Tour round North Wales* (London, 1804), vol. ii. p. 332.

<sup>3</sup> *History of Music* (London, 1766), vol. ii. bk. iii. ch. iii., description and illustration.

<sup>4</sup> *Musical and Poetical Relicks of Welsh Bards* (London, 1794), illustration of *crwth*, also reproduced by Carl Engel; see note above.

<sup>5</sup> *Archaeologia*, vol. iii. (London, 1775).

have based an illogical claim that the *crwth*, or rather *chrotta* or *rotta*, mentioned by Venantius Fortunatus as a British instrument, was the Welsh *crwth* as it was known in the 18th century, and was the earliest bowed instrument, and therefore the ancestor of the violin. The lines of Fortunatus, who was bishop of Poitiers during the second half of the 6th century, ran thus:—

“Romanusque lyra, plaudat tibi Barbarus harpa,  
Graecus Achilliaca, *chrotta* Britannia canat.”

The bow is not mentioned by Fortunatus, and there is no ground whatever for believing that the Welsh *crwth* was played with a bow in the 6th century, or indeed for several centuries after. The stringing of the Welsh *crwth* with the two drone strings still twanged, the form of the body without incurvations, the flat bridge which rendered bowing, even in the most highly developed specimens of the 18th century, a difficult task, together with what is known of the early history of the *chrotta* and *rotta* derived from the lyre and *cithara* and like them twanged by fingers or plectrum, all make the claim untenable. Carl Engel was probably the first to expose the fallacy in his work on the violin.<sup>7</sup>

British lexicographers all agree in deriving the words *crwth*, *crowd* and other forms of the name, from some word meaning a bulging protuberant bellying form, while in German the etymology of the word *Chrotta* is given as *Chrota* or *Chreta*, the O.H.G. for *Kröte*=toad, *Schildkröte*=tortoise. This word *Chrotta* was undoubtedly the German equivalent term for the lyre of Hermes, having as back a tortoise-shell, *χέλυσ* in Greek and *testudo* in Latin. *Chrotta* was also spelt *hrotta*, and it is easy to see how this became *rotta*. A thoughtful and suggestive treatment of the whole subject will be found in Engel's work, to which reference has been made. Just as the lyre and *cithara*, which appeared to be similar to the casual observer, and are indeed still confused at the present day, were instruments differing essentially in construction<sup>8</sup>; so there were, during the early middle ages, while lyre and *cithara* were still in transition, two types of *chrotta* or *rotta*. (1) The *rotta* or improved *cithara* had a body either rectangular with the corners rounded, or guitar-shaped with incurvations, back and sound-board being nearly or quite flat, joined as in the *cithara* by ribs or sides. This *rotta* must be reckoned among the early ancestors of the violin before the advent of the bow; it was known both as *rotta* and *cithara*, and with a neck added it became the guitar-fiddle. (2) The tortoise or lyre *chrotta* consisted of a protuberant, very convex back cut out of a block of wood, to which was glued a flat sound-board, at first like the lyre, without intermediary ribs. This instrument became the *crwth*, and there was no further development. The first step in the transition of both lyre and *cithara* was the incorporation of arms and cross-bar into the body, the same outline being preserved; the second step was the addition of a finger-board against which the strings were stopped, thus increasing the compass while restricting the number of strings to three or four; the third step, observed only in the *rotta-cithara*, consisted in the addition of a neck,<sup>9</sup> as in the guitar. The *crwth*, *crowd*, *crouth* did not undergo this third transition even when the bow was used to set the strings in vibration.



Drawn from a plate in Auguste de Bastard's *Peintures et ornements de la bible de Charles le Chauve*.

FIG. 2.—Early Crwth, 9th century.

The earliest representation of the *crwth* yet discovered dates from the Carolingian period. In the miniatures of the Bible of Charles the Bald,<sup>10</sup> in the Bibliothèque Nationale, Paris, one of the musicians of King David is seen stopping strings on the finger-board with his left hand and plucking them with the right (fig. 2); this *crwth* has only three strings, and may be the *crwth trithant* of Wales. A second example occurs in the Bible of St Paul,<sup>11</sup> another of the magnificent MSS. prepared for Charles the Bald, and preserved during the middle ages in the monastery of St Paul *extra muros* in Rome (now deposited

<sup>6</sup> Venantius Fortunatus, *Poëmata*, lib. vii. cap. 8, p. 245; see Migne's *Patrologia Sacra*, vol. 88.

<sup>7</sup> *Op. cit.* chapters "Crwth," "Chrotta," "Rotta."

<sup>8</sup> See Kathleen Schlesinger, *Orchestral Instruments*, part ii., "The Precursors of the Violin Family" (London, 1909), pp. 14 to 23, with illustrations.

<sup>9</sup> See also Kathleen Schlesinger, *op. cit.* ch. vii., "The Cithara in Transition," pp. 111-135 with illustrations.

<sup>10</sup> See Auguste de Bastard, *Peintures et ornements des MSS. de France, and Peintures, ornements, &c., de la bible de Charles le Chauve*, in facsimile (Paris, 1883).

<sup>11</sup> See J. O. Westwood, *Photographic Facsimile of the Bible of St Paul* (London, 1876).

in that of St Calixtus in Rome). Other representations are in the miniatures of the 11th, 12th and 13th centuries. To Edward Heron-Allen (*De fiduculis opuscula*, viii., 1895) is due the discovery of a representation of the Welsh crwth, showing the form still retained in the 18th cent. On the seal of Roger Wade (1316) is a crwth differing but little from the specimen in the Victoria and Albert



FIG. 3.—Crowd on a 14th-century Seal.

Museum. The 14th-century instrument had four strings instead of six, and the foot of the bridge does not appear to pass through the sound-hole—a detail which may have escaped the notice of the artist who cut the seal. The original seal lies in the muniment room at Berkeley Castle in Gloucestershire attached to a defeasance of a bond between the crowdier and his debtor Warren de l'Isle, and a cast (see fig. 3) is preserved at the British Museum. The British Museum also possesses two interesting MSS. which concern the crwth: one of these (Add. MS. 14939 ff. 4 and 27) contains an extract made by Lewis Morris in 1742 from an ancient Welsh MS. of "Instructions supposed to be wrote for the Crowd"; the other (Add. MS. 15036 ff. 65b and 66) consists of tracings from a 16th-century Welsh MS. copied in 1610 of a bagpipe, a harp and a *krythe*, together with the names of those who played the last at the Eisteddfod. The drawing is crude, and shows an instrument similar to Roger Wade's crowd, but having three strings instead of four.

The genealogical tree of the violin given below shows the relative positions of both kinds of rotta and chrotta.

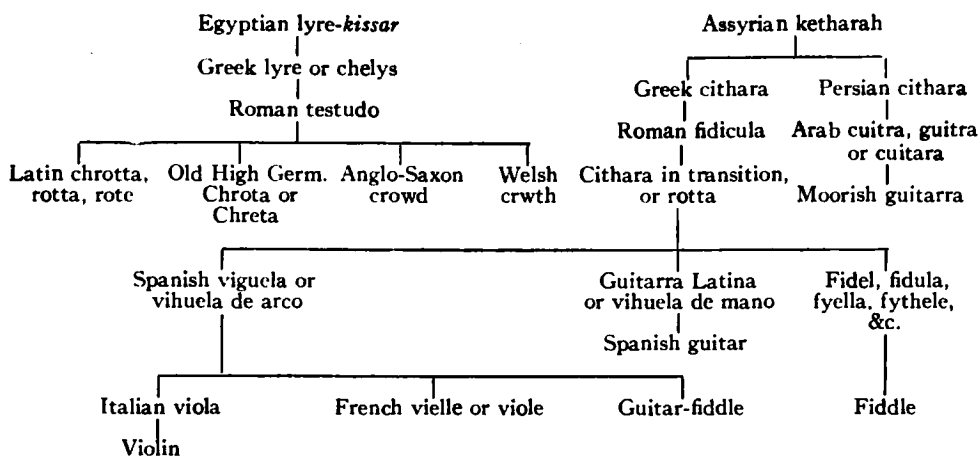

The Welsh crwth was therefore obviously not an exclusively Welsh instrument, but only a late 18th-century survival in Wales of an archaic instrument once generally popular in Europe but long obsolete. An interesting article on the subject in German by J. F. W. Wewertem will be found in *Monatshefte für Musik* (Berlin, 1881), Nos. 7-12, p. 151, &c. (K. S.)

**CROWE, EYRE EVANS** (1799-1868), English journalist and historian, was born about the year 1799. He commenced his work as a writer for the London newspaper press in connexion with the *Morning Chronicle*, and he afterwards became a leading contributor to the *Examiner* and the *Daily News*. Of the latter journal he was principal editor for some time previous to his death. The department he specially cultivated was that of continental history and foreign politics. He published *Lives of Foreign Statesmen* (1830), *The Greek and the Turk* (1853), and *Reigns of Louis XVIII. and Charles X.* (1854). These were followed by his most important work, the *History of France* (5 vols., 1858-1868). It was founded upon original sources, in order to consult which the author resided for a considerable time in Paris. He died in London on the 25th of February 1868.

**CROWE, SIR JOSEPH ARCHER** (1828-1896), English consular official and art critic, son of Eyre Crowe, was born in London on the 25th of October 1828. At an early age he showed considerable aptitude for painting and entered the studio of Delaroche in Paris, where his father was correspondent of the *Morning Chronicle*. During the Crimean War he was the correspondent of

the *Illustrated London News*, and during the Austro-Italian War represented *The Times* in Vienna. He was British consul-general in Leipzig from 1860 to 1872, and in Düsseldorf from 1872 to 1880, when he was appointed commercial attaché in Berlin, being transferred in a like capacity to Paris in 1882. In 1883 he was secretary to the Danube Conference in London; in 1889 plenipotentiary at the Samoa Conference in Berlin; and in 1890 British envoy at the Telegraph Congress in Paris, in which year he was made K.C.M.G. During a sojourn in Italy, 1846-1847, he cemented a lifelong friendship with the Italian critic Giovanni Battista Cavalcaselle (1820-1897), and together they produced several historical works on art of classic importance, notably *Early Flemish Painters* (London, 1857); *A New History of Painting in Italy from the Second to the Sixteenth Century* (London, 1864-1871, 5 vols.). In 1895 Crowe published *Reminiscences of Thirty-Five Years of My Life*. He died at Schloss Gamburg in Bavaria on the 6th of September 1896.

Crowe and Cavalcaselle's great *History of Painting* was under revision by Crowe up to the time of his death, and then by S. A. Strong (d. 1904) and Langton Douglas, who in 1903 brought out vols. i. and ii. of Murray's new six-volume edition, the 3rd vol., edited by Langton Douglas, appearing in 1909. A reprint of the original edition, brought up to date by annotations by Edward Huttons, was published by Dent in 3 vols. in 1909.

**CROW INDIANS**, or **ABSAROKAS** (the name for a species of hawk), a tribe of North American Indians of Siouan stock. They are now settled to the number of some 1800 on a reservation in southern Montana to the south of the Yellowstone river.

Their original range included this reservation and extended eastward and southward, and no part of the country for hundreds of miles around was safe from their raids. They have ever been known as marauders and horse-stealers, and, though they have generally been cunning enough to avoid open war with the whites, they have robbed them whenever opportunity served. Physically they are tall and athletic, with very dark complexions.

**CROWLAND**, or **CROYLAND**, a market-town in the S. Kesteven or Stamford parliamentary division of Lincolnshire, England; in a low fen district on the river Welland, 8 m. N.E. of Peter-

borough, and 4 m. from Postland station on the March-Spalding line of the Great Northern and Great Eastern railways, and Peakirk on the Great Northern. Pop. (1901) 2747. A monastery was founded here in 716 by King Æthelbald, in honour of St Guthlac of Mercia (d. 714), a young nobleman who became a hermit and lived here, and, it was said, had foretold Æthelbald's accession to the throne. The site of St Guthlac's cell, not far from the abbey, is known as Anchor (anchorite's) Church Hill. After the abbey had suffered from the Danish incursions in 870, and had been burnt in that year and in 1091, a fine Norman abbey was raised in 1113. Remains of this building appear in the ruined nave and tower arch, but the most splendid fragment is the west front, of Early English date, with Perpendicular restoration. The west tower is principally in this style. The north aisle is restored and used as the parish church. Among the abbots was Ingulphus (1085-1109), to whom was formerly attributed the *Historia Monasterii Croylandensis*. A curious triangular bridge remains, apparently of the 14th century, but referred originally to the middle of the 9th century, which spanned three streams now covered, and affords three footways which meet at an apex in the middle.

The town of Crowland grew up round the abbey. By a charter dated 716, Æthelbald granted the isle of Crowland, free from all secular services, to the abbey with a gift of money, and leave to build and enclose the town. The privileges thus



obtained were confirmed by numerous royal charters extending over a period of nearly 800 years. Under Abbot Ægelric the fens were tilled, the monastery grew rich, and the town increased in size, enormous tracts of land being held by the abbey at the Domesday Survey. The town was nearly destroyed by fire (1469-1476), but the abbey tenants were given money to rebuild it. By virtue of his office the abbot had a seat in parliament, but the town was never a parliamentary borough. Abbot Ralph Mershe in 1257 obtained a grant of a market every Wednesday, confirmed by Henry IV. in 1421, but it was afterwards moved to Thorney. The annual fair of St Bartholomew, which originally lasted twelve days, was first mentioned in Henry III.'s confirmatory charter of 1227. The dissolution of the monastery in 1539 was fatal to the progress of the town, which had prospered under the thrifty rule of the monks, and it rapidly sank into the position of an unimportant village. The abbey lands were granted by Edward VI. to Lord Clinton, from whose family they passed in 1671 to the Orby family. The inhabitants formerly carried on considerable trade in fish and wild fowl.

See R. Gough, *History and Antiquities of Croyland* (Bibl. Top. Brit. iii. No. 11) (London, 1783); W. G. Searle, *Ingulf and the Historia Croylandensis* (Camb. Antiq. Soc., No. 27); Dugdale, *Monasticon*, ii. 91 (London, 1846; Cambridge, 1894).

**CROWLEY, ROBERT** (1518?-1588), English religious and social reformer, was born in Gloucestershire, and educated at Magdalen College, Oxford, of which he was successively demy and fellow. Coming to London, he set up a printing-office in Ely Rents, Holborn, where he printed many of his own writings. As a typographer, his most notable production was an edition of *Pierce Plowman* in 1550, and some of the earliest Welsh printed books came from his press. As an author, his first venture seems to have been his "Information and Petition against the Oppressors of the poor Commons of this realm," which internal evidence shows to have been addressed to the parliament of 1547. It contains a vigorous plea for a further religious reformation, but is more remarkable for its attack on the "more than Turkish tyranny" of the landlords and capitalists of that day. While repudiating communism, Crowley was a Christian Socialist, and warmly approved the efforts of Protector Somerset to stop enclosures. In his *Way to Wealth*, published in 1550, he laments the failure of the Protector's policy, and attributes it to the organized resistance of the richer classes. In the same year he published (in verse) *The Voice of the last Trumpet blown by the seventh Angel*; it is a rebuke in twelve "lessons" to twelve different classes of people; and a similar production was his *One-and-Thirty Epigrams* (1550). These, with *Pleasure and Pain* (1551), were edited for the Early English Text Society in 1872 (Extra Ser. xv.). The dozen or more other works which Crowley published are more distinctly theological: indeed, the failure of the temporal policy he advocated seems to have led Crowley to take orders, and he was ordained deacon by Ridley on the 29th of September 1551. During Mary's reign he was among the exiles at Frankfurt. At Elizabeth's accession he became a popular preacher, was made archdeacon of Hereford in 1559, and prebendary of St Paul's in 1563, and was incumbent first of St Peter's the Poor in London, and then of St Giles' without Cripplegate. He refused to minister in the "conjuring garments of popery," and in 1566 was deprived and imprisoned for resisting the use of the surplice by his choir. He stated his case in "A brief Discourse against the Outward Apparel and Ministering Garments of the Popish Church," a tract "memorable," says Canon Dixon, "as the first distinct utterance of Nonconformity." He continued to preach occasionally, and in 1576 was presented to the living of St Lawrence Jewry. Nor had he abandoned his connexion with the book trade, and in 1578 he was admitted a freeman of the Stationers' Company. He died on the 18th of June 1588, and was buried in St Giles'. The most important of his works not hitherto mentioned is his continuation of Languet and Cooper's *Epitome of Chronicles* (1559).

See J. M. Cowper's *Pref. to the Select Works of Crowley* (1872); Strype's *Works*; Gough's *General Index to Parker Soc. Publ.*;

*Machyn's Diary*; Macray's *Reg. Magdalen College*; Newcourt's *Rep. Eccles. Lond.*; Hennessy's *Nov. Rep. Eccl.* (1898); Le Neve's *Fasti Eccl. Angl.*; Pocock's *Burnet*; Pollard's *England under Somerset*; R. W. Dixon's *Church History*. (A. F. P.)

**CROWN**, an English silver coin of the value of five shillings, hence often used to express the sum of five shillings. It was originally of gold and was first coined in the reign of Henry VIII. Edward VI. introduced silver crowns and half-crowns, and down to the reign of Charles II. crowns and half-crowns and sometimes double crowns were struck both in gold and silver. In the reign of Edward VI. also was introduced the practice of dating coins and marking them with their current value. The "Oxford crown" struck in the reign of Charles I. was designed by Rawlins (see NUMISMATICS: *Medieval*). Since the reign of Charles II. the crown has been struck in silver only. At one time during the 19th century it was proposed to abandon the issue of the crown, and from 1861 until 1887 none was struck, but since the second issue in 1887 it has been freely in circulation again.

**CROWN** and **CORONET**, an official or symbolical ornament worn on or round the head. The crown (Lat. *corona*) at first had no regal significance. It was a garland, or wreath, of leaves or flowers, conferred on the winners in the athletic games. Afterwards it was often made of gold, and among the Romans was bestowed as a recognition of honourable service performed or distinction won, and on occasion it took such a form as to correspond with, or indicate the character of, the service rendered. The *corona obsidionalis* was formed of grass and flowers plucked on the spot and given to the general who conquered a city. The *corona civica*, made of oak leaves with acorns, was bestowed on the soldier who in battle saved the life of a Roman citizen. The mural crown (*corona muralis*) was the decoration of the soldier who was the first to scale the walls of a besieged city, and was usually a circlet of gold adorned with a series of turrets. The naval crown (*corona navalis*), decorated in like manner with a series of miniature prows of ships, was the reward of him who gained a notable victory at sea. These latter crowns form charges in English heraldry (see HERALDRY).

Many other forms of crown were used by the Romans, as the conqueror's triumphal crown of laurel, the myrtle crown, and the convivial, bridal, funeral and other crowns. Some of the emperors wore crowns on occasion, as Caligula and Domitian, at the games, and stellate or spike crowns are depicted on the heads of several of the emperors on their coins, but no idea of imperial sovereignty was indicated thereby. The Roman people, who had accepted imperial rule as a fact, were very jealous of the employment of its emblem on the part of their rulers. That emblem was the diadem, and although the diadem and crown are frequently confused with each other they were quite distinct, and it is well to bear this in mind. The diadem, which was of eastern origin, was a fillet or band of linen or silk, richly embroidered, and was worn tied round the forehead. Selden (*Titles of Honour*, chap. viii. sect. 8) says that the diadem and crown "have been from ancient times confounded, yet the diadem strictly was a very different thing from what a crown now is or was, and it was no other than only a fillet of silk, linen, or some such thing." It is desirable to remember the distinction, for, although diadem and crown are now used as synonymous terms, the two were originally quite distinct. The confusion between them has, perhaps, come about from the fact that the modern crown seems to be rather an evolution from the diadem than the lineal descendant of the older crowns. The linen or silk diadem was eventually exchanged for a flexible band of gold, which was worn in its place round the forehead. The further development of the crown from this was readily effected by the addition of an upper row of ornament. Thus the medieval and modern crowns may be considered as radiated diadems, and so the diadem and crown have become, as it were, merged in one another.

Among the historical crowns of Europe, the Iron Crown of Lombardy, now preserved at Monza, claims notice. It is a band of iron, enclosed in a circlet formed of six plates of gold,



hinged one to the other, and richly jewelled and enamelled. It is regarded with great reverence, owing to a legend that the inner band of iron has been hammered out of one of the nails of the true cross. The crown is so small, the diameter being only 6 in., and the circlet only 2½ in. in width, that doubts have been felt as to whether it was originally intended to be worn on the head or was merely meant to be a votive crown. The legend as to the iron being that of one of the nails of the cross is rejected by Muratori and others, and cannot be traced far back. How it arose or how any credence came to be reposed in the legend, it is difficult to surmise. Another historical crown is that of Charlemagne, preserved at Vienna. It is composed of a series of four larger and four smaller plaques of gold, rounded at the tops and set together alternately. The larger plaques are richly ornamented with emeralds and sapphires, and the smaller plaques have each an enamelled figure of Our Lord, David, Solomon, and Hezekiah respectively. A jewelled cross rises from the large front plaque, and an arch bearing the name of the emperor Conrad springs across from the back of this cross to the back of the crown.

At Madrid there is preserved the crown of Svintilla, king of the Visigoths, 621-631. It is a circlet of thick gold set with pearls, sapphires and other stones. It has been given as a votive offering at some period to a church, as was often the custom. Attached to its upper rim are the chains whereby to suspend it, and from the lower rim hang letters of red-coloured glass or paste which read +SVINTILANVS REX OFFERET. Two other Visigothic crowns are also preserved with it in the Armeria Real.

In 1858 a most remarkable discovery was made near Toledo, of eight gold crowns of the 7th century, fashioned lavishly with barbaric splendour. They are now in the Cluny Museum at Paris, having been purchased for £4000, the intrinsic value of the gold, without reckoning that of the jewels and precious stones, being not less than £600. The largest and most magnificent is the crown of Reccesvinto, king of the Visigoths from 653 to 675. It is composed of a circlet of pure gold set with pearls and precious stones in great profusion, which gives it a most sumptuous appearance. It is 9 in. in diameter and more than ½ in. in thickness, the width of the circlet being 4 in. It has also been given as a votive offering to a church, and has

soon afterwards followed they were buried out of sight for safety, where they were eventually discovered absolutely unharmed centuries afterwards. For a detailed description of these most remarkable crowns the reader must be referred to a paper by the late Mr Albert Way (*Archaeological Journal*, xvi. 253). Mr Way, in the article alluded to, says of the custom of offering crowns to churches that frequent notices of the usage may be found in the lives of the Roman pontiffs by Anastasius. "They are usually described as having been placed over the altar, and in many instances mention is made of jewelled crosses of gold appended within such crowns as an accessory ornament. . . . The crowns suspended in churches suggested doubtless the sumptuous pensile luminaries, frequently designated from a very early period as *coronae*, in which the form of the royal circlet was preserved in much larger proportions, as exemplified by the remarkable *corona* still to be seen suspended in the cathedral at Aix-la-Chapelle over the crypt in which the body of Charlemagne was deposited."



FIG. 1.—The Papal Tiara (without the *infulae*).

Of modern continental crowns the imperial crown of Austria (fig. 4) may be mentioned. It is composed of a circlet of gold, adorned with precious stones and pearls, heightened with fleurs-de-lys, and is raised above the circlet in the form of a cap which is opened in the middle, so that the lower part is crescent-shaped; across this opening from front to back rises an arched fillet, enriched with pearls and surmounted by an orb, on which is a cross of pearls.

The papal *tiara* (a Greek word, of Persian origin, for a form of ancient Persian popular head-dress, standing high erect, and worn encircled by a diadem by the kings), the triple crown worn by the popes, has taken various forms since the 9th century. It is important to remember that the tiaras in old Italian pictures are inventions of the artists and not copied from actual examples. In its present shape, dating substantially from the Renaissance, it is a peaked head-covering not unlike a closed mitre (*q.v.*), round which are placed one above the other three circlets or open



Figs. 2-4 from Meyer's *Konversations Lexikon*.

FIG. 2.—Crown of the Holy Roman Empire.



FIG. 3.—Crown of the German Empire.



FIG. 4.—Crown of the Austrian Empire.

the chains to hang it by attached to the upper rim, while from the lower rim depend pearls, sapphires and a series of richly jewelled letters 2 in. each in depth, which read +RECCESVINTHVS REX OFFERET. The second of these crowns in size is generally thought to be that of the queen of Reccesvinto. It has no legend, but merely a cross hanging from it. The six others are smaller, and are all most richly ornamented. They are believed to have been the crowns of Reccesvinto's children. From one of them hangs a legend which relates that they were an offering to a church, which has been identified with much probability as that of Sorbas, a small town in the province of Almeria. It has been surmised that in the disturbances which

crowns.<sup>1</sup> Two bands, or *infulae*, as they are called, hang from it as in the case of a mitre. The tiara is the crown of the pope as a temporal sovereign (see TIARA).

<sup>1</sup> A coloured drawing, done in the first half of the 18th century, of the magnificent tiara made by the celebrated goldsmith, Caradosso, for Julius II., is in the Print-Room, British Museum. It was re-fashioned by Pius VI., but went with other treasure as part of the indemnity to Napoleon. The splendid emerald at the summit, which was engraved with the arms of Gregory XIII., was restored by Napoleon and now adorns another papal tiara at Rome. In this drawing the three crowns (a feature introduced at the beginning of the 14th century) are represented by three bands of X-shaped ornament in enamelled gold.

Pictorial representations in early manuscripts, and the rude effigies on their coins, are not very helpful in deciding as to the form of crown worn by the Anglo-Saxon and Danish kings of England before the Norman Conquest. In some cases it would appear as if the diadem studded with pearls had been worn, and in others something more of the character of a crown. We reach surer ground after the Conquest, for then the great seals, monumental effigies, and coins become more and more serviceable in determining the forms the crown took.

The crown of William the Conqueror and his immediate successors seems to have been a plain circlet with four uprights,



FIG. 5.



FIG. 6.



FIG. 7.



FIG. 8.



FIG. 9.



FIG. 10.

Royal Crowns. William I. to Henry IV.

which terminated in trefoils (fig. 5), but Henry I. enriched the circlet with pearls or gems (fig. 6), and on his great seal the trefoils have something of the character of fleurs-de-lys. The effigy of Richard I. at Fontevault shows a development of the crown; the trefoil heads are expanded, and are chased and jewelled. The crown of John is shown on his effigy at Worcester, though unfortunately it is rather badly mutilated. It shows, however, that the upper ornament was of fleurons set with jewels. Fig. 7 shows generally this development of the crown in a restored form. The crown on the effigy of Henry III. at Westminster had a beaded row below the circlet, which is narrow and plain, and from it rises a series of plain trefoils with slightly raised points between them. The tomb was opened in 1774, and on the king's head was found an imitation crown of tin or latten gilt, with trefoils rising from its upper edge. This, although only made of base metal for the king's burial, may nevertheless be taken as exhibiting the form of the royal crown at the time, and it may be usefully compared with that on the effigy of the king, which was made in Edward I.'s reign (fig. 8). Edward I. used a crown of very similar design. In the crown of Edward II. we have perhaps the most graceful and elegant of all the forms which the English medieval crown assumed (fig. 9), and it seems to have continued without any marked alteration during the reigns of Edward III. and Richard II. The crown on the head of the effigy of Henry IV. at Canterbury evidently represents one of great magnificence, both of design and ornament. What is perhaps lost of the grace of form of the crown of Edward II. is made up for by a profusion of adornment and ornamentation unsurpassed at any later period (fig. 10). The circlet is much wider and is richly chased and jewelled, and from it rise eight large leaves, the intervening spaces being filled with fleurs-de-lys of definite outline. It will be noted that this crown is, like its predecessors, what is known as an open crown, without any arches rising from the circlet, but in the accounts of the coronation of Henry IV. by Froissart and Waurin it is distinctly stated that the crown was arched in the form of a cross. This is the earliest mention of an arched crown, which is not represented on the great seal till that of Edward IV. in 1461. The crown, as shown on Henry IV.'s effigy, very probably represents the celebrated "Harry crown" which was afterwards broken up and employed as surety for the loan required by Henry V. when he was about to embark on his expedition to France. Fig. 11 shows the crown of Henry V. The crown of

Henry VI. seems to have had three arches, and there is the same number shown on the crown of Henry VII., which ensigns the hawthorn bush badge of that king. The crown of Edward IV. (fig. 12) shows two arches, and a crown similarly arched appears on the great seal of Richard III. Crowns, both open and arched, are represented in sculpture and paintings until the end of the reign of Edward IV., and the royal arms are occasionally ensigned by an open crown as late as the reign of Henry VIII. The crown of Henry VII. on his effigy in Westminster Abbey shows a circlet surmounted by four crosses and four fleurs-de-lys alternately, and has two arches rising from it. A similar crown appears on the great seal of Henry VIII. The crown of Henry VII. (fig. 13), which ensigns the royal arms above the south door of King's College chapel, Cambridge, has the motto of the order of the Garter round the circlet. Fig. 14 shows the form of crown used by Edward VI., but a tendency (not shown in the illustration) began of flattening the arches of the crown, and on some of the coins of Elizabeth the arches are not merely flattened, but are depressed in the centre, much after the character of the arches of the crown on many of the silver coins of the 19th century prior to 1887. The crowns of James I. and Charles I. had four arches, springing from the alternate crosses and fleurs-de-lys of the circlet (fig. 15). The crown which strangely enough surmounts the shield with the arms of the Commonwealth on the coins of Oliver Cromwell (as distinguished from those of the Commonwealth itself, which have no crown) is a royal crown with alternate crosses and fleurs-de-lys round the circlet, and is surmounted by three arches, which, though somewhat flattened, are not bent. On them rests the orb and cross. The crown used by Charles II. (fig. 16) shows the arches depressed in the centre, a feature of the royal crown which seems to have been continued henceforward till 1887, when the pointed form of the arches was resumed, in consonance with an idea that such a form indicated an imperial rather than a regal crown, Queen Victoria having been proclaimed empress of India in 1877. In the foregoing account the changes of the form of the crowns of the kings have been briefly noticed. Those crowns were the personal crowns, worn by the different kings on various state occasions, but they were all crowned before the Commonwealth with the ancient crown of St Edward, and the queens consort with that of Queen Edith. There were, in fact, two sets of regalia, the one used for the coronations and kept at Westminster,

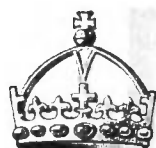

FIG. 11.



FIG. 12.



FIG. 13.



FIG. 14.



FIG. 15.

Royal Crowns. Henry V. to Charles I.

and the other that used on other occasions by the kings and kept in the Tower. The crowns of this latter set were the personal crowns made to fit the different wearers, and are those which have been briefly described. The crown of St Edward, with which the sovereigns were crowned, had a narrow circlet from which rose alternately four crosses and four fleurs-de-lys, and from the crosses sprang two arches, which at their crossing supported an orb and cross. These arches must have been a later addition, and possibly were first added for the coronation of Henry IV. (*vide supra*). Queen Edith's crown had a plain

circlet with, so far as can be determined, four crosses of pearls or gems on it, and a large cross patée rising from it in front, and arches of jewels or pearls terminating in a large pearl at the top. A valuation of these ancient crowns was made at the time of the Commonwealth prior to their destruction. From this valuation we learn that St Edward's crown was of gold filigree or "wirework" as it is called, and was set with stones, and was valued at £248. Queen Edith's crown was found to be only of silver-gilt, with counterfeit pearls, sapphires and other stones,



FIG. 16.

FIG. 17.

FIG. 19.

Recent Forms of the English Crown.

and was only valued at £16. At the Restoration an endeavour was made to reproduce as well as possible the old crowns and regalia according to their ancient form, and a new crown of St Edward was made on the lines of the old one for the coronation of Charles II. The framework of this crown, bereft of its jewels, is in the possession of Lady Amherst of Hackney. The crowns of James II., William III. and Anne generally resembled it in form (fig. 16). The later crowns of the Georges and William IV. are represented in general form in fig. 17. Although the marginal note in the coronation order of Queen Victoria indicates "K. Edward's crown" as that with which the late queen was to be crowned, it was actually the state or imperial crown worn by the sovereign when leaving the church after the ceremony that was used. It had been altered for the coronation, and the arches were formed of oak leaves (fig. 18). Fig. 19 shows Queen Victoria's crown with raised arches and without the inner cap of estate, which since the reign of Henry VII. has been degraded into forming a lining to the crowns of the sovereigns and the coronets of the peers. Fig. 20 shows the coronation crown of King Edward VII. The crown of Scotland, preserved with the Scottish regalia at Edinburgh, is believed to be composed of the original circlet worn by King Robert the Bruce. James V.

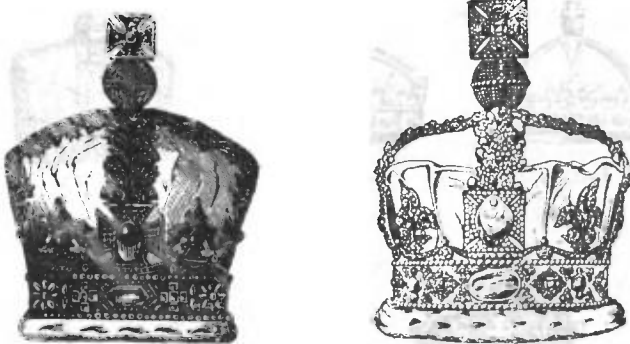

FIG. 18.

FIG. 20.

Coronation Crowns of Queen Victoria and King Edward VII.

made additions to it in 1535, and in general characteristics it much resembles an English crown of that date.

The kings of arms in England, Scotland and Ireland wear crowns, the ornamentation of which round the upper rim of the circlet is composed of a row of acanthus or oak leaves. Round the circlet is the singularly inappropriate text from Psalm li., "*Miserere mei Deus secundum magnam misericordiam tuam.*" The form of these crowns seems to have been settled in the reign of Charles II. Before that period they varied at different times, according to representations given of them in grants of arms, &c.

This brings us to the crowns of lesser dignity, known for that reason as coronets, and worn by the five orders of peers.

The use of crowns by dukes originated in 1362, when Edward III. created his sons Lionel and John dukes of Clarence and Lancaster respectively. This was done by investing them with a sword, a cap of maintenance or estate, and with a circlet of gold set with precious stones, which was imposed on the head. Previous to this dukes had been invested at their creation by the girding on of a sword only. In 1387 Richard II. created Richard de Vere marquess of Dublin, and invested him by girding on a sword, and by placing a golden circlet on his head. The golden circlet was confined to dukes and marquesses till 1444, when Henry VI. created Henry Beauchamp, earl of Warwick, premier earl, and the letters patent effecting this concede that the earl and his heirs shall wear a golden circlet on the head on feast days, even in the royal presence. As to the form of these circlets we have no clear knowledge. The dignity of a viscount was first created by Henry VI. in 1439, but nothing is said of any insignia pertaining to that dignity.



FIG. 21.



FIG. 22.

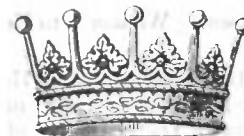

FIG. 23.

Coronets of Dukes, Marquesses and Earls.

It is believed that a circlet of gold with an upper rim of pearls was first conferred on a viscount by James I., who conceded it to Robert Cecil, Viscount Cranborne. However, in 1625-1626 it is definitely recorded that the viscounts carried their coronets in their hands in the coronation procession from Westminster Hall to the Abbey church. The use of a coronet by the barons dates from the coronation of Charles II., and by letters patent of the 7th of August 1661 their coronet is described as a circle of gold with six pearls on it.



FIG. 24.



FIG. 25.

Coronets of Viscounts and Barons.

At the present day the coronet of a duke (fig. 21) is formed of a circlet of gold, from which rise eight strawberry leaves. The coronet of a marquess (fig. 22) differs from that of a duke in having only four strawberry leaves, the intervening spaces being occupied by four low points which are surmounted by pearls. The coronet of an earl (fig. 23) differs again by having eight tall rays on each of which is set a pearl, the intervening spaces being occupied by strawberry leaves one-fourth of the height of the rays. The coronet of a viscount (fig. 24) has sixteen small pearls fixed to the golden circlet, and the coronet of a baron (fig. 25) has six large pearls similarly arranged.

AUTHORITIES.—L. G. Wickham Legg, *English Coronation Records* (London, 1901); *The Ancestor*, Nos. i. and ii. (London, 1902); Stothard, *The Monumental Effigies of Great Britain* (London, 1817). (T. M. F.)

**CROWN DEBT**, in English law, a debt due to the crown. By various statutes—the first dating from the reign of Henry VIII. (1541)—the crown has priority for its debts before all other creditors. At common law the crown always had a lien on the lands and goods of debtors by record, which could be enforced even when they had passed into the hands of other persons. The difficulty of ascertaining whether lands were subject to a crown lien or not was often very great, and a remedy was provided by the Judgments Act 1839, and the Crown Suits Act

1865. Now by the Land Charges Act 1900, no debt due to the crown operates as a charge on land until a writ of execution for the purpose of enforcing it has been registered under the Land Charges Registration and Searches Act 1888. By the Act of 1541 specialty debts were put practically on the same footing as debts by record. Simple contract debts due to the crown also become specialty debts, and the rights of the crown are enforced by a summary process called an *extent* (see WRIT).

**CROWNE, JOHN** (d. c. 1703), British dramatist, was a native of Nova Scotia. His father "Colonel" William Crowne, accompanied the earl of Arundel on a diplomatic mission to Vienna in 1637, and wrote an account of his journey. He emigrated to Nova Scotia where he received a grant of land from Cromwell, but the French took possession of his property, and the home government did nothing to uphold his rights. When the son came to England his poverty compelled him to act as gentleman usher to an Independent lady of quality, and his enemies asserted that his father had been an Independent minister. He began his literary career with a romance, *Pandion and Amphigenia, or the History of the coy Lady of Thessalia* (1665). In 1671 he produced a romantic play, *Juliana, or the Princess of Poland*, which has, in spite of its title, no pretensions to rank as an historical drama. The earl of Rochester procured for him, apparently with the sole object of annoying Dryden by infringing on his rights as poet-laureate, a commission to supply a masque for performance at court. *Calisto* gained him the favour of Charles II., but Rochester proved a fickle patron, and his favour was completely alienated by the success of Crowne's heroic play in two parts, *The Destruction of Jerusalem by Titus Vespasian* (1677). This piece contained a thinly disguised satire on the Puritan party in the description of the Pharisees, and about 1683 he produced a distinctly political play, *The City Politiques*, satirizing the Whig party and containing characters which were readily recognized as portraits of Titus Oates and others. This made him many enemies, and he petitioned the king for a small place that would release him from the necessity of writing for the stage. The king exacted one more comedy, which should, he suggested, be based on the *No puet esser* of Moreto. This had already been unsuccessfully adapted, as Crowne discovered later, by Sir Thomas St Serfe, but in Crowne's hands it developed into *Sir Courtly Nice, It Cannot Be* (1685), a comedy which kept its place as a stock piece for nearly a century. Unfortunately Charles II. died before the play was completed, and Crowne was disappointed of his reward. He continued to write plays, and it is stated that he was still living in 1703, but nothing is known of his later life.

Crowne was a fertile writer of plays with an historical setting, in which heroic love was, in the fashion of the French romances, made the leading motive. The prosaic level of his style saved him as a rule from the rant to be found in so many contemporary heroic plays, but these pieces are of no particular interest. He was much more successful in comedy of the kind that depicts "humours."

*The History of Charles the Eighth of France, or The Invasion of Naples by the French* (1672) was dedicated to Rochester. In *Timon*, generally supposed to have been written by the earl, a line from this piece—"whilst sporting waves smil'd on the rising sun"—was held up to ridicule. *The Ambitious Statesman, or The Loyal Favourite* (1679), one of the most extravagant of his heroic efforts, deals with the history of Bernard d'Armagnac, Constable of France, after the battle of Agincourt; *Thyestes, A Tragedy* (1681), spares none of the horrors of the Senecan tragedy, although an incongruous love story is interpolated; *Darius, King of Persia* (1688), *Regulus* (acted 1692, pr. 1694) and *Caligula* (1698) complete the list of his tragedies. *The Country Wit: A Comedy* (acted 1675, pr. 1693), derived in part from Molière's *Le Sicilien, ou l'amour peintre*, is remembered for the leading character, Sir Mannerly Shallow; *The English Friar; or The Town Sparks* (acted 1689, pr. 1690), perhaps suggested by Molière's *Tartuffe*, ridicules the court Catholics, and in Father Finical caricatures Father Petre; and *The Married Beau; or The Curious Impertinent* (1694), is based on the *Curioso Impertinente* in Don Quixote. He also produced a version of Racine's *Andromaque*, an adaptation from Shakespeare's *Henry VI.*, and an unsuccessful comedy, *Justice Busy*.

See *The Dramatic Works of John Crowne* (4 vols., 1873), edited by James Maidment and W. H. Logan for the *Dramatists of the Restoration*.

**CROWN LAND**, in the United Kingdom, land belonging to the crown, the hereditary revenues of which were surrendered to parliament in the reign of George III.

In Anglo-Saxon times the property of the king consisted of (a) his private estate, (b) the demesne of the crown, comprising palaces, &c., and (c) rights over the folkland of the kingdom. By the time of the Norman Conquest the three became merged into the estate of the crown, that is, land annexed to the crown, held by the king as king. The king, also, ceased to hold as a private owner,<sup>1</sup> but he had full power of disposal by grant of the crown lands, which were increased from time to time by confiscation, escheat, forfeiture, &c. The history of the crown lands to the reign of William III. was one of continuous alienation to favourites. Their wholesale distribution by William III. necessitated the intervention of parliament, and in the reign of Queen Anne an act was passed limiting the right of alienation of crown lands to a period of not more than thirty-one years or three lives. The revenue from the crown lands was also made to constitute part of the civil list. At the beginning of his reign George III. surrendered his interest in the crown lands in return for a fixed "civil list" (*q.v.*). The control and management of the crown lands is now regulated by the Crown Lands Act 1829 and various amending acts. Under these acts their management is entrusted to the commissioners of Woods, Forests and Land Revenues, who have certain statutory powers as to leasing, selling, exchanging, &c.

In theory, also, state lands in the British colonies are supposed to be vested in the crown, and they are called crown lands; actually, however, the various colonial legislatures have full control over them and power of disposal. The term "crown-lands," in Austria, is applied to the various provinces into which that country is divided. (See AUSTRIA.)

**CROWN POINT**, a village of Essex county, New York, U.S.A., in a township of the same name, about 90 m. N.E. of Albany and about 10 m. N. of Ticonderoga, on the W. shore of Lake Champlain. Pop. of the township (1890) 3135; (1900) 2112; (1905, state census) 1890; of the village, about 1000. The village is served by the Delaware & Hudson Railway and by the Champlain Canal. Among the manufactures are lumber and woodenware. Graphite has been found in the western part of the township, and spar is mined. In 1609 Champlain fought near here the engagement with the Iroquois Indians which marked the beginning of the long enmity between the Five (later Six) Nations and the French. Subsequently Dutch and English traders trafficked in the vicinity, the latter maintaining here for many years a regular trading-post. In 1731 the French built here Fort Frédéric, the first military post at Crown Point, and the place was subsequently for many years of considerable strategic importance, owing to its situation on Lake Champlain, which with Lake George furnished a comparatively easy route from Canada to New York. Twice during the French and Indian War, in 1755 and again in 1756, English and colonial expeditions were sent against it in vain; it remained in French hands until 1759, when, after Lord Jeffrey Amherst's occupation of Ticonderoga, the garrison joined that of the latter place and retreated to Canada. Crown Point was then occupied by Amherst, who during the winter of 1759-1760 began the construction, about a quarter of a mile from the old Fort Frédéric, of a large fort, which was garrisoned but was never completed; the ruins of this fort (not of Fort Frédéric) still remain. At the outbreak of the War of Independence, on the 11th of May 1775, the fort, whose garrison then consisted of only a dozen men, was captured by Colonel Seth Warner and a force of "Green Mountain Boys," sent from Ticonderoga by Ethan Allen; and it remained in American hands save for a brief period in 1777, when it was occupied by a detachment of Burgoyne's invading army.

**CROWTHER, SAMUEL ADJAI** (1809?-1891), African missionary-bishop, was born at Ochugu in the Yoruba country,

<sup>1</sup>The duchy of Lancaster, which was the private property of Henry IV. before he ascended the throne, was assured to him and his heirs by a special act of parliament. In the first year of Henry VII. it was united to the crown, but as a separate property.

West Africa, and was sold into slavery in 1821. Next year he was rescued, with many other captives, by H.M. ship "Myrmidon," and was landed at Sierra Leone. Educated there in a missionary school, he was baptized on the 11th of December 1825. In time he became a teacher at Furah Bay, and afterwards an energetic missionary on the Niger. He came to England in 1842, entered the Church Missionary College at Islington, and in June 1843 was ordained by Bishop Blomfield. Returning to Africa, he laboured with great success amongst his own people and afterwards at Abeokuta. Here he devoted himself to the preparation of school-books, and the translation of the Bible and Prayer-Book into Yoruba and other dialects. He also established a trade in cotton, and improved the native agriculture. In 1857 he commenced the third expedition up the Niger, and after labouring with varied success, returned to England and was consecrated, on St Peter's Day 1864, first bishop of the Niger territories. Before long a commencement was made of the missions to the delta of the Niger, and between 1866 and 1884 congregations of Christians were formed at Bonny, Brass and New Calabar, but the progress made was slow and subject to many impediments. In 1888 the tide of persecution turned, and several chiefs embraced Christianity, and on Crowther's return from another visit to England, the large iron church known as "St Stephen's cathedral" was opened. Crowther died of paralysis on the 31st of December 1891, having displayed as a missionary for many years untiring industry, great practical wisdom, and deep piety.

**CROYDON**, a municipal, county and parliamentary borough of Surrey, England, suburban to London, 10 m. S. of London Bridge. Pop. (1891) 102,695; (1901) 133,895. The borough embraces a great residential district. Several railway stations give it communication with all parts of the metropolis, the principal railways serving it being the London, Brighton & South Coast and the South-Eastern & Chatham. It stands near the sources of the river Wandle, under Banstead Downs, and is a place of great antiquity. The original site, farther west than the present town, is mentioned in Domesday Book. The derivation indicated is from the O. Fr. *croie dune*, chalk hill. The supposition that here was the Roman station of *Noviomagus* is rejected. The site is remarkable for the number of springs which issue from the soil. One of these, called the "Bourne," bursts forth a short way above the town at irregular intervals of one to ten years or more; and after running a torrent for two or three months, as quickly vanishes. Until its course was diverted it caused destructive floods. This phenomenon seems to arise from rains which, falling on the chalk hills, sink into the porous soil and reappear after a time from crevices at lower levels. The manor of Croydon was presented by William the Conqueror to Archbishop Lanfranc, who is believed to have founded the archiepiscopal palace there, which was the occasional residence of his successors till about 1750, and of which the chapel and hall remain. Addington Park, 3½ m. from Croydon, was purchased for the residence, in 1807, of the archbishop of Canterbury, but was sold in consequence of Archbishop Temple's decision to reside at the palace, Canterbury. The neighbouring church, which is Norman and Early English, contains several memorials of archbishops. Near the park a group of tumuli and a circular encampment are seen. Croydon is a suffragan bishopric in the diocese of Canterbury. The parish church of St John the Baptist appears to have been built in the 14th and 15th centuries, but to have contained remains of an older building. The church was restored or rebuilt in the 16th century, and again restored by Sir Gilbert Scott in 1857-1859. It was destroyed by fire, with the exception of the tower, on the 5th of January 1867, and was at once rebuilt by Scott on the old lines. In 1596 Archbishop Whitgift founded the hospital or almshouse which bears his name, and remains in its picturesque brick buildings surrounding two quadrangles. His grammar school was housed in new buildings in 1871, and is a flourishing day school. The principal public building of Croydon is that erected by the corporation for municipal business; it included court-rooms and the public library. At Addiscombe in the

neighbourhood was formerly a mansion dating from 1702, and acquired by the East India Company in 1809 for a Military College, which on the abolition of the Company became the Royal Military College for the East Indian Army, and was closed in 1862. Croydon was formed into a municipal borough in 1883, a parliamentary borough, returning one member, in 1885, and a county borough in 1888. The corporation consists of a mayor, 12 aldermen and 36 councillors. Area, 9012 acres.

**CROZAT, PIERRE** (1661-1740), French art collector, was born at Toulouse, one of a family who were prominent French financiers and collectors. He became treasurer to the king in Paris, and gradually acquired a magnificent collection of pictures and *objets d'art*. Between 1729 and 1742 a finely illustrated work was published in two volumes, known as the *Cabinet Crozat*, including the finest pictures in French collections. Most of his own treasures descended to his nephews, Louis François (d. 1750), Joseph Antoine (d. 1750), and Louis Antoine (d. 1770), and were augmented by them, being dispersed after their deaths; the collection of Louis Antoine Crozat went to St Petersburg.

**CROZET ISLANDS**, an uninhabited group in the Indian Ocean, in 46°-47° S. and 51° E. They are mountainous, with summits from 4000 to 5000 ft. high, and are disposed in two divisions—Penguin or Inaccessible, Hog, Possession and East Islands; and the Twelve Apostles. Like Kerguelen, and other clusters in these southern waters, they appear to be of igneous formation; but owing to the bleak climate and their inaccessible character they are seldom visited, and have never been explored since their discovery in 1772 by Marion-Dufresne, after one of whose officers they are named. Possession, the highest, has a snowy peak said to exceed 5000 ft. Hog Island takes its name from the animals which were here let loose by an English captain many years ago, but have since disappeared. Rabbits burrow in the heaps of scoria on the slopes of the mountains.

**CROZIER, WILLIAM** (1855- ), American artilleryist and inventor, born at Carrollton, Carroll county, Ohio, on the 19th of February 1855, was the son of Robert Crozier (1827-1895), chief justice of Kansas in 1863-1866, and a United States senator from that state from December 1873 to February 1874. He graduated at West Point in 1876, was appointed a 2nd lieutenant in the 4th Artillery, and served on the Western frontier for three years against the Sioux and Bannock Indians. From 1879 to 1884 he was instructor in mathematics at West Point, and was superintendent of the Watertown (Massachusetts) Arsenal from 1884 to 1887. In 1888 he was sent by the war department to study recent developments in artillery in Europe, and upon his return he was placed in full charge of the construction of gun carriages for the army, and with General Adelbert R. Buffington (1837- ), the chief of ordnance, he invented the Buffington-Crozier disappearing gun carriage (1896). He also invented a wire-wound gun, and perfected many appliances connected with heavy and field ordnance. In 1890 he attained the rank of captain. During the Spanish-American War he was inspector-general for the Atlantic and Gulf coast defences. In 1899 he was one of the American delegates to the Peace Conference at the Hague. He later served in the Philippine Islands on the staffs of Generals John C. Bates and Theodore Schwan, and in 1900 was chief of ordnance on the staff of General A. R. Chaffee during the Pekin Relief Expedition. In November 1901 he was appointed brigadier-general and succeeded General Buffington as chief of ordnance of the United States army. His *Notes on the Construction of Ordnance*, published by the war department, are used as text-books in the schools for officers, and he is also the author of other important publications on military subjects.

**CROZIER**, or pastoral staff, one of the insignia of a bishop, and probably derived from the *lituus* of the Roman augurs. It is crook-headed, and borne by bishops and archbishops alike (see PASTORAL STAFF). The word "crozier" or "crosier" represents the O. Fr. *crocier*, Med. Lat. *crociarius*, the bearer of the episcopal crook (Med. Lat. *crocea*, *croccia*, &c., Fr. *croc*). The English representative of *crocea* was *crose*, later *crosse*, which, becoming confused with "cross" (*q.v.*), was replaced by "crozier-



staff" or "crozier's staff," and then, at the beginning of the 16th century, by "crozier" (see J. T. Taylor, *Archaeologia*, lii., "On the Use of the Terms Crozier, Pastoral Staff and Cross").

**CRUCIAL** (from Lat. *crux*, a cross), that which has the form of a cross, as the "crucial ligaments" of the knee-joint, which cross each other, connecting the femur and the tibia. From Francis Bacon's expression *instantia crucis* (taken, as he says, from the finger-post or *crux* at cross-roads) for a phenomenon which decides between two causes which have each similar analogies in its favour, comes the use of "crucial" for that which decides between two alternatives, hence, generally, as a synonym for "critical." The word is also used, with a reference to the use of a "crucible," of something which tests and tries.

**CRUCIFERAE**, or Crucifer family, a natural order of flowering plants, which derives its name from the cruciform arrangement of the four petals of the flower. It is an order of herbaceous



FIG. 1.—Wallflower (*Cheiranthus Cheiri*), reduced. 1, Flower in vertical section. 2, Horizontal plan of arrangement of flower in *Barbarea*.

plants, many of which, such as wallflower, stock, mustard, cabbage, radish and others, are well-known garden or field-plants. Many of the plants are annuals; among these are some of the commonest weeds of cultivation, shepherd's purse (*Capsella Bursa-pastoris*), charlock (*Brassica Sinapis*), and such common

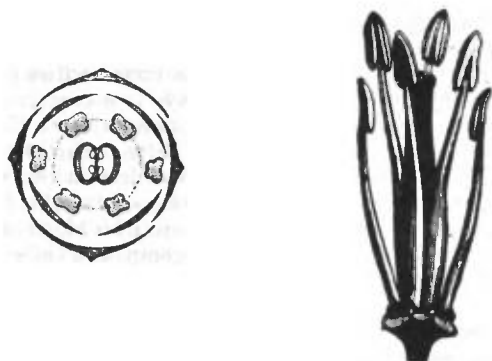

FIG. 2.—Cruciferae. Floral Diagram (*Brassica*).

FIG. 3.—*Cardamine pratensis*. Flower with Perianth removed. X4. (After Baillon.)

plants as hedge mustard (*Sisymbrium officinale*), Jack-by-the-hedge (*S. Alliaria* or *Alliaria officinalis*). Others are biennials producing a number of leaves on a very short stem in the first year, and in the second sending up a flowering shoot at the expense of the nourishment stored in the thick tap-root during

the previous season. Under cultivation this root becomes much enlarged, as in turnip, swede and others. Wallflower (*Cheiranthus Cheiri*) (fig. 1) is a perennial. The leaves when borne on an elongated stem are arranged alternately and have no stipules. The flowers are arranged in racemes without bracts; during the life of the flower its stalk continues to grow so that the open flowers of an inflorescence stand on a level (that is, are corymbose). The flowers are regular, with four free sepals arranged in two pairs at right angles, four petals arranged cross-wise in one series, and two sets of stamens, an outer with two members and an inner with four, in two pairs placed in the middle line of the flower and at right angles to the outer series. The four inner stamens are longer than the two outer; and the stamens are hence collectively described as tetradynamous. The pistil, which is above the rest of the members of the flower, consists of two carpels joined at their edges to form the ovary, which becomes two-celled by subsequent ingrowth of a septum from these united edges; a row of ovules springs from each edge. The fruit is a pod or siliqua splitting by two valves from

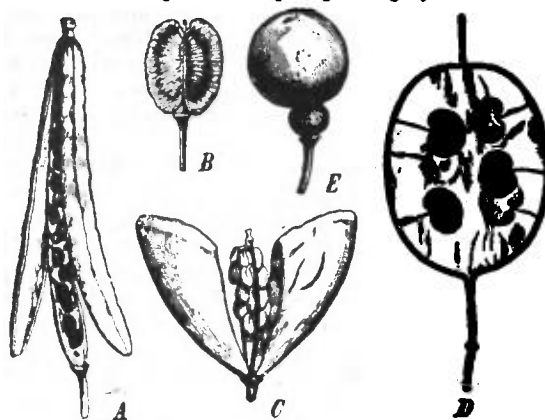

FIG. 4.—Cruciferous Fruits. (After Baillon.)

A, *Cheiranthus Cheiri*. B, *Lepidium sativum*. C, *Capsella Bursa-pastoris*. D, *Lunaria biennis*, showing the septum after the carpels have fallen away. E, *Crambe maritima*.

below upwards and leaving the placentas with the seeds attached to the *replum* or framework of the septum. The seeds are filled with the large embryo, the two cotyledons of which are variously folded. In germination the cotyledons come above ground and form the first green leaves of the plant.

Pollination is effected by aid of insects. The petals are generally white or yellow, more rarely lilac or some other colour, and between the bases of the stamens are honey-glands. Some or all of the anthers become twisted so that insects in probing for honey will touch the anthers with one side of their head and the capitate stigma with the other. Owing, however, to the close proximity of stigma and anthers, very slight irregularity in the movements of the visiting insect will cause self-pollination, which may also occur by the dropping of pollen from the anthers of the larger stamens on to the stigma.

Cruciferae is a large order containing nearly 200 genera and about 1200 species. It has a world-wide distribution, but finds its chief development in the temperate and frigid zones, especially of the northern hemisphere, and as Alpine plants. In the subdivision of the order into tribes use is made of differences in the form of the fruit and the manner of folding of the embryo. When the fruit is several times longer than broad it is known as a siliqua, as in stock or wallflower; when about as long as broad, a silicula, as in shepherd's purse.

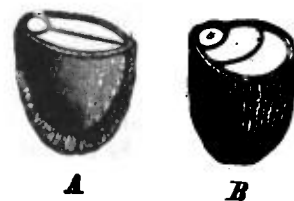

FIG. 5.—Seeds of *Cruciferae* cut across to show the radicle and cotyledons. (After Baillon.)

A, *Cheiranthus Cheiri* (X8). B, *Sisymbrium Alliaria* (X7).

Figures 2-5 are from Strasburger's *Lehrbuch der Botanik*, by permission of Gustav Fischer.

The order is well represented in Britain—among others by *Nasturtium* (*N. officinale*, water-cress), *Arabis* (rock-cress), *Cardamine* (bitter-cress), *Sisymbrium* (hedge mustard, &c.;



FIG. 6.—Honesty (*Lunaria biennis*), showing Flower and Fruit. Reduced. *Lepidium sativum* (garden cress). *Isatis* affords a blue

dye, woad. Many of the genera are known as ornamental garden plants; such are *Cheiranthus* (wallflower), *Matthiola* (stock), *Iberis* (candy-tuft), *Alyssum* (Alison), *Hesperis* (dame's violet), *Lunaria* (honesty) (fig. 6), *Aubrietia* and others.

**CRUDEN, ALEXANDER** (1701–1770), author of the well-known concordance (*q.v.*) to the English Bible, was born at Aberdeen on the 31st of May 1701. He was educated at the grammar school, Aberdeen, and studied at Marischal College, intending to enter the ministry. He took the degree of master of arts, but soon after began to show signs of insanity owing to a disappointment in love. After a term of confinement he recovered and removed to London. In 1722 he had an engagement as private tutor to the son of a country squire living at Eton Hall, Southgate, and also held a similar post at Ware. Years afterwards, in an application for the title of bookseller to the queen, he stated that he had been for some years corrector for the press in Wild Court. This probably refers to this time. In 1729 he was employed by the 10th earl of Derby as a reader and secretary, but was discharged on the 7th of July for his ignorance of French pronunciation. He then lodged in a house in Soho frequented exclusively by Frenchmen, and took lessons in the language in the hope of getting back his post with the earl, but when he went to Knowsley in Lancashire, the earl would not see him. He returned to London and opened a bookseller's shop in the Royal Exchange. In April 1735 he obtained the title of bookseller to the queen by recommendation of the lord mayor and most of the Whig aldermen. The post was an unremunerative sinecure. In 1737 he finished his concordance, which, he says, was the work of several years. It was presented to the queen on the 3rd of November 1737, a fortnight before her death.

Although Cruden's biblical labours have made his name a household word among English-speaking people, he was disappointed in his hopes of immediate profit, and his mind again became unhinged. In spite of his earnest and self-denying piety, and his exceptional intellectual powers, he developed idiosyncrasies, and his life was marred by a harmless but ridiculous egotism, which so nearly bordered on insanity that his friends sometimes thought it necessary to have him confined. He paid unwelcome addresses to a widow, and was confined in a madhouse in Bethnal Green. On his release he published a pamphlet dedicated to Lord H. (probably Harrington, secretary of state) entitled *The London Citizen exceedingly injured, or a British Inquisition Displayed*. He also published an account of

his trial, dedicated to the king. In December 1740 he writes to Sir H. Sloane saying he has been employed since July as Latin usher in a boarding-school at Enfield. He then found work as a proof-reader, and several editions of Greek and Latin classics are said to have owed their accuracy to his care. He superintended the printing of one of Matthew Henry's commentaries, and in 1750 printed a small *Compendium of the Holy Bible* (an abstract of the contents of each chapter), and also reprinted a larger edition of the *Concordance*.

About this time he adopted the title of "Alexander the Corrector," and assumed the office of correcting the morals of the nation, especially with regard to swearing and Sunday observance. For this office he believed himself divinely commissioned, but he petitioned parliament for a formal appointment in this capacity. In April 1755 he printed a letter to the speaker and other members of the House of Commons, and about the same time an "Address to the King and Parliament." He was in the habit of carrying a sponge, with which he effaced all inscriptions which he thought contrary to good morals. In September 1753, through being involved in a street brawl, he was confined in an asylum in Chelsea for seventeen days at the instance of his sister, Mrs Wild. He brought an unsuccessful action against his friends, and seriously proposed that they should go into confinement as an atonement. He published an account of this second restraint in "The Adventures of Alexander the Corrector." He made attempts to present to the king in person an account of his trial, and to obtain the honour of knighthood, one of his predicted honours. In 1754 he was nominated as parliamentary candidate for the city of London, but did not go to the poll. In 1755 he paid unwelcome addresses to the daughter of Sir Thomas Abney, of Newington (1640–1722), and then published his letters and the history of his repulse in the third part of his "Adventures." In June and July 1755 he visited Oxford and Cambridge. He was treated with the respect due to his learning by officials and residents in both universities, but experienced some boisterous fooling at the hands of the undergraduates. At Cambridge he was knighted with mock ceremonies. There he appointed "deputy correctors" to represent him in the university. He also visited Eton, Windsor, Tonbridge and Westminster schools, where he appointed four boys to be his deputies. (An *Admonition to Cambridge* is preserved among letters from J. Neville of Emmanuel to Dr Cox Macro, in the British Museum.) *The Corrector's Earnest Address to the Inhabitants of Great Britain*, published in 1756, was occasioned by the earthquake at Lisbon. In 1762 he saved an ignorant seaman, Richard Potter, from the gallows, and in 1763 published a pamphlet recording the history of the case. Against John Wilkes, whom he hated, he wrote a small pamphlet, and used to delete with his sponge the number 45 wherever he found it, this being the offensive number of the *North Briton*. In 1769 he lectured in Aberdeen as "Corrector," and distributed copies of the fourth commandment and various religious tracts. The wit that made his eccentricities palatable is illustrated by the story of how he gave to a conceited young minister whose appearance displeased him *A Mother's Catechism dedicated to the young and ignorant*. The *Scripture Dictionary*, compiled about this time, was printed in Aberdeen in two volumes shortly after his death. Alexander Chalmers, who in his boyhood heard Cruden lecture in Aberdeen and wrote his biography, says that a verbal index to Milton, which accompanied the edition of Thomas Newton, bishop of Bristol, in 1769, was Cruden's.

The second edition of the Bible *Concordance* was published in 1761, and presented to the king in person on the 21st of December. The third appeared in 1769. Both contain a pleasing portrait of the author. He is said to have gained £800 by these two editions. He returned to London from Aberdeen, and died suddenly while praying in his lodgings in Camden Passage, Islington, on the 1st of November 1770. He was buried in the ground of a Protestant dissenting congregation in Dead Man's Place, Southwark. He bequeathed a portion of his savings for a £5 bursary at Aberdeen, which preserves his name on the list of benefactors of the university. (D. M.N.)

**CRUDEN**, a village and parish on the E. coast of Aberdeenshire, Scotland. Pop. of parish (1901) 3444. It is situated at the head of Cruden Bay, 29½ m. N.N.E. of Aberdeen by the Great North of Scotland railway company's branch line from Ellon to Boddam. The golf-course of 18 holes is one of the best in Scotland, and there is a sandy beach, with good bathing. There is some good fishing at Port Erroll, also called Ward of Cruden. Prehistoric remains have been found in the parish, and near Ardendraught, not far from the shore, Malcolm II. is said to have defeated Canute in 1014. The Water of Cruden, which rises a few miles to the west, flows through the village into the North Sea. Slains Castle, a seat of the earl of Erroll, lies to the north of Cruden, but must not be confounded with the old castle of Slains, about 5 m. to the south-west, near the point where, according to tradition, the "St Catherine" of the Spanish Armada foundered in 1588. The Bulters of Buchan are within 2 m. walk of Cruden.

**CRUELTY** (through the O. Fr. *cruauté*, mod. *cruauté*, from the Lat. *crudelitas*), the intentional infliction of pain or suffering. It is only necessary to deal here with the legal relations involved. Statutory provision for the prevention of cruelty to those who are unable to protect themselves has been particularly marked in the 19th century. The increase of legislation for the protection of children, lunatics and animals is a proof of the growing humanitarianism of the age. There was at one time a tendency among jurists to question whether, for instance, the prevention of cruelty to animals was not a recognition of a certain quasi-right in animals, or whether it was merely that such exhibitions as bull- and bear-baiting, cock-fights, &c., were demoralizing to the public generally. The true fact seems to be that the first introduction of such legislation was undoubtedly due to the desire for the promotion of humanity, but that the principle, for the recognition of which the time was not yet ripe, had to be excused in the eyes of the public by the plea that cruelty had a demoralizing effect upon spectators (see A. V. Dicey, *Law and Opinion in England*, p. 188; T. E. Holland, *Jurisprudence*, 10th ed., p. 372).

*Cruelty to Animals.*—The English common law has never taken cognizance of the commission of acts of cruelty upon animals, and direct legislation upon the subject, dating from the 19th century, was due in a great measure to public agitation, supported by the Royal Society for the Prevention of Cruelty to Animals (founded in 1824). Various acts were passed in 1822 (known as Martin's Act), 1835 and 1837, and these were amended and consolidated by the Cruelty to Animals Acts 1849 and 1854, which, with the Wild Animals in Captivity Protection Act 1900, are the main acts upon the subject. There are also, in addition, many other acts that impose certain liabilities in respect of animals and indirectly prevent cruelty. The Cruelty to Animals Acts 1849 and 1854 render liable to prosecution and fine practically any act of cruelty to an animal; such acts as dubbing a cock, cropping the ears of a dog or dishorning cattle, are offences. The latter practice, however, is allowed both in Scotland and Ireland, the courts having held that the advantages to be obtained from dishorning outweigh the pain caused by the operation. The word "animal" is defined as meaning "any domestic animal" of whatever kind or species, and whether a quadruped or not. The act of 1849 also forbids bull- and bear-baiting, or fighting between any kinds of animals; requires the provision of food and water to animals impounded; lays down regulations as to the treatment of animals sent for slaughter, and imposes a penalty for improperly conveying animals. The Wild Animals in Captivity Protection Act 1900 extends to wild animals in captivity that protection which the acts of 1849 and 1854 conferred on domestic animals, making exception of any act done or any omission in the preparation of animals for the food of man or for sport. The word "animal" in the act includes bird, beast, fish or reptile. The Dogs Act 1865 rendered owners of dogs liable for injuries to cattle and sheep; the Dogs Act 1906 extended the owner's liability for injury done to any cattle by a dog, and further, where a dog is proved to have injured cattle or chased sheep it may be treated

as a dangerous dog and must be kept under proper control or be destroyed. The Drugging of Animals Act 1876 imposes a penalty on giving poisonous drugs to any domestic animal unlawfully. The Cruelty to Animals Act 1876 was passed for the purpose of regulating the practice of vivisection (*q.v.*). The Ground Game Act 1880, prohibits night shooting, or the use of spring traps above ground or poison. The Injured Animals Act 1907 enables police constables to cause any animal when mortally or seriously injured to be slaughtered. The Diseases of Animals Act 1894 and orders under it are for the purpose of securing animals from unnecessary suffering, as well as from disease. Finally, the Wild Birds Protection Acts 1880 to 1904, with various game acts (see *GAME LAWS*), extend the protection of the law to wild birds. The acts establish a close time for wild birds and impose penalties for shooting or taking them within that time; prohibit the exposing or offering for sale within certain dates any wild bird recently killed or taken unless bought or received from some person residing out of the United Kingdom; the taking or destroying of wild birds' eggs, the setting of pole traps, and the taking of a wild bird by means of a hook or other similar instrument.

For the law relating to the prevention of cruelty to children see *CHILDREN, LAW RELATING TO*; for cruelty in the sense of such conduct as entitles a husband or wife to judicial separation see *DIVORCE*. (T. A. I.)

**CRUIKSHANK, GEORGE** (1792–1878), English artist, caricaturist and illustrator, was born in London on the 27th of September 1792. By natural disposition and collateral circumstances he may be accepted as the type of the born humorist artist predestined for this special form of art. His grandfather had taken up the arts, and his father, Isaac Cruikshank, followed the painter's profession. Amidst these surroundings the children were born and brought up, their first playthings the materials of the arts their father practised. George followed the family traditions with amazing facility, easily surpassing his compeers as an etcher. When the father died, about 1811, George, still in his teens, was already a successful and popular artist. All his acquisitions were native gifts, and of home-growth; outside training, or the serious apprenticeship to art, were dispensed with, under the necessity of working for immediate profit. This lack of academic training the artist at times found cause to regret, and at some intervals he made exertions to cultivate the knowledge obtainable by studying from the antique and drawing from life at the schools. From boyhood he was accustomed to turn his artistic talents to ready account, disposing of designs and etchings to the printsellers, and helping his father in forwarding his plates. Before he was twenty his spirited style and talent had secured popular recognition; the contemporary of Gillray, Rowlandson, Alken, Heath, Dighton, and the established caricaturists of that generation, he developed great proficiency as an etcher. Gillray's matured and trained skill had some influence upon his executive powers, and when the older caricaturist passed away in 1815, George Cruikshank had already taken his place as a satirist. Prolific and dexterous beyond his competitors, for a generation he delineated Tories, Whigs and Radicals with fine impartiality. Satirical capital came to him from every public event,—wars abroad, the enemies of England (for he was always fervidly patriotic), the camp, the court, the senate, the Church; low life, high life; the humours of the people, the follies of the great. In this wonderful gallery the student may grasp the popular side of most questions which for the time being engaged public attention. George Cruikshank's technical and manipulative skill as an etcher was such that Ruskin and the best judges have placed his productions in the foremost rank; in this respect his works have been compared favourably with the masterpieces of etching. He died at 263 Hampstead Road on the 1st of February 1878. His remains rest in St Paul's cathedral.

A vast number of Cruikshank's spirited cartoons were published as separate caricatures, all coloured by hand; others formed series, or were contributed to satirical magazines, the *Satirist*, *Town Talk*, *The Scourge* (1811–1816) and the like

ephemeral publications. In conjunction with William Hone's scathing tracts, G. Cruikshank produced political satires to illustrate the series of facetiae and miscellanies, like *The Political House that Jack Built* (1819).

Of a more genially humoristic order are his well-known book illustrations, now so deservedly esteemed for their inimitable fun and frolic, among other qualities, such as the weird and terrible, in which he excelled. Early in this series came *The Humorist* (1819-1821) and *Life in Paris* (1822). The well-known series of *Life in London*, conjointly produced by the brothers I. R. and G. Cruikshank, has enjoyed a prolonged reputation, and is still sought after by collectors. Grimm's *Collection of German Popular Stories* (1824-1826), in two series, with 22 inimitable etchings, are in themselves sufficient to account for G. Cruikshank's reputation. To the first fourteen volumes (1837-1843) of *Bentley's Miscellany* Cruikshank contributed 126 of his best plates, etched on steel, including the famous illustrations to *Oliver Twist*, *Jack Sheppard*, *Guy Fawkes* and *The Ingoldsby Legends*. For W. Harrison Ainsworth, Cruikshank illustrated *Rookwood* (1836) and *The Tower of London* (1840); the first six volumes of *Ainsworth's Magazine* (1842-1844) were illustrated by him with several of his finest suites of etchings. For C. Lever's *Arthur O'Leary* he supplied 10 full-page etchings (1844), and 20 spirited graphic etchings for Maxwell's lurid *History of the Irish Rebellion in 1798* (1845). Of his own speculations, mention must be made of *George Cruikshank's Omnibus* (1841) and *George Cruikshank's Table Book* (1845), as well as his *Comic Almanack* (1835-1853). *The Life of Sir John Falstaff* contained 20 full-page etchings (1857-1858). These are a few leading items amongst the thousands of illustrations emanating from that fertile imagination. As an enthusiastic teetotal advocate, G. Cruikshank produced a long series of pictures and illustrations, pictorial pamphlets and tracts; the best known of these are *The Bottle*, 8 plates (1847), with its sequel, *The Drunkard's Children*, 8 plates (1848), with the ambitious work, *The Worship of Bacchus*, published by subscription after the artist's oil painting, now in the National Gallery, London, to which it was presented by his numerous admirers.

See *Cruikshank's Water-Colours*, with introduction by Joseph Grego (London, 1903). (J. Go.)\*

**CRUNDEN, JOHN** (d. 1828), English architectural and mobiliary designer. Most of his early inspiration was drawn from Chippendale and his school, but he fell later under the influence of a bastard classicism. He produced a very large number of designs which were published in numerous volumes; among the most ambitious were ornamental centres for ceilings in which he introduced cupids with bows and arrows, Fame sounding her trumpet, and such like motives. Sport and natural history supplied him with many other themes, and one of his ceilings is a hunting scene representing a "kill." His principal works were *Designs for Ceilings; Convenient and Ornamental Architecture; The Carpenter's Companion for Chinese Railings, Gates, &c.* (1770); *The Joiner and Cabinet-maker's Darling, or Sixty Designs for Gothic, Chinese, Mosaic and Ornamental Frets* (1765); and *The Chimney Piece Maker's Daily Assistant* (1776). Much of his work was either absurd or valueless.

**CRUSADES**, the name given to the series of wars for delivering the Holy Land from the Mahomedans, so-called from the cross worn as a badge by the crusaders. By analogy the term "crusade" is also given to any campaign undertaken in the same spirit.

1. *The Meaning of the Crusades.*—The Crusades may be regarded partly as the *decumanus fluctus* in the surge of religious revival, which had begun in western Europe during the 10th, and had mounted high during the 11th century; partly as a chapter, and a most important chapter, in the history of the interaction of East and West. Contemporaries regarded them in the former of these two aspects, as "holy wars" and "pilgrims' progresses" towards Christ's Sepulchre; the reflective eye of history must perhaps regard them more exclusively from the latter point of view. Considered as holy wars the Crusades

must be interpreted by the ideas of an age which was dominated by the spirit of otherworldliness, and accordingly ruled by the clerical power which represented the other world. They are a *novum salutis genus*—a new path to Heaven, to tread which counted "for full and complete satisfaction" *pro omni poenitentia* and gave "forgiveness of sins" (*peccaminum remissio*); they are, again, the "foreign policy" of the papacy, directing its faithful subjects to the great war of Christianity against the infidel. As such a *novum salutis genus*, the Crusades connect themselves with the history of the penitentiary system; as the foreign policy of the Church they belong to that clerical purification and direction of feudal society and its instincts, which appears in the institution of "God's Truce" and in chivalry itself. The penitentiary system, according to which the priest enforced a code of moral law in the confessional by the sanction of penance—penance which must be performed as a condition of admission to the sacrament of the Eucharist—had been from early times a great instrument in the civilization of the raw Germanic races. Penance might consist in fasting; it might consist in flagellation; it might consist in pilgrimage. The penitentiary pilgrimage, which seems to have been practised as early as A.D. 700, was twice blessed; not only was it an act of atonement in itself, like fasting and flagellation; it also gained for the pilgrim the merit of having stood on holy ground. Under the influence of the Cluniac revival, which began in the 10th century, pilgrimages became increasingly frequent; and the goal of pilgrimage was often Jerusalem. Pilgrims who were travelling to Jerusalem joined themselves in companies for security, and marched under arms; the pilgrims of 1064, who were headed by the archbishop of Mainz, numbered some 7000 men. When the First Crusade finally came, what was it but a penitentiary pilgrimage under arms—with the one additional object of conquering the goal of pilgrimage? That the Pilgrims' Progress should thus have turned into a Holy War is a fact readily explicable, when we turn to consider the attempts made by the Church, during the 11th century, to purify, or at any rate to direct, the feudal instinct for private war (*Fehde*). Since the close of the 10th century diocesan councils in France had been busily acting as legislatures, and enacting "forms of peace" for the maintenance of God's Peace or Truce (*Pax Dei* or *Treuga Dei*). In each diocese there had arisen a judicature (*judices pacis*) to decide when the form had been broken; and an executive, or *communitas pacis*, had been formed to enforce the decisions of the judicature. But it was an easier thing to consecrate the fighting instinct than to curb it; and the institution of chivalry represents such a clerical consecration, for ideal ends and noble purposes, of the martial impulses which the Church had hitherto endeavoured to check. In the same way the Crusades themselves may be regarded as a stage in the clerical reformation of the fighting laymen. As chivalry directed the layman to defend what was right, so the preaching of the Crusades directed him to attack what was wrong—the possession by "infidels" of the Sepulchre of Christ. The Crusades are the offensive side of chivalry: chivalry is their parent—as it is also their child. The knight who joined the Crusades might thus still indulge the bellicose side of his genius—under the aegis and at the bidding of the Church; and in so doing he would also attain what the spiritual side of his nature ardently sought—a perfect salvation and remission of sins. He might butcher all day, till he waded ankle-deep in blood, and then at nightfall kneel, sobbing for very joy, at the altar of the Sepulchre—for was he not red from the winepress of the Lord? One can readily understand the popularity of the Crusades, when one reflects that they permitted men to get to the other world by fighting hard on earth, and allowed them to gain the fruits of asceticism by the ways of hedonism. Nor was the Church merely able, through the Crusades, to direct the martial instincts of

\*Fulcher of Chartres, i. i. For what follows, with regard to the Church's conversion of *guerra* into the Holy War, cf. especially the passage—"Procedant contra infideles ad pugnam jam incipi dignam . . . qui abusive *privatum certamen* contra fideles consuescebant distendere quondam."

a feudal society; it was also able to pursue the object of its own immediate policy, and to attempt the universal diffusion of Christianity, even at the edge of the sword, over the whole of the known world.

Thus was renewed, on a greater scale, that ancient feud of East and West, which has never died. For a thousand years, from the Hegira in 622 to the siege of Vienna in 1683, the peril of a Mahomedan conquest of Europe was almost continually present. From this point of view, the Crusades appear as a reaction of the West against the pressure of the East—a reaction which carried the West into the East, and founded a Latin and Christian kingdom on the shores of Asia. They protected Europe from the new revival of Mahomedanism under the Turks; they gave it a time of rest in which the Western civilization of the middle ages developed. But the relation of East and West during the Crusades was not merely hostile or negative. The Latin kingdom of Jerusalem was the meeting-place of two civilizations: on its soil the East learned from the West, and—perhaps still more—the West learned from the East. The culture developed in the West during the 13th century was not only permitted to develop by the protection of the Crusades, it grew upon materials which the Crusades enabled it to import from the East. Yet the debt of Europe to the Crusades in this last respect has perhaps been unduly emphasized. Sicily was still more the meeting-place of East and West than the kingdom of Jerusalem; and the Arabs of Spain gave more to the culture of Europe than the Arabs of Syria.

2. *Historical Causes of the Crusades.*—Within fifteen years of the Hegira Jerusalem fell before the arms of Omar (637), and it continued to remain in the hands of Mahomedan rulers till the end of the First Crusade. For centuries, however, a lively intercourse was maintained between the Latin Church in Jerusalem, which the clemency of the Arab conquerors tolerated, and the Christians of the West. Charlemagne in particular was closely connected with Jerusalem: the patriarch sent him the keys of the city and a standard in 800; and in 807 Harun al-Rashid recognized this symbolical cession, and acknowledged Charlemagne as protector of Jerusalem and owner of the church of the Sepulchre. Charlemagne founded a hospital and a library in the Holy City; and later legend, when it made him the first of crusaders and the conqueror of the Holy Land, was not without some basis of fact. The connexion lasted during the 9th century; kings like Alfred of England and Louis of Germany sent contributions to Jerusalem, while the Church of Jerusalem acquired estates in the West. During the 10th century this intercourse still continued; but in the 11th century interruptions began to come. The fanaticism of the caliph Hakim destroyed the church of the Sepulchre and ended the Frankish protectorate (1010); and the patronage of the Holy Places, a source of strife between the Greek and the Latin Churches as late as the beginning of the Crimean War, passed to the Byzantine empire in 1021. This latter change in itself made pilgrimages from the West increasingly difficult: the Byzantines, especially after the schism of 1054, did not seek to smooth the way of the pilgrim, and Victor II. had to complain to the empress Theodora of the exactions practised by her officials. But still worse for the Latins was the capture of Jerusalem by the Seljukian Turks in 1071. Without being intolerant, the Turks were a rougher and ruder race than the Arabs of Egypt whom they displaced; while the wars between the Fatimites of Egypt and the Abbasids of Bagdad, whose cause was represented by the Seljuks, made Syria (one of the natural battle-grounds of history) into a troubled and unquiet region. The native Christians suffered; the pilgrims of the West found their way made still more difficult, and that at a time when greater numbers than ever were thronging to the East. Western Christians could not but feel hampered and checked in their natural movement towards the fountain-head of their religion, and it was natural that they should ultimately endeavour to clear the way. In much the same way, at a later date and in a lesser sphere, the closing of the trade-routes by the advance of the Ottoman Turks led traders to endeavour to find new channels, and issued in the rounding of

the Cape of Good Hope and the discovery of America. Nor, indeed, must it be forgotten that the search for new and more direct connexions with the routes of Oriental trade is one of the motives underlying the Crusades themselves, and leading to what may be called the 13th-century discovery of Asia.

It was thus natural, for these reasons, that the conquest of the Holy Land should gradually become an object for the ambition of Western Christianity—an object which the papacy, eager to realize its dream of a universal Church subject to its sway, would naturally cherish and attempt to advance. Two causes combined to make this object still more natural and more definite. On the one hand, the reconquest of lost territories from the Mahomedans by Christian powers had been proceeding steadily for more than a hundred years before the First Crusade; on the other hand, the position of the Eastern empire after 1071 was a clear and definite summons to the Christian West, and proved, in the event, the immediate occasion of the holy war. As early as 970 the recovery of the territories lost to Mahomedanism in the East had been begun by emperors like Nicephoras Phocas and John Zimisces: they had pushed their conquests, if only for a time, as far as Antioch and Edessa, and the temporary occupation of Jerusalem is attributed to the East Roman arms. At the opposite end of the Mediterranean, in Spain, the Omayyad caliphate was verging to its fall: the long Spanish crusade against the Moor had begun; and in 1018 Roger de Toeni was already leading Normans into Catalonia to the aid of the native Spaniard. In the centre of the Mediterranean the fight between Christian and Mahomedan had been long, but was finally inclining in favour of the Christian. The Arabs had begun the conquest of Sicily from the East Roman empire in 827, and they had attacked the mainland of Italy as early as 840. The popes had put themselves at the head of Italian resistance: in 848 Leo IV. is already promising a sure and certain hope of salvation to those who die in defence of the cross; and by 916, with the capture of the Arab fortress on the Garigliano, Italy was safe. Then came the reconquest of the Mediterranean islands near Italy. The Pisans conquered Sardinia at the instigation of Benedict VIII. about 1016; and, in a thirty years' war which lasted from 1060 to 1090, the Normans, under a banner blessed by Pope Alexander II., wrested Sicily from the Arabs. The Norman conquest of Sicily may with justice be called a crusade before the Crusades; and it cannot but have given some impulse to that later attempt to wrest Syria from the Mahomedans, in which the virtual leader was Bohemund, a scion of the same house which had conquered Sicily. But while the Christians of the West were thus winning fresh ground from the Mahomedans, in the course of the 11th century, the East Roman empire had now to bear the brunt of a Mahomedan revival under the Seljuks—a revival which, while it crushed for a time the Greeks, only acted as a new incentive to the Latins to carry their arms to the East. The Seljukian Turks, first the mercenaries and then the masters of the caliph, had given new life to the decadent caliphate of Bagdad. Under the rule of their sultans, who assumed the rôle of mayors of the palace in Bagdad about the middle of the 11th century, they pushed westwards towards the caliphate of Egypt and the East Roman empire. While they wrested Jerusalem from the former (1071), in the same year they inflicted a crushing defeat on the Eastern emperor at Manzikert. The result of the defeat was the loss of almost the whole of Asia Minor; the dominions of the Turks extended to the sea of Marmora. An appeal for assistance, such as was often to be heard again in succeeding centuries, was sent by Michael VII. of Constantinople to Gregory VII. in 1073. Gregory listened to the appeal; he projected—not, indeed, as has often been said, a crusade,<sup>1</sup> but a great expedition, which should recover

<sup>1</sup> Tradition credits a pope still earlier than Gregory VII. with the idea of a crusade. Silvester II. is said to have preached a general expedition for the recovery of Jerusalem; and the same preaching is attributed to Sergius IV. in 1011. But the supposed letter of Silvester is a later forgery; and in 1000 the way of the Christian to Jerusalem was still free and open.



Asia Minor for the Eastern empire, in return for a union of the Eastern with the Western Church. In 1074 Gregory actually assembled a considerable army; but his disagreement with Robert Guiscard, followed by the outbreak of the war of investitures, hindered the realization of his plans, and the only result was a precedent and a suggestion for the events of 1095. The appeal of Michael VII. was re-echoed by Alexius Comnenus himself. Brave and sage as he was, he could hardly cope at one and the same time with the hostility of the Normans on the west, of the Petchenegs (Patzinaks) on the north, and of the Seljuks on the east and south. Already in 1087 and 1088 he had appealed to Baldwin of Flanders, verbally and by letter,<sup>1</sup> for troops; and Baldwin had answered the appeal. The same appeal was made, more than once, to Urban II.; and the answer was the First Crusade. The First Crusade was not, indeed, what Alexius had asked or expected to receive. He had appealed for reinforcements to recover Asia Minor; he received hundreds of thousands of troops, independent of him, and intending to conquer Jerusalem for themselves, though they might incidentally recover Asia Minor for the Eastern empire on their way. Alexius may almost be compared to a magician, who has uttered a charm to summon a ministering spirit, and is surrounded on the instant by legions of demons. In truth the appeal of Alexius had set free forces in the West which were independent of, and even ultimately hostile to, the interests of the Eastern empire.

The primary force, which thus transmuted an appeal for reinforcements into a holy war for the conquest of Palestine, was the Church. The creative thought of the middle ages is clerical thought. It is the Church which creates the Carolingian empire, because the clergy thinks in terms of empire. It is the Church which creates the First Crusade, because the clergy believes in penitentiary pilgrimages, and the war against the Seljuks can be turned into a pilgrimage to the Sepulchre; because, again, it wishes to direct the fighting instinct of the laity, and the consecrating name of Jerusalem provides an unimpeachable channel; above all, because the papacy desires a perfect and universal Church, and a perfect and universal Church must rule in the Holy Land. But it would be a mistake to regard the Crusades (as it would be a mistake to regard the Carolingian empire) as a *pure* creation of the Church, or as *merely* due to the policy of a theocracy directing men to the holy war which is the only war possible for a theocracy. It would be almost truer, though only half the truth, to say that the clergy gave the name of Crusade to sanctify interests and ambitions which, while set on other ends than those of the Church, happened to coincide in their choice of means. There was, for instance, the ambition of the adventurer prince, the younger son, eager to carve a principality in the far East, of whom Bohemund is the type; there was the interest of Italian towns, anxious to acquire the products of the East more directly and cheaply, by erecting their own emporia in the eastern Mediterranean. The former was the driving force which made the First Crusade successful, where later Crusades, without its stimulus, for the most part failed; the latter was the one staunch ally which alone enabled Baldwin I. and Baldwin II. to create the kingdom of Jerusalem. So far as the Crusades led to permanent material results in the East, they did so in virtue of these two forces. Unregulated enthusiasm might of itself have achieved little or nothing; enthusiasm caught and guided by the astute Norman, and the no less astute Venetian or Genoese, could not but achieve tangible results. The principality or the emporium, it is true, would supply motives to the prince and the merchant only; and it may be urged that to the mass of the crusaders the religious motive was all in all. In this way we may return to the view that the First Crusade, at any rate, was *un fait ecclésiastique*.

<sup>1</sup> The comte de Riant impugned the authenticity of Alexius' letter to the count of Flanders. It is very probable that the versions of this letter which we possess, and which are to be found only in later writings like Guibert de Nogent, are apocryphal; Alexius can hardly have held out the bait of the beauty of Greek women, or have written that he preferred to fall under the yoke of the Latins rather than that of the Turks. But it is also probable that these apocryphal versions are based on a genuine original.

It is indeed true that to thousands the hope of acquiring spiritual merit must have been a great motive; it is also true, as the records of crusading sermons show, that there was a strong element of "revivalism" in the Crusades, and that thousands were hurried into taking the cross by a gust of that uncontrollable enthusiasm which is excited by revivalist meetings to-day. But it must also be admitted that there were motives of this world to attract the masses to the Crusades. Famine and pestilence at home drove men to emigrate hopefully to the golden East. In 1094 there was pestilence from Flanders to Bohemia; in 1095 there was famine in Lorraine. *Francigenis occidentalibus facile persuaderi poterat sua rura relinquere; nam Gallias per annos aliquot nunc seditio civilis, nunc James, nunc mortalitas nimis affixerat.*<sup>2</sup> No wonder that a stream of emigration set towards the East, such as would in modern times flow towards a newly discovered gold-field—a stream carrying in its turbid waters much refuse, tramps and bankrupts, camp-followers and hucksters, fugitive monks and escaped villeins, and marked by the same motley grouping, the same fever of life, the same alternations of affluence and beggary, which mark the rush for a gold-field to-day.

Such were the forces set in movement by Urban II., when, after holding a synod at Piacenza (March, 1095), and receiving there fresh appeals from Alexius, he moved to Clermont, in the S.E. of France, and there on the 26th of November delivered the great speech which was followed by the First Crusade. In this speech he appealed, indeed, for help for the Greeks, *auxilio . . . saepe acclamato indigis* (Fulcher i. c. i.); but the gist of his speech was the need of Jerusalem. Let the truce of God be observed at home; and let the arms of Christians be directed to the winning of Jerusalem in an expedition which should count for full and complete penance. Like Gregory, Urban had thus sought for aid for the Eastern empire; unlike Gregory, who had only mentioned the Holy Sepulchre in a single letter, and then casually, he had struck the note of Jerusalem. The instant cries of *Deus vult* which answered the note showed that Urban had struck aright. Thousands at once took the cross; the first was Bishop Adhemar of Puy, whom Urban named his legate and made leader of the First Crusade (for the holy war, according to Urban's original conception, must needs be led by a clerk). Fixing the 15th of August 1096 as the time for the departure of the crusaders, and Constantinople as the general rendezvous, Urban returned from France to Italy. It is noticeable that it was on French soil that the seed had been sown.<sup>3</sup> Preached on French soil by a pope of French descent, the Crusades began—and they continued—as essentially a French (or perhaps better Norman-French) enterprise; and the kingdom which they established in the East was essentially a French kingdom, in its speech and its customs, its virtues and its vices. It was natural that France should be the home of the Crusades. She was already the home of the Cluniac movement, the centre from which radiated the truce of God, the chosen place of chivalry; she could supply a host of feudal nobles, somewhat loosely tied to their place in society, and ready to break loose for a great enterprise; she had suffered from battle and murder, pestilence and famine, from which any escape was welcome. To the Normans particularly the Crusades had an intimate appeal. They appealed to the old Norse instinct for wandering—an instinct which, as it had long before sent the Norseman eastward to find his El Dorado of Micklegarth, could now find a natural outlet in the expedition to Jerusalem: they appealed to the Norman religiosity, which had made them a people of pilgrims, the allies of the papacy, and, in England and Sicily, crusaders before the Crusades: finally, they appealed to that desire to gain fresh territory, upon which Malaterra remarks as characteristic of Norman princes.<sup>4</sup> No wonder, then, that

<sup>2</sup> Ekkehard, *Chronica*, p. 213.

<sup>3</sup> The *Chanson de Roland*, which cannot be posterior to the First Crusade—for the poem never alludes to it—already contains the idea of the Holy War against Islam. The idea of the crusade had thus already ripened in French poetry, before Urban preached his sermon.

<sup>4</sup> Book i. c. iii. (in Muratori, *S.R.I.*, v. 550).

the crusading armies were recruited in France, or that they were led by men of the stock of the d'Hautevilles. Meanwhile newly-conquered England had its own problems to solve; and Germany, torn by civil war, and not naturally quick to kindle, could only deride the "delirium" of the crusader.<sup>1</sup>

3. *Course of the First Crusade.*—The First Crusade falls naturally into two parts. One of these may be called the Crusade of the people: the other may be termed the Crusade of the princes. Of these the people's Crusade—prior in order of time, if only secondary in point of importance—may naturally be studied first. The sermon of Urban II. at Clermont became the staple for wandering preachers, among whom Peter the Hermit distinguished himself by his fiery zeal.<sup>2</sup> Riding on an ass from place to place through France and along the Rhine, he carried away by his eloquence thousands of the poor. Some three or four months before the term fixed by Urban II., in April and May 1096, five divisions of *pauperes* had already collected. Three of these, led by Fulcher of Orleans, Gottschalk and William the Carpenter respectively, failed to reach even Constantinople. The armies of Fulcher and Gottschalk were destroyed by the Hungarians in just revenge for their excesses (June); the third, after joining in a wild *Judenhetze* in the towns of the valley of the Rhine, during which some 10,000 Jews perished as the first-fruits of crusading zeal, was scattered to the winds in Hungary (August). Two other divisions, however, reached Constantinople in safety. The first of these, under Walter the Penniless, passed through Hungary in May, and reached Constantinople, where it halted to wait for the Hermit, in the middle of July. The second, led by Peter himself, passed safely through Hungary, but suffered severely in Bulgaria, and only attained Constantinople with sadly diminished numbers at the end of July. These two divisions (which in spite of good treatment by Alexius began to commit excesses against the Greeks) united and crossed the Bosphorus in August, Peter himself remaining in Constantinople. By the end of October they had perished utterly at the hands of the Seljuks; a heap of whitening bones also remained to testify to the later crusaders, when they passed in the spring of 1097, of the fate of the people's Crusade.

Meanwhile the knights had already begun to assemble in March 1096. In small bands, and by divers ways, they streamed gradually southward and eastward, in a steady flow, throughout 1096. But three large divisions, under three considerable leaders, were pre-eminent among the rest. Godfrey of Bouillon, with his brother Baldwin, led the crusaders of Lorraine along "the road of Charles the Great," through Hungary, to Constantinople, where he arrived on the 23rd of December. Raymund of Toulouse (the first prince to join the crusading movement) along with Bishop Adhemar, the papal commissary, led the Provençals down the coast of Illyria, and then due east to Constantinople, arriving towards the end of April 1097. Bohemund of Otranto, the destined leader of the Crusade, with his nephew Tancred, led a fine force of Normans by sea to Durazzo, and thence by land to Constantinople, which he reached about the same time as Raymund. To the same great rendezvous other leaders also gathered, some of higher rank than Godfrey or Raymund or Bohemund, but none destined to exercise an equal influence on the fate of the Crusade. Hugh of Vermandois, younger brother of Philip I. of France, had reached Constantinople in November 1096, in a species of honourable captivity, and had done Alexius homage; Robert of Normandy and Stephen of Blois, to whom Urban II. had given St Peter's banner at Lucca, only arrived—the last of the crusaders—in May 1097 (their original companion in arms, Count Robert of Flanders, having left them to winter at Bari, and crossed to Constantinople before the end of 1096).

Thus was gathered at Constantinople, in the spring of

<sup>1</sup> Ekkehard, *Chronica*, 214.

<sup>2</sup> Later legend ascribed the origin of the First Crusade to the preaching of Peter the Hermit. The legend has been followed by modern historians; but in point of fact Peter is a figure of secondary importance. (See PETER THE HERMIT.)

1097, a great host, which Fulcher computes at 600,000 men (I. c. iv.), Urban II. at 300,000, and which was probably some 150,000 strong.<sup>3</sup> Before we follow this host into Asia, we may pause to inquire into the various factors which would determine its course, or condition its activity. On the Western side, and among the crusaders themselves, there were two factors of importance, already mentioned above—the aims of the adventurer prince, and the interests of the Italian merchant; while on the Eastern side there are again two—the policy of the Greeks, and the condition of the Mahomedan East. We have already seen that among the princes who joined the First Crusade there were some who were rather *politiques* than *dévots*, and who aimed at the acquisition of temporal profit as well as of spiritual merit. Of these the type—and, it may almost be said, the inspirer of the rest—was Bohemund. From the first he had an Eastern principality in his mind's eye; and if we may judge from the follower of Bohemund who wrote the *Gesta Francorum*, there had already been some talk at Constantinople of Antioch as the seat of this principality. Bohemund's policy seems to have inspired Baldwin, the brother of Godfrey of Bouillon to emulation; on the one hand he strove to thwart the endeavours of Tancred, the nephew of Bohemund, to begin the foundation of the Eastern principality for his uncle by conquering Cilicia, and, on the other, he founded a principality for himself in Edessa. Raymond of Provence, the third and last of the great *politiques* of the First Crusade, was, like Baldwin, envious of Bohemund; and jealousy drove him first to attempt to wrest Antioch from Bohemund, and then to found a principality of Tripoli to the south of Antioch, which would check the growth of his power. The political motives of these three princes, and the interaction of their different policies, was thus a great factor in determining the course and the results of the First Crusade. The influence of the Italian towns did not make itself greatly felt till after the end of the First Crusade, when it made possible the foundation of a kingdom in Jerusalem, in addition to the three principalities established by Bohemund, Baldwin and Raymond; but during the course of the Crusade itself the Italian ships which hugged the shores of Syria were able to supply the crusaders with provisions and munition of war, and to render help in the sieges of Antioch and Jerusalem.<sup>4</sup> Sea-power had thus some influence in determining the victory of the crusaders.

In the East the conditions were, on the whole, favourable to the crusaders. The one difficulty—and it was serious—was the attitude adopted by Alexius. Confronted by crusaders where he had asked for auxiliaries, Alexius had two alternative policies presented to his choice. He might, in the first place, have frankly admitted that the crusaders were independent allies, and treating them as equals, he might have waged war in concert with them, and divided the conquests achieved in the war. A boundary line might have been drawn somewhere to the N.W. of Antioch; and the crusaders might have been left to acquire what they could to the south and east of that line. Unhappily, clinging to the conviction that all the lands which the crusaders would traverse were the "lost provinces" of his empire, he induced the crusaders to do him homage, so that, whatever they conquered, they would conquer in his name, and whatever they held, they would hold by his grant and as his vassals. Thus Hugh of Vermandois became the man of Alexius in November 1096; Godfrey of Bouillon was induced, not without difficulty, to do homage in January 1097; and in April and May the other leaders, including Bohemund and the obstinate Raymond himself, followed his example. The policy of Alexius was destined to produce evil results, both for the Eastern empire and for the crusading movement. The West had already its grievances against the East: the Greek emperors had taken advantage of their protectorate of the Holy Places to lay charges

<sup>3</sup> Godfrey's army numbered some 30,000 infantry and 10,000 cavalry (Röhricht, *Erst. Kreuzz.* 61); Urban II. reckons Bohemund's knights as 7000 in number (*ibid.* 71, n. 7).

<sup>4</sup> The Genoese had been invited by Urban II. in September 1096 "to go with their galleys to Eastern parts in order to set free the path to the Lord's Sepulchre."

on the pilgrims, against which the Papacy had already been forced to remonstrate; nor were the Italian towns, with the exception of favoured Venice, disposed to be friendly to the great monopolist city of Constantinople. The old dissension of the Eastern and Western Churches had blazed out afresh in 1054; and the policy of Alexius only added new rancours to an old grudge, which culminated in the Latin conquest of Constantinople in 1204. On the other hand, the success of the crusading movement was imperilled, both now and afterwards, by the jealousy of the Comneni. Always hostile to the principality, which Bohemund established in spite of his oath, they helped by their hostility to cause the loss of Edessa in 1144, and thus to hasten the disintegration of the Latin kingdom of Jerusalem. Yet one must remember, in justice to Alexius, the gravity of the problem by which he was confronted; nor was the conduct of the crusaders themselves such that he could readily make them his brethren in arms.

The condition of Asia Minor and Syria in 1097 was almost altogether such as to favour the success of the crusaders. The Seljukian sultans had only achieved a military occupation of the country which they had conquered. There were Seljukian garrisons in towns like Nicaea and Antioch, ready to offer an obstinate resistance to the crusaders; and here and there in the country there were Seljukian armies, either cantoned or nomadic. But the inhabitants of the towns were often hostile to the garrisons, and over wide tracts of country there were no forces at all. Accordingly, when the crusaders had captured the town at Nicaea, and defeated the Seljukian field-army at Dorylaeum their way lay clear before them through Asia Minor. Not only so, but they could count, at the very least, on a benevolent neutrality from the native population; while from the Armenian principalities in the S.E. of Asia Minor, which survived unsubdued in the general deluge of Seljukian conquest, they could expect active assistance (the hope of which will explain the north-easterly line of march which they followed after leaving Heraclea). But the purely military character of the Seljukian occupation helped the crusaders in yet another way. Strong generals were needed in the separate divisions of the empire, and these, as has always been the case in Eastern empires, made themselves independent in their spheres of command, because there was no organization to keep them together under a single control. On the death of Malik Shah, the last of the great Seljukian emperors (1092), the empire dissolved. A new sultan, Barkiyāroq or Barkiarok, ruled in Bagdad (1094-1104); but in Asia Minor Kilij Arslan held sway as the independent sultan of Konia (Iconium), while the whole of Syria was also practically independent. Not only was Syria thus weakened by being detached from the body of the Seljukian empire; it was divided by dissensions within, and assailed by the Fatimite caliph of Egypt from without. In 1095 two brothers, Ridwan and Dekak, ruled in Aleppo and Damascus respectively; but they were at war with one another, and Yagi-sian, the ruler of Antioch, was a party to their dissensions. Ridwan and Yagi-sian were only stopped in an attack on Damascus by news of the approach of the crusaders, which led the latter to throw himself hastily into Antioch, in the autumn of 1097. Meanwhile the Fatimites were not slow to take advantage of these dissensions. A great religious difference divided the Fatimite caliph of Cairo, the head of the Shiite sect, from the Abbasid caliph of Bagdad, who was the head of the Sunnites. The difference may be compared to the dissension between the Greek and the Latin Churches; but it had perhaps more of the nature of a political difference. In any case, it hampered the Mahommedans as much as the jealousy between Alexius and the Latins hampered the progress of the Crusade. The crusading princes were well enough aware of the gulf which divided the caliph of Cairo from the Sunnite princes of Syria; and they sought by envoys to put themselves into connexion with him, hoping by his aid to gain Jerusalem (which was then ruled for the Turks by Sokman, the son of the amir Ortok).<sup>1</sup> But the caliph preferred to act for

himself, and took advantage of the wars of the Syrian princes, and of the terror inspired by the advance of the crusaders to conquer Jerusalem (August 1098). But though the leaders of the First Crusade did not succeed in utilizing the dissensions of the Mahommedans as fully as they desired, it still remains true that these dissensions very largely explain their success. It was the disunion of the Syrian amirs, and the division between the Abbasids and the Fatimites, that made possible the conquest of the Holy City and the foundation of the kingdom of Jerusalem. When a power arose in Mosul, about 1130, which was able to unify Syria—when, again, in the hands of Saladin, unified Syria was in turn united to Egypt—the cause of Latin Christianity in the East was doomed.

We are now in a position to follow the history of the First Crusade. By the beginning of May 1097 the crusaders were crossing the Bosphorus, and entering the dominions of Kilij Arslan. Their first operation was the siege of Nicaea, defended by a Seljuk garrison, but eventually captured, with the aid of Alexius, after a month's siege (June 18). Alexius took possession of the town; and though he rewarded the crusading princes richly, some discontent was excited by his action. After the capture of Nicaea, the field-army of Kilij Arslan had to be met. In a long and obstinate encounter, it was defeated at Dorylaeum (July 1); and the crusaders marched unmolested in a south-easterly direction to Heraclea. Here Tancred, followed by Baldwin, turned into Cilicia, and began to take possession of the Cilician towns, and especially of Tarsus—thus beginning, it would seem, the creation of the Norman principality of Antioch. The main army turned to the N.E., in the direction of Caesarea (in order to bring itself into touch with the Armenian princes of this district), and then marched southward again to Antioch. At Marash, half way between Caesarea and Antioch, Baldwin, who had meanwhile wrested Tarsus from Tancred, rejoined the ranks; but he soon left the main body again, and struck eastward towards Edessa, to found a principality there. At the end of October the crusaders came into position before Antioch, which was held by Yagi-sian, and began the siege of the city, which lasted from October 21, 1097, to June 3, 1098. The great figure in the siege was naturally Bohemund (who had also been the hero of Dorylaeum). He repelled attempts at relief made by Dekak (Dec. 31, 1097) and Ridwan (Feb. 9, 1098); he put the besiegers in touch with the Genoese ships lying in the harbour of St Simeon, the port of Antioch (March 1098)—a move which at once served to remedy the want of provisions from which the crusaders suffered, and secured materials for the building of castles, with which Bohemund sought—in the Norman fashion—to overawe the besieged city. But it was finally by the treachery of one of Yagi-sian's commanders, the amir Firuz, that Bohemund was able to effect its capture. The other leaders had, however, to promise him possession of the city, before he would bring his negotiations with Firuz to a conclusion; and the matter was so long protracted that an army of relief under Kerbogha of Mosul was only at a distance of three days' march, when the city was taken (June 3, 1098). The besiegers were no sooner in the city, than they were besieged in their turn by Kerbogha; and the twenty-five days which followed were the worst period of stress and strain which the crusaders had to encounter. Under the pressure of this strain "spiritualistic" phenomena began to appear. It was in the ranks of the Provençals, where the religiosity of Count Raymond seems to have extended to his followers, that these phenomena appeared; and they culminated in the discovery of the Holy Lance, which had pierced the side of the Saviour. The excitement communicated itself to the whole army; and the nervous strength which it gave enabled the crusaders to meet and defeat Crusade, and above all on the Sixth, this path was still more seriously attempted. It is interesting, too, to notice the part which the laity already plays in directing the course of the Crusade. From the first the Crusade, however clerical in its conception, was largely secular in its conduct; and thus, somewhat paradoxically, a religious enterprise aided the growth of the secular motive, and contributed to the escape of the laity from that tendency towards a papal theocracy, which was evident in the pontificate of Gregory VII.

<sup>1</sup> Thus already on the First Crusade the path of negotiation is attempted simultaneously with the Holy War. On the Third

Kerbogha in the open (June 28), but not before many of their number, including even Count Stephen of Blois, had deserted and fled.

With the discovery of the Lance, which became as it were a Provençal asset, Count Raymund assumes a new importance. Mingled with the religiosity of his nature there was much obstinacy and self-seeking; and when Kerbogha was finally repelled, he began to dispute the possession of Antioch with Bohemund, pleading in excuse his oath to Alexius. The struggle lasted for some months, and helped to delay the further progress of the crusaders. Raymund, indeed, left Antioch in November, and moved S.E. to Marra; but his men still held two positions in Antioch, from which they were not dislodged by Bohemund till January 1099. Expelled from Antioch, the obstinate Raymund endeavoured to recompense himself in the south (where indeed he subsequently created the county of Tripoli); and from February to May 1099 he occupied himself with the siege of Arca, to the N.E. of Tripoli. It was during the siege of Arca that Peter Bartholomew, to whom the vision of the Holy Lance had first appeared, was subjected, with no definite result, to the ordeal of fire—the hard-headed Normans doubting the genuine character of any Provençal vision, the more when, as in this case, it turned to the political advantage of the Provençals. The siege was long protracted; the mass of the pilgrims were anxious to proceed to Jerusalem, and, as the altered tone of the author of the *Gesta* sufficiently indicates, thoroughly weary of the obstinate political bickerings of Raymund and Bohemund. Here Godfrey of Bouillon finally came to the front, and placing himself at the head of the discontented pilgrims, he forced Raymund to accept the offers of the amir of Tripoli, to desist from the siege, and to march to Jerusalem (in the middle of May 1099). Bohemund remained in Antioch: the other leaders pressed forward, and following the coast route, arrived before Jerusalem in the beginning of June. After a little more than a month's siege, the city was finally captured (July 15). The slaughter was terrible; the blood of the conquered ran down the streets, until men splashed in blood as they rode. At nightfall, "sobbing for excess of joy," the crusaders came to the Sepulchre from their treading of the winepress, and put their blood-stained hands together in prayer. So, on that day of July, the First Crusade came to an end.

It remained to determine the future government of Jerusalem; and here the eternal problem of the relations of Church and State emerged. It might seem natural that the Holy City, conquered in a holy war by an army of which the pope had made a churchman, Bishop Adhemar, the leader, should be left to the government of the Church. But Adhemar had died in August 1098 (whence, in large part, the confusion and bickerings which followed in the end of 1098 and the beginning of 1099); nor were there any churchmen left of sufficient dignity or weight to secure the triumph of the ecclesiastical cause. In the meeting of the crusaders on the 22nd of July, some few voices were raised in support of the view that a "spiritual vicar" should first be chosen in the place of the late patriarch of Jerusalem (who had just died in Cyprus), before the election of any lay ruler was taken in hand. But the voices were not heard; and the princes proceeded at once to elect a lay ruler. Raymund of Provence refused to accept their nomination, nominally on the pious ground that he did not wish to reign where Christ had suffered on the cross; though one may suspect that the establishment of a principality in Tripoli—in which he had been interrupted by the pressure of the pilgrims—was still the first object of his ambition. The refusal of Raymund meant the choice of Godfrey of Bouillon, who had, as we have seen, become prominent since the siege of Arca; and Godfrey accordingly became—not king, but "advocate of the Holy Sepulchre," while a few days afterwards Arnulf, the chaplain of Robert of Normandy, and one of the sceptics in the matter of the Holy Lance, became "vicar" of the vacant patriarchate. Godfrey's first business was to repel an Egyptian attack, which he accomplished successfully at Ascalon, with the aid of the other crusaders (August 12). At

the end of August the other crusaders returned,<sup>1</sup> and Godfrey was left with a small army of 2000 men, and the support of Tancred, now prince of Galilee, to rule in some four isolated districts—Jaffa, Jerusalem, Ramlah and Haifa. At the end of the year came Bohemund and Godfrey's brother Baldwin (now count of Edessa) on a pilgrimage to Jerusalem. The result of Bohemund's visit was new trouble for Godfrey. Bohemund procured the election of Dagobert, the archbishop of Pisa, to the vacant patriarchate, disliking Arnulf, and perhaps hoping to find in the new patriarch a political supporter. Bohemund and Godfrey together became Dagobert's vassals; and in the spring Godfrey even seems to have entered into an agreement with the patriarch to cede Jerusalem and Jaffa into his hands, in the event of acquiring other lands or towns, especially Cairo, or dying without direct heirs. When Godfrey died in July 1100 (after successful forays against the Mahomedans which took him as far as Damascus), it might seem as if a theocracy were after all to be established in Jerusalem, in spite of the events of 1099.

4. *The Latin Kingdom of Jerusalem under the First Three Kings*,<sup>2</sup> 1100-1143.—The theocracy, however, was not destined to be established. Godfrey had died without direct heirs; but in far Edessa there was his brother Baldwin, ready to take his place. Dagobert had at first consented to the dying Godfrey's wish that Baldwin should be his successor; but when Godfrey died he saw an opportunity too precious to be missed, and opposed Baldwin, counting on the support of Bohemund, to whom he sent an appeal for assistance.<sup>3</sup> But a party in Jerusalem, headed by the late "vicar" Arnulf, opposed itself to the hierarchical pretensions of Dagobert and the Norman influence by which they were backed; and this party, representing the Lotharingian laity, carried the day. Baldwin was summoned from Edessa; and when he arrived, towards the end of the year, he was crowned king by Dagobert himself. Thus was founded, on Christmas day 1100, the Latin kingdom of Jerusalem; and thus was the possibility of a theocracy finally annihilated. A feudal kingdom of Frankish seigneurs was to be planted on the soil of Palestine, instead of a *dominium temporale* of the patriarch like that of the pope in central Italy. Nor were any great difficulties with the Church to hamper the growth of this kingdom. For two years, indeed, a struggle raged between Baldwin I. and Dagobert: Baldwin accused the patriarch of treachery, and attempted to force him to contribute to the defence of the kingdom. But in 1102 the struggle ceased with the deposition of the patriarch and the victory of the king; and though it was renewed for a time by the patriarch Stephen in the reign of Baldwin II. (1128-1130), the new struggle was of short duration, and was soon ended by Stephen's death.

The establishment of a kingdom in Jerusalem in 1100 was a blow, not only to the Church but to the Normans of Antioch. At the end of 1099 any contemporary observer must have believed that the capital of Latin Christianity in the East was destined to be Antioch. Antioch lay in one of the most fertile regions of the East; Bohemund was almost, if not quite, the greatest genius of his generation; and when he visited Jerusalem at the end of 1099, he led an army of 25,000 men—and those men, at any rate in large part, Normans. What could Godfrey avail against such a force? Yet the principality of Godfrey was destined to higher things than that of Bohemund. Jerusalem, like Rome, had the shadow of a mighty name to lend prestige to its ruler; and as residence in Rome was one great reason of the strength of the medieval papacy, so was

<sup>1</sup> Before he left, Raymund had played in Jerusalem the same part of dog in the manger which he had also played at Antioch, and had given Godfrey considerable trouble. See the articles, GODFREY OF BOUILLON and RAYMUND OF TOULOUSE.

<sup>2</sup> For an account of the kings of Jerusalem see the articles on the five BALDWINs, on the two AMALRICs, on FULK and JOHN OF BRIENNE and on the LUSIGNAN (family).

<sup>3</sup> The genuineness of the letter (on which, by the way, depends the story of Godfrey's agreement with Dagobert) has been impeached by Prutz and Kugler, and doubted by Röhrich. It is accepted by von Sybel and Hagenmeyer.

residence in Jerusalem a reason for the ultimate supremacy of the Lotharingian kings. Jerusalem attracted the flow of pilgrims from the West as Antioch never could; and though the great majority of the pilgrims were only birds of passage, there were always many who stayed in the East. There was thus a steady immigration into the kingdom, to strengthen its armies and recruit with new blood the vigour of its inhabitants. Still more important perhaps was the fact that the ports of the kingdom attracted the Italian towns; and it was therefore to the kingdom that they lent the strength of their armies and the skill of their siege-artillery—in return, it is true, for concessions of privileges so considerable as to weaken the resources of the kingdom they helped to create. While Jerusalem possessed these advantages, Antioch was not without its defects. It had to meet—or perhaps it would be more true to say, it brought upon itself—the hostility of strong Mahomedan powers in the vicinity. As early as 1100 Bohemund was captured in battle by Danishmend of Sivas; and it was his captivity, depriving the patriarch as it did of Norman assistance, which allowed the uncontested accession of Baldwin I. Again, in 1104, the Normans, while attempting to capture Harran, were badly defeated on the river Balikh, near Rakka; and this defeat may be said to have been fatal to the chance of a great Norman principality.<sup>1</sup> But the hostility of Alexius, aided and abetted by the jealousy of Raymund of Toulouse, was almost equally fatal. Alexius claimed Antioch; was it not the old possession of his empire, and had not Bohemund done him homage? Raymund was ready to defend the claims of Alexius; was not Bohemund a successful rival? Thus it came about that Alexius and Raymund became allies; and by the aid of Alexius Raymund established, from 1102 onwards, the principality which, with the capture of Tripoli in 1109, became the principality of Tripoli, and barred the advance of Antioch to the south. Meanwhile the armies of Alexius not only prevented any farther advance to the N.W., but conquered the Cilician towns (1104). No wonder that Bohemund flung himself in revenge on the Eastern empire in 1108—only, however, to meet with a humiliating defeat at Durazzo.

Thus it was that Baldwin waxed while Bohemund waned. The growth of Baldwin's kingdom, as it was suggested above, owed more to the interests of Italian traders than it did to crusading zeal. In 1100, indeed, it might appear that a new Crusade from the West, which the capture of Antioch in 1098 had begun, and the conquest of Jerusalem in 1099 had finally set in motion, was destined to achieve great things for the nascent kingdom. Thousands had joined this new Crusade, which should deal the final blow to Mahomedanism: among the rest came the first of the troubadours, William IX., Count of Poitiers, to gather copy for his muse, and even some, like Stephen of Blois and Hugh of Vermandois, who had joined the First Crusade, but had failed to reach Jerusalem. The new crusaders cherished high plans; they would free Bohemund and capture Bagdad. But each of the three sections of their army was routed in turn in Asia Minor by the princes of Sivas, Aleppo and Harran, in the middle of 1101; and only a few escaped to report the crushing disaster. Baldwin I. had thus no assistance to expect from the West, save that of the Italian towns. From an early date Italian ships had followed the crusaders. There were Genoese ships in St Simeon's harbour in the spring of 1098 and at Jaffa in 1099; in 1099 Dagobert, the archbishop of Pisa, led a fleet from his city to the Holy Land; and in 1100 there came to Jaffa a Venetian fleet of 200 sail, whose leaders promised Venetian assistance in return for freedom from tolls and a third of each town they helped to conquer. But it was the Genoese who helped Baldwin I. most. The Venetians already enjoyed, since 1080, a favoured position in Constantinople, and had the less reason to find a new emporium in the East; while Pisa connected

itself, through Dagobert, with Antioch<sup>2</sup> rather than with Jerusalem, and was further, in 1111, invested by Alexius with privileges, which made an outlet in the Holy Land no longer necessary. But the Genoese, who had helped with provisions and siege-tackle in the capture of Antioch and of Jerusalem, had both a stronger claim on the crusaders, and a greater interest in acquiring an eastern emporium. An alliance was accordingly struck in 1101 (Fulcher II. c. vii.), by which the Genoese promised their assistance, in return for a third of all booty, a quarter in each town captured, and a grant of freedom from tolls. In this way Baldwin I. was able to take Arsuf and Caesarea in 1101 and Acre in 1104. But Genoese aid was given to others beside Baldwin (it enabled Raymund to capture Byblus in 1104, and his successor, William, to win Tripoli in 1109); while, on the other hand, Baldwin enjoyed other aid besides that of the Genoese. In 1110, for example, he was enabled to capture Sidon by the aid of Sigurd of Norway, the Jorsalafari, who came to the Holy Land with a fleet of 55 ships, starting in 1107, and in a three years' "wandering," after the old Norse fashion, fighting the Moors in Spain, and fraternizing with the Normans in Sicily. At a later date, in the reign of Baldwin II., Venice also gave her aid to the kings of Jerusalem. Irritated by the concessions made by Alexius to the Pisans in 1111, and furious at the revocation of her own privileges by John Comnenus in 1118, the republic naturally sought a new outlet in the Holy Land. A Venetian fleet of 120 sail came in 1123, and after aiding in the repulse of an attack, which the Egyptians had taken advantage of Baldwin II.'s captivity to deliver, they helped the regent Eustace to capture Tyre (1124), in return for considerable privileges—freedom from tolls throughout the kingdom, a quarter in Jerusalem, baths and ovens in Acre, and in Tyre one-third of the city and its suburbs, with their own court of justice and their own church. After thus gaining a new footing in Tyre, the Venetians could afford to attack the islands of the Aegean as they returned, in revenge for the loss of their privileges in Constantinople; but the hostility between Venice and the Eastern empire was soon afterwards appeased, when John Comnenus restored the old privileges of the Venetians. The Venetians, however, maintained their position in Palestine; and their quarters remained, along with those of the Genoese, as privileged commercial franchises in an otherwise feudal state.

In this way the kingdom of Jerusalem expanded until it came to embrace a territory stretching along the coast from Beirut (captured in 1110<sup>3</sup>) to el-Arish on the confines of Egypt—a territory whose strength lay not in Judaea, like the ancient kingdom of David, but, somewhat paradoxically (though commercial motives explain the paradox), in Phoenicia and the land of the Philistines. With all its length, the territory had but little breadth: towards the north it was bounded by the amirate of Damascus; in the centre, it spread little, if at all, beyond the Jordan; and it was only in the south that it had any real extension. Here there were two considerable annexes. To the south of the Dead Sea stretched a tongue of land, reaching to Aila, at the head of the eastern arm of the Red Sea. This had been won by Baldwin I., by way of revenge for the attacks of the Egyptians on his kingdom; and here, as early as 1116, he had built the fort of Monreal, half way between Aila and the Dead Sea. To the east of the Dead Sea, again, lay a second strip of territory, in which the great fortress was Krak (Kerak) of the Desert, planted somewhere about 1140 by the royal butler, Paganus, in the reign of Fulk of Jerusalem. These extensions in the south and east had also, it is easy to see, a commercial motive. They gave the kingdom a connexion of its own with the Red Sea and its shipping; and they enabled the Franks to

<sup>2</sup> Pisa naturally connected itself with Antioch, because Antioch was hostile to Constantinople, and Pisa cherished the same hostility, since Alexius I. had in 1080 given preferential treatment to Venice, the enemy of Pisa.

<sup>3</sup> This is the year in which the kingdom may be regarded as definitely founded. The period of conquest practically ends at this date, though isolated gains were afterwards made. The year 1110 is additionally important by reason of the accession of Maudud al Mosul, which marks the beginning of a Moslem reaction.

<sup>1</sup> Yet the north always continued to be more populous than the south; and the Latins maintained themselves in Antioch and Tripoli a century after the loss of Jerusalem. The land was richer in the north: it was protected by its connexion with Cyprus and Armenia: it was more remote from Egypt—the basis of Mahomedan power from the reign of Saladin onwards.



control the routes of the caravans, especially the route from Damascus to Egypt and the Red Sea. Thus, it would appear, the whole of the expansion of the Latin kingdom (which may be said to have attained its height in 1131, at the death of Baldwin II.) may be shown to have been dictated, at any rate in large part, by economic motives; and thus, too, it would seem that two of the most powerful motives which sway the mind of man—the religious motive and the desire for gain—conspired to elevate the kingdom of Jerusalem (at once the country of Christ, and a natural centre of trade) to a position of supremacy in Latin Syria. During this process of growth the kingdom stood in relation to two sects of powers—the three Frankish principalities in northern Syria, and the Mahommedan powers both of the Euphrates and the Nile—whose action affected its growth and character.

Of the three Frankish principalities, Edessa, founded in 1098 by Baldwin I. himself, was a natural fief of Jerusalem. Baldwin de Burgh, the future Baldwin II., ruled in Edessa as the vassal of Baldwin I. from 1100 to 1118; and thereafter the county was held in succession by the two Joscelins of Tell-bashir until the conquest of Edessa by Zengi in 1144. Lying to the east of the Euphrates, at once in close contact with the Armenians, and in near proximity to the great route of trade which came up the Euphrates to Rakka, and thence diverged to Antioch and Damascus, the county of Edessa had an eventful if brief life. The county of Tripoli, the second of these principalities, had also come under the aegis of Jerusalem at an early date. Founded by Raymund of Toulouse, between 1102 and 1105, with the favour of Alexius and the alliance of the Genoese, it did not acquire its capital of Tripoli till 1109. Even before the conquest of Tripoli, there had been dissensions between William, the nephew and successor of Raymund, and Bertrand, Raymund's eldest son, which it had needed the interference of Baldwin I. to compose; and it was only by the aid of the king that the town of Tripoli had been taken. At an early date therefore the county of Tripoli had already come under the influence of the kingdom. Meanwhile the principality of Antioch, ruled by Tancred, after the departure of Bohemund (1104–1112), and then by Roger his kinsman (1112–1119), was, during the reign of Baldwin I., busily engaged in disputes both with its Christian neighbours at Edessa and Tripoli, and with the Mahommedan princes of Mardin and Mosul. On the death of Roger in 1119, the principality came under the regency of Baldwin II. of Jerusalem, until 1126, when Bohemund II. came of age. Bohemund had married a daughter of Baldwin; and on his death in 1130 Baldwin II. had once more become the guardian of Antioch. From his reign therefore Antioch may be regarded as a dependency of Jerusalem; and thus the end of Baldwin's reign (1131) may be said to mark the time when the Latin kingdom of Jerusalem stands complete, with its own boundaries stretching from Beirut in the north to el-Arish and Aila in the south, and with the three Frankish powers of the north admitting its suzerainty.

The Latin power thus established and organized in the East had to face in the north a number of Mahommedan amirs, in the south the caliph of Egypt. The disunion between the Mahommedans of northern Syria and the Fatimites of Egypt, and the political disintegration of the former, were both favourable to the success of the Franks; but they had nevertheless to maintain their ground vigorously both in the north and the south against almost incessant attacks. The hostility of the decadent caliphate of Cairo was the less dangerous; and though Baldwin I. had at the beginning of his reign to meet annual attacks from Egypt, by the end he had pushed his power to the Red Sea, and in the very year of his death (1118) he had penetrated along the north coast of Egypt as far as Farama (Pelusium). The plan of conquering Egypt had indeed presented itself to the Franks from the first, as it continued to attract them to the end; and it is significant that Godfrey himself, in 1100, promised Jerusalem to the patriarch, "as soon as he should have conquered some other great city, and especially Cairo." But the real menace to the Latin kingdom lay in northern Syria; and here a power was eventually destined to rise, which outstripped the kings of

Jerusalem in the race for Cairo, and then—with the northern and southern boundaries of Jerusalem in its control—was able to crush the kingdom as it were between the two arms of a vice. Until 1127, however, the Mahommedans of northern Syria were disunited among themselves. The beginning of the 12th century was the age of the atabegs (regents or stadtholders). The atabegs formed a number of dynasties, which displaced the descendants of the Seljukian amirs in their various principalities. These dynasties were founded by emancipated mamelukes, who had held high office at court and in camp under powerful amirs, and who, on their death, first became stadtholders for their descendants, and then usurped the throne of their masters. There was an atabeg dynasty in Damascus founded by Tughtigin (1103–1128): there was another to the N.E., that of the Ortokids, represented by Sokman, who established himself at Kaifa in Diarbekr about 1101, and by his brother Ilghazi, who received Mardin from Sokman about 1108, and added to it Aleppo in 1117.<sup>1</sup> But the greatest of the atabegs were those of Mosul on the Tigris—Maudud, who died in 1113; Aksunkur, his successor; and finally, greatest of all, Zengi himself, who ruled in Mosul from 1127 onwards.

Before the accession of Zengi, there had been constant fighting, which had led, however, to no definite result, between the various Mahommedan princes and the Franks of northern Syria. The constant pressure of Tancred of Antioch and Baldwin de Burgh of Edessa led to a series of retaliations between 1110 and 1115; Edessa was attacked in 1110, 1111, 1112 and 1114; and in 1113 Maudud of Mosul had even penetrated as far as the vicinity of Acre and Jerusalem.<sup>2</sup> But the dissensions of the Mahommedans made their attacks unavailing; in 1115, for instance, we find Antioch actually aided by Ilghazi and Tughtigin against Aksunkur of Mosul. Again, in the reign of Baldwin II., there was steady fighting in the north; Roger of Antioch was defeated by Ilghazi at Balat in 1119, and Baldwin II. himself was captured by Balak, the successor of Ilghazi, in 1123, but on the whole the Franks held the upper hand. Baldwin conquered part of the territory of Aleppo (in 1121 and the following years), and extorted a tribute from Damascus (1126). But when Zengi established himself in Mosul in 1127, the tide gradually began to turn. He created for himself a great and united principality, comprising not only Mosul, but also Aleppo,<sup>3</sup> Harran, Nisibin and other districts; and in 1130, Alice, the widow of Bohemund II., sought his alliance in order to maintain herself in power at Antioch. In the beginning of the reign of Fulk of Jerusalem (1131–1143) the progress of Zengi was steady. He conquered in 1135 several fortresses in the east of the principality of Antioch, and in this year and the next pressed the count of Tripoli hard; while in 1137 he defeated Fulk at Barin, and forced the king to capitulate and surrender the town. If Fulk had been left alone to wage the struggle against Zengi, and if Zengi had enjoyed a clear field against the Franks, the fall of the kingdom of Jerusalem might have come far sooner than it did.<sup>4</sup> But there were two powers which aided Fulk, and impeded the progress of Zengi—the amirate of Damascus and the emperors of Constantinople. The position of Damascus is a position of crucial importance from 1130 to 1154. Lying between Mosul and Jerusalem, and important both strategically

<sup>1</sup> Ilghazi died in 1122. His successor was Balak, who ruled from 1122 to 1124, and succeeded in capturing in 1123 Baldwin II. of Jerusalem. The union of Mardin and Aleppo under the sway of these two amirs, connecting as it did Mesopotamia with Syria, marks an important stage in the revival of Mahommedan power (Stevenson, *Crusades in the East*, p. 109).

<sup>2</sup> Maudud (the brother of the sultan Mahommed) may be regarded as the first to begin the *jihad*, or counter-crusade, and his attack expedition of 1113, which carried him so far into the heart of Palestine, may be considered as the first act of the *jihad* (Stevenson, *op. cit.* pp. 87, 96).

<sup>3</sup> Aleppo had passed from the rule of Timurtash (son of Ilghazi and successor of Balak) into the possession of Aksunkur, 1125.

<sup>4</sup> Stevenson, however, believes that Zengi was *not* animated by the idea of recovering Jerusalem. He thinks that his principal aim was simply the formation of a compact Mahommedan state, which was, indeed, in the issue destined to be the instrument of the *jihad*, but was not so intended by Zengi (*op. cit.* pp. 123–124).

and from its position on the great route of commerce from the Euphrates to Egypt, Damascus became the arbiter of Syrian politics. During the greater part of the period between 1130 and 1154 the policy of Damascus was guided by the vizier Muin eddin Anar, who ruled on behalf of the descendants of the atabeg Tughtigin. He saw the importance of finding an ally against the ambition of Zengi, who had already attacked Damascus in 1130. The natural ally was Jerusalem. As early as 1133 the alliance of the two powers had been concluded; and in 1140 the alliance was solemnly renewed between Fulk and the vizier. Henceforth this alliance was a dominant factor in politics. One of the great mistakes made by the Franks was the breach of the alliance in 1147—a breach which was widened by the attack directed against Damascus during the Second Crusade; and the conquest of Damascus by Nureddin in 1154 was ultimately fatal to the Latin kingdom, removing as it did the one possible ally of the Franks, and opening the way to Egypt for the atabegs of Mosul.

The alliance of the emperors of Constantinople was of far more dubious value to the kings of Jerusalem. We have already seen that it was the theory of the Eastern emperors—a theory which logically followed from the homage of the crusaders to Alexius—that the conquests of the crusaders belonged to their empire, and were held by the crusading princes as fiefs. We have seen that the action of Bohemund at Antioch was the negation of this theory, and that Alexius in consequence helped Raymund to establish himself in Tripoli as a thorn in the side of Bohemund, and sent an army and a fleet which wrested from the Normans the towns of Cilicia (1104). The defeat of Bohemund at Durazzo in 1108 had resulted in a treaty, which made Antioch a fief of Alexius; but Tancred (who in 1107 had recovered Cilicia from the Greeks) refused to fulfil the terms of the treaty, and Alexius (who attempted—but in vain—to induce Baldwin I. to join an alliance against Tancred in 1112) was forced to leave Antioch independent. Thus, although Alexius had been able, in the wake of the crusading armies, to recover a large belt of land round the whole coast of Asia Minor,—the interior remaining subject to the sultans of Konia (Iconium) and the princes of Sivas,—he left the territories to the east of the western boundary of Cilicia in the hands of the Latins when he died in 1118. Not for 20 years after his death did the Eastern empire make any attempt to gain Cilicia or wrest homage from Antioch. But in 1137 John Comnenus appeared, instigated by the opportunity of dissensions in Antioch, and received its long-denied homage, as well as that of Tripoli; while in the following year he entered into hostilities with Zengi, without, however, achieving any considerable result. In 1142 he returned again, anxious to create a principality in Cilicia and Antioch for his younger son Manuel. The people of Antioch refused to submit; a projected visit to Jerusalem, during which John was to unite with Fulk in a great alliance against the Moslem, fell through; and in the spring of 1143 the emperor died in Cilicia, with nothing accomplished. On the whole, the interference of the Comneni, if it checked Zengi for the moment in 1138, may be said to have ultimately weakened and distracted the Franks, and to have helped to cause the loss of Edessa (1144), which marks the turning-point in the history of the kingdom of Jerusalem.

5. *Organisation of the Kingdom.*—Before we turn to describe the Second Crusade, which the loss of Edessa provoked, and to trace the fall of the kingdom, which the Second Crusade rather hastened than hindered, we may pause at this point to consider the organization of the Frankish colonies in Syria. The first question which arises is that of the relation of the kingdom of Jerusalem to the three counties or principalities of Antioch, Tripoli and Edessa, which acknowledged their dependence upon it. The degree of this dependence was always a matter of dispute. The rights of the king of Jerusalem chiefly appear when there is a vacancy or a minority in one of the principalities, or when there is dissension either inside one of the principalities or between two of the princes. On the death of one of the princes without heirs of full age, the kings of Jerusalem were entitled to act as regents, as Baldwin II. did twice at Antioch, in 1119

and 1130; but the kings regarded this right of regency as a burden rather than a privilege, and it is indeed characteristic of the relation of the king to the three princes, that it imposes upon him duties without any corresponding rights. It is his duty to act as regent; it is his duty to compose the dissensions in the principality of Antioch, and to repress the violences of the prince towards his patriarch (1154); it is his duty to reconcile Antioch with Edessa, when the two fall to fighting. The princes on their side acted independently: if they joined the king with their armies, it was as equals doing a favour; and they sometimes refused to join until they were coerced. They made their own treaties with the Mahommedans, or attacked them in spite of the king's treaties; they dated their documents by the year of their own reign, and they had each their separate laws or assizes. There was, in a word, co-ordination rather than subordination; nor did the kings ever attempt to embark on a policy of centralization.

The relation of the king to his own barons within his immediate kingdom of Jerusalem is not unlike the relation of the king to the three princes. In Norman England the king insisted on his rights; in Frankish Jerusalem the barons insisted on his duties. The circumstances of the foundation of the kingdom explain its characteristics. As the crusaders advanced to Jerusalem, says Raymund of Agiles (c. xxxiii.), it was their rule that the first-comer had the right to each castle or town, provided that he hoisted his standard and planted a garrison there. The feudal nobility was thus the first to establish itself, and the king only came after its institution—the reverse of Norman England, where the king first conquered the country, and then plotted it out among his nobles. The predominance of the nobility in this way became as characteristic of feudalism in the Latin kingdom of Jerusalem as the supremacy of the crown was of contemporary feudalism in England; and that predominance expressed itself in the position and powers of the high court, in which the ultimate sovereignty resided. The kingdom of Jerusalem consisted of a society of peers, in which the king might be *primus*, but in which he was none the less subject to a punctilious law, regulating his position equally with that of every member of the society. In such a society the election of the head by the members may seem natural; and in the case of Godfrey and the first two Baldwins this was the case. But the conception of the equality of the king and his peers in the long run led to hereditary monarchy; for if the king held his kingdom as a fief, like other nobles, the laws of descent which applied to a fief applied to the kingdom, and those laws demanded heredity. Yet the high court, which decided all problems of descent, would naturally intervene if a problem of descent arose, as it frequently did, in the kingdom; and thus the barons had the right of deciding between different claimants, and also of formally "approving" each new successor to the throne. The conception of the kingdom as a fief not only subjected it to the jurisdiction of the high court; it involved the more disastrous result that the kingdom, like other fiefs, might be carried by an heiress to her husband; and the proximate causes of the collapse of the kingdom in 1187 depend on this fact and the dissensions which it occasioned.

Thus conceived as the holder of a great fief, the king had only the rights of *suzerain* over the four great baronies and the twelve minor fiefs of his kingdom. He had not those rights of *sovereign* which the Norman kings of England inherited from their Anglo-Saxon predecessors, or the Capetian kings of France from the Carolings; nor was he able therefore to come into direct touch with each of his subjects, which William I., in virtue of his sovereign rights, was able to attain by the Salisbury oath of 1086. Amalric I. indeed, by his *assise sur la ligece*, attempted to reach the vassals of his vassals; he admitted *arrière-vassaux* to the *haute cour*, and encouraged them to carry their cases to it in the first instance. But this is the only attempt at that policy of *immédialisation* which in contemporary England was carried to far greater lengths; and even this attempt was unsuccessful. No alliance was actually formed between the king and the mesne nobility against the immediate baronage. The body of the tenants-in-chief continued to limit the power of the crown:

their consent was necessary to legislation, and grants of fiefs could not be made without their permission. Nor was the crown only limited in this way. The *duties* of the king towards his tenants are prominent in the *assises*. The king's oath to his men binds him to respect and maintain their rights, which are as prominent as are his duties; and if the men feel that the royal oath has not been kept, they may lawfully refuse military service (*gager le roi*), and may even rise in authorized and legal rebellion. The system of military service and the organization of justice corresponded to the part which the monarchy was thus constrained to play. The vassal was bound to pay military service, not, as in western Europe, for a limited period of forty days, but for the whole year—the Holy Land being, as it were, in a perpetual state of siege. On the other hand, the vassal was not bound to render service, unless he were *paid* for his service; and it was only famine, or Saracen devastation, which freed the king from the obligation of paying his men. The king was also bound to insure the horses of his men by a system called the *restor*: if a vassal lost his horse otherwise than by his own fault, it must be replaced by the treasury (which was termed, as it also was in Norman Sicily, the *secretum*).<sup>1</sup> But the king had another force in addition to the feudal levy—a paid force of *soudoyers*,<sup>2</sup> holding fiefs, not of land, but of pay (*fiefs de soudée*). Along with this paid cavalry went another branch of the army, the Turcopuli, a body of light cavalry, recruited from the Syrians and Mahommedans, and using the tactics of the Arabs; while an infantry was found among the Armenians, the best soldiers of the East, and the Maronites, who furnished the kingdom with archers. To all these various forces must be added the knights and native levies of the great orders, whose masters were practically independent sovereigns like the princes of Antioch and Tripoli;<sup>3</sup> and with these the total levy of the kingdom may be reckoned at some 25,000 men. But the strength of the kingdom lay less perhaps in the army than in the magnificent fortresses which the nobility, and especially the two orders, had built; and the most visible relic of the crusades to-day is the towering ruins of a fortress like Krak (Kerak) des Chevaliers, the fortress of the Knights of St John in the principality of Tripoli. These fortresses, garrisoned not by the king, as in Norman England, but by their possessors, would only strengthen the power of the feudatories, and help to dissipate the kingdom into a number of local units.

In the organization of its system of justice the kingdom showed its most characteristic features. Two great central courts sat in Jerusalem to do justice—the high court of the nobles, and the court of burgesses for the rest of the Franks. (1) The high court was the supreme source of justice for the military class; and in its composition and procedure the same limitation of the crown, which appears in regard to military service, is again evident. The high court is not a *curia regis*, but a *curia baronum*, in which the theory of *judicium parium* is fully realized. If the king presides in the court, the motive of its action is none the less the preservation of the rights of the nobles, and not, as in England, the extension of the rights of the crown. It is a court of the king's peers: it tries cases of dispute between the king and his peers—with regard, for instance, to military service—and it settles the descent of the title of king. (2) The court of

burgesses was almost equally sovereign within its sphere. While the body of the noblesse formed the high court, the court of the burgesses was composed of twelve legists (probably named by the king) under the presidency of the *vicomte*—a knight also named by the king, who was a great financial as well as a judicial officer. The province of the court included all acts and contracts between burgesses, and extended to criminal cases in which burgesses were involved. Like the high court, the court of burgesses had also its *assizes*<sup>4</sup>—a body of unwritten legal

<sup>4</sup> As was noticed above, there were apparently separate *assizes* for the three principalities, in addition to the *assizes* of the kingdom. The *assizes* of Antioch have been discovered and published. The *assizes* of the kingdom itself are twofold—the *assizes* of the high court and the *assizes* of the court of burgesses. (1) The *assizes* of the high court are preserved for us in works by legists—John of Ibelin, Philip of Novara and Geoffrey of Tort—composed in the 13th century. We possess, in other words, *law-books* (like Bracton's treatise *De legibus*), but not *laws*—and law-books made after the loss of the kingdom to which the laws belonged. There are two vexed questions with regard to these law-books. (a) The first concerns the origin and character of the laws which the law-books profess to expound. According to the story of the legists who wrote these books—e.g. John of Ibelin—the laws of the kingdom were laid down by Godfrey, who is thus regarded as the great *νομοθετης* of the kingdom. These laws (progressively modified, it is admitted) were kept in Jerusalem, under the name of "Letters of the Sepulchre," until 1187. In that year they were lost; and the legists tell us that they are attempting to reconstruct *par oir dire* the gist of the lost archetype. The story of the legists is now generally rejected. Godfrey never legislated: the customs of the kingdom gradually grew, and were gradually defined, especially under kings like Baldwin III. and Amalric I. If there was thus only a customary and unwritten law (and William of Tyre definitely speaks of a *jus consuetudinarium* under Baldwin III., *quo regnum regebatur*), then the "Letters of the Sepulchre" are a myth—or rather, if they ever existed, they existed not as a code of written law, but, perhaps, as a register of fiefs, like the Sicilian *Defetaris*. Thus the story of the legists shrinks down to the regular myth of the primitive legislator, used to give an air of respectability to law-books, which really record an unwritten custom. The fact is that until the 13th century the Franks lived *consuetudinibus antiquis et jure non scripto*. They preferred an unwritten law, as Prutz suggests, partly because it suited the barristers (who often belonged to the baronage, for the Frankish nobles were "great pleaders in court and out of court"), and partly because the high court was left unbound so long as there was no written code. In the 13th century it became necessary for the legists to codify, as it were, the unwritten law, because the upheavals of the times necessitated the fixing of some rules in writing, and especially because it was necessary to oppose a definite custom of the kingdom to Frederick II., who sought, as king of Jerusalem, to take advantage of the want of a written law, to substitute his own conceptions of law in the teeth of the high court. (b) The second difficulty concerns the text of the law-books themselves. The text of Ibelin became a *textus receptus*—but it also became overlaid by glosses, for it was used as authoritative in the kingdom of Cyprus after the loss of the kingdom of Jerusalem, and it needed expounding. Recensions and revisions were twice made, in 1368 and 1531; but how far the true Ibelin was recovered, and what additions or alterations were made at these two dates, we cannot tell. We can only say that we have the text of Ibelin which was used in Cyprus in the later middle ages. At the same time, if our text is thus late, it must be remembered that its content gives us the earliest and purest exposition of French feudalism, and describes for us the organization of a kingdom, where all rights and duties were connected with the fief, and the monarch was only a suzerain of feudatories. (2) The *assizes* of the court of burgesses became the basis of a treatise at an earlier date than the *assizes* of the high court. The date of the redaction (which was probably made by some learned burgess) may well have been the reign of Baldwin III., as Kugler suggests: he was the first native king, and a king learned in the law; but Beugnot would refer the *assizes* to the years immediately preceding Saladin's capture of Jerusalem. These *assizes* do not, of course, appear in Ibelin, who was only concerned with the feudal law of the high court. They were used, like the *assizes* of the high court, in Cyprus; and, like the other *assizes*, they were made the subject of investigation in 1531, with the object of discovering a good text. The law which is expounded in these *assizes* is a mixture of Frankish law with the Graeco-Roman law of the Eastern empire which prevailed among the native population of Syria.

In regard to both *assizes*, it is most important to bear in mind that we possess not laws, but law-books or customals—records made by lawyers for their fellows of what they conceived to be the law, and supported by legal arguments and citations of cases. But, as Prutz remarks, Philip of Novara *lehrt nicht die Wissenschaft des Rechts, sondern die des Unrechts*: he does not explain the law so much as the ways of getting round it.

<sup>1</sup> There are certain connexions and analogies between the kingdom of Sicily and that of Jerusalem during the twelfth century. In either case there is an importation of Western feudalism into a country originally possessed of Byzantine institutions, but affected by an Arabic occupation. The subject deserves investigation.

<sup>2</sup> The holders of fiefs (*sodeers*) both held fiefs of land and received pay: the paid force of *soudoyers* only received pay. An instance of the latter is furnished by John of Margat, a vassal of the seignory of Arsuf. He has 200 bezants, along with a quantity of wheat, barley, lentils and oil; and in return he must march with four horses (Rey, *Les Colonies franques en Syrie*, p. 24).

<sup>3</sup> For the history of the orders see the articles on the **TEMPLARS**; **ST JOHN OF JERUSALEM, KNIGHTS OF**; **KNIGHTS, and the TEUTONIC ORDER**. The Templars were founded about the year 1118 by a Burgundian knight, Hugh de Paganis; the Hospitallers sprang from a foundation in Jerusalem erected by merchants of Amalch before the First Crusade, and were reorganized under Gerard le Puy, master until 1120. The Teutonic knights date from the Third Crusade.

custom. The independent position of the burgesses, who thus assumed a position of equality by the side of the feudal class, is one of the peculiarities of the kingdom of Jerusalem. It may be explained by reference to the peculiar conditions of the kingdom. Burgesses and nobles, however different in status, were both of the same Frankish stock, and both occupied the same superior position with regard to the native Syrians. The commercial motive, again, had been one of the great motives of the crusade; and the class which was impelled by that motive would be both large and, in view of the quality of the Eastern goods in which it dealt, exceptionally prosperous. Finally, when one remembers how, during the First Crusade, the *pedites* had marched side by side with the *principes*, and how, from the beginning of 1099, they had practically risen in revolt against the selfish ambitions of princes like Count Raymund, it becomes easy to understand the independent position which the burgesses assumed in the organization of the kingdom. Burgesses could buy and possess property in towns, which knights were forbidden to acquire; and though they could not intermarry with the feudal classes, it was easy and regular for a burgess to thrive to knighthood. Like the nobles, again, the burgesses had the right of confirming royal grants and of taking part in legislation; and they may be said to have formed—socially, politically and judicially—an independent and powerful estate. Yet (with the exception of Antioch, Tripoli and Acre in the course of the 13th century) the Frankish towns never developed a communal government: the domain of their development was private law and commercial life.

Locally, the consideration of the system of justice administered in the kingdom involves some account of three things—the organization of the fiefs, the position of the Italian traders in their quarters, and the privileges of the Church. Each fief was organized like the kingdom. In each there was a court for the noblesse, and a court (or courts) for the bourgeoisie. There were some thirty-seven *cours de bourgeoisie* (several of the fiefs having more than one), each of which was under the presidency of a *vicomte*, while all were independent of the court of burgesses at Jerusalem. Of the feudal courts there were some twenty-two. Each of these followed the procedure and the law of the high court; but each was independent of the high court, and formed a sovereign court without any appeal. On the other hand, the revolution wrought by Amalric I. in the status of the *arrière-vassaux*, which made them members of the high court, allowed them to carry their cases to Jerusalem in the first instance, if they desired. Apart from this, the characteristic of seignorial justice is its independence and its freedom from the central court; though, when we reflect that the central court is a court of seigneurs, this characteristic is seen to be the logical result of the whole system. Midway between the seignorial *cours de bourgeoisie* and the privileged jurisdictions of the Italian quarter, there were two kinds of courts of a commercial character—the *cours de la fonde* in towns where trade was busy, and the *cours de la chatne* in the sea-ports. The former courts, under their bailiffs, gradually absorbed the separate courts which the Syrians had at first been permitted to enjoy under their own *reis*; and the bailiff with his 6 assessors (4 Syrians and 2 Franks) thus came to judge both commercial cases and cases in which Syrians were involved. The *cours de la chatne*, whose institution is assigned to Amalric I. (1162–1174), had a civil jurisdiction in admiralty cases, and, like the *cours de la fonde*, they were composed of a bailiff and his assessors. Distinct from all these courts, if similar in its sphere, is the court which the Italian quarter generally enjoyed in each town under its own consuls—a court privileged to try all but the graver cases, like murder, theft and forgery. The court was part of the general immunity which made these quarters *imperia in imperio*: their exemptions from tolls and from financial contributions is parallel to their judicial privileges. Regulated by their mother-town, both in their trade and their government, these Italian quarters outlasted the collapse of the kingdom, and continued to exist under Mahomedan rulers. The Church had its separate courts, as in the West; but their province was perhaps greater than

elsewhere. The church courts could not indeed decide cases of perjury; but, on the other hand, they tried all matters in which clerical property was concerned, and all cases of dispute between husband and wife. In other spheres the immunities and exemptions of the Church offered a far more serious problem, and especially in the sphere of finance. Perhaps the supreme defect of the kingdom of Jerusalem was its want of any financial basis. It is true that the king had a revenue, collected by the *vicomte* and paid into the *secretum* or treasury—a revenue composed of tolls on the caravans and customs from the ports, of the profits of monopolies and the proceeds of justice, of poll-taxes on Jews and Mahomedans, and of the tributes paid by Mahomedan powers. But his expenditure was large: he had to pay his feudatories; and he had to provide fiefs in money and kind to those who had not fiefs of land. The contributions sent to the Holy Land by the monarchs of western Europe, as commutations in lieu of personal participation in crusades, might help; the fatal policy of razzias against the neighbouring Mahomedan powers might procure temporary resources; but what was really necessary was a wide measure of native taxation, such as was once, and once only, attempted in 1183. To any such measure the privileges of the Italian quarters, and still more those of the Church, were inimical. In spite of provisions somewhat parallel to those of the English statute of mortmain, the clergy continued to acquire fresh lands at the same time that they refused to contribute to the defence of the kingdom, and rigorously exacted the full quota of tithe from every source which they could tap, and even from booty captured in war. The richest proprietor in the Holy Land,<sup>1</sup> but practically immune from any charges on its property, the Church helped, unconsciously, to ruin the kingdom which it should have supported above all others. It refused to throw its weight into the scale, and to strengthen the hands of the king against an over-mighty nobility. On the other hand, it must be admitted that the Church did not, after the first struggle between Dagobert and Baldwin I., actively oppose by any hierarchical pretensions the authority of the crown. The assizes may speak of patriarch and king as conjoint seigneurs in Jerusalem; but as a matter of fact the king could secure the nomination of his own patriarch, and after Dagobert the patriarchs are, with the temporary exception of Stephen in 1128, the confidants and supporters of the kings. It was the two great orders of the Templars and the Hospitallers which were, in reality, most dangerous to the kingdom. Honeycombed as it was by immunities—of seigneurs, of Italian quarters, of the clergy—the kingdom was most seriously impaired by these overweening immunists, who, half-lay and half-clerical, took advantage of their ambiguous position to escape from the duties of either character. They built up great estates, especially in the principality of Tripoli; they quarrelled with one another, until their dissensions prevented any vigorous action; they struggled against the claims of the clergy to tithes and to rights of jurisdiction; they negotiated with the Mahomedans as separate powers; they conducted themselves towards the kings as independent sovereigns. Yet their aid was as necessary as their influence was noxious. Continually recruited from the West, they retained the vigour which the native Franks of Palestine gradually lost; and their corporate strength gave a weight to their arms which made them indispensable.

In describing the organization of the kingdom, we have also been describing the causes of its fall. It fell because it had not the financial or political strength to survive. "Les vices du gouvernement avaient été plus puissants que les vertus des gouvernants." But the vices were not only vices of the government: they were also vices, partly inevitable, partly moral, in the governing race itself. The climate was no doubt responsible for much. The Franks of northern Europe attempted to live a life that suited a northern climate under a southern sun. They rode incessantly to battle over burning sands, in full armour

<sup>1</sup> For instance, the abbey of Mount Sion had large possessions, not only in the Holy Land (at Ascalon, Jaffa, Acre, Tyre, Caesarea and Tarsus), but also in Sicily, Calabria, Lombardy, Spain and France (at Orleans, Bourges and Poitiers).

—chain mail, long shield and heavy casque—as if they were on their native French soil. The ruling population was already spread too thin for the work which it had to do; and exhausted by its efforts, it gradually became extinct. A constant immigration from the West, bringing new blood and recruiting the stock, could alone have maintained its vigour; and such immigration never came. Little dribbles of men might indeed be added to the numbers of the Franks; but the great bodies of crusaders either perished in Asia Minor, as in 1101 and 1147, or found themselves thwarted and distrusted by the native Franks. It was indeed one of the misfortunes of the kingdom that its inhabitants could never welcome the reinforcements which came to their aid.<sup>1</sup> The barons suspected the crusaders of ulterior motives, and of designing to get new principalities for themselves. In any case the native Frank, accustomed to commercial intercourse and diplomatic negotiations with the Mahomedans, could hardly share the unreasoning passion to make a dash for the “infidel.” As with the barons, so with the burgesses: they profited too much by their intercourse with the Mahomedans to abandon readily the way of peaceful commerce, and they were far more ready to hinder than to help any martial enterprise. Left to itself, the native population lost physical and moral vigour. The barons alternated between the extravagances of Western chivalry and the attractions of Eastern luxury: they returned from the field to divans with frescoed walls and floors of mosaic, Persian rugs and embroidered silk hangings. Their houses, at any rate those in the towns, had thus the characteristics of Moorish villas; and in them they lived a Moorish life. Their sideboards were covered with the copper and silver work of Eastern smiths and the confectioneries of Damascus. They dressed in flowing robes of silk, and their women wore oriental gauzes covered with sequins. Into these divans where figures of this kind moved to the music of Saracen instruments, there entered an inevitable voluptuousness and corruption of manners. The hardships of war and the excesses of peace shortened the lives of the men; the kingdom of Jerusalem had eleven kings within a century. While the men died, the women, living in comparative indolence, lived longer lives. They became regents to their young children; and the experience of all medieval minorities reiterates the lesson—woe to the land where the king is a child and the regent a woman. Still worse was the frequent remarriage of widowed princesses and heiresses. By the assizes of the high court, the widow, on the death of her husband, took half of the estate for herself, and half in guardianship for her children. *Liberæ ire cum terra*, widows carried their estates or titles to three or four husbands; and as in 15th-century England, the influence of the heiress was fatal to the peace of the country. At Antioch, for instance, after the death of Bohemund II. in 1130, his widow Alice headed a party in favour of the marriage of the heiress Constance to Manuel of Constantinople, and did not scruple to enter into negotiations with Zengi of Mosul. Her policy failed; and Constance successively married Raymund of Antioch and Raynald of Chatillon. The result was the renewed enmity of the Greek empire, while the French adventurers who won the prize ruined the prospects of the Franks by their conduct. In the kingdom matters were almost worse. There was hardly any regular succession to the throne; and Jerusalem, as Stubbs writes, “suffered from the weakness of hereditary right and the jealousies of the elective system” at one and the same time. With the frequent remarriages of the heiresses of the kingdom, relationships grew confused and family quarrels frequent; and when Sibylla carried the crown to Guy de Lusignan, a newcomer disliked by all the relatives of the crown, she sealed the fate of the kingdom.

It may be doubted—though it seems a harsh verdict to pass

<sup>1</sup> One must remember that these reinforcements would often consist of desperate characters. It was one of the misfortunes of Palestine that it served as a Botany Bay, to which the criminals of the West were transported for penance. The natives, already prone to the immorality which must infect a mixed population living under a hot sun, the immorality which still infects a place like Aden, were not improved by the addition of convicts.

on a kingdom founded by religious zeal on holy soil—whether the kingdom possessed that moral basis which alone can give a right of survival to any institution or organization. The crusading states had been founded by adventurers who thirsted for gain; and the primitive appetite did not lose its edge with the progress of time. We cannot be certain, indeed, how far the Frankish lords oppressed their Syrian tenants: the stories of such oppression have been discredited; while if we may trust the evidence of a Mahomedan traveller, Ibn Jubair, the lot of the Mahomedan who lived on Frankish manors was better than it had been under their native lords.<sup>2</sup> But the habits of the Franks were none the less habits of lawless greed: they swooped down from their castles, as Raynald of Chatillon did from Krak of the Desert, to capture Saracens and hold them to ransom or to plunder caravans. The lust of unlawful gain had infected the Frankish blood, as it seems to have infected England during the Hundred Years’ War; and in either case nemesis infallibly came. The Moslems might have endured a state of “infidels”; they could not endure a state of brigands.

6. *The History of the Kingdom and the Crusades from the Loss of Edessa in 1144 to the Fall of Jerusalem in 1187.*—The years 1143–1144 are in many ways the turning point in the history of the Latin East. In 1143 began the reign of the first native king;<sup>3</sup> and about this date may be placed the final organization of the kingdom, witnessed by the completion of its body of customary law. At the same date, however, the decline of the kingdom also begins; the fall of Edessa is the beginning of the end. In 1143 John Comnenus and Fulk had just died, and Zengi, seeing his way clear, threw himself on the great Christian outpost, against which the tides of Mahomedan attack had so often vainly surged, and finally entered on Christmas Day 1144. Two years later Zengi died; but he left an able successor in his son, Nureddin, and an attempt to recover Edessa was successfully repelled in November 1146. Not only so, but in the spring of 1147 the Franks were unwise enough to allow the hope of gaining two small towns to induce them to break the vital alliance with Damascus. Thus, in itself, the position of affairs in the Holy Land in 1147 was certainly ominous; and the kingdom might well seem dependent for its safety on such aid as it might receive from the West.

Early in 1145 news had come from Antioch to Eugenius III. of the fall of Edessa, and at the end of the year he had sent an encyclical to France—the natural soil, as we have seen, of crusading zeal. The response was instantaneous: the king of France himself, who bore on his conscience the burden of an unpunished massacre by his troops at Vitry in 1142,<sup>4</sup> took the crusading vow on the Christmas day of 1145. But the greatest success was attained when St Bernard—no great believer in pilgrimages, and naturally disposed to doubt the policy of a second Crusade—was induced by the pope to become the preacher of the new movement. To the crusading king of

<sup>2</sup> The manorial system in the Latin kingdom of Jerusalem was a continuation of the village system as it had existed under the Arabs. In each village (*casale*) the *rustici* were grouped in families (*foci*): the tenants paid from  $\frac{1}{4}$  to  $\frac{1}{3}$  of the crop, besides a poll-tax and labour-dues. The villages were mostly inhabited by Syrians: it was rarely that Franks settled down as tillers of the soil. Prutz regards the manorial system as oppressive. Absentee landlords, he thinks, rack-rented the soil (p. 167), while the “inhuman severity” of their treatment of villeins led to a progressive decay of agriculture, destroyed the economic basis of the Latin kingdom, and led the natives to welcome the invasion of Saladin (pp. 327–331).

The French writers Rey and Dodu are more kind to the Franks; and the testimony of contemporary Arabic writers, who seem favourably impressed by the treatment of their subjects by the Franks, bears out their view, while the tone of the assizes is admittedly favourable to the Syrians. One must not forget that there was a brisk native manufacture of carpets, pottery, ironwork, gold-work and soap; or that the Syrians of the towns had a definite legal position.

<sup>3</sup> After 1143 one may therefore speak of the period of the Epigoni—the native Franks, ready to view the Moslems as joint occupants of Syria, and to imitate the dress and habits of their neighbours.

<sup>4</sup> Doubt has been cast on the view that a troubled conscience drove Louis to take the cross; and his action has been ascribed to simple religious zeal (cf. Lavissee, *Histoire de France*, iii. 12).



France St Bernard added the king of Germany, when, in Christmas week of 1146, he induced Conrad III. to take the vow by his sermon in the cathedral of Spire. Thus was begun the Second Crusade,<sup>1</sup> under auspices still more favourable than those which attended the beginning of the First, seeing that kings now took the place of knights, while the new crusaders would no longer be penetrating into the wilds, but would find a friendly basis of operations ready to their hands in Frankish Syria. But the more favourable the auspices, the greater proved the failure. Already at the final meeting at Étampes, in 1147, difficulties arose. Manuel Comnenus demanded that all conquests made by the crusaders should be his fiefs; and the question was debated whether the crusaders should follow the land route through Hungary, along the old road of Charlemagne, or should go by sea to the Holy Land. In this question the envoys of Manuel and of Roger of Sicily, who were engaged in hostilities with one another, took opposite sides. Conrad, related by marriage to Manuel, decided in favour of the land route, which Manuel desired because it brought the Crusade more under his direction, and because, if the route by sea were followed, Roger of Sicily might be able to divert the crusading ships against Constantinople. As it was, a struggle raged between Roger and Manuel during the whole progress of the Crusade, which greatly contributed towards its failure, preventing, as it did, any assistance from the Eastern empire. Nor was there any real unity among the crusaders themselves. The crusaders of northern Germany never went to the Holy Land at all; they were allowed the crusaders' privileges for attacking the Wends to the east of the Elbe—a fact which at once attests the cleavage between northern and southern Germany (intensified of late years by the war of investitures), and anticipates the age of the Teutonic knights and their long Crusade on the Baltic. The crusaders of the Low Countries and of England took the sea route, and attacked and captured Lisbon on their way, thus helping to found the kingdom of Portugal, and achieving the one real success which was gained by the Second Crusade.<sup>2</sup> Among the great army of crusaders who actually marched to Jerusalem there was little real unity. Conrad and Louis VII. started separately, and at different times, in order to avoid dissensions between their armies; and when they reached Asia Minor (after encountering some difficulties in Greek territory) they still acted separately. Eager to win the first spoils, the German crusaders, who were in advance of the French, attempted a raid into the sultanate of Iconium; but after a stern fight at Dorylaeum they were forced to retreat (October 1147), and for the most part perished by the way. Louis VII., who now appeared, was induced by this failure to take the long and circuitous route by the west coast of Asia Minor; but even so he had lost the majority of his troops when he reached the Holy Land in 1148. Here he joined Conrad (who had come by sea from Constantinople) and Baldwin III., and after some deliberation the three

<sup>1</sup> We speak of First, Second and Third Crusades, but, more exactly, the Crusades were one continuous process. Scarcely a year passed in which new bands did not come to the Holy Land. We have already noticed the great if disastrous Crusade of 1100–1101, and the Venetian Crusade of 1123–1124; and we may also refer to the Crusade of Henry the Lion in 1172, and to that of Edward I. in 1271–1272—all famous Crusades, which are not reckoned in the usual numbering. Crusades appear to have been dignified by numbers when they followed some crushing disaster—the loss of Edessa in 1144, or the fall of Jerusalem in 1187—and were led by kings and emperors; or when, like the Fourth and Fifth Crusades, they achieved some conspicuous success or failure. But it is important to bear in mind the continuity of the Crusades—the constant flow of new forces eastward and back again westward; for this alone explains why the Crusades formed a great epoch in civilization, familiarizing, as they did, the West with the East.

<sup>2</sup> This body of crusaders ultimately reached the Holy Land, where it joined Conrad (who had lost his own original forces), and helped in the fruitless siege of Damascus. The services which it rendered to Portugal were repeated by later crusaders. Crusaders from the Low Countries, England and the Scandinavian north took the coast route round western Europe; and it was natural that, landing for provisions and water, they should be asked, and should consent, to lend their aid to the natives against the Moors. Such aid is recorded to have been given on the Third and the Fifth Crusades.

sovereigns resolved to attack Damascus. The attack was impolitic: Damascus was the one ally which could help the Franks to stem the advance of Nureddin. It proved as futile as it was impolitic; for the vizier of Damascus, Muin-eddin-Anar, was able to sow dissension between the native Franks and the crusaders; and by bribes and promises of tribute he succeeded in inducing the former to make the siege an absolute failure, at the end of only four days (July 28th, 1148). The Second Crusade now collapsed. Conrad returned to Constantinople in the autumn of 1148, and Louis VII. returned by sea to France in the spring of 1149. The only effects of this great movement were effects prejudicial to the ends towards which it was directed. The position of the Franks in the Holy Land was not improved by the attack on Damascus; while the ignominious failure of a Crusade led by two kings brought the whole crusading movement into discredit in western Europe, and it was utterly in vain that Suger and St Bernard attempted to gather a fresh Crusade in 1150.

The result of the failure of the Second Crusade was the renewal of Nureddin's attacks. The rest of the county of Edessa, including Tell-bashir on the west, was now conquered (1150); while Raymond of Antioch was defeated and killed (in 1149), and several towns in the east of his principality were captured. Baldwin III. attempted to make head against these troubles, partly by renewing the old alliance with Damascus, partly by drawing closer to Manuel of Constantinople. For the next twenty years, during the reigns of Baldwin and his brother Amalric I., there is indeed a close connexion between the kingdom of Jerusalem and the East Roman empire. Baldwin and Amalric both married into the Comnenian house, while Manuel married Mary of Antioch, the daughter of Raymond. In the north Manuel enjoyed the homage of Antioch, which his father had gained in 1137, and the nominal possession of Tell-bashir, which had been ceded to him by Baldwin III.: in the south he joined with Amalric I. in the attempt to acquire Egypt (1168–1171). In this way he acquired a certain ascendancy over the Latin kings: Baldwin III. rode behind him at Antioch in 1159 without any of the insignia of royalty, and in an inscription at Bethlehem of 1172 Amalric I. had the name of the emperor written above his own.<sup>3</sup> The patronage of Constantinople, to which Jerusalem was thus practically surrendered, contributed to some slight extent in maintaining the kingdom against Nureddin. But there were dissensions within, both between Baldwin and his mother, Melisinda, who sought to protract her regency unduly, and between contending parties in Antioch, where the hand of Constance, Raymond's widow, was a desirable prize<sup>4</sup>; while from without the horns of the crescent were slowly closing in on the kingdom. Nureddin pursued in his policy the tactics which the Mahommedans used against the Franks in battle: he sought to envelop their territories on every side. In 1154 fell Damascus, and the crescent closed perceptibly in the north: the most valuable ally of the kingdom was lost, and the way seemed clear from Aleppo (the peculiar seat of Nureddin's power) into Egypt. On the other hand, in 1153 Baldwin III. had taken Ascalon, which for fifty years had mocked the efforts of successive kings, and by this stroke he might appear to have closed for Nureddin the route to Egypt, and to have opened a path for its conquest by the Franks. For the future, events hinged on the situation of affairs in Egypt, and in Egypt the fate of the kingdom of Jerusalem was finally decided (see EGYPT: *History*, "Mahommedan Period"). There was a race for the possession of the country between Nureddin's lieutenant Shīrghūh or Shīrkūh and Amalric I., the brother and successor of Baldwin III.; and in the race Shīrkūh proved the winner.

Since the days of Godfrey and Baldwin I., Egypt had been a

<sup>3</sup> Manuel was an ambitious sovereign, apparently aiming at a world-monarchy, such as was afterwards attempted from the other side by Henry VI. As Henry VI. had designs on Constantinople and the Eastern empire, so Manuel cherished the ambition of acquiring Italy and the Western empire, and he negotiated with Alexander III. to that end in 1167 and 1169: cf. the life of Alexander III. in Muratori, *S. R. I.* iii. 460.

<sup>4</sup> The prize was won by Raynald of Chatillon (*q.v.*)

goal of Latin ambition, and the capture of Ascalon must obviously have given form and strength to the projects for its conquest. Plans of attack were sketched: routes were traced: distances were measured; and finally in 1163 there came the impulse from within which turned these plans into action. The Shiite caliphs of Egypt were by this time the playthings of contending viziers, as the Sunnite caliphs of Bagdad had long been the puppets of Turkish sultans or amirs; and in 1164 Amalric I. and Nureddin were fighting in Egypt in support of two rival viziers, Dirgham and Shawar. For Nureddin the fight meant the acquisition of an heretical country for the true faith of the Sunnite, and the final enveloping of the Latin kingdom:<sup>1</sup> for Amalric it meant the escape from Nureddin's net, and a more direct and lucrative contact with Eastern trade. Into the vicissitudes of the fight it is not necessary here to enter; but in the issue Nureddin won, in spite of the support which Manuel gave to Amalric. Nureddin's Kurdish lieutenant, Shirghūh, succeeded in establishing in power the vizier whom he favoured, and finally in becoming vizier himself (January 1169); and when he died, his nephew Saladin (Sala-ed-din) succeeded to his position (March 1169), and made himself, on the death of the caliph in 1171, sole ruler in Egypt. Thus the Shiite caliphate became extinct: in the mosques of Cairo the name of the caliph of Bagdad was now used; and the long-disunited Mahommedans at last faced the Christians as a solid body. But nevertheless the kingdom of Jerusalem continued almost unmenaced, and practically undiminished, for the next sixteen years. If a religious union had been effected between Egypt and northern Syria, political disunion still remained; and the Franks were safe as long as it lasted. Saladin acted as the peer of Nureddin rather than as his subject; and the jealousy between the two kept both inactive till the death of Nureddin in 1174. Nureddin only left a minor in his place: Amalric, who died in the same year, left a son (Baldwin IV.) who was not only a minor but also a leper; and thus the stage seemed cleared for Saladin. He was confronted, however, by Raymund, count of Tripoli, the one man of ability among the decadent Franks, who acted as guardian of the kingdom; while he was also occupied in trying to win for himself the Syrian possessions of Nureddin. The task engaged his attention for nine years. Damascus he acquired as early as 1174; but Raymund supported the heir of Nureddin in his capital at Aleppo, and it was not until 1183 that Saladin entered the city, and finally brought Egypt and northern Syria under a single rule.

The hour of peril for the Latin kingdom had now at last struck. It had done little to prepare itself for that hour. Repeated appeals had been sent to the West from the beginning of the Egyptian affair (1163) onwards; while in 1184-1185 a great mission, on which the patriarch of Jerusalem and the masters of the Templars and the Hospitallers were all present, came to France and England, and offered the crown of Jerusalem to Philip Augustus and Henry II. in turn, in order to secure their presence in the Holy Land.<sup>2</sup> The only result of these appeals was the rise of a regular system of taxation in France and England, *ad sustentationem Jerosolimitanæ terræ*, which starts about 1185 (though there had already been isolated taxes in 1147 and 1166), and which has been described as the beginning of modern taxation. In the East itself, with the exception of the tax of 1183,<sup>3</sup> nothing was done that was good, and two things were done which were evil. Sibylla married her second husband, Guy de Lusignan, in 1180—a marriage destined to be the cause of many dissensions; for Sibylla, the eldest daughter

<sup>1</sup> Nureddin, unlike his father, was definitely animated by a religious motive: he fought first and foremost against the Latins (and not, like his father, against Moslem states), and he did so as a matter of religious duty.

<sup>2</sup> Henry II., as an Angevin, was the natural heir of the kingdom of Jerusalem on the extinction of the line descended from Fulk of Anjou. This explains the part played by Richard I. in deciding the question of the succession during the Third Crusade.

<sup>3</sup> The taxation levied in the West was also attempted in the East, and in 1183 a universal tax was levied in the kingdom of Jerusalem, at the rate of 1% on movables and 2% on rents and revenues. Cf. Dr A. Cartellieri, *Philipp II. August*, ii. pp. 3-18 and p. 85.

of Amalric I., carried to her husband—a French adventurer—a presumptive title to the crown, which would never be admitted without dispute. In 1186 Guy eventually became king, after the death of Baldwin V. (Sibylla's son by her first marriage); but his coronation was in violation of the promise given to Raymund of Tripoli (that in the event of the death of Baldwin V. without issue the succession should be determined by the pope, the emperor and the kings of France and England), and Guy, with a weak title, was unable to exercise any real control over the kingdom. At this point another French adventurer, who had already made himself somewhat of a name in Antioch, gave the final blow to the kingdom. Raynald of Chatillon, the second husband of Constance of Antioch, after languishing in captivity from 1159 to 1176, had been granted the seignory of Krak, to the east and south of the Dead Sea. From this point of vantage he began depredations on the Red Sea (1182), building a fleet, and seeking to attack Medina and Mecca—a policy which may be interpreted either as mere buccaneering, or as a calculated attempt to deal a blow at Mahommedanism in its very centre. Driven from the Red Sea by Saladin, he turned from buccaneering to brigandage, and infested the great trade-route from Damascus to Egypt, which passed close by his seignory. In 1186 he attacked a caravan in which the sister of Saladin was travelling, thus violating a four years' truce, which, after some two years' skirmishing, Saladin and Raymund of Tripoli had made in the previous year owing to the general prevalence of famine.<sup>4</sup> The coronation of one French adventurer and the conduct of another, whom the first was unable to control, meant the ruin of the kingdom; and Saladin at last delivered in full force his long-deferred attack. The Crusade was now at last answered by the counter-Crusade—the *jihad*; for though for many years past Saladin had, in his attempt to acquire all the inheritance of Nureddin, left Palestine unmenaced and intact, his ultimate aim was always the holy war and the recovery of Jerusalem. The acquisition of Aleppo could only make that supreme object more readily attainable; and so Saladin had spent his time in acquiring Aleppo, but only in order that he might ultimately "attain the goal of his desires, and set the mosque of Asha free, to which Allah once led in the night his servant Mahomet." Thus it was on a kingdom of crusaders who had lost the crusading spirit that a new Crusade swept down; and Saladin's army in 1187 had the spirit and the fire of the Latin crusaders of 1099. The tables were turned; and fighting on their own soil for the recovery of what was to them too a holy place, the Mahommedans easily carried the day. At Tiberias a little squadron of the brethren of the two Orders went down before Saladin's cavalry in May; at Hattin the levy *en masse* of the kingdom, some 20,000 strong, foolishly marching over a sandy plain under the heat of a July sun, was utterly defeated; and after a fortnight's siege Jerusalem capitulated (October 2nd, 1187). In the kingdom itself nothing was left to the Latins by the end of 1189 except the city of Tyre; and to the north of the kingdom they only held Antioch and Tripoli, with the Hospitallers' fortress at Margat. The fingers of the clock had been pushed back; once more things were as they had been at the time of the First Crusade; once more the West must arm itself for the holy war and the recovery of Jerusalem—but now it must face a united Mahommedan world, where in 1096 it had found political and religious dissension, and it must attempt its vastly heavier task without the morning freshness of a new religious impulse, and with something of the weariness of a hundred years of struggle upon its shoulders.

7. *The Forty Years' Crusade for the Recovery of Jerusalem, 1189-1229.*—The forty years from 1189 to 1229 form a period of incessant crusading, occupied by Crusades of every kind. There are the Third, Fifth and Sixth Crusades against the "infidel" Mahommedans encamped in the Holy Land; there is the Albigensian Crusade against the heretic Cathars; there is the Fourth Crusade, directed in the issue against the schismatic

<sup>4</sup> Stevenson argues (*op. cit.* p. 240) that this truce was already practically dissolved before Raynald struck, and that Raynald's "action may reasonably be viewed as the practical outcome of the feeling of a party."

Greeks; lastly, there are the Crusades waged by the papacy against revolted Christians—John of England and Frederick II. Our concern lies with the first kind of Crusade, and with the other three only so far as they bear on the first, and as they illustrate the immense widening which the term "Crusade" now underwent—a widening accompanied by its inevitable corollary of shallowness of motive and degradation of impulse.

*The Third Crusade, 1189-1192.*—Conrad of Montferrat was, as much as any one man, responsible for the Third Crusade. Compelled to leave the court of Constantinople, which he had been serving, he had sailed for the Holy Land and reached Tyre about three weeks after the battle of Hattin. He had saved Tyre; and from it he sent his appeals to the West. Not the least effective of these appeals was a great poster which he had circulated in Europe, and which represented the Holy Sepulchre defiled by the horses of the Mahommedans. Meanwhile the papacy, as soon as the news reached Rome, despatched encyclicals throughout Europe; and soon a new Crusade was in full swing. But the Third Crusade, unlike the First, does not spring from the papacy, which was passing through one of its epochs of depression; it springs from the lay power, which, represented by the three strong monarchies of Germany, England and France, was at this time dominant in Europe. In Germany it was the solemn national diet of Mainz (Easter 1188) which "swore the expedition" to the Holy Land; in France and England the agreement of the two kings decided upon a joint Crusade. The very means which Philip Augustus and Henry II. took, in order to further the Crusade, show its lay aspect. A scheme of taxation—the Saladin tithe—was imposed on all who did not take the cross; and this taxation, while on the one hand it drove many to take the cross in order to escape its incidence, on the other hand provided a necessary financial basis for military operations.<sup>1</sup> The lay basis of the Third Crusade made it, in one sense, the greatest of all Crusades, in which all the three great monarchs of western Europe participated; but it also made it a failure, for the kings of France and England, changing *caelum, non animum*, carried their political rivalries into the movement, in which it had been agreed that they should be sunk. Spiritually, therefore, the Third Crusade is inferior to the First, however imposing it may be in its material aspects. Yet it must be admitted that the idea of a spiritual regeneration accompanied the crusading movement of 1188. Europe had sinned in the face of God; otherwise Jerusalem would never have fallen; and the idea of a spiritual reform from within, as the necessary corollary and accompaniment of the expedition of Christianity without, breathes in some of the papal letters, just as, during the conciliar movement, the *causa reformationis* was blended with the *causa unionis*.

We may conceive of the Third Crusade under the figure of a number of converging lines, all seeking to reach a common centre. That centre is Acre. The siege of Acre, as arduous and heroic in many of its episodes as the siege of Troy, had been begun in the summer of 1189 by Guy de Lusignan, who, captured by Saladin at the battle of Hattin, and released on parole, had at once broken his word and returned to the attack. The army which was besieging Acre was soon joined by various contingents; for Acre, after all, was the vital point, and its capture would open the way to Jerusalem. Two of these contingents alone concern us here—the German and the Anglo-French. Frederick I. of Germany, using a diplomacy which corresponds to the lay character of the Third Crusade, had sought to prepare his way by embassies to the king of Hungary, the Eastern emperor and the sultan of Iconium. Starting from Regensburg in May 1189, the German army marched quietly through Hungary; but difficulties arose, as they had arisen in 1147, as soon as the frontiers of the Eastern empire were reached. The emperor Isaac Angelus had not only the old grudge of all Eastern

<sup>1</sup> The "economic" motive for taking the cross was strengthened by the papal regulations in favour of debtors who joined the Crusade. Thousands must have joined the Third Crusade in order to escape paying either their taxes or the interest on their debts; and the atmosphere of the gold-digger's camp (or of the cave of Adullam) must have begun more than ever to characterize the crusading armies.

emperors against the "upstart" emperor of the West; he had also allied himself with Saladin, in order to acquire for his empire the patronage of the Holy Places and religious supremacy in the Levant. The difficulties between Frederick and Isaac Angelus became acute: in November 1189 Frederick wrote to his son Henry, asking him to induce the pope to preach a Crusade against the schismatic Greeks. But terms were at last arranged, and by the end of March 1190 the Germans had all crossed to the shores of Asia Minor. Taking a route midway between the eastern route of the crusaders of 1097 and the westerly route of Louis VII. in 1148, Frederick marched by Philadelphia and Iconium, not without dust and heat, until he reached the river Salof, in Armenian territory. Here, with the burden of the day now past, the fine old crusader—he had joined before in the Second Crusade, forty years ago—perished by accident in the river; and of all his fine army only a thousand men won their way through, under his son, Frederick of Swabia, to join the ranks before Acre (October 1190). The Anglo-French detachment achieved a far greater immediate success. War had indeed disturbed the original agreement of Gisors between Philip Augustus and Henry II., but a new agreement was made between Henry's successor, Richard I., and the French king at Nonancourt (December 1189), by which the two monarchs were to meet at Vezelay next year, and then follow the sea route to the Holy Land together. They met, and by different routes they both reached Sicily, where they wintered together (1190-1191). The enforced inactivity of a whole winter was the mother of disputes and bad blood; and when Philip sailed for the Holy Land, at the end of March 1191, the failure of the Crusade was already decided. Richard soon followed; but while Philip sailed straight for Acre, Richard occupied himself by the way in conquering Cyprus—partly out of knight-errantry, and in order to avenge an insult offered to his betrothed wife Berengaria by the despot of the island, partly perhaps out of policy, and in order to provide a basis of supplies and of operations for the armies attempting to recover Palestine. In any case, he is the founder of the Latin kingdom of Cyprus (for he afterwards sold his new acquisition to Guy de Lusignan, who established a dynasty in the island); and thereby he made possible the survival of the institutions and assizes of Jerusalem, which were continued in Cyprus until it was conquered by the Ottoman Turks. From Cyprus Richard sailed to Acre, arriving on the 8th of June, and in little more than a month he was able, in virtue of the large reinforcements he brought, and in spite of dissensions in the Christian camp which he helped to foment, to bring the two years' siege to a successful issue (July 12th, 1191). It was indeed time; the privations of the besiegers during the previous winter had been terrible; and the position of affairs had only been made worse by the dissensions between Guy de Lusignan and Conrad of Montferrat, who had begun to claim the crown in return for his services, and had, on the death of Sibylla, the wife of Guy, reinforced his claim by a marriage with her younger sister, Isabella. In these dissensions it was inevitable that Philip Augustus and Richard I., already discordant, should take contrary sides; and while Richard naturally sided with Guy de Lusignan, who came from his own county of Poitou, Philip as naturally sided with Conrad. At the end of July it was decided that Guy should remain king for his life, and Conrad should be his successor; but as three days afterwards Philip Augustus began his return to France (pleading ill-health, but in reality eager to gain possession of Flanders), the settlement availed little for the success of the Crusade. Richard stayed in the Holy Land for another year, during which he won a battle at Arsuf and refortified Jaffa. But far more important than any hostilities are the negotiations which, for the whole year, Richard conducted with Saladin. They show the lay aspect of the Third Crusade; they anticipate the Crusade of Frederick II.—for Richard was attempting to secure the same concessions which Frederick secured by the same means which he used. They show again the closer approximation and better understanding with the Mahommedans, which marks this Crusade. Nothing is more striking in these

respects than Richard's proposal that Saladin's brother should marry his own sister Johanna and receive Jerusalem and the contiguous towns on the coast. In the event, a peace was made for three years (September 2nd, 1192), by which Lydda and Ramlah were to be equally divided, Ascalon was to be destroyed, and small bodies of crusaders were to be allowed to visit the Holy Sepulchre. Meanwhile Conrad of Montferrat, at the very instant when his superior ability had finally forced Richard to recognize him as king, had been assassinated (April 1192): Guy de Lusignan had bought Cyprus from Richard, and had sailed away to establish himself there;<sup>1</sup> and Henry of Champagne, Richard's nephew, had been called to the throne of Jerusalem, and had given himself a title by marrying Conrad's widow, Isabella. In this condition Richard left the Holy Land, when he began his eventful return, in October 1192. The Crusade had failed—failed because a leaderless army, torn by political dissensions and fighting on a foreign soil, could not succeed against forces united by religious zeal under the banner of a leader like Saladin. Yet it had at any rate saved for the Christians the principality of Antioch, the county of Tripoli, and some of the coast towns of the kingdom;<sup>2</sup> and if it had failed to accomplish its object, it had left behind, none the less, many important results. The difficulties which had arisen between Isaac Angelus and Frederick Barbarossa contain the germs of the Fourth Crusade; the negotiations between Richard and Saladin contain the germs of the Sixth. National rivalries had been accentuated and national differences brought into prominence by the meeting of the nations in a common enterprise; while, on the other hand, Mahomedans and Christians had fraternized as they had never done before during the progress of a Crusade. But what the Third Crusade showed most clearly was that the crusading movement was being lost to the papacy, and becoming part of the demesne of the secular state—organized by the state on its own basis of taxation, and conducted by the state according to its own method of negotiation. This after all is the great change; and even the genius of an Innocent III. "could not make undone what had once been done." On the

<sup>1</sup> The Crusades in their course established a number of new states or kingdoms. The First Crusade established the kingdom of Jerusalem (1100); the Third, the kingdom of Cyprus (1195); the Fourth, the Latin empire of Constantinople (1204); while the long Crusade of the Teutonic knights on the coast of the Baltic led to the rise of a new state east of the Vistula. The kingdom of Lesser Armenia, established in 1195, may also be regarded as a result of the Crusades. The history of the kingdom of Jerusalem is part of the history of the Crusades: the history of the other kingdoms or states touches the history of the Crusades less vitally. But the history of Cyprus is particularly important—and for two reasons. In the first place, Cyprus was a natural and excellent basis of operations; it sent provisions to the crusaders in 1191, and again at the siege of Damietta in 1219, while its advantages as a strategic basis were proved by the exploits of Peter of Cyprus in the 14th century. In the second place, as the Latin kingdom of Jerusalem fell, its institutions and assizes were transplanted bodily to Cyprus, where they survived until the island was conquered by the Ottoman Turks. But the monarchy was stronger in Cyprus than in Jerusalem: the fiefs were distributed by the monarch, and were smaller in extent; while the feudatories had neither the collective powers of the *haute cour* of Jerusalem, nor the individual privileges (such as jurisdiction over the bourgeoisie), which had been enjoyed by the feudatories of the old kingdom. Till 1489 the kingdom of Cyprus survived as an independent monarchy, and its capital, Famagusta, was an important centre of trade after the loss of the coast-towns in the kingdom of Jerusalem. In 1489 it was acquired by Venice, which claimed the island on the death of the last king, having adopted his widow (a Venetian lady named Catarina Cornaro) as a daughter of the republic. On the history of Cyprus, see Stubbs, *Lectures on Medieval and Modern History*, 156-208. The history of the kingdom of Armenia is closely connected with that of Cyprus. The Armenians in the south-east of Asia Minor borrowed feudal institutions from the Franks and the feudal vocabulary itself. The kingdom was involved in a struggle with Antioch in the early part of the 13th century. Later, it allied itself with the Mongols and fought against the Mamelukes, to whom, however, it finally succumbed in 1375.

<sup>2</sup> The kingdom of Jerusalem is thus from 1192 to its final fall a strip of coast, to which it is the object of kings and crusaders to annex Jerusalem and a line of communication connecting it with the coast. This was practically the aim of Richard I.'s negotiations; and this was what Frederick II. for a time secured.

contrary, the thing once done would go further; and the state would take up the name of Crusade in order to cover, and under such cover to achieve, its own objects and ambitions, as in the future it was destined again and again to do.

*The Fourth Crusade, 1202-1204.*—The history of the Fourth Crusade is a history of the predominance of the lay motive, of the attempt of the papacy to escape from that predominance, and to establish its old direction of the Crusade, and of the complete failure of its attempt. Until the accession of Innocent III. in 1198 the lay motive was supreme; and its representative was Henry VI.—the greatest politician of his day, and in many ways the greatest emperor since Charlemagne. In 1195 Amalric, the brother of Guy de Lusignan, and his successor in Cyprus, sought the title of king from Henry and did homage; and at the same time Leo of Lesser Armenia, in order to escape from dependence on the Eastern empire, took the same course. Henry thus gained a basis in the Levant; while the death of Saladin in 1193, followed by a civil war between his brother, Malik-al-Adil, and his sons for the possession of his dominions, weakened the position of the Mahomedans. As emperor, Henry was eager to resume the imperial Crusade which had been stopped by his father's death; while both as Frederick's successor and as heir to the Norman kings of Sicily, who had again and again waged war against the Eastern empire, he had an account to settle with the rulers of Constantinople. The project of a Crusade and of an attack on Constantinople wove themselves into a single thread, in a way which very definitely anticipates the Fourth Crusade of 1202-1204. In 1195 Henry took the cross; some time before, he had already sent to Isaac Angelus to demand compensation for the injuries done to Frederick I., along with the cession of all territories ever conquered by the Norman kings of Sicily, and a fleet to co-operate with the new Crusade. In the same year, however, Isaac was dethroned by his brother, Alexius III.; but Henry married Isaac's daughter Irene to his brother, Philip of Swabia, and thus attempted to give the Hohenstaufen a new title and a valid claim against the usurper Alexius. Thus armed he pushed forward the preparations for the Crusade in Germany—a Crusade whose first object would have been an attack on Alexius III.; but in the middle of his preparations he died in Sicily in the autumn of 1197, and the Crusade collapsed. Some results were, however, achieved by a body of German crusaders which had sailed in advance of Henry; by its influence Amalric of Cyprus succeeded Henry of Champagne, who died in 1197, as king of Jerusalem, and a vassal of the emperor thus became ruler in the Holy Land; while the Teutonic order, which had begun as a hospital during the siege of Acre (1190-1191), now received its organization. Some of the coast towns, too, were recovered by the German crusaders, especially Beirut; and in 1198 the new king Amalric II. was able to make a truce with Malik-al-Adil for the next five years.

"The true heir of Henry VI.," Ranke has said, "is Innocent III.," and nowhere is this more true than in respect of the crusading movement. Throughout the course of his crowded and magnificent pontificate, Innocent III. made the Crusade his ultimate object, and attempted to bring it back to its old religious basis and under its old papal direction. By the spring of 1200, owing to Innocent's exertions, a new Crusade was in full progress, especially in France, where Fulk of Neuilly played the part once played by Peter the Hermit. Like the First Crusade, the Fourth Crusade also—in its personnel, but not its direction—was a French enterprise; and its leading members were French feudatories like Theobald of Champagne (who was chosen leader of the Crusade), Baldwin of Flanders (the future emperor of Constantinople), and the count of Blois. The objective, which these three original chiefs of the Fourth Crusade proposed to themselves, was Egypt.<sup>3</sup> Since 1163 the importance of acquiring Egypt had, as we have seen, been definitely understood, and

<sup>3</sup> M. Luchaire, in the volume of his biography of Innocent III. called *La Question d'Orient*, shows how, in spite of the pope, the Fourth Crusade was in its very beginnings a lay enterprise. The crusading barons of France chose their own leader, and determined their own route, without consulting Innocent.

in the summer of 1192 Richard I. had been advised by his counsellors that Cairo and not Jerusalem was the true point of attack; while in 1200 there was the additional reason for preferring an attack on Egypt, that the truce in the Holy Land between Amalric II. and Malik-al-Adil had still three years to run. It is Egypt therefore—to which, it must be remembered, the centre of Mahommedan power had now been virtually shifted, and to which motives of trade impelled the Italian towns (since from it they could easily reach the Red Sea, and the commerce of the Indian Ocean)—it is Egypt which is henceforth the normal goal of the Crusades. This is one of the many facts which differentiate the Crusades of the 13th from those of the preceding century. But, with Syria in the hands of the Mahommedans, the attack on Egypt must necessarily be directed by sea; and thus the Crusade henceforth becomes—what the Third Crusade, here as elsewhere the turning-point in crusading history, had already in part been—a maritime enterprise. Accordingly, early in 1201, envoys from each of the three chiefs of the Fourth Crusade (among whom was Villehardouin, the historian of the Crusade) came to Venice to negotiate for a passage to Egypt. An agreement was made between the doge and the envoys, by which transport and active help were to be given by Venice in return for 85,000 marks and the cession of half of the conquests made by the crusaders. But the Fourth Crusade was not to be plain sailing to Egypt. It became involved in a maelstrom of conflicting political motives, by which it was swept to Constantinople. Here we must distinguish between cause and occasion. There were three great causes which made for an attack on Constantinople by the West. There was first of all the old crusading grudge against the Eastern empire, and its fatal policy of regarding the whole of the Levant as its lost provinces, to be restored as soon as conquered, or at any rate held in fee, by the Western crusaders—a policy which led the Eastern emperors either to give niggardly aid or to pursue obstructive tactics, and caused them to be blamed for the failure of the Crusades in 1101, and 1149, and in 1190. It is significant of the final result of these things that already in 1147 Roger of Sicily, engaged in war with Manuel, had proposed the sea-route for the Second Crusade, perhaps with some intention of diverting it against Constantinople; and in the winter of 1189–1190 Barbarossa, as we have seen, had actually thought and spoken of an attack on Constantinople. In the second place, there was the commercial grudge of Venice, which had only been given large privileges by the Eastern empire to desire still larger, and had, moreover, been annoyed not only by alterations or revocations of those privileges, such as the usurper Alexius III. had but recently attempted, but also by the temporary destruction of their colony in Constantinople in 1171. Lastly, and perhaps most of all, there is the old Norman blood-feud with Constantinople, as old as the old Norse seeking for Micklegarth, and keen and deadly ever since the Norman conquest of the Greek themes in South Italy (1041 onwards). The heirs of the Norman kings were the Hohenstaufen; and we have already seen Henry VI. planning a Crusade which would primarily have been directed against Constantinople. It is this Hohenstaufen policy which becomes the primary occasion of the diversion of the Fourth Crusade. Philip of Swabia, engaged in a struggle with the papacy, found Innocent III. planning a Guelph Crusade, which should be under the direction of the church; and to this Guelph project he opposed the Ghibelline plan of Henry VI., with such success that he transmuted the Fourth Crusade into a political expedition against Constantinople. To such a policy of transmutation he was urged by two things. On the one hand, the death of the count of Champagne (May 1201) had induced the crusaders to elect as their leader Boniface of Montferrat, the brother of Conrad; and Boniface was the cousin of Philip, and interested in Constantinople, where not only Conrad, but another brother as well, had served, and suffered for their service at the hands of their masters. On the other hand Alexius, the son of the dethroned Isaac Angelus, was related to Philip through his marriage with Irene; and Alexius had escaped to the German court to urge

the restoration of his father. On Christmas day 1201, Philip, Alexius and Boniface all met at Hagenau<sup>1</sup> and formulated (one may suppose) a plan for the diversion of the Crusade. Events played into their hands. When the crusaders gathered at Venice in the autumn of 1202, it was found impossible to get together the 85,000 marks promised to Venice. The Venetians—already, perhaps, indoctrinated in the Hohenstaufen plan—indicated to the leaders a way of meeting the difficulty: they had only to lend their services to the republic for certain ends which it desired to compass, and the debt was settled. The conquest of Zara, a port on the Adriatic claimed by the Venetians from the king of Hungary, was the only object overtly mentioned; but the idea of the expedition to Constantinople was in the air, and the crusaders knew what was ultimately expected. It took time and effort to bring them round to the diversion: the pope—naturally enough—set his face sternly against the project, the more as the usurper, Alexius III., was in negotiation with him in order to win his support against the Hohenstaufen, and Innocent hoped to find, as Alexius promised, a support and a reinforcement for the Crusade in an alliance with the Greek empire. But they came round none the less, in spite of Innocent's renewed prohibitions. In November 1202 Zara was taken; and at Zara the fatal decision was made. The young Alexius joined the army; and in spite of the opposition of stern crusaders like Simon de Montfort, who sailed away ultimately to Palestine, he succeeded by large promises in inducing the army to follow in his train to Constantinople. By the middle of July 1203 Constantinople was reached, the usurper was in flight, and Isaac Angelus was restored to his throne. But when the time came for Alexius to fulfil his promises, the difficulty which had arisen at Venice in the autumn of 1202 repeated itself. Alexius's resources were insufficient, and he had to beg the crusaders to wait at Constantinople for a year in order that he might have time. They waited; but the closer contact of a prolonged stay only brought into fuller play the essential antipathy of the Greek and the Latin. Continual friction developed at last into the open fire of war; and in March 1204 the crusaders resolved to storm Constantinople, and to divide among themselves the Eastern empire. In April Constantinople was captured; in May Baldwin of Flanders became the first Latin emperor of Constantinople. Venice had her own reward; a Venetian, Thomas Morosini, became patriarch; and the doge of Venice added "a quarter and a half" of the Eastern empire—chiefly the coasts and the islands—to the sphere of his sway. If Venetian cupidity had not originally deflected the Crusade (and it was the view of contemporary writers that Venice had committed her first treason against Christianity by diverting the Crusade from Egypt in order to get commercial concessions from Malik-al-Adil,<sup>2</sup> yet it had at any rate profited exceedingly from that deflection; and the Hohenstaufen and their protégé Alexius only reaped dust and ashes. For, however Ghibelline might be the original intention, the result was not commensurate with the subtlety of the design, and the power of the pope was rather increased than diminished by the event of the Crusade. The crusaders appealed to Innocent to ratify the subjugation of a schismatic people, and the union of the Eastern and Western Churches; and Innocent, dazzled by the magic of the *fait accompli*, not unwillingly acquiesced. He might soothe himself by reflecting that the basis for the Crusade, which he had hoped to find in Alexius III., was still more securely offered by Baldwin; he could not but feel with pride that he had become "as it were pope and apostolicus of a second world." Yet the result of the Fourth Crusade was on the whole disastrous both for the papacy and for the crusading movement. The pope had been forced to

<sup>1</sup> As a matter of fact, there is some doubt whether Alexius arrived in Germany before the spring of 1202. But there seems to be little doubt of Philip's complicity in the diversion of the Fourth Crusade to Constantinople (cf. M. Luchaire, *La Question d'Orient*, pp. 84–86).

<sup>2</sup> It is true that in 1208 Venice received commercial concessions from the court of Cairo. But this *ex post facto* argument is the sole proof of this view; and it is quite insufficient to prove the accusation. Venice is *not* the primary agent in the deflection of the Fourth Crusade.



see the helm of the Crusades wrenched from his grasp; and the Albigensian Crusade against the heretics of southern France was soon afterwards to show that the example could be followed, and that the land-hunger of the north French baronage could exploit a Crusade as successfully as ever did Hohenstaufen policy leagued with Venetian cupidity. The Crusade lost its *elan* when it became a move in a political game. If the Third Crusade had been directed by the lay power towards the true spiritual end of all Crusades, the Fourth was directed by the lay power to its own lay ends; and the political and commercial motives, which were deeply implicit even in the First Crusade, had now become dominantly explicit. In a simpler and more immediate sense, the capture of Constantinople was detrimental to the movement from which it sprang. The precarious empire which had been founded in 1204 drained away all the vigorous adventurers of the West for its support for many years to come, and the Holy Land was starved to feed a land less holy, but equally greedy of men.<sup>1</sup> No basis for the Crusades was ever to be found in the Latin empire of the East; and Innocent, after vainly hoping for the new Crusade which was to emerge from Constantinople, was by 1208 compelled to return to the old idea of a Crusade proceeding simply and immediately from the West to the East.

*The Fifth Crusade, 1218-1221.*—The glow and the glamour of the Crusades disappear save for the pathetic sunset splendours of St Louis, as Dandolo dies, and gallant Villehardouin drops his pen. But before St Louis sailed for Damietta there intervened the miserable failure of one Crusade, and the secular and diplomatic success of another. The Fifth Crusade is the last which is started in that pontificate of Crusades—the pontificate of Innocent III. It owed its origin to his feverish zeal for the recovery of Jerusalem, rather than to any pressing need in the Holy Land. Here there reigned, during the forty years of the loss of Jerusalem, an almost unbroken peace. Malik-al-Adil, the brother of Saladin, had by 1200 succeeded to his brother's possessions not only in Egypt but also in Syria, and he granted the Christians a series of truces (1198-1203, 1204-1210, 1211-1217). While the Holy Land was thus at peace, crusaders were also being drawn elsewhere by the needs of the Latin empire of Constantinople, or the attractions of the Albigensian Crusade.<sup>2</sup> But Innocent could never consent to forget Jerusalem, as long as his right hand retained its cunning. The pathos of the Children's Crusade of 1212 only nerved him to fresh efforts. A shepherd boy named Stephen had appeared in France, and had induced thousands to follow his guidance: with his boyish army he rode on a wagon southward to Marseilles, promising to lead his followers dry-shod through the seas. In Germany a child from Cologne, named Nicolas, gathered some 20,000 young crusaders by the like promises, and led them into Italy. Stephen's army was kidnapped by slave-dealers and sold into Egypt; while Nicolas's expedition left nothing behind it but an after-echo in the legend of the Pied Piper of Hamelin. But for Innocent these outbursts of the revivalist element, which always accompanied the Crusades, had their moral: "the very children put us to shame," he wrote; "while we sleep

<sup>1</sup> Already under Innocent III. the benefits of the Crusade were promised to those who went to the assistance of the Latin empire of the East.

<sup>2</sup> In 1208 Innocent excommunicated Raymund VI. of Toulouse on account of the murder of a papal legate who was attempting to suppress Manichaeism, and offered all Catholics the right to occupy and guard his territories. Thus was begun the First Crusade against heresy. Raymund at once submitted to the pope, but the Crusade continued none the less, because, as Luchaire says, "the baronage of the north and centre of France had finished their preparations," and were resolved to annex the rich lands of the south. In this way land-hunger exploited the Albigensian, as political and commercial motives had helped to exploit the Fourth Crusade; and in the former, as in the latter, Innocent had reluctantly to consent to the results of the secular motives which had infected a spiritual enterprise. The Albigensian Crusades, however, belong to French history; and it can only be noted here that their ultimate result was the absorption of the fertile lands, and the extinction of the peculiar civilization, of southern France by the northern monarchy. (See the article ALBIGENSES.)

they go forth gladly to conquer the Holy Land." In the fourth Lateran council of 1215 Innocent found his opportunity to rekindle the flickering fires. Before this great gathering of all Christian Europe he proclaimed a Crusade for the year 1217, and in common deliberation it was resolved that a truce of God should reign for the next four years, while for the same time all trade with the Levant should cease. Here were two things attempted—neither, indeed, for the first time<sup>3</sup>—which 14th century pamphleteers on the subject of the Crusades unanimously advocate as the necessary conditions of success; there was to be peace in Europe and a commercial war with Egypt. This statesmanlike beginning of a Crusade, preached, as no Crusade had ever been preached before, in a general council of all Europe, presaged well for its success. In Germany (where Frederick II. himself took the cross in this same year) a large body of crusaders gathered together: in 1217 the south-east sent the duke of Austria and the king of Hungary to the Holy Land; while in 1218 an army from the north-west joined at Acre the forces of the previous year. Egypt had already been indicated by Innocent III. in 1215 as the goal of attack, and it was accordingly resolved to begin the Crusade by the siege of Damietta, on the eastern delta of the Nile. The original leader of the Crusade was John of Brienne, king of Jerusalem (who had succeeded Amalric II., marrying Maria, the daughter of Amalric's wife Isabella by her former husband, Conrad of Montferrat); but after the end of 1218 the cardinal legate Pelagius, fortified by papal letters, claimed the command. In spite of dissensions between the cardinal and the king, and in spite of the offers of Malik-al-Kamil (who succeeded Malik-al-Adil at the end of 1218), the crusaders finally carried the siege to a successful conclusion by the end of 1219. The capture of Damietta was a considerable feat of arms, but nothing was done to clinch the advantage which had been won, and the whole of the year 1220 was spent by the crusaders in Damietta, partly in consolidating their immediate position, and partly in waiting for the arrival of Frederick II., who had promised to appear in 1221. In 1221 Hermann of Salza, the master of the Teutonic order, along with the duke of Bavaria, appeared in the camp before Damietta; and as it seemed useless to wait any longer for Frederick II.,<sup>4</sup> the cardinal, in spite of the opposition of King John, gave the signal for the march on Cairo. The army reached a fortress (erected by the sultan in 1219 (afterwards, from 1221, the town of Mansura), and encamped there at the end of July. Here the sultan reiterated terms which he had already offered several times before—the cession of most of the kingdom of Jerusalem, the surrender of the cross (captured by Saladin in 1187), and the restoration of all prisoners. King John urged the acceptance of these terms. The legate insisted on a large indemnity in addition: the negotiations failed, and the sultan prepared for war. The crusaders were driven back towards Damietta; and at the end of August 1221 Pelagius had to make a treaty with Malik-al-Kamil, by which he gained a free retreat and the surrender of the Holy Cross at the price of the restoration of Damietta. The treaty was to last for eight years, and could only be broken on the coming of a king or emperor to the East. In pursuance of its terms the crusaders evacuated Egypt, and the Fifth Crusade was at an end. It is difficult to decide whether to blame the legate or the emperor more for its failure. If Frederick had only come in person, a single month of his presence might have meant everything: if Pelagius had only listened to King John, the sultan was ready to concede practically everything which was at issue. Unhappily Frederick preferred to put his Sicilian house in order, and the legate preferred to listen to the Italians, who had their own

<sup>3</sup> A canon of the third Lateran council (1179) forbade traffic with the Saracens in munitions of war; and this canon had been renewed by Innocent in the beginning of his pontificate.

<sup>4</sup> He had promised the pope, at his coronation in 1220, to begin his Crusade in August 1221. But he declared himself exhausted by the expenses of his coronation; and Honorius III. consented to defer his Crusade until March 1222. The letter of the pope informing Pelagius of this delay is dated the 20th of June: it would probably reach his hands after his departure from Damietta; and thus the Cardinal gave the signal for the march, when, as he thought, the emperor's coming was imminent.

commercial reasons for wishing to establish a strong position in Egypt, and to the Templars and Hospitallers, who did not feel satisfied by the terms offered by the sultan, because he wished to retain in his hands the two fortresses of Krak and Monreal.

*The Sixth Crusade* (1228-1229) succeeded as signally as the Fifth Crusade had failed; but the circumstances under which it took place and the means by which it was conducted made its success still more disastrous than the failure of 1221. The last Crusade had, after all, been under papal control: if Richard I. had directed the Third Crusade, and the policy of the Hohenstaufen and the Venetians had directed the Fourth, it was a papal legate who had steered the Fifth to its ultimate fate. The Crusade of Frederick II. in 1228-1229 finds its analogy in the projected Crusade of Henry VI.; it is essentially lay. It is unique in the annals of the Crusades. Alone of all Crusades (though the Fourth Crusade offers some analogy) it was not blessed but cursed by the papacy: alone of all the Crusades it was conducted without a single act of hostility against the Mahommedan. St Louis, the true type of the religious crusader, once said that a layman ought only to argue with a blasphemer against Christian law by running his sword into the bowels of the blasphemer as far as it would go:<sup>1</sup> Frederick II. talked amicably with all unbelievers, if one may trust Arabic accounts, and he achieved by mere negotiation the recovery of Jerusalem, for which men had vainly striven with the sword for the forty years since 1187. It was in 1215 that the leader of this strange Crusade had first taken the vow; it was twelve years afterwards when he finally attempted to carry the vow into effective execution. Again and again he had excused himself to the pope, and been excused by the pope, because the exigencies of his policy in Germany or Sicily tied his hands. After the failure of the Fifth Crusade—for which these delays were in part responsible—Honorius III. had attempted to bind him more intimately to the Holy Land by arranging a marriage with Isabella, the daughter of John of Brienne, and the heiress of the kingdom of Jerusalem. In 1225 Frederick married Isabella, and immediately after the marriage he assumed the title of king in right of his wife, and exacted homage from the vassals of the kingdom.<sup>2</sup> It was thus as king of Jerusalem that Frederick began his Crusade in the autumn of 1227. Scarcely, however, had he sailed from Brindisi when he fell sick of a fever which had been raging for some time among the ranks of his army, while they waited for the crossing. He sailed back to Otranto in order to recover his health, but the new pope, Gregory IX., launched in hot anger the bolt of excommunication, in the belief that Frederick was malingering once more. None the less the emperor sailed on his Crusade in the summer of 1228, affording to astonished Europe the spectacle of an excommunicated crusader, and leaving his territories to be invaded by papal soldiers, whom Gregory IX. professed to regard as crusaders against a non-Christian king, and for whom he accordingly levied a tithe from the churches of Europe. The paradox of Frederick's Crusade is indeed astonishing. Here was a crusader against whom a Crusade was proclaimed in his own territories; and when he arrived in the Holy Land he found little obedience and many insults from all but his own immediate followers. Yet by adroit use of his powers of diplomacy, and by playing upon the dissensions which raged between the descendants of Saladin's brother (Malik-al-Adil), he was able, without striking a blow, to conclude a treaty with the sultan of Egypt which gave him all that Richard I. had vainly attempted to secure by arduous fighting and patient negotiations. By the treaty of the 18th of February 1229, which was to last for ten years, the sultan conceded to Frederick, in addition to the coast towns already in the possession of the Christians, Nazareth, Bethlehem and Jerusalem, with a strip of territory connecting Jerusalem with the port of Acre. As king of Jerusalem Frederick was now able

to enter his capital: as one under excommunication, he had to see an interdict immediately fall on the city, and it was with his own hands—for no churchman could perform the office—that he had to take his crown from the altar of the church of the Sepulchre, and crown himself king of his new kingdom. He stayed in the Holy Land little more than a month after his coronation; and leaving in May he soon overcame the papal armies in Italy, and secured absolution from Gregory IX. (August 1229). By his treaty with the sultan he had secured for Christianity the last fifteen years of its possession of Jerusalem (1229-1244): no man since Frederick II. has ever recovered the holy places for the religion which holds them most holy. Yet the church might ask, with some justice, whether the means he had used were excused by the end which he had attained. After all, there was nothing of the holy war about the Sixth Crusade: there was simply huckstering, as in an Eastern bazaar, between a free-thinking, semi-oriental king of Sicily and an Egyptian sultan. It was indeed in the spirit of a king of Sicily, and not in the spirit—though it was in the rôle—of a king of Jerusalem, that Frederick had acted. It was from his Sicilian predecessors, who had made trade treaties with Egypt, that he had learned to make even the Crusade a matter of treaty. The Norman line of Sicilian kings might be extinct; their policy lived after them in their Hohenstaufen successors, and that policy, as it had helped to divert the Fourth Crusade to the old Norman objective of Constantinople, helped still more to give the Sixth Crusade its secular, diplomatic, non-religious aspect.

Forty years of struggle ended in fifteen years' possession of Jerusalem. During those fifteen years the kingdom of Jerusalem was agitated by a struggle between the native barons, championing the principle that sovereignty resided in the collective baronage, and taking their stand on the assizes, and Frederick II., claiming sovereignty for himself, and opposing to the assizes the feudal law of Sicily. It is a struggle between the king and the *haute cour*: it is a struggle between the aristocratic feudalism of the Franks and the monarchical feudalism of the Normans. Already in Cyprus, in the summer of 1228, Frederick II. had insisted on the right of wardship which he enjoyed as overlord of the island,<sup>3</sup> and he had appointed a commission of five barons to exercise his rights. In 1229 this commission was overthrown by John of Ibelin, lord of Beirut, against whom it had taken proceedings. John of Beirut, like many of the Cypriot barons, was also a baron of the kingdom of Jerusalem; and resistance in the one kingdom could only produce difficulties in the other. Difficulties quickly arose when Frederick, in 1231, sent Marshal Richard to Syria as his legate. This in itself was a serious matter; according to the assizes, the barons maintained, the king must either personally reside in the kingdom, or, in the event of his absence, be replaced by a regency. The position became more difficult, when the legate took steps against John of Beirut without any authorization from the high court. A gild was formed at Acre—the gild of St Adrian—which, if nominally religious in its origin, soon came to represent the political opposition to Frederick, as was significantly proved by its reception of the rebellious John of Beirut as a member (1232). The opposition was successful: by 1233 Frederick had lost all hold on Cyprus, and only retained Tyre in his own kingdom of Jerusalem. In 1236 he had to promise to recognize fully the laws of the kingdom: and when, in 1239, he was again excommunicated by Gregory IX., and a new quarrel of papacy and empire began, he soon lost the last vestiges of his power. Till 1243 the party of Frederick had been successful in retaining Tyre, and the baronial demand for a regency had remained without effect; but in that year the opposition, headed by the great family of Ibelin, succeeded, under cover of asserting the rights of Alice of Cyprus to the regency, in securing possession of Tyre, and the kingdom of Jerusalem thus fell back into the power of the baronage. The very next year (1244) Jerusalem was finally and for ever lost. Its loss was the natural corollary of these dissensions. The

<sup>3</sup> Amalric I. of Cyprus had done homage to Henry VI., from whom he had received the title of king (1195).

<sup>1</sup> Joinville, ch. x.

<sup>2</sup> John of Brienne had only ruled in right of his wife Mary. On her death (1212) John might be regarded as only ruling "by the courtesy of the kingdom" until her daughter Isabella was married, when the husband would succeed. That, at any rate, was the view Frederick II. took.

treaty of Frederick with Malik-al-Kamil (d. 1238) had now expired, and new succours and new measures were needed for the Holy Land. Theobald of Champagne had taken the cross as early as 1230, and 1239 he sailed to Acre in spite of the express prohibition of the pope, who, having quarrelled with Frederick II., was eager to divert any succour from Jerusalem itself, so long as Jerusalem belonged to his enemy. Theobald was followed (1240-1241) by Richard of Cornwall, the brother of Henry III., who, like his predecessor, had to sail in the teeth of papal prohibitions; but neither of the two achieved any permanent result, except the fortification of Ascalon. It was, however, by their own folly that the Franks lost Jerusalem in 1244. They consented to ally themselves with the ruler of Damascus against the sultan of Egypt; but in the battle of Gaza they were deserted by their allies and heavily defeated by Bibars, the Egyptian general and future Mameluke sultan of Egypt. Jerusalem, which had already been plundered and destroyed earlier in the year by Chorasmians (Khwarizmians), was the prize of victory, and Ascalon also fell in 1247.

8. *The Crusades of St Louis.*—As the loss of Jerusalem in 1187 produced the Third Crusade, so its loss in 1244 produced the Seventh: as the preaching of the Fifth Crusade had taken place in the Lateran council of 1215, so that of the Seventh Crusade began in the council of Lyons of 1245. But the preaching of the Crusade by Innocent IV. at Lyons was a curious thing. On the one hand he repeated the provisions of the Fourth Lateran council on behalf of the Crusade to the Holy Land; on the other hand he preached a Crusade against Frederick II., and promised to all who would join the full benefits of absolution and remission of sins. While the papacy thus bent its energies to the destruction of the Crusades in their genuine sense, and preferred to use for its own political objects what was meant for Jerusalem, a layman took up the derelict cause with all the religious zeal which any pope had ever displayed. Paradoxically enough, it was now the turn for the papacy to exploit the name of Crusade for political ends, as the laity had done before; and it was left to the laity to champion the spiritual meaning of the Crusade even against the papacy.<sup>1</sup> It was at the end of the year in which Jerusalem had fallen that St Louis had taken the cross, and by all the means in his power he attempted to ensure the success of his projected Crusade. He sought to mediate, though with no success, between the pope and the emperor; he descended to a whimsical piety, and took his courtiers by guile in distributing to them, at Christmas, clothing on which a cross had been secretly stitched. He started in 1248 with a gallant company, which contained his three brothers and the sieur de Joinville, his biographer; and after wintering in Cyprus he directed his army in the spring of 1249 against Egypt. The objective was unexpected: it may have been chosen by St Louis, because he knew how seriously the power of the sultan was undermined by the Mamelukes, who were in the very next year to depose the Ayyubite dynasty, which had reigned since 1171, and to substitute one of their number as sultan. Damietta was taken without a blow, and the march for Cairo was begun, as it had been begun by the legate Pelagius in 1221. Again the invading army halted before Mansura (December 1249); again it had to retreat. The

<sup>1</sup> It may be argued that the Crusade against a revolted Christian like Frederick II. was not misplaced, and that the pope had a true sense of religious values when he attacked Frederick. The answer is partly that men like St Louis *did* think that the Crusade was misplaced, and partly that Frederick was really attacked *not* as a revolted Christian, but as the would-be unifier of Italy, the enemy of the states of the church.

retreat became a rout. St Louis was captured, and a treaty was made by which he had to consent to evacuate Damietta and pay a ransom of 800,000 pieces of gold. Eventually St Louis was released on surrendering Damietta and paying one-half of his ransom, and by the middle of May 1250 he reached Acre, having abandoned the Egyptian expedition. For the next four years he stayed in the Holy Land, seeking to do what he could for the establishing of the kingdom of Jerusalem. He was able to do but little. The struggle of papacy and empire paralysed Europe, and even in France itself there were few ready to answer the calls for help which St Louis sent home from Acre. The one answer was the Shepherds' Crusade, or Crusade of the Pastoureaux—"a religious Jacquerie," as it has been called by Dean Milman. It had some of the features of the Children's Crusade of 1212. That, too, had begun with a shepherd boy: the leader of the Pastoureaux, like the leader of the children, promised to lead his followers dry-shod through the seas; and tradition even said that this leader, "the master of Hungary," as he was called, was the Stephen of the Children's Crusade. But the anti-clerical feeling and action of the Shepherds was new and ominous; and moved by its enormities the government suppressed the new movement ruthlessly. None came to the aid of St Louis; and in 1254, on the death of his mother Blanche, the regent, he had to return to France.

The final collapse of the kingdom of Jerusalem had been really determined by the battle of Gaza in 1244, and by the deposition of the Ayyubite dynasty by the Mamelukes. The Ayyubites had always been, on the whole, chivalrous and tolerant: Saladin and his successors, Malik-al-Adil and Malik-al-Kamil, had none of them shown an implacable enmity to the Christians. The Mamelukes, who are analogous to the janissaries of the Ottoman Turks, were made of sterner and more fanatical stuff; and Bibars, the greatest of these Mamelukes, who had commanded at Gaza in 1244, had been one of the leaders in 1250, and was destined to become sultan in 1260, was the sternest and most fanatical of them all. The Christians were, however, able to maintain a footing in Syria for forty years after St Louis' departure, not by reason of their own strength, but owing to two powers which checked the advance of the Mamelukes. The first of these was Damascus. The kingdom of Jerusalem, as we have seen, had profited by the alliance of Damascus as early as 1130, when the fear of the atabegs of Mosul had first drawn the two together; and when Damascus had been acquired by the rule of Mosul, the hostility between the house of Nureddin in Damascus and Saladin in Egypt had still for a time preserved the kingdom (from 1171 onwards). Saladin had united Egypt and Damascus; but after his death dissensions broke out among the members of his family,<sup>2</sup> which more than once led to wars between Damascus and Cairo. It has already been noticed that such a war between the sons of Malik-al-Adil accounts in large

<sup>2</sup> The following table of the Ayyubite rulers serves to illustrate the text:—

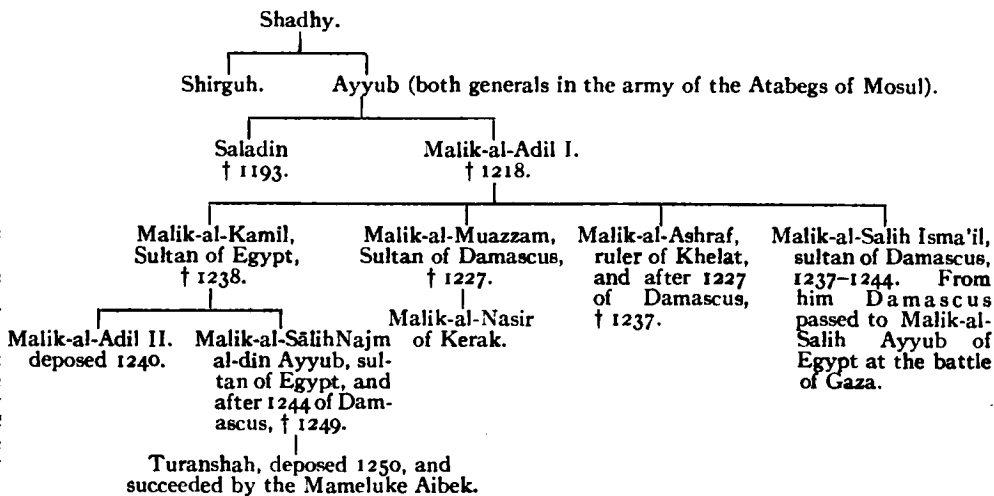

measure for the success of the Sixth Crusade; and it has been seen that the battle of Gaza was an act in the long drama of strife between Egypt and northern Syria. The revolution in Egypt in 1250 separated Damascus from Cairo more trenchantly than they had ever been separated since 1171: while a Mameluke ruled in Cairo, Malik-al-Nāsir of Aleppo was elected as sultan by the emirs of Damascus. But an entirely new and far more important factor in the affairs of the Levant was the extension of the empire of the Mongols during the 13th century. That empire had been founded by Jenghiz Khan in the first quarter of the century; it stretched from Peking on the east to the Euphrates and the Dnieper on the west. Two things gave the Mongols an influence on the history of the Holy Land and the fate of the Crusades. In the first place, the south-western division of the empire, comprising Persia and Armenia, and governed about 1250 by the Khan Hulaku or Hulagu, was inevitably brought into relations, which were naturally hostile, with the Mahomedan powers of Syria and Egypt. In the second place, the Mongols of the 13th century were not as yet, in any great numbers, Mahomedans; the official religion was "Shamanism," but in the Mongol army there were many Christians, the results of early Nestorian missions to the far East. This last fact in particular caused western Europe to dream of an alliance with the great khan "Prester John," who should aid in the reconquest of Jerusalem and the final conversion to Christianity of the whole continent of Asia. The Crusades thus widen out, towards their close, into a general scheme for the christianization of all the known world.<sup>1</sup> About 1220 James of Vitry was already hoping that 4000 knights would, with the assistance of the Mongols, recover Jerusalem; but it is in 1245 that the first definite sign of an alliance with the Mongols appears. In that year Innocent IV. sent a Franciscan friar, Joannes de Piano Carpini, to the Mongols of southern Russia, and despatched a Dominican mission to Persia. Nothing came of either of these missions; but through them Europe first began to know the interior of Asia, for Carpini was conducted by the Mongols as far as Karakorum, the capital of the great khan, on the borders of China. Again in 1252 St Louis (who had already begun to negotiate with the Mongols in the winter of 1248-1249) sent the friar William of Rubruquis to the court of the great khan; but again nothing came of the mission save an increase of geographical knowledge. It was in the year 1260 when it first seemed likely that any results definitely affecting the course of the Crusades would flow from the action of the Mongols. In that year Hulagu, the khan of Persia, invaded Syria and captured Damascus. His general, a Christian named Kitboga, marched southwards to attack the Mamelukes of Egypt, but he was beaten by Bibars (who in the same year became sultan of Egypt), and Damascus fell into the hands of the Mamelukes. Once more, in spite of Mongol intervention, Damascus and Cairo were united, as they had been united in the hands of Saladin; once more they were united in the hands of a devout Mahomedan, who was resolved to extirpate the Christians from Syria.

While these things were taking place around them, the Christians of the kingdom of Jerusalem only hastened their own fall by internal dissensions which repeated the history of the period preceding 1187. In part the war of Guelph and Ghibelline fought itself out in the East; and while one party demanded a regency, as in 1243, another argued for the recognition of Conrad, the son of Frederick II., as king. In part, again, a commercial war raged between Venice and Genoa, which attracted into its orbit all the various feuds and animosities of the Levant (1257). Beaten in the war, the Genoese avenged themselves for their defeat by an alliance with the Palaeologi, which led to the loss of Constantinople by the Latins (1261), and to the collapse of the Latin empire after sixty years of infirm and precarious existence. On a kingdom thus divided

<sup>1</sup> Though Europe indulged in dreams of Mongol aid, the eventual results of the extension of the Mongol Empire were prejudicial to the Latin East. The sultans of Egypt were stirred to fresh activity by the attacks of the Mongols; and as Syria became the battleground of the two, the Latin principalities of Syria were fated to fall as the prize of victory to one or other of the combatants.

against itself, and deprived of allies, the arm of Bibars soon fell with crushing weight. The sultan, who had risen from a Mongolian slave to become a second Saladin, and who combined the physique and audacity of a Danton with the tenacity and religiosity of a Philip II., dealt blow after blow to the Franks of the East. In 1265 fell Caesarea and Arsuf; in 1268 Antioch was taken, and the principality of Bohemund and Tancred ceased to exist.<sup>2</sup> In the years which followed on the loss of Antioch several attempts were made in the West to meet the progress of the new conqueror. In 1269 James the Conqueror of Aragon, at the bidding of the pope, turned from the long Spanish Crusade to a Crusade in the East in order to atone for his offences against the law matrimonial. An opportune storm, however, gave the king an excuse for returning home, as Frederick II. had done in 1227; and though his followers reached Acre, they hardly dared venture outside its walls, and returned home promptly in the beginning of 1270. More serious were the plans and the attempts of Charles of Anjou and Louis IX., in which the Crusades may be said to have finally ended, save for sundry disjointed epilogues in the 14th and 15th centuries.

Charles of Anjou had succeeded, as a result of the long "crusade" waged by the papacy against the Hohenstaufen from the council of Lyons to the battle of Tagliacozzo (1245-1268), in establishing himself in the kingdom of Sicily. With the kingdom of Frederick II. and Henry VI. he also took over their policy—the "forward" policy in the East which had also been followed by the old Norman kings. On the one hand he aimed at the conquest of Constantinople as Henry VI. had done before; and by the treaty of Viterbo of 1267 he secured from the last Latin emperor of the East, Baldwin II., a right of eventual succession. On the other hand, like Frederick II., he aimed at uniting the kingdom of Jerusalem with that of Sicily; and here, too, he was able to provide himself with a title. On the death of Conradin, Hugh of Cyprus had been recognized in the East as king of Jerusalem (1269); but his pretensions were opposed by Mary of Antioch, a granddaughter of Amalric II., who was prepared to bequeath her claims to Charles of Anjou, and was therefore naturally supported by him. But the policy of Charles, which thus prepared the way for a Crusade similar to those of 1197 and 1202, was crossed by that of his brother Louis IX. Already in 1267 St Louis had taken the cross a second time, moved by the news of Bibars' conquests; and though the French baronage, including even Joinville himself, refused to follow the lead of their king, Prince Edward of England imitated his example. Louis had been led to think that the bey of Tunis might be converted, and in that hope he resolved to begin this eighth and last of the Crusades by an expedition to Tunis. Charles, as anxious to attack Constantinople as he was reluctant to attack Tunis, with which Sicily had long had commercial relations, was forced to abandon his own plans and to join in those of his brother.<sup>3</sup> St Louis had barely landed in Tunis when he sickened and died, murmuring "Jerusalem, Jerusalem" (August 1270); but Charles, who appeared immediately after his brother's death, was able to conduct the Crusade to a successful conclusion. Negotiating in the spirit of a Frederick II., and acting not as a king of Sicily, he not only wrested a large indemnity from the bey for himself and the new king of France, but also secured a large annual tribute for his Sicilian exchequer. So ended the Eighth Crusade—much as the Sixth had done—to the profound disgust of many of the crusaders, including Prince Edward of England, who only arrived on the eve of the conclusion of the treaty. Baulked of any opportunity of joining in the main Crusade, Edward, after wintering in Sicily, conducted a Crusade of his own to Acre in the spring of 1271. For over a year he stayed in the Holy Land, making little sallies from Acre, and negotiating

<sup>2</sup> Of the four Latin principalities of the East, Edessa was the first to fall, being extinguished between 1144 and 1150. Antioch fell in 1268; Tripoli in 1289; and the kingdom itself may be said to end with the capture of Acre, 1291.

<sup>3</sup> Michael Palaeologus had actually appealed to Louis IX. against Charles of Anjou, who in 1270 had actively begun preparations for the attack on Constantinople.

with the Mongols, but achieving no permanent results. He returned home at the end of 1272, the last of the western crusaders; and thus all the attempts of St Louis and Charles of Anjou, of James of Aragon and Edward of England left Bibars still in possession of all his conquests.

Two projects of Crusades were started before the final expulsion of the Latins from Syria. In 1274, at the council of Lyons, Gregory X., who had been the companion of Edward in the Holy Land, preached the Crusade to an assembly which contained envoys from the Mongol khan and Michael Palaeologus as well as from many western princes. All the princes of western Europe took the cross; not only so, but Gregory was successful in uniting the Eastern and Western churches for the moment, and in securing for the new Crusade the aid of the Palaeologi, now thoroughly alarmed by the plans of Charles of Anjou. Thus was a papal Crusade begun, backed by an alliance with Constantinople, and thus were the plans of Charles of Anjou temporarily thwarted. But in 1276 Gregory X. died, and all his plans died with him; there was to be no union of the monarchs of the West with the emperor of the East in a common Crusade. Charles was able to resume his plans. In 1277 Mary of Antioch ceded to him her claims, and he was able to establish himself in Acre; in 1278 he took possession of the principality of Achaëa. With these bases at his disposal he began to prepare a new Crusade, to be directed primarily (like that of Henry VI. in 1197, and like his own projected Crusade of 1270) against Constantinople. Once more his plans were crossed finally and fatally: the Sicilian Vespers, and the coronation of Peter of Aragon as Sicilian king (1282), gave him troubles at home which occupied him for the rest of his days. This was the last serious attempt at a Crusade on behalf of the dying kingdom of Jerusalem which was made in the West; and its collapse was quickly followed by the final extinction of the kingdom. A precarious peace had reigned in the Holy Land since 1272, when Bibars had granted a truce of ten years; but the fall of the great power of Charles of Anjou set free Kalā'un the successor of Bibars' son (who reigned little more than two years), to complete the work of the great sultan. In 1289 Kalā'un took Tripoli, and the county of Tripoli was extinguished; in 1290 he died while preparing to besiege Acre, which was captured after a brave defence by his son and successor Khālil in 1291. Thus the kingdom of Jerusalem came to an end. The Franks evacuated Syria altogether, leaving behind them only the ruins of their castles to bear witness, to this very day, of the Crusades they had waged and the kingdom they had founded and lost.

9. *The Ghost of the Crusades.*—The loss of Acre failed to stimulate the powers of Europe to any new effort. France, always the natural home of the Crusades, was too fully occupied, first by war with England and then by a struggle with the papacy, to turn her energies towards the East. But it is often the case that theory develops as practice fails; and as the theory of the Holy Roman Empire was never more vigorous than in the days of its decrepitude, so it was with the Crusades. Particularly in the first quarter of the 14th century, writers were busy in explaining the causes of the failures of past Crusades, and in laying down the lines along which a new Crusade must proceed. Several causes are recognized by these writers as accounting for the failure of the Crusades. Some of them lay the blame on the papacy; and it is true that the papacy had contributed towards the decay of the Crusades when it had allowed its own particular interests to overbear the general welfare of Christianity, and had dignified with the name and the benefits of a Crusade its own political war against the Hohenstaufen. Others again find in the princes of Europe the authors of the ruin of the Crusades; they too had preferred their own national or dynastic interests to the cause of a common Christianity. They had indeed, as has been already noticed, done even more; they had used the name of Crusade, from the days of Henry VI. onwards, as a cover and an excuse for secular ambitions of their own; and in this way they had certainly helped, in very large measure, to discourage the old religious zeal for the Holy War. Other writers, again, blame the com-

mercial cupidity of the Italian towns; of what avail, they asked with no little justice, was the Crusade, when Venice and Genoa destroyed the naval bases necessary for its success by their internecine quarrels in the Levant (as in 1257), or—still worse—entered into commercial treaties with the common enemy against whom the Crusades were directed? On the very eve of the Fifth Crusade, Venice had concluded a commercial treaty with Malik-al-Kamil of Egypt; just before the fall of Acre the Genoese, the king of Aragon and the king of Sicily had all concluded advantageous treaties with the sultan Kalā'un. A fourth cause, on which many writers dwelt, particularly at the time when the suppression of the Templars was in question, was the dissensions between the two orders of Templars and Hospitallers, and the selfish policy of merely pursuing their own interest which was followed by both in common. But one might enumerate *ad infinitum* the causes of the failure of the Crusades. It is simplest, as it is truest, to say that the Crusades did not fail—they simply ceased; and they ceased because they were no longer in joint with the times. The moral character of Europe in 1300 was no longer the moral character of Europe in 1100; and the Crusades, which had been the active and objective embodiment of the other worldly Europe of 1100, were alien to the secular, legal, scholastic Europe of 1300. While Edward I. was seeking to found a united kingdom in Great Britain; while the Habsburgs were entrenching themselves in Austria; above all, while Philippe le Bel and his legists were consolidating the French monarchy on an absolutist basis, there could be little thought of the holy war. These were hard-headed men of affairs—men who would not lightly embark on joyous ventures, or seek for an ideal San Grai; nor were the popes, doomed to the Babylonian captivity for seventy long years at Avignon, able to call down the spark from on high which should consume all earthly ambitions in one great act of sacrifice.

But it is long before the death of any institution is recognized; and it was inevitable that men should busy themselves in trying to rekindle the dead embers into new life. Pierre Dubois, in a pamphlet "*De recuperatione Sanctae Terrae*," addressed to Edward I. in 1307, advocates a general council of Europe to maintain peace and prevent the dissensions which—as, for instance, in 1192—had helped to cause the failure of past Crusades. Along with this advocacy of internationalism goes a plea for the disendowment of the Church, in order to provide an adequate financial basis for the future Crusade. Other proposals, made by men well acquainted with the East, are more definitely practical and less political in their intention. A blockade of Egypt by an international fleet, an alliance with the Mongols, the union of the two great orders—these are the three staple heads of these proposals. Something, indeed, was attempted, if little was actually done, under each of these three heads. The plan of an international fleet to coerce the Mahomedan is even to this day ineffective; but the Hospitallers, who acquired a new basis by the conquest of Rhodes in 1310, used their fleet to enforce a partial and, on the whole, ineffective blockade of the coast of the Levant. The union of the two orders, already suggested at the council of Lyons in 1245, was nominally achieved by the council of Vienne in 1311; but the so-called "union" was in reality the suppression of the Templars, and the confiscation of all their resources by the cupidity of Philippe le Bel. The alliance with the Mongols remained, from the first to the last, something of a chimera; and the last visionary hope vanished when the Mongols finally embraced Mahomedanism, as, by the end of the 14th century, they had almost universally done.

Isolated enterprises somewhat of the character of a Crusade, but hardly serious enough to be dignified by that name, recur during the 14th century. The French kings are all crusaders—in name—until the beginning of the Hundred Years' War; but the only crusader who ever carried war in Palestine and sought to shake the hold of the Mamelukes on the Holy Land was Peter I., king of Cyprus from 1359 to 1369. Peter founded the order of the Sword for the delivery of Jerusalem; and instigated by his chancellor, P. de Mézières (one of the last of



the theorists who speculated and wrote on the Crusades), he attempted to revive the old crusading spirit throughout the west of Europe. The mission which he undertook with his chancellor for this purpose (1362-1365) only produced a crop of promises or excuses from sovereigns like Edward III. or the Emperor Charles IV.; and Peter was forced to begin the Crusade with such volunteers as he could collect for himself. In the autumn of 1365 he sacked Alexandria; in 1367 he ravaged the coast of Syria, and inflicted serious damages on the sultan of Egypt. But in 1369 he was assassinated, and the last romantic figure of the Crusades died, leaving only the legacy of his memory to his chancellor de Mézières, who for nearly forty years longer continued to be the preacher of the Crusades to Europe, advocating—what always continued to be the “dream of the old pilgrim”—a new order of knights of the Passion of Christ for the recovery and defence of Jerusalem. De Mézières was the last to advocate seriously, as Peter I. was the last to attempt, a Crusade after the old fashion—an offensive war against Egypt for the recovery of the Holy Sepulchre.<sup>1</sup> From 1350 onwards the Crusade assumes a new aspect; it becomes defensive, and it is directed against the Ottoman Turks, a tribe of Turcomans who had established themselves in the sultanate of Iconium at the end of the 13th century, during the confusion and displacement of peoples which attended the Mongol invasions. As early as 1308 the Ottoman Turks had begun to settle in Europe; by 1350 they had organized their terrible army of janissaries. They threatened at once the débris of the old Latin empire in Greece and the archipelago, and the relics of the Byzantine empire round Constantinople; they menaced the Hospitallers in Rhodes and the Lusignans in Cyprus. It was natural that the popes should endeavour to form a coalition between the various Christian powers which were threatened by the Turks; and Venice, anxious to preserve her possessions in the Aegean, zealously seconded their efforts. In 1344 a Crusade, in which Venice, the Cypriots, and the Hospitallers all joined, ended in the conquest of Smyrna; in 1345 another Crusade, led by Humbert, dauphin of Vienne, ended in failure. The Turks continued their progress; in 1363 they captured Philippopolis, and in 1365 they entered Adrianople; the whole Balkan peninsula was threatened, and even Hungary itself seemed doomed. Already in 1365 Urban VI. sought to unite the king of Hungary and the king of Cyprus in a common Crusade against the Turks; but it was not till 1396 that an attempt was at last made to supplement by a land Crusade the naval Crusades of 1344 and 1345. Master of Servia and of Bulgaria, as well as of Asia Minor, the sultan Bayezid was now threatening Constantinople itself. To arrest his progress, a Crusade, preached by Boniface IX., led by John the Fearless of Burgundy, and joined chiefly by French knights, was directed down the valley of the Danube into the Balkans; but the old faults stigmatized by de Mézières, *divisio* and *propria voluntas*, were the ruin of the crusading army, and at the battle of Nicopolis it was signally defeated. Not the Western Crusades but an Eastern rival, Timur (Tamerlane), king of Transoxiana and conqueror of southern Russia and India, was destined to arrest the progress of Bayezid; and from the battle of Angora (1402) till the days of Murad II. (1422) the Ottoman power was paralysed. Under Murad, however, it rose to its old height. To meet the new danger a new union of the churches of the East and the West was attempted. As in 1074 Gregory VII. had dreamed of such a union, to be followed by a joint attack of East and West on the Seljuks, so in 1439, at the council of Florence, a new union of the two churches was again attempted and temporarily secured, in order that a united Christendom might face the new Turkish danger.<sup>2</sup> The logical result of the union was the Crusade of 1443. An army of cosmopolitan adventurers, led by the Cardinal Caesarini, joined the

<sup>1</sup> The dream of a Crusade to Jerusalem survived de Mézières; a society which read “romants” of the Crusades, could not but dream the dream. Henry V., whose father had fought with the Teutonic knights on the Baltic, dreamed of a voyage to Jerusalem.

<sup>2</sup> The union of 1274, conceded by the Palaeologi at the council of Lyons in order to defeat the plans of Charles of Anjou, had only been temporary.

forces of Wladislaus of Poland and John Hunyadi of Transylvania, and succeeded in forcing on Murad II. a truce of ten years at Szegedin in 1444. But the crusaders broke the truce, to which Caesarini had never consented; and, attempting to better what was already good enough, they were defeated at Varna. Here the last Crusade ended; and nine years afterwards, in 1453, Mahommed II., the successor of Murad, captured Constantinople. It was in vain that the popes sought to gather a new Crusade for its recovery; Pius II., who had vowed to join the crusade in person, only reached Ancona in 1464 to find the crusaders deserting and to die. Yet the ghost of the Crusades still lingered. It became a convention of diplomacy, designed to cover any particularly sharp piece of policy which needed some excuse; and the treaty of Granada, formed between Louis XII. and Ferdinand of Aragon for the partition of Naples in 1500, was excused as a thing necessary in the interests of the Crusades. In a more noble fashion the Crusade survived in the minds of the navigators; “Vasco da Gama, Christopher Columbus, Albuquerque, and many others dreamed, and not insincerely, that they were labouring for the deliverance of the Holy Land, and they bore the Cross on their breasts.”<sup>3</sup> “Don Henrique’s scheme,” it has been said, “represents the final effort of the crusading spirit; and the naval campaigns against the Moslem in the Indian seas, in which it culminated, forty years after Don Henrique’s death, may be described as the last Crusade.”<sup>4</sup>

10. *Results of the Crusades.*—In one vital respect the result of the Crusades may be written down as failure. They ended, not in the occupation of the East by the Christian West, but in the conquest of the West by the Mahomedan East. The Crusades began with the Seljukian Turk planted at Nicaea; they ended with the Ottoman Turk entrenched by the Danube. Nothing is more striking in history than the recession of Christianity in the East after the 13th century. In the 13th century the whole of Europe was Christian; part of Asia Minor still belonged to Greek Christianity, and there was a Christian kingdom in Palestine. Nor was this all. A wide missionary activity had begun in the 13th century—an activity which was the product of the Crusades and the contact with the Moslem which they brought, but which yet helped to check the Crusades, substituting as it did peaceful and spiritual conquests of souls for the violence and materialism of even a Holy War. The Eastern mission had been begun by St Francis, who had visited and attempted to convert the sultan of Egypt during the Fifth Crusade (1220); within a hundred years the little seed had grown into a great tree. A great field for missionary enterprise opened itself in the Mongol empire, in which, as has already been mentioned, there were many Christians to be found; and by 1350 this field had been so well worked that Christian missions and Christian bishops were established from Persia to Peking, and from the Dnieper to Tibet itself. But a Mahomedan reaction came, thanks in large measure to the zeal of Timur; and central Asia was lost to Christianity. Everywhere in the 15th century, in Europe and in Asia, the crescent was victorious over the cross; and Crusade and mission, whether one regards them as complementary or inimical, perished together.<sup>5</sup>

But the history of the Crusades must be viewed rather as a chapter in the history of civilization in the West itself, than as an extension of Western dominion or religion to the East. It is a chapter very difficult to write, for while on the one hand an ingenious and speculative historian may refer to the influence of the Crusades almost everything which was thought or done between 1100 and 1300, a cautious writer who seeks to find

<sup>3</sup> Bréhier, *L’Église et l’Orient*, p. 347.

<sup>4</sup> *Cambridge Modern History*, i. 11. It is perhaps worth remarking that something of the old crusading spirit seems still to linger in the movement of Russia towards Constantinople.

<sup>5</sup> While from this point of view the Crusades appear as a failure, it must not be forgotten that elsewhere than in the East Crusades did attain some success. A Crusade won for Christianity the coast of the eastern Baltic (see TEUTONIC ORDER); and the centuries of the Spanish Crusade ended in the conquest of the whole of Spain for Christianity.

documentary evidence for every assertion may be rather inclined to attribute to that influence little or nothing.<sup>1</sup> The dissolution of feudalism, the development of towns, the growth of scholasticism, all these and much more have been ascribed to the Crusades, when in truth they were concomitants rather than results, or at any rate, if in part the results of the Crusades, were in far larger part the results of other things. At most, therefore, it may be admitted that the Crusades contributed to the dissolution of feudalism by putting property on the market and disturbing the validity of titles; that they aided the development of towns by vastly increasing the volume of trade; and that they furthered the growth of scholasticism by bringing the West into contact with the mind of the East. If we seek the peculiar and definite results of the Crusades, we must turn to narrower issues. In the first place, the Crusades represent the attempt of a feudal system, bound under the law of primogeniture to dispose of its younger sons. They are attempts at feudal colonization; and as such they resulted in a number of colonies—the kingdom of Jerusalem, the kingdom of Cyprus, the Latin empire of Constantinople. They resulted too in a number of “chartered companies”—that is to say, the three military orders, which, beginning as charitable societies, developed into military clubs, and developed again from military clubs into chartered companies, possessed of banks, navies and considerable territories. In the second place, as has already been noticed, the Crusades represent the attempt of Western commerce to find new and more easy routes to the wealth of the East; and in this respect they led to various results. On the one hand they led to the establishment of emporia in the East—for instance, Acre, and after the fall of Acre Famagusta, both in their day great centres of Levantine trade. On the other hand, the commodities which poured into Venice and Genoa from the East had to find a route for their diffusion through Europe. The great route was that which led from Venice over the Brenner and up the Rhine to Bruges; and this route became the long red line of municipal development, along which—in Lombardy, Germany and Flanders—the great towns of the middle ages sprang to life. Partly as a result of this trade, ever pushing its way farther east, and partly as a result of the Asiatic missions, which were themselves an accompaniment and effect of the Crusades, a third great result of the Crusades came to light in the 13th century—the discovery of the interior of Asia, and an immense accession to the sphere of geography. When one remembers that missionaries like Piano Carpini, and traders like the Venetian Polos, either penetrated by land from Acre to Peking, or circumnavigated southern Asia from Basra to Canton, one realizes that there was, about 1300, a discovery of Asia as new and tremendous as the discovery of America by Columbus two centuries later. At the same time the old knowledge of nearer Asia was immensely deepened. It has already been noticed how military reconnaissances of the routes to Egypt came to be made; but more important were the guide-books, of which a great number were written to guide the pilgrims from one sacred spot of Bible history to another. There were medieval Baedekers in abundance for the use of the annual flow of tourists, who were carried every Easter by the vessels of the Italian towns or of the Orders to visit the Holy Land and to bathe in Jordan, to gather palms, and to see the miracle of fire at the Sepulchre.

Colonization, trade, geography—these then are three things closely connected with the history of the Crusades. The development of the art of war, and the growth of a systematic taxation, are two debts which medieval Europe also owed to the Crusades. Partly by contact with the Byzantines, partly by conflict with the Mahomedans, the Franks learned new methods

both of building and of attacking fortifications. The concentric castle, with its rings of walls, began to displace the old keep and bailey with their single wall, as the crusaders brought back news from the East.<sup>2</sup> The art of the sapper and miner, the use of siege instruments like the mangonel, and the employment of various “fires” as missiles, were all known among the Mahomedans; and in all these respects the Franks learned from their enemies. The common use of armorial bearings, and the practice of the tournament, may be Oriental in their origin; the latter has its affinities with the equestrian exercises of the Jerid, and the former, though of prehistoric antiquity, may have received a new impulse from contact with the Arabs. The military development which sprang from the Crusades is thus largely a matter of borrowing; the financial development is independent and indigenous in the West. As early as 1147 Louis VII. had imposed a tax in the interests of the Crusades; and that tax had been repeated by Louis, and imitated by Henry II. in 1166, while it had been still further extended in the Saladin tithe of 1188. The taxation of 1166 is important as the first to fall on “moveables”; the whole scheme of taxation may be regarded as the beginning of a modern system of taxation. But it was not only to the lay power that the Crusades gave an excuse for taxation; the papacy also profited. Tithes for the Crusades were first imposed on the clergy by Innocent III. at the Lateran council of 1215; and clerical taxation was thus part of the whole statesmanlike project of the Fifth Crusade as it was sketched by the great pope. Henceforth tithes for the Crusades are regular; under Gregory IX. they become a great part of the papal resources in the Crusade against the Hohenstaufen; and in the 16th century they are still a normal part of the government of the Church.

In many other ways the Europe over which the Crusades had passed was different from the Europe of the 11th century. In the first place, many political changes had been wrought, largely under its influence. Always in large part French, the Crusades had on the whole contributed to exalt the prestige of France, until it stood at the end of the 13th century the most considerable power in Europe. It was France which had colonized the Levant; it was the French tongue which was used in the Levant; and the results of the ancient and continuous connexion with the East are still to be traced to-day. Of the other great powers of Europe, England and Germany had been little changed by the Crusades, save that Germany had been extended towards the East by the conquests of the Teutonic Order; but the Eastern empire had been profoundly modified, and the papacy had suffered a great change. The Eastern empire had been for a time annihilated by the movement which in 1095 it had helped to evoke; and if it rose from its ashes in 1261 for two centuries of renewed life, it was never more than the shadow of its old self, with little hold on Asia Minor and less on Greece and the Archipelago, which the Latins still continued to occupy until they were finally conquered by the Ottoman Turks. The papacy, on the other hand, had grown as a result of the Crusades. Popes had preached them; popes had financed them; popes had sent their legates to lead them. Through them the popes had deposed the emperors of the West from their headship of the world, partly because through the Crusades the popes were able to direct the common Christianity of Europe in a foreign policy of their own without consultation with the emperor, partly because in the 13th century they were ultimately able to direct the Crusade itself against the empire. Yet while they had magnified, the Crusades had also corrupted the papacy. They became an instrument in its hands which it used to its own undoing. It cried Crusade when there was no Crusade; and the long Crusade against the Hohenstaufen, if it gave the papacy an apparent victory, only served in the long run to lower its

<sup>1</sup> Authors like Heeren (*Versuch einer Entwicklung der Folgen der Kreuzzüge*) and Michaud (in the last volume of his *Histoire des croisades*) fall into the error of assigning all things to the Crusades. Even Prutz, in his *Kulturgeschichte der Kreuzzüge*, over-estimates the influence of the Crusades as a chapter in the history of civilization. He depreciates unduly the Western civilization of the early middle ages, and exalts the civilization of the Arabs; and starting from these two premises, he concludes that modern civilization is the offspring of the Crusades, which first brought East and West together.

<sup>2</sup> It is difficult to decide how far Arabic models influenced ecclesiastical architecture in the West as a result of the Crusades. Greater freedom of moulding and the use of trefoil and cinquefoil may be, but need not be, explained in this way. The pointed arch owes nothing to the Arabs; it is already used in England in early Norman work. Generally, one may say that Western architecture is independent of the East.

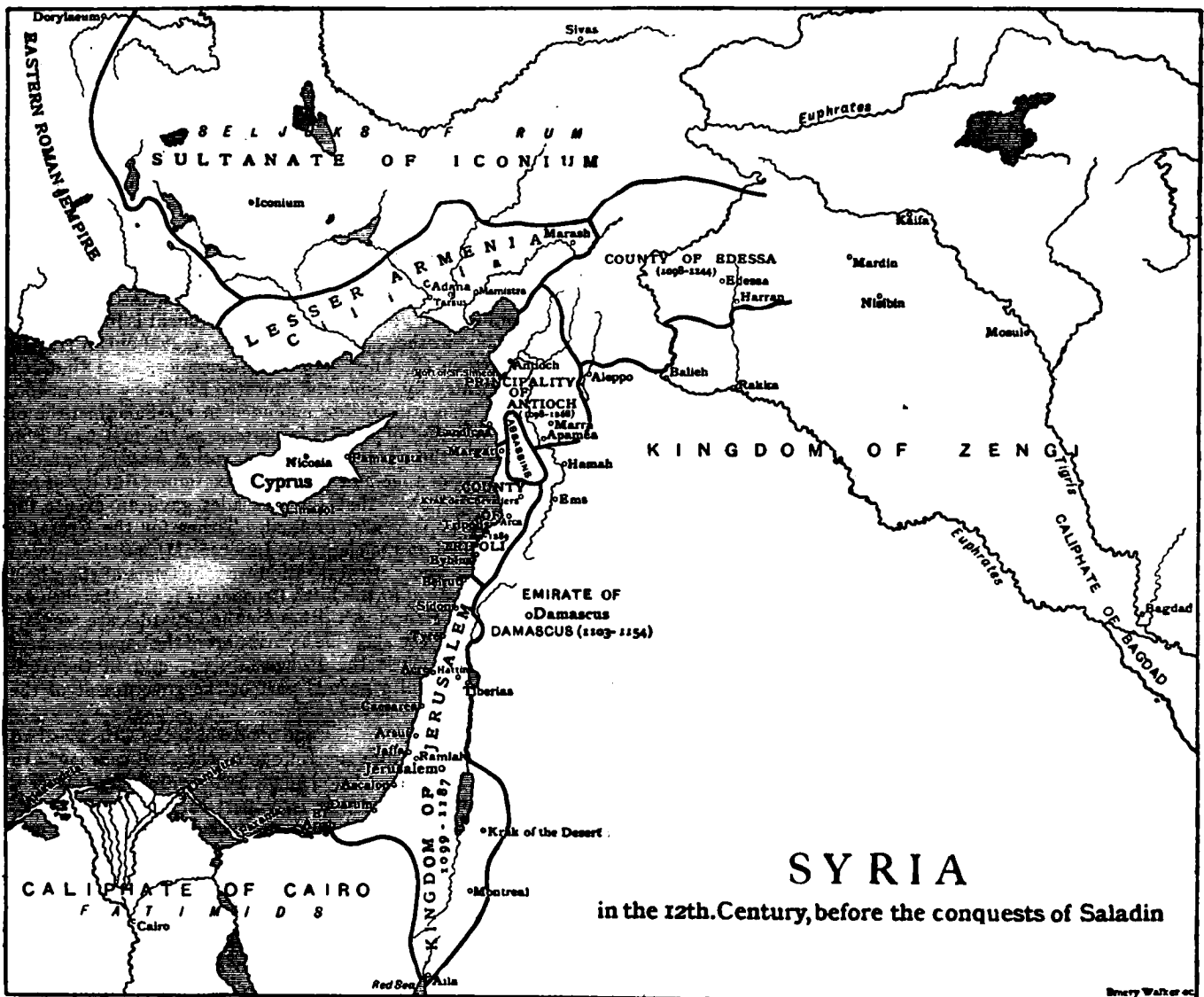

prestige in the eyes of Europe. When we turn from the sphere of politics to the history of civilization and culture, we find the effects of the Crusades as deeply impressed, if not so definitely marked. The Crusades had sprung from the policy of a theocratic government counting on the motive of otherworldliness; they had helped in their course to overthrow that motive, and with it the government which it had made possible. In part they had provided a field in which the layman could prove that he too was a priest; in part they had brought the West into a living and continuous contact with a new faith and a new civilization. They had torn men loose from the ancestral custom of home to walk in new ways and see new things and hear new thoughts; and some broadening of view, some lessening in the intensity of the old one-sidedness, was the inevitable result. It is not so much that the West came into contact with a particular civilization in the East, or borrowed from that civilization; it is simply that the West came into contact with something unlike itself, yet in many ways as high as, if not higher than, itself. The spirit of *Nathan der Weise* may not have been exactly the spirit engendered by the Crusades; and yet it is not without reason that Lessing stages the fable which teaches toleration in the Latin kingdom of Jerusalem. In any case the accusations made against the Templars at the time of their suppression prove that there was, at any rate in the ranks of those who knew the East, too little of absolute orthodoxy. While a new spirit which compares and tolerates thus sprang from the Crusades, the large sphere of new knowledge and experience which they gave brought new material at once

for scientific thought and poetic imagination. Not only was geography more studied; the Crusades gave a great impulse to the writing of history, and produced, besides innumerable other works, the greatest historical work of the middle ages—the *Historia transmarina* of William of Tyre. Mathematics received an impulse, largely, it is true, from the Arabs of Spain, but also from the East; Leonardo Fibonacci, the first Christian algebraist, had travelled in Syria and Egypt. The study of Oriental languages began in connexion with the Christian missions of the East; Raymond Lull, the indefatigable missionary, induced the council of Vienne to decide on the creation of six schools of Oriental languages in Europe (1311). But the new field of poetic literature afforded by the Crusades is still more striking than this development of science. New poems in abundance dealt with the history of the Crusades, either in a faithful narrative, like that of the *Chanson of Amboise*, which narrates the Third Crusade, or in a free and poetical spirit, such as breathes in the *Chanson d'Antioche*. Nor was this all. The Crusades afforded new details which might be inserted into old matters, and a new spirit which might be infused into old subjects; and a crusading complexion thus came to be put upon old tales like those of Arthur and Charlemagne. By the side of these greater things it may seem little, and yet, just because it is little, it is all the more significant that the Crusades should have familiarized Europe with new plants, new fruits, new manufactures, new colours, and new fashions in dress. Sugar and maize; lemons, apricots and melons; cotton, muslin and damask; lilac and purple (azure and gules are words derived

GENEALOGY OF THE KINGS OF JERUSALEM

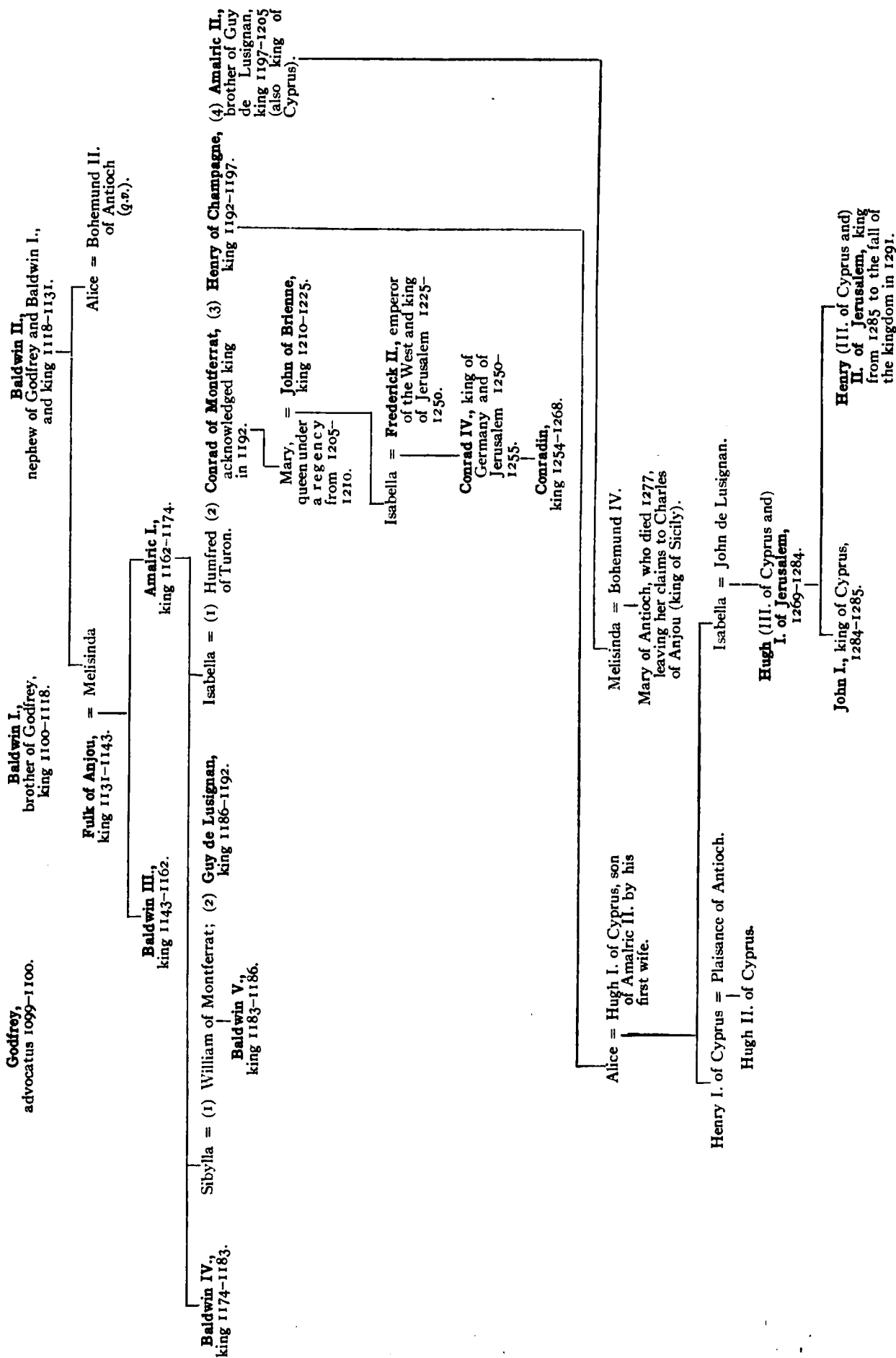

from the Arabic); the use of powder and of glass mirrors, and also of the rosary itself—all these things came to Europe from the East and as a result of the Crusades. To this day there are many Arabic words in the vocabulary of the languages of western Europe which are a standing witness of the Crusades—words relating to trade and seafaring, like tariff and corvette, or words for musical instruments, like lute or the Elizabethan word “naker.”

When all is said, the Crusades remain a wonderful and perpetually astonishing act in the great drama of human life. They touched the summits of daring and devotion, if they also sank into the deep abysses of shame. Motives of self-interest may have lurked in them—otherworldly motives of buying salvation for a little price, or worldly motives of achieving riches and acquiring lands. Yet it would be treason to the majesty of man's incessant struggle towards an ideal good, if one were to deny that in and through the Crusades men strove for righteousness' sake to extend the kingdom of God upon earth. Therefore the tears and the blood that were shed were not unavailing; the heroism and the chivalry were not wasted. Humanity is the richer for the memory of those millions of men, who followed the pillar of cloud and fire in the sure and certain hope of an eternal reward. The ages were not dark in which Christianity could gather itself together in a common cause, and carry the flag of its faith to the grave of its Redeemer; nor can we but give thanks for their memory, even if for us religion is of the spirit, and Jerusalem in the heart of every man who believes in Christ.

**LITERATURE.**—In dealing with the literature of the Crusades, it is perhaps better, though ideally less scientific, to begin with chronicles and narratives rather than with documents. One of the results of the Crusades, as has just been suggested above, was a great increase in the writing of history. Crusaders themselves kept diaries or *itineraria*; while home-keeping ecclesiastics in the West—monks like Robert of Reims, abbots like Guibert of Nogent, archbishops like Balderich of Dol—found a fertile subject for their pens in the history of the Crusades. The history of a series of actions like the Crusades must primarily be based on these accounts, and more particularly on the former; narratives must precede documents where one is dealing, not with the continuous life of an organized kingdom, but with a number of enterprises—especially when those enterprises have been, as in this case, excellently narrated by contemporary writers.

**I. Chronicles and Narratives of the Crusades**—(1) Collections. The authorities for the Crusades have been collected in Bongars, *Gesta Dei per Francos* (Hanover, 1611) (incomplete); Michaud, *Bibliothèque des croisades* (Paris, 1829) (containing translations of select passages in the authorities); the *Recueil des historiens des croisades*, published by the Académie des Inscriptions (Paris, 1841 onwards) (the best general collection, containing many of the Latin, Greek, Arabic and Armenian authorities, and also the text of the assizes; but sometimes poorly edited and still incomplete); and the publications of the Société de l'Orient Latin (founded in 1875), especially the *Archives*, of which two volumes were published in 1881 and 1884, and the volumes of the *Revue*, published yearly from 1893 to 1902, and containing not only new texts, but articles and reviews of books which are of great service. (2) Particular authorities. The Crusades—a movement which engaged all Europe and brought the East into contact with the West—must necessarily be studied not only in the Latin authorities of Europe and of Palestine, but also in Byzantine, Armenian and Arabic writers. There are thus some four or five different points of view to be considered.

The *First Crusade*, far more than any other, became the theme of a multitude of writings, whose different degrees of value it is all-important to distinguish. Until about 1840 the authority followed for its history was naturally the great work of William of Tyre. For the First Crusade William had followed Albert of Aix; and he had consequently depicted Peter the Hermit as the prime mover in the Crusade. But about 1840 Ranke suggested, and von Sybel in his *Geschichte des ersten Kreuzzuges* proved, that Albert of Aix was not a good authority, and that consequently William of Tyre must be set aside for the history of the First Crusade, and other and more contemporary authorities used. In writing his account of the First Crusade, von Sybel accordingly based himself on the three contemporary Western authorities—the *Gesta Francorum*, Raymond of Agiles, and Fulcher. His view of the value of Albert of Aix, and his account of the First Crusade, have been generally followed (Kugler alone having attempted, to some extent, to rehabilitate Albert of Aix); and thus von Sybel's work may be said to mark a revolution in the history of the First Crusade, when its legendary features were stripped away, and its real progress was first properly discovered.

Taking the Western authorities for the First Crusade separately,

one may divide them, in the light of von Sybel's work, into four kinds—the accounts of eye-witnesses; later compilations based on these accounts; semi-legendary and legendary narratives; and lastly, in a class by itself, the “History” of William of Tyre, who is rather a scientific historian than a chronicler.

(a) The three chief eye-witnesses are the anonymous author of the *Gesta Francorum*, Raymond of Agiles, and Fulcher. The anonymous author of the *Gesta* (see Hagenmeyer's edition, Heidelberg, 1890) was a Norman of South Italy, who followed Bohemund, and accordingly depicts the progress of the First Crusade from a Norman point of view. He was a layman, marching and fighting in the ranks; and thus he is additionally valuable as representing the opinion of the ordinary crusader. Finally he was an eye-witness throughout, and absolutely contemporary, in the sense that he wrote his account of each great event practically at the time of the event. He is the primary authority for the First Crusade. Raymond of Agiles, a Provençal clerk and a follower of Raymond of Toulouse, writes his *Historia Francorum qui ceperunt Jerusalem* from the Provençal point of view. He gives an ecclesiastic's account of the First Crusade, and is specially full on the spiritualistic phenomena which accompanied and followed the finding of the Holy Lance. His book might almost be called the “Visions of Peter Bartholomew and others,” and it is written in the plain matter-of-fact manner of Defoe's narratives. He too was an eye-witness throughout, and thoroughly honest; and his account ranks second to the *Gesta*. Fulcher of Chartres originally followed Robert of Normandy, but in October 1097 he joined Baldwin of Lorraine in his expedition to Edessa, and afterwards followed his fortunes. His *Historia Hierosolymitana*, which extends to 1127, and embraces not only the history of the First Crusade, but also that of the foundation of the kingdom of Jerusalem, is written on the whole from a Lotharingian point of view, and is thus a natural complement to the accounts of the Anonymus and Raymond. His account of the First Crusade itself is poor (he was absent at Edessa during its course), but otherwise he is an excellent authority. A kindly old pedant, Fulcher interlard his history with much discourse on geography, zoology and sacred history. Besides these three chief eye-witnesses we may also mention the *Annales Genuenses* by the Genoese consul Caffarus,<sup>1</sup> and the *Annales Pisani* of Bernardus Marago, useful as giving the mercantile and Italian side of the Crusade; the *Hierosolymita* of Ekkehard, the German abbot of Aura, who first came to Jerusalem about 1101 (partly based on the *Gesta*, but also of independent value; see Hagenmeyer's edition, Tübingen, 1877); and Raoul of Caen's *Gesta Tancredi*, composed on the basis of information supplied by Tancred himself. The last two works, if not actually the works of eye-witnesses, are at any rate first-hand, and belong to the category of primary writers rather than to that of later compilations. Finally, to contemporary writers we may add contemporary letters, especially those written by Stephen of Blois and Anselm of Ribemont, and the three letters sent to the West by the crusading princes during the First Crusade (see Hagenmeyer, *Epistolae et Chartae*, &c., Innsbruck, 1901).<sup>2</sup>

(b) The later compilations are chiefly based on the *Gesta*, whose uncouth style many writers set themselves to mend. In the first place, there is the *Historia de Hierosolymitano itinere* of Tudebod, which according to Besly, writing in 1641, is the original from which the *Gesta* was a mere plagiarism—an absolute inversion of the truth, as von Sybel first proved two centuries later. Secondly, besides the plagiarist Tudebod, there are the artistic *rédacteurs* of the *Gesta*, who confess their indebtedness, but plead the bad style of their original—Guibert of Nogent, Balderich of Dol, Robert of Reims (all c. 1120–1130), and Fulco, the author of a Virgilian poem on the Crusades, continued by Gilo (*ob. c. 1142*). Of these, the monk Robert was more popular in the middle ages than either the pompous abbot Guibert or the quiet garden-loving archbishop of Dol.

(c) The growth of a legend, or perhaps better, a saga of the First Crusade began, according to von Sybel, even during the Crusade itself. The basis of this growth is partly the story-telling instinct innate in all men, which loves to heighten an effect, sharpen a point or increase a contrast—the instinct which breathes in Icelandic sagas like that of *Burnt Njal*; partly the instinct of idolization, if it may be so called, which leads to the perversion into impossible greatness of an approved character, and has created, in this instance, the legendary figures of Peter the Hermit and Godfrey of Bouillon (*qq.v.*); partly the religious impulse, which counted nothing wonderful in a holy war, and imported miraculous elements even into the sober pages of the *Gesta*. These instincts and impulses would be at work already among the soldiers during the Crusade, producing a saga all the more readily, as there were poets in the camp; for we know that a certain Richard, who joined the First Crusade, sang its exploits in verse, while still more famous is the princely troubadour, William of Aquitaine, who joined the Crusade of 1100. If we are to follow von Sybel rather than Kugler, this saga of the First Crusade found one of its earliest expressions (*c. 1120*) in the prose work of Albert of Aix (*Historia Hierosolymitana*)—genuine saga in its

<sup>1</sup> His somewhat legendary treatise, *De liberatione civitatum Orientis*, was only composed about 1155.

<sup>2</sup> There is also an *Inventaire critique* of these letters by the comte de Riant (Paris, 1880).



inconsistencies, its errors of chronology and topography, its poetical colour, and its living descriptions of battles. Kugler, however, regards Albert as a copyist, somewhat in the manner of Tudebod, of an unknown writer of value, who belonged to the Lotharingian ranks during the Crusade, and settled in the kingdom of Jerusalem afterwards (see Kugler, *Albert von Aachen*, Stuttgart, 1885).<sup>1</sup> In the *Chanson des chefs* and the *Chanson d'Antioche* the legend of the Crusades more certainly finds its expression. The former, composed at Antioch about 1130, contained an idolization of the Hermit: the latter is a poem written about 1180 by Graindor of Douai, who used as his basis the verses of the crusader Richard (see the edition of P. Paris, 1848). It shows the growth of the legend that Graindor regards the vision of the Hermit as responsible for the Crusade, and makes the Crusade led by him precede, and indeed occasion by its failure, the meeting at Clermont (which is dated in May instead of November). Into the legendary overgrowth of the First Crusade we cannot here enter any further<sup>2</sup>; but it is perhaps worth while to mention that the French legend of the Third Crusade equally perverted the truth, making Richard I. return home in disgrace, while Philip Augustus stays, captures Damascus and mortally wounds Saladin (cf. G. Paris, *L'Éstoire de la guerre sainte*, Paris, 1897; Introduction).

(d) William of Tyre is the scientific historian and rationalizer, weaving into a harmonious account, which was followed by historians for centuries, the sober accounts of eye-witnesses and the picturesque details of the saga—with somewhat of a bias towards the latter in regard to the First Crusade. He was a native of Palestine, born about 1130, and educated in the West. On his return he was happy in winning the good opinion of Amalric I.; he was made first canon and then archdeacon of Tyre, and tutor of the future Baldwin IV. (1170); while on Baldwin's accession he became chancellor of the kingdom and archbishop of Tyre (1174-1175). He was a man often employed on missions and negotiations, and as chancellor he had in his care the archives of the kingdom. His temper was naturally that of a trimmer; and he had thus many qualifications for the writing of well-informed and unbiassed history. He knew Greek and Arabic; and he was well acquainted with the affairs of Constantinople, to which he went at least twice on political business, and with the history of the Mahomedan powers, on which he had written a work (now lost) at the command of Amalric. It was Amalric also who set him to write the history of the Crusades which we still possess (in twenty-two books, with a fragment of a twenty-third)—the *Historia rerum in partibus transmarinis gestarum*. He wrote the book at different times between 1170 and 1183, when it abruptly ends, and its author as abruptly disappears from sight. The book falls into two parts, the first (books i.-xv.) derivative, the second (books xvi.-xxiii.) original. In the second part he had his own knowledge of events and the information of his contemporaries as his source: in the first he used the same authorities which we still possess—the *Gesta*, Fulcher, and Albert of Aix—in somewhat of an eclectic spirit, choosing now here, now there, according as he could best weave a pleasant narrative, but not according to any real critical principle. His book thus begins to be a real authority only from the date of the Second Crusade onwards; but the perfection of his form (for he is one of the greatest stylists of the middle ages) and the prestige of his position conspired to make his book the one authority for the whole history of the first century of the Crusades. Nor was he (apart from his reception of legendary elements into his narrative) unworthy of the honour in which he was held; for he is really a great historian, in the form of his matter and in his conception of his subject—diligent, impartial, well-informed and interesting, if somewhat rhetorical in style and vague in chronology.

[During the middle ages his work was current in a French translation, known as the *Chronique d'outremer*, or the *Livre or Roman d'Éraclès* (so called from the reference at the beginning to the emperor Heraclius). This translation also contained a continuation by various hands down to 1277; while besides the continuation embedded in the *Livre d'Éraclès*, there are separate continuations, of the nature of independent works, by Ernoul and Bernard the Treasurer. These latter cover the period from 1183 to 1228; and of the two Ernoul's account seems primary, while that of Bernard is in large part a mere copy of Ernoul. But the whole subject of the continuators of William of Tyre is dubious.]

To the Western authorities for the First Crusade must be added the Eastern—Byzantine, Arabic and Armenian. Of these the Byzantine authority, the *Alexiad* of Anna Comnena, is most important, partly from the position of the authoress, partly from the many points of contact between the Byzantine empire and the crusaders. Anna's narrative both furnishes a useful corrective of

the prejudiced Western accounts of Alexius, and serves to bring Bohemund forward into his proper prominence. The Armenian view of the First Crusade and of Baldwin's principality of Edessa is presented in the *Armenian Chronicle* of Matthew of Edessa. There is little in Arabic bearing on the First Crusade: the Arabic authorities only begin to be of value with the rise of the atabegs of Mosul (c. 1127). But Kemal-ud-din's *History of Aleppo* (composed in the 13th century) contains some details on the history of the First Crusade; and the *Vie d'Ousâma* (the autobiography of a sheik at Caesarea in northern Syria, edited and paraphrased by Derenbourg in the *Publications de l'École des langues orientales vivantes*) presents the point of view of an Arab whose life covered the first century of the Crusades (1095-1188).

For the *Second Crusade* the primary authority in the West is the work of Odo de Deuil, *De professione Ludovici VII regis Francorum in Orientem*. Odo was a monk attached by Suger to Louis VII. during the Second Crusade; and he wrote home to Suger during the Crusade seven short letters, afterwards pieced together in a single work. The *Gesta Friderici Primi* of Otto of Freising (who joined in the Second Crusade) gives some details from the German point of view (i. c. 44 sqq.). The former is supplemented by the letters of Louis VII. to Suger; the latter by the letters of Conrad III. to Wibald, abbot of Stablo and Corvey. The Byzantine point of view is presented in the *Ἐπιτομή* of Cinnamus, the private secretary of Manuel, who continued the *Alexiad* of Anna Comnena in a work describing the reigns of John and Manuel. It is from the Second Crusade that William of Tyre, representing the attitude of the Franks of Jerusalem, begins to be a primary authority; while on the Mahomedan side a considerable authority emerges in Ibn Athir. His history of the Atabegs was written about 1200, and it presents in a light favourable to Zengi and Nureddin, but unfavourable to Saladin (who thrust Nureddin's descendants aside), the history of the great Mahomedan power which finally crushed the kingdom of Jerusalem.<sup>3</sup>

Side by side with Beha-ud-din's life of Saladin, Ibn Athir's work is the most considerable historical record written by the Arabs. Generally speaking the Arabic writings are late in point of date, and cold and jejune in style; while it must also be remembered that they are set religious works written to defend Islam. On the other hand they are generally written by men of affairs—governors, secretaries or ambassadors; and a fatalistic temper leads their authors to a certain impartial recording of everything, good or evil, which seems of moment.

The *Third Crusade* was narrated in the West from very different points of view by Anglo-Norman, French and German authorities. The primary Anglo-Norman authority is the *Carmen Ambrosii*, or, as it is called by M. Gaston Paris, *L'Éstoire de la guerre sainte*. This is an octosyllabic poem in French verse, written by Ambroise, a Norman *trouvère* who followed Richard I. to the Holy Land. The poem first came to be known by scholars about 1873, and has been edited by M. Gaston Paris (Paris, 1897). The *Itinerarium Peregrinorum*, a work in ornate Latin prose, is (except for the first book) a translation of the *Carmen* masquerading under the guise of an independent work. There seems no doubt that it is a piece of plagiarism, and that its writer, Richard, "canon of the Holy Trinity" in London, stands to the *Carmen* as Tudebod to the *Gesta*, or Albert of Aix to his supposed original. The Third Crusade is also described from the English point of view by all contemporary writers of history in England, e.g. Ralph of Coggeshall, who used information gained from crusaders, and William of Newburgh, who had access to a work by Richard I.'s chaplain Anselm, which is now lost.<sup>4</sup> The French side is presented in Rigord's *Gesta Philippi Augusti* and in the *Gesta* (an abridgment and continuation of Rigord) and the *Philippides* of William the Breton. The two French writers represent Richard as a faithless vassal: in the German writers—Tagino, dean of Passau, who wrote a *Descriptio* of Barbarossa's Crusade (1189-1190); and Ansbert, an Austrian clerk, who wrote *De expeditione Friderici Imperatoris* (1187-1196)—Richard appears rather as a monster of pride and arrogance. From the Arabic point of view the life of Richard's rival, Saladin, is described by Beha-ud-din, a high official under Saladin, who writes a panegyric on his master, somewhat confused in chronology and partial in its sympathies, but nevertheless of great value. The various continuations of William of Tyre above mentioned represent the opinion of the native Franks (which is hostile to Richard I.); while in Nicetas, who wrote a history of the Eastern empire from 1118 to 1206, we have a Byzantine authority who, as Professor Bury remarks, "differs from Anna and Cinnamus in his tone towards the crusaders, to whom he is surprisingly fair."

For the *Fourth Crusade* the primary authority is Villehardouin's *La Conquête de Constantinople*, an official apology for the diversion of the Crusade written by one of its leaders, and concealing the *arcana* under an appearance of frank naïveté. His work is usefully supplemented by the narrative (*La Prise de Constantinople*) of

<sup>1</sup> Von Sybel's view must be modified by that of Kugler, to which a scholar like Hagenmeyer has to some extent given his adhesion (cf. his edition of the *Gesta*, pp. 62-68). Hagenmeyer inclines to believe in an original author, distinct from Albert the copyist; and he thinks that this original author (whether or no he was present during the Crusade) used the *Gesta* and also Fulcher, though he had probably also "eigene Notizen und Aufzeichnungen."

<sup>2</sup> See Pignonneau, *Le Cycle de la croisade*, &c. (Paris, 1877); and Hagenmeyer, *Peter der Eremita* (Leipzig, 1879).

<sup>3</sup> On the bibliography of the Second Crusade see Kugler, *Studien zur Geschichte des zweiten Kreuzzuges* (Stuttgart, 1866).

<sup>4</sup> Of these writers see Archer's *Crusade of Richard I.*, Appendix (in Nutt's series of Histories from Contemporary Writers).

Robert de Clary, a knight from Picardy, who presents the non-official view of the Crusade, as it appeared to an ordinary soldier. The *Χρονικὸν τῶν ἐν Ῥωμανίᾳ* (composed in Greek verse some time after 1300, apparently by an author of mixed Frankish and Greek parentage, and translated into French at an early date under the title "The Book of the Conquest of Constantinople and the Empire of Rumania") narrates in a prologue the events of the Fourth (as indeed also of the First) Crusade. The *Chronicle of the Morea* (as this work is generally called) is written from the Frankish point of view, in spite of its Greek verse; and the Byzantine point of view must be sought in Nicetas.<sup>1</sup>

The history of the later Crusades, from the Fifth to the Eighth, enters into the continuations of William of Tyre above mentioned; while the *Historia orientalis* of Jacques de Vitry, who had taken part in the Fifth Crusade, and died in 1240, embraces the history of events till 1218 (the third book being a later addition). The *Secreta fidelium Crucis* of Marino Sanudo, a history of the Crusades written by a Venetian noble between 1306 and 1321, is also of value, particularly for the Crusade of Frederick II. The minor authorities for the Fifth Crusade have been collected by Röhricht, in the publications of the Société de l'Orient Latin for 1879 and 1882; the ten valuable letters of Oliver, bishop of Paderborn, and the *Historia Damiellina*, based on these letters, have also been edited by Röhricht in the *Westdeutsche Zeitschrift für Geschichte und Kunst* (1891). The Sixth Crusade, that of Frederick II., is described in the chronicle of Richard of San Germano, a notary of the emperor, and in other Western authorities, e.g. Roger of Wendover. For the Crusades of St Louis the chief authorities are Joinville's life of his master (whom he accompanied to Egypt on the Seventh Crusade), and de Nangis' *Gesta Ludovici regis*. Several works were written on the capture of Acre in 1291, especially the *Excidium urbis Aconensis*, a treatise which emerges to throw light, after many years of darkness, on the last hours of the kingdom. The Oriental point of view for the 13th century appears in Jeleddin's history of the Ayyubite sultans of Egypt, written towards the end of the 13th century; in Maqrizi's history of Egypt, written in the middle of the 15th century; and in the compendium of the history of the human race by Abulfeda (†1332); while the omniscient Abulfaragius (whom Rey calls the Eastern St Thomas) wrote, in the latter half of the 13th century, a chronicle of universal history in Syriac, which he also issued, in an Arabic recension, as a *Compendious History of the Dynasties*.

II. The documents bearing on the history of the Crusades and the Latin kingdom of Jerusalem are various. Under the head of charters come the *Regesta regni Hierosolymitani*, published by Röhricht, Innsbruck, 1893 (with an *Additamentum* in 1904); the *Cartulaire générale des Hospitaliers*, by Delaville Leroulx (Paris, 1894 onwards); and the *Cartulaire de l'église du St Sépulcre*, by de Rozière (Paris, 1849). Under the head of laws come the assizes of the Kingdom, edited by Beugnot in the *Recueil des historiens des croisades*; and the assizes of Antioch, printed at Venice in 1876. G. Schlumberger has written on the coins and seals of the Latin East in various publications; while Rey has written an *Étude sur les monuments de l'architecture militaire* (Paris, 1871). The genealogy of the Levant is given in *Le Livre des lignages d'outre-mer* (published along with the assizes).

**BIBLIOGRAPHIES.**—The best modern account of the original authorities for the Crusades is that of A. Molinier, *Les Sources de l'histoire de France*, vols. ii. and iii. W. Wattenbach's *Deutschlands Geschichtsquellen* gives an account of Albert of Aix (vol. ii., ed. 1894, pp. 170-180) and of Ekkehard of Aura (*ibid.* pp. 189-198). Von Sybel's *Geschichte des ersten Kreuzzuges* contains a full study of the authorities for the First Crusade; while the prefaces to Hagenmeyer's editions of the *Gesta* and of Ekkehard are also valuable. Gaston Dodu, in the work mentioned below, begins by a brief account of the original authorities, which is chiefly of value so far as it deals with William of Tyre and the history of the assizes; and H. Prutz has also a short account of some of the historians of the Crusades (*Kulturgeschichte*, pp. 453-469). Finally reference may be made to the works of Kugler and Klimke above mentioned, and to J. F. Michaud's *Bibliographie des croisades* (Paris, 1822).

**Modern Writers.**—The various works of R. Röhricht present the soundest, if not the brightest, account of the Crusades. There is a *Geschichte des ersten Kreuzzugs* (Innsbruck, 1901), a *Geschichte des Königreichs Jerusalem* (*ibid.* 1898) and a *Geschichte der Kreuzzüge in Umriss* (*ibid.* 1898). For the First Crusade von Sybel's work and Chalandon's *Alexis I<sup>er</sup> Comnène* may also be mentioned; for the Fourth A. Luchaire's volume on *Innocent III: La Question d'Orient*; while for the whole of the Crusades Norden's *Papstum und Byzanz* is of value. B. Kugler's *Geschichte der Kreuzzüge* (in Oncken's series) still remains a suggestive and valuable work; and L. Bréhier's *L'Église et l'orient au moyen âge* (Paris, 1907) contains not only an up-to-date account of the Crusades, but also a full and useful bibliography, which should be consulted for fuller information. On points of chronology, and on the relations between the crusaders and their Mahommedan neighbours, W. B. Stevenson's *The Crusaders in the East* (Cambridge, 1907) is very valuable. On the constitutional and

social history of the Latin kingdom of Jerusalem Dodu's *Histoire des institutions du royaume latin de Jérusalem* is very useful; E. G. Rey's *Les Colonies franques en Syrie* contains many interesting details; and Prutz's *Kulturgeschichte der Kreuzzüge* contains both an account of the Latin East and an attempt to sketch the effects of the Crusades on the progress of civilization. The works of Gmelin and J. Delaville-Leroulx on the Templars and Hospitaliers respectively are worth consulting; while for Eastern affairs the English reader may be referred to G. Lestrangle's *Palestine under the Moslem*, and to Stanley Lane-Poole's *Life of Saladin* and his *Mahommedan Dynasties* (the latter a valuable work of reference). (E. BR.)

**CRUSENSTOLPE, MAGNUS JAKOB** (1795-1865), Swedish historian, early became famous both as a political and a historical writer. His first important work was a *History of the Early Years of the Life of King Gustavus IV. Adolphus*, which was followed by a series of monographs and by some politico-historical novels, of which *The House of Holstein-Gottorp in Sweden* is considered the best. He obtained a great influence over King Charles XIV. (Bernadotte), who during the years 1830-1833 gave him his fullest confidence, and sanctioned the official character of Crusenstolpe's newspaper *Fäderneslandet*. In the last-mentioned year, however, the historian suddenly became the king's bitterest enemy, and used his acrid pen on all occasions in attacking him. In 1838 he was condemned, for one of these angry utterances, to be imprisoned three years in the castle of Waxholm. He continued his literary labours until his death in 1865. Few Swedish writers have wielded so pure and so incisive a style as Crusenstolpe, but his historical work is vitiated by political and personal bias.

**CRUSIUS, CHRISTIAN AUGUST** (1715-1775), German philosopher and theologian, was born on the 10th of January 1715 at Lenau near Merseburg in Saxony. He was educated at Leipzig, and became professor of theology there in 1750, and principal of the university in 1773. He died on the 18th of October 1775. Crusius first came into notice as an opponent of the philosophy of Leibnitz and Wolff from the standpoint of religious orthodoxy. He attacked it mainly on the score of the moral evils that must flow from any system of determinism, and exerted himself in particular to vindicate the freedom of the will. The most important works of this period of his life are *Entwurf der notwendigen Vernunftwahrheiten* (1745), and *Weg zur Gewissheit und Zuverlässigkeit der menschlichen Erkenntnis* (1747). Though diffusely written, and neither brilliant nor profound, Crusius' philosophical books had a great but short-lived popularity. His criticism of Wolff, which is generally based on sound sense, had much influence upon Kant at the time when his system was forming; and his ethical doctrines are mentioned with respect in the *Kritik of Practical Reason*. Crusius's later life was devoted to theology. In this capacity his sincere piety and amiable character gained him great influence, and he led the party in the university which became known as the "Crusianer" as opposed to the "Ernestianer," the followers of J. A. Ernesti. The two professors adopted opposite methods of exegesis. Ernesti wished to subject the Scripture to the same laws of exposition as are applied to other ancient books; Crusius held firmly to orthodox ecclesiastical tradition. Crusius's chief theological works are *Hypomnemata ad theologiam prophetica* (1764-1778), and *Kurzer Entwurf der Moraltheologie* (1772-1773). He sets his face against innovation in such matters as the accepted authorship of canonical writings, verbal inspiration, and the treatment of persons and events in the Old Testament as types of the New. His views, unscholarly and uncritical as they seem to us now, have had influence on later evangelical students of the Old Testament, such as E. W. Hengstenberg and F. Delitzsch.

There is a full notice of Crusius in Ersch and Gruber's *Allgemeine Encyclopädie*. Consult also J. E. Erdmann's *History of Philosophy*; A. Marquardt, *Kant und Crusius*; and art. in Herzog-Hauck, *Realencyclopädie* (1898). (H. ST.)

**CRUSTACEA**, a very large division of the animal kingdom, comprising the familiar crabs, lobsters, crayfish, shrimps and prawns, the sandhoppers and woodlice, the strangely modified barnacles and the minute water-fleas. Besides these the group also includes a multitude of related forms which, from their

<sup>1</sup> The bibliography of the Fourth Crusade is discussed in Klimke, *Die Quellen zur Geschichte des vierten Kreuzzuges* (Breslau, 1875).

aquatic habits and generally inconspicuous size, and from the fact that they are commonly neither edible nor noxious, are little known except to naturalists and are undistinguished by any popular names. Collectively, they are ranked as one of the classes forming the sub-phylum ARTHROPODA, and their distinguishing characters are discussed under that heading. It will be sufficient here to define them as Arthropoda for the most part of aquatic habits, having typically two pairs of antenniform appendages in front of the mouth and at least three pairs of post-oral limbs acting as jaws.

As a matter of fact, however, the range of structural variation within the group is so wide, and the modifications due to parasitism and other causes are so profound, that it is almost impossible to frame a definition which shall be applicable to all the members of the class. In certain parasites, for instance, the adults have lost every trace not only of Crustacean but even of Arthropodous structure, and the only clue to their zoological position is that afforded by the study of their development. In point of size also the Crustacea vary within very wide limits. Certain water-fleas (Cladocera) fall short of one-hundredth of an inch in total length; the giant Japanese crab (*Macrocheira*) can span over 10 ft. between its outstretched claws.

The habits of the Crustacea are no less diversified than their structure. Most of them inhabit the sea, but representatives of all the chief groups are found in fresh water (though the Cirripedia have hardly gained a footing there), and this is the chief home of the primitive Phyllopora. A terrestrial habitat is less common, but the widely-distributed land Isopoda or woodlice and the land-crabs of tropical regions have solved the problem of adaptation to a subaerial life.

Swimming is perhaps the commonest mode of locomotion, but numerous forms have taken to creeping or walking, and the robber-crab (*Birgus latro*) of the Indo-Pacific islands even climbs palm-trees. None has the power of flight, though certain pelagic Copepoda are said to leap from the surface of the sea like flying-fish. Apart from the numerous parasitic forms, the only Crustacea which have adopted a strictly sedentary habit of life are the Cirripedia, and here, as elsewhere, profound modifications of structure have resulted, leading ultimately to a partial assumption of the radial type of symmetry which is so often associated with a sedentary life.

Many, perhaps the majority, of the Crustacea are omnivorous or carrion-feeders, but many are actively predatory in their habits, and are provided with more or less complex and efficient instruments for capturing their prey, and there are also many plant-eaters. Besides the sedentary Cirripedia, numbers of the smaller forms, especially among the Entomostraca, subsist on floating particles of organic matter swept within reach of the jaws by the movements of the other limbs.

Symbiotic association with other animals, in varying degrees of interdependence, is frequent. Sometimes the one partner affords the other merely a convenient means of transport, as in the case of the barnacles which grow on, or of the gulf-weed crab which clings to, the carapace of marine turtles. From this we may pass through various grades of "commensalism," like that of the hermit-crab with its protective anemones, to the cases of actual parasitism. The parasitic habit is most common among the Copepoda and Isopoda, where it leads to complex modifications of structure and life-history. Perhaps the most complete degeneration is found in the Rhizocephala, which are parasitic on other Crustacea. In these the adult consists of a simple saccular body containing the reproductive organs and attached by root-like filaments which ramify throughout the body of the host and serve for the absorption of nourishment (fig. 1).

Many of the larger species of Crustacea are used as food by man, the most valuable being the lobster, which is caught in large quantities on both sides of the North Atlantic. Perhaps the most important of all Crustacea, however, with respect to the part which they play in the economy of nature, are the minute pelagic Copepoda, of which incalculable myriads form an important constituent of the "plankton" in all the seas of

the globe. It is on the plankton that a great part of the higher animal life of the sea ultimately depends for food. The Copepoda live upon the diatoms and other important microscopic vegetable life at the surface of the sea, and in their turn serve as food for fishes and other larger forms and thus, indirectly, for man himself.

*Historical Sketch.*—In common with most branches of natural history, the science of Carcinology may be traced back to its beginnings in the writings of Aristotle. It received additions

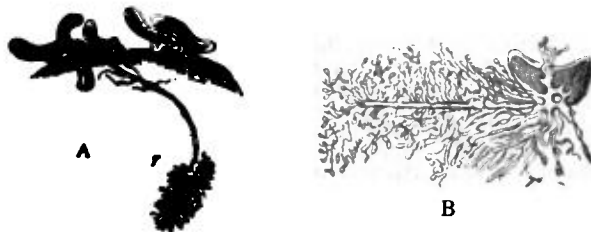

FIG. 1.

A, Group of *Pellogaster socialis* on the abdomen of a small hermit-crab; in one of them the fasciculate ramified roots, *r*, in the liver of the crab are shown (Fritz Müller).

B, Young of *Sacculina purpurea* with its roots. Magn. 5 diam. (Fritz Müller).

of varying importance at the hands of medieval and later naturalists, and first began to assume systematic form under the influence of Linnaeus. The application of the morphological method to the Crustacea may perhaps be dated from the work of J. C. Fabricius towards the end of the 18th century.

In the first quarter of the 19th century important advances in classification were made by P. A. Latreille, W. E. Leach and others, and J. Vaughan Thompson demonstrated the existence of metamorphosis in the development of the higher Crustacea. A new epoch may be said to begin with H. Milne-Edwards' classical *Histoire naturelle des crustacés* (1834-1840). It is noteworthy that even at this late date the Cirripedia (Thyrostrea) were still excluded from the Crustacea, though Darwin's Monograph (1851-1854) was soon to make them known with a wealth of anatomical and systematic detail such as was available, at that time, for few other groups of Crustacea. About the same period three authors call for special mention, W. de Haan, J. D. Dana and H. Kröyer. The new impulse given to biological research by the publication of the *Origin of Species* bore fruit in Fritz Müller's *Für Darwin*, in which an attempt was made to reconstruct the phylogenetic history of the class. The same line of work was followed in the long series of important memoirs from the pen of K. F. W. Claus, and noteworthy contributions were made, among many others, by A. Dohrn, Ray Lankester and Huxley. In more recent years the long and constantly increasing list of writers on Crustacea contains no name more honoured than that of the veteran G. O. Sars of Christiania.

#### Morphology.

*External Structure: Body.*—As in all Arthropoda the body consists of a series of segments or somites which may be free or more or less coalesced together. In its simplest form the exoskeleton of a typical somite is a ring of chitin defined from the rings in front and behind by areas of thinner integument forming moveable joints, and having a pair of appendages articulated to its ventral surface on either side of the middle line. Frequently, however, this exoskeletal somite may be differentiated into various regions. A dorsal and a ventral plate are often distinguished, known respectively as the tergum and the sternum, and the tergum may overhang the insertion of the limb on each side as a free plate called the pleuron. The name epimeron is sometimes applied to what is here called the pleuron, but the word has been used in widely different senses and it seems better to abandon it. The typical form of a somite is well seen, for example, in the segments which make up the abdomen or "tail" of a lobster or crayfish (fig. 2). The posterior terminal segment of the body, on which the opening of the anus is situated, never bears appendages. The nature of this segment, which is

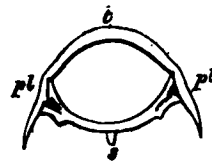

FIG. 2. — Abdominal Somite of a Lobster, separated and viewed from in front. *t*, tergum; *s*, sternum; *pl*, pleuron.

known as the "anal segment" or telson (fig. 3, *T*), has been much discussed, some authorities holding that it is a true somite, homologous with those which precede it. Others have regarded it as representing the fusion of a number of somites, and others again as a "median appendage" or as a pair of appendages fused. Its morphological nature, however, is clearly shown by its development. In the larval development of the more primitive Crustacea, the number of somites, at first small, increases by the successive appearance of new somites between the last-formed somite and the terminal region which bears the anus. The "growing point" of the trunk is, in fact, situated in front of this region, and, when the full number of somites has been reached, the unsegmented part remaining forms the telson of the adult.

In no Crustacean, however, do all the somites of the body remain distinct. Coalescence, or suppression of segmentation ("lipomerism"), may involve more or less extensive regions. This is especially the case in the anterior part of the body, where, in correlation with the "adaptational shifting of the oral aperture" (see ARTHROPODA), a varying number of somites unite to form the "cephalon" or head. Apart from the possible existence of an ocular

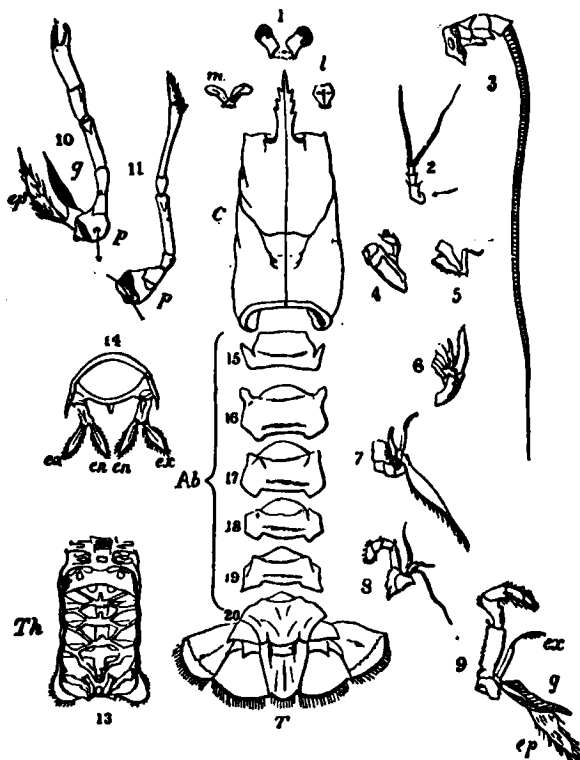

FIG. 3.—The Separated Somites and Appendages of the Common Lobster (*Homarus gammarus*).

- |   |   |
|---|---|
| C, carapace covering the cephalothorax.   | 6, maxilla (second maxilla).  |
| Ab, abdominal somites.  | 7-9, first, second and third maxillipeds.   |
| T, telson, having the uropods or appendages of the last abdominal somite spread out on either side of it, forming the "tail-fan." | ex, exopodite.  |
| l, labrum, or upper lip.  | ep, epipodite.  |
| m, metastoma, or lower lip.   | g, gill.  |
| 1, eyes.  | 10, sixth thoracic limb (second walking-leg) of female.                                 |
| 2, antennule (the arrow points to the opening of the so-called auditory organ).   | 11, last thoracic limb of male. In 10 and 11 the arrows indicate the genital apertures. |
| 3, antenna.   | 13, sterna of the thoracic somites, from within.  |
| 4, mandible.  | 14, third abdominal somite, with appendages or "swimmerets."                            |
| 5, maxillula (or first maxilla).  |   |

somite corresponding to the eyes (the morphological nature of which is discussed below), the smallest number of head-somites so united in any Crustacean is five. Even where a large number of the somites have fused, there is generally a marked change in the character of the appendages after the fifth pair, and since the integumental fold which forms the carapace seems to originate from this point, it is usual to take the fifth somite as the morphological limit of the cephalon throughout the class. It is quite probable, however, that in the primitive ancestors of existing Crustacea a still smaller number of somites formed the head. The three pairs of appendages present in the "nauplius" larva show certain peculiarities of

structure and development which seem to place them in a different category from the other limbs, and there is some ground for regarding the three corresponding somites as constituting a "primary cephalon." For practical purposes, however, it is convenient to include the two following somites also as cephalic.

A remarkable feature found only in the Stomatopoda is the reappearance of segmentation in the anterior part of the cephalic region. Whether the movably articulated segments which bear the

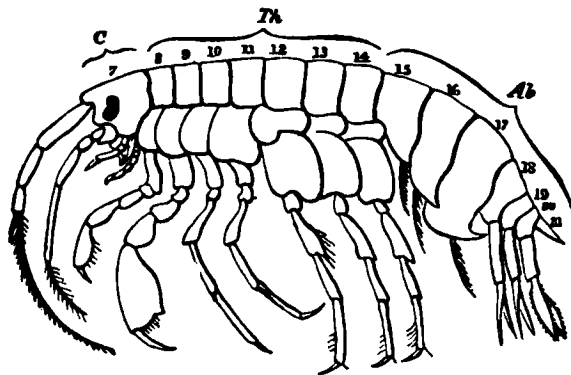

FIG. 4.—Diagram of an Amphipod. (After Spence Bate and Westwood.)

- |  |   |
|--|---|
| C, cephalon.   | Ab, abdomen.  |
| Th, thorax. (Only seven of the eight thoracic somites are visible, the first being fused with the cephalon.) | The numbers appended to the somites do not correspond to the enumeration adopted in the text. 21 is the telson. |

eyestalks and the antennules in this aberrant group correspond to the primitive head somites or not, their distinctness is certainly a secondarily acquired character, for it is not found in the larvae, nor in any of the more primitive groups of Malacostraca.

The body proper is usually divisible into two regions to which the names *thorax* and *abdomen* are applied. Throughout the whole of the Malacostraca the thorax consists of eight and the abdomen of six somites (fig. 4), and the two regions are sharply distinguished by the character of their appendages. In the various groups of the Entomostraca, on the other hand, the terms thorax and abdomen, though conveniently employed for purposes of systematic description, do not imply any homology with the regions so named in the Malacostraca. Sometimes they are applied, as in the Copepoda, to the limb-bearing and limbless regions of the trunk, while in other cases, as in the Phyllopoda, they denote, respectively, the regions in front of and behind the genital apertures.

A character which recurs in the most diverse groups of the Crustacea, and which is probably to be regarded as a primitive attribute

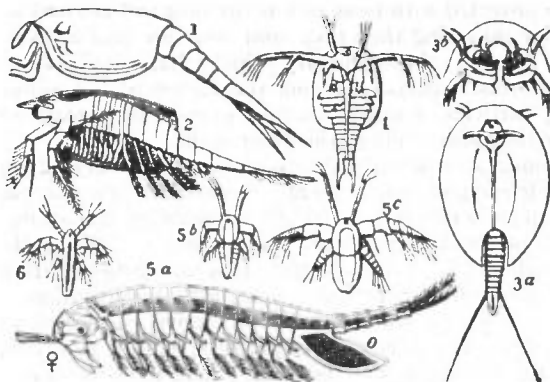
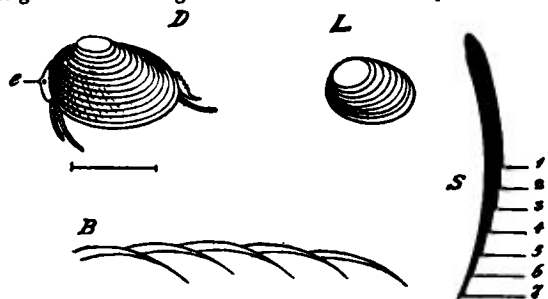

FIG. 5.—Phyllopoda and Phyllocarida.

- |   |   |
|---|---|
| 1, <i>Ceratiocaris papilio</i> , U. Silurian, Lanark. head showing the labrum and mouth-parts.              | 4, larva of <i>Apus cancriformis</i> .  |
| 2, <i>Nebalia bipes</i> (one side of).  | 5, <i>Branchipus stagnalis</i> : a, adult female; b, first larval stage (Nauplius); c, second larval stage. |
| 3, <i>Lepidurus Angassi</i> : a, dorsal aspect; b, ventral aspect of 6, Nauplius of <i>Artemia salina</i> . |   |

of the class, is the possession of a carapace or shell, arising as a dorsal fold of the integument from the posterior margin of the head-region. In its most primitive form, as seen in the *Apodidae* (fig. 5, 3) and in *Nebalia* (fig. 5, 2), this shell-fold remains free from the trunk, which it envelops more or less completely. It may assume the form of a bivalve shell entirely enclosing the body and limbs, as in many

Phyllopoda (fig. 6) and in the Ostracoda. In the Cirripedia it forms a fleshy "mantle" strengthened by shelly plates or valves which may assume a very complex structure. In many cases, however, the shell-fold coalesces with some of the succeeding somites. In the Decapoda (fig. 3), this coalescence affects only the dorsal region of the thoracic somites, and the lateral portions of the carapace overhang on each side, enclosing a pair of chambers within which lie the gills. The arrangement is similar in Schizopoda and Stomato-



From Morse's Zoology.

FIG. 6.—*Estheria*, sp.; D from Dubuque, Iowa; (e) the eye. L from Lynn, Massachusetts (nat. size). S presents a highly magnified section of one of the valves to show the successive moults. B an enlarged portion of the edge of the shell along the back, showing the overlap of each growth.

poda (fig. 7), except that the coalescence does not usually involve the posterior thoracic somites, several of which remain free, though they may be overlapped by the carapace.

In the Isopoda and Amphipoda, where, as a rule, all the thoracic somites except the first are distinct (fig. 4), there seems at first sight to be no shell-fold. A comparison with the related Tanaidacea (fig. 8) and Cumacea (or Sympoda), however, leads to the conclusion that the coalescence of the first thoracic somite with the cephalon really involves a vestigial shell-fold, and, indeed, traces of this are said to be observed in the embryonic development of some Isopoda. It seems likely that a similar explanation is to be applied to the coalescence of one or two trunk-somites with the head in the Copepoda, and, if this be so, the only Crustacea remaining in which no trace of a shell-fold is found in the adult are the Anostracous Phyllopoda such as *Branchipus* (fig. 5. 5).

**General Morphology of Appendages.**—Amid the great variety of forms assumed by the appendages of the Crustacea, it is possible to trace, more or less plainly, the modifications of a fundamental type consisting of a peduncle, the protopodite, bearing two branches, the endopodite and exopodite.

This simple biramous form is shown in the swimming-feet of the Copepoda and Branchiura, the "cirri" of the Cirripedia, and the abdominal appendages of the Malacostraca (fig. 3, 14). It is also found in the earliest and most primitive form of larva, known as the *Nauplius*. As a rule the protopodite is composed of two segments, though one may be reduced or suppressed and occasionally three may be present. In many cases, one of the branches, generally the endopodite, is more strongly developed than the other. Thus, in the thoracic limbs of the Malacostraca, the endopodite generally forms a walking-leg while the exopodite becomes a swimming-branch or may disappear altogether. Very often the basal segment of the protopodite bears, on the outer side, a lamellar appendage (more rarely, two), the epipodite, which may function as a gill. In the appendages near the mouth one or both of the protopodal segments may bear inwardly-turned processes, assisting in mastication and known as gnathobases. The frequent occurrence of epipodites and gnathobases tends to show that the primitive type of appendage was more complex than the simple biramous limb, and some authorities have regarded the leaf-like appendages of the Phyllopoda as nearer the original form from which the various modifications found in other groups have been derived. In a Phyllopod such as *Apus* the limbs of the trunk consist of a flattened, unsegmented or obscurely segmented axis or corm having a series of lobes or processes known as endites and exites on its inner and outer margins respectively. In all the Phyllopoda the number of endites is six, and the proximal one is

FIG. 7.—*Squilla mantis* (Stomatopoda), showing the last four thoracic (leg-bearing) somites free from the carapace.

more or less distinctly specialized as a gnathobase, working against its fellow of the opposite side in seizing food and transferring it to the mouth. The Phyllopoda are the only Crustacea in which distinct and functional gnathobasic processes are found on appendages far removed from the mouth. The two distal endites are regarded as corresponding to the endopodite and exopodite of the higher Crustacea, the axis or corm of the Phyllopod limb representing the protopodite. The number of exites is less constant, but, in *Apus*, two are present, the proximal branchial in function and the distal forming a stiffer plate which probably aids in swimming. It is not altogether easy to recognize the homologues of the endites and exites even within the order Phyllopoda, and the identification of the two distal endites as corresponding to the endopodite and exopodite of higher Crustacea is not free from difficulty. It is highly probable, however, that the biramous limb is a simplification of a more complex primitive type, to which the Phyllopod limb is a more or less close approximation.

The modifications which this original type undergoes are usually more or less plainly correlated with the functions which the appendages have to discharge. Thus, when acting as swimming organs, the appendages, or their rami, are more or less flattened, or oar-like, and often have the margins fringed with long plumose hairs. When used for walking, one of the rami, usually the inner, is stout and cylindrical, terminating in a claw, and having the segments united by definite hinge-joints. The jaws have the gnathobasic endites developed at the expense of the rest of the limb, the endopodite

and exopodite persisting only as sensory "palps" or disappearing altogether. When specialized as bearers of sensory (olfactory and tactile) organs, the rami are generally elongated, many-jointed and flagelliform. This modification is usually only found in the antennules and antennae, but it may exceptionally be found in the appendages of the trunk, as, for instance, in the thoracic legs of some Decapods (e.g. *Mastigocheirus*). Very often one or other of the appendages may be modified for prehension, the seizing of prey or the holding of a mate. In this case, the claw-like terminal segment may be simply flexed against the preceding in the same way as the blade of a penknife shuts up against the handle. The penultimate segment is often broadened, so that the terminal claw shuts against a transverse edge (fig. 4), or, finally, the penultimate segment may be produced into a thumb-like process opposed to the movable terminal segment or finger, forming a perfect chela or forceps, as, for instance, in the large claws of a crab or lobster. This chelate condition may be assumed by almost any of the appendages, and sometimes it appears in different appendages in closely related forms, so that no very great phylogenetic importance can in most cases be attached to it. A peculiar modification is found in the trunk-limbs of the Cirripedia (fig. 9), in which both rami are multiarticulate and filiform and fringed with long bristles. When highly magnified view of one of the protruded from the opening of the shell these "cirri" are spread out to form a casting-net for the capture of minute floating prey.

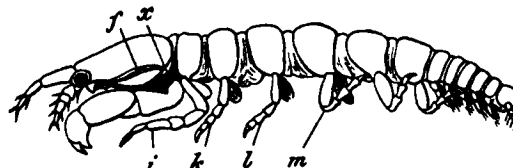

FIG. 8.—*Tanais dubius* (?) Kr. ♀, magnified 25 times, showing the orifice of entrance (x) into the cavity overarched by the carapace in which an appendage of the maxilliped (f) plays. On four feet (i, k, l, m) are the rudiments of the lamellae which subsequently form the brood-cavity. (Fritz Müller.)

Gills or branchiae may be developed by parts of an appendage becoming thin-walled and vascular and either expanded into a thin lamella or ramified. Some of the special modifications of branchiae are referred to below.

**Special Morphology of Appendages.**—In many Crustacea the eyes are borne on stalks which are movably articulated with the head and which may be divided into two or three segments. The view is commonly held that these eye-stalks are really limbs, homologous with the other appendages. In spite of much discussion, however, it cannot be said that this point has been finally settled. The evidence of embryology is decidedly against the view that the eye-stalks are limbs. They are absent in the earliest and most primitive

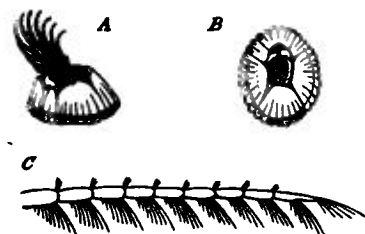

FIG. 9.—A, *Balanus* (young), side view with cirri protruded. B, Upper view of same; valves closed. C, with long bristles. When highly magnified view of one of the protruded from the opening of the shell these "cirri" are spread out to form a casting-net for the capture of minute floating prey.

Gills or branchiae may be developed by parts of an appendage becoming thin-walled and vascular and either expanded into a thin lamella or ramified. Some of the special modifications of branchiae are referred to below.

**Special Morphology of Appendages.**—In many Crustacea the eyes are borne on stalks which are movably articulated with the head and which may be divided into two or three segments. The view is commonly held that these eye-stalks are really limbs, homologous with the other appendages. In spite of much discussion, however, it cannot be said that this point has been finally settled. The evidence of embryology is decidedly against the view that the eye-stalks are limbs. They are absent in the earliest and most primitive



larval forms (nauplius), and appear only late in the course of development, after many of the trunk-limbs are fully formed. In the development of the Phyllopod *Branchipus*, the eyes are at first sessile, and the lateral lobes of the head on which they are set grow out and become movably articulated, forming the peduncles. The most important evidence in favour of their appendicular nature is afforded by the phenomena of regeneration. When the eye-stalk is removed from a living lobster or prawn, it is found that under certain conditions a many-jointed appendage like the flagellum of an antennule or antenna may grow in its place. It is open to question, however, how far the evidence from such "heteromorphic regeneration" can be regarded as conclusive on the points of homology. The fact that in certain rare cases among insects a leg may apparently be replaced by a wing tends to show that under exceptional conditions similar forms may be assumed by non-homologous parts.

The antennules (or first antennae) are almost universally regarded as true appendages, though they differ from all the other appendages in the fact that they are always innervated from the "brain" (or preoral ganglia), and that they are uniramous in the nauplius larva and in all the Entomostracan orders. As regards their innervation an apparent exception is found in the case of *Apus*, where the nerves to the antennules arise, behind the brain, from the oesophageal commissures, but this is, no doubt, a secondary condition, and the nerve-fibres have been traced forwards to centres within the brain. In the Malacostraca, the antennules are often biramous, but there is considerable doubt as to whether the two branches represent the endopodite and exopodite of the other limbs, and three branches are found in the Stomatopoda and in some Caridea. In the great majority of Crustacea the antennules are purely sensory in function and carry numerous "olfactory" hairs. They may, however, be natatory as in many Ostracoda and Copepoda, or prehensile, as in some Copepoda. The most peculiar modification, perhaps, is that found in the Cirripedia (Thyrostraca), in the larvae of which the antennules develop into organs of attachment, bearing the openings of the cement-glands, and becoming, in the adult, involved in the attachment of the animal to its support.

The antennae (second antennae) are of special interest on account of the clear evidence that, although preoral in position in all adult Crustacea, they were originally postoral appendages. In the nauplius larva they lie rather at the sides than in front of the mouth, and their basal portion carries a hook-like masticatory process which assists the similar processes of the mandibles in seizing food. In the primitive Phyllopoda, and less distinctly in some other orders, the nerves supplying the antennae arise, not from the brain, but from the circum-oesophageal commissures, and even in those cases where the nerves and the ganglia in which they are rooted have been moved forwards to the brain, the transverse commissure of the ganglia can still be traced, running behind the oesophagus.

The functions of the antennae are more varied than is the case with the antennules. In many Entomostraca (Phyllopoda, Cladocera, Ostracoda, Copepoda) they are important, and sometimes the only, organs of locomotion. In some male Phyllopoda they form complex "claspers" for holding the female. They are frequently organs of attachment in parasitic Copepoda, and they may be completely pediform in the Ostracoda. In the Malacostraca they are chiefly sensory, the endopodite forming a long flagellum, while the exopodite may form a lamellar "scale," probably useful as a balancer in swimming, or may disappear altogether. A very curious function sometimes discharged by the antennules or antennae of Decapods is that of forming a respiratory siphon in sand-burrowing species.

The mandibles, like the antennae, have, in the nauplius, the form of biramous swimming limbs, with a masticatory process originating from the proximal part of the protopodite. This form is retained, with little alteration in some adult Copepoda, where the biramous "palp" still aids in locomotion. A somewhat similar structure is found also in some Ostracoda. In most cases, however, the palp loses its exopodite and it often disappears altogether, while the coxal segment forms the body of the mandible, with a masticatory edge variously armed with teeth and spines. In a few Ostracoda, by a rare exception, the masticatory process is reduced or suppressed, and the palp alone remains, forming a pediform appendage used in locomotion as well as in the prehension of food. In parasitic blood-sucking forms the mandibles often have the shape of piercing stylets, and are enclosed in a tubular proboscis formed by the union of the upper lip (labrum) with the lower lip (hypostome or paragnatha).

The maxillulae and maxillae (or, as they are often termed, first and second maxillae) are nearly always flattened leaf-like appendages, having gnathobasic lobes or endites borne by the segments of the protopodite. The endopodite, when present, is unsegmented or composed of few segments and forms the "palp," and outwardly-directed lobes representing the exopodite and epipodites may also be present. These limbs undergo great modification in the different groups. The maxillulae are sometimes closely connected with the "paragnatha" or lobes of the lower lip, when these are present, and it has been suggested that the paragnatha are really the basal endites which have become partly separated from the rest of the appendage.

The limbs of the post-cephalic series show little differentiation

among themselves in many Entomostraca. In the Phyllopoda they are for the most part all alike, though one or two of the anterior pairs may be specialized as sensory (*Apus*) or grasping (*Estheriidae*) organs. In the Cirripedia (Thyrostraca) the six pairs of biramous cirriform limbs differ only slightly from each other, and in many Copepoda this is also the case. In other Entomostraca considerable differentiation may take place, but the series is never divided into definite "tagmata" or groups of similarly modified appendages. It is highly characteristic of the Malacostraca, however, that the trunk-limbs are divided into two sharply defined tagmata corresponding to the thoracic and abdominal regions respectively, the limit between the two being marked by the position of the male genital openings. The thoracic limbs have the endopodites converted, as a rule, into more or less efficient walking-legs, and the exopodites are often lost, while the abdominal limbs more generally preserve the biramous form and are, in the more primitive types, natatory. These tagmata may again be subdivided into groups preserving a more or less marked individuality. For example, in the Amphipoda (fig. 4) the abdominal appendages are constantly divided into an anterior group of three natatory "swimmerets" and a posterior group of three limbs used chiefly in jumping or in burrowing. In nearly all Malacostraca the last pair of abdominal appendages (uropods) differ from the others, and in the more primitive groups they form, with the telson, a lamellar "tail-fan" (fig. 3, 7), used in springing backwards through the water. In the thoracic series it is usual for one or more of the anterior pairs to be pressed into the service of the mouth, forming "foot-jaws" or maxillipeds. In the Decapoda three pairs are thus modified, and in the Tanaidacea, Isopoda and Amphipoda only one. In the Schizopoda and Cumacea the line of division is less sharp, and the varying number of so-called maxillipeds recognized by different authors gives rise to some confusion of terminology in systematic literature.

*Gills.*—In many of the smaller Entomostraca (Copepoda and most Ostracoda) no special gills are present, and respiration is carried on by the general surface of the body and limbs. When present, the branchiae are generally differentiations of parts of the appendages, most often the epipodites, as in the Phyllopoda. In the Cirripedia, however, they are vascular processes from the inner surface of the mantle or shell-fold, and in some Ostracoda they are outgrowths from the sides of the body. In the primitive Malacostraca the gills were probably, as in the Phyllopoda and in *Nebalia*, the modified epipodites of the thoracic limbs, and this is the condition found in some Schizopoda. In the Cumacea and Tanaidacea only the first thoracic limb has a branchial epipodite. In the Amphipoda, the gills though arising from the inner side of the bases of the thoracic legs are probably also epipodial in nature. In the Isopoda the respiratory function has been taken over by the abdominal appendages, both rami or only the inner becoming thin or flattened. In the Decapoda the branchial system is more complex. The gills are inserted at the base of the thoracic limbs, and lie within a pair of branchial chambers covered by the carapace. Three series are distinguished, *podobranchiae*, attached to the proximal segments of the appendages, *pleurobranchiae*, springing from the body-wall, and an intermediate series, *arthrobranchiae*, inserted on the articular membrane of the joint between the limb and the body. The *podobranchiae* are clearly epipodites, or, more correctly, parts of the epipodites, and it is probable that the arthro- and pleuro-branchiae are also epipodial in origin and have migrated from the proximal segment of the limbs on to the adjacent body-wall.

Adaptations for aerial respiration are found in some of the land-crabs, where the lining membrane of the gill-chamber is beset with vascular papillae and acts as a lung. In some of the terrestrial Isopoda or woodlice (Oniscoidea) the abdominal appendages have ramified tubular invaginations of the integument, filled with air and resembling the tracheae of insects.

*Internal Structure: Alimentary System.*—In almost all Crustacea the food-canal runs straight through the body, except at its anterior end, where it curves downwards to the ventrally-placed mouth. In a few cases its course is slightly sinuous or twisted, but the only cases in which it is actually coiled upon itself are found in the Cladocera of the family *Lynceidae* (*Alonidae*) and in a single recently-discovered genus of Cumacea (Symopoda). As in all Arthropoda, it is composed of three divisions, a fore-gut or stomodaeum, ectodermal in origin and lined by an inturning of the chitinous cuticle, a mid-gut formed by endoderm and without a cuticular lining, and a hind-gut or proctodaeum, which, like the fore-gut, is ectodermal and is lined by cuticle. The relative proportions of these three divisions vary considerably, and the extreme abbreviation of the mid-gut found in the common crayfish (*Astacus*) is by no means typical of the class. Even in the closely-related lobster (*Homarus*) the mid-gut may be 2 or 3 in. long.

In a few Entomostraca (some Phyllopoda and Ostracoda) the chitinous lining of the fore-gut develops spines and hairs which help to triturate and strain the food, and among the Ostracods there is occasionally (*Bairdia*) a more elaborate armature of toothed plates moved by muscles. It is among the Malacostraca, however, and especially in the Decapoda, that the "gastric mill" reaches its greatest perfection. In most Decapods the "stomach" or dilated portion of the fore-gut is divided into two chambers, a large anterior "cardiac" and a smaller posterior "pyloric." In the narrow

opening between these, three teeth (fig. 10) are set, one dorsally and one on each side. These teeth are connected with a framework of movably articulated ossicles developed as thickened and calcified portions of the lining cuticle of the stomach and moved by special muscles in such a way as to bring the three teeth together in the middle line. The walls of the pyloric chamber bear a series of pads and ridges beset with hairs and so disposed as to form a straining apparatus.

The mid-gut is essentially the digestive and absorptive region of the alimentary canal, and its surface is, in most cases, increased by pouch-like or tubular outgrowths which not only serve as glands for the secretion of the digestive juices, but may also become filled by the more fluid portion of the partially digested food and facilitate its absorption. These outgrowths vary much in their arrangement in the different groups. Most commonly there is a pair of lateral caeca, which may be more or less ramified and may form a massive "hepato-pancreas" or "liver."

The whole length of the alimentary canal is provided, as a rule, with muscular fibres, both circular and longitudinal, running in its walls, and, in addition, there may be muscle-bands running between the gut and the body-wall. In the region of the oesophagus these muscles are more strongly developed to perform the movements of deglutition, and, where a gastric mill is present, both intrinsic and extrinsic muscles co-operate in producing the movements of its various parts. The hind-gut is also provided with sphincter and dilator muscles, and these may produce rhythmic expansion and contraction, causing an inflow and outflow of water through the anus, which has been supposed to aid in respiration.

In the parasitic Rhizocephala and in a few Copepoda (*Monstrilidae*) the alimentary canal is absent or vestigial throughout life.

**Circulatory System.**—As in the other Arthropoda, the circulatory system in Crustacea is largely lacunar, the blood flowing in spaces or channels without definite walls. These spaces make up the apparent body-cavity, the true body-cavity or coelom having been, for the most part, obliterated by the great expansion of the blood-containing spaces. The heart is of the usual Arthropodous type, lying in a more or less well-defined pericardial blood-sinus, with which it communicates by valvular openings or ostia. In the details of the system, however, great differences exist within the limits of the class. There is every reason to believe that, in the primitive Arthropoda, the heart was tubular in form, extending the whole length of the body, and having a pair of ostia in each somite. This arrangement is retained in some of the Phyllopoda, but even in that group a progressive abbreviation of the heart, with a diminution in the

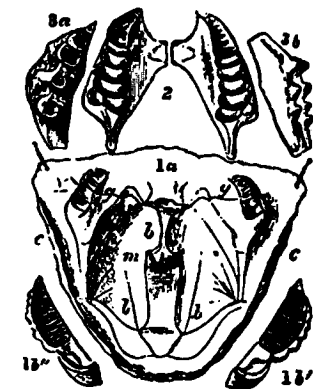

FIG. 10.—Gastric Teeth of Crab and Lobster.

- 1a, Stomach of common crab, *Cancer pagurus*, laid open, showing *b, b, b*, some of the calcareous plates inserted in its muscular coat; *g, g*, the lateral teeth, which when in use are brought in contact with the sides of the median tooth *m*; *c, c*, the muscular coat.
- 1b' and 1b'', The gastric teeth enlarged to show their grinding surfaces.
- 2, Gastric tooth of common lobster, *Homarus vulgaris*.
- 3a and 3b, Two crustacean teeth (of *Dithyrocaris*) from the Carboniferous series of Renfrewshire (these, however, may be the toothed edges of the mandibles).

number of the ostia, can be traced, leading to the condition found in the closely related Cladocera, where the heart is a sub-globular sac, with only a single pair of ostia. In the Malacostraca, an elongated heart with numerous segmentally arranged ostia is found only in the aberrant group of Stomatopoda and in the transitional Phyllocarida. In the other Malacostraca the heart is generally abbreviated, and even where, as in the Amphipoda, it is elongated and tubular, the ostia are restricted in number, three pairs only being usually present. In many Entomostraca the heart is absent, and it is impossible to speak of a "circulation" in the proper sense of the term, the blood being merely driven hither and thither by the movements of the body and limbs and of the alimentary canal.

A very remarkable condition of the blood-system, unique, as far as is yet known among the Arthropoda, is found in a few genera of parasitic Copepoda (*Lernanthropus*, *Mytilicola*). In these there is a closed system of vessels, not communicating with the body-cavity, and containing a coloured fluid. There is no heart. The morphological nature of this system is unknown.

**Excretory System.**—The most important excretory or renal organs of the Crustacea are two pairs of glands lying at the base of the antennae and of the second maxillae respectively. The two are probably never functional together in the same animal, though one may replace the other in the course of development. Thus, in the

Phyllopoda, the antennal gland develops early and is functional during a great part of the larval life, but it ultimately atrophies, and in the adult (as in most Entomostraca) the maxillary gland is the functional excretory organ. In the Decapoda, where the antennal gland alone is well-developed in the adult, the maxillary gland sometimes precedes it in the larva. The structure of both glands is essentially the same. There is a more or less convoluted tube with glandular walls connected internally with a closed "end-sac" and opening to the exterior by means of a thin-walled duct. Development shows that the glandular tube is mesoblastic in origin and is of the nature of a coelomduct, while the end-sac is to be regarded as a vestigial portion of the coelom. In the Branchiopoda the maxillary gland is lodged in the thickness of the shell-fold (when this is present), and, from this circumstance, it often receives the somewhat misleading name of "shell-gland." In the Decapoda the antennal gland is largely developed and is known as the "green gland." The external duct of this gland is often dilated into a bladder, and may sometimes send out diverticula, forming a complex system of sinuses ramifying through the body. The green gland and the structures associated with it in Decapods were at one time regarded as constituting an auditory apparatus.

In addition to these two pairs of glands, which are in all probability the survivors of a series of segmentally arranged coelomducts present in the primitive Arthropoda, other excretory organs have been described in various Crustacea. Although the excretory function of these has been demonstrated by physiological methods, however, their morphological relations are not clear. In some cases they consist of masses of mesodermal cells, within which the excretory products appear to be stored up instead of being expelled from the body.

**Nervous System.**—The central nervous system is constructed on the same general plan as in the other Arthropoda, consisting of a supra-oesophageal ganglionic mass or brain, united by circum-oesophageal connectives with a double ventral chain of segmentally arranged ganglia. In the primitive Phyllopoda the ventral chain retains the ladder-like arrangement found in some Annelids and lower worms, the two halves being widely separated and the pairs of ganglia connected together across the middle line by double transverse commissures. In the higher groups the two halves of the chain are more or less closely approximated and coalesced, and, in addition, a concentration of the ganglia in a longitudinal direction takes place, leading ultimately, in many cases, to the formation of an unsegmented ganglionic mass representing the whole of the ventral chain. This is seen, for example, in the Brachyura among the Decapoda. The brain, or supra-oesophageal ganglion, shows various degrees of complexity. In the Phyllopoda it consists mainly of two pairs of ganglionic centres, giving origin respectively to the optic and antennular nerves. The centres for the antennular nerves form ganglionic swellings on the oesophageal connectives. In the higher forms, as already mentioned, the antennal ganglia have become shifted forwards and coalesced with the brain. In the higher Decapoda, numerous additional centres are developed in the brain and its structure becomes extremely complex.

**Eyes.**—The eyes of Crustacea are of two kinds, the unpaired, median or "nauplius" eye, and the paired compound eyes. The former is generally present in the earliest larval stages (nauplius), and in some Entomostraca (e.g. Copepoda) it forms the sole organ of vision in the adult. In the Malacostraca it is absent in the adult, or persists only in a vestigial condition, as in some Decapoda and Schizopoda. It is typically tripartite, consisting of three cup-shaped masses of pigment, the cavity of each cup being filled with columnar retinal cells. At their inner ends (towards the pigment) these cells contain rod-like structures, while their outer ends are connected with the nerve-fibres. In some cases three separate nerves arise from the front of the brain, one going to each of the three divisions of the eye. In the Copepoda the median eye may undergo considerable elaboration, and refracting lenses and other accessory structures may be developed in connexion with it.

The compound eyes are very similar in the details of their structure (see ARTHROPODA) to those of insects (Hexapoda). They consist of a varying number of ommatidia or visual elements, covered by a transparent region of the external cuticle forming the cornea. In most cases this cornea is divided into lenticular facets corresponding to the underlying ommatidia.

As has been already stated, the compound eyes are often set on movable peduncles. It is probable that this is the primitive condition from which the sessile eyes of other forms have been derived. In the Malacostraca the sessile eyed groups are certainly less primitive than some of those with stalked eyes, and among the Entomostraca also there is some evidence pointing in the same direction.

Although typically paired, the compound eyes may occasionally coalesce in the middle line into a single organ. This is the case in the Cladocera, the Cumacea and a few Amphipoda.

Mention should also be made of the partial or complete atrophy of the eyes in many Crustacea which live in darkness, either in the deep sea or in subterranean habitats. In these cases the peduncles may persist and may even be modified into spinous organs of defence.

**Other Sense-Organs.**—As in Arthropoda, the hairs or setae on the surface of the body are important organs of sense and are variously modified for special sensory functions. Many, perhaps all, of them

are tactile. They are movably articulated at the base where they are inserted in pits formed by a thinning away of the cuticle, and each is supplied by a nerve-fibril. When feathered or provided with secondary barbs the setae will respond to movements or vibrations in the surrounding water, and have been supposed to have an auditory function. In certain divisions of the Malacostraca more specialized organs are found which have been regarded as auditory. In the majority of the Decapoda there is a saccular invagination of the integument in the basal segment of the antennular peduncle having on its inner surface "auditory" setae of the type just described. The sac is open to the exterior in most of the *Macrura*, but completely closed in the *Brachyura*. In the former case it contains numerous grains of sand which are introduced by the animal itself after each moult and which are supposed to act as otoliths. Where the sac is completely closed it generally contains no solid particles, but in a few *Macrura* a single otolith secreted by the walls of the sac is present. In the *Mysidae* among the Schizopoda a pair of similar otocysts are found in the endopodites of the last pair of appendages (uropods). These contain each a single concretionary otolith.

Recent observations, however, make it very doubtful whether aquatic Crustacea can hear at all, in the proper sense of the term, and it has been shown that one function, at least, of the so-called otocysts is connected with the equilibration of the body. They are more properly termed statocysts.

Another modification of sensory setae is supposed to be associated with the sense of smell. In nearly all Crustacea the antennules and often also the antennae bear groups of hair-like filaments in which the chitinous cuticle is extremely delicate and which do not taper to a point but end bluntly. These are known as olfactory filaments or aesthetascs. They are very often more strongly developed in the male sex, and are supposed to guide the males in pursuit of the females.

**Glands.**—In addition to the digestive and excretory glands already mentioned, various glandular structures occur in the different groups of Crustacea. The most important of these belong to the category of dermal glands, and may be scattered over the surface of the body and limbs, or grouped at certain points for the discharge of special functions. Such glands occurring on the upper and lower lips or on the walls of the oesophagus have been regarded as salivary. In some Amphipoda the secretion of glands on the body and limbs is used in the construction of tubular cases in which the animals live. In some freshwater Copepoda the secretion of the dermal glands forms a gelatinous envelope, by means of which the animals are able to survive desiccation. In certain Copepoda and Ostracoda glands of the same type produce a phosphorescent substance, and others, in certain Amphipoda and Branchiura, are believed to have a poisonous function. Possibly related to the same group of structures are the greatly-developed cement-glands of the Cirripedia, which serve to attach the animals to their support.

**Phosphorescent Organs.**—Many Crustacea belonging to very different groups (Ostracoda, Copepoda, Schizopoda, Decapoda) possess the power of emitting light. In the Ostracoda and Copepoda the phosphorescence, as already mentioned, is due to glands which produce a luminous secretion, and this is the case also in certain members of the Schizopoda and Decapoda. In other cases in the last two groups, however, the light-producing organs found on the body and limbs have a complex and remarkable structure, and were formerly described as accessory eyes. Each consists of a globular capsule pierced at one or two points for the entrance of nerves which end in a central cup-shaped "striated body." This body appears to be the source of light, and has behind it a reflector formed of concentric lamellae, while, in front, in some cases, there is a refracting lens. The whole organ can be rotated by special muscles. Organs of this type are best known in the *Euphausiidae* among the Schizopoda, but a modified form is found in some of the lower Decapods.

**Reproductive System.**—In the great majority of Crustacea the sexes are separate. Apart from certain doubtful and possibly abnormal instances among Phyllopoda and Amphipoda, the only exceptions are the sessile Cirripedia and some parasitic Isopoda (*Cymothoidae*), where hermaphroditism is the rule. Parthenogenesis is prevalent in the Branchiopoda and Ostracoda, often in more or less definite seasonal alternation with sexual reproduction. Where the sexes are distinct, a more or less marked dimorphism often exists. The male is very often provided with clasping organs for seizing the female. These may be formed by the modification of almost any of the appendages, often the antennules or antennae or some of the thoracic limbs, or even the mandibular palps (some Ostracoda). In addition, some of the appendages in the neighbourhood of the genital apertures may be modified for the purpose of transferring the genital products to the female, as, for instance, the first and second abdominal limbs in the Decapoda. In the higher Decapoda the male is generally larger than the female and has stronger chelae. On the other hand, in other groups the male is often smaller than the female. In the parasitic Copepoda and Isopoda the disparity in size is carried to an extreme degree, and the minute male is attached, like a parasite, to the enormously larger female.

The Cirripedia present some examples of sexual relationships which are only paralleled, in the animal kingdom, among the para-

sitic Myzostomida. While the great majority are simple hermaphrodites, capable of cross and self fertilization, it was discovered by Darwin that, in certain species, minute degraded males exist, attached within the mantle-cavity of the ordinary individuals. Since these dwarf males pair, not with females, but with hermaphrodites, Darwin termed them "complemental" males. In other species the large individuals have become purely female by atrophy of the male organs, and are entirely dependent on the dwarf males for fertilization. In spite of the opinion of some distinguished zoologists to the contrary, it seems most probable that the separation of the sexes is in this case a secondary condition, derived from hermaphroditism through the intermediate stage represented by the species having complemental males.

The gonads, as in other Arthropoda, are hollow saccular organs, the cavity communicating with the efferent ducts. They are primitively paired, but often coalesce with each other more or less completely. The ducts are present only as a single pair, except in one genus of parasitic Isopoda (*Hemioniscus*), where two pairs of oviducts are found. Various accessory structures may be connected with the efferent ducts in both sexes. The oviducts may have diverticula serving as receptacles for the spermatozoa (in cases where internal impregnation takes place), and may be provided with glands secreting envelopes or shells around the eggs. The male ducts often have glandular walls, secreting capsules or spermatophores within which the spermatozoa are packed for transference to the female. The terminal part of the male ducts may be protrusible and act as an intromittent organ, or this function may be discharged by some of the appendages, as, for instance, in the *Brachyura*.

The position of the genital apertures varies very greatly in the different groups of the class. They are farthest forward in the case of the female organs of the Cirripedia, where the openings are on the first thoracic (fourth postoral) somite. The most posterior

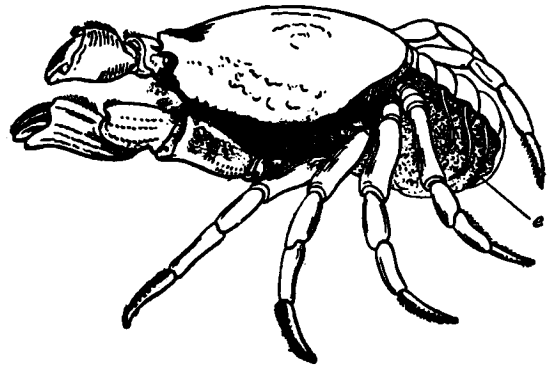

FIG. 11.—Side view of Crab, the abdomen extended and carrying a mass of eggs beneath it; *e*, eggs. (After Morse.)

position is occupied by the genital apertures of certain Phyllopoda (*Polyartemia*), which lie behind the nineteenth trunk-somite. It is characteristic of the Malacostraca that the position of the genital apertures is constantly different in the two sexes, the female openings being on the sixth, and those of the male on the eighth thoracic somite.

Very few Crustacea are viviparous in the sense that the eggs are retained within the body until hatching takes place (some Phyllopoda), but, on the other hand, the great majority carry the eggs in some way or other after their extrusion. In some Phyllopoda (*Apus*) egg-sacs are formed by modification of certain of the thoracic feet. The eggs are retained between the valves of the shell in some Phyllopoda and in the Cladocera and Ostracoda, and they lie in the mantle cavity in the Cirripedia. In the Copepoda they are agglutinated together into masses attached to the body of the female. Among the Malacostraca some Schizopoda, the Cumacea, Tanaidacea, Isopoda and Amphipoda (sometimes grouped all together as Peracarida) have a marsupium or brood-pouch formed by overlapping plates attached to the bases of some of the thoracic legs. In most of the Decapoda the eggs are carried by the female, attached to the abdominal appendages (fig. 11). A few cases are known in which the developing embryos are nourished by a special secretion while in the brood-chamber of the mother (Cladocera, terrestrial Isopoda).

#### Embryology.

The majority of the Crustacea are hatched from the egg in a form differing more or less from that of the adult, and pass through a series of free-swimming larval stages. There are many cases, however, in which the metamorphosis is suppressed, and the newly-hatched young resemble the parent in general structure. The relative size of the eggs and the amount of nutritive yolk which they contain are generally much greater in those forms which have a direct development.

The details of the early embryonic stages vary considerably within the limits of the class. They are of interest, however, rather from the point of view of general embryology than from that of

the special student of the Crustacea, and cannot be fully dealt with here.

Segmentation is usually of the superficial or centrolethical type. The hypoblast is formed either by a definite invagination or by the immigration of isolated cells, known as vitellophags, which wander through the yolk and later become associated into a definite mesenteron, or by some combination of these two methods. The blastopore generally occupies a position corresponding to the posterior end of the body. The mesoblast of the cephalic (naupliar) region probably arises in connexion with the lips of the blastopore and consists of loosely-connected cells or mesenchyme. In the region of the trunk, in many cases, paired mesoblastic bands are formed, growing in length by the division of teloblastic cells at the posterior end, and becoming segmented into somites. The existence of true coelom-sacs is somewhat doubtful. The rudiments of the first three pairs of appendages commonly appear simultaneously, and, even in forms with embryonic development, they show differences in their mode of appearance from the succeeding somites. Further, a definite cuticular membrane is frequently formed and shed at this stage, which corresponds to the nauplius-stage of larval development.

The larval metamorphoses of the Crustacea have attracted much attention, and have been the subject of much discussion in view of their bearing on the phylogenetic history of the group. In those Crustacea in which the series of larval stages is most complete, the starting-point is the form already mentioned under the name of *nauplius*. The typical nauplius (fig. 12) has an oval unsegmented body and three pairs of limbs corresponding to the antennules, antennae and mandibles of the adult. The antennules are uniramous, the others biramous, and all three pairs are used in swimming.

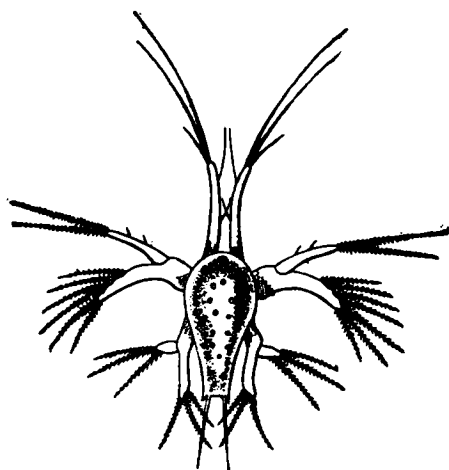

FIG. 12.—Nauplius of a Prawn (*Penaeus*). Magn. 45 diam. (Fritz Müller.)

The antennae have a spiniform or hooked masticatory process at the base, and share with the mandibles, which have a similar process, the function of seizing and masticating the food. The mouth is overhung by a large labrum or upper lip, and the integument of the dorsal surface of the body forms a more or less definite dorsal shield. The paired eyes are, as yet, wanting, but the unpaired eye is large and conspicuous. A pair of frontal papillae or filaments, probably sensory, are commonly present.

A nauplius larva differing only in details from the typical form just described is found in the majority of the Phyllopora, Copepoda and Cirripedia, and in a more modified form, in some Ostracoda. Among the Malacostraca the nauplius is less commonly found, but it occurs in the *Euphausiidae* among the Schizopoda and in a few of the more primitive Decapoda (*Penaeidea*) (fig. 12). In most of the Crustacea which hatch at a later stage there is, as already mentioned, more or less clear evidence of an embryonic nauplius stage. It seems certain, therefore, that the possession of a nauplius larva must be regarded as a very primitive character of the Crustacean stock.

As development proceeds, the body of the nauplius elongates, and indications of segmentation begin to appear in its posterior part. At successive moults the somites increase in number, new somites being added behind those already differentiated, from a formative zone in front of the telsonic region. Very commonly the posterior end of the body becomes forked, two processes growing out at the sides of the anus and often persisting in the adult as the "caudal furca." The appendages posterior to the mandibles appear as buds on the ventral surface of the somites, and in the most primitive cases they become differentiated, like the somites which bear them, in regular order from before backwards. The limb-buds early become bilobed and grow out into typical biramous appendages which gradually assume the characters found in the adult. With the elongation of the body, the dorsal shield begins to project posteriorly as a shell-fold, which may increase in size to envelop

more or less of the body or may disappear altogether. The rudiments of the paired eyes appear under the integument at the sides of the head, but only become pedunculated at a comparatively late stage.

The course of development here outlined, in which the nauplius gradually passes into the adult form by the successive addition of somites and appendages in regular order, agrees so well with the process observed in the development of the typical Annelida that we must regard it as being the most primitive method. It is most closely followed by the Phyllopora such as *Apus* or *Branchipus*, and by some Copepoda.

In most Crustacea, however, this primitive scheme is more or less modified. The earlier stages may be suppressed or passed through

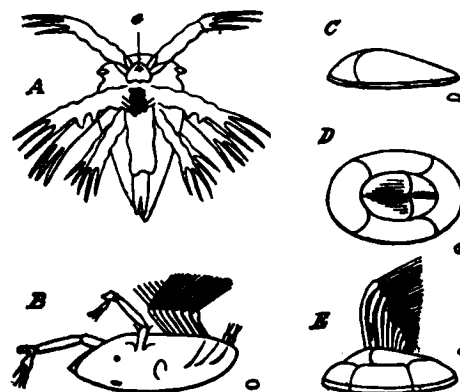

FIG. 13.—Early Stages of *Balanus*. (After Spence Bate.)

- A, Nauplius. e, Eye.
- B, Cypris-larva with a bivalve shell and just before becoming attached (represented feet upwards for comparison with E, where it is attached).
- C, After becoming attached, side views.
- D, Later stage, viewed from above.
- E, Side view, later stage and with cirri extended.

The dots indicate the actual size.

within the egg (or within the maternal brood-chamber), so that the larva, on hatching, has reached a stage more advanced than the nauplius. Further, the gradual appearance and differentiation of the successive somites and appendages may be accelerated, so that comparatively great advances take place at a single moult. In the Cirripedia, for example, the latest nauplius stage (fig. 13, A) gives rise directly to the so-called *Cypris*-larva (fig. 13, B), differing widely from the nauplius in form, and possessing all the appendages of the adult. Another very common modification of the primitive method of development is found in the accelerated appearance of certain somites or appendages, disturbing the regular order of development. This modification is especially found in the Malacostraca. Even in those which have most fully retained the primitive order of development, as in the *Penaeidea* and *Euphausiidae*, the last pair of abdominal appendages make their appearance in advance of those immediately in front of them. The same process, carried further, leads to the very peculiar larva known as the *Zoea*, in the typical form of which, found in the *Brachyura* (fig. 14), the posterior five or six thoracic somites have their development greatly retarded, and are still represented by a short unsegmented region of the body at a time when the abdominal somites are fully formed and even carry appendages. The *Zoea* was formerly regarded as a recapitulation of an ancestral form, but there can be no doubt that its peculiarities are the result of secondary modification. It is most typically developed in the most specialized Decapoda, the *Brachyura*, while the more primitive groups of Malacostraca, the *Euphausiidae*, *Penaeidea* and *Stomatopoda*, retain the primitive order of appearance

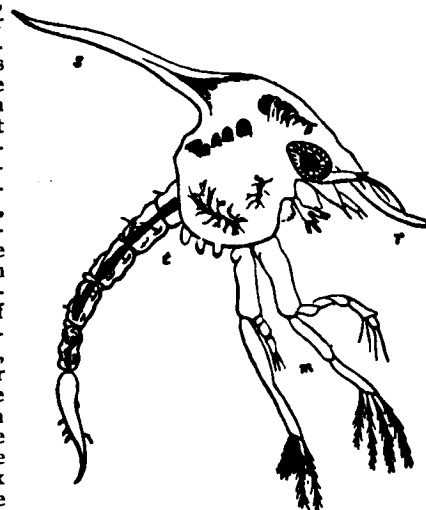

FIG. 14.—Zoea of Common Shore-Crab in its second stage. (Spence Bate.)

- r, Rostral spine. t, Buds of thoracic feet.
- s, Dorsal spine.
- m, Maxillipeds. a, Abdomen.

of the somites, and, for the most part, of the limbs. At the same time, the tendency to a retardation in the development of the posterior thoracic somites is very general in Malacostracan larvae, and may perhaps be correlated with the fact that in the primitive Phyllocarida the whole thoracic region is very short and the limbs closely crowded together.

Besides the nauplius and the zoea there are many other types of Crustacean larvae, distinguished by special names, though, as their occurrence is restricted within the limits of the smaller systematic groups, they are of less general interest. We need only mention the *Mysis*-stage (better termed Schizopod-stage) found in many Macrura (as, for example, the lobster), which differs from the adult in having large natatory exopodites on the thoracic legs.

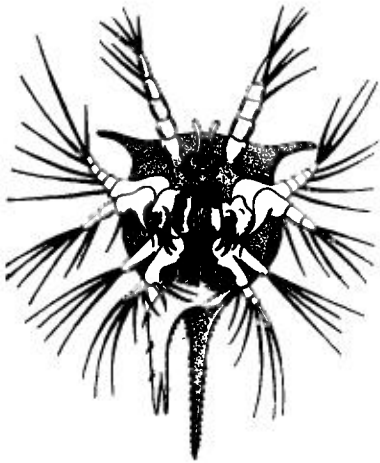

FIG. 15.—Nauplius of *Tetracitta porosa* after the first moult. Magn. 90 diam. (Fritz Müller.)

Most of the larval forms swim freely at the surface of the sea, and many show special adaptations to this habit of life. As in many other "pelagic" organisms, spines and processes from the surface of the body are often developed, which are probably less important as defensive organs than as aids to flotation. This is well seen in the nauplius of many Cirripedia (fig. 15) and in nearly all zoeae. Perhaps the most striking example is the zoea-like larva of the *Sergestidae*, known as *Elaphocaris*, which has an extraordinary armature of ramified spines. The same purpose is probably served by the extreme flattening of the body in the membranous *Phyllosoma*-larva of the rock-lobsters and their allies (Loricata).

#### Past History.

Although fossil remains of Crustacea are abundant, from the most ancient fossiliferous rocks down to the most recent, their study has hitherto contributed little to a precise knowledge of the phylogenetic history of the class. This is partly due to the fact that many important forms must have escaped fossilization altogether owing to their small size and delicate structure, while very many of those actually preserved are known only from the carapace or shell, the limbs being absent or represented only by indecipherable fragments. Further, many important groups were already differentiated when the geological record began. The Phyllopoda, Ostracoda and Cirripedia (Thyrostraca) are represented in Cambrian or Silurian rocks by forms which seem to have resembled closely those now existing, so that palaeontology can have little light to throw on the mode of origin of these groups. With the Malacostraca the case is little better. There is considerable reason for believing that the *Ceratiocaridae*, which are found from the Cambrian onwards, were allied to the existing *Nebalia*, and may possibly include the forerunners of the true Malacostraca, but nothing is definitely known of their appendages. In Palaeozoic formations, from the Upper Devonian onwards, numbers of shrimp-like forms are found which have been referred to the Schizopoda and the Decapoda, but here again the scanty information which may be gleaned as to the structure of the limbs rarely permits of definite conclusions as to their affinities. The recent discovery in the Tasmanian "schizopod" *Anaspides*, of what is believed to be a living representative of the Carboniferous and Permian *Synsarcida*, has, however, afforded a clue to the affinities of some of these problematical forms.

True Decapods are first met with in Mesozoic rocks, the first to appear being the *Penaeidea*, a primitive group comprising the *Penaeidae* and *Sergestidae*, which occur in the Jurassic and perhaps in the Trias. Some of the earliest are referred to the existing genus *Penaeus*. The Stenopidea, another primitive group, differing from the *Penaeidea* in the character of the gills, appear in the Trias and Jurassic. The Caridea or true prawns and shrimps appear later, in the Upper Jurassic, some of them presenting primitive characteristics in the retention of swimming

exopodites on the walking-legs. The Eryonidea (fig. 16, 3), a group related to the Loricata but of a more generalized type, are specially interesting since the few existing deep-sea forms appear to be only surviving remnants of what was, in the Mesozoic period, a dominant group. The Mesozoic *Glyphacidae* have been supposed to stand in the direct line of descent of the modern rock-lobsters and their allies (Loricata). Some of the Loricata have persisted with little change from the Cretaceous period to the present day.

The Anomura are hardly known as fossils. The Brachyura, on the other hand, are well represented (fig. 16, 1, 2). The earliest forms, from the Lower Oolite and later, belonging chiefly to the extinct family *Prosopeonidae*, have been shown to have close relations with the most generalized of existing Brachyura, the deep-sea *Homolodromiidae*, and to link the Brachyura to the Homarine (lobster-like) Macrura.

A few Isopoda are known from Secondary rocks, but their systematic position is doubtful and they throw no light on the evolution of the group. The Amphipoda are not definitely known to occur till Tertiary times. Stomatopoda of a very modern-looking type, and even their larvae, occur in Jurassic rocks.

In the dearth of trustworthy evidence as to the actual forerunners of existing Crustacea, we are compelled to rely wholly

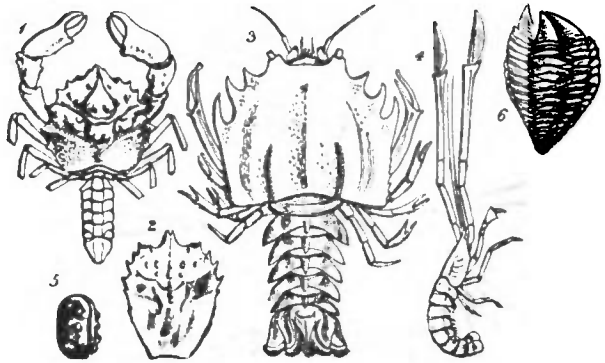

FIG. 16.

- 1, *Dromilites Lamarckii*, Desm.; London Clay, Sheppey.
- 2, *Palaeocorystes Stokesii*, Gault; Folkestone.
- 3, *Eryon arctiformis*, Schl.; Lithographic stone, Solenhofen.
- 4, *Mecocheirus longimanus*, Schl.; Lithographic stone, Solenhofen.
- 5, *Cypridea tuberculata*, Sby.; (Ostracoda); Weald, Sussex.
- 6, *Loricula pulchella*, Sby. (Cirripedia); L. Chalk, Sussex.

on the data afforded by comparative anatomy and embryology in attempting to reconstruct the probable phylogeny of the class. It is unnecessary to insist on the purely speculative character of the conclusions to be reached in this way, so long as they cannot be checked by the results of palaeontology, but, when this is recognized, such speculation is not only legitimate but necessary as a basis on which to build a natural classification.

The first attempts to reconstruct the genealogical history of the Crustacea started from the assumption that the "theory of recapitulation" could be applied to their larval history. The various larval forms, especially the nauplius and zoea, were supposed to reproduce, more or less closely, the actual structure of ancestral types. So far as the zoea was concerned, this assumption was soon shown to be erroneous, and the secondary nature of this type of larva is now generally admitted. As regards the nauplius, however, the constancy of its general character in the most widely diverse groups of Crustacea strongly suggests that it is a very ancient type, and the view has been advocated that the Crustacea must have arisen from an unsegmented nauplius-like ancestor.

The objections to this view, however, are considerable. The resemblances between the Crustacea and the Annelid worms, in such characters as the structure of the nervous system and the mode of growth of the somites, can hardly be ignored. Several structures which must be attributed to the common



stock of the Crustacea, such as the paired eyes and the shell-fold, are not present in the nauplius. The opinion now most generally held is that the primitive Crustacean type is most nearly approached by certain Phyllopods such as *Apus*. The large number and the uniformity of the trunk somites and their appendages, and the structure of the nervous system and of the heart in *Apus*, are Annelidan characters which can hardly be without significance. It is probable also, as already mentioned, that the leaf-like appendages of the Phyllopoda are of a primitive type, and attempts have been made to refer their structure to that of the Annelid parapodium. In many respects, however, the Phyllopoda, and especially *Apus*, have diverged considerably from the primitive Crustacean type. All the cephalic appendages are much reduced, the mandibles have no palps, and the maxillulae are vestigial. In these respects some of the Copepoda have retained characters which we must regard as much more primitive. In those Copepods in which the palps of the mandibles as well as the antennae are biramous and natatory, the first three pairs of appendages retain throughout life, with little modification, the shape and function which they have in the nauplius stage, and must, in all likelihood, be regarded as approximating to those of the primitive Crustacea. In other respects, however, such as the absence of paired eyes and of a shell-fold, as well as in the characters of the post-oral limbs, the Copepoda are undoubtedly specialized.

In order to reconstruct the hypothetical ancestral Crustacean, therefore, it is necessary to combine the characters of several of the existing groups. It may be supposed to have approximated, in general form, to *Apus*, with an elongated body composed of numerous similar somites and terminating in a caudal furca; with the post-oral appendages all similar and all bearing gnathobasic processes; and with a carapace originating as a shell-fold from the maxillary somite. The eyes were probably stalked, the antennae and mandibles biramous and natatory, and both armed with masticatory processes. It is likely that the trunk-limbs were also biramous, with additional endites and exites. Whether any of the obscure fossils generally referred to the Phyllopoda or Phyllocarida may have approximated to this hypothetical form it is impossible to say. It is to be noted, however, that the Trilobita, which, according to the classification here adopted, are dealt with under Arachnida, are not very far removed, except in such characters as the absence of a shell-fold and of eye-stalks, from the primitive Crustacean here sketched.

On this view, the nauplius, while no longer regarded as reproducing an ancestral type, does not altogether lose its phylogenetic significance. It is an ancestral larval form, corresponding perhaps to the stages immediately succeeding the trochophore in the development of Annelids, but with some of the later-acquired Crustacean characters superposed upon it. While little importance is to be given to such characters as the unsegmented body, the small number of limbs and the absence of a shell-fold and of paired eyes, it has, on the other hand, preserved archaic features in the form of the limbs and the masticatory function of the antenna.

The probable course of evolution of the different groups of Crustacea from this hypothetical ancestral form can only be touched on here. The Phyllopoda must have branched off very early and from them to the Cladocera the way is clear. The Ostracoda might have been derived from the same stock were it not that they retain the mandibular palp which all the Phyllopods have lost. The Copepoda must have separated themselves very early, though perhaps some of their characters may be persistently larval rather than phylogenetically primitive. The Cirripedia are so specialized both as larvae and as adults that it is hard to say in what direction their origin is to be sought.

For the Malacostraca, it is generally admitted that the Leptostraca (*Nebalia*, &c.) provide a connecting-link with the base of the Phyllopod stem. Nearest to them come the Schizopoda, a primitive group from which two lines of descent can be traced, the one leading from the Mysidacea (*Mysidae* + *Lophogastridae*)

to the Cumacea and the sessile-eyed groups Isopoda and Amphipoda, the other from the Euphausiacea (*Euphausiidae*) to the Decapoda

#### Classification.

The modern classification of Crustacea may be said to have been founded by P. A. Latreille, who, in the beginning of the 19th century, divided the class into Entomostraca and Malacostraca. The latter division, characterized by the possession of 19 somites and pairs of appendages (apart from the eyes), by the division of the appendages into two tagmata corresponding to cephalothorax and abdomen, and by the constancy in position of the generative apertures, differing in the two sexes, is unquestionably a natural group. The Entomostraca, however, are certainly a heterogeneous assemblage, defined only by negative characters, and the name is retained only for the sake of convenience, just as it is often useful to speak of a still more heterogeneous and unnatural assemblage of animals as Invertebrata. The barnacles and their allies, forming the group Cirripedia or Thyrostraca, sometimes treated as a separate sub-class, are distinguished by being sessile in the adult state, the larval antennules serving as organs of attachment, and the antennae being lost. An account of them will be found in the article THYROSTRACA. The remaining groups are dealt with under the headings ENTOMOSTRACA and MALACOSTRACA, the annectent group Leptostraca being included in the former.

It may be useful to give here a synopsis of the classification adopted in this encyclopaedia, noting that, for convenience of treatment, it has been thought necessary to adopt a grouping not always expressive of the most recent views of affinity.

#### Class Crustacea.

##### Sub-class Entomostraca.

##### Order Branchiopoda.

##### Sub-orders Phyllopoda.

*Cladocera*,  
*Branchiura*.

##### Orders Ostracoda.

##### *Copepoda*.

##### Sub-classes Thyrostraca (*Cirripedia*).

##### *Leptostraca*.

##### *Malacostraca*.

##### Order Decapoda.

##### Sub-orders Brachyura.

*Macrura*.

##### Orders Schizopoda (including *Anaspides*).

##### *Stomatopoda*.

##### *Sympoda* (*Cumacea*).

##### *Isopoda* (including *Tanaidacea*).

##### *Amphipoda*.

(W. T. CA.)

**CRUSTUMERIUM**, an ancient town of Latium, on the edge of the Sabine territory, near the headwaters of the Allia, not far from the Tiber. It appears several times in the early history of Rome, but was conquered in 500 B.C. according to Livy ii. 19, the *tribus Crustumina* [or *Clustumina*] being formed in 471 B.C. Pliny mentions it among the lost cities of Latium, but the name clung to the district, the fertility of which remained famous. No remains of it exist, and its exact site is uncertain.

See T. Ashby in *Papers of the British School at Rome*, iii. 50.

**CRUVEILHIER, JEAN** (1791–1874), French anatomist, was born at Limoges in 1791, and was educated at the university of Paris, where in 1825 he became professor of anatomy. In 1836 he became the first occupant of the recently founded chair of pathological anatomy. He died at Jussac in 1874. His chief works are *Anatomie descriptive* (1834–1836); *Anatomie pathologique du corps humain* (1829–1842), with many coloured plates; *Traité d'anatomie pathologique générale* (1849–1864); *Anatomie du système nerveux de l'homme* (1845); *Traité d'anatomie descriptive* (1851).

**CRUZ E SILVA, ANTONIO DINIZ DA** (1731–1799), Portuguese heroic-comic poet, was the son of a Lisbon carpenter who emigrated to Brazil shortly before the poet's birth, leaving his wife to support and educate her young family by the earnings of her needle. Diniz studied Latin and philosophy with the Oratorians, and in 1747 matriculated at Coimbra University, where he wrote his first verses about 1750. In 1753 he took his degree in law, and returning to the capital, devoted much of the

next six years to literary work. In 1756 he became one of the founders and drew up the statutes of the *Arcadia Lusitana*, a literary society whose aims were the instruction of its members, the cultivation of the art of poetry, and the restoration of good taste. The fault was not his if these ends were not attained, for, taking contemporary French authors as his models, he contributed much, both in prose and verse, to its proceedings, until he left in February 1760 to take up the position of *juiz de fora* at Castello de Vide. On returning to Lisbon for a short visit, he found the *Arcadia* a prey to the internal dissensions that caused its dissolution in 1774, but succeeded in composing them, and in 1764 he went to Elvas to act as auditor of one of the regiments stationed there. During a ten years' residence, his wide reading and witty conversation gained him the friendship of the governor of that fortress and the admiration of a circle comprising all that was cultivated in Elvas. As in most cathedral and garrison towns, the clerical and military elements dominated society, and here were mutually antagonistic, because of the enmity between their respective leaders, the bishop and the governor. Moreover, Elvas, being a remote provincial centre, abounded in curious and grotesque types. Diniz, who was a keen observer, noted these, and, treasuring them in his memory, reproduced them, with their vanities, intrigues and ignorance, in his masterpiece, *Hyssope*. In 1768 a quarrel arose between the bishop, a proud, pretentious prelate, and the dean, as to the right of the former to receive holy water from the latter at a private side door of the cathedral, instead of at the principal entrance. The matter being one of principle, neither party would yield what he considered his rights, and it led to a lawsuit, and divided the town into two sections, which eagerly debated the arguments on both sides and enjoyed the ridiculous incidents which accompanied the dispute. Ultimately the dean died, and was succeeded by his nephew, who appealed to the crown with success and the bishop lost his pretension. The *Hyssope* arose out of and deals with this affair. It was dictated in seventeen days, in the years 1770-1772, and, in its final redaction, consists of eight cantos of blank verse. The pressure of absolutism left open only one form of expression, satire, and in this poem Diniz produced an original work which ridicules the clergy and the prevailing Gallomania, and contains episodes full of humour. It has been compared with Boileau's *Lutrin*, because both are founded on a petty ecclesiastical quarrel, but here the resemblance ends, and the poem of Diniz is the superior in everything except metrification.

Returning to Lisbon in 1774, Diniz endeavoured once more to resuscitate the *Arcadia*, but his long absence had withdrawn its chief support, its most talented members Garção (*q.v.*) and Quita were no more, and he only assisted at its demise. In April 1776 he was appointed *disembargador* of the court of Relação in Rio de Janeiro and given the habit of Aviz. He lived in Brazil, devoting his leisure to a study of its natural history and mineralogy, until 1789, when he went back to Lisbon to take up the post of *disembargador* of the Relação of Oporto; in July 1790 he was promoted, and became *disembargador* of the Casa da Supplicação. In this year he was sent again to Brazil to assist in trying the leaders of the Republican conspiracy in Minas, in which Gonzaga (*q.v.*) and other men of letters were involved, and in December 1792 he became chancellor of the Relação in Rio. Six years later he was named councillor of the *Conselho Ultramarino*, but did not live to return home, dying in Rio on the 5th of October 1799.

Diniz possessed a poetic temperament, but his love of imitating the classics, whose spirit he failed to understand, fettered his muse, and he seems never to have perceived that mythological comparisons and pastoral allegories were poor substitutes for the expression of natural feeling. The conventionalism of his art prejudiced its sincerity, and, inwardly cherishing the belief that poetry was unworthy of the dignity of a judge, he never gave his real talents a chance to display themselves. His Anacreontic odes, dithyrambs and idylls earned the admiration of contemporaries, but his Pindaric odes lack fire, his sonnets are weak, and his idylls have neither the truth nor the simplicity of Quita's

work. As a rule Diniz's versification is weak and his verses lack harmony, though the diction is beyond cavil.

His poems were published in 6 vols. (Lisbon, 1807-1817). The best edition of *Hyssope*, to which Diniz owes his lasting fame, is that of J. R. Coelho (Lisbon, 1879), with an exhaustive introductory study on his life and writings. A French prose version of the poem by Boissonade has gone through two editions (Paris, 1828 and 1867), and English translations of selections have been printed in the *Foreign Quarterly Review*, and in the *Manchester Quarterly* (April 1896).

See also Dr Theophilo Braga, *A. Arcadia Lusitana* (Oporto, 1899). (E. PR.)

**CRYOLITE**, a mineral discovered in Greenland by the Danes in 1794, and found to be a compound of fluorine, sodium and aluminium. From its general appearance, and from the fact that it melts readily, even in a candle-flame, it was regarded by the Eskimos as a peculiar kind of ice; from this fact it acquired the name of cryolite (from Gr. *κρύος*, frost, and *λίθος*, stone). Cryolite occurs in colourless or snow-white cleavable masses, often tinted brown or red with iron oxide, and occasionally passing into a black variety. It is usually translucent, becoming nearly transparent on immersion in water. The mineral cleaves in three rectangular directions, and the crystals occasionally found in the crevices have a cubic habit, but it has been proved, after much discussion, that they belong to the anorthic system. The hardness is 2.5, and the specific gravity 3. Cryolite has the formula  $\text{Na}_2\text{AlF}_6$ , or  $3\text{NaF}\cdot\text{AlF}_3$ , corresponding to fluorine 54.4, sodium 32.8, and aluminium 12.8%. It colours a flame yellow, through the presence of sodium, and when heated with sulphuric acid it evolves hydrofluoric acid.

Cryolite occurs almost exclusively at Ivigtut (sometimes written Evigtok) on the Arksut Fjord in S.W. Greenland. There it forms a large deposit, in a granitic vein running through gneiss, and is accompanied by quartz, siderite, galena, blende, chalcopryrite, &c. It is also associated with a group of kindred minerals, some of which are evidently products of alteration of the cryolite, known as pachnolite, thomsenolite, ralstonite, garksutite, arksutite, &c. Cryolite likewise occurs, though only to a limited extent, at Miyask, in the Ilmen Mountains; at Pike's Peak, Colorado, and in the Yellowstone Park.

Cryolite is a mineral of much economic importance. It has been extensively used as a source of metallic aluminium, and as a flux in smelting the metal. It is largely employed in the manufacture of certain sodium salts, as suggested by Julius Thomsen, of Copenhagen, in 1849; and it has been used for the production of certain kinds of porcelain and glass, remarkable for its toughness, and for enamelled ware.

Although cryolite is known as "ice-stone" (*Eisstein*), it is not to be confused with "ice-spar" (*Eisspath*), which is a vitreous kind of felspar termed "glassy felspar" or rhyacolite. (F. W. R.\*)

**CRYPT** (Lat. *crypta*, from the Gr. *κρύπτειν*, to hide), a vault or subterranean chamber, especially under churches. In classical phraseology "crypta" was employed for any vaulted building, either partially or entirely below the level of the ground. It is used for a sewer (*crypta Suburae*, Juvenal, *Sat.* v. 106); for the "carceres," or vaulted stalls for the horses and chariots in a circus (Sidon. Apoll. *Carm.* xxiii. 319); for the close porticoes or arcades, more fully known as "cryptoporticus," attached by the Romans to their suburban villas for the sake of coolness, and to the theatres as places of exercise or rehearsal for the performers (Plin. *Epist.* ii. 15, v. 6, vii. 21; Sueton. *Calig.* 58; Sidon. Apoll. lib. ii. epist. 2); and for underground receptacles for agricultural produce (Vitruv. vi. 8, Varro, *De re rust.* i. 57). Tunnels, or galleries excavated in the living rock, were also called *cryptae*. Thus the tunnel to the north of Naples, through which the road passes to Puteoli, familiar to tourists as the "Grotto of Posilipo," was originally designated *crypta Neapolitana* (Seneca, *Epist.* 57). In early Christian times *crypta* was appropriately employed for the galleries of a catacomb, or for the catacomb itself. Jerome calls them by this name when describing his visits to them as a schoolboy, and the term is used by Prudentius (see CATACOMBS).

A crypt, as a portion of a church, had its origin in the subterranean chapels known as "confessiones," erected around the tomb of a martyr, or the place of his martyrdom. This is the origin of the spacious crypts, some of which may be called subterranean churches, of the Roman churches of S. Prisca, S. Prassede, S. Martino ai Monti, S. Lorenzo fuori le Mura, and above all of St Peter's—the crypt being thus the germ of the church or basilica subsequently erected above the hallowed spot. When the martyr's tomb was sunk in the surface of the ground, and not placed in a catacomb chapel, the original memorial-shrine would be only partially below the surface, and consequently the part of the church erected over it, which was always that containing the altar, would be elevated some height above the ground, and be approached by flights of steps. This fashion of raising the chancel or altar end of a church on a crypt was widely imitated long after the reason for adopting it ceased, and even where it never existed. The crypt under the altar at the basilica of St Maria Maggiore in Rome is merely imitative, and the same may be said of many of the crypts of the early churches in England. The original Saxon cathedral of Canterbury had a crypt beneath the eastern apse, containing the so-called body of St Dunstan, and other relics, "fabricated," according to Eadmer, "in the likeness of the confessor of St Peter at Rome" (see *BASILICA*). St Wilfrid constructed crypts still existing beneath the churches erected by him in the latter part of the 7th century at Hexham and Ripon. These are peculiarly interesting from their similarity in form and arrangement to the catacomb chapels with which Wilfrid must have become familiar during his residence in Rome. The cathedral, begun by Æthelwold and finished by Alphege at Winchester, at the end of the 10th century, had spacious crypts "supporting the holy altar and the venerable relics of the saints" (Wulstan, *Life of St Æthelwold*), and they appear to have been common in the earlier churches in England. The arrangement was adopted by the Norman builders of the 11th and 12th centuries, and though far from universal is found in many of the cathedrals of that date. The object of the construction of these crypts was twofold,—to give the altar sufficient elevation to enable those below to witness the sacred mysteries, and to provide a place of burial for those holy men whose relics were the church's most precious possession. But the crypt was "a foreign fashion," derived, as has been said, from Rome, "which failed to take root in England, and indeed elsewhere barely outlasted the Romanesque period" (*Essays on Cathedrals*, ed. Howson, p. 331).

Of the crypts beneath English Norman cathedrals, that under the choir of Canterbury (*q.v.*) is by far the largest and most elaborate in its arrangements. It is, in fact, a subterranean church of vast size and considerable altitude. The whole crypt was dedicated to the Virgin Mary, and contained two chapels especially dedicated to her,—the central one beneath the high altar, enclosed with rich Gothic screen-work, and one under the south transept. This latter chapel was appropriated by Queen Elizabeth to the use of the French Huguenot refugees who had settled at Canterbury in the time of Edward VI. There were also in this crypt a large number of altars and chapels of other saints, some of whose hallowed bodies were buried here. At the extreme east end, beneath the Trinity chapel, the body of St Thomas (Becket) was buried the day after his martyrdom, and lay there till his translation, July 7, 1220.

The cathedrals of Winchester, Worcester and Gloucester have crypts of slightly earlier date (they may all be placed between 1080 and 1100), but of similar character, though less elaborate. They all contain piscinas and other evidences of the existence of altars in considerable numbers. They are all apsidal. The most picturesque is that of Worcester, the work of Bishop Wulfstan (1084), which is remarkable for the multiplicity of small pillars supporting its radiating vaults. Instead of having the air of a sepulchral vault like those of Winchester and Gloucester, this crypt is, in Professor Willis's words, "a complex and beautiful temple." Archbishop Roger's crypt at York, belonging to the next century (1154-1181), was filled up with earth when the

present choir was built at the end of the 14th century, and its existence forgotten till its disinterment after the fire of 1829. The choir and presbytery at Rochester are supported by an extensive crypt, of which the western portion is Gundulf's work (1076-1107), but the eastern part, which displays slender cylindrical and octagonal shafts, with light vaulting springing from them, is of the same period as the superstructure, the first years of the 13th century. This crypt, and that beneath the Early English Lady chapel at Hereford, are the latest English existing cathedral crypts. That at Hereford was rendered necessary by the fall of the ground, and is an exceptional case. Later than any of these crypts was that of St Paul's, London. This was a really large and magnificent church of Decorated date, with a vaulted roof of rich and intricate character resting on a forest of clustered columns. Part of it served as the parish church of St Faith. A still more exquisite work of the Decorated period is the crypt of St Stephen's chapel at Westminster, than which it is difficult to conceive anything more perfect in design or more elaborate in ornamentation. Having happily escaped the conflagration of the Houses of Parliament in 1834—before which it was degraded to the purpose of the speaker's state dining-room—it has been restored to its former sumptuousness of decoration, and is now one of the most beautiful architectural gems in England.

Of Scottish cathedrals the only one that possesses a crypt is the cathedral of Glasgow, rendered celebrated by Sir Walter Scott in his novel of *Rob Roy* (ch. xx.). At the supposed date of the tale, and indeed till a comparatively recent period, this crypt was used as a place of worship by one of the three congregations among which the cathedral was partitioned, and was known as "the Laigh or Barony Kirk." It extends beneath the choir transepts and chapter-house; in consequence of the steep declivity on which the cathedral stands it is of unusual height and lightsomeness. It belongs to the 13th century, its style corresponding to Early English, and is simply constructional, the building being adapted to the locality. In architectural beauty it is quite unequalled by any crypt in the United Kingdom, and can hardly anywhere be surpassed. It is an unusually rich example of the style, the clustered piers and groining being exquisite in design and admirable in execution. The bosses of the roof and capitals of the piers are very elaborate, and the doors are much enriched with foliage. "There is a solidity in its architecture, a richness in its vaulting, and a variety of perspective in the spacing of its pillars, which make it one of the most perfect pieces of architecture in these kingdoms" (Fergusson).

In the centre of the main alley stands the mutilated effigy of St Mungo, the patron saint of Glasgow, and at the south-east corner is a well called after the same saint.

Crypts under parish churches are not very uncommon in England, but they are usually small and not characterized by any architectural beauty. A few of the earlier crypts, however, deserve notice. One of the earliest and most remarkable is that of the church of Lastingham near Pickering in Yorkshire, on the site of the monastery founded in 648 by Cedd, bishop of the East Saxons. The existing crypt, though exceedingly rude in structure, is of considerably later date than Bishop Cedd, forming part of the church erected by Abbot Stephen of Whitby in 1080, when he had been driven inland by the incursions of the northern pirates. This crypt is remarkable from its extending under the nave as well as the chancel of the upper church, the plan of which it accurately reproduces, with the exception of the westernmost bay. It forms a nave with side aisles of three bays, and an apsidal chancel, lighted by narrow deeply splayed slits. The roof of quadripartite vaulting is supported by four very dwarf thick cylindrical columns, the capitals of which and of the responds are clumsy imitations of classical work with rude volutes. Still more curious is the crypt beneath the chancel of the church of Repton in Derbyshire. This also consists of a centre and side aisles, divided by three arches on either side. The architectural character, however, is very different from that at Lastingham, and is in some respects almost unique, the:

piers being slender, and some of them of a singular spiral form, with a bead running in the sunken part of the spiral. Another very extensive and curious Norman crypt is that beneath the chancel of St Peter's-in-the-East at Oxford. This is five bays in length, the quadripartite vaulting being supported by eight low, somewhat slender, cylindrical columns with capitals bearing grotesque animal and human subjects. Its dimensions are 36 by 20 ft. and 10 ft. in height. This crypt has been commonly attributed to Grymboldt in the 9th century; but it is really not very early Norman. Under the church of St Mary-le-Bow in London there is an interesting Norman crypt not very dissimilar in character to that last described. Of a later date is the remarkably fine Early English crypt groined in stone, beneath the chancel of Hythe in Kent, containing a remarkable collection of skulls and bones, the history of which is quite uncertain. There is also a Decorated crypt beneath the chancel at Wimborne minster, and one of the same date beneath the southern chancel aisle at Grantham.

Among the more remarkable French crypts may be mentioned those of the cathedrals of Auxerre, said to date from the original foundation in 1085; of Bayeux, attributed to Odo, bishop of that see, uterine brother of William the Conqueror, where twelve columns with rude capitals support a vaulted roof; of Chartres, running under the choir and its aisles, frequently assigned to Bishop Fulbert in 1029, but more probably coeval with the superstructure; and of Bourges, where the crypt is in the Pointed style, extending beneath the choir. The church of the Holy Trinity attached to Queen Matilda's foundation—the "Abbaye aux Dames" at Caen—has a Norman crypt where the thirty-four pillars are as closely set as those at Worcester. The church of St Eutropius at Saintes has also a crypt of the 11th century, of very large dimensions, which deserves special notice; the capitals of the columns exhibit very curious carvings. Earlier than any already mentioned is that of St Gervase of Rouen, considered by E. A. Freeman "the oldest ecclesiastical work to be seen north of the Alps." It is apsidal, and in its walls are layers of Roman brick. It is said to contain the remains of two of the earliest apostles of Gaul—St Mello and St Avitian. There are numerous crypts in Germany. One at Göttingen may be mentioned, where cylindrical shafts with capitals of singular design support "vaulting of great elegance and lightness" (Fergusson), the curves being those of a horseshoe arch. The crypts of the cathedrals or churches at Halberstadt, Hildesheim and Naumburg also deserve to be noticed; that of Lübeck may be rather called a lower choir. It is 20 ft. high and vaulted.

The Italian crypts, when found, as a rule reproduce the "confessio" of the primitive churches. That beneath the chancel of S. Michele at Pavia is an excellent typical example, probably dating from the 10th century. It is apsidal and vaulted, and is seven bays in length. That at S. Zeno at Verona (c. 1138) is still more remarkable; its vaulted roof is upborne by forty columns, with curiously carved capitals. It is approached from the west by a double flight of steps and contains many ancient monuments. S. Miniato at Florence, begun in 1013, has a very spacious crypt at the east end, forming virtually a second choir. It is seven bays in length and vaulted. The most remarkable crypt in Italy, however, is perhaps that of St Mark's, Venice. The plan of this is almost a Greek cross. Four rows of nine columns each run from end to end, and two rows of three each occupy the arms of the cross, supporting low stunted arches on which rests the pavement of the church above. This also constitutes a lower church, containing a *chorus cantorum* formed by a low stone screen, not unlike that of S. Clemente at Rome (see BASILICA), enclosing a massive stone altar with four low columns. This crypt is reasonably supposed to belong to the church founded by the doge P. Orseolo in 977. There are also crypts deserving notice at the cathedrals of Brescia, Fiesole and Modena, and the churches of S. Ambrogio and S. Eustorgio at Milan. The former was unfortunately modernized by St Charles Borromeo. The crypt at Assisi is really a second church at a lower level, and being built on the steep side of a hill is well lighted. The whole fabric is a beautiful specimen of Italian

Gothic, and both the lower and upper churches are covered with rich frescoes.

Domestic crypts are of frequent occurrence. Medieval houses had as a rule their chief rooms raised above the level of the ground upon vaulted substructures, which were used as cellars and storerooms. These were sometimes partially underground, sometimes entirely above it. The underground vaults often remain when all the superstructure has been swept away, and from their Gothic character are frequently mistaken for ecclesiastical buildings. The older English towns are full of crypts of this character, now used as cellars. They occur in Oxford and Rochester, are very abundant in the older parts of Bristol, and, according to J. H. Parker, "nearly the whole city of Chester is built upon a series of them with the Rows or passages made on the top of the vaults" (*Domestic Architecture*, iii. 91). The crypt of Gerard's Hall in London, destroyed in the construction of New Cannon Street, figured by Parker (*Dom. Arch.* ii. 185), was a beautiful example of the lower storey of the residence of a wealthy merchant of the time of Edward I. It was divided down the middle by a row of four slender cylindrical columns supporting a very graceful vault. The finest example of a secular crypt now remaining in England is that beneath the Guildhall of London. The date of this is early in the 15th century—1411. It is a large and lofty apartment, divided into four alleys by two rows of clustered shafts supporting a rich lierne vault with ribs of considerable intricacy. There is a fine vaulted crypt of the same date and of similar character beneath St Mary's Hall, the Guildhall of the city of Coventry. (E. V.)

**CRYPTEIA** (Gr. κρύπτειν, to hide), a kind of secret police in ancient Sparta, founded, according to Aristotle, by Lycurgus; there is, however, no real evidence as to the date of its origin. The institution was under the supervision of the ephors, who, on entering office, annually proclaimed war against the helots (serf-class) and thus absolved from the guilt of murder any Spartan who should slay a helot. It was instituted primarily as a precaution against the ever-present danger of a helot revolt, and secondarily perhaps as a training for young Spartans, who were sent out by the ephors to keep watch on the helots and assassinate any who might appear dangerous. Plato (*Laws*, i. p. 633) emphasizes the former aspect, but there can be little doubt that, at all events after the revolt of 464 (see CIMON), its more sinister purpose was predominant, as we may gather from the secret massacre of 2000 helots who, on the invitation of the ephors, claimed to have rendered distinguished service (Thuc. iv. 80).

See HELOTS; EPHOR; also A. H. J. Greenidge, *Handbook of Gk. Const. Hist.* (London, 1896); G. Gilbert, *Gk. Const. Antiq.* (Eng. trans., London, 1895).

**CRYPTOBRANCHUS**, a genus of thoroughly aquatic, but lung-breathing tailed Batrachia, of the family *Amphiumidae*, characterized by a heavy, flattened build, a very porous tubercular skin, with a frilled fold along each side, short stout limbs with four very short fingers and five very short toes, and minute eyes without lids. The vertebrae are biconcave, and although the gills are lost in the adult, ossified gill-arches, two to four in number, persist. A strong series of vomerine teeth extends across the palate. Three species of this genus are known. One is the well-known fossil of Oeningen first described as *Homo diluvii testis* and shown by Cuvier to be nearly related to the gigantic salamander of Japan, *Cryptobranchus maximus*, which has since been found to inhabit China also; the third is the hellbender, mud-puppy or water-dog of North America, *C. alleghaniensis*, also known under the name of *Menopoma*. Both the fossil *C. scheuchzeri* and *C. maximus* grow to a length of over 5 ft. and are by far the largest Urodeles known, whilst *C. alleghaniensis* reaches the respectable length of 18 in.

The eggs are laid in rosary-like strings. They have been found, in Japan, deposited in deep holes in the water, where they form large clumps (70 to 80 eggs) round which the female coils herself. The gigantic salamander has also been bred in the Amsterdam zoological gardens, the eggs numbering upwards of 500; the male, it is stated, took charge of the eggs, and for the

ten weeks which elapsed before the release of the last larva, he kept close to them, at times crawling among the coiled mass of egg-strings or lifting them up, evidently for the purpose of aeration. The larva on leaving the egg is about an inch long, provided with three branched external gills on each side, and showing mere rudiments of the four limbs.

**CRYPTOGRAPHY** (from Gr. κρύπτος, hidden, and γράφειν, to write), or writing in cipher, called also steganography (from Gr. στεγάνη, a covering), the art of writing in such a way as to be incomprehensible except to those who possess the key to the system employed. The unravelling of the writing is called deciphering. Cryptography having become a distinct art, Bacon (Lord Verulam) classed it (under the name *ciphers*) as a part of grammar. Secret modes of communication have been in use from the earliest times. The Lacedemonians had a method called the *scytale*, from the staff (σκυτάλη) employed in constructing and deciphering the message. When the Spartan ephors wished to forward their orders to their commanders abroad, they wound slantwise a narrow strip of parchment upon the σκυτάλη so that the edges met close together, and the message was then added in such a way that the centre of the line of writing was on the edges of the parchment. When unwound the scroll consisted of broken letters; and in that condition it was despatched to its destination, the general to whose hands it came deciphering it by means of a σκυτάλη exactly corresponding to that used by the ephors. Polybius has enumerated other methods of cryptography.

The art was in use also amongst the Romans. Upon the revival of letters methods of secret correspondence were introduced into private business, diplomacy, plots, &c.; and as the study of this art has always presented attractions to the ingenious, a curious body of literature has been the result.

John Trithemius (d. 1516), the abbot of Spanheim, was the first important writer on cryptography. His *Polygraphia*, published in 1518, has passed through many editions, and has supplied the basis upon which subsequent writers have worked. It was begun at the desire of the duke of Bavaria; but Trithemius did not at first intend to publish it, on the ground that it would be injurious to public interests. A *Steganographia* published at Lyons (? 1551) and later at Frankfort (1606), is also attributed to him. The next treatises of importance were those of Giovanni Battista della Porta, the Neapolitan mathematician, who wrote *De furtivis litterarum notis*, 1563; and of Blaise de Vigenere, whose *Traité des chiffres* appeared in Paris, 1587. Bacon proposed an ingenious system of cryptography on the plan of what is called the double cipher; but while thus lending to the art the influence of his great name, he gave an intimation as to the general opinion formed of it and as to the classes of men who used it. For when prosecuting the earl of Somerset in the matter of the poisoning of Overbury, he urged it as an aggravation of the crime that the earl and Overbury "had cyphers and jargons for the king and queen and all the great men,—things seldom used but either by princes and their ambassadors and ministers, or by such as work or practise against or, at least, upon princes."

Other eminent Englishmen were afterwards connected with the art. John Wilkins, subsequently bishop of Chester, published in 1641 an anonymous treatise entitled *Mercury, or The Secret and Swift Messenger*,—a small but comprehensive work on the subject, and a timely gift to the diplomatists and leaders of the Civil War. The deciphering of many of the royalist papers of that period, such as the letters that fell into the hands of the parliament at the battle of Naseby, has by Henry Stubbe been charged on the celebrated mathematician Dr John Wallis (*Athen. Oxon.* iii. 1072), whose connexion with the subject of cipher-writing is referred to by himself in the Oxford edition of his mathematical works, 1689, p. 659; as also by John Davys. Dr Wallis elsewhere states that this art, formerly scarcely known to any but the secretaries of princes, &c., had grown very common and familiar during the civil commotions, "so that now there is scarce a person of quality but is more or less acquainted with it, and doth, as there is occasion, make use of it." Subsequent

writers on the subject are John Falconer (*Cryptomenysis patefacta*), 1685; John Davys (*An Essay on the Art of Decyphering: in which is inserted a Discourse of Dr Wallis*), 1737; Philip Thicknesse (*A Treatise on the Art of Decyphering and of Writing in Cypher*), 1772; William Blair (the writer of the comprehensive article "Cipher" in Rees's *Cyclopaedia*), 1819; and G. von Marten (*Cours diplomatique*), 1801 (a fourth edition of which appeared in 1851). Perhaps the best modern work on this subject is the *Kryptographik* of J. L. Klüber (Tübingen, 1809), who was drawn into the investigation by inclination and official circumstances. In this work the different methods of cryptography are classified. Amongst others of lesser merit who have treated of this art may be named Gustavus Selenus (*i.e.* Augustus, duke of Brunswick), 1624; Cospi, translated by Nicéron in 1641; the marquis of Worchester, 1659; Kircher, 1663; Schott, 1665; Ludwig Heinrich Hiller, 1682; Comiers, 1690; Baring, 1737; Conrad, 1739, &c. See also a paper on *Elizabethan Cipher-books* by A. J. Butler in the Bibliographical Society's *Transactions*, London, 1901.

Schemes of cryptography are endless in their variety. Bacon lays down the following as the "virtues" to be looked for in them:—"that they be not laborious to write and read; that they be impossible to decipher; and, in some cases, that they be without suspicion." These principles are more or less disregarded by all the modes that have been advanced, including that of Bacon himself, which has been unduly extolled by his admirers as "one of the most ingenious methods of writing in cypher, and the most difficult to be decyphered, of any yet contrived" (Thicknesse, p. 13).

The simplest and commonest of all the ciphers is that in which the writer selects in place of the proper letters certain other letters in regular advance. This method of transposition was used by Julius Caesar. He, "per quartam elementorum literam," wrote *d* for *a*, *e* for *b*, and so on. There are instances of this arrangement in the Jewish rabbis, and even in the sacred writers. An illustration of it occurs in Jeremiah (xxv. 26), where the prophet, to conceal the meaning of his prediction from all but the initiated, writes *Sheshak* instead of Babel (Babylon), the place meant; *i.e.* in place of using the second and twelfth letters of the Hebrew alphabet (*b, b, l*) from the beginning, he wrote the second and twelfth (*sh, sh, k*) from the end. To this kind of cipher-writing Buxtorf gives the name Athbash (from *a* the first letter of the Hebrew alphabet, and *h* the last; *b* the second from the beginning, and *k* the second from the end). Another Jewish cabalism of like nature was called Albam; of which an example is in Isaiah vii. 6, where Tabeal is written for Remaliah. In its adaptation to English this method of transposition, of which there are many modifications, is comparatively easy to decipher. A rough key may be derived from an examination of the respective quantities of letters in a type-founder's bill, or a printer's "case." The decipherer's first business is to classify the letters of the secret message in the order of their frequency. The letter that occurs oftenest is *e*; and the next in order of frequency is *t*. The following groups come after these, separated from each other by degrees of decreasing recurrence:—*a, o, n, i; r, s, h; d, l; c, w, u, m; f, y, g, p, b; v, k; x, q, j, z*. All the single letters must be *a, l* or *O*. Letters occurring together are *ee, oo, ff, ll, ss*, &c. The commonest words of two letters are (roughly arranged in the order of their frequency) *of, to, in, it, is, be, he, by, or, as, at, an, so*, &c. The commonest words of three letters are *the* and *and* (in great excess), *for, are, but, all, not*, &c.; and of four letters—*that, with, from, have, this, they*, &c. Familiarity with the composition of the language will suggest numerous other points that are of value to the decipherer. He may obtain other hints from Poe's tale called *The Gold Bug*. As to messages in the continental languages constructed upon this system of transposition, rules for deciphering may be derived from Breithaupt's *Ars deciffratoria* (1737), and other treatises.

Bacon remarks that though ciphers were commonly in letters and alphabets yet they might be in words. Upon this basis codes have been constructed, classified words taken from dictionaries being made to represent complete ideas. In recent



years such codes have been adapted by merchants and others to communications by telegraph, and have served the purpose not only of keeping business affairs private, but also of reducing the excessive cost of telegraphic messages to distant markets. Obviously this class of ciphers presents greater difficulties to the skill of the decipherer.

Figures and other characters have been also used as letters; and with them ranges of numerals have been combined as the representatives of syllables, parts of words, words themselves, and complete phrases. Under this head must be placed the despatches of Giovanni Michael, the Venetian ambassador to England in the reign of Queen Mary, documents which have only of late years been deciphered. Many of the private letters and papers from the pen of Charles I. and his queen, who were adepts in the use of ciphers, are of the same description. One of that monarch's letters, a document of considerable interest, consisting entirely of numerals purposely complicated, was in 1858 deciphered by Professor Wheatstone, the inventor of the ingenious crypto-machine, and printed by the Philobiblon Society. Other letters of the like character have been published in the *First Report of the Royal Commission on Historical Manuscripts* (1870). In the second and subsequent reports of the same commission several keys to ciphers have been catalogued, which seem to refer themselves to the methods of cryptography under notice. In this connexion also should be mentioned the "characters," which the diarist Pepys drew up when clerk to Sir George Downing and secretary to the earl of Sandwich and to the admiralty, and which are frequently mentioned in his journal. Pepys describes one of them as "a great large character," over which he spent much time, but which was at length finished, 25th April 1660; "it being," says he, "very handsomely done and a very good one in itself, but that not truly alphabetical."

Shorthand marks and other arbitrary characters have also been largely imported into cryptographic systems to represent both letters and words, but more commonly the latter. This plan is said to have been first put into use by the old Roman poet Ennius. It formed the basis of the method of Cicero's freedman, Tiro, who seems to have systematized the labours of his predecessors. A large quantity of these characters have been engraved in Gruter's *Inscriptiones*. The correspondence of Charlemagne was in part made up of marks of this nature. In Rees's *Cyclopaedia* specimens were engraved of the cipher used by Cardinal Wolsey at the court of Vienna in 1524, of that used by Sir Thomas Smith at Paris in 1563, and of that of Sir Edward Stafford in 1586; in all of which arbitrary marks are introduced. The first English system of shorthand—Bright's *Characterie*, 1588—almost belongs to the same category of ciphers. A favourite system of Charles I., used by him during the year 1646, was one made up of an alphabet of twenty-four letters, which were represented by four simple strokes varied in length, slope and position. This alphabet is engraved in Clive's *Linear System of Shorthand* (1830), having been found amongst the royal manuscripts in the British Museum. An interest attaches to this cipher from the fact that it was employed in the well-known letter addressed by the king to the earl of Glamorgan, in which the former made concessions to the Roman Catholics of Ireland.

Complications have been introduced into ciphers by the employment of "dummy" letters,—“nulls and insignificants,” as Bacon terms them. Other devices have been introduced to perplex the decipherer, such as spelling words backwards, making false divisions between words, &c. The greatest security against the decipherer has been found in the use of elaborate tables of letters, arranged in the form of the multiplication table, the message being constructed by the aid of preconcerted key-words. Details of the working of these ciphers may be found in the treatises named in this article. The deciphering of them is one of the most difficult of tasks. A method of this kind is explained in the Latin and English lives of Dr John Barwick, whose correspondence with Hyde, afterwards earl of Clarendon, was carried on in cryptography. In a letter dated 20th February 1659/60, Hyde, alluding to the skill of his political opponents in deciphering, says that "nobody needs to fear them, if they

write carefully in good cyphers." In his next he allays his correspondent's apprehensiveness as to the deciphering of their letters.

"I confess to you, as I am sure no copy could be gotten of any of my cyphers from hence, so I did not think it probable that they could be got on your side the water. But I was as confident, till you tell me you believe it, that the devil himself cannot decypher a letter that is well written, or find that 100 stands for Sir H. Vane. I have heard of many of the pretenders to that skill, and have spoken with some of them, but have found them all to be mountebanks; nor did I ever hear that more of the King's letters that were found at Naseby, than those which they found decyphered, or found the cyphers in which they were writ, were decyphered. And I very well remember that in the volume they published there was much left in cypher which could not be understood, and which I believe they would have explained if it had been in their power."

An excellent modification of the key-word principle was constructed by Admiral Sir Francis Beaufort.

Ciphers have been constructed on the principle of altering the places of the letters without changing their powers. The message is first written Chinese-wise, upward and downward, and the letters are then combined in given rows from left to right. In the celebrated cipher used by the earl of Argyll when plotting against James II., he altered the positions of the words. Sentences of an indifferent nature were constructed, but the real meaning of the message was to be gathered from words, placed at certain intervals. This method, which is connected with the name of Cardan, is sometimes called the trellis or card-board cipher.

The wheel-cipher, which is an Italian invention, the string-cipher, the circle-cipher and many others are fully explained, with the necessary diagrams, in the authorities named above—more particularly by Klüber in his *Kryptographik*. (J. E. B.)

**CRYPTOMERIA**, or JAPANESE CEDAR, a genus of conifers, containing a single species, *C. japonica*, native of China and Japan, which was introduced into Great Britain by the Royal Horticultural Society in 1844. It is described as one of the finest trees in Japan, reaching a height of 100 or more feet, usually divested of branches along the lower part of the trunk and crowned with a conical head. The narrow, pointed leaves are spirally arranged and persist for four or five years; the cones are small, globose and borne at the ends of the branchlets, the scales are thickened at the extremity and divided into sharply pointed lobes, three to five seeds are borne on each scale. *Cryptomeria* is extensively used in Japan for reforesting denuded lands, as it is a valuable timber tree; it is also planted to form avenues along the public roads. In Veitch's *Manual of Coniferae* (ed. 2, 1900, p. 265) reference is made to "an avenue of *Cryptomerias* 7 m. in extent near Lake Hakone" in which "the trees are more than 100 ft. high, with perfectly straight trunks crowned with conical heads of foliage." Professor C. S. Sargent, in his *Forest Flora of Japan*, says, "Japan owes much of the beauty of its groves and gardens to the *Cryptomeria*. Nowhere is there a more solemn and impressive group of trees than that which surrounds the temples and tombs at Nikko where they rise to a height of 100 to 125 ft.; it is a stately tree with no rival except in the sequoias of California." Many curious varieties have been obtained by Japanese horticulturists, including some dwarf shrubby forms not exceeding a few feet in height. When grown in Great Britain *Cryptomeria* requires a deep, well-drained soil with plenty of moisture, and protection from cold winds.

**CRYPTO-PORTICUS** (Gr. κρυπτός, concealed, and Lat. *porticus*), an architectural term for a concealed or covered passage, generally underground, though lighted and ventilated from the open air. One of the best-known examples is the crypto-porticus under the palaces of the Caesars in Rome. In Hadrian's villa in Rome they formed the principal private intercommunication between the several buildings.

**CRYSTAL-GAZING**, or SCRYING, the term commonly applied to the induction of visual hallucinations by concentrating the gaze on any clear deep, such as a crystal or a ball of polished rock crystal. Some persons do not even find a clear deep necessary, and are content to gaze at the palm of the hand, for example, when hallucinatory pictures, as they declare, emerge.

Among objects used are a pool of ink in the hand (Egypt), the liver of an animal (tribes of the North-West Indian frontier), a hole filled with water (Polynesia), quartz crystals (the Apaches and the Euahlayi tribe of New South Wales), a smooth slab of polished black stone (the Huille-che of South America), water in a vessel (Zulus and Siberians), a crystal (the Incas), a mirror (classical Greece and the middle ages), the finger-nail, a sword-blade, a ring-stone, a glass of sherry, in fact almost anything. Much depends on what the "seer" is accustomed to use, and some persons who can "scry" in a glass ball or a glass water-bottle cannot "scry" in ink.

The practice of inducing pictorial hallucinations by such methods as these has been traced among the natives of North and South America, Asia, Australia, Africa, among the Maoris, who sometimes use a drop of blood, and in Polynesia, and is thus practically of world-wide diffusion. This fact was not observed (that is, the collections of examples were not made) till recently, when experiments in private non-spiritualist circles drew attention to crystal-gazing, a practice always popular among peasants, and known historically to have survived through classical and medieval times, and, as in the famous case of Dr Dee, after the Reformation.

The early church condemned *specularii* (mirror-gazers), and Aubrey and the *Memoirs* of Saint-Simon contain "scrying" anecdotes of the 17th and 18th centuries, while Sir Walter Scott's story, *My Aunt Margaret's Mirror*, is based on a tradition of about 1750 in a noble Scottish family. The practice, in all times and countries, was used for purposes of divination. The gazer detected unknown criminals, or described remote events, or even professed to foretell things future. Sometimes the supposed magician or medicine man himself did the scrying; occasionally he enabled his client to see for himself; often a child was selected as the scryer. The process was usually explained as the result of the action of a spirit, angel or devil, and many unessential formulae, invocations, "calls," written charms with cabalistic signs, and fumigations, were employed. These things may have had some effect by way of suggestion; the scryer may have been brought by them into an appropriate frame of mind; but, as a whole, they are tedious and superfluous.

A person can either induce the pictorial hallucinations (he may discover his capacity by accident, like George Sand, as she tells in her *Memoirs*—and other cases are known), or he cannot induce them, though he stare till his eyes water. It is almost universally found, in cases of successful experiment, that the glass ball, for example, takes a milky or misty aspect, that it then grows black, reflections disappearing, and that then the pictures emerge. Some people arrive at seeing the glass ball milky or misty, and can go no further. Others see pictures of persons or landscapes, only in black and white, and motionless. Others see in the glass coloured figures of men, women and animals in motion; while in rarer cases the ball disappears from view, and the scryer finds himself apparently looking at an actual scene. In a few attested cases two persons have shared the same vision. In experiments with magnifying glasses, and through spars, the ordinary effects of magnifying and of alteration of view are sometimes produced; sometimes they are not. The evidence, of course, is necessarily only that of the scryers themselves, but repeated experiments by persons of probity, and unfamiliar with the topic, combined with the world-wide existence of the practice, prove that hallucinatory pictures are really induced.

It has not been found possible to determine, before experiment, whether any given man or woman will prove capable of the hallucinatory experiences. Many subjects with strong powers of "visualization," or seeing things "in the mind's eye," cannot scry; others are successful in various degrees. We might expect persons who have experienced spontaneous visual hallucinations, of the kind vulgarly styled "ghosts" or "wraiths," to succeed in inducing pictures in a glass ball. As a matter of fact such persons sometimes can and sometimes cannot see pictures in the way of crystal-gazing; while many who can see in the crystal have had no spontaneous hallucinations. It is useless to make experiments with hysterical and visionary people, "whose word

no man relies on"; they may have the hallucinatory experiences, but they would say that they had in any case.

The nearest analogy to crystal visions, as described, is the common experience of "hypnagogic illusions" (cf. Alfred Maury, *Les Rêves et le sommeil*). With closed eyes, between sleeping and waking, many people see faces, landscapes and other things flash upon their view, pictures often brilliant, but of very brief duration and rapid mutation. Sometimes the subject opens his eyes to get rid of an unpleasant vision of this kind. People who cannot scry may have these hypnagogic illusions, and, so far, may partly understand the experience of the scryer who is wide awake. But the visions of the scryer often endure for a considerable time. He or she may put the glass down and converse, and may find the picture still there when the ball is taken up again. New figures may join the figure first seen, as when one enters a room. In these respects, and in the awakeness of the scryer, crystal pictures differ from hypnagogic illusions. In other ways the experiences coincide, the pictures are either fanciful, like illustrations of some unread history or romance, or are revivals of remembered places and faces.

Occasionally, in hypnagogic illusions, the observer can see the picture develop rapidly out of a blot of light or colour, beheld by the closed eyes. One or two scryers think that they, too, can trace the picture as it develops on the suggestion of some passage of light, colour or shadow in the glass or crystal. But, as a rule, the scryer cannot detect any process of development from such *points de mire*; though this may be the actual process.

On the whole there seems little doubt that successful crystal-gazing is the exertion of a not uncommon though far from universal faculty, like those of "chromatic audition"—the vivid association of certain sounds with certain colours—and the mental seeing of figures arranged in coloured diagrams (Galton, *Inquiry into Human Faculty*, pp. 114-154). The experience of hypnagogic illusions also seems far more rare than ordinary dreaming in sleep. Unfortunately, while these phenomena have been carefully studied by officially scientific characters, in England orthodox *savants* have disdained to observe crystal-gazing, while in France psychologists have too commonly experimented with subjects professionally hysterical and quite untrustworthy. Our remarks are therefore based mainly on considerable personal study of "scrying" among normal British subjects of both sexes, to whom the topic was previously unknown.

The superstitious associations of crystal-gazing, as of hypnotism, appear to bar the way to official scientific investigation, and the fluctuating proficiency of the seers, who cannot command success, or determine the causes and conditions of success and failure, tends in the same direction. The existence, too, of paid professionals who lead astray silly women, encourages the natural scientific contempt for the study of the faculty.

The seeing of the pictures, as far as we have spoken of it, appears to be a thing unusual, but in no way abnormal, any more than dreams or hypnagogic illusions are abnormal. Crystal pictures, however, are commonly dismissed as mere results of "imagination," a theory which, of course, is of no real assistance to psychology. Persons of recognized "imaginativeness," such as novelists and artists, do not seem more or less capable of the hallucinatory experiences than their sober neighbours; while persons not otherwise recognizably "imaginative" (we could quote a singularly accurate historian) are capable of the experiences. It is unfortunate, as it awakens prejudice, but in the present writer's opinion it is true, that crystal-gazing sometimes is rewarded with results which may be styled "supra-normal." In addition to the presentation of revived memories, and of "objectivation of ideas or images consciously or unconsciously in the mind of the percipient," there occur "visions, possibly telepathic or clairvoyant, implying acquirement of knowledge by supra-normal means."<sup>1</sup>

A number of examples occurring during experiments made by the present writer and by his acquaintances in 1897 were carefully recorded and attested by the signatures of all concerned.

<sup>1</sup> *Proceedings of the Society for Psychological Research*, v. 486.

The cases, or rather a selection of the cases, are printed in A. Lang's book, *The Making of Religion* (2nd ed., London, 1902, pp. 87-104). Others are chronicled in A. Lang's Introduction to Mr N. W. Thomas's work, *Crystal Gazing* (1905). The experiments took this form: any person might ask the scryer (a lady who had never previously heard of crystal-gazing) "to see what he was thinking of." The scryer, who was a stranger in a place which she had not visited before, gave, in a long series of cases, a description of the person or place on which the inquirer's thoughts were fixed. The descriptions, though three or four entire failures occurred, were of remarkable accuracy as a rule, and contained facts and incidents unknown to the inquirers, but confirmed as accurate. In fact, some Oriental scenes and descriptions of incidents were corroborated by a letter from India which arrived just after the experiment; and the same thing happened when the events described were occurring in places less remote. On one occasion a curious set of incidents were described, which happened to be vividly present to the mind of a sceptical stranger who chanced to be in the room during the experiment; events unknown to the inquirer in this instance. As an example of the minuteness of description, an inquirer, thinking of a brother in India, an officer in the army, whose hair had suffered in an encounter with a tiger, had described to her an officer in undress uniform, with bald scars through the hair on his temples, such as he really bore. The number and proportion of successes was too high to admit of explanation by chance coincidence, but success was not invariable. On one occasion the scryer could see nothing, "the crystal preserved its natural diaphaneity," as Dr Dee says; and there were failures with two or three inquirers. On the other hand no record was kept in several cases of success.

Whoever can believe that the successes were numerous and that descriptions were given correctly—not only of facts present to the minds of inquirers, and of other persons present who were not consciously taking a share in the experiments, but also of facts necessarily unknown to all concerned—must of course be most impressed by the latter kind of success. If the process commonly styled "telepathy" exists (see TELEPATHY), that may account for the scryer's power of seeing facts which are in the mind of the inquirer. But when the scryers see details of various sorts, which are unknown to the inquirer, but are verified on inquiry, then telepathy perhaps fails to provide an explanation. We seem to be confronted with actual clairvoyance (*q.v.*), or *vue à distance*. It would be vain to form hypotheses as to the conditions or faculties which make *vue à distance* possible. This way lie metaphysics, with Hegel's theory of the Sensitive Soul, or Myers' theory of the Subliminal Self. "The intuitive soul," says Hegel, "oversteps the conditions of time and space; it beholds things remote, things long past, and things to come."<sup>1</sup>

What we need, if any progress is to be made in knowledge of the subject, is not a metaphysical hypothesis, but a large, carefully tested, and well-recorded collection of examples, made by *savants* of recognized standing. At present we are where we were in electrical science, when Newton produced curious sparks while rubbing glass with paper. By way of facts, we have only a large body of unattested anecdotes of supra-normal successes in crystal-gazing, in many lands and ages; and the scanty records of modern amateur investigators, like the present writer. Even from these, if the honesty of all concerned be granted (and even clever dishonesty could not have produced many of the results), it would appear that we are investigating a strange and important human faculty. The writer is acquainted with no experiments in which it was attempted to discern the future (except in trivial cases as to events on the turf, when chance coincidence might explain the successes), and only with two or three cases in which there was an attempt to help historical science and discern the past by aid of psychical methods. The results were interesting and difficult to explain, but the experiments were few. Ordinary scryers of fancy pictures are common enough, but scryers capable of apparently supra-normal successes

<sup>1</sup> "Philosophie der Geistes," Hegel's *Werke*, vii. 179, 406, 408 (Berlin, 1845). Cf. Wallace's translation (Oxford, 1894).

are apparently rare. Perhaps something depends on the inquirer as well as the scryer.

The method of scrying, as generally practised, is simple. It is usual to place a glass ball on a dark ground, to sit with the back to the light, to focus the gaze on the ball (disregarding reflections, if these cannot be excluded), and to await results. Perhaps from five to ten minutes is a long enough time for the experiment. The scryer may let his consciousness play freely, but should not be disturbed by lookers-on. As a rule, if a person has the faculty he "sees" at the first attempt; if he fails in the first three or four efforts he need not persevere. Solitude is advisable at first, but few people can find time amounting to ten minutes for solitary studies of this sort, so busy and so gregarious is mankind. The writer has no experience of trance, sleep or auto-hypnotization produced in such experiments; scryers have always seemed to retain their full normal consciousness. As regards scepticism concerning the faculty we may quote what Mr Galton says about the faculty of visualization: "Scientific men as a class have feeble power of visual reproduction. . . . They had a mental deficiency of which they were unconscious, and, naturally enough, supposed that those who affirmed they were possessed of it were romancing."

**AUTHORITIES.**—A useful essay is that of "Miss X" (Miss Goodrich Freer) in the *Proceedings of the Society for Psychological Research*, v. The history of crystal-gazing is here traced, and many examples of the author's own experiments are recorded. A. Lang's *The Making of Religion*, ch. v., contains anthropological examples and a series of experiments. In N. W. Thomas's *Crystal Gazing* the history and anthropology of the subject are investigated, with modern instances. For Egypt, see Lane's *Modern Egyptians*, and the *Journal of Sir Walter Scott*, xi. 419-421, with *Quarterly Review*, No. 117, pp. 196-208. These Egyptian experiments of 1830 were vitiated by their method, the scryer being asked to see and describe a given person, named. He ought not, of course, to be told more than that he is to describe the inquirer's thoughts, and there ought never to be physical contact, as in holding hands, between the inquirer and the scryer during the experiment. There is a chapter on crystal-gazing in *Les Névroses et les idées fixes* of Dr Janet (1898). His statements are sometimes demonstrably inaccurate (see *Making of Religion*, Appendix C). A curious passage on the subject, by Ibn Khaldun, an Arabian medieval *savant*, is quoted by Mr Thomas from the printed Extracts of MSS. in the Bibliothèque Nationale. There is also a chapter on crystal-gazing in Myers' *Human Personality*. (A. L.)

**CRYSTALLITE.** In media which, on account of their viscosity, offer considerable resistance to those molecular movements which are necessary for the building and growth of crystals, rudimentary or imperfect forms of crystallization very frequently occur. Such media are the volcanic rocks when they are rapidly cooled, producing various kinds of pitchstone, obsidian, &c. When examined under the microscope these rocks consist largely of a perfectly amorphous or glassy base, through which are scattered great numbers of very minute crystals (microliths), and other bodies, termed crystallites, which seem to be stages in the formation of crystals. Crystallites may also be produced by allowing a solution of sulphur in carbon disulphide mixed with Canada balsam to evaporate slowly, and their development may be watched on a microscopic slide. Small globules appear (globulites), spherical and non-crystalline (so far as can be ascertained). They may coalesce or may arrange themselves into rows like strings of beads—margarites—(Gr. *μαργαρίτης*, a pearl) or into groups with a somewhat radiate arrangement—globospherites. Occasionally they take elongated shapes—longulites and baculites (Lat. *baculus*, a staff). The largest may become crystalline, changing suddenly into polyhedral bodies with evident double refraction and the optical properties belonging to crystals. Others become long and thread-like—trichites (Gr. *τριχίτης*, *τριχός*, hair)—and these are often curved, and a group of them may be implanted on the surface of a small crystal. All these forms are found in vitreous igneous rocks. H. P. J. Vogelsang, who was the first to direct much attention to them, believes that the globulites are preliminary stages in the formation of crystals.

Microliths, as distinguished from crystallites, have crystalline properties, and evidently belong to definite minerals or salts. When sufficiently large they are often recognizable, but usually

they are so small, so opaque, or so densely crowded together that this is impossible. In igneous rocks they are usually felspar, augite, enstatite, and iron oxides, and are found in abundance only where there is much uncrystallized glassy base; in contact-altered sediments, slags, &c., microlithic forms of garnet, spinel, sillimanite, cordierite, various lime silicates, and many other substances have been observed. Their form varies greatly, e.g. thin fibres (sillimanite, augite), short prisms or rods (felspar, enstatite, cordierite), or equidimensional grains (augite, spinel, magnetite). Occasionally they are perfectly shaped though minute crystals; more frequently they appear rounded (magnetite, &c.), or have brush-like terminations (augite, felspar, &c.). The larger microliths may contain enclosures of glass, and it is very common to find that the prisms have hollow, funnel-shaped ends, which are filled with vitreous material. These microliths, under the influence of crystalline forces, may rank themselves side by side to make up skeleton crystals and networks, or feathery and arborescent forms, which obey more or less closely the laws of crystallization of the substance to which they belong. They bear a very close resemblance to the arborescent frost flowers seen on window panes in winter, and to the stellate snow crystals. In magnetite the growths follow three axes at right angles to one another; in augite this is nearly, though not exactly, the case; in hornblende an angle of  $57^\circ$  may frequently be observed, corresponding to the prism angle of the fully-developed crystal. The interstices of the network may be partly filled up by a later growth. In other cases the crystalline arrangement of the microliths is less perfect, and branching, arborescent or feathery groupings are produced (e.g. felspar, augite, hornblende). Spherulites may be regarded as radiate aggregates of such microliths (mostly felspar mixed with quartz or tridymite). If larger porphyritic crystals occur in the rock, the microliths of the vitreous base frequently grow outwards from their faces; in some cases a definite parallelism exists between the two, but more frequently the early crystal has served merely as a centre, or nucleus, from which the microliths and spherulites have spread in all directions. (J. S. F.)

**CRYSTALLIZATION**, the art of obtaining a substance in the form of crystals; it is an important process in chemistry since it permits the purification of a substance, or the separation of the constituents of a mixture. Generally a substance is more soluble in a solvent at a high temperature than at a low, and consequently, if a boiling concentrated solution be allowed to cool, the substance will separate in virtue of the diminished solubility, and the slower the cooling the larger and more perfect will be the crystals formed. If, as sometimes appears, such a solution refuses to crystallize, the expedient of inoculating the solution with a minute crystal of the same substance, or with a similar substance, may be adopted; shaking the solution, or the addition of a drop of another solvent, may also occasion the desired result. "Fractional crystallization" consists in repeatedly crystallizing a salt so as to separate the substances of different solubilities. Examples are especially presented in the study of the rare-earths. Other conditions under which crystals are formed are given in the article CRYSTALLOGRAPHY.

**CRYSTALLOGRAPHY** (from the Gr. *κρύσταλλος*, ice, and *γράφω*, to write), the science of the forms, properties and structure of crystals. Homogeneous solid matter, the physical and chemical properties of which are the same about every point, may be either amorphous or crystalline. In amorphous matter all the properties are the same in every direction in the mass; but in crystalline matter certain of the physical properties vary with the direction. The essential properties of crystalline matter are of two kinds, viz. the general properties, such as density, specific heat, melting-point and chemical composition, which do not vary with the direction; and the directional properties, such as cohesion and elasticity, various optical, thermal and electrical properties, as well as external form. By reason of the homogeneity of crystalline matter the directional properties are the same in all parallel directions in the mass, and there may be a certain symmetrical repetition of the directions along which the properties are the same.

When the crystallization of matter takes place under conditions free from outside influences the peculiarities of internal structure are expressed in the external form of the mass, and there results a solid body bounded by plane surfaces intersecting in straight edges, the directions of which bear an intimate relation to the internal structure. Such a polyhedron (*πολύς*, many, *ἔδρα*, base or face) is known as a crystal. An example of this is sugar-candy, of which a single isolated crystal may have grown freely in a solution of sugar. Matter presenting well-defined and regular crystal forms, either as a single crystal or as a group of individual crystals, is said to be crystallized. If, on the other hand, crystallization has taken place about several centres in a confined space, the development of plane surfaces may be prevented, and a crystalline aggregate of differently orientated crystal-individuals results. Examples of this are afforded by loaf sugar and statuary marble.

After a brief historical sketch, the more salient principles of the subject will be discussed under the following sections:—

#### I. CRYSTALLINE FORM.

- (a) Symmetry of Crystals.
- (b) Simple Forms and Combinations of Forms.
- (c) Law of Rational Indices.
- (d) Zones.
- (e) Projection and Drawing of Crystals.
- (f) Crystal Systems and Classes.
  1. Cubic System.
  2. Tetragonal System.
  3. Orthorhombic System.
  4. Monoclinic System.
  5. Anorthic System.
  6. Hexagonal System.
- (g) Regular Grouping of Crystals (Twinning, &c.).
- (h) Irregularities of Growth of Crystals: Characters of Faces.
- (i) Theories of Crystal Structure.

#### II. PHYSICAL PROPERTIES OF CRYSTALS.

- (a) Elasticity and Cohesion (Cleavage, Etching, &c.).
- (b) Optical Properties (Interference figures, Pleochroism, &c.).
- (c) Thermal Properties.
- (d) Magnetic and Electrical Properties.

#### III. RELATIONS BETWEEN CRYSTALLINE FORM AND CHEMICAL COMPOSITION.

Most chemical elements and compounds are capable of assuming the crystalline condition. Crystallization may take place when solid matter separates from solution (e.g. sugar, salt, alum), from a fused mass (e.g. sulphur, bismuth, felspar), or from a vapour (e.g. iodine, camphor, haematite; in the last case by the interaction of ferric chloride and steam). Crystalline growth may also take place in solid amorphous matter, for example, in the devitrification of glass, and the slow change in metals when subjected to alternating stresses. Beautiful crystals of many substances may be obtained in the laboratory by one or other of these methods, but the most perfectly developed and largest crystals are those of mineral substances found in nature, where crystallization has continued during long periods of time. For this reason the physical science of crystallography has developed side by side with that of mineralogy. Really, however, there is just the same connexion between crystallography and chemistry as between crystallography and mineralogy, but only in recent years has the importance of determining the crystallographic properties of artificially prepared compounds been recognized.

*History.*—The word "crystal" is from the Gr. *κρύσταλλος*, meaning clear ice (Lat. *crystallum*), a name which was also applied to the clear transparent quartz ("rock-crystal") from the Alps, under the belief that it had been formed from water by intense cold. It was not until about the 17th century that the word was extended to other bodies, either those found in nature or obtained by the evaporation of a saline solution, which resembled rock-crystal in being bounded by plane surfaces, and often also in their clearness and transparency.

The first important step in the study of crystals was made by Nicolaus Steno, the famous Danish physician, afterwards bishop of Titopolis, who in his treatise *De solido intra solidum naturaliter contento* (Florence, 1669; English translation, 1671) gave the

results of his observations on crystals of quartz. He found that although the faces of different crystals vary considerably in shape and relative size, yet the angles between similar pairs of faces are always the same. He further pointed out that the crystals must have grown in a liquid by the addition of layers of material upon the faces of a nucleus, this nucleus having the form of a regular six-sided prism terminated at each end by a six-sided pyramid. The thickness of the layers, though the same over each face, was not necessarily the same on different faces, but depended on the position of the faces with respect to the surrounding liquid; hence the faces of the crystal, though variable in shape and size, remained parallel to those of the nucleus, and the angles between them constant. Robert Hooke in his *Micrographia* (London, 1665) had previously noticed the regularity of the minute quartz crystals found lining the cavities of flints, and had suggested that they were built up of spheroids. About the same time the double refraction and perfect rhomboidal cleavage of crystals of calcite or Iceland-spar were studied by Erasmus Bartholinus (*Experimenta crystalli Islandici disdiastictici*, Copenhagen, 1669) and Christiaan Huygens (*Traité de la lumière*, Leiden, 1690); the latter supposed, as did Hooke, that the crystals were built up of spheroids. In 1695 Anton van Leeuwenhoek observed under the microscope that different forms of crystals grow from the solutions of different salts. Andreas Libavius had indeed much earlier, in 1597, pointed out that the salts present in mineral waters could be ascertained by an examination of the shapes of the crystals left on evaporation of the water; and Domenico Guglielmini (*Riflessioni filosofiche dedotte dalle figure de' sali*, Padova, 1706) asserted that the crystals of each salt had a shape of their own with the plane angles of the faces always the same.

The earliest treatise on crystallography is the *Prodromus Crystallographiae* of M. A. Cappeller, published at Lucerne in 1723. Crystals were mentioned in works on mineralogy and chemistry; for instance, C. Linnaeus in his *Systema Naturae* (1735) described some forty common forms of crystals amongst minerals. It was not, however, until the end of the 18th century that any real advances were made, and the French crystallographers Romé de l'Isle and the abbé Haüy are rightly considered as the founders of the science. J. B. L. de Romé de l'Isle (*Essai de cristallographie*, Paris, 1772; *Cristallographie, ou description des formes propres à tous les corps du règne minéral*, Paris, 1783) made the important discovery that the various shapes of crystals of the same natural or artificial substance are all intimately related to each other; and further, by measuring the angles between the faces of crystals with the goniometer (*g.o.*), he established the fundamental principle that these angles are always the same for the same kind of substance and are characteristic of it. Replacing by single planes or groups of planes all the similar edges or solid angles of a figure called the "primitive form" he derived other related forms. Six kinds of primitive forms were distinguished, namely, the cube, the regular octahedron, the regular tetrahedron, a rhombohedron, an octahedron with a rhombic base, and a double six-sided pyramid. Only in the last three can there be any variation in the angles: for example, the primitive octahedron of alum, nitre and sugar were determined by Romé de l'Isle to have angles of  $110^\circ$ ,  $120^\circ$  and  $100^\circ$  respectively. René Just Haüy in his *Essai d'une théorie sur la structure des cristaux* (Paris, 1784; see also his *Treatises on Mineralogy and Crystallography*, 1801, 1822) supported and extended these views, but took for his primitive forms the figures obtained by splitting crystals in their directions of easy fracture of "cleavage," which are always the same in the same kind of substance. Thus he found that all crystals of calcite, whatever their external form (see, for example, figs. 1-6 in the article CALCITE), could be reduced by cleavage to a rhombohedron with interfacial angles of  $75^\circ$ . Further, by stacking together a number of small rhombohedra of uniform size he was able, as had been previously done by J. G. Gahn in 1773, to reconstruct the various forms of calcite crystals. Fig. 1 shows a scalenohedron (*σκαληνός*, uneven) built up in this manner of rhombohedra; and fig. 2 a regular octahedron built

up of cubic elements, such as are given by the cleavage of galena and rock-salt.

The external surfaces of such a structure, with their step-like arrangement, correspond to the plane faces of the crystal, and the bricks may be considered so small as not to be separately visible. By making the steps one, two or three bricks in width and one, two or three bricks in height the various secondary

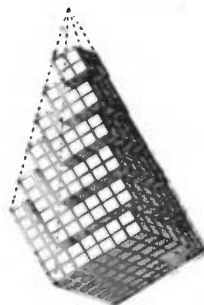

FIG. 1.—Scalenohedron built up of Rhombohedra.

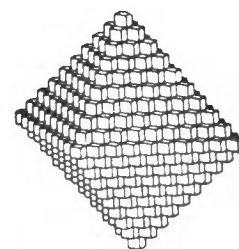

FIG. 2.—Octahedron built up of Cubes.

faces on the crystal are related to the primitive form or "cleavage nucleus" by a law of whole numbers, and the angles between them can be arrived at by mathematical calculation. By measuring with the goniometer the inclinations of the secondary faces to those of the primitive form Haüy found that the secondary forms are always related to the primitive form on crystals of numerous substances in the manner indicated, and that the width and the height of a step are always in a simple ratio, rarely exceeding that of 1 : 6. This laid the foundation of the important "law of rational indices" of the faces of crystals.

The German crystallographer C. S. Weiss (*De indagando formarum crystallinarum caractere geometrico principali dissertatio*, Leipzig, 1809; *Übersichtliche Darstellung der verschiedenen natürlichen Abtheilungen der Krystallisations-Systeme*, Denkschrift der Berliner Akad. der Wissensch., 1814-1815) attacked the problem of crystalline form from a purely geometrical point of view, without reference to primitive forms or any theory of structure. The faces of crystals were considered by their intercepts on co-ordinate axes, which were drawn joining the opposite corners of certain forms; and in this way the various primitive forms of Haüy were grouped into four classes, corresponding to the four systems described below under the names cubic, tetragonal, hexagonal and orthorhombic. The same result was arrived at independently by F. Mohs, who further, in 1822, asserted the existence of two additional systems with oblique axes. These two systems (the monoclinic and anorthic) were, however, considered by Weiss to be only hemihedral or tetartohedral modifications of the orthorhombic system, and they were not definitely established until 1835, when the optical characters of the crystals were found to be distinct. A system of notation to express the relation of each face of a crystal to the co-ordinate axes of reference was devised by Weiss, and other notations were proposed by F. Mohs, A. Lévy (1825), C. F. Naumann (1826), and W. H. Miller (*Treatise on Crystallography*, Cambridge, 1839). For simplicity and utility in calculation the Millerian notation, which was first suggested by W. Whewell in 1825, surpasses all others and is now generally adopted, though those of Lévy and Naumann are still in use.

Although the peculiar optical properties of Iceland-spar had been much studied ever since 1669, it was not until much later that any connexion was traced between the optical characters of crystals and their external form. In 1818 Sir David Brewster found that crystals could be divided optically into three classes, viz. isotropic, uniaxial and biaxial, and that these classes corresponded with Weiss's four systems (crystals belonging to the cubic system being isotropic, those of the tetragonal and hexagonal being uniaxial, and the orthorhombic being biaxial). Optically biaxial crystals were afterwards shown by J. F. W. Herschel and F. E. Neumann in 1822 and 1835 to be of three kinds, corresponding with the orthorhombic, monoclinic and



anorthic systems. It was, however, noticed by Brewster himself that there are many apparent exceptions, and the "optical anomalies" of crystals have been the subject of much study. The intimate relations existing between various other physical properties of crystals and their external form have subsequently been gradually traced.

The symmetry of crystals, though recognized by Romé de l'Isle and Haüy, in that they replaced all similar edges and corners of their primitive forms by similar secondary planes, was not made use of in defining the six systems of crystallization, which depended solely on the lengths and inclinations of the axes of reference. It was, however, necessary to recognize that in each system there are certain forms which are only partially symmetrical, and these were described as hemihedral and tetartohedral forms (*i.e.*  $\eta\mu\mu$ -, half-faced, and  $\tau\epsilon\alpha\pi\tau\omicron\varsigma$ -, quarter-faced forms).

As a consequence of Haüy's law of rational intercepts, or, as it is more often called, the law of rational indices, it was proved by J. F. C. Hessel in 1830 that thirty-two types of symmetry are possible in crystals. Hessel's work remained overlooked for sixty years, but the same important result was independently arrived at by the same method by A. Gadolin in 1867. At the present day, crystals are considered as belonging to one or other of thirty-two classes, corresponding with these thirty-two types of symmetry, and are grouped in six systems. More recently, theories of crystal structure have attracted attention, and have been studied as purely geometrical problems of the homogeneous partitioning of space.

The historical development of the subject is treated more fully in the article CRYSTALLOGRAPHY in the 9th edition of this work. Reference may also be made to C. M. Marx, *Geschichte der Crystallkunde* (Karlsruhe and Baden, 1825); W. Whewell, *History of the Inductive Sciences*, vol. iii. (3rd ed., London, 1857); F. von Kobell, *Geschichte der Mineralogie von 1650-1860* (München, 1864); L. Fletcher, *An Introduction to the Study of Minerals* (British Museum Guide-Book); L. Fletcher, *Recent Progress in Mineralogy and Crystallography* [1832-1894] (Brit. Assoc. Rep., 1894).

**I. CRYSTALLINE FORM**

The fundamental laws governing the form of crystals are:—

1. Law of the Constancy of Angle.
2. Law of Symmetry.
3. Law of Rational Intercepts or Indices.

According to the first law, the angles between corresponding faces of all crystals of the same chemical substance are always the same and are characteristic of the substance.

(a) *Symmetry of Crystals.*

Crystals may, or may not, be symmetrical with respect to a point, a line or axis, and a plane; these "elements of symmetry" are spoken of as a centre of symmetry, an axis of symmetry, and a plane of symmetry respectively.

*Centre of Symmetry.*—Crystals which are centro-symmetrical have their faces arranged in parallel pairs; and the two parallel faces, situated on opposite sides of the centre (*O* in fig. 3) are alike in surface characters, such as lustre, striations, and figures of corrosion. An octahedron (fig. 3) is bounded by four pairs of parallel faces. Crystals belonging to many of the hemihedral and tetartohedral classes of the six systems of crystallization are devoid of a centre of symmetry.

*Axes of Symmetry.*—Consider the vertical axis joining the opposite corners  $a_3$  and  $\bar{a}_3$  of an octahedron (fig. 3) and passing through its centre *O*: by rotating the crystal about this axis through a right angle ( $90^\circ$ ) it reaches a position such that the orientation of its faces is the same as before the rotation; the face  $\bar{a}_1\bar{a}_2\bar{a}_3$ , for example, coming into the position of  $a_1a_2a_3$ . During a complete rotation of  $360^\circ$  ( $=90^\circ \times 4$ ), the crystal occupies four such interchangeable positions. Such an axis of symmetry is known as a tetrad axis of symmetry. Other tetrad axes of the octahedron are  $a_2\bar{a}_2$  and  $a_1\bar{a}_1$ .

An axis of symmetry of another kind is that which passing through the centre *O* is normal to a face of the octahedron. By rotating the crystal about such an axis *Op* (fig. 3) through an angle of  $120^\circ$  those faces which are not perpendicular to the

axis occupy interchangeable positions; for example, the face  $a_1a_2a_3$  comes into the position of  $\bar{a}_2\bar{a}_1\bar{a}_3$ , and  $\bar{a}_2\bar{a}_1\bar{a}_3$  to  $a_2\bar{a}_2\bar{a}_1$ . During a complete rotation of  $360^\circ$  ( $=120^\circ \times 3$ ) the crystal occupies similar positions three times. This is a triad axis of symmetry; and there being four pairs of parallel faces on an octahedron, there are four triad axes (only one of which is drawn in the figure).

An axis passing through the centre *O* and the middle points *d* of two opposite edges of the octahedron (fig. 4), *i.e.* parallel

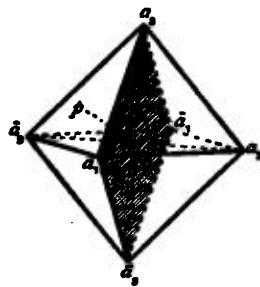

FIG. 3.

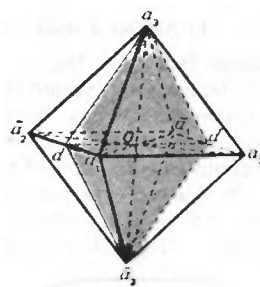

FIG. 4.

Axes and Planes of Symmetry of an Octahedron.

to the edges of the octahedron, is a dyad axis of symmetry. About this axis there may be rotation of  $180^\circ$ , and only twice in a complete revolution of  $360^\circ$  ( $=180^\circ \times 2$ ) is the crystal brought into interchangeable positions. There being six pairs of parallel edges on an octahedron, there are consequently six dyad axes of symmetry.

A regular octahedron thus possesses thirteen axes of symmetry (of three kinds), and there are the same number in the cube. Fig. 5 shows the three tetrad (or tetragonal) axes (*aa*), four triad (or trigonal) axes (*pp*), and six dyad (diad or diagonal) axes (*dd*).

Although not represented in the cubic system, there is still another kind of axis of symmetry possible in crystals. This is the hexad axis or hexagonal axis, for which the angle of rotation is  $60^\circ$ , or one-sixth of  $360^\circ$ . There can be only one hexad axis of symmetry in any crystal (see figs. 77-80).

*Planes of Symmetry.*—A regular octahedron can be divided into two equal and similar halves by a plane passing through the corners  $a_1a_2\bar{a}_1\bar{a}_2$  and the centre *O* (fig. 3). One-half is the mirror reflection of the other in this plane, which is called a plane of symmetry. Corresponding planes on either side of a plane of symmetry are inclined to it at equal angles. The octahedron can also be divided by similar planes of symmetry passing through the corners  $a_1a_2\bar{a}_1\bar{a}_2$  and  $a_2a_3\bar{a}_2\bar{a}_3$ . These three similar planes of symmetry are called the cubic planes of symmetry, since they are parallel to the faces

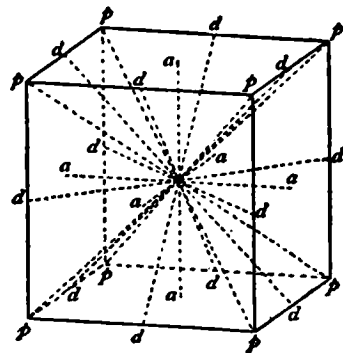

FIG. 5.—Axes of Symmetry of a Cube.

of the cube (compare figs. 6-8, showing combinations of the octahedron and the cube).

A regular octahedron can also be divided symmetrically into two equal and similar portions by a plane passing through the corners  $a_3$  and  $\bar{a}_3$ , the middle points *d* of the edges  $a_1\bar{a}_2$  and  $\bar{a}_1a_2$ , and the centre *O* (fig. 4). This is called a dodecahedral plane of symmetry, being parallel to the face of the rhombic dodecahedron which truncates the edge  $a_1a_2$  (compare fig. 14, showing a combination of the octahedron and rhombic dodecahedron). Another similar plane of symmetry is that passing through the corners  $a_2\bar{a}_2$  and the middle points of the edges  $a_1a_2$  and  $\bar{a}_1\bar{a}_2$ , and altogether there are six dodecahedral planes of symmetry, two through each of the corners  $a_1, a_2, a_3$  of the octahedron.

A regular octahedron and a cube are thus each symmetrical with respect to the following elements of symmetry: a centre of symmetry, thirteen axes of symmetry (of three kinds), and nine planes of symmetry (of two kinds). This degree of symmetry, which is the type corresponding to one of the classes of the cubic system, is the highest possible in crystals. As will be pointed out below, it is possible, however, for both the octahedron and the cube to be associated with fewer elements of symmetry than those just enumerated.

(b) *Simple Forms and Combinations of Forms.*

A single face  $a_1a_2a_3$  (figs. 3 and 4) may be repeated by certain of the elements of symmetry to give the whole eight faces of the octahedron. Thus, by rotation about the vertical tetrad axis  $a_3\bar{a}_3$  the four upper faces are obtained; and by rotation of these about one or other of the horizontal tetrad axes the eight faces are derived. Or again, the same repetition of the faces may be arrived at by reflection across the three cubic planes of symmetry. (By reflection across the six dodecahedral planes

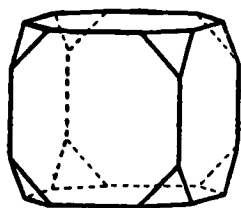

FIG. 6.—Cube in combination with Octahedron.

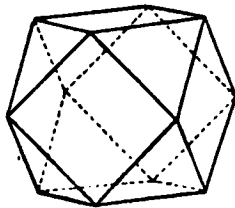

FIG. 7.—Cubo-octahedron.

of symmetry a tetrahedron only would result, but if this is associated with a centre of symmetry we obtain the octahedron.) Such a set of similar faces, obtained by symmetrical repetition, constitutes a "simple form." An octahedron thus consists of eight similar faces, and a cube is bounded by six faces all of which have the same surface characters, and parallel to each of which all the properties of the crystal are identical.

Examples of simple forms amongst crystallized substances are octahedra of alum and spinel and cubes of salt and fluorspar. More usually, however, two or more forms are present on a crystal, and we then have a combination of forms, or simply a "combination." Figs. 6, 7 and 8 represent combinations of the octahedron and the cube; in the first the faces of the cube predominate, and in the third those of the octahedron; fig. 7 with the two forms equally developed is called a cubo-octahedron.

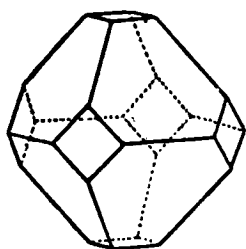

FIG. 8.—Octahedron in combination with Cube.

Each of these combined forms has all the elements of symmetry proper to the simple forms.

The simple forms, though referable to the same type of symmetry and axes of reference, are quite independent, and cannot be derived one from the other by symmetrical repetition, but, after the manner of Romé de l'Isle, they may be derived by replacing edges or corners by a face equally inclined to the faces forming the edges or corners; this is known as "truncation" (Lat. *truncare*, to cut off). Thus in fig. 6 the corners of the cube are symmetrically replaced or truncated by the faces of the octahedron, and in fig. 8 those of the octahedron are truncated by the cube.

(c) *Law of Rational Intercepts.*

For axes of reference,  $OX$ ,  $OY$ ,  $OZ$  (fig. 9), take any three edges formed by the intersection of three faces of a crystal. These axes are called the crystallographic axes, and the planes in which they lie the axial planes. A fourth face on the crystal intersecting these three axes in the points  $A$ ,  $B$ ,  $C$  is taken as the parametral plane, and the lengths  $OA : OB : OC$  are the parameters of the crystal. Any other face on the crystal may be

referred to these axes and parameters by the ratio of the intercepts

$$\frac{OA}{h} : \frac{OB}{k} : \frac{OC}{l}.$$

Thus for a face parallel to the plane  $ABc$  the intercepts are in the ratio  $OA : OB : Oc$ , or

$$\frac{OA}{1} : \frac{OB}{1} : \frac{OC}{2}$$

and for a plane  $fg\bar{C}$  they are  $Of : Og : O\bar{C}$  or

$$\frac{OA}{2} : \frac{OB}{3} : \frac{OC}{1}.$$

Now the important relation existing between the faces of a crystal is that the denominators  $h$ ,  $k$  and  $l$  are always rational whole numbers, rarely exceeding 6, and usually 0, 1, 2 or 3. Written in the form  $(hkl)$ ,  $h$  referring to the axis  $OX$ ,  $k$  to  $OY$ , and  $l$  to  $OZ$ , they are spoken of as the indices (Millerian indices) of the face. Thus of a face parallel to the plane  $ABC$  the indices are  $(111)$ , of  $ABc$  they are  $(112)$ , and of  $fg\bar{C}$   $(23\bar{1})$ . The indices are thus inversely proportional to the intercepts, and the law of rational intercepts is often spoken of as the "law of rational indices."

The angular position of a face is thus completely fixed by its indices; and knowing the angles between the axial planes and the parametral plane all the angles of a crystal can be calculated when the indices of the faces are known.

Although any set of edges formed by the intersection of three planes may be chosen for the crystallographic axes, it is in practice usual to select certain edges related to the symmetry of the crystal, and usually coincident with axes of symmetry; for then the indices will be simpler and all faces of the same simple form will have a similar set of indices. The angles between the axes and the ratio of the lengths of the parameters

$OA : OB : OC$  (usually given as  $a : b : c$ ) are spoken of as the "elements" of a crystal, and are constant for and characteristic of all crystals of the same substance.

The six systems of crystal forms, to be enumerated below, are defined by the relative inclinations of the crystallographic axes and the lengths of the parameters. In the cubic system, for example, the three crystallographic axes are taken parallel to the three tetrad axes of symmetry, *i.e.* parallel to the edges of the cube (fig. 5) or joining the opposite corners of the octahedron (fig. 3), and they are therefore all at right angles; the parametral plane  $(111)$  is a face of the octahedron, and the parameters are all of equal length. The indices of the eight faces of the octahedron will then be  $(111)$ ,  $(\bar{1}\bar{1}\bar{1})$ ,  $(1\bar{1}\bar{1})$ ,  $(\bar{1}11)$ ,  $(11\bar{1})$ ,  $(\bar{1}\bar{1}1)$ ,  $(111)$ ,  $(\bar{1}\bar{1}\bar{1})$ . The symbol  $\{111\}$  indicates all the faces belonging to this simple form. The indices of the six faces of the cube are  $(100)$ ,  $(010)$ ,  $(001)$ ,  $(\bar{1}00)$ ,  $(0\bar{1}0)$ ,  $(00\bar{1})$ ; here each face is parallel to two axes, *i.e.* intercepts them at infinity, so that the corresponding indices are zero.

(d) *Zones.*

An important consequence of the law of rational intercepts is the arrangement of the faces of a crystal in zones. All faces, whether they belong to one or more simple forms, which intersect in parallel edges are said to lie in the same zone. A line drawn through the centre  $O$  of the crystal parallel to these edges is called a zone-axis, and a plane perpendicular to this axis is called a zone-plane. On a cube, for example, there are three zones each containing four faces, the zone-axes being coincident with the three tetrad axes of symmetry. In the crystal of zircon (fig. 88) the eight prism-faces  $a$ ,  $m$ , &c. constitute a zone, denoted

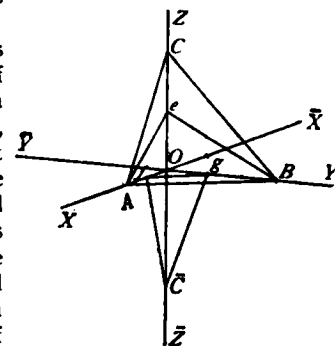

FIG. 9.—Crystallographic axes of reference.

by  $[a, m, a', \&c.]$ , with the vertical tetrad axis of symmetry as zone-axis. Again the faces  $[a, x, p, e', p', x'', a'']$  lie in another zone, as may be seen by the parallel edges of intersection of the faces in figs. 87 and 88; three other similar zones may be traced on the same crystal.

The direction of the line of intersection (*i.e.* zone-axis) of any two planes  $(hkl)$  and  $(h_1k_1l_1)$  is given by the zone-indices  $[uvw]$ , where  $u = kl_1 - lk_1$ ,  $v = lh_1 - hl_1$ , and  $w = hk_1 - kh_1$ , these being obtained from the face-indices by cross multiplication as follows:—

$$\begin{array}{cccc} h & k & l & h & k & l \\ & \times & \times & \times & & \\ h_1 & k_1 & l_1 & h_1 & k_1 & l_1 \end{array}$$

Any other face  $(h_2k_2l_2)$  lying in this zone must satisfy the equation

$$h_2u + k_2v + l_2w = 0.$$

This important relation connecting the indices of a face lying in a zone with the zone-indices is known as Weiss's zone-law, having been first enunciated by C. S. Weiss. It may be pointed out that the indices of a face may be arrived at by adding together the indices of faces on either side of it and in the same zone; thus,  $(311)$  in fig. 12 lies at the intersections of the three zones  $[210, 101]$ ,  $[201, 110]$  and  $[211, 100]$ , and is obtained by adding together each set of indices.

(e) Projection and Drawing of Crystals.

The shapes and relative sizes of the faces of a crystal being as a rule accidental, depending only on the distance of the faces

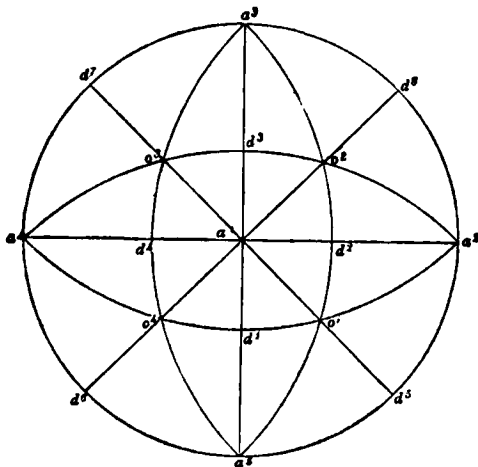
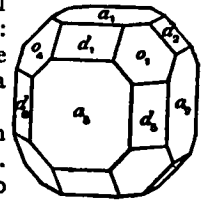

FIG. 10.—Stereographic Projection of a Cubic Crystal.

from the centre of the crystal and not on their angular relations, it is often more convenient to consider only the directions of the normals to the faces. For this purpose projections are drawn, with the aid of which the zonal relations of a crystal are more readily studied and calculations are simplified.

The kind of projection most extensively used is the "stereographic projection." The crystal is considered to be placed inside a sphere from the centre of which normals are drawn to all the faces of the crystal. The points at which these normals intersect the surface of the sphere are called the poles of the faces, and by these poles the positions of the faces are fixed. The poles of all faces in the same zone on the crystal will lie on a great circle of the sphere, which are therefore called zone-circles. The calculation of the angles between the normals of faces and between zone-circles is then performed by the ordinary methods of spherical trigonometry. The stereographic projection, however, represents the poles and zone-circles on a plane surface and not on a spherical surface. This is achieved by drawing lines joining all the poles of the faces with the north or south pole of the sphere and finding their points of intersection with the plane of the equatorial great circle, or primitive circle, of the sphere, the projection being represented on this plane. In fig. 10 is shown the stereographic projection, or stereogram, of a

cubic crystal;  $a^1, a^2, \&c.$  are the poles of the faces of the cube,  $o^1, o^2, \&c.$  those of the octahedron, and  $d^1, d^2, \&c.$  those of the rhombic dodecahedron. The straight lines and circular arcs are the projections on the equatorial plane of the great circles in which the nine planes of symmetry intersect the sphere. A drawing of a crystal showing a combination of the cube, octahedron and rhombic dodecahedron is shown in fig. 11, in which the faces are lettered the same as the corresponding poles in the projection. From the zone-circles in the projection and the parallel edges in the drawing the zonal relations of the faces are readily seen: thus  $[a^1o^1d^1]$ ,  $[a^1d^1o^1]$ ,  $[a^2o^2d^2]$ , &c. are zones. A stereographic projection of a rhombohedral crystal is given in fig. 72.



Another kind of projection in common use is the "gnomonic projection" (fig. 12). Here the plane of projection is tangent to the sphere, and normals to all the faces are drawn from the centre of the sphere to intersect the plane of projection. In this case all zones are represented by straight lines. Fig. 12 is the gnomonic projection of a cubic crystal, the plane of projection being tangent to the sphere at the pole of an octahedral face  $(111)$ , which is therefore in the centre of the projection. The indices of the several poles are given in the figure.

In drawing crystals the simple plans and elevations of descriptive geometry (*e.g.* the plans in the lower part of figs. 87 and 88) have sometimes the advantage of showing the symmetry of a crystal, but they give no idea of solidity. For instance, a cube would be represented merely by a square, and an octahedron by a square with lines joining the opposite corners. True perspective drawings are never used in the representation of crystals, since for showing the zonal relations it is important to preserve the parallelism of the edges. If, however, the eye, or point of vision, is regarded as being at an infinite distance from the object all the rays will be parallel, and edges which are parallel on the crystal will be represented by parallel lines in the drawing. The plane of the drawing, in which the parallel rays joining the corners of the crystals and the eye intersect, may be either perpendicular or oblique to the rays; in the former case we have an "orthographic" ( $\delta\rho\theta\theta\acute{o}s$ , straight;  $\lambda\rho\acute{\alpha}\phi\epsilon\iota\nu$ , to draw) drawing, and in the latter a "clinographic" ( $\kappa\lambda\iota\nu\epsilon\iota\nu$ , to incline)

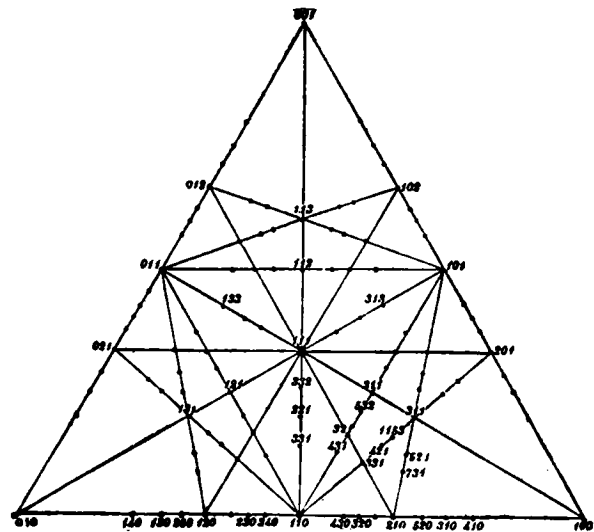

FIG. 12.—Gnomonic Projection of a Cubic Crystal.

drawing. Clinographic drawings are most frequently used for representing crystals. In representing, for example, a cubic crystal (fig. 11) a cube face  $a^1$  is first placed parallel to the plane on which the crystal is to be projected and with one set of edges vertical; the crystal is then turned through a small angle about a vertical axis until a second cube face  $a^2$  comes into view,

and the eye is then raised so that a third cube face  $a^1$  may be seen.

(f) Crystal Systems and Classes.

According to the mutual inclinations of the crystallographic axes of reference and the lengths intercepted on them by the parametral plane, all crystals fall into one or other of six groups or systems, in each of which there are several classes depending on the degree of symmetry. In the brief description which follows of these six systems and thirty-two classes of crystals we shall proceed from those in which the symmetry is most complex to those in which it is simplest.

1. CUBIC SYSTEM

(Isometric; Regular; Octahedral; Tesseral).

In this system the three crystallographic axes of reference are all at right angles to each other and are equal in length. They are parallel to the edges of the cube, and in the different classes coincide either with tetrad or dyad axes of symmetry. Five classes are included in this system, in all of which there are, besides other elements of symmetry, four triad axes.

In crystals of this system the angle between any two faces  $P$  and  $Q$  with the indices  $(hkl)$  and  $(pqr)$  is given by the equation

$$\cos PQ = \frac{hp + kq + lr}{\sqrt{(h^2 + k^2 + l^2)(p^2 + q^2 + r^2)}}.$$

The angles between faces with the same indices are thus the same in all substances which crystallize in the cubic system: in other systems the angles vary with the substance and are characteristic of it.

HOLOSYMMETRIC CLASS

(Holohedral ( $\delta\lambda\sigma$ , whole); Hexakis-octahedral).

Crystals of this class possess the full number of elements of symmetry already mentioned above for the octahedron and the cube, viz. three cubic planes of symmetry, six dodecahedral planes, three tetrad axes of symmetry, four triad axes, six dyad axes, and a centre of symmetry.

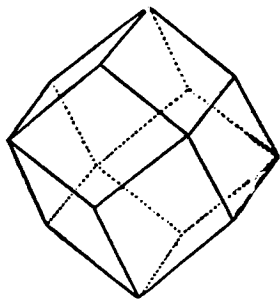

FIG. 13.—Rhombic Dodecahedron.

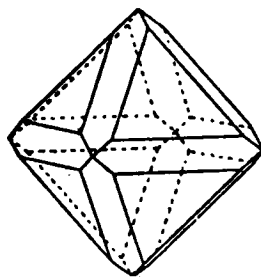

FIG. 14.—Combination of Rhombic Dodecahedron and Octahedron.

There are seven kinds of simple forms, viz. :—  
Cube (fig. 5). This is bounded by six square faces parallel to the cubic planes of symmetry; it is known also as the hexahedron. The angles between the faces are  $90^\circ$ , and the indices of the form are  $\{100\}$ . Salt, fluorspar and galena crystallize in simple cubes.

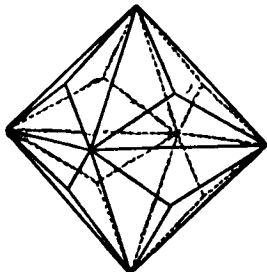

FIG. 15.—Triakis-octahedron.

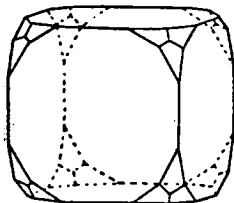

FIG. 16.—Combination of Triakis-octahedron and Cube.

Octahedron (fig. 3). Bounded by eight equilateral triangular faces perpendicular to the triad axes of symmetry. The angles between the faces are  $70^\circ 32'$  and  $109^\circ 28'$ , and the indices are  $\{111\}$ . Spinel, magnetite and gold crystallize in simple octahedra. Combinations of the cube and octahedron are shown in figs. 6-8.

Rhombic dodecahedron (fig. 13). Bounded by twelve rhomb-shaped faces parallel to the six dodecahedral planes of symmetry. The angles between the normals to adjacent faces are  $60^\circ$ , and

between other pairs of faces  $90^\circ$ ; the indices are  $\{110\}$ . Garnet frequently crystallizes in this form. Fig. 14 shows the rhombic dodecahedron in combination with the octahedron.

In these three simple forms of the cubic system (which are shown in combination in fig. 11) the angles between the faces and the indices

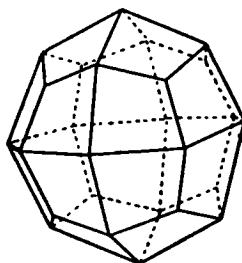

FIG. 17.—Icositetrahedron.

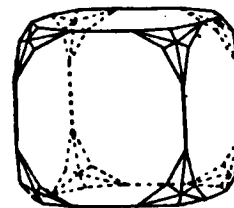

FIG. 18.—Combination of Icositetrahedron and Cube.

are fixed and are the same in all crystals; in the four remaining simple forms they are variable.

Triakis-octahedron (three-faced octahedron) (fig. 15). This solid is bounded by twenty-four isosceles triangles, and may be considered as an octahedron with a low triangular pyramid on each of its faces. As the inclinations of the faces may vary there is a series of these forms with the indices  $\{221\}$ ,  $\{331\}$ ,  $\{332\}$ , &c. or in general  $\{hhh\}$ .

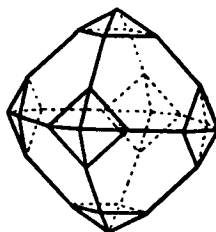

FIG. 19.—Combination of Icositetrahedron and Octahedron.

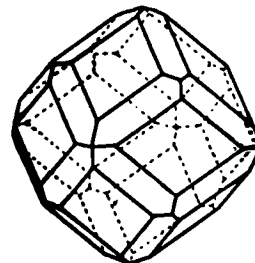

FIG. 20.—Combination of Icositetrahedron  $\{211\}$  and Rhombic Dodecahedron.

Icositetrahedron (fig. 17). Bounded by twenty-four trapezoidal faces, and hence sometimes called a "trapezohedron." The indices are  $\{211\}$ ,  $\{311\}$ ,  $\{322\}$ , &c., or in general  $\{hhh\}$ . Analcite, leucite and garnet often crystallize in the simple form  $\{211\}$ . Combinations are shown in figs. 18-20. The plane  $ABe$  in fig. 9 is one face  $\{112\}$  of an icositetrahedron; the indices of the remaining faces in this octant being  $\{211\}$  and  $\{121\}$ .

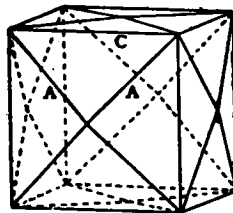

FIG. 21.—Tetrakis-hexahedron.

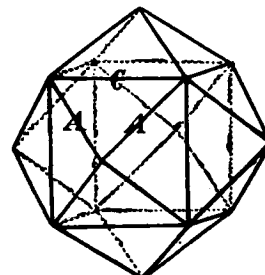

FIG. 22.—Tetrakis-hexahedron.

Tetrakis-hexahedron (four-faced cube) (figs. 21 and 22). Like the triakis-octahedron this solid is also bounded by twenty-four isosceles triangles, but here grouped in fours over the cubic faces. The two figures show how, with different inclinations of the faces, the form may vary, approximating in fig. 21 to the cube and in fig. 22 to the rhombic dodecahedron. The angles over the edges lettered  $A$  are different from the angles over the edges lettered  $C$ . Each face is parallel to one of the crystallographic axes and intercepts the two others in different lengths; the indices are therefore  $\{210\}$ ,  $\{310\}$ ,  $\{320\}$ , &c., in general  $\{hko\}$ . Fluorspar sometimes crystallizes in the simple form  $\{310\}$ ; more usually, however, in combination with the cube (fig. 23).

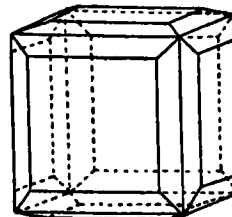

FIG. 23.—Combination of Tetrakis-hexahedron and Cube.

Hexakis-octahedron (fig. 24). Here each face of the octahedron is replaced by six scalene triangles, so that altogether there are

forty-eight faces. This is the greatest number of faces possible for any simple form in crystals. The faces are all oblique to the planes and axes of symmetry, and they intercept the three crystallographic axes in different lengths, hence the indices are all unequal, being in general  $\{hkl\}$ , or in particular cases  $\{321\}$ ,  $\{421\}$ ,  $\{432\}$ , &c. Such a form is known as the "general form" of the class. The interfacial angles over the three edges of each triangle are all different. These forms usually exist only in combination with other cubic forms (for example, fig. 25), but  $\{421\}$  has been observed as a simple form on fluorspar.

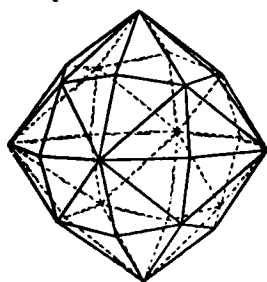

FIG. 24.—Hexakis-octahedron.

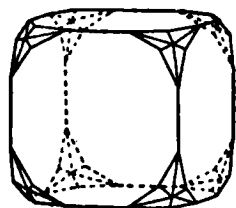

FIG. 25.—Combination of Hexakis-octahedron and Cube.

Several examples of substances which crystallize in this class have been mentioned above under the different forms; many others might be cited—for instance, the metals iron, copper, silver, gold, platinum, lead, mercury, and the non-metallic elements silicon and phosphorus.

TETRAHEDRAL CLASS

(Tetrahedral-hemihedral; Hexakis-tetrahedral).

In this class there is no centre of symmetry nor cubic planes of symmetry; the three tetrad axes become dyad axes of symmetry, and the four triad axes are polar, *i.e.* they are associated with different faces at their two ends. The other elements of symmetry (six dodecahedral planes and six dyad axes) are the same as in the last class. Of the seven simple forms, the cube, rhombic dodecahedron and tetrakis-hexahedron are geometrically the same as before, though on actual crystals the faces will have different surface characters.

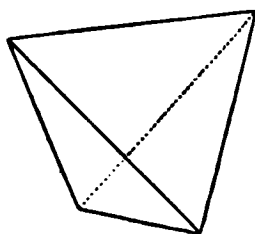

FIG. 26.—Tetrahedron.

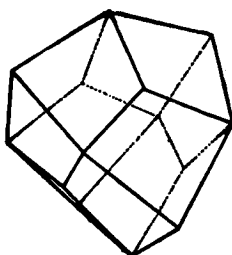

FIG. 27.—Deltoid Dodecahedron.

For instance, the cube faces will be striated parallel to only one of the diagonals (fig. 90), and etched figures on this face will be symmetrical with respect to two lines, instead of four as in the last class. The remaining simple forms have, however, only half the number of faces as the corresponding form in the last class, and are spoken of as "hemihedral with inclined faces."

Tetrahedron (fig. 26). This is bounded by four equilateral triangles and is identical with the regular tetrahedron of geometry. The angles between the normals to the faces are  $109^{\circ} 28'$ . It may be derived from the octahedron by suppressing the alternate faces.

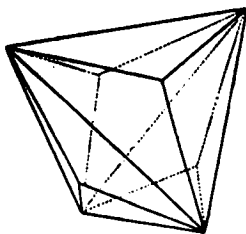

FIG. 28.—Triakis-tetrahedron.

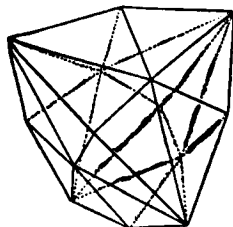

Fig. 29.—Hexakis-tetrahedron.

Deltoid<sup>1</sup> dodecahedron (fig. 27). This is the hemihedral form of the triakis-octahedron; it has the indices  $\{hkk\}$  and is bounded by twelve trapezoidal faces.

<sup>1</sup> From the Greek letter δέλτα, Δ; in general, a triangular-shaped object; also an alternative name for a trapezoid.

Triakis-tetrahedron (fig. 28). The hemihedral form  $\{hkk\}$  of the icositetrahedron; it is bounded by twelve isosceles triangles arranged in threes over the tetrahedron faces.

Hexakis-tetrahedron (fig. 29). The hemihedral form  $\{hkl\}$  of the hexakis-octahedron; it is bounded by twenty-four scalene triangles and is the general form of the class.

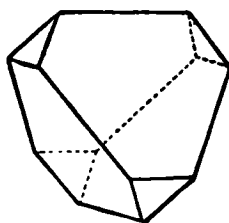

FIG. 30.—Combination of two Tetrahedra.

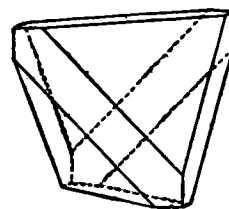

FIG. 31.—Combination of Tetrahedron and Cube.

Corresponding to each of these hemihedral forms there is another geometrically similar form, differing, however, not only in orientation, but also in actual crystals in the characters of the faces. Thus from the octahedron there may be derived two tetrahedra with the indices  $\{111\}$  and  $\{\bar{1}\bar{1}\bar{1}\}$ , which may be distinguished as positive and negative respectively. Fig. 30 shows a combination of

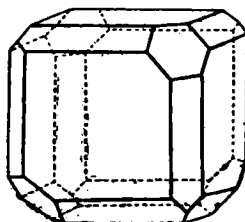

FIG. 32.—Combination of Tetrahedron, Cube and Rhombic Dodecahedron.

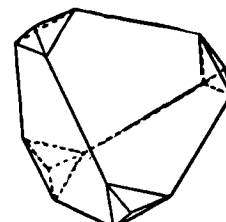

FIG. 33.—Combination of Tetrahedron and Rhombic Dodecahedron.

these two tetrahedra, and represents a crystal of blende, in which the four larger faces are dull and striated, whilst the four smaller are bright and smooth. Figs. 31-33 illustrate other tetrahedral combinations.

Tetrahedrite, blende, diamond, boracite and pharmacosiderite are substances which crystallize in this class.

PYRITOHEDRAL<sup>1</sup> CLASS

(Parallel-faced hemihedral; Dyakis-dodecahedron).

Crystals of this class possess three cubic planes of symmetry but no dodecahedral planes. There are only three dyad axes of symmetry, which coincide with the crystallographic axes; in addition there are three triad axes and a centre of symmetry.

Here the cube, octahedron, rhombic dodecahedron, triakis-octahedron and icositetrahedron are geometrically the same as in the first class. The characters of the faces will, however, be different; thus the cube faces will be striated parallel to one edge only (fig. 89),

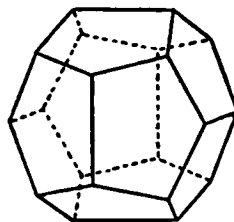

FIG. 34.—Pentagonal Dodecahedron.

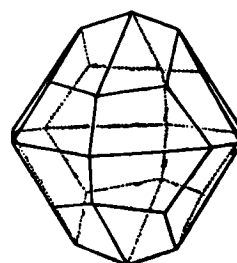

FIG. 35.—Dyakis-dodecahedron.

and triangular markings on the octahedron faces will be placed obliquely to the edges. The remaining simple forms are "hemihedral with parallel faces," and from the corresponding holohedral forms two hemihedral forms, a positive and a negative, may be derived.

Pentagonal dodecahedron (fig. 34). This is bounded by twelve pentagonal faces, but these are not regular pentagons, and the angles over the three sets of different edges are different. The regular dodecahedron of geometry, contained by twelve regular pentagons, is not a possible form in crystals. The indices are  $\{hko\}$ ; as a simple form  $\{210\}$  is of very common occurrence in pyrites.

Dyakis-dodecahedron (fig. 35). This is the hemihedral form of

<sup>1</sup> Named after pyrites, which crystallizes in a typical form of this class.



the hexakis-octahedron and has the indices  $\{hkl\}$ ; it is bounded by twenty-four faces. As a simple form  $\{321\}$  is met with in pyrites. Combinations (figs. 36-39) of these forms with the cube and the octahedron are common in pyrites. Fig. 37 resembles in general

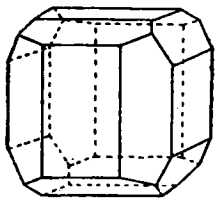

FIG. 36.—Combination of Pentagonal Dodecahedron and Cube.

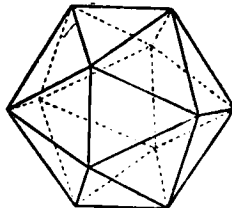

FIG. 37.—Combination of Pentagonal Dodecahedron and Octahedron.

appearance the regular icosahedron of geometry, but only eight of the faces are equilateral triangles. Cobaltite, smaltite and other sulphides and sulpharsenides of the pyrites group of minerals crystallize in these forms. The alums also belong to this class; from an aqueous solution they crystallize as simple octahedra,

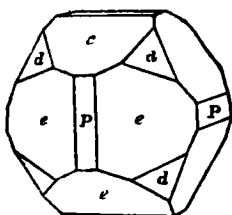

FIG. 38.—Combination of Pentagonal Dodecahedron, Cube and Octahedron.

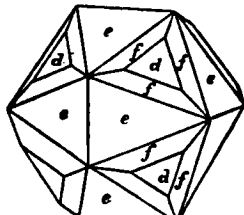

FIG. 39.—Combination of Pentagonal Dodecahedron  $e$   $\{210\}$ , Dyakis-dodecahedron  $f$   $\{321\}$ , and Octahedron  $d$   $\{111\}$ .

sometimes with subordinate faces of the cube and rhombic dodecahedron, but from an acid solution as octahedra combined with the pentagonal dodecahedron  $\{210\}$ .

PLAGIHEDRAL<sup>1</sup> CLASS

(Plagihedral-hemihedral; Pentagonal icositetrahedral; Gyroidal<sup>2</sup>).

In this class there are the full number of axes of symmetry (three tetrad, four triad and six dyad), but no planes of symmetry and no centre of symmetry.

Pentagonal icositetrahedron (fig. 40). This is the only simple form in this class which differs geometrically from those of the holosymmetric class. By suppressing either one or other set of alternate faces of the hexakis-octahedron two pentagonal icositetrahedra  $\{hkl\}$  and  $\{khl\}$  are derived. These are each bounded by twenty-four irregular

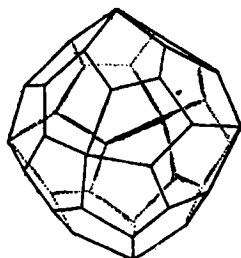

FIG. 40.—Pentagonal Icositetrahedron.

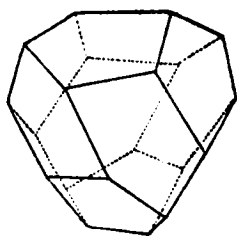

FIG. 41.—Tetrahedral Pentagonal Dodecahedron.

pentagons, and although similar to each other they are respectively right- and left-handed, one being the mirror image of the other; such similar but nonsuperposable forms are said to be enantiomorphous (*ἑπάρτιος*, opposite, and *μορφή*, form), and crystals showing such forms sometimes rotate the plane of polarization of plane-polarized light. Faces of a pentagonal icositetrahedron with high indices have been very rarely observed on crystals of cuprite, potassium chloride and ammonium chloride, but none of these are circular polarizing.

TETARTOHEDRAL CLASS

(Tetrahedral pentagonal dodecahedron).

Here, in addition to four polar triad axes, the only other elements of symmetry are three dyad axes, which coincide with the crystallo-

<sup>1</sup> From *πλάγιος*, placed sideways, referring to the absence of planes and centre of symmetry.

<sup>2</sup> From *γύρος*, a ring or spiral, and *εἶδος*, form.

graphic axes. Six of the simple forms, the cube, tetrahedron, rhombic dodecahedron, deltoid dodecahedron, triakis-tetrahedron and pentagonal dodecahedron, are geometrically the same in this class as in either the tetrahedral or pyritohedral classes. The general form is the

Tetrahedral pentagonal dodecahedron (fig. 41). This is bounded by twelve irregular pentagons, and is a tetartohedral or quarter-faced form of the hexakis-octahedron. Four such forms may be derived, the indices of which are  $\{hkl\}$ ,  $\{khl\}$ ,  $\{\bar{h}\bar{k}l\}$  and  $\{\bar{h}k\bar{l}\}$ ; the first pair are enantiomorphous with respect to one another, and so are the last pair. Barium nitrate, lead nitrate, sodium chlorate and sodium bromate crystallize in this class, as also do the minerals ullmannite (NiSbS) and langbeinite (K<sub>2</sub>Mg<sub>2</sub>(SO<sub>4</sub>)<sub>2</sub>).

2. TETRAGONAL SYSTEM

(Pyramidal; Quadratic; Dimetric).

In this system the three crystallographic axes are all at right angles, but while two are equal in length and interchangeable the third is of a different length. The unequal axis is spoken of as the principal axis or morphological axis of the crystal, and it is always placed in a vertical position; in five of the seven classes of this system it coincides with the single tetrad axis of symmetry.

The parameters are  $a : a : c$ , where  $a$  refers to the two equal hori-

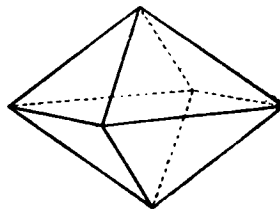

FIG. 42.

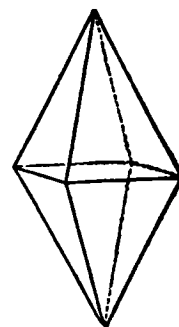

FIG. 43.

Tetragonal Bipyramids.

zontal axes, and  $c$  to the vertical axis;  $c$  may be either shorter (as in fig. 42) or longer (fig. 43) than  $a$ . The ratio  $a : c$  is spoken of as the axial ratio of a crystal, and it is dependent on the angles between the faces. In all crystals of the same substance this ratio is constant, and is characteristic of the substance; for other substances crystallizing in the tetragonal system it will be different. For example, in cassiterite it is given as  $a : c = 1 : 0.67232$  or simply as  $c = 0.67232$ ,  $a$  being unity; and in anatase as  $c = 1.7771$ .

HOLOSYMMETRIC CLASS

(Holohedral; Ditetragonal bipyramidal).

Crystals of this class are symmetrical with respect to five planes, which are of three kinds; one is perpendicular to the principal axis, and the other four intersect in it; of the latter, two are perpendicular to the equal crystallographic axes, while the two others bisect the angles between them. There are five axes of symmetry, one tetrad and two pairs of dyad, each perpendicular to a plane of symmetry. Finally, there is a centre of symmetry.

There are seven kinds of simple forms, viz.:-

Tetragonal bipyramid of the first order (figs. 42 and 43). This is bounded by eight equal isosceles triangles. Equal lengths are intercepted on the two horizontal axes, and the indices are  $\{111\}$ ,  $\{221\}$ ,  $\{112\}$ , &c., or in general  $\{hhl\}$ . The parametral plane with the intercepts  $a : a : c$  is a face of the bipyramid  $\{111\}$ .

Tetragonal bipyramid of the second order. This is also bounded by eight equal isosceles triangles, but differs from the last form in

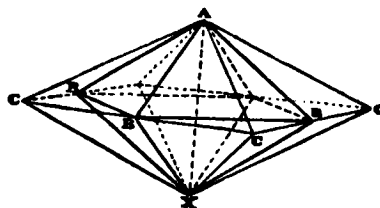

FIG. 44.

Tetragonal Bipyramids of the first and second orders.

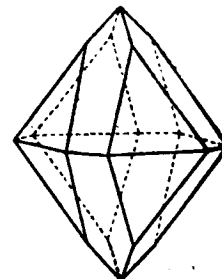

FIG. 45.

its position, four of the faces being parallel to each of the horizontal axes; the indices are therefore  $\{101\}$ ,  $\{201\}$ ,  $\{102\}$ , &c., or  $\{h0l\}$ .

Fig. 44 shows the relation between the tetragonal bipyramids

of the first and second orders when the indices are  $\{111\}$  and  $\{101\}$  respectively:  $ABB$  is the face  $\{111\}$ , and  $ACC$  is  $\{101\}$ . A combination of these two forms is shown in fig. 45.

Ditetragonal bipyramid (fig. 46). This is the general form; it is bounded by sixteen scalene triangles, and all the indices are unequal, being  $\{321\}$ , &c., or  $\{hkl\}$ .

Tetragonal prism of the first order. The four faces intersect the horizontal axes in equal lengths and are parallel to the principal axis; the indices are therefore  $\{110\}$ . This form does not enclose space, and is therefore called an "open form" to distinguish it from a "closed form" like the tetragonal bipyramids and all the forms of the cubic system. An open form can exist only in combination with other forms; thus fig. 47 is a combination of the tetragonal prism  $\{110\}$  with the basal pinacoid  $\{001\}$ . If the faces  $\{110\}$  and  $\{001\}$  are of equal size such a figure will be geometrically a cube, since all the angles are right angles; the variety of apophyllite known as tesselite crystallizes in this form.

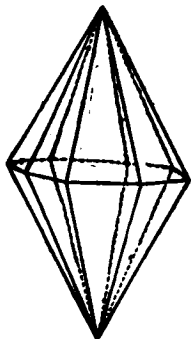

FIG. 46.—Ditetragonal Bipyramid.

Tetragonal prism of the second order. This has the same number of faces as the 1st prism, but differs in position; each face being parallel to the vertical axis and one of the horizontal axes; the indices are  $\{100\}$ .

Ditetragonal prism. This consists of eight faces all parallel to the principal axis and intercepting the horizontal axes in different lengths; the indices are  $\{210\}$ ,  $\{32\}$ , &c., or  $\{hko\}$ .

Basal pinacoid (from  $\pi\lambda\alpha\zeta$ , a tablet). This consists of a single pair of parallel faces perpendicular to the principal axis. It is therefore an open form and can exist only in combination (fig. 47).

Combinations of holohedral tetragonal forms are shown in figs. 47-49; fig. 48 is a combination of a pyramid of the first order with one of the second order and the prism of the first order; fig. 49 a

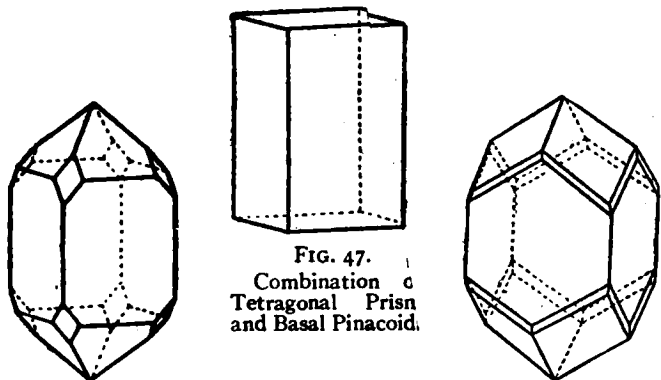

FIG. 48.

Combinations of Tetragonal Prisms and Pyramids.

combination of a bipyramid of the first order with a ditetragonal bipyramid and the prism of the second order. Compare also figs. 87 and 88.

Examples of substances which crystallize in this class are cassiterite, rutile, anatase, zircon, thorite, vesuvianite, apophyllite, phosgenite, also boron, tin, mercuric iodide.

SCALENOHEDRAL CLASS  
(Bisphenoidal-hemihedral)

Here there are only three dyad axes and two planes of symmetry, the former coinciding with the crystallographic axes and the latter bisecting the angles between the horizontal pair. The dyad axis of symmetry, which in this class coincides with the principal axis of the crystal, has certain of the characters of a tetrad axis, and is sometimes called a tetrad axis of "alternating symmetry"; a face on the upper half of the crystal if rotated through  $90^\circ$  about this axis and reflected across the equatorial plane falls into the position of a face on the lower half of the crystal. This kind of symmetry, with simultaneous rotation about an axis and reflection across a plane, is also called "composite symmetry."

In this class all except two of the simple forms are geometrically the same as in the holosymmetric class.

Bisphenoid ( $\sigma\phi\psi$ , a wedge) (fig. 50). This is a double wedge-shaped solid bounded by four equal isosceles triangles; it has the indices  $\{111\}$ ,  $\{211\}$ ,  $\{112\}$ , &c., or in general  $\{hkl\}$ . By suppressing either one or other set of alternate faces of the tetragonal bipyramid of the first order (fig. 42) two bisphenoids are derived, in the

same way that two tetrahedra are derived from the regular octahedron.

Tetragonal scalenohedron or ditetragonal bisphenoid (fig. 51). This is bounded by eight scalene triangles and has the indices  $\{hkl\}$ . It may be considered as the hemihedral form of the ditetragonal bipyramid.

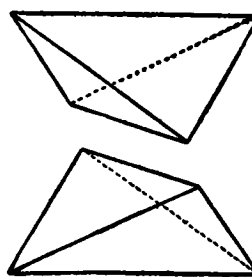

FIG. 50.—Tetragonal Bisphenoids.

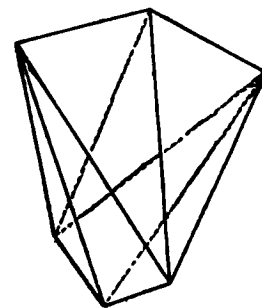

FIG. 51.—Tetragonal Scalenohedron.

The crystal of chalcopyrite ( $\text{CuFeS}_2$ ) represented in fig. 52 is a combination of two bisphenoids ( $P$  and  $P'$ ), two bipyramids of the second order ( $b$  and  $c$ ), and the basal pinacoid ( $a$ ). Stannite ( $\text{Cu}_3\text{FeSnS}_4$ ), acid potassium phosphate ( $\text{H}_2\text{KPO}_4$ ), mercuric cyanide, and urea ( $\text{CO}(\text{NH}_2)_2$ ) also crystallize in this class.

BIPYRAMIDAL CLASS  
(Parallel-faced hemihedral).

The elements of symmetry are a tetrad axis with a plane perpendicular to it, and a centre of symmetry. The simple forms are the same here as in the holosymmetric class, except the prism  $\{hko\}$ , which has only four faces, and the bipyramid  $\{hkl\}$ , which has eight faces and is distinguished as a "tetragonal pyramid of the third order."

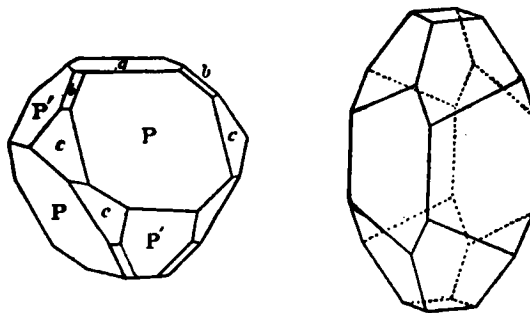

FIG. 52.—Crystal of Chalcopyrite. FIG. 53.—Crystal of Fergusonite.

Fig. 53 shows a combination of a tetragonal prism of the first order with a tetragonal bipyramid of the third order and the basal pinacoid, and represents a crystal of fergusonite. Scheelite ( $q.v.$ ), scapolite ( $q.v.$ ), and erythrite ( $\text{C}_4\text{H}_{10}\text{O}_4$ ) also crystallize in this class.

PYRAMIDAL CLASS  
(Hemimorphic-tetartohedral).

Here the only element of symmetry is the tetrad axis. The pyramids of the first  $\{hkl\}$ , second  $\{hol\}$  and third  $\{hkl\}$  orders have each only four faces at one or other end of the crystal, and are hemimorphic. All the simple forms are thus open forms.

Examples are wulfenite ( $\text{PbMoO}_4$ ) and barium antimonyl dextro-tartrate ( $\text{Ba}(\text{SbO})_2(\text{C}_4\text{H}_4\text{O}_6) \cdot \text{H}_2\text{O}$ ).

DITETRAGONAL PYRAMIDAL CLASS  
(Hemimorphic-hemihedral).

Here there are two pairs of vertical planes of symmetry intersecting in the tetrad axis. The pyramids  $\{hkl\}$  and  $\{hol\}$  and the bipyramid  $\{hkl\}$  are all hemimorphic.

Examples are iodosuccinimide ( $\text{C}_4\text{H}_4\text{O}_2\text{NI}$ ), silver fluoride ( $\text{AgF} \cdot \text{H}_2\text{O}$ ), and penta-erythrite ( $\text{C}_4\text{H}_{12}\text{O}_4$ ). No examples are known amongst minerals.

TRAPEZOHEDRAL CLASS  
(Trapezohedral-hemihedral).

Here there are the full number of axes of symmetry, but no planes or centre of symmetry. The general form  $\{hkl\}$  is bounded by eight trapezoidal faces and is the tetragonal trapezohedron.

Examples are nickel sulphate ( $\text{NiSO}_4 \cdot 6\text{H}_2\text{O}$ ), guanidine carbonate ( $(\text{CH}_2\text{N}_2)_2\text{H}_2\text{CO}_3$ ), strychnine sulphate ( $(\text{C}_{21}\text{H}_{22}\text{N}_2\text{O}_2)_2 \cdot \text{H}_2\text{SO}_4 \cdot 6\text{H}_2\text{O}$ ).

**BISPHENOIDAL CLASS**  
(Bisphenoidal-tetartohedral).

Here there is only a single dyad axis of symmetry, which coincides with the principal axis. All the forms, except the prisms and basal pinacoid, are sphenoids. Crystals possessing this type of symmetry have not yet been observed.

**3. ORTHORHOMBIC SYSTEM**  
(Rhombic; Prismatic; Trimetric).

In this system the three crystallographic axes are all at right angles, but they are of different lengths and not interchangeable. The parameters, or axial ratios, are  $a : b : c$ , these referring to the axes  $OX, OY$  and  $OZ$  respectively. The choice of a vertical axis,  $OZ = c$ , is arbitrary, and it is customary to place the longer of the two horizontal axes from left to right ( $OY = b$ ) and take it as unity: this is called the "macro-axis" or "macro-diagonal" (from  $\mu\alpha\kappa\rho\varsigma$ , long), whilst the shorter horizontal axis ( $OX = a$ ) is called the "brachy-axis" or "brachy-diagonal" (from  $\beta\rho\alpha\chi\varsigma$ , short). The axial ratios are constant for crystals of any one substance and are characteristic of it; for example, in barytes ( $\text{BaSO}_4$ ),  $a : b : c = 0.8152 : 1 : 1.3136$ ; in anglesite ( $\text{PbSO}_4$ ),  $a : b : c = 0.7852 : 1 : 1.2894$ ; in cerussite ( $\text{PbCO}_3$ ),  $a : b : c = 0.6100 : 1 : 0.7230$ .

There are three symmetry-classes in this system:—

**HOLOHEDRAL CLASS**  
(Holohebral; Bipyramidal).

Here there are three dissimilar dyad axes of symmetry, each coinciding with a crystallographic axis; perpendicular to them are three dissimilar planes of symmetry; there is also a centre of symmetry. There are seven kinds of simple forms:—

Bipyramid (figs. 54 and 55). This is the general form and is bounded by eight scalene triangles; the indices are  $\{111\}, \{211\},$

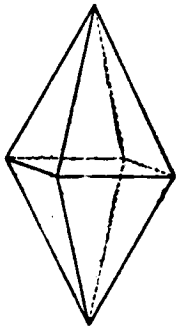

FIG. 54.

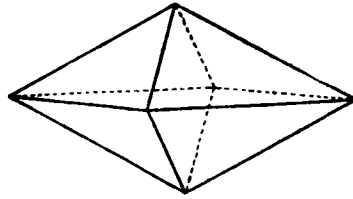

FIG. 55.

Orthorhombic Bipyramids.

$\{221\}, \{112\}, \{321\}, \{123\},$  &c., or in general  $\{hkl\}$ . The crystallographic axes join opposite corners of these pyramids and in the fundamental bipyramid  $\{111\}$  the parametral plane has the intercepts  $a : b : c$ . This is the only closed form in this class; the others are open forms and can exist only in combination. Sulphur often crystallizes in simple bipyramids.

Prism. This consists of four faces parallel to the vertical axis and intercepting the horizontal axes in the lengths  $a$  and  $b$  or in any multiples of these; the indices are therefore  $\{110\}, \{210\}, \{120\}$  or  $\{hko\}$ .

Macro-prism. This consists of four faces parallel to the macro-

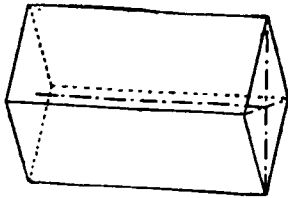

FIG. 56.—Macro-prism and Brachy-pinacoid.

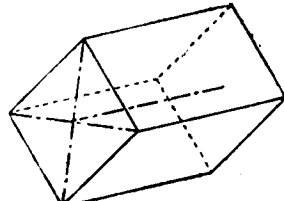

FIG. 57.—Brachy-prism and Macro-pinacoid.

axis, and has the indices  $\{101\}, \{201\} \dots$  or  $\{h0l\}$ .

Brachy-prism. This consists of four faces parallel to the brachy-axis, and has the indices  $\{011\}, \{021\} \dots$  or  $\{0kl\}$ . The macro- and brachy-prisms are often called "domes."

Basal pinacoid, consisting of a pair of parallel faces perpendicular to the vertical axis; the indices are  $\{001\}$ . The macro-pinacoid

$\{100\}$  and the brachy-pinacoid  $\{010\}$  each consist of a pair of parallel faces respectively parallel to the macro- and the brachy-axis.

Figs. 56-58 show combinations of these six open forms, and fig. 59 a combination of the macro-pinacoid ( $a$ ), brachy-pinacoid ( $b$ ), a prism ( $m$ ), a macro-prism ( $d$ ), a brachy-prism ( $k$ ), and a bipyramid ( $n$ ).

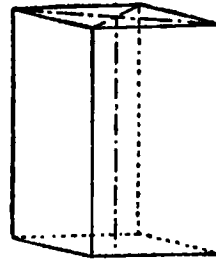

FIG. 58.—Prism and Basal Pinacoid.

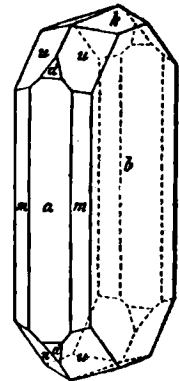

FIG. 59.—Crystal of Hypersthene.

Holohebral Orthorhombic Combinations.

Examples of substances crystallizing in this class are extremely numerous; amongst minerals are sulphur, stibnite, cerussite, chrysoberyl, topaz, olivine, nitre, barytes, columbite and many others; and amongst artificial products iodine, potassium permanganate, potassium sulphate, benzene, barium formate, &c.

**PYRAMIDAL CLASS**  
(Hemimorphic).

Here there is only one dyad axis in which two planes of symmetry intersect. The crystals are usually so placed that the dyad axis coincides with the vertical crystallographic axis, and the planes of symmetry are also vertical.

The pyramid  $\{hkl\}$  has only four faces at one end or other of the crystal. The macro-prism and the brachy-prism of the last class are here represented by the macro-dome and brachy-dome respectively, so called because of the resemblance of the pair of equally sloped faces to the roof of a house. The form  $\{001\}$  is a single plane at the top of the crystal, and is called a "pedion"; the parallel pedion  $\{00\bar{1}\}$ , if present at the lower end of the crystal, constitutes a different form. The prisms  $\{hko\}$  and the macro- and brachy-pinacoids are geometrically the same in this class as in the last. Crystals of this class are therefore differently developed at the two ends and are said to be "hemimorphic."

Fig. 60 shows a crystal of the mineral hemimorphite ( $\text{H}_2\text{Zn}_2\text{SiO}_4$ ) which is a combination of the brachy-pinacoid  $\{010\}$  and a prism,

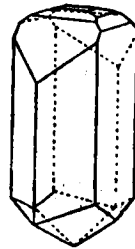

FIG. 60.—Crystal of Hemimorphite.

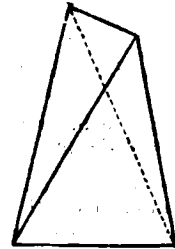

FIG. 61.—Orthorhombic Bisphenoid.

with the pedion  $\{001\}$ , two brachy-domes and two macro-domes at the upper end, and a pyramid at the lower end. Examples of other substances belonging to this class are struvite ( $\text{NH}_4\text{MgPO}_4 \cdot 6\text{H}_2\text{O}$ ), bertrandite ( $\text{H}_2\text{Be}_2\text{Si}_2\text{O}_9$ ), resorcin, and picric acid.

**BISPHENOIDAL CLASS**  
(Hemihedral).

Here there are three dyad axes, but no planes of symmetry and no centre of symmetry. The general form  $\{hkl\}$  is a bisphenoid (fig. 61) bounded by four scalene triangles. The other simple forms are geometrically the same as in the holosymmetric class.

Examples: epsomite (Epsom salts,  $\text{MgSO}_4 \cdot 7\text{H}_2\text{O}$ ), goslarite ( $\text{ZnSO}_4 \cdot 7\text{H}_2\text{O}$ ), silver nitrate, sodium potassium dextro-tartrate (seignette salt,  $\text{NaKC}_4\text{H}_4\text{O}_6 \cdot 4\text{H}_2\text{O}$ ), potassium antimonyl dextro-tartrate (tartar-emetic,  $\text{K}(\text{SbO})\text{C}_4\text{H}_4\text{O}_6$ ), and asparagine ( $\text{C}_4\text{H}_8\text{N}_2\text{O}_2 \cdot \text{H}_2\text{O}$ ).

4. MONOCLINIC SYSTEM

(Oblique; Monosymmetric).

In this system two of the angles between the crystallographic axes are right angles, but the third angle is oblique, and the axes are of unequal lengths. The axis which is perpendicular to the other two is taken as  $OY = b$  (fig. 62) and is called the ortho-axis or ortho-diagonal. The choice of the other two axes is arbitrary; the vertical axis ( $OZ = c$ ) is usually taken parallel to the edges of a prominently developed prismatic zone, and the clino-axis or clino-diagonal ( $OX = a$ ) parallel to the zone-axis of some other prominent zone on the crystal. The acute angle between the axes  $OX$  and  $OZ$  is usually denoted as  $\beta$ , and it is necessary to know its magnitude, in addition to the axial ratios  $a : b : c$ , before the crystal is completely determined. As in other systems, except the cubic, these elements,  $a : b : c$  and  $\beta$ , are characteristic of the substance. Thus for gypsum  $a : b : c = 0.6899 : 1 : 0.4124$ ;  $\beta = 80^\circ 42'$ ; for orthoclase  $a : b : c = 0.6585 : 1 : 0.5554$ ;  $\beta = 63^\circ 57'$ ; and for cane-sugar  $a : b : c = 1.2595 : 1 : 0.8782$ ;  $\beta = 76^\circ 30'$ .

HOLOSYMMETRIC CLASS

(Holohedral; Prismatic).

Here there is a single plane of symmetry perpendicular to which is a dyad axis; there is also a centre of symmetry. The dyad axis coincides with the ortho-axis  $OY$ , and the vertical axis  $OZ$  and the clino-axis  $OX$  lie in the plane of symmetry.

All the forms are open, being either pinacoids or prisms; the former consisting of a pair of parallel faces, and the latter of four faces intersecting in parallel edges and with a rhombic cross-section. The pair of faces parallel to the plane of symmetry is distinguished as the "clino-pinacoid" and has the indices  $\{010\}$ . The other pinacoids are all perpendicular to the plane of symmetry (and parallel to the ortho-axis); the one parallel to the vertical axis is called the "ortho-pinacoid"  $\{100\}$ , whilst that parallel to the clino-axis is the "basal pinacoid"  $\{001\}$ ; pinacoids not parallel to the arbitrarily chosen clino- and vertical axes may have the indices  $\{101\}$ ,  $\{201\}$ ,  $\{102\}$  . . .  $\{h0l\}$  or  $\{101\}$ ,  $\{201\}$ ,  $\{102\}$  . . .  $\{h0l\}$ , according to whether they lie in the obtuse or the acute axial angle. Of the prisms, those with edges (zone-axis) parallel to the clino-axis, and having indices  $\{011\}$ ,  $\{021\}$ ,  $\{012\}$  . . .  $\{0kl\}$ , are called "clino-prisms"; those with edges parallel to the vertical axis, and with the indices  $\{110\}$ ,  $\{210\}$ ,  $\{120\}$  . . .  $\{hko\}$ , are called simply "prisms." Prisms with edges parallel to neither of the axes  $OX$  and  $OY$  have the indices  $\{111\}$ ,  $\{221\}$ ,  $\{211\}$ ,  $\{321\}$  . . .  $\{hkl\}$  or  $\{111\}$  . . .  $\{hkl\}$ .

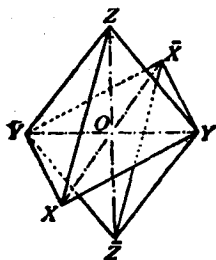

FIG. 62.—Monoclinic Axes and Hemi-pyramid.

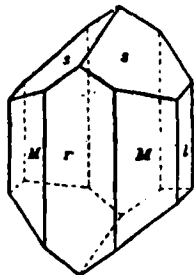

FIG. 63.—Crystal of Augite.

and are usually called "hemi-pyramids" (fig. 62); they are distinguished as negative or positive according to whether they lie in the obtuse or the acute axial angle  $\beta$ .

Fig. 63 represents a crystal of augite bounded by the clino-pinacoid ( $s$ ), the ortho-pinacoid ( $r$ ), a prism ( $M$ ), and a hemi-pyramid ( $s$ ).

The substances which crystallize in this class are extremely numerous: amongst minerals are gypsum, orthoclase, the amphiboles, pyroxenes and micas, epidote, monazite, realgar, borax, mirabilite ( $\text{Na}_2\text{SO}_4 \cdot 10\text{H}_2\text{O}$ ), melanterite ( $\text{FeSO}_4 \cdot 7\text{H}_2\text{O}$ ) and many others; amongst artificial products are monoclinic sulphur, barium chloride ( $\text{BaCl}_2 \cdot 2\text{H}_2\text{O}$ ), potassium chlorate, potassium ferrocyanide ( $\text{K}_4\text{Fe}(\text{CN})_6 \cdot 3\text{H}_2\text{O}$ ), oxalic acid ( $\text{C}_2\text{O}_4\text{H}_2 \cdot 2\text{H}_2\text{O}$ ), sodium acetate ( $\text{NaC}_2\text{H}_3\text{O}_2 \cdot 3\text{H}_2\text{O}$ ) and naphthalene.

HEMIMORPHIC CLASS

(Sphenoidal).

In this class the only element of symmetry is a single dyad axis, which is polar in character, being dissimilar at the two ends.

The form  $\{010\}$  perpendicular to the axis of symmetry consists of a single plane or pedion; the parallel face is dissimilar in character and belongs to the pedion  $\{0\bar{1}0\}$ . The pinacoids  $\{100\}$ ,  $\{001\}$ ,  $\{h0l\}$  and  $\{k0l\}$  parallel to the axis of symmetry are geometrically the

<sup>1</sup> From  $\mu\acute{\nu}\rho\omicron\varsigma$ , single, and  $\kappa\lambda\nu\epsilon\upsilon$ , to incline, since one axis is inclined to the plane of the other two axes, which are at right angles.

same in this class as in the holosymmetric class. The remaining forms consist each of only two planes on the same side of the axial plane  $XOZ$  and equally inclined to the dyad axis (e.g. in fig. 62 the two planes  $XYZ$  and  $\bar{X}\bar{Y}\bar{Z}$ ); such a wedge-shaped form is sometimes called a sphenoid.

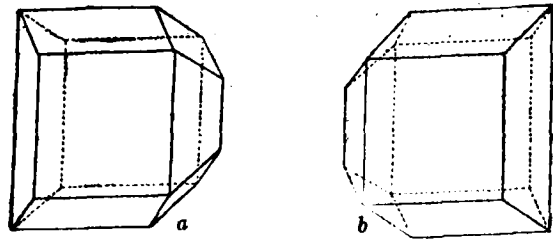

FIG. 64.—Enantiomorphous Crystals of Tartaric Acid.

Fig. 64 shows two crystals of tartaric acid,  $a$  a right-handed crystal of dextro-tartaric acid, and  $b$  a left-handed crystal of laevo-tartaric acid. The two crystals are enantiomorphous, i.e. although they have the same interfacial angles they are not superposable, one being the mirror image of the other. Other examples are potassium dextro-tartrate, cane-sugar, milk-sugar, quercite, lithium sulphate ( $\text{Li}_2\text{SO}_4 \cdot \text{H}_2\text{O}$ ); amongst minerals the only example is the hydrocarbon fichtelite ( $\text{C}_5\text{H}_8$ ).

CLINOHEDRAL CLASS

(Hemihedral; Domatic).

Crystals of this class are symmetrical only with respect to a single plane. The only form which is here geometrically the same as in the holosymmetric class is the clino-pinacoid  $\{010\}$ . The forms perpendicular to the plane of symmetry are all pedions, consisting of single planes with the indices  $\{100\}$ ,  $\{100\}$ ,  $\{001\}$ ,  $\{001\}$ ,  $\{h0l\}$ , &c. The remaining forms,  $\{hko\}$ ,  $\{okl\}$  and  $\{hkl\}$ , are domes or "gonioids" ( $\gamma\omega\upsilon\lambda\alpha$ , an angle, and  $\epsilon\lambda\delta\omicron\varsigma$ , form), consisting of two planes equally inclined to the plane of symmetry.

Examples are potassium tetrathionate ( $\text{K}_2\text{S}_4\text{O}_{11}$ ), hydrogen trisodium hypophosphate ( $\text{HNa}_3\text{P}_2\text{O}_6 \cdot 9\text{H}_2\text{O}$ ); and amongst minerals, clinohedrite ( $\text{H}_2\text{ZnCaSiO}_4$ ) and scolecite.

5. ANORTHIC SYSTEM

(Triclinic).

In the anorthic (from  $\acute{\alpha}\nu$ , privative, and  $\delta\omicron\phi\theta\epsilon\iota\varsigma$ , right) or triclinic system none of the three crystallographic axes are at right angles, and they are all of unequal lengths. In addition to the parameters  $a : b : c$ , it is necessary to know the angles,  $\alpha$ ,  $\beta$ , and  $\gamma$ , between the axes. In anorthite, for example, these elements are  $a : b : c = 0.6347 : 1 : 0.5501$ ;  $\alpha = 93^\circ 13'$ ,  $\beta = 115^\circ 55'$ ,  $\gamma = 91^\circ 12'$ .

HOLOSYMMETRIC CLASS

(Holohedral; Pinacoidal).

Here there is only a centre of symmetry. All the forms are pinacoids, each consisting of only two parallel faces. The indices of the three pinacoids parallel to the axial planes are  $\{100\}$ ,  $\{010\}$  and  $\{001\}$ ; those of pinacoids parallel to only one axis are  $\{hko\}$ ,  $\{hol\}$  and  $\{okl\}$ ; and the general form is  $\{hkl\}$ .

Several minerals crystallize in this class; for example, the plagioclastic feldspars, microcline, axinite (fig. 65), cyanite, amblygonite, chalcantite ( $\text{CuSO}_4 \cdot 5\text{H}_2\text{O}$ ), sassolite ( $\text{H}_2\text{BO}_3$ ); among artificial substances are potassium bichromate, racemic acid ( $\text{C}_6\text{H}_8\text{O}_6 \cdot 2\text{H}_2\text{O}$ ), dibrom-para-nitrophenol, &c.

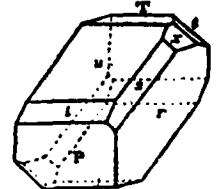

FIG. 65.—Crystal of Axinite.

ASYMMETRIC CLASS

(Hemihedral, Pedial).

Crystals of this class are devoid of any elements of symmetry. All the forms are pedions, each consisting of a single plane; they are thus hemihedral with respect to crystals of the last class. Although there is a total absence of symmetry, yet the faces are arranged in zones on the crystals.

Examples are calcium thiosulphate ( $\text{CaS}_2\text{O}_3 \cdot 6\text{H}_2\text{O}$ ) and hydrogen strontium dextro-tartrate ( $(\text{C}_4\text{H}_4\text{O}_6\text{H})_2\text{Sr} \cdot 5\text{H}_2\text{O}$ ); there is no example amongst minerals.

6. HEXAGONAL SYSTEM

Crystals of this system are characterized by the presence of a single axis of either triad or hexad symmetry, which is spoken of as the "principal" or "morphological" axis. Those with a triad axis are grouped together in the rhombohedral or trigonal division, and those with a hexad axis in the hexagonal division. By some authors these two divisions are treated as separate systems; or again the rhombohedral forms may be considered as hemihedral developments

of the hexagonal. On the other hand, hexagonal forms may be considered as a combination of two rhombohedral forms.

Owing to the peculiarities of symmetry associated with a single triad or hexad axis, the crystallographic axes of reference are different in this system from those used in the five other systems of crystals. Two methods of axial representation are in common use; rhombohedral axes being usually used for crystals of the rhombohedral division, and hexagonal axes for those of the hexagonal division; though sometimes either one or the other set is employed in both divisions.

Rhombohedral axes are taken parallel to the three sets of edges of a rhombohedron (fig. 66). They are inclined to one another at equal oblique angles, and they are all equally inclined to the principal axis; further, they are all of equal length and are interchangeable. With such a set of axes there can be no statement of an axial ratio, but the angle between the axes (or some other angle which may be calculated from this) may be given as a constant of the substance. Thus in calcite the rhombohedral angle (the angle between two faces of the fundamental rhombohedron) is  $74^\circ 55'$ , or the angle between the normal to a face of this rhombohedron and the principal axis is  $44^\circ 36\frac{1}{2}'$ .

Hexagonal axes are four in number, viz. a vertical axis coinciding with the principal axis of the crystal, and three horizontal axes inclined to one another at  $60^\circ$  in a plane perpendicular to the principal axis. The three horizontal axes, which are taken either parallel or perpendicular to the faces of a hexagonal prism (fig. 71) or the edge of a hexagonal bipyramid (fig. 70), are equal in length ( $a$ ) but the vertical axis is of a different length ( $c$ ). The indices of planes referred to such a set of axes are four in number; they are written as  $\{hkl\}$ , the first three ( $h+i+k=0$ ) referring to the horizontal axes and the last to the vertical axis. The ratio  $a : c$  of the parameters, or the axial ratio, is characteristic of all the crystals of the same substance. Thus for beryl (including emerald)  $a : c = 1 : 0.4989$  (often written  $c = 0.4989$ ); for zinc  $c = 1.3564$ .

**Rhombohedral Division.**

In the rhombohedral or trigonal division of the hexagonal system there are seven symmetry-classes, all of which possess a single triad axis of symmetry.

**HOLOSYMMETRIC CLASS**

(Holoedral; Ditrigonal scalenohedral).

In this class, which presents the commonest type of symmetry of the hexagonal system, the triad axis is associated with three similar planes of symmetry inclined to one another at  $60^\circ$  and inter-

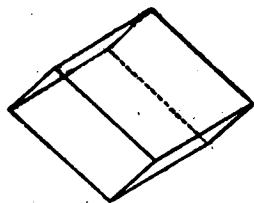

FIG. 66.

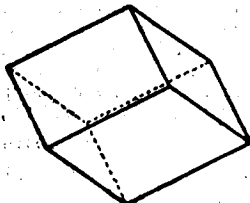

FIG. 67.

Direct and Inverse Rhombohedra.

secting in the triad axis; there are also three similar dyad axes, each perpendicular to a plane of symmetry, and a centre of symmetry. The seven simple forms are:—

Rhombohedral (figs. 66 and 67), consisting of six rhomb-shaped faces with the edges all of equal lengths: the faces are perpendicular to the planes of symmetry. There are two sets of rhombohedra, distinguished respectively as direct and inverse; those of one set (fig. 66) are brought into the orientation of the other set (fig. 67) by a rotation of  $60^\circ$  or  $180^\circ$  about the principal axis. For the fundamental rhombohedron, parallel to the edges of which are the crystallographic axes of reference, the indices are  $\{100\}$ . Other rhombohedra may have the indices  $\{211\}$ ,  $\{411\}$ ,  $\{110\}$ ,  $\{221\}$ ,  $\{111\}$ , &c., or in general  $\{hkk\}$ . (Compare fig. 72; for figures of other rhombohedra see CALCITE.)

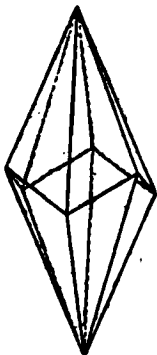

FIG. 68.—Scalenohedron.

Scalenohedron (fig. 68), bounded by twelve scalene triangles, and with the general indices  $\{hkl\}$ . The zig-zag lateral edges coincide with the similar edges of a rhombohedron, as shown in fig. 69; if the indices of the inscribed rhombohedron be  $\{100\}$ , the indices of the scalenohedron represented in the figure are  $\{201\}$ . The scalenohedron  $\{201\}$  is a characteristic form of calcite, which for this reason is sometimes called "dog-tooth-spar." The angles over the three edges of

a face of a scalenohedron are all different; the angles over three alternate polar edges are more obtuse than over the other three polar edges. Like the two sets of rhombohedra, there are also direct and inverse scalenohedra, which may be similar in form and angles, but different in orientation and indices.

Hexagonal bipyramid (fig. 70), bounded by twelve isosceles triangles each of which are equally inclined to two planes of symmetry. The indices are  $\{210\}$ ,  $\{41\bar{2}\}$ , &c., or in general  $\{hkl\}$ , where  $h-2k+l=0$ .

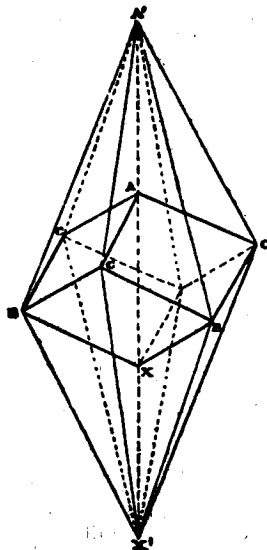

FIG. 69.—Scalenohedron with inscribed Rhombohedron.

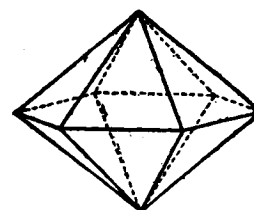

FIG. 70.—Hexagonal Bipyramid.

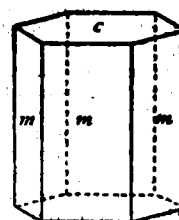

FIG. 71.—Hexagonal Prism and Basal Pinacoid.

Hexagonal prism of the first order ( $211$ ), consisting of six faces parallel to the principal axis and perpendicular to the planes of symmetry; the angles between (the normals to) the faces are  $60^\circ$ .

Hexagonal prism of the second order ( $101$ ), consisting of six faces parallel to the principal axis and parallel to the planes of symmetry. The faces of this prism are inclined to  $30^\circ$  to those of the last prism.

Dihexagonal prism, consisting of twelve faces parallel to the principal axis and inclined to the planes of symmetry. There are two sets of angles between the faces. The indices are  $\{3\bar{2}1\}$ ,  $\{5\bar{3}\bar{2}\}$ , &c., or in general  $\{hkl\}$ , where  $h+k+l=0$ .

Basal pinacoid ( $111$ ), consisting of a pair of parallel faces perpendicular to the principal axis.

Fig. 71 shows a combination of a hexagonal prism ( $m$ ) with the basal pinacoid ( $c$ ). For figures of other combinations see CALCITE

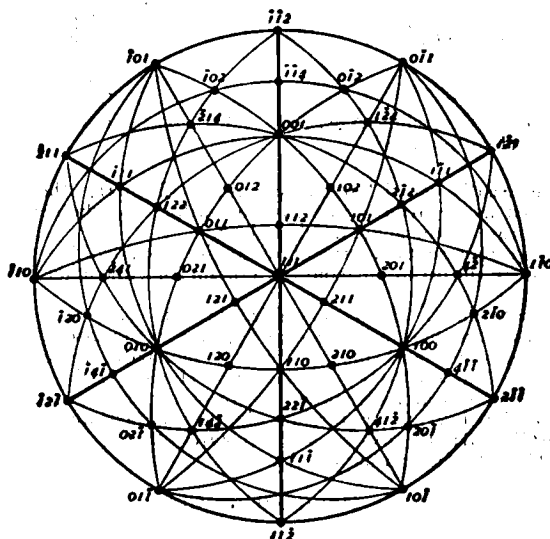

FIG. 72.—Stereographic Projection of a Holosymmetric Rhombohedral Crystal.

and CORUNDUM. The relation between rhombohedral forms and their indices are best studied with the aid of a stereographic projection (fig. 72); in this figure the thicker lines are the projections of the three planes of symmetry, and on these lie the poles of the rhombohedra (six of which are indicated).

Numerous substances, both natural and artificial, crystallize



in this class; for example, calcite, chalybite, calamine, corundum (ruby and sapphire), haematite, chabazite; the elements arsenic, antimony, bismuth, selenium, tellurium and perhaps graphite; also ice, sodium nitrate, thymol, &c.

**DITRIGONAL PYRAMIDAL CLASS**  
(Hemimorphic-hemihedral).

Here there are three similar planes of symmetry intersecting in the triad axis; there are no dyad axes and no centre of symmetry. The triad axis is uniterminal and polar, and the crystals are differently developed at the two ends; crystals of this class are therefore pyro-electric. The forms are all open forms:—

Trigonal pyramid  $\{hkk\}$ , consisting of three faces which correspond to the three upper or the three lower faces of a rhombohedron of the holosymmetric class.

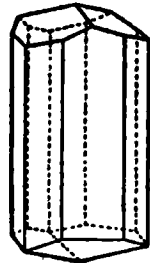

FIG. 73.—Crystal of Tourmaline.

Ditrigonal pyramid  $\{hkl\}$ , of six faces, corresponding to the six upper or lower faces of the scalenohedron.

Hexagonal pyramid  $\{hkl\}$  (where  $h-2k+l=0$ ), of six faces, corresponding to the six upper or lower faces of the hexagonal bipyramid.

Trigonal prism  $\{211\}$  or  $\{311\}$ , two forms each consisting of three faces parallel to principal axis and perpendicular to the planes of symmetry.

Hexagonal prism  $\{101\}$ , which is geometrically the same as in the last class.

Ditrigonal prism  $\{hkl\}$  (where  $h+k+l=0$ ), of six faces parallel to the principal axis, and with two sets of angles between them.

Basal pedion  $\{111\}$  or  $\{11\bar{1}\}$ , each consisting of a single plane perpendicular to the principal axis.

Fig. 73 represents a crystal of tourmaline with the trigonal prism  $\{211\}$ , hexagonal prism  $\{101\}$ , and a trigonal pyramid at each end. Other substances crystallizing in this class are pyrrargyrite, proustite, iodyrite (AgI), greenockite, zincite, spangolite, sodium lithium sulphate, tolylphenylketone.

**TRAPEZOHEDRAL CLASS**  
(Trapezohedral-hemihedral).

Here there are three similar dyad axes inclined to one another at  $60^\circ$  and perpendicular to the triad axis. There are no planes or centre of symmetry. The dyad axes are uniterminal, and are pyro-electric axes. Crystals of most substances of this class rotate the plane of polarization of a beam of light.

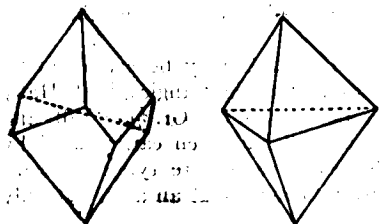

FIG. 74.—Trigonal Trapezohedron.

FIG. 75.—Trigonal Bipyramid.

In this class the rhombohedra  $\{hkk\}$ , the hexagonal prism  $\{211\}$ , and the basal pinacoid  $\{111\}$  are geometrically the same as in the holosymmetric class; the trigonal prism  $\{101\}$  and the ditrigonal prisms are as in the ditrigonal pyramidal class. The remaining simple forms are:—

Trigonal trapezohedron (fig. 74), bounded by six trapezoidal faces. There are two complementary and enantiomorphous trapezohedra,  $\{hkl\}$  and  $\{h\bar{k}l\}$ , derivable from the scalenohedron.

Trigonal bipyramid (fig. 75), bounded by six isosceles triangles; the indices are  $\{hkl\}$ , where  $h-2k+l=0$ , as in the hexagonal bipyramid.

The only minerals crystallizing in this class are quartz (*q.v.*) and cinnabar, both of which rotate the plane of a beam of polarized light transmitted along the triad axis. Other examples are dithionates of lead ( $\text{PbS}_2\text{O}_6 \cdot 4\text{H}_2\text{O}$ ), calcium and strontium, and of potassium ( $\text{K}_2\text{S}_2\text{O}_6$ ), benzil, matico-stearoptene.

**RHOMBOHEDRAL CLASS**  
(Parallel-faced hemihedral).

The only elements of symmetry are the triad axis and a centre of symmetry. The general form  $\{hkl\}$  is a rhombohedron, and is a hemihedral form, with parallel faces, of the scalenohedron. The form  $\{hkl\}$ , where  $h-2k+l=0$ , is also a rhombohedron, being the hemihedral form of the hexagonal bipyramid. The dihexagonal prism  $\{hkl\}$  of the holosymmetric class becomes here a hexagonal prism. The rhombohedra  $\{hkk\}$ , hexagonal prisms  $\{211\}$  and  $\{101\}$ , and the basal pinacoid  $\{111\}$  are geometrically the same in this class as in the holosymmetric class.

Fig. 76 represents a crystal of diopside with the fundamental rhombohedron  $r\{100\}$  and the hexagonal prism of the second order  $m\{101\}$  combined with the rhombohedron  $s\{031\}$ .

Examples of minerals which crystallize in this class are phenacite,

diopside, willemite, dolomite, ilmenite and pyrophanite; amongst artificial substances is ammonium periodate  $((\text{NH}_4)_2\text{I}_2\text{O}_7 \cdot 3\text{H}_2\text{O})$ .

**TRIGONAL PYRAMIDAL CLASS**  
(Hemimorphic-tetartohedral).

Here there is only the triad axis of symmetry, which is uniterminal. The general form  $\{hkl\}$  is a trigonal pyramid consisting of three faces at one end of the crystal. All other forms, in which the faces are neither parallel nor perpendicular to the triad axis, are trigonal pyramids. All the prisms are trigonal prisms; and perpendicular to these are two pedions.

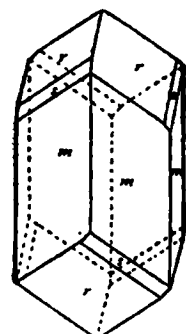

FIG. 76.—Crystal of Diopside.

The only substance known to crystallize in this class is sodium periodate ( $\text{NaIO}_4 \cdot 3\text{H}_2\text{O}$ ), the crystals of which are circularly polarizing.

**TRIGONAL BIPYRAMIDAL CLASS**

Here there is a plane of symmetry perpendicular to the triad axis. The trigonal pyramids of the last class are here trigonal bipyramids (fig. 75); the prisms are all trigonal prisms, and parallel to the plane of symmetry is the basal pinacoid. No example is known for this class.

**DITRIGONAL BIPYRAMIDAL CLASS**

Here there are three similar planes of symmetry intersecting in the triad axis, and perpendicular to them is a fourth plane of symmetry; at the intersection of the three vertical planes with the horizontal plane are three similar dyad axes; there is no centre of symmetry.

The general form is bounded by twelve scalene triangles and is a ditrigonal bipyramid. Like the general form of the last class, this has two sets of indices  $\{hkl, pqr\}$ ,  $\{hkl\}$  for faces above the equatorial plane of symmetry and  $\{pqr\}$  for faces below: with hexagonal axes there would be only one set of indices. The hexagonal bipyramids, the hexagonal prism  $\{101\}$  and the basal pinacoid  $\{111\}$  are geometrically the same in this class as in the holosymmetric class. The trigonal prism  $\{211\}$  and ditrigonal prisms  $\{hkl\}$  are the same as in the ditrigonal pyramidal class.

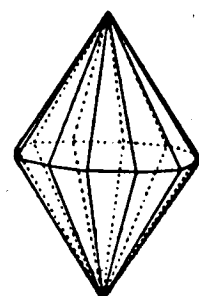

FIG. 77.—Dihexagonal Bipyramid.

The only representative of this type of symmetry is the mineral benitoite (*q.v.*).

**Hexagonal Division.**

In crystals of this division of the hexagonal system the principal axis is a hexad axis of symmetry. Hexagonal axes of reference are used: if rhombohedral axes be used many of the simple forms will have two sets of indices.

**HOLOSYMMETRIC CLASS**

(Holo-hedral; Dihexagonal bipyramidal).

Intersecting in the hexad axis are six planes of symmetry of two kinds, and perpendicular to them is an equatorial plane of symmetry. Perpendicular to the hexad axis are six dyad axes of two kinds and each perpendicular to a vertical plane of symmetry. The seven simple forms are:—

Dihexagonal bipyramid, bounded by twenty-four scalene triangles (fig. 77; *v* in fig. 80). The indices are  $\{21\bar{3}1\}$ , &c., or in general  $\{hkl\}$ . This form may be considered as a combination of two scalenohedra, a direct and an inverse.

Hexagonal bipyramid of the first order, bounded by twelve

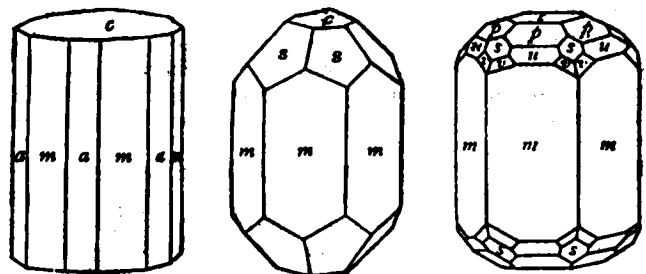

FIG. 78. FIG. 79. FIG. 80.

Combinations of Hexagonal forms.

isosceles triangles (fig. 70; *p* and *u* in fig. 80); indices  $\{1011\}$ ,  $\{2021\}$  . . . (*hohl*). The hexagonal bipyramid so common in quartz is geometrically similar to this form, but it really is a combination of two rhombohedra, a direct and an inverse, the faces of which differ in surface characters and often also in size.

Hexagonal bipyramid of the second order, bounded by twelve faces ( $s$  in figs. 79 and 80); indices  $\{11\bar{2}1\}$ ,  $\{11\bar{2}2\}$   $\{h.h.2h.l\}$ .

Dihexagonal prism, consisting of twelve faces parallel to the hexad axis and inclined to the vertical planes of symmetry; indices  $\{hiko\}$ .

Hexagonal prism of the first order  $\{10\bar{1}0\}$ , consisting of six faces parallel to the hexad axis and perpendicular to one set of three vertical planes of symmetry ( $m$  in figs. 71, 78-80).

Hexagonal prism of the second order  $\{11\bar{2}0\}$ , consisting of six faces also parallel to the hexad axis, but perpendicular to the other set of three vertical planes of symmetry ( $a$  in fig. 78).

Basal pinacoid  $\{0001\}$ , consisting of a pair of parallel planes perpendicular to the hexad axis ( $c$  in figs. 71, 78-80).

Beryl (emerald), connellite, zinc, magnesium and beryllium crystallize in this class.

#### BIPYRAMIDAL CLASS

(Parallel-faced hemihedral).

Here there is a plane of symmetry perpendicular to the hexad axis; there is also a centre of symmetry. All the closed forms are hexagonal bipyramids; the open forms are hexagonal prisms or the basal pinacoid. The general form  $\{hikl\}$  is hemihedral with parallel faces with respect to the general form of the holosymmetric class.

Apatite ( $q.v.$ ), pyromorphite, mimetite and vanadinite possess this degree of symmetry.

#### DIHEXAGONAL PYRAMIDAL CLASS

(Hemimorphic-hemihedral).

Six planes of symmetry of two kinds intersect in the hexad axis. The hexad axis is uniterminal and all the forms are open forms. The general form  $\{hikl\}$  consists of twelve faces at one end of the crystal, and is a dihedral pyramid. The hexagonal pyramids  $\{hoh\}$  and  $\{h.h.2h.l\}$  each consist of six faces at one end of the crystal. The prisms are geometrically the same as in the holosymmetric class. Perpendicular to the hexad axis are the pedions  $\{0001\}$  and  $\{000\bar{1}\}$ .

Iodyrite (AgI), greenockite (CdS), wurtzite (ZnS) and zincite (ZnO) are often placed in this class, but they more probably belong to the hemimorphic-hemihedral class of the rhombohedral division of this system.

#### TRAPEZOHEDRAL CLASS

(Trapezohedral-hemihedral).

Six dyad axes of two kinds are perpendicular to the hexad axis. The general form  $\{hikl\}$  is the hexagonal trapezohedron bounded by twelve trapezoidal faces. The other simple forms are geometrically the same as in the holosymmetric class. Barium-antimonydextro-tartrate+potassiumnitrate ( $Ba(SbO)_2(C_6H_5O_6)_2 \cdot KNO_3$ ) and the corresponding lead salt crystallize in this class.

#### HEXAGONAL PYRAMIDAL CLASS

(Hemimorphic-tetartohedral).

No other element is here associated with the hexad axis, which is uniterminal. The pyramids all consist of six faces at one end of the crystal, and prisms are all hexagonal prisms; perpendicular to the hexad axis are the pedions.

Lithium potassium sulphate, strontium-antimony dextro-tartrate, and lead-antimony dextro-tartrate are examples of this type of symmetry. The mineral nepheline is placed in this class because of the absence of symmetry in the etched figures on the prism faces (fig. 92).

#### (g) Regular Grouping of Crystals.

Crystals of the same kind when occurring together may sometimes be grouped in parallel position and so give rise to special structures, of which the dendritic (from *δένδρον*, a tree) or branch-like aggregations of native copper or of magnetite and the fibrous structures of many minerals furnish examples. Sometimes, owing to changes in the surrounding conditions, the crystal may continue its growth with a different external form or colour, e.g. sceptre-quartz.

Regular intergrowths of crystals of totally different substances such as staurolite with cyanite, rutile with haematite, blende with chalcopyrite, calcite with sodium nitrate, are not uncommon. In these cases certain planes and edges of the two crystals are parallel. (See O. Mügge, "Die regelmässigen Verwachsungen von Mineralien verschiedener Art," *Neues Jahrbuch für Mineralogie*, 1903, vol. xvi. pp. 335-475.)

But by far the most important kind of regular conjunction of crystals is that known as "twinning." Here two crystals or individuals of the same kind have grown together in a certain symmetrical manner, such that one portion of the twin may be brought into the position of the other by reflection across a

plane or by rotation about an axis. The plane of reflection is called the twin-plane, and is parallel to one of the faces, or to a possible face, of the crystal: the axis of rotation, called the twin-axis, is parallel to one of the edges or perpendicular to a face of the crystal.

In the twinned crystal of gypsum represented in fig. 81 the two portions are symmetrical with respect to a plane parallel

to the ortho-pinacoid  $\{100\}$ , i.e. a vertical plane perpendicular to the face  $b$ . Or we may consider the simple crystal (fig. 82) to be cut in half by this plane and one portion to be rotated through  $180^\circ$  about the normal to the same plane. Such a crystal (fig. 81) is therefore described as

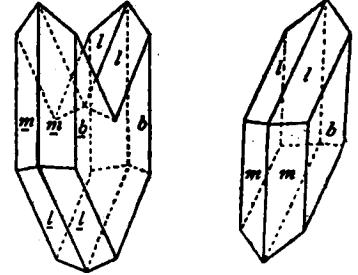

FIG. 81.—Twinned Crystal of Gypsum. FIG. 82.—Simple Crystal of Gypsum. being twinned on the plane  $\{100\}$ .

An octahedron (fig. 83) twinned on an octahedral face  $\{111\}$  has the two portions symmetrical with respect to a plane parallel to this face (the large triangular face in the figure); and either portion may be brought into the position of the other by a rotation through  $180^\circ$  about the triad axis of symmetry which is perpendicular to this face. This kind of twinning is especially frequent in crystals of spinel, and is consequently often referred to as the "spinel twin-law."

In these two examples the surface of the union, or composition-plane, of the two portions is a regular surface coinciding with the twin-plane; such twins are called "juxtaposition-twins." In other juxtaposed twins the plane of composition is, however, not necessarily the twin-plane. Another type of twin is the "interpenetration twin," an example of which is shown in fig. 84. Here one cube may be brought into the position of the other by a rotation of  $180^\circ$  about a triad axis, or by reflection across the octahedral plane which is perpendicular to this axis; the twin-plane is therefore  $\{111\}$ .

Since in many cases twinned crystals may be explained by the rotation of one portion through two right angles, R. J. Haüy introduced the term "hemitrope" (from the Gr. *ἡμι-*, half, and *τροπή*, a turn); the word "maclé" had been earlier used by Romé d'Isle. There are, however, some rare types of twins which cannot be explained by rotation about an axis, but only

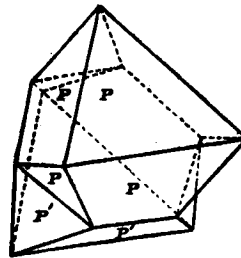

FIG. 83.—Spinel-twin.

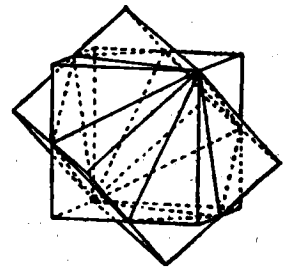

FIG. 84.—Interpenetrating Twinned Cubes.

by reflection across a plane; these are known as "symmetric twins," a good example of which is furnished by one of the twin-laws of chalcopyrite.

Twinned crystals may often be recognized by the presence of re-entrant angles between the faces of the two portions, as may be seen from the above figures. In some twinned crystals (e.g. quartz) there are, however, no re-entrant angles. On the other hand, two crystals accidentally grown together without any symmetrical relation between them will usually show some re-entrant angles, but this must not be taken to indicate the presence of twinning.

Twinning may be several times repeated on the same plane or on other similar planes of the crystal, giving rise to triplets,

quartets and other complex groupings. When often repeated on the same plane, the twinning is said to be "polysynthetic," and gives rise to a laminated structure in the crystal. Sometimes such a crystal (e.g. of corundum or pyroxene) may be readily broken in this direction, which is thus a "plane of parting," often closely resembling a true cleavage in character. In calcite and some other substances this lamellar twinning may be produced artificially by pressure (see below, Sect. II. (a), *Glide-plane*).

Another curious result of twinning is the production of forms which apparently display a higher degree of symmetry than that actually possessed by the substance. Twins of this kind are known as "mimetic-twins or pseudo-symmetric twins." Two hemihedral or hemimorphic crystals (e.g. of diamond or of hemimorphite) are often united in twinned position to produce a group with apparently the same degree of symmetry as the holosymmetric class of the same system. Or again, a substance crystallizing in, say, the orthorhombic system (e.g. aragonite) may, by twinning, give rise to pseudo-hexagonal forms: and pseudo-cubic forms often result by the complex twinning of crystals (e.g. stannite, phillipsite, &c.) belonging to other systems. Many of the so-called "optical anomalies" of crystals may be explained by this pseudo-symmetric twinning.

#### (h) Irregularities of Growth of Crystals; Character of Faces.

Only rarely do actual crystals present the symmetrical appearance shown in the figures given above, in which similar faces are all represented as of equal size. It frequently happens that the crystal is so placed with respect to the liquid in which it grows that there will be a more rapid deposition of material on one part than on another; for instance, if the crystal be attached to some other solid it cannot grow in that direction. Only when a crystal is freely suspended in the mother-liquid and material for growth is supplied at the same rate on all sides does an equably developed form result.

Two misshapen or distorted octahedra are represented in figs. 85 and 86; the former is elongated in the direction of one of the edges of the octahedron, and the latter is flattened parallel to one pair of faces. It will be noticed in these figures that the edges in which the faces intersect have the same directions as before, though here there are additional edges not present in fig. 3. The angles ( $70^{\circ} 32'$  or  $109^{\circ} 28'$ ) between the faces also remain the same; and the faces have the same inclinations to the axes and planes of symmetry as in the equably developed form. Although from a geometrical point of view these figures are no

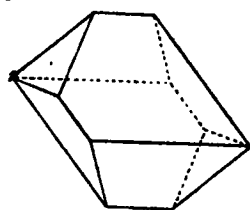

FIG. 85.

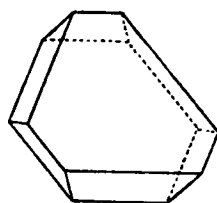

FIG. 86.

Misshapen Octahedra.

longer symmetrical with respect to the axes and planes of symmetry, yet crystallographically they are just as symmetrical as the ideally developed form, and, however much their irregularity of development, they still are regular (cubic) octahedra of crystallography. A remarkable case of irregular development is presented by the mineral cuprite, which is often found as well-developed octahedra; but in the variety known as chalcotrichite it occurs as a matted aggregate of delicate hairs, each of which is an individual crystal enormously elongated in the direction of an edge or diagonal of the cube.

The symmetry of actual crystals is sometimes so obscured by irregularities of growth that it can only be determined by measurement of the angles. An extreme case, where several of the planes have not been developed at all, is illustrated in fig. 87, which shows the actual shape of a crystal of zircon from Ceylon; the ideally developed form (fig. 88) is placed at the side for com-

parison, and the parallelism of the edges between corresponding faces will be noticed. This crystal is a combination of five simple forms, viz. two tetragonal prisms ( $a$  and  $m$ ), two tetragonal bipyramids ( $e$  and  $p$ ), and one ditetragonal bipyramid ( $x$ , with 16 faces).

The actual form, or "habit," of crystals may vary widely in different crystals of the same substance, these differences depending largely on the conditions under which the growth has taken place. The material may have crystallized from a fused

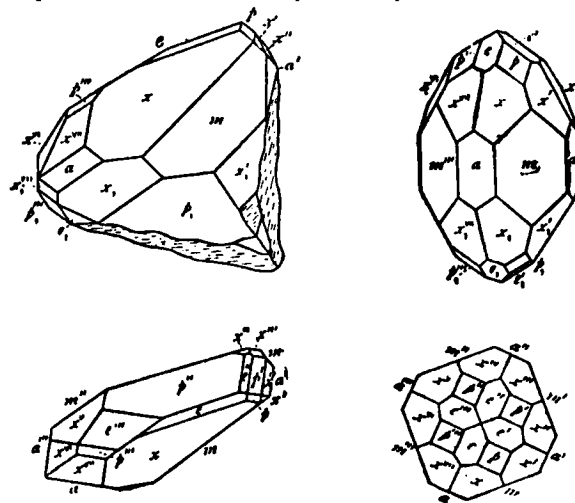

FIG. 87.—Actual Crystal. FIG. 88.—Ideal Development.  
Crystal of Zircon (clinographic drawings and plans).

mass or from a solution; and in the latter case the solvent may be of different kinds and contain other substances in solution, or the temperature may vary. Calcite (*q.v.*) affords a good example of a substance crystallizing in widely different habits, but all crystals are referable to the same type of symmetry and may be reduced to the same fundamental form.

When crystals are aggregated together, and so interfere with each other's growth, special structures and external shapes often result, which are sometimes characteristic of certain substances, especially amongst minerals.

Incipient crystals, the development of which has been arrested owing to unfavourable conditions of growth, are known as crystallites (*q.v.*). They are met with in imperfectly crystallized substances and in glassy rocks (obsidian and pitchstone), or may be obtained artificially from a solution of sulphur in carbon disulphide rendered viscous by the addition of Canada-balsam. To the various forms H. Vogelsang gave, in 1875, the names "globulites," "margarites" (from *μαργαρίτης*, a pearl), "longulites," &c. At a more advanced stage of growth these bodies react on polarized light, thus possessing the internal structure of true crystals; they are then called "microlites." These have the form of minute rods, needles or hairs, and are aggregated into feathery and spherulitic forms or skeletal crystals. They are common constituents of microcrystalline igneous rocks, and often occur as inclusions in larger crystals of other substances.

Inclusions of foreign matter, accidentally caught up during growth, are frequently present in crystals. Inclusions of other minerals are specially frequent and conspicuous in crystals of quartz, and crystals of calcite may contain as much as 60% of included sand. Cavities, either with rounded boundaries or with the same shape ("negative crystals") as the surrounding crystal, are often to be seen; they may be empty or enclose a liquid with a movable bubble of gas.

The faces of crystals are rarely perfectly plane and smooth, but are usually striated, studded with small angular elevations, pitted or cavernous, and sometimes curved or twisted. These irregularities, however, conform with the symmetry of the crystal, and much may be learnt by their study. The parallel grooves or furrows, called "striae," are the result of oscillatory combination between adjacent faces, narrow strips of first one face and then another being alternately developed. Sometimes

the striae on crystal-faces are due to repeated lamellar twinning, as in the plagioclase feldspars. The directions of the striations are very characteristic features of many crystals: e.g. the faces of the hexagonal prism of quartz are always striated horizontally, whilst in beryl they are striated vertically. Cubes of pyrites (fig. 89) are striated parallel to one edge, the striae on adjacent faces being at right angles, and due to oscillatory combination of the cube and the pentagonal dodecahedron (compare fig. 36); whilst cubes of blende (fig. 90) are striated parallel to one diagonal of each face, *i.e.* parallel to the tetrahedron faces (compare

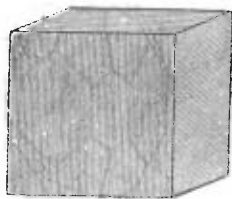

FIG. 89.—Striated Cube of Pyrites.

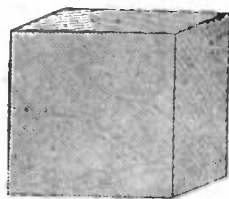

FIG. 90.—Striated Cube of Blende.

fig. 31). These striated cubes thus possess different degrees of symmetry and belong to different symmetry-classes. Oscillatory combination of faces gives rise also to curved surfaces. Crystals with twisted surfaces (see DOLOMITE) are, however, built up of smaller crystals arranged in nearly parallel position. Sometimes a face is entirely replaced by small faces of other forms, giving rise to a drusy surface; an example of this is shown by some octahedral crystals of fluorspar (fig. 2) which are built up of minute cubes.

The faces of crystals are sometimes partly or completely replaced by smooth bright surfaces inclined at only a few minutes of arc from the true position of the face; such surfaces are called "vicinal faces," and their indices can be expressed only by very high numbers. In apparently perfectly developed crystals of alum the octahedral face, with the simple indices (111), is usually replaced by faces of very low triakis-octahedra, with indices such as (251·251·250); the angles measured on such crystals will therefore deviate slightly from the true octahedral angle. Vicinal faces of this character are formed during the growth of crystals, and have been studied by H. A. Miers (*Phil. Trans.*, 1903, Ser. A. vol. 202). Other faces with high indices, *viz.* "prorision faces" and the minute faces forming the sides of etched figures (see below), as well as rounded edges and other surface irregularities, may, however, result from the corrosion of a crystal subsequent to its growth. The pitted and cavernous faces of artificially grown crystals of sodium chloride and of bismuth are, on the other hand, a result of rapid growth, more material being supplied at the edges and corners of the crystal than at the centres of the faces.

#### (i) Theories of Crystal Structure.

The ultimate aim of crystallographic research is to determine the internal structure of crystals from both physical and chemical data. The problem is essentially twofold: in the first place it is necessary to formulate a theory as to the disposition of the molecules, which conforms with the observed types of symmetry—this is really a mathematical problem; in the second place, it is necessary to determine the orientation of the atoms (or groups of atoms) composing the molecules with regard to the crystal axes—this involves a knowledge of the atomic structure of the molecule. As appendages to the second part of our problem, there have to be considered: (1) the possibility of the existence of the same substance in two or more distinct crystalline forms—polymorphism, and (2) the relations between the chemical structure of compounds which affect nearly identical or related crystal habits—isomorphism and morphotropy. Here we shall discuss the modern theory of crystal structure; the relations between chemical composition and crystallographical form are discussed in Part III. of this article; reference should also be made to the article CHEMISTRY: *Physical*.

The earliest theory of crystal structure of any moment is that of Haüy, in which, as explained above, he conceived a crystal as composed of elements bounded by the cleavage planes of the crystal, the elements being arranged contiguously and along parallel lines. There is, however, no reason to suppose that matter is continuous throughout a crystalline body; in fact, it has been shown that space does separate the molecules, and we may therefore replace the contiguous elements of Haüy by particles equidistantly distributed along parallel lines; by this artifice we retain the reticulated or net-like structure, but avoid the continuity of matter which characterizes Haüy's theory; the permanence of crystal form being due to equilibrium between the intermolecular (and interatomic) forces. The crystal is thus conjectured as a "space-lattice," composed of three sets of parallel planes which enclose parallelepipeda, at the corners of which are placed the constituent molecules (or groups of molecules) of the crystal.

The geometrical theory of crystal structure (*i.e.* the determination of the varieties of crystal symmetry) is thus reduced to the mathematical problem: "in how many ways can space be partitioned?" M. L. Frankenheim, in 1835, determined this number as fifteen, but A. Bravais, in 1850, proved the identity of two of Frankenheim's forms, and showed how the remaining fourteen coalesced by pairs, so that really these forms only corresponded to seven distinct systems and fourteen classes of crystal symmetry. These systems, however, only represented holohedral forms, leaving the hemihedral and tetartohedral classes to be explained. Bravais attempted an explanation by attributing differences in the symmetry of the crystal elements, or, what comes to the same thing, he assumed the crystals to exhibit polar differences along any member of the lattice; for instance, assume the particles to be (say) pear-shaped, then the sharp ends point in one direction, the blunt ends in the opposite direction.

A different view was adopted by L. Sohncke in 1879, who, by developing certain considerations published by Camille Jordan in 1869 on the possible types of regular repetition in space of identical parts, showed that the lattice-structure of Bravais was unnecessary, it being sufficient that each molecule of an indefinitely extended crystal, represented by its "point" (or centre of gravity), was identically situated with respect to the molecules surrounding it. The problem then resolves itself into the determination of the number of "point-systems" possible; Sohncke derived sixty-five such arrangements, which may also be obtained from the fourteen space-lattices of Bravais, by interpenetrating any one space-lattice with one or more identical lattices, with the condition that the resulting structure should conform with the homogeneity characteristic of crystals. But the sixty-five arrangements derived by Sohncke, of which Bravais' lattices are particular cases, did not complete the solution, for certain of the known types of crystal symmetry still remained unrepresented. These missing forms are characterized as being enantiomorphs; consequently, with the introduction of this principle of repetition over a plane, *i.e.* mirror images. E. S. Fedorov (1890), A. Schoenflies (1891), and W. Barlow (1894), independently and by different methods, showed how Sohncke's theory of regular point-systems explained the whole thirty-two classes of crystal symmetry, 230 distinct types of crystal structure falling into these classes.

By considering the atoms instead of the centres of gravity of the molecules, Sohncke (*Zeits. Kryst. Min.*, 1888, 14, p. 431) has generalized his theory, and propounded the structure of a crystal in the following terms: "A crystal consists of a finite number of interpenetrating regular point-systems, which all possess like and like-directed coincidence movements. Each separate point-system is occupied by similar material particles, but these may be different for the different interpenetrating partial systems which form the complex system." Or we may quote the words of P. von Groth (*British Assoc. Rep.*, 1904): "A crystal—considered as indefinitely extended—consists of  $n$

interpenetrating regular point-systems, each of which is formed of similar atoms; each of these point-systems is built up from a number of interpenetrating space-lattices, each of the latter being formed from similar atoms occupying parallel positions. All the space-lattices of the combined system are geometrically identical, or are characterized by the same elementary parallel-opipedon."

A complete résumé, with references to the literature, will be found in "Report on the Development of the Geometrical Theories of Crystal Structure, 1666-1901" (*British Assoc. Rep.*, 1901).

## II. PHYSICAL PROPERTIES OF CRYSTALS.

Many of the physical properties of crystals vary with the direction in the material, but are the same in certain directions; these directions obeying the same laws of symmetry as do the faces on the exterior of the crystal. The symmetry of the internal structure of crystals is thus the same as the symmetry of their external form.

### (a) Elasticity and Cohesion.

The elastic constants of crystals are determined by similar methods to those employed with amorphous substances, only the bars and plates experimented upon must be cut from the crystal with known orientations. The "elasticity surface" expressing the coefficients in various directions within the crystal has a configuration symmetrical with respect to the same planes and axes of symmetry as the crystal itself. In calcite, for instance, the figure has roughly the shape of a rounded rhombohedron with depressed faces and is symmetrical about three vertical planes. In the case of homogeneous elastic deformation, produced by pressure on all sides, the effect on the crystal is the same as that due to changes of temperature; and the surfaces expressing the compression coefficients in different directions have the same higher degree of symmetry, being either a sphere, spheroid or ellipsoid. When strained beyond the limits of elasticity, crystalline matter may suffer permanent deformation in one or other of two ways, or may be broken along cleavage surfaces or with an irregular fracture. In the case of plastic deformation, e.g. in a crystal of ice, the crystalline particles are displaced but without any change in their orientation. Crystals of some substances (e.g. para-azoxyanisol) have such a high degree of plasticity that they are deformed even by their surface tension, and the crystals take the form of drops of doubly refracting liquid which are known as "liquid crystals." (See O. Lehmann, *Flüssige Kristalle*, Leipzig, 1904; F. R. Schenck, *Kristallinische Flüssigkeiten und flüssige Krystalle*, Leipzig, 1905.)

In the second, and more usual kind of permanent deformation without fracture, the particles glide along certain planes into a new (twinned) position of equilibrium. If a knife blade be pressed into the edge of a cleavage rhombohedron of calcite (at *b*, fig. 91) the portion *abcde* of the crystal will take up the

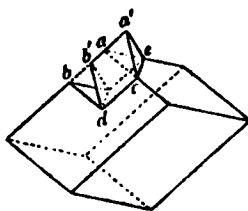

FIG. 91.—Glide-plane of Calcite.

position *a'b'c'de*. The obtuse solid angle at *a* becomes acute (*a'*), whilst the acute angle at *b* becomes obtuse (*b'*); and the new surface *a'ce* is as bright and smooth as before. This result has been effected by the particles in successive layers gliding or rotating over each other, without separation, along planes parallel to *cde*. This plane, which truncates the edge of the rhombohedron and has the indices (110), is called a "glide-plane." The new portion is in twinned position with respect to the rest of the crystal, being a reflection of it across the plane *cde*, which is therefore a plane of twinning. This secondary twinning is often to be observed as a repeated lamination in the grains of calcite composing a crystalline limestone, or marble, which has been subjected to earth movements. Planes of gliding have been observed in many minerals (pyroxene, corundum, &c.) and their crystals may often be readily broken along these directions, which are thus "planes of parting" or "pseudo-cleavage."

The characteristic transverse striae, invariably present on the cleavage surfaces of stibnite and cyanite are due to secondary twinning along glide-planes, and have resulted from the bending of the crystals.

One of the most important characters of crystals is that of "cleavage"; there being certain plane directions across which the cohesion is a minimum, and along which the crystal may be readily split or cleaved. These directions are always parallel to a possible face on the crystal and usually one prominently developed and with simple indices, it being a face in which the crystal molecules are most closely packed. The directions of cleavage are symmetrically repeated according to the degree of symmetry possessed by the crystal. Thus in the cubic system, crystals of salt and galena cleave in three directions parallel to the faces of the cube {100}, diamond and fluorspar cleave in four directions parallel to the octahedral faces {111}, and blende in six directions parallel to the faces of the rhombic dodecahedron {110}. In crystals of other systems there will be only a single direction of cleavage if this is parallel to the faces of a pinacoid; e.g. the basal pinacoid in tetragonal (as in apophyllite) and hexagonal crystals; or parallel (as in gypsum) or perpendicular (as in mica and cane-sugar) to the plane of symmetry in monoclinic crystals. Calcite cleaves in three directions parallel to the faces of the primitive rhombohedron. Barytes, which crystallizes in the orthorhombic system, has two sets of cleavages, viz. a single cleavage parallel to the basal pinacoid {001} and also two directions parallel to the faces of the prism {110}. In all of the examples just quoted the cleavage is described as perfect, since cleavage flakes with very smooth and bright surfaces may be readily detached from the crystals. Different substances, however, vary widely in their character of cleavage; in some it can only be described as good or distinct, whilst in others, e.g. quartz and alum, there is little or no tendency to split along certain directions and the surfaces of fracture are very uneven. Cleavage is therefore a character of considerable determinative value, especially for the purpose of distinguishing different minerals.

Another result of the presence in crystals of directions of minimum cohesion are the "percussion figures," which are produced on a crystal-face when this is struck with a sharp point. A percussion figure consists of linear cracks radiating from the point of impact, which in their number and orientation agree with the symmetry of the face. Thus on a cube face of a crystal of salt the rays of the percussion figure are parallel to the diagonals of the face, whilst on an octahedral face a three-rayed star is developed. By pressing a blunt point into a crystal face a somewhat similar figure, known as a "pressure figure," is produced. Percussion and pressure figures are readily developed in cleavage sheets of mica (*q.v.*).

Closely allied to cohesion is the character of "hardness," which is often defined, and measured by, the resistance which a crystal face offers to scratching. That hardness is a character depending largely on crystalline structure is well illustrated by the two crystalline modifications of carbon: graphite is one of the softest of minerals, whilst diamond is the hardest of all. The hardness of crystals of different substances thus varies widely, and with minerals it is a character of considerable determinative value; for this purpose a scale of hardness is employed (see MINERALOGY). Various attempts have been made with the view of obtaining accurate determinations of degrees of hardness, but with varying results; an instrument used for this purpose is called a sclerometer (from *σκληρός*, hard). It may, however, be readily demonstrated that the degree of hardness on a crystal face varies with the direction, and that a curve expressing these relations possesses the same geometrical symmetry as the face itself. The mineral cyanite is remarkable in having widely different degrees of hardness on different faces of its crystals and in different directions on the same face.

Another result of the differences of cohesion in different directions is that crystals are corroded, or acted upon by chemical solvents, at different rates in different directions. This is strikingly shown when a sphere cut from a crystal, say of calcite



or quartz, is immersed in acid; after some time the resulting form is bounded by surfaces approximating to crystal faces, and has the same symmetry as that of the crystal from which the sphere was cut. When a crystal bounded by faces is immersed in a solvent the edges and corners become rounded and "prerision faces" developed in their place; the faces become marked all over with minute pits or shallow depressions, and as these are extended by further solution they give place to small elevations on the corroded face. The sides of the pits and elevations are bounded by small faces which have the character of vicinal faces. These markings are known as "etched figures" or "corrosion figures," and they are extremely important aids in determining the symmetry of crystals. Etched figures are sometimes beautifully developed on the faces of natural crystals, e.g. of diamond, and they may be readily produced artificially with suitable solvents.

As an example, the etched figures on the faces of a hexagonal prism and the basal plane are illustrated in figs. 92-94 for three of the several symmetry-classes of the hexagonal system. The classes chosen are those in which nepheline, calcite and beryl (emerald) crystallize, and these minerals often have the simple form of crystal represented in the figures. In nepheline (fig. 92) the only element of symmetry is a hexad axis; the etched figures on the prism are therefore unsymmetrical, though similar on all the faces; the hexagonal markings on the basal plane have none of their edges parallel to the edges of the face; further the crystals being hemimorphic, the etched figures on the basal planes at the two ends will be different in character.

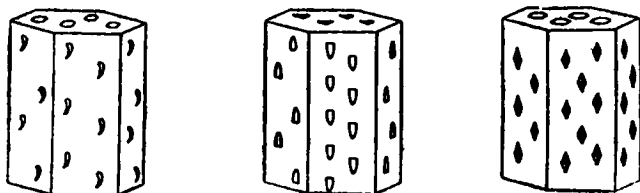

FIG. 92.—Nepheline. FIG. 93.—Calcite. FIG. 94.—Beryl.  
Etched Figures on Hexagonal Prisms.

The facial development of crystals of nepheline give no indication of this type of symmetry, and the mineral has been referred to this class solely on the evidence afforded by the etched figures. In calcite there is a triad axis of symmetry parallel to the prism edges, three dyad axes each perpendicular to a pair of prism edges and three planes of symmetry perpendicular to the prism faces; the etched figures shown in fig. 93 will be seen to conform to all these elements of symmetry. There being in calcite also a centre of symmetry, the equilateral triangles on the basal plane at the lower end of the crystal will be the same in form as those at the top, but they will occupy a reversed position. In beryl, which crystallizes in the holosymmetric class of the hexagonal system, the etched figures (fig. 94) display the fullest possible degree of symmetry; those on the prism faces are all similar and are each symmetrical with respect to two lines, and the hexagonal markings on the basal planes at both ends of the crystal are symmetrically placed with respect to six lines. A detailed account of the etched figures of crystals is given by H. Baumhauer, *Die Resultate der Ätzmethode in der kristallographischen Forschung* (Leipzig, 1894).

#### (b) Optical Properties.

The complex optical characters of crystals are not only of considerable interest theoretically, but are of the greatest practical importance. In the absence of external crystalline form, as with a faceted gem-stone, or with the minerals constituting a rock (thin, transparent sections of which are examined in the polarizing microscope), the mineral species may often be readily identified by the determination of some of the optical characters.

According to their action on transmitted plane-polarized light (see POLARIZATION OF LIGHT) all crystals may be referred to one or other of the five groups enumerated below. These groups

correspond with the six systems of crystallization (in the second group two systems being included together). The several symmetry-classes of each system are optically the same, except in the rare cases of substances which are circularly polarizing.

(1) Optically isotropic crystals—corresponding with the cubic system.

(2) Optically uniaxial crystals—corresponding with the tetragonal and hexagonal systems.

(3) Optically biaxial crystals in which the three principal optical directions coincide with the three crystallographic axes—corresponding with the orthorhombic system.

(4) Optically biaxial crystals in which only one of the three principal optical directions coincides with a crystallographic axis—corresponding with the monoclinic system.

(5) Optically biaxial crystals in which there is no fixed and definite relation between the optical and crystallographic directions—corresponding with the anorthic system.

*Optically Isotropic Crystals.*—These belong to the cubic system, and like all other optically isotropic (from *ἴσος*, like, and *τροπος*, character) bodies have only one index of refraction for light of each colour. They have no action on polarized light (except in crystals which are circularly polarizing); and when examined in the polariscope or polarizing microscope they remain dark between crossed nicols, and cannot therefore be distinguished optically from amorphous substances, such as glass and opal.

*Optically Uniaxial Crystals.*—These belong to the tetragonal and hexagonal (including rhombohedral) systems, and between crystals of these systems there is no optical distinction. Such crystals are anisotropic or doubly refracting (see REFRACTION: *Double*); but for light travelling through them in a certain, single direction they are singly refracting. This direction, which is called the optic axis, is the same for light of all colours and at all temperatures; it coincides in direction with the principal crystallographic axis, which in tetragonal crystals is a tetrad (or dyad) axis of symmetry, and in the hexagonal system a triad or hexad axis.

For light of each colour there are two indices of refraction; namely, the ordinary index ( $\omega$ ) corresponding with the ordinary ray, which vibrates perpendicular to the optic axis; and the extraordinary index ( $\epsilon$ ) corresponding with the extraordinary ray, which vibrates parallel to the optic axis. If the ordinary index of refraction be greater than the extraordinary index, the crystal is said to be optically negative, whilst if less the crystal is optically positive. The difference between the two indices is a measure of the strength of the double refraction or birefringence. Thus in calcite, for sodium (D) light,  $\omega = 1.6585$  and  $\epsilon = 1.4863$ ; hence this substance is optically negative with a relatively high double refraction of  $\omega - \epsilon = 0.1722$ . In quartz  $\omega = 1.5442$ ,  $\epsilon = 1.5533$  and  $\epsilon - \omega = 0.0091$ ; this mineral is therefore optically positive with low double refraction. The indices of refraction vary, not only for light of different colours, but also slightly with the temperature.

The optical characters of uniaxial crystals are symmetrical not only with respect to the full number of planes and axes of symmetry of tetragonal and hexagonal crystals, but also with respect to all vertical planes, i.e. all planes containing the optic axis. A surface expressing the optical relations of such crystals is thus an ellipsoid of revolution about the optic axis. (In cubic crystals the corresponding surface is a sphere.) In the "optical indicatrix" (L. Fletcher, *The Optical Indicatrix and the Transmission of Light in Crystals*, London, 1892), the length of the principal axis, or axis of rotation, is proportional to the index of refraction, (i.e. inversely proportional to the velocity) of the extraordinary rays, which vibrate along this axis and are transmitted in directions perpendicular thereto; the equatorial diameters are proportional to the index of refraction of the ordinary rays, which vibrate perpendicular to the optic axis. For positive uniaxial crystals the indicatrix is thus a prolate spheroid (egg-shaped), and for negative crystals an oblate spheroid (orange-shaped).

In "Fresnel's ellipsoid" the axis of rotation is proportional to

the velocity of the extraordinary ray, and the equatorial diameters proportional to the velocity of the ordinary ray; it is therefore an oblate spheroid for positive crystals, and a prolate spheroid for negative crystals. The "ray-surface," or "wave-surface," which represents the distances traversed by the rays during a given interval of time in various directions from a point of origin within the crystal, consists in uniaxial crystals of two sheets; namely, a sphere, corresponding to the ordinary rays, and an ellipsoid of revolution, corresponding to the extraordinary rays. The difference in form of the ray-surface for positive and negative crystals is shown in figs. 95 and 96.

When a uniaxial crystal is examined in a polariscope or polarizing microscope between crossed nicols (*i.e.* with the principal planes of the polarizer or analyser at right angles, and

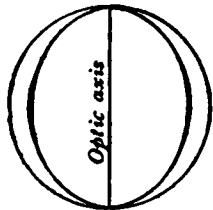

FIG. 95.—Section of the Ray-Surface of a Positive Uniaxial Crystal.

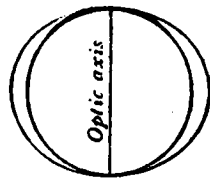

FIG. 96.—Section of the Ray-Surface of a Negative Uniaxial Crystal.

so producing a dark field of view) its behaviour differs according to the direction in which the light travels through the crystal, to the position of the crystal with respect to the principal planes of the nicols, and further, whether convergent or parallel polarized light be employed. A tetragonal or hexagonal crystal viewed, in parallel light, through the basal plane, *i.e.* along the principal axis, will remain dark as it is rotated between crossed nicols, and will thus not differ in its behaviour from a cubic crystal or other isotropic body. If, however, the crystal be viewed in any other direction, for example, through a prism face, it will, except in certain positions, have an action on the polarized light. A plane-polarized ray entering the crystal will be resolved into two polarized rays with the directions of vibration parallel to the vibration-directions in the crystal. These two rays on leaving the crystal will be combined again in the analyser, and a portion of the light transmitted through the instrument; the crystal will then show up brightly against the dark field. Further, owing to interference of these two rays in the analyser, the light will be brilliantly coloured, especially if the crystal be thin, or if a thin section of a crystal be examined. The particular colour seen will depend on the strength of the double refraction, the orientation of the crystal or section, and upon its thickness. If now, the crystal be rotated with the stage of the microscope, the nicols remaining fixed in position, the light transmitted through the instrument will vary in intensity, and in certain positions will be cut out altogether. The latter happens when the vibration-directions of the crystal are parallel to the vibration-directions of the nicols (these being indicated by cross-wires in the microscope). The crystal, now being dark, is said to be in position of extinction; and as it is turned through a complete rotation of  $360^\circ$  it will extinguish four times. If a prism face be viewed through, it will be seen that, when the crystal is in a position of extinction, the cross-wires of the microscope are parallel to the edges of the prism: the crystal is then said to give "straight extinction."

In convergent light, between crossed nicols, a very different phenomenon is to be observed when a uniaxial crystal, or section of such a crystal, is placed with its optic axis coincident with the axis of the microscope. The rays of light, being convergent, do not travel in the direction of the optic axis and are therefore doubly refracted in the crystal; in the analyser the vibrations will be reduced to the same plane and there will be interference of the two sets of rays. The result is an "interference figure" (fig. 97), which consists of a number of brilliantly coloured concentric rings, each showing the colours of the spectrum of white

light; intersecting the rings is a black cross, the arms of which are parallel to the principal planes of the nicols. If monochromatic light be used instead of white light, the rings will be alternately light and dark. The number and distance apart of the rings depend on the strength of the double refraction and on the thickness of the crystal. By observing the effect produced on such a uniaxial interference figure when a "quarter undulation (or wave-length) mica-plate" is superposed on the crystal, it may be at once decided whether the crystal is optically positive or negative. Such a simple test may, for example, be applied for distinguishing certain faceted gemstones: thus zircon and phenacite are optically positive, whilst corundum (ruby and sapphire) and beryl (emerald) are optically negative.



FIG. 97.—Interference Figure of a Uniaxial Crystal.

*Optically Biaxial Crystals.*—In these crystals there are three principal indices of refraction, denoted by  $\alpha$ ,  $\beta$  and  $\gamma$ ; of these  $\gamma$  is the greatest and  $\alpha$  the least ( $\gamma > \beta > \alpha$ ). The three principal vibration-directions, corresponding to these indices, are at right angles to each other, and are the directions of the three rectangular axes of the optical indicatrix. The indicatrix (fig. 98) is an ellipsoid with the lengths of its axes proportional to the refractive indices;  $OC = \gamma$ ,  $OB = \beta$ ,  $OA = \alpha$ , where  $OC > OB > OA$ . The figure is symmetrical with respect to the principal planes  $OAB$ ,  $OAC$ ,  $OBC$ .

In Fresnel's ellipsoid the three rectangular axes are proportional to  $1/\alpha$ ,  $1/\beta$ , and  $1/\gamma$ , and are usually denoted by  $a$ ,  $b$  and  $c$  respectively, where  $a > b > c$ : these have often been called "axes of optical elasticity," a term now generally discarded. The ray-surface (represented in fig. 99 by its sections in the three principal planes) is derived from the indicatrix in the following manner. A ray of light entering the crystal and travelling in the direction  $OA$  is resolved into polarized rays vibrating parallel to  $OB$  and  $OC$ , and therefore propagated with the velocities  $1/\beta$  and  $1/\gamma$  respectively: distances  $Ob$  and  $Oc$  (fig. 99) proportional to these velocities are marked off in the direction  $OA$ . Similarly, rays travelling along  $OC$  have the velocities

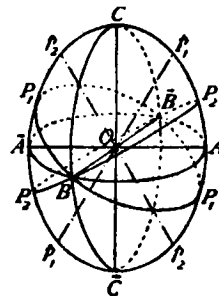

FIG. 98.—Optical Indicatrix of a Biaxial Crystal.

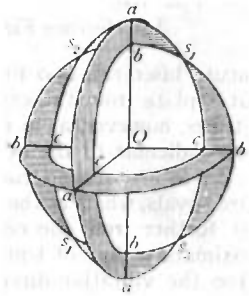

FIG. 99.—Ray-Surface of a Biaxial Crystal.

$1/\alpha$  and  $1/\beta$ , and those along  $OB$  the velocities  $1/\alpha$  and  $1/\gamma$ . In the two directions  $Op_1$  and  $Op_2$  (fig. 98), perpendicular to the two circular sections  $P_1P_1$  and  $P_2P_2$  of the indicatrix, the two rays will be transmitted with the same velocity  $1/\beta$ . These two directions are called the optic axes ("primary optic axis"), though they have not all the properties which are associated with the optic axis of a uniaxial crystal. They have very nearly the same direction as the lines  $Os_1$  and  $Os_2$  in fig. 99, which are distinguished as the "secondary optic axes." In most crystals the primary and secondary optic axes are inclined to each other at not more than a few minutes, so that for practical purposes there is no distinction between them.

The angle between  $Op_1$  and  $Op_2$  is called the "optic axial angle"; and the plane  $OAC$  in which they lie is called the "optic axial plane." The angles between the optic axes are bisected by the vibration-directions  $OA$  and  $OC$ ; the one which

bisects the acute angle being called the "acute bisectrix" or "first mean line," and the other the "obtuse bisectrix" or "second mean line." When the acute bisectrix coincides with the greatest axis  $OC$  of the indicatrix, *i.e.* the vibration-direction corresponding with the refractive index  $\gamma$  (as in figs. 98 and 99), the crystal is described as being optically positive; and when the acute bisectrix coincides with  $OA$ , the vibration-direction for the index  $\alpha$ , the crystal is negative. The distinction between positive and negative biaxial crystals thus depends on the relative magnitude of the three principal indices of refraction; in positive crystals  $\beta$  is nearer to  $\alpha$  than to  $\gamma$ , whilst in negative crystals the reverse is the case. Thus in topaz, which is optically positive, the refractive indices for sodium light are  $\alpha=1.6120$ ,  $\beta=1.6150$ ,  $\gamma=1.6224$ ; and for orthoclase which is optically negative,  $\alpha=1.5190$ ,  $\beta=1.5237$ ,  $\gamma=1.5260$ . The difference  $\gamma-\alpha$  represents the strength of the double refraction.

Since the refractive indices vary both with the colour of the light and with the temperature, there will be for each colour and temperature slight differences in the form of both the indicatrix and the ray-surface: consequently there will be variations in the positions of the optic axes and in the size of the optic axial angle. This phenomenon is known as the "dispersion of the optic axes." When the axial angle is greater for red light than for blue the character of the dispersion is expressed by  $\rho > v$ , and when less by  $\rho < v$ . In some crystals, *e.g.* brookite, the optic axes for red light and for blue light may be, at certain temperatures, in planes at right angles.

The type of interference figure exhibited by a biaxial crystal in convergent polarized light between crossed nicols is represented in figs. 100 and 101. The crystal must be viewed along

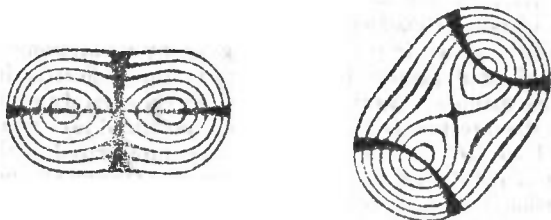

FIG. 100.

FIG. 101.

Interference Figures of a Biaxial Crystal.

the acute bisectrix, and for this purpose it is often necessary to cut a plate from the crystal perpendicular to this direction: sometimes, however, as in mica and topaz, a cleavage flake will be perpendicular to the acute bisectrix. When seen in white light, there are around each optic axis a series of brilliantly coloured ovals, which at the centre join to form an 8-shaped loop, whilst further from the centre the curvature of the rings is approximately that of lemniscates. In the position shown in fig. 100 the vibration-directions in the crystal are parallel to those of the nicols, and the figure is intersected by two black bands or "brushes" forming a cross. When, however, the crystal is rotated with the stage of the microscope the cross breaks up into the two branches of a hyperbola, and when the vibration-directions of the crystal are inclined at  $45^\circ$  to those of the nicols the figure is that shown in fig. 101. The points of emergence of the optic axes are at the middle of the hyperbolic brushes when the crystal is in the diagonal position: the size of the optic axial angle can therefore be directly measured with considerable accuracy.

In orthorhombic crystals the three principal vibration-directions coincide with the three crystallographic axes, and have therefore fixed positions in the crystal, which are the same for light of all colours and at all temperatures. The optical orientation of an orthorhombic crystal is completely defined by stating to which crystallographic planes the optic axial plane and the acute bisectrix are respectively parallel and perpendicular. Examined in parallel light between crossed nicols, such a crystal extinguishes parallel to the crystallographic axes, which are often parallel to the edges of a face or section; there is thus

usually "straight extinction." The interference figure seen in convergent polarized light is symmetrical about two lines at right angles.

In monoclinic crystals only one vibration-direction has a fixed position within the crystal, being parallel to the ortho-axis (*i.e.* perpendicular to the plane of symmetry or the plane (010)). The other two vibration-directions lie in the plane (010), but they may vary in position for light of different colours and at different temperatures. In addition to dispersion of the optic axes there may thus, in crystals of this system, be also "dispersion of the bisectrices." The latter may be of one or other of three kinds, according to which of the three vibration-directions coincides with the ortho-axis of the crystal. When the acute bisectrix is fixed in position, the optic axial planes for different colours may be crossed, and the interference figure will then be symmetrical with respect to a point only ("crossed dispersion"). When the obtuse bisectrix is fixed, the axial planes may be inclined to one another, and the interference figure is symmetrical only about a line which is perpendicular to the axial planes ("horizontal dispersion"). Finally, when the vibration-direction corresponding to the refractive index  $\beta$ , or the "third mean line," has a fixed position, the optic axial plane lies in the plane (010), but the acute bisectrix may vary in position in this plane; the interference figure will then be symmetrical only about a line joining the optic axes ("inclined dispersion"). Examples of substances exhibiting these three kinds of dispersion are borax, orthoclase and gypsum respectively. In orthoclase and gypsum, however, the optic axial angle gradually diminishes as the crystals are heated, and after passing through a uniaxial position they open out in a plane at right angles to the one they previously occupied; the character of the dispersion thus becomes reversed in the two examples quoted. When examined in parallel light between crossed nicols monoclinic crystals will give straight extinction only in faces and sections which are perpendicular to the plane of symmetry (or the plane (010)); in all other faces and sections the extinction-directions will be inclined to the edges of the crystal. The angles between these directions and edges are readily measured, and, being dependent on the optical orientation of the crystal, they are often characteristic constants of the substance (see, *e.g.*, PLAGIOCLASE).

In anorthic crystals there is no relation between the optical and crystallographic directions, and the exact determination of the optical orientation is often a matter of considerable difficulty. The character of the dispersion of the bisectrices and optic axes is still more complex than in monoclinic crystals, and the interference figures are devoid of symmetry.

**Absorption of Light in Crystals: Pleochroism.**—In crystals other than those of the cubic system, rays of light with different vibration-directions will, as a rule, be differently absorbed; and the polarized rays on emerging from the crystal may be of different intensities and (if the observation be made in white light and the crystal is coloured) differently coloured. Thus, in tourmaline the ordinary ray, which vibrates perpendicular to the principal axis, is almost completely absorbed, whilst the extraordinary ray is allowed to pass through the crystal. A plate of tourmaline cut parallel to the principal axis may therefore be used for producing a beam of polarized light, and two such plates placed in crossed position form the polarizer or analyser of "tourmaline tongs," with the aid of which the interference figures of crystals may be simply shown. Uniaxial (tetragonal and hexagonal) crystals when showing perceptible differences in colour for the ordinary and extraordinary rays are said to be "dichroic." In biaxial (orthorhombic, monoclinic and anorthic) crystals, rays vibrating along each of the three principal vibration-directions may be differently absorbed, and, in coloured crystals, differently coloured; such crystals are therefore said to be "trichroic" or in general "pleochroic" (from  $\pi\lambda\acute{\epsilon}\omega\varsigma$ , more, and  $\chi\rho\acute{o}\alpha$ , colour). The directions of maximum absorption in biaxial crystals have, however, no necessary relation with the axes of the indicatrix, unless these have fixed crystallographic directions, as in the orthorhombic system and the ortho-axis in the monoclinic. In epidote it has been shown that the two directions

of maximum absorption which lie in the plane of symmetry are not even at right angles.

The pleochroism of some crystals is so strong that when they are viewed through in different directions they exhibit marked differences in colour. Thus a crystal of the mineral iolite (called also dichroite because of its strong pleochroism) will be seen to be dark blue, pale blue or pale yellow according to which of three perpendicular directions it is viewed. The "face colours" seen directly in this way result, however, from the mixture of two "axial colours" belonging to rays vibrating in two directions. In order to see the axial colours separately the crystal must be examined with a dichroscope, or in a polarizing microscope from which the analyser has been removed. The dichroscope, or dichroscope (fig. 102), consists of a cleavage rhombohedron

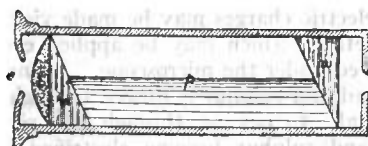

FIG. 102.—Dichroscope.

of calcite (Iceland-spar)  $p$ , on the ends of which glass prisms  $w$  are cemented: the lens  $l$  is focused on a small square aperture  $o$  in the tube of the instrument. The eye of the observer placed at  $e$  will see two images of the square aperture, and if a pleochroic crystal be placed in front of this aperture the two images will be differently coloured. On rotating this crystal with respect to the instrument the maximum difference in the colours will be obtained when the vibration-directions in the crystal coincide with those in the calcite. Such a simple instrument is especially useful for the examination of faceted gem-stones, even when they are mounted in their settings. A single glance suffices to distinguish between a ruby and a "spinel-ruby," since the former is dichroic and the latter isotropic and therefore not dichroic.

The characteristic absorption bands in the spectrum of white light which has been transmitted through certain crystals, particularly those of salts of the cerium metals, will, of course, be different according to the direction of vibration of the rays.

**Circular Polarization in Crystals.**—Like the solutions of certain optically active organic substances, such as sugar and tartaric acid, some optically isotropic and uniaxial crystals possess the property of rotating the plane of polarization of a beam of light. In uniaxial (tetragonal and hexagonal) crystals it is only for light transmitted in the direction of the optic axis that there is rotatory action, but in isotropic (cubic) crystals all directions are the same in this respect. Examples of circularly polarizing cubic crystals are sodium chlorate, sodium bromate, and sodium uranyl acetate; amongst tetragonal crystals are strychnine sulphate and guanidine carbonate; amongst rhombohedral are quartz (*q.v.*) and cinnabar (*q.v.*) (these being the only two mineral substances in which the phenomenon has been observed), dithionates of potassium, lead, calcium and strontium, and sodium periodate; and amongst hexagonal crystals is potassium lithium sulphate. Crystals of all these substances belong to one or other of the several symmetry-classes in which there are neither planes nor centre of symmetry, but only axes of symmetry. They crystallize in two complementary hemihedral forms, which are respectively right-handed and left-handed, *i.e.* enantiomorphous forms. Some other substances which crystallize in enantiomorphous forms are, however, only "optically active" when in solution (*e.g.* sugar and tartaric acid); and there are many other substances presenting this peculiarity of crystalline form which are not circularly polarizing either when crystallized or when in solution. Further, in the examples quoted above, the rotatory power is lost when the crystals are dissolved (except in the case of strychnine sulphate, which is only feebly active in solution). The rotatory power is thus due to different causes in the two cases, in the one depending on a spiral arrangement of the crystal particles, and in the other on the structure of the molecules themselves.

The circular polarization of crystals may be imitated by a pile of mica plates, each plate being turned through a small angle on the one below, thus giving a spiral arrangement to the pile.

"Optical Anomalies" of Crystals.—When, in 1818, Sir David

Brewster established the important relations existing between the optical properties of crystals and their external form, he at the same time noticed many apparent exceptions. For example, he observed that crystals of leucite and boracite, which are cubic in external form, are always doubly refracting and optically biaxial, but with a complex internal structure; and that cubic crystals of garnet and analcite sometimes exhibit the same phenomena. Also some tetragonal and hexagonal crystals, *e.g.* apophyllite, vesuvianite, beryl, &c., which should normally be optically uniaxial, sometimes consist of several biaxial portions arranged in sectors or in a quite irregular manner. Such exceptions to the general rule have given rise to much discussion. They have often been considered to be due to internal strains in the crystals, set up as a result of cooling or by earth pressures, since similar phenomena are observed in chilled and compressed glasses and in dried gelatine. In many cases, however, as shown by E. Mallard, in 1876, the higher degree of symmetry exhibited by the external form of the crystals is the result of mimetic twinning, as in the pseudo-cubic crystals of leucite (*q.v.*) and boracite (*q.v.*). In other instances, substances not usually regarded as cubic, *e.g.* the monoclinic phillipsite (*q.v.*), may by repeated twinning give rise to pseudo-cubic forms. In some cases it is probable that the substance originally crystallized in one modification at a higher temperature, and when the temperature fell it became transformed into a dimorphous modification, though still preserving the external form of the original crystal (see BORACITE). A summary of the literature is given by R. Brauns, *Die optischen Anomalien der Krystalle* (Leipzig, 1891).

#### (c) Thermal Properties.

The thermal properties of crystals present certain points in common with the optical properties. Heat rays are transmitted and doubly refracted like light rays; and surfaces expressing the conductivity and dilatation in different directions possess the same degree of symmetry and are related in the same way to the crystallographic axes as the ellipsoids expressing the optical relations. That crystals conduct heat at different rates in different directions is well illustrated by the following experiment.

Two plates (fig. 103) cut from a crystal of quartz, one parallel to the principal axis and the other perpendicular to it, are coated with a thin layer of wax, and a hot wire is applied to a point on the surface. On the transverse section the wax will be melted in a circle, and on the longitudinal section (or on the natural prism faces) in an ellipse. The isothermal surface in a uniaxial crystal is therefore a spheroid; in cubic crystals it is a sphere; and in biaxial crystals an ellipsoid, the three axes of which coincide, in orthorhombic crystals, with the crystallographic axes.

With change of temperature cubic crystals expand equally in all directions, and the angles between the faces are the same at all temperatures. In uniaxial crystals there are two principal coefficients of expansion; the one measured in the direction of the principal axis may be either greater or less than that measured in directions perpendicular to this axis. A sphere cut from a uniaxial crystal at one temperature will be a spheroid at another temperature. In biaxial crystals there are different coefficients of expansion along three rectangular axes, and a sphere at one temperature will be an ellipsoid at another. A result of this is that for all crystals, except those belonging to the cubic system, the angles between the faces will vary, though only slightly, with changes of temperature. E. Mitscherlich found that the rhombohedral angle of calcite decreases  $8' 37''$  as the crystal is raised in temperature from  $0^\circ$  to  $100^\circ$  C.



FIG. 103.—Conductivity of Heat in Quartz.

As already mentioned, the optical properties of crystals vary considerably with the temperature. Such characters as specific heat and melting-point, which do not vary with the direction, are the same in crystals as in amorphous substances.

(d) *Magnetic and Electrical Properties.*

Crystals, like other bodies, are either paramagnetic or diamagnetic, *i.e.* they are either attracted or repelled by the pole of a magnet. In crystals other than those belonging to the cubic system, however, the relative strength of the induced magnetization is different in different directions within the mass. A sphere cut from a tetragonal or hexagonal (uniaxial) crystal will if freely suspended in a magnetic field (between the poles of a strong electro-magnet) take up a position such that the principal axis of the crystal is either parallel or perpendicular to the lines of force, or to a line joining the two poles of the magnet. Which of these two directions is taken by the axis depends on whether the crystal is paramagnetic or diamagnetic, and on whether the principal axis is the direction of maximum or minimum magnetization. The surface expressing the magnetic character in different directions is in uniaxial crystals a spheroid; in cubic crystals it is a sphere. In orthorhombic, monoclinic and anorthic crystals there are three principal axes of magnetic induction, and the surface is an ellipsoid, which is related to the symmetry of the crystal in the same way as the ellipsoids expressing the thermal and optical properties.

Similarly, the dielectric constants of a non-conducting crystal may be expressed by a sphere, spheroid or ellipsoid. A sphere cut from a crystal will when suspended in an electro-magnetic field set itself so that the axis of maximum induction is parallel to the lines of force.

The electrical conductivity of crystals also varies with the direction, and bears the same relation to the symmetry as the thermal conductivity. In a rhombohedral crystal of haematite the electrical conductivity along the principal axis is only half as great as in directions perpendicular to this axis; whilst in a crystal of bismuth, which is also rhombohedral, the conductivities along and perpendicular to the axis are as 1.6:1.

Conducting crystals are thermo-electric: when placed against another conducting substance and the contact heated there will be a flow of electricity from one body to the other if the circuit be closed. The thermo-electric force depends not only on the nature of the substance, but also on the direction within the crystal, and may in general be expressed by an ellipsoid. A remarkable case is, however, presented by minerals of the pyrites group: some crystals of pyrites are more strongly thermo-electrically positive than antimony, and others more negative than bismuth, so that the two when placed together give a stronger thermo-electric couple than do antimony and bismuth. In the thermo-electrically positive crystals of pyrites the faces of the pentagonal dodecahedron are striated parallel to the cubic edges, whilst in the rarer negative crystals the faces are striated perpendicular to these edges. Sometimes both sets of striae are present on the same face, and the corresponding areas are then thermo-electrically positive and negative.

The most interesting relation between the symmetry of crystals and their electrical properties is that presented by the pyro-electrical phenomena of certain crystals. This is a phenomenon which may be readily observed, and one which often aids in the determination of the symmetry of crystals. It is exhibited by crystals in which there is no centre of symmetry, and the axes of symmetry are uniterminal or polar in character, being associated with different faces on the crystal at their two ends. When a non-conducting crystal possessing this hemimorphic type of symmetry is subjected to changes of temperature a charge of positive electricity will be developed on the faces in the region of one end of the uniterminal axis, whilst the faces at the opposite end will be negatively charged. With rising temperature the pole which becomes positively charged is called the "analogous pole," and that negatively charged the "antilogous pole": with falling temperature the charges are reversed. The phenomenon was first observed in crystals of tourmaline,

the principal axis of which is a uniterminal triad axis of symmetry. In crystals of quartz there are three uniterminal dyad axes of symmetry perpendicular to the principal triad axis (which is here similar at its two ends): the dyad axes emerge at the edges of the hexagonal prism, alternate edges of which become positively and negatively charged on change of temperature. In boracite there are four uniterminal triad axes, and the faces of the two tetrahedra perpendicular to them will bear opposite charges. Other examples of pyro-electric crystals are the orthorhombic mineral hemimorphite (called also, for this reason, "electric calamine") and the monoclinic tartaric acid and cane-sugar, each of which possesses a uniterminal dyad axis of symmetry. In some exceptional cases, *e.g.* axinite, prehnite, &c., there is no apparent relation between the distribution of the pyro-electric charges and the symmetry of the crystals.

The distribution of the electric charges may be made visible by the following simple method, which may be applied even with minute crystals observed under the microscope. A finely powdered mixture of red-lead and sulphur is dusted through a sieve over the cooling crystal. In passing through the sieve the particles of red-lead and sulphur become electrified by mutual friction, the former positively and the latter negatively. The red-lead is therefore attracted to the negatively charged parts of the crystal and the sulphur to those positively charged, and the distribution of the charges over the whole crystal becomes mapped out in the two colours red and yellow.

Since, when a crystal changes in temperature, it also expands or contracts, a similar distribution of "piezo-electric" (from *πιέζειν*, to press) charges are developed when a crystal is subjected to changes of pressure in the direction of a uniterminal axis of symmetry. Thus increasing pressure along the principal axis of a tourmaline crystal produced the same electric charges as decreasing temperature.

### III. RELATIONS BETWEEN CRYSTALLINE FORM AND CHEMICAL COMPOSITION.

That the general and physical characters of a chemical substance are profoundly modified by crystalline structure is strikingly illustrated by the two crystalline modifications of the element carbon—namely, diamond and graphite. The former crystallizes in the cubic system, possesses four directions of perfect cleavage, is extremely hard and transparent, is a non-conductor of heat and electricity, and has a specific gravity of 3.5; whilst graphite crystallizes in the hexagonal system, cleaves in a single direction, is very soft and opaque, is a good conductor of heat and electricity, and has a specific gravity of 2.2. Such substances, which are identical in chemical composition, but different in crystalline form and consequently in their physical properties, are said to be "dimorphous." Numerous examples of dimorphous substances are known; for instance, calcium carbonate occurs in nature either as calcite or as aragonite, the former being rhombohedral and the latter orthorhombic; mercuric iodide crystallizes from solution as red tetragonal crystals, and by sublimation as yellow orthorhombic crystals. Some substances crystallize in three different modifications, and these are said to be "trimorphous"; for example, titanium dioxide is met with as the minerals rutile, anatase and brookite (*q.v.*). In general, or in cases where more than three crystalline modifications are known (*e.g.* in sulphur no less than six have been described), the term "polymorphism" is applied.

On the other hand, substances which are chemically quite distinct may exhibit similarity of crystalline form. For example, the minerals iodyrite (AgI), greenockite (CdS), and zincite (ZnO) are practically identical in crystalline form; calcite (CaCO<sub>3</sub>) and sodium nitrate (NaNO<sub>3</sub>); celestite (SrSO<sub>4</sub>) and marcasite (FeS<sub>2</sub>); epidote and azurite; and many others, some of which are no doubt only accidental coincidences. Such substances are said to be "homoeomorphous" (*Gr.* *ὁμοιος*, like, and *μορφή*, form).

Similarity of crystalline form in substances which are chemically related is frequently met with and is a relation of much



importance: such substances are described as being "isomorphous." Amongst minerals there are many examples of isomorphous groups, e.g. the rhombohedral carbonates, garnet (*q.v.*), plagioclase (*q.v.*); and amongst crystals of artificially prepared salts isomorphism is equally common, e.g. the sulphates and selenates of potassium, rubidium and caesium. The rhombohedral carbonates have the general formula  $R''CO_3$ , where  $R''$  represents calcium, magnesium, iron, manganese, zinc, cobalt or lead, and the different minerals (calcite, ankerite, magnesite, chalybite, rhodochrosite and calamine (*q.v.*)) of the group are not only similar in crystalline form, cleavage, optical and other characters, but the angles between corresponding faces do not differ by more than  $1^\circ$  or  $2^\circ$ . Further, equivalent amounts of the different chemical elements represented by  $R''$  are mutually replaceable, and two or more of these elements may be present together in the same crystal, which is then spoken of as a "mixed crystal" or isomorphous mixture.

In another isomorphous series of carbonates with the same general formula  $R''CO_3$ , where  $R''$  represents calcium, strontium, barium, lead or zinc, the crystals are orthorhombic in form, and are thus dimorphous with those of the previous group (e.g. calcite and aragonite, the other members being only represented by isomorphous replacements). Such a relation is known as "isodimorphism." An even better example of this is presented by the arsenic and antimony trioxides, each of which occurs as two distinct minerals:—

$As_2O_3$ , Arsenolite (cubic); Claudetite (monoclinic).  
 $Sb_2O_3$ , Senarmontite (cubic); Valentinite (orthorhombic).

Claudetite and valentinite though crystallizing in different systems have the same cleavages and very nearly the same angles, and are strictly isomorphous.

Substances which form isodimorphous groups also frequently crystallize as double salts. For instance, amongst the carbonates quoted above are the minerals dolomite ( $CaMg(CO_3)_2$ ) and barytocalcite ( $CaBa(CO_3)_2$ ). Crystals of barytocalcite (*q.v.*) are monoclinic; and those of dolomite (*q.v.*), though closely related to calcite in angles and cleavage, possess a different degree of symmetry, and the specific gravity is not such as would result by a simple isomorphous mixture of the two carbonates. A similar case is presented by artificial crystals of silver nitrate and potassium nitrate. Somewhat analogous to double salts are the molecular compounds formed by the introduction of "water of crystallization," "alcohol of crystallization," &c. Thus sodium sulphate may crystallize alone or with either seven or ten molecules of water, giving rise to three crystallographically distinct substances.

A relation of another kind is the alteration in crystalline form resulting from the replacement in the chemical molecule of one or more atoms by atoms or radicles of a different kind. This is known as a "morphotropic" relation (Gr. *μορφή*, form, *τρόπος*, habit). Thus when some of the hydrogen atoms of benzene are replaced by (OH) and (NO<sub>2</sub>) groups the orthorhombic system of crystallization remains the same as before, and the crystallographic axis  $a$  is not much affected, but the axis  $c$  varies considerably:—

	$a$	$b$	$c$
Benzene, $C_6H_6$	0.891	1	0.799
Resorcin, $C_6H_4(OH)_2$	0.910	1	0.540
Picric acid, $C_6H_3(OH)(NO_2)_3$	0.937	1	0.974

A striking example of morphotropy is shown by the humite (*q.v.*) group of minerals: successive additions of the group  $Mg_2SiO_4$  to the molecule produce successive increases in the length of the vertical crystallographic axis.

In some instances the replacement of one atom by another produces little or no influence on the crystalline form; this happens in complex molecules of high molecular weight, the "mass effect" of which has a controlling influence on the isomorphism. An example of this is seen in the replacement of sodium or potassium by lead in the alunite (*q.v.*) group of minerals, or again in such a complex mineral as tourmaline, which, though varying widely in chemical composition, exhibits no variation in crystalline form.

For the purpose of comparing the crystalline forms of isomorphous and morphotropic substances it is usual to quote the angles or the axial ratios of the crystal, as in the table of benzene derivatives quoted above. A more accurate comparison is, however, given by the "topic axes," which are calculated from the axial ratios and the molecular volume; they express the relative distances apart of the crystal molecules in the axial directions.

The two isomerides of substances, such as tartaric acid, which in solution rotate the plane of polarized light either to the right or to the left, crystallize in related but enantiomorphous forms.

REFERENCES.—An introduction to crystallography is given in most text-books of mineralogy, e.g. those of H. A. Miers and of E. S. Dana (see MINERALOGY). The standard work treating of the subject generally is that of P. Groth, *Physikalische Krystallographie* (4th ed., Leipzig, 1905). A condensed summary is given by A. J. Moses, *The Characters of Crystals* (New York, 1899).

For geometrical crystallography, dealing exclusively with the external form of crystals, reference may be made to N. Story-Maskelyne, *Crystallography, a Treatise on the Morphology of crystals* (Oxford, 1895) and W. J. Lewis, *A Treatise on Crystallography* (Cambridge, 1899). Theories of crystal structure are discussed by L. Sohncke, *Entwicklung einer Theorie der Krystalstruktur* (Leipzig, 1879); A. Schoenflies, *Krystalssysteme und Krystalstruktur* (Leipzig, 1891); and H. Hilton, *Mathematical Crystallography and the Theory of Groups of Movements* (Oxford, 1903).

The physical properties of crystals are treated by T. Liebisch, *Physikalische Krystallographie* (Leipzig, 1891), and in a more elementary form in his *Grundriss der physikalischen Krystallographie* (Leipzig, 1896); E. Mallard, *Traité de cristallographie, Cristallographie physique* (Paris, 1884); C. Soret, *Éléments de cristallographie physique* (Geneva and Paris, 1893).

For an account of the relations between crystalline form and chemical composition, see A. Arzruni, *Physikalische Chemie der Krystalle* (Braunschweig, 1893); A. Fock, *An Introduction to Chemical Crystallography*, translated by W. J. Pope (Oxford, 1895); P. Groth, *An Introduction to Chemical Crystallography*, translated by H. Marshall (London, 1906); A. E. H. Tutton, *Crystalline Structure and Chemical Constitution*, 1910. Descriptive works giving the crystallographic constants of different substances are C. F. Rammelsberg, *Handbuch der kristallographisch-physikalischen Chemie* (Leipzig, 1881–1882); P. Groth, *Chemische Krystallographie* (Leipzig, 1906); and of minerals the treatises of J. D. Dana and C. Hintze.

(L. J. S.)

**CRYSTAL PALACE, THE**, a well-known English resort, standing high up in grounds just outside the southern boundary of the county of London, in the neighbourhood of Sydenham. The building, chiefly of iron and glass, is flanked by two towers and is visible from far over the metropolis. It measures 1608 ft. in length by 384 ft. across the transepts, and was opened in its present site in 1854. The materials, however, were mainly those of the hall set up in Hyde Park for the Great Exhibition of 1851. The designer was Sir Joseph Paxton. In the palace there are various permanent exhibitions, while special exhibitions are held from time to time, also concerts, winter pantomimes and other entertainments. In the extensive grounds there is accommodation for all kinds of games: the final tie of the Association Football Cup and other important football matches are played here, and there are also displays of fireworks and other attractions.

**CSENGERY, ANTON** (1822–1880), Hungarian publicist, and a historical writer of great influence on his time, was born at Nagyvárad on the 2nd of June 1822. He took, at an early date, a very active part in the literary and political movements immediately preceding the Hungarian Revolution of 1848. He and Baron Sigismund Kemény may be considered as the two founders of high-class Magyar journalism. After 1867 the greatest of modern Hungarian statesmen, Francis Deák, attached Csengery to his personal service, and many of the momentous state documents inspired or suggested by Deák were drawn up by Csengery. In that manner his influence, as represented by the text of many a statute regulating the relations between Austria and Hungary, is one of an abiding character. As a historical writer he excelled chiefly in brilliant and thoughtful essays on the leading political personalities of his time, such as Paul Nagy, Bertalan, Szemere and others. He also commenced a translation of Macaulay's *History*. He died at Budapest on the 13th of July 1880.

**CSIKY, GREGOR** (1842–1891), Hungarian dramatist, was born on the 8th of December 1842 at Pankota, in the county of Arad. He studied Roman Catholic theology at Pest and Vienna, and was professor in the Priests' College at Temesvár from 1870 to 1878. In the latter year, however, he joined the Evangelical Church, and took up literature. Beginning with novels and works on ecclesiastical history, which met with some recognition, he ultimately devoted himself to writing for the stage. Here his success was immediate. In his *Az ellenállhatatlan* ("L'Irrésistible"), which obtained a prize from the Hungarian Academy, he showed the distinctive features of his talent—directness, freshness, realistic vigour, and highly individual style. In rapid succession he enriched Magyar literature with realistic genre-pictures, such as *A Proletárok* ("Proletariate"), *Buborckok* ("Bubbles"), *Két szerelmem* ("Two Loves"), *A szégyenlős* ("The Bashful"), *Athalia*, &c., in all of which he seized on one or another feature or type of modern life, dramatizing it with unusual intensity, qualified by chaste and well-balanced diction. Of the latter, his classical studies may, no doubt, be taken as the inspiration, and his translation of Sophocles and Plautus will long rank with the most successful of Magyar translations of the ancient classics. Among the best known of his novels are *Arnold*, *Az Atlasz család* ("The Atlas Family"). He died at Budapest on the 19th of November 1891.

**CSOKONAI, MIHALY VITEZ** (1773–1805), Hungarian poet, was born at Debreczen in 1773. Having been educated in his native town, he was appointed while still very young to the professorship of poetry there; but soon after he was deprived of the post on account of the immorality of his conduct. The remaining twelve years of his short life were passed in almost constant wretchedness, and he died in his native town, and in his mother's house, when only thirty-one years of age. Csokonai was a genial and original poet with something of the lyrical fire of Petöfi, and wrote a mock-heroic poem called *Dorottya or the Triumph of the Ladies at the Carnival*, two or three comedies or farces, and a number of love-poems. Most of his works have been published, with a life, by Schedel (1844–1847).

**CSOMA DE KÖRÖS, ALEXANDER** (c. 1790–1842), or, as the name is written in Hungarian, **KÖRÖSI CSOMA SÁNDOR**, Hungarian traveller and philologist, born about 1790 at Körös in Transylvania, belonged to a noble family which had sunk into poverty. He was educated at Nagy-Enyed and at Göttingen; and, in order to carry out the dream of his youth and discover the origin of his countrymen, he divided his attention between medicine and the Oriental languages. In 1820, having received from a friend the promise of an annuity of 100 florins (about £10) to support him during his travels, he set out for the East. He visited Egypt, and made his way to Tibet, where he spent four years in a Buddhist monastery studying the language and the Buddhist literature. To his intense disappointment he soon discovered that he could not thus obtain any assistance in his great object; but, having visited Bengal, his knowledge of Tibetan obtained him employment in the library of the Asiatic Society there, which possessed more than 1000 volumes in that language; and he was afterwards supported by the government while he published a Tibetan-English dictionary and grammar (both of which appeared at Calcutta in 1834). He also contributed several articles on the Tibetan language and literature to the *Journal of the Asiatic Society of Bengal*, and he published an analysis of the *Kah-Gyur*, the most important of the Buddhist sacred books. Meanwhile his fame had reached his native country, and procured him a pension from the government, which, with characteristic devotion to learning, he devoted to the purchase of books for Indian libraries. He spent some time in Calcutta, studying Sanskrit and several other languages; but, early in 1842, he commenced his second attempt to discover the origin of the Hungarians, but he died at Darjiling on the 11th of April 1842. An oration was delivered in his honour before the Hungarian Academy by Eötvös, the novelist.

**CTENOPHORA**, in zoology, a class of jelly-fish which were briefly described by Professor T. H. Huxley in 1875 (see ACTINOZOA, *Ency. Brit.* 9th ed. vol. i.) as united with what we

now term Anthozoa to form the group Actinozoa; but little was known of the intimate structure of those remarkable and beautiful forms till the appearance in 1880 of C. Chun's Monograph of the Ctenophora occurring in the Bay of Naples. They may be defined as Coelentera which exhibit both a radial and bilateral symmetry of organs; with a stomodaeum; with a mesenchyma which is partly gelatinous but partly cellular; with eight meridional rows of vibratile paddles formed of long fused or matted cilia; lacking nematocysts (except in one genus). An example common on the British coasts is furnished by *Hormiphora* (*Cydippe*). In outward form this is an egg-shaped ball of clear jelly, having a mouth at the pointed (oral) pole, and a sense-organ at the broader (aboral) pole. It possesses eight meridians (costae) of iridescent paddles in constant vibration, which run from near one pole towards the other; it has also two pendent feathery tentacles of considerable length, which can be retracted into pouches. The mouth leads into an ectodermal stomodaeum ("stomach"), and the latter into an endodermal funnel (infundibulum); these two are compressed in planes at right angles to one another, the sectional long axis of the stomodaeum lying in the so-called sagittal (stomodaeal or gastric) plane, that of the funnel in the transverse (tentacular or funnel) plane. From the funnel, canals are given off in three directions; (a) a pair of paragastric (stomachal, or stomodaeal) canals run orally, parallel to the stomodaeum, and end blindly near the mouth; (b) a pair of perradial canals run in the transverse plane towards the equator of the animal; each of these becomes divided into two short canals at the base of the tentacle sheath which they supply, but has previously given off a pair of short interradianal canals, which again bifurcate into two adradial canals; all these branches lie in the equatorial plane of the animal, but the eight adradial canals then open into eight meridional canals which run orally and aborally under the costae; (c) a pair of aboral vessels which run towards the sense-organ, each of which bifurcates; of the four vessels thus formed, two only open at the sides of the sense-organ, forming the so-called excretory apertures. These three sets of structures, with the funnel from which they rise, make up the endodermal coelenteron, or gastro-vascular system. The generative organs are endodermal by origin, borne at the sides of the meridional canals as indicated by the signs ♂♀. There exists a subepithelial plexus with nerve cells



FIG. 1.—Schematic drawing of a *Cydippid* from the side. (After Chun.)

- A, Adradial canals.
- F, Infundibulum.
- I, Interradial canal.
- M, Meridional canal lying under a costa.
- N, Ciliated furrow from sense pole to costa.
- Pg, Paragastric canal.
- SO, Sense-organ.
- St, Stomodaeum.
- Subs, Subsagittal costa.
- Subt, Subtentacular costa.
- T, Tentacle.
- T', Boundaries of tentacle-sheath.

and fibres, similar to that of jelly-fishes. The sense-organ of the aboral pole is complex, and lies under a dome of fused cilia shaped like an inverted bell-jar; it consists of an otolith, formed of numerous calcareous spheroids, which is supported on four plates of fused cilia termed balancers, but is otherwise free. The ciliated ectoderm below the organ is markedly thickened, and perhaps functionally represents a nerve-ganglion: from it eight ciliated furrows radiate outwards, two passing under each balancer as through an archway, and diverge each to the head of a meridional costa.

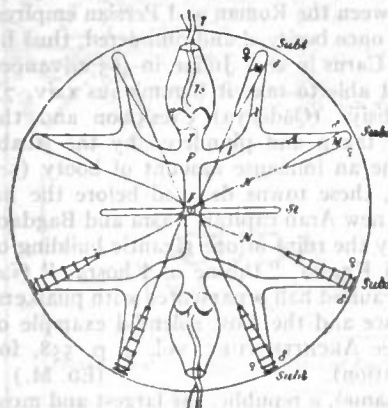

FIG. 2.—Schematic drawing of a Cydippid from the aboral pole. (After Chun.)

T (centrally), Tentacular canal, and (distally) tentacle.  
 ♂, Position of testes.  
 ♀, Position of ovaries; other letters as in fig. 1. The stomodaeum lies in the sagittal plane, the funnel and tentacles in the transverse or tentacular plane.

These ciliated furrows stain deeply with osmic acid, and nervous impulses are certainly transmitted along them. Locomotion is effected by strokes of the paddles in an aboral direction, driving the animal mouth forwards through the water: each paddle or comb (Gr. *kreis*; hence Ctenophora) consists of a plate of fused or matted cilia set transversely to the costa. The myoepithelial cells (formerly termed neuro-muscular cells), characteristic of other Coelentera, are not to be found in this group. On the other hand there are well-marked muscle fibres

in definite layers, derived from special mesoblastic cells in the embryo, which are embedded in a jelly; these in their origin and arrangement are quite comparable to the mesoderm of Triploblastica, and, although the muscle-cells of some jelly-fish exhibit a somewhat similar condition, nothing so highly specialized as the mesenchyme of Ctenophora occurs in any other Coelenterate. The nematocysts being nearly absent from their group, their chief function is carried out by adhesive lasso-cells.

The Ctenophora are classified as follows:—  
 Subclass i. **Tentaculata**, Order 1. CYDIPPIDEA, *Hormiphora*.  
 " 2. LOBATA, *Deiopea*.  
 " 3. CESTOIDEA, *Cestus*.  
 " ii. **Nuda**, " *Beroë*.

The **Tentaculata**, as the name implies, may be recognized by the presence of tentacles of some sort. The CYDIPPIDEA are generally spherical or ovoid, with two long retrusible pinnate tentacles: the meridional and paragastric canals end blindly. An example of these has already been briefly described. The LOBATA are of the same general type as the first Order, except for the presence of four circumoral auricles (processes of the subtransverse costae) and of a pair of sagittal outgrowths or lobes, on to which the subsagittal costae are continued. Small accessory tentacles lie in grooves, but there is no tentacular pouch; the meridional vessels anastomose in the lobes. In the CESTOIDEA the body is compressed in the transverse plane, elongated in the sagittal plane, so as to become riband-like: the subtransverse costae are greatly reduced, the subsagittal costae extend along the aboral edge of the riband. The subsagittal canals lie immediately below their costae aborally, but continuations of the subtransverse canals round down the middle of the riband, and at its end unite, not only with the subsagittal but also with the paragastric canals which run along the oral edge of the riband. The tentacular bases and pouches are present, but there is no main tentacle as in Cydippidea; fine accessory tentacles lie in four grooves along the oral edge. The subclass **Nuda** have no tentacles of any kind; they are conical or ovoid, with a capacious stomodaeum like the cavity of a thimble. There is a coelenteric network formed by anastomoses of the meridional and paragastric canals all over the body.

The embryology of *Callianira* has been worked out by E. Mechnikov. Segmentation is complete and unequal, producing macromeres and micromeres marked by differences in the size and in yolk-

contents. The micromeres give rise to the ectoderm; each of the sixteen macromeres, after budding off a small mesoblast cell, passes on as endoderm. A gastrula is established by a mixed process of embolae and epibolae. The mesoblast cells travel to the aboral pole of the embryo, and there form a cross-shaped mass, the arms of which lie in the sagittal and transverse planes (perradii).

There can be but little question of the propriety of including Ctenophora among the Coelentera. The undivided coelenteron (gastro-vascular system) which constitutes the sole cavity of the body, the largely radial symmetry, the presence of endo-

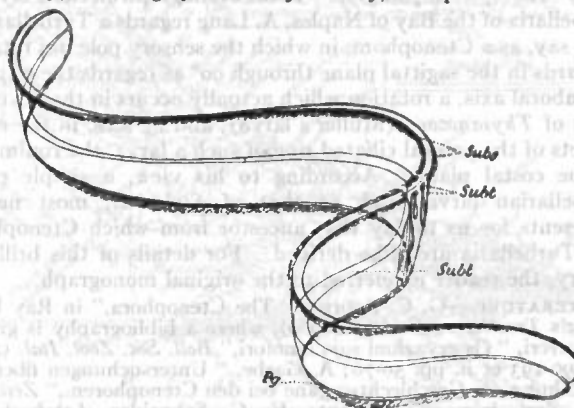

FIG. 3.—Schematic Drawing of Cestus. (After Chun.)

Subs, Subsagittal costae. Pg, Continuation of the paragastric canal at right angles to its original direction along the lower edge of the riband. At the right-hand end the last two are seen to unite with the subsagittal canal.  
 Subt, Much reduced subtentacular costae.  
 Subt, Branch of the subtentacular canal which runs along the centre of the riband.

dermal generative organs on the coelenteric canals, the subepithelial nerve-plexus, the mesogloea-like matrix of the body—all these features indicate affinity to other Coelentera, but, as has been stated in the article under that title, the relation is by no means close. At what period the Ctenophora branched off from the line of descent, which culminated in the Hydromedusae and Scyphozoa of to-day, is not clear, but it is practically certain that they did so before the point of divergence of these two groups from one another. The peculiar sense-organ, the specialization of the cilia into paddles with the corresponding modifications of the coelenteron, the anatomy and position of the tentacles, and, above all, the character and mode of formation of the mesenchyme, separate them widely from other Coelentera.

The last-named character, however, combined with the discovery of two remarkable organisms, *Coeloplana* and *Ctenoplana*, has suggested affinity to the flat-worms termed Turbellaria. *Ctenoplana*, the best known of these, has recently been redescribed by A. Willey (*Quart. Journ. Micr. Sci.* xxxix, 1896). It is flattened along the axis which unites sense-organ and mouth, so as to give it a dorsal (aboral) surface, and a ventral (oral) surface on which it frequently creeps. Its costae are very short, and retrusible; its two tentacles are pinnate and are also retrusible. Two crescentic rows of ciliated papillae lie in the transverse plane on each side of the sense-organ. The coelenteron exhibits six lobes, two of which Willey identifies with the stomodaeum of other



FIG. 4.—Schematic Drawing of *Beroë*. (After Chun.)

Ctenophora; the other four give rise to a system of anastomosing canals such as are found in *Beroë* and Polyclad Turbellaria. An aboral vessel embraces the sense-organ, but has no external opening. *Ctenoplana* is obviously a Ctenophoran flattened and of a creeping habit. *Coeloplana* is of similar form and habit, with two Ctenophoran tentacles: it has no costae, but is uniformly ciliated. These two forms at least indicate a possible stepping-stone from Ctenophora to

Turbellaria, that is to say, from diploblastic to triploblastic Metazoa. By themselves they would present no very weighty argument for this line of descent from two-layered to three-layered forms, but the coincidences which occur in the development of Ctenophora and Turbellaria,—the methods of segmentation and gastrulation, of the separation of the mesoblast cells, and of mesenchyme formation,—together with the marked similarity of the adult mesenchyme in the two groups, have led many to accept this pedigree. In his Monograph on the Polyclad Turbellaria of the Bay of Naples, A. Lang regards a Turbellarian, so to say, as a Ctenophora, in which the sensory pole has rotated forwards in the sagittal plane through 90° as regards the original oral-aboral axis, a rotation which actually occurs in the development of *Thysanozoon* (Müller's larva); and he sees, in the eight lappets of the preoral ciliated ring of such a larva, the rudiments of the costal plates. According to his view, a simple early Turbellarian larva, such as that of *Stylochus*, most nearly represents for us to-day that ancestor from which Ctenophora and Turbellaria are alike derived. For details of this brilliant theory, the reader is referred to the original monograph.

LITERATURE.—G. C. Bourne, "The Ctenophora," in Ray Lankester's *Treatise on Zoology* (1900), where a bibliography is given; G. Curreri, "Osservazioni sui ctenofori," *Boll. Soc. Zool. Ital.* (2), i. pp. 190-193 et ii. pp. 58-76; A. Garbe, "Untersuchungen über die Entstehung der Geschlechtsorgane bei den Ctenophoren," *Zeitschr. Wiss. Zool.* lxi. pp. 472-491; K. C. Schneider, *Lehrbuch der vergleich. Histologie* (1902).

**CTESIAS**, of Cnidus in Caria, Greek physician and historian, flourished in the 5th century B.C. In early life he was physician to Artaxerxes Mnemon, whom he accompanied (401) on his expedition against his brother Cyrus the Younger. Ctesias was the author of treatises on rivers, and on the Persian revenues, of an account of India (which is of value as recording the beliefs of the Persians about India), and of a history of Assyria and Persia in 23 books, called *Persica*, written in opposition to Herodotus in the Ionic dialect, and professedly founded on the Persian royal archives. The first six books treated of the history of Assyria and Babylon to the foundation of the Persian empire; the remaining seventeen went down to the year 398. Of the two histories we possess abridgments by Photius, and fragments are preserved in Athenaeus, Plutarch and especially Diodorus Siculus, whose second book is mainly from Ctesias. As to the worth of the *Persica* there has been much controversy, both in ancient and modern times. Being based upon Persian authorities, it was naturally looked upon with suspicion by the Greeks and censured as untrustworthy.

For an estimate of Ctesias as a historian see G. Rawlinson's *Herodotus*, i. 71-74; also the edition of the fragments of the *Persica* by J. Gilmore (1888, with introduction and notes and list of authorities).

**CTESIPHON**, a large village on the left bank of the Tigris, opposite to Seleucia, of which it formed a suburb, about 25 m. below Bagdad. It is first mentioned in the year 220 by Polybius v. 45. 4. When the Parthian Arsacids had conquered the lands east of the Euphrates in 129 B.C., they established their winter residence in Ctesiphon. They dared not stay in Seleucia, as this city, the most populous town of western Asia, always maintained her Greek self-government and a strong feeling of independence, which made her incline to the west whenever a Roman army attacked the Parthians. The Arsacids also were afraid of destroying the wealth and commerce of Seleucia, if they entered it with their large retinue of barbarian officials and soldiers (Strabo xvi. 743, Plin. vi. 122, cf. Joseph. *Ant.* xviii. 9, 2). From this time Ctesiphon increased in size, and many splendid buildings rose; it had the outward appearance of a large town, although it was by its constitution only a village. From A.D. 36-43 Seleucia was in rebellion against the Parthians till at last it was forced by King Vardanes to yield. It is very probable that Vardanes now tried to put Ctesiphon in its place; therefore he is called founder of Ctesiphon by Ammianus Marcellinus (xxiii. 6. 23), where King Pacorus (78-110) is said to have increased its inhabitants and built its walls. Seleucia was destroyed by the Romans in A.D. 164. When Ardashir I.

founded the Sassanian empire (226), and fixed his residence at Ctesiphon, he built up Seleucia again under the name of Veh-Ardashir. Later kings added other suburbs; Chosroes I. in 540 established the inhabitants of Antiochia in Syria, whom he had led into captivity, in a new city, "Chosrau-Antioch" (or "the Roman city") near his residence. Therefore the Arabs designate the whole complex of towns which lay together around Seleucia and Ctesiphon and formed the residence of the Sassanids by the name Madāin, "the cities,"—their number is often given as seven. In the wars between the Roman and Persian empires, Ctesiphon was more than once besieged and plundered, thus by Odaenathus in 261, and by Carus in 283; Julian in 363 advanced to Ctesiphon, but was not able to take it (Ammianus xxiv. 7). After the battle of Kadisiya (Qādisiya) Ctesiphon and the neighbouring towns were taken and plundered by the Arabs in 637, who brought home an immense amount of booty (see CALIPHATE). From then, these towns decayed before the increasing prosperity of the new Arab capitals Basra and Bagdad. The site is marked only by the ruins of one gigantic building of brick-work, called Takhti Khesra, "throne of Khosrau" (i.e. Chosroes). It is a great vaulted hall ornamented with pilasters, the remainder of the palace and the most splendid example of Sassanian architecture (see ARCHITECTURE, vol. ii. p. 558, for further details and illustration). (Ed. M.)

**CUBA** (the aboriginal name), a republic, the largest and most populous of the West India Islands, included between the meridians of 74° 7' and 84° 57' W. longitude and (roughly) the parallels of 19° 48' and 23° 13' N. latitude. It divides the entrance to the Gulf of Mexico into two passages of nearly equal width,—the Strait of Florida, about 110 m. wide between Capes Hicacos in Cuba and Arenas in Florida (Key West being a little over 100 m. from Havana); and the Yucatan Channel, about 130 m. wide between Capes San Antonio and Catoche. On the N.E., E. and S.E., narrower channels separate it from the Bahamas, Haiti (50 m.) and Jamaica (85 m.). In 1908, by the opening of a railway along the Florida Keys, the time of passage by water between Cuba and the United States was reduced to a few hours.

The island is long and narrow, somewhat in the form of an irregular crescent, convex toward the N. It has a decided pitch to the S. Its length from Cape Maisí to Cape San Antonio along a medial line is about 730 m.; its breadth, which averages about 50 m., ranges from a maximum of 160 m. to a minimum of about 22 m. The total area is estimated at 41,634 sq. m. without the surrounding keys and the Isle of Pines (area about 1180 sq. m.), and including these is approximately 44,164. The geography of the island is still very imperfectly known, and all figures are approximate only. The coast line, including larger bays, but excluding reefs, islets, keys and all minute sinuosities, is about 2500 m. in length. The N. littoral is characterized by bluffs, which grow higher and higher toward the east, rising to 600 ft. at Cape Maisí. They are marked by distinct terraces. The southern coast near Cape Maisí is low and sandy. From Guantánamo to Santiago it rises in high escarpments, and W. of Santiago, where the Sierra Maestra runs close to the sea, there is a very high abrupt shore. To the W. of Manzanillo it sinks again, and throughout most of the remaining distance to Cape San Antonio is low, with a sandy or marshy littoral; at places sand hills fringe the shore; near Trinidad there are hills of considerable height; and the coast becomes high and rugged W. of Point Fisga, in the province of Pinar del Rio. On both the N. and the S. side of the island there are long chains of islets and reefs and coral keys (of which it is estimated there are 1300), which limit access to probably half of the coast, and on the N. render navigation difficult and dangerous. On the S. they are covered with mangroves. A large part of the southern littoral is subject to overflow, and much more of it is permanently marshy. The Zapata Swamp near Cienfuegos is 600 sq. m. in area; other large swamps are the Majaguillar, E. of Cárdenas, and the Ciénaga del Buey, S. of the Cauto river. The Isle of Pines in its northern part is hilly and wooded; in its southern part, very low, level and rather barren; a tidal swamp almost cuts the island in two.



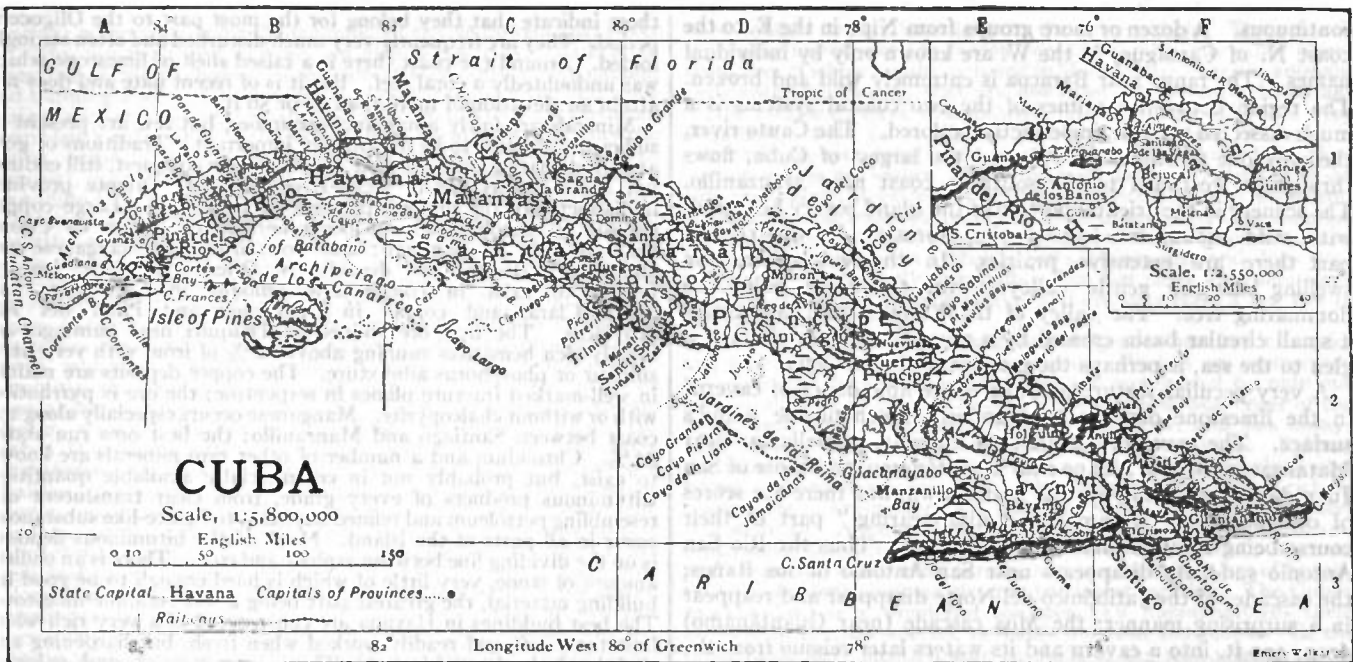

A remarkable feature of the Cuban coast is the number of excellent anchorages, roadsteads and harbours. On the N. shore, beginning at the W., Bahía Honda, Havana, Matanzas, Cardenas, Nuevitas and Nipe; and on the S. shore running westward Guantánamo, Santiago and Cienfuegos, are harbours of the first class, several of them among the best of the world. Mariel, Cabañas, Banes, Sagua la Grande and Baracoa on the N., and Manzanillo, Santa Cruz, Batabanó and Trinidad on the S. are also excellent ports or anchorages. The peculiar pouch-shape of almost all the harbours named (Matanzas being a marked exception) greatly increases their security and defensibility. These pouch harbours are probably "drowned" drainage basins. The number of small bays that can be utilized for coast trade traffic is extraordinary.

In popular language the different portions of the island are distinguished as the Vuelta Abajo ("lower turn"), W. of Havana; the Vuelta Arriba ("upper turn"), E. of Havana to Cienfuegos—Vuelta Abajo and Vuelta Arriba are also used colloquially at any point in the island to mean "east" and "west"—Las Cinco Villas—i.e. Villa Clara, Trinidad, Remedios, Cienfuegos and Sancti Spiritus—between Cienfuegos and Sancti Spiritus; and Tierra Adentro, referring to the region between Cienfuegos and Bayamo. These names are extremely common. The province and city of Puerto Príncipe are officially known as Camagüey, their original Indian name, which has practically supplanted the Spanish name in local usage.

Five topographic divisions of the island are fairly marked. Santiago (now Oriente) province is high and mountainous. Camagüey is characterized by rolling, open plains, slightly broken, especially in the W., by low mountains. The E. part of Santa Clara province is decidedly rough and broken. The W. part, with the provinces of Matanzas and Havana, is flat and rolling, with occasional hills a few hundred feet high. Finally, Pinar del Rio is dominated by a prominent mountain range and by outlying piedmont hills and mesas. There are mountains in Cuba from one end of the island to the other, but they are not derived from any central mass and are not continuous. As just indicated there are three distinctively mountainous districts, various minor groups lying outside these. The three main systems are known in Cuba as the occidental, central and oriental. The first, the Organ mountains, in Pinar del Rio, rises in a sandy, marshy region near Cape San Antonio. The crest runs near the N. shore, leaving various flanking spurs and foothills, and a coastal plain which at its greatest breadth on the S. is some 20 m. wide. The plain on the N. is narrower and higher. The southern

slope is smooth, and abounds in creeks and rivers. The portion of the southern plain between the bays of Cortés and Majana is the most famous portion of the Vuelta Abajo tobacco region. The mountain range is capriciously broken at points, especially near Bejucal. The highest part is the Pan de Guajabón, near Bahía Honda, at the W. end of the chain; its altitude has been variously estimated from 2500 to 1950 ft. The central system has two wings, one approaching the N. coast, the other covering the island between Sancti Spiritus and Santa Clara. It comprehends a number of independent groups. The highest point, the Pico Potrerillo, is about 2900 ft. in altitude. The summits are generally well rounded, while the lower slopes are often steep. Frequent broad intervals of low upland or low level plain extend from sea to sea between and around the mountains. Near the coast runs a continuous belt of plantations, while grazing, tobacco and general farm lands cover the lower slopes of the hills, and virgin forests much of the uplands and mountains.

The oriental mountain region includes the province of Oriente and a portion of Camagüey. In extent, in altitude, in mass, in complexity and in geological interest, it is much the most important of the three systems. Almost all the mountains are very bold. They are imperfectly known. There are two main ranges, the Sierra Maestra, and a line of various groups along the N. shore. The former runs from Cape Santa Cruz eastward along the coast some 125 m. to beyond the river Baconao. The Sierra de Cobre, a part of the system in the vicinity of Santiago, has a general elevation of about 3000 ft. Monte Turquino, 7700-8320 ft. in altitude, is the highest peak of the island. Gran Piedra rises more than 5200 ft., the Ojo del Toro more than 3300, the Anvil de Baracoa is somewhat lower, and Pan de Matanzas is about 1267 ft. The western portions of the range rise abruptly from the ocean, forming a bold and beautiful coast. A multitude of ravines and gullies, filled with torrential streams or dry, according to the season of the year, and characterized by many beautiful cascades, seam the narrow coastal plain and the flanks of the mountains. The spurs of the central range are a highly intricate complex, covered with dense forests of superb woods. Many points are inaccessible, and the scenery is wild in the extreme. The mountains beyond Guantánamo are locally known by a variety of names, though topographically a continuation of the Sierra Maestra. The same is true of the chains that coalesce with these near Cape Maisí and diverge northwesterly along the N. coast of the island. The general character of this northern marginal system is much the same as that of the southern, save that the range is much less



continuous. A dozen or more groups from Nipe in the E. to the coast N. of Camagüey in the W. are known only by individual names. The range near Baracoa is extremely wild and broken. The region between the lines of the two coastal systems is a much dissected plateau, imperfectly explored. The Cauto river, the only one flowing E. or W. and the largest of Cuba, flows through it westward to the southern coast near Manzanillo. The scenery in the oriental portion of the island is very beautiful, with wild mountains and tropical forests. In the central part there are extensive prairies. In the west there are swelling hills and gentle valleys, with the royal palm the dominating tree. The valley of the Yumurí, near Matanzas, a small circular basin crossed by a river that issues through a glen to the sea, is perhaps the most beautiful in Cuba.

A very peculiar feature of Cuba is the abundance of caverns in the limestone deposits that underlie much of the island's surface. The caves of Cotilla near Havana, of Bellamar near Matanzas, of Monte Libano near Guantánamo, and those of San Juan de los Remedios, are the best known, but there are scores of others. Many streams are "disappearing," part of their course being through underground tunnels. Thus the Rio San Antonio suddenly disappears near San Antonio de los Baños; the cascades of the Jatibónico del Norte disappear and reappear in a surprising manner; the Moa cascade (near Guantánamo) drops 300 ft. into a cavern and its waters later reissue from the earth; the Jojo river disappears in a great "sink" and later issues with violent current at the edge of the sea. The springs of fresh water that bubble up among the keys of the S. coast are also supposedly the outlets of underground streams.

The number of rivers is very great, but almost without exception their courses are normal to the coast, and they are so short as to be of but slight importance. The Cauto river in Oriente province is exceptional; it is 250 m. long, and navigable by small vessels for about 75 m. Inside the bar at its mouth (formed by a storm in 1616) ships of 200 tons can still ascend to Cauto. In Camagüey province the Jatibónico del Sur; in Oriente the Salado, a branch of the Cauto; in Santa Clara the Sagua la Grande (which is navigable for some 20 m. and has an important traffic), and the Damuji; in Matanzas, the Canimar; and in Pinar del Rio the Cuyaguaje, are important streams. The water-parting in the four central provinces is very indefinite. There are few river valleys that are noteworthy—those of the Yumurí, the Trinidad and the Güines. At Guantánamo and Trinidad are other valleys, and between Mariel and Havana is the fine valley of Ariguanabo. Of lakes, there are a few on the coast, and a very few in the mountains. The finest is Lake Ariguanabo, near Havana, 6 sq. m. in area. Of the almost innumerable river cascades, those of the Sierra Maestra Mountains, and in particular the Moa cascade, have already been mentioned. The Guamá cascade in Oriente province and the Hanabanilla Fall near Cienfuegos (each more than 300 ft. high), the Rosario Fall in Pinar del Rio, and the Almendares cascade near Havana, may also be mentioned.

**Geology.**—The foundation of the island is formed of metamorphic and igneous rocks, which appear in the Sierra Maestra and are exposed in other parts of the island wherever the comparatively thin covering of later beds has been worn away. A more or less continuous band of serpentine belonging to this series forms the principal watershed, although it nowhere rises to any great height. It is in this band that the greater part of the mineral wealth of Cuba is situated. These ancient rocks have hitherto yielded no fossils and their age is therefore uncertain, but they are probably pre-Cretaceous at least. Fossiliferous Cretaceous limestones containing *Rudistes* have been found in several parts of the island (Santiago de los Baños, Santa Clara province, &c.). At the base there is often an arkose, composed largely of fragments of serpentine and granite derived from the ancient floor. At Esperanza and other places in the Santa Clara province, bituminous plant-bearing beds occur beneath the Tertiary limestones, and at Baracoa a Radiolarian earth occupies a similar position. The latter, like the similar deposits in other West Indian islands, is probably of Oligocene age. It is the Tertiary limestones which form the predominant feature in the geology of Cuba. Although they do not exceed 1000 ft. in thickness, they probably at one time covered the whole island except the summits of the Sierra Maestra, where they have been observed, resting upon the older rocks, up to a height of 2300 ft. They contain corals, but are not coral reefs. The shells which have been found in

them indicate that they belong for the most part to the Oligocene period. They are frequently very much disturbed and often strongly folded. Around the coast there is a raised shelf of limestone which was undoubtedly a coral reef. But it is of recent date and does not attain an elevation of more than 40 or 50 ft.

Minerals are fairly abundant in number, but few are present in sufficient quantity to be industrially important. Traditions of gold and silver, dating from the time of the Spanish conquest, still endure, but these metals are in fact extremely rare. Oriente province is distinctively the mineral province of the island. Large copper deposits of peculiar richness occur here in the Sierra de Cobre, near the city of Santiago; and both iron and manganese are abundant. Besides the deposits in Oriente province, iron is known to exist in considerable amount in Camagüey and Santa Clara, and copper in Camagüey and Pinar del Rio provinces. The iron ores mined at Daiquirí near Santiago are mainly rich hematites running above 60% of iron, with very little sulphur or phosphorus admixture. The copper deposits are mainly in well-marked fracture planes in serpentine; the ore is pyrrhotite, with or without chalcopyrite. Manganese occurs especially along the coast between Santiago and Manzanillo; the best ores run above 50%. Chromium and a number of other rare minerals are known to exist, but probably not in commercially available quantities. Bituminous products of every grade, from clear translucent oils resembling petroleum and refined naphtha, to lignite-like substances, occur in all parts of the island. Much of the bituminous deposits is on the dividing line between asphalt and coal. There is an endless amount of stone, very little of which is hard enough to be good for building material, the greatest part being a soft coralline limestone. The best buildings in Havana are constructed of a very rich white limestone, soft and readily worked when fresh, but hardening and slightly darkening with age. There are extensive and valuable deposits of beautiful marbles in the Isle of Pines, and lesser ones near Santiago. The Organ Mountains contain a hard blue limestone; and sandstones occur on the N. coast of Pinar del Rio province. Clays of all qualities and colours abound. Mineral waters, though not yet important in trade, are extremely abundant, and a score of places in Cuba and the Isle of Pines are already known as health resorts. Those near San Diego, Guanabacoa and Santa Maria del Rosario (near Havana) and Madruga (near Güines) are the best known.

The soil of the island is almost wholly of modern formation, mainly alluvial, with superficial limestones as another prominent feature. In the original formation of the island volcanic disturbances and coral growth played some part; but there are only very slight superficial evidences in the island of former volcanic activity. Noteworthy earthquakes are rare. They have been most common in Oriente province. Those of 1776, 1842 and 1852 were particularly destructive, and of earlier ones those of 1551 and 1624 at Bayamo and of 1578 and 1678 at Santiago. Every year there are seismic disturbances, and though Santiago is the point of most frequent visitation, they occur in all parts of the island, in 1880 affecting the entire western end. Notable seismic disturbances in Cuba have coincided with similar activity in Central America so often as to make some connexion apparent.

**Flora.**—The tropical heat and humidity of Cuba make possible a flora of splendid richness. All the characteristic species of the West Indies, the Central American and Mexican and southern Florida seaboard, and nearly all the large trees of the Mexican tropic belt, are embraced in it. As many as 3350 native flowering species were catalogued in 1876. The total number of species of the island flora was estimated in 1892 by a writer in the *Revista Cubana* (vol. xv. pp. 5-16) to be between 5000 and 6000, but hardly one-third of this number had then been gathered into a herbarium, and all parts of the island had not then been explored. It was estimated officially in 1904 that the wooded lands of the island comprised 3,628,434 acres, of which one-third were in Oriente province, another third in Camagüey, and hardly any in Havana province. Much of this area is of primeval forest; somewhat more than a third of the total, belonging to the government, was opened to sale (and speculative expropriation) in 1904. The woods are so dense over large districts as to be impenetrable, except by cutting a path foot by foot through the close network of vines and undergrowth. The jagüey (*Ficus* sp.), which stifles in its giant coils the greatest trees of the forest, and the copei (*Clusia rosea*) are remarkable parasitic lianas. Of the palm there are more than thirty species. The royal palm is the most characteristic tree of Cuba. It attains a height of from 50 to 75 ft., and sometimes of more than 100 ft. Alone, or in groups, or in long aisles, towering above the plantations or its fellow trees of the forest, its beautiful crest dominates every landscape. Every portion, from its roots to its leaves, serves some useful purpose. From it the native draws lumber for his hut, utensils for his kitchen, thatch for his roof, medicines, preserved delicacies, and a long list of other articles. The corajo palm (*Cocos crispera*) rivals the royal palm in beauty and utility; oil, sugar, drink and wood are derived from it. The coco palm (*Cocos nucifera*) is also put to varied uses. The mango is planted with the royal palm along the avenues of the plantations. The beautiful ceiba (*Bombax ceiba* L., *Ceiba pentandra*) or silk cotton tree is the giant of the Cuban forests; it often grows to a height of 100 to 150 ft. with enormous girth. The royal piñon (*Erythrina*

*Delatina*) is remarkable for the magnificent purple flowers that cover it. The tamarind and banyan are also noteworthy. Utiitarian trees and plants are legion. There are at least forty choice cabinet and building woods. Of these, ebonies, mahogany (for the bird's-eye variety such enormous prices are paid as \$1200 to \$1800 per thousand board-feet), cullá (or cuyá, *Bumelia retusa*), cocullo (cocuyo, *Bumelia nigra*), ocujé (*Callophyllum viticifolia*, *Ornitrophis occidentalis*, *O. comina*), jigüe (jique, *Lysiloma sabicu*), mahagua (*Hibiscus tiliaceus*), granadillo (*Brya ebenus*), icaquillo (*Licania incana*) and agua-baría (*Cordia gerascanthes*) are perhaps the most beautiful. Other woods, beautiful and precious, include guayacán (*Guaiacum sanctum*), barla (varía, *Cordia gerascanthoides*)—the fragrant, hard-wood Spanish elm—the quebra-hacha (*Copajivera hymenofolia*), which three are of wonderful lasting qualities; the jiquí (*Malpighia obovata*), acana (*Achras dissecta*, *Bassia albenscens*), caigarán (or caguairan, *Hymenaea floribunda*), and the dagame (*Calicophyllum candidissimum*), which four, like the cullá, are all wonderfully resistant to humidity; the caimatillo (*Chrysophyllum oliviforme*), the yaya (or yayajabico, yayabito: *Erythalis fruticosa*, *Bocagea virgata*, *Gualteria virgata*, *Asimina Blaini*), a magnificent construction wood; the maboa (*Cameraria latifolia*) and the jocuma (jocum: *Sideroxylon maschodendron*, *Bumelia saticifolia*), all of individual beauties and qualities. Many species are rich in gums and resins; the calabac, mastic, copal, cedar, &c. Many others are oleaginous, among them, peanuts, sun-flowers, the bene seed (sesame), corozo, almond and palmchristi. Others (in addition to some already mentioned) are medicinal; as the palms, calabash, manchineel, pepper, fustic and a long list of cathartics, caustics, emetics, astringents, febrifuges, vermifuges, diuretics and tonics. Then, too, there are various dyewoods; rosewood, logwood (or campeachy wood), indigo, manajá (*Garcinia Morella*), Brazil-wood and saffron. Textile plants are extremely common. The majagua tree grows as high as 40 ft.; from its bark is made cordage of the finest quality, which is scarcely affected by the atmosphere. Strong, fine, glossy fibres are yielded by the exotic ramie (*Boehmeria nivea*), whose fibre, like that of the majagua, is almost incorruptible; by the maya or rat-pineapple (*Bromelia Pinguin*), and by the daquilla (or daiguiya—*Lagetta lintearia*, *L. valenzuelana*), which like the maya yields a brilliant, flexible product like silk; stronger cordage by the corajo palms, and various henequén plants, native and exotic (especially *Agave americana*, *A. Cubensis*); and various plantains, the exotic *Sansiveria guineensis*, okra, jute, *Laportea*, various lianas, and a great variety of woods, supply varied textile materials of the best quality. The yucca is a source of starch. For building and miscellaneous purposes, in addition to the rare woods above named, there are cedars (used in great quantities for cigar boxes); the pine, found only in the W., where it gives its name to the Isle of Pines and the province of Pinar del Rio; various palms; oaks of varying hardness and colour, &c. The number of alimentary plants is extremely great. Among economic plants should be mentioned the coffee, cacao, citron, cinnamon, coconut and rubber tree. Wheat, Indian corn and many vegetables, especially tuberous, are particularly important. Plantain occurs in several varieties; it is in part a cheap and healthful substitute for bread, which is also made from the bitter cassava, after the poison is extracted. The sweet cassava yields tapioca. Bread-trees are fairly common, but are little cared for. White and sweet potatoes, yams, sweet and bitter yuccas, sago and okra, may also be mentioned.

Fruits are varied and delicious. The pineapple is the most favoured by Cubans. Four or five annual crops grow from one plant, but not more than three can be marketed, unless locally, as the product deteriorates. The better ("purple") varieties are mainly consumed in the island, and the smaller and less juicy "white" varieties exported. The tamarind is everywhere. Bananas are grown particularly in the region about Nipe, Gibara and Baracoa, whence they are exported in large quantities, though there is a tendency to lessen their culture in these parts in favour of sugar. Mangoes, though exotic, are extremely common, and in the E. grow wild in the forests. They are the favourite fruit of the negroes. Oranges are little cultivated, although they offer apparently almost unlimited possibilities; their culture decreased steadily after 1880, but after about 1900 was again greatly extended. Lemons yield continuously through the year, but like oranges, not much has yet been done with them commercially. Pomegranates are as universally used in Cuba as apples in the United States. Figs and grapes degenerate in Cuba. Dates grow better, but nothing has been done with them. The coco-nut palm is most abundant in the vicinity of Baracoa. Among the common fruits are various anonas—the custard apple (*Anona cherimolia*), sweet-sop (*A. squamosa*), sour-sop (*A. muricata*), mamón (*A. reticulata*), and others,—the star-apple (*Chrysophyllum cainito*, *C. pomiferum*), rose-apple (*Eugenia jambos*), pawpaw, the sapodilla (*Sapota achras*), the caniste (*Sapota Elongata*), jagua (*Genipa americana*), alligator pear (*Persea gratissima*), the yellow mammee (*Mammea americana*) and so-called "red mammee" (*Lucuma mammosa*) and limes.

**Fauna.**—The fauna of Cuba, like the flora, is still imperfectly known. Collectively it shows long isolation from the other Antilles. Only two land mammals are known to be indigenous. One is the hutia (agouti) or Cuban rat, of which three species are known (*Capromys Fournieri*, *C. melanurus* and *C. Poeyi*). It lives in the

most solitary woods, especially in the eastern hills. The other is a peculiar insectivore (*Solenodon paradoxus*), the only other representatives of whose family are found in Madagascar. Various animals, apparently indigenous, that are described by the early historians of the conquest, have disappeared. An Antillean rabbit is very abundant. Bats in prodigious numbers, and some of them of extraordinary size, inhabit the many caves of the island; more than twenty species are known. Rats and mice, especially the guayabita (*Mus musculus*), an extremely destructive rodent, are very abundant. The manatee, or sea-cow, frequents the mouths of rivers, the sargasso drifts, and the regions of submarine fresh-water springs off the coast. Horses, asses, cows, deer, sheep, goats, swine, cats and dogs were introduced by the early Spaniards. The last three are common in a wild state. Deer are not native, and are very rare; a few live in the swamps.

Of birds there are more than 200 indigenous species, it is said, and migratory species are also numerous. Waders are represented by more than fifty species. Vultures are represented by only one species, the turkey buzzard, which is the universal scavenger of the fields, and until recent years even of the cities, and has always been protected by custom and the Laws of the Indies. Falcons are represented by a score of species, at least, several of them nocturnal. Kestrels are common. The gallinaceous order is rich in *Columbidae*. Trumpeters are notably represented, and climbers still more so. Among the latter are species of curious habits and remarkable colouring. Woodpeckers (*Colaptes auratus*), macaws, parakeets and other small parrots, and trogons, these last of beautifully resplendent plumage, deserve particular mention. The Cuban mocking-bird is a wonderful songster. Of humming-birds there are said to be sixty species, probably only one indigenous. Of the other birds mere mention may be made of the wild pigeon, raven, indigo-bird, English lady-bird and linnet.

Reptiles are numerous. Many tortoises are notable. The crocodile and cayman occur in the swampy littoral of the south. Of lizards the iguana (*Cyclura caudata*) is noteworthy. Chameleons are common. Snakes are not numerous, and it is said that none is poisonous or vicious. There is one enormous boa, the maja (*Epicrates angulifer*), which feeds on pigs, goats and the like, but does not molest man.

Fishes are present in even greater variety than birds. Felipa Poey, in his *Ictiologia Cubana*, listed 782 species of fish and crustaceans, of which 105 were doubtful; but more than one-half of the remainder were first described by Poey. The fish of Cuban waters are remarkable for their metallic colourings. The largest species are found off the northern coast. Food fishes are relatively not abundant, presumably because the deep sea escarpments of the N. are unfavourable to their life. Shell fish are unimportant. Two species of blind fish, of extreme scientific interest, are found in the caves of the island. Of the "percoideos" there are many genera. Among the most important are the robalo (*Labrax*), an exquisite food fish, the tunny, eel, Spanish sardine and mangua. Of the sharks the genus *Squalus* is represented by individuals that grow to a length of 26 to 30 ft. The hammer-head attains a weight at times of 600 lb. The saw-fish is common. Of fresh-water fish the lisa, dogro, guayacán and viajocos (*Chromis fuscomaculatus*) are possibly the most noteworthy.

Molluscs are extraordinarily numerous; and many, both of water and land, are rarities among their kind for size and richness of colour. Of crustaceans, land-crabs are remarkable for size and number. Arachnids are prodigiously numerous. Insect life is abundant and beautiful. The bite of the scorpion and of the numerous spiders produces no serious effects. The nigua, the Cuban jigger, is a pest of serious consequence, and the mal de nigua (jigger sickness) sometimes causes the death of lower animals and men. Sand-flies and biting gnats are lesser nuisances. Lepidoptera are very brilliant in colouring. The cucujo or Cuban firefly (*Pyrophorus noctilucus*) gives out so strong a light that a few of them serve effectively as a lantern. The *Stegomyia* mosquito is the agent of yellow fever inoculation. Sponges grow in great variety.

**Climate.**—The climate of Cuba is tropical and distinctively insular in characteristics of humidity, equability and high mean temperature. There are two distinct seasons: a "dry" season from November to April, and a hotter, "wet" season. About two-thirds of the total precipitation falls in the latter. Droughts, extensive in area and in duration, are by no means uncommon. At Havana the mean temperature is about 76° F., with extreme monthly oscillations ranging on the average from 6° to 12° F. for different months, and with a range between the means of the coldest and warmest months of 10° (70° to 80°); temperatures below 50° or above 90° being rare. The mean rainfall at Havana is about 40.6 in. (sometimes over 80), and the mean absolute humidity of different months ranges from 70 to 80%. These figures represent fairly well the conditions of much of the northern coast. In the N.E. the rainfall is much greater. The equability of heat throughout the day is masked and relieved by the afternoon sea breezes. The trades are steady through the year, and

in the dry season the western part of the island enjoys cool "northerns." Despite this the interior is somewhat cooler than the coast, and in the uplands frost is not uncommon. The southern littoral is also (except in sheltered points such as Santiago, which is one of the hottest cities of the island) somewhat cooler than the northern.

More than eight or ten years rarely pass without tornadoes or hurricanes of local severity at least. Notably destructive ones occurred in 1768, 1774, 1842, 1844, 1846, 1865, 1870, 1876, 1885 and 1894. Those of 1842 and 1844 caused extreme distress in the island. In 1846, 300 vessels and 2000 houses were destroyed at Havana; in 1896 the banana groves of the N.E. coast were ruined and the banana industry prostrated; and in 1906 Havana suffered damage. The autumn months, particularly October and November, are those in which such storms most frequently occur.

*Health.*—Convincing evidence is offered by the qualities of the Spanish race in Cuba that white men of temperate lands can be perfectly acclimatized in this tropical island. As for diseases, some common to Cuba and Europe are more frequent or severe in the island, others rarer or milder. There are the usual malarial, bilious and intermittent fevers, and liver, stomach and intestinal complaints prevalent in tropical countries; but unhygienic living is, in Cuba as elsewhere, mainly responsible for their existence. Yellow fever (which first appeared in Cuba in 1647) was long the only epidemic disease, Havana being an endemic focus. Aside from the recurrent loss of life, the pecuniary loss from such epidemics was enormous, and the interference with commerce and social intercourse with other countries extremely vexatious. The Cuban coast was uninterruptedly full of infection, and the danger of an outbreak in each year was never absent, until the work of the United States army in 1901-1902 conclusively proved that this disease, though ineradicable by the most extreme sanitary measures, based on the accepted theory of its origin as a filth-disease, could be eradicated entirely by removing the possibility of inoculation by the *Stegomyia* mosquito. Since then yellow fever has ceased to be a scourge in Cuba. Small-pox was the cause of a greater mortality than yellow fever even before the means of combating the latter had been ascertained. The remarkable sanitary work begun during the American occupation and continued by the republic of Cuba, has shown that the ravages of this and other diseases can be greatly diminished. Leprosy is rather common, but seemingly only slightly contagious. Consumption is very prevalent.

*Agriculture.*—Soils are of four classes: calcareous-ferruginous, alluvial, argillous and silicious. Calcareous lands are predominant, especially in the uplands. Deep residual clay soils derived from underlying limestones, and coloured red or black according to the predominance of oxides of iron or vegetable detritus, characterize the plains. A red-black soil known as "mulatto" or tawny is perhaps the best fitted for general cultivation. Tobacco is most generally cultivated on loose red soils, which are rich in clays and silicates; and sugar-cane preferably on the black and mulatto soils; but in general, contrary to prevalent suppositions, colour is no test of quality and not a very valuable guide in the setting of crops. Almost without exception the lands throughout the island are of extreme fertility. The lowlands about Cienfuegos, Trinidad, Mariel and Matanzas are noted for their richness. The census of 1899 showed that farm lands occupied three-tenths of the total area; the cultivated area being one-tenth of the farms or 3% of the whole. At the end of 1905 it was officially estimated that 16% was in cultivation. In 1902 it was officially estimated that the public land available for permanent agrarian cultivation, including forest lands, was only 186,967 hectares (416,995 acres), almost wholly in the province of Oriente. The average size of a farm in 1899 was 143 acres. More than 85% of all cultivated lands were then occupied by whites; and somewhat more than one-half (56.6%) of all occupiers were renters. Holdings of more than 32 acres constituted only 7% of the total. As regards crops, 47% of the cultivated area was given over to sugar, 11% to sweet potatoes, 9% to tobacco and almost 9% to bananas.

But owing to the disturbed conditions created by the war it is probable that these figures by no means represent normal conditions. The actual sugar crop of 1899-1900, for example, was not a quarter of that of 1894. With the establishment of peace in 1898 and the influx of American and other capital and of a heavy immigration, great changes took place in agriculture as in other industrial conditions.

Sugar has been the dominant crop since the end of the 18th century. Before the Civil War of 1895-1898 the capital invested in sugar estates was greater by half than that represented by tobacco and coffee plantations, live-stock ranches and other farms. Since that time fruit and live-stock interests have increased. The dependence of the island on one crop has been an artificial economic condition often of grave momentary danger to prosperity; but generally speaking, the progress of the industry has been steady. The competition of the sugar-beet has been felt severely. During and after the war of 1868-1878, when many Cuban estates were confiscated, many families emigrated, and many others were ruined, the ownership of plantations largely passed from the hands of Cubans to Spaniards. Under the conditions of free labour, the development of railways abroad, the improvement of machinery both in cane and beet producing countries, the general competition of the beet, and the fall of prices, it was impossible for the Cuban industry to survive without radical betterment of methods. About 1885 began an immense development of centralization (the tendency having been evident many years before this). Plantations have increased greatly in size (and also diminished in number), greater capital is involved, bagasse furnaces have been introduced, double grinding mills have increased by more than a half the yield of juice from a given weight of cane, and extractive operations instead of being carried on on all plantations have been (since 1880) concentrated in comparatively few "centrals" (168 in Feb. 1908). Three-fourths of all are in the jurisdictions of Cienfuegos, Cárdenas, Havana, Matanzas and Sagua la Grande, which are the great sugar centres of the island (three-fourths of the crop coming from Matanzas and Santa Clara provinces). Caibarién, Guantánamo and Manzanillo are next in importance. A comparatively low cost of labour, the fact that labour is not, as in the days of slavery, that of unintelligent blacks but of intelligent free labourers, the centralized organization and modern methods that prevail on the plantations, the remarkable fertility of the soil (which yields 5 or 6 crops on good soil and with good management, without replanting), and the proximity of the United States, in whose markets Cuba disposes of almost all her crop, have long enabled her to distance her smaller West Indian rivals and to compete with the bounty-fed beet. The methods of cultivation, however, are still distinctly extensive, and the returns are much less than they would be (and in some other cane countries are) under more intensive and scientific methods of cultivation. Indeed, conditions were relatively primitive so late as 1880, if compared with those of other sugar-producing countries. More than four-fifths of the total area sown to cane in the island is in the three provinces of Santa Clara, Matanzas and Oriente (formerly Santiago), the former two representing two-thirds of the area and three-fourths of the crop. The majority of the sugar estates are of an area less than 3000 acres, and the most common area is between 1500 and 2000 acres; but the extremes range from a very small size to 60,000 acres. Only a part of the great estates is ever planted in any one season. The most profitable unit is calculated to be a daily consumption of 1500 tons of cane, or 150,000 in a grinding season of 100 days, which implies a feeding area not above 6000 acres. In the season of 1904-1905, which may be taken as typical, 179 estates, with a planted area of 431,056 acres, produced 11,576,137 tons of cane, and yielded—in addition to alcohol, brandy and molasses—1,089,814 tons of sugar. Of this amount 416,862 tons were produced by 24 estates yielding more than 11,000 tons each, including one (planting 28,050 acres) that yielded 33,609, and 4 others more than 22,000 tons each. The production of the island from 1850 to 1868 averaged 469,934 tons yearly, rising from 223,145 to 749,000; from 1869 to 1886

(continuing high during the period of the Ten Years' War), 632,003 tons; from 1887 to 1907—omitting the five years 1896–1900 when the industry was prostrated by war,—909,827 tons (and including the war period, 758,066); and in the six harvests of 1901–1906, 1,016,899 tons. Prior to 1902 the million mark was reached only twice—in 1894 and 1895. Following the resuscitation of the industry after the last war, the island's crop rose steadily from one-sixth to a full quarter of the total cane sugar output of the world, its share in the world's product of sugar of all kinds ranging from a tenth to an eighth. Of this enormous output, from 98.3% upward went to the United States;<sup>1</sup> of whose total importation of all sugars and of cane sugar the proportion of Cuban cane—steadily rising—was respectively 49.8 and 53.7% in the seasons of 1900–1901 and 1904–1905.

If sugar is the island's greatest crop, tobacco is her most renowned in the markets of the world. Three-fourths of the tobacco of Cuba comes from Pinar del Rio province; the rest mainly from the provinces of Havana and Santa Clara,—the description *de partido* being applied to the leaf not produced in Havana and Pinar del Rio provinces, and sometimes to all produced outside the *vuelta abajo*. This district, including the finest land, is on the southern slope of the Organ Mountains between the Honda river and Mantua; bananas are cultivated with the tobacco. "Vegas" (tobacco fields) of especially good repute are also found near Trinidad, Remedios, Yara, Mayarí and Vicana. The tobacco industry has been uniformly prosperous, except when crippled by the destruction of war in 1868–1878 and 1895–1898. Even in the time of slavery tobacco was generally a white-man's crop; for it requires intelligent labour and intensive care. In recent years the growth of the leaf under cloth tents has greatly increased, as it has been abundantly proved that the product thus secured is much more valuable—lighter in colour and weight, finer in texture, with an increased proportion of wrapper leaves, and more uniform qualities, and with lesser amounts of cellulose, nicotine, gums and resins. In these respects the finest Cuban tobacco crops, produced in the sun, hardly rival the finest Sumatra product; but produced under cheese-cloth they do. "Cuban tobacco" does not mean to-day, as a commercial fact, what the words imply; for the original *Nicotiana Tabacum*, variety *havanensis*, can probably be found pure to-day only in out-of-the-way corners of Pinar del Rio. After the Ten Year's War seed of Mexican and United States tobaccos was in great demand to re-seed the ruined vegas, and was introduced in great quantities; and although by a later law the destruction of these exotic species was ordered, that destruction was in fact quite impossible. "Lusty growers and coarser than the genuine old-time Cuban . . . Mexican tobaccos (*Nicotiana Tabacum*, variety *macrophyllum*) are to-day predominant in a large part of Cuban vegas. . . . Ordinary commercial Cuban seed of to-day is largely, and often altogether, Mexican tobacco." Though improved in the Cuban environment, the foreign tobaccos introduced after the Ten Years' War did not lose their exotic character, but prevailed over the indigenous forms: "Tobaccos with exactly the character of the introduced types are now the prevalent forms" (quotation from Bulletin of the *Estación Central Agronómica*, Feb. 1908). In the markets of the world Cuban tobacco has always suffered less competition than Cuban sugar, and still less has been done than in the case of sugar cane in the study of methods of cultivation, which in several respects are far behind those of other tobacco-growing countries. The crop of 1907 was 201,512 bales (109,562,400 lb Sp.).

Coffee-raising was once a flourishing and very promising industry. It first attained prominence with the settlement in eastern Cuba, late in the 18th century, of French refugee immigrants from San Domingo. Some "cafetales" were established by the newcomers near Havana, but the industry has always been almost exclusively one of Oriente province; with Santa Clara as a much smaller producer. Before

<sup>1</sup> Other countries taking only 27,462 long tons out of a total of 5,719,777 in the seven fiscal years 1899–1900 to 1905–1906.

the war of 1868–1878 the production amounted to about 25,000,000 lb yearly. The war of 1895–1898 still further diminished the vitality of the industry. In 1907 the crop was 6,595,700 lb. The berries are of fine quality, and despite the competition of Brazil there is no (agricultural) reason why the home market at least should not be supplied from Cuban estates.

Of other agricultural crops those of fruits are of greatest importance—bananas (which are planted about once in three years), pine-apples (planted about once in five years), coco-nuts, oranges, &c. The coco-nut industry has long been largely confined to the region about Baracoa, owing to the ruin of the trees elsewhere by a disease not yet thoroughly understood, which, appearing finally near Baracoa, threatened by 1908 to destroy the industry there as well. Yams and sweet-potatoes, yuccas, malangas, cacao, rice—which is one of the most important foods of the people, but which is not yet widely cultivated on a profitable basis—and Indian corn, which grows everywhere and yields two crops yearly, may be mentioned also. In very recent years gardening has become an interest of importance, particularly in the province of Pinar del Rio. Save on the coffee, tobacco and sugar plantations, where competition in large markets has compelled the adoption of adequate modern methods, agriculture in Cuba is still very primitive. The wooden ploughstick, for instance—taking the country as a whole—has never been displaced. A central agricultural experiment station (founded 1904) is maintained by the government at Santiago de las Vegas; but there is no agricultural college, nor any special school for the scientific teaching and improvement of sugar and tobacco farming or manufacture.

Stock-breeding is a highly important interest. It was the all-important one in the early history of the island, down to about the latter part of the 18th century. Grasses grow luxuriantly, and the savannahs of central Cuba are, in this respect, excellent cattle ranges. The droughts to which the island is recurrently subject are, however, a not unimportant drawback to the industry; and though the best ranges, under favourable conditions, are luxuriant, nevertheless the pastures of the island are in general mediocre. Practically nothing has yet been done in the study of native grasses and the introduction of exotic species. The possibilities of the stock interest have as yet by no means been realized. The civil wars were probably more disastrous to it than to any other agricultural interest of the island. It has been authoritatively estimated, for example, that from 90 to 95% of all horses, neat cattle and hogs in the entire island were lost in the war years of 1895–1898. In the decade after 1898 particularly great progress was made in the raising of live-stock. The fishing and sponge industries are important. Batabano and Caibarién are centres of the sponge fisheries.

*Manufactures.*—The manufacturing industries of Cuba have never been more than insignificant as compared with what they might be. In 1907 48.5% of all wage-earners were engaged in agriculture, fishing and mining, 16.3 in manufactures, and 17.7 in trade and transportation. Such manufactures as are of any consequence are mostly connected with the sugar and tobacco industries. Forest resources have been but slightly touched (more so since the end of Spanish rule) except mahogany, which goes to the United States, and cedar, which is used to box the tobacco products of the island, much going also to the United States. The value of forest products in 1901–1902 amounted to \$320,528. There are some tanneries, some preparation of preserves and other fruit products, and some old handicraft industries like the making of hats; but these have been of comparatively scant importance. Despite natural advantages for all meat industries, canned meats have generally been imported. The leading manufactures are cigars and cigarettes, sugar, rum and whisky. The tobacco industries are very largely concentrated in Havana, and there are factories in Santiago de las Vegas and Bejucal. The yearly output of cigars was locally estimated in 1908 at about 500,000,000, but this is probably too high an estimate. In 1904–1906 the yearly average sent to the United States was 234,063,652 cigars, 29,776,429 lb of leaf and 14,203,571 packages of cigarettes. The sugar industry is not similarly centralized. With the improvement of methods the old partially refined grades (*moscobados*) have disappeared.

*Mining.*—Mining is of very considerable importance. The Cobre copper mines near Santiago were once the greatest producers of the world. They were worked from 1524 until about 1730, when they were abandoned for almost a century, after which they were reopened and greatly developed. In 1828/1840 about two million dollars' worth of ore was shipped yea

to the United States alone. After 1868 the mines were again abandoned and flooded, the mining property being ruined during the civil war. Finally, after 1900 they again became prosperous producers. The "Cobre" mine is only the most famous and productive of various copper properties. The copper output has not greatly increased since 1890, and is of slight importance in mineral exports. Iron and manganese have, on the contrary, been greatly developed in the same period. Iron is now the most important mineral product. The iron ores are even more accessible than the famous ones of the Lake Superior region in the United States. No shafts or tunnels are necessary except for exploration; the mining consists entirely in open-cut and terrace work. The cost of exploitation is accordingly slight. Daiquiri, near Santiago, and mines near Nipe, on the north coast, are the chief centres of production. Nearly the entire product goes to the United States. The first exports from the Daiquiri district were made by an American company in 1884; the Nipe (Cagimaya) mines became prominent in promise in 1906. The shipments from Oriente province from 1884 to 1901 aggregated 5,053,847 long tons, almost all going to the United States (which is true of other mineral products also). After 1900 production was greatly increased and by 1906 had come to exceed half a million tons annually. There are small mines in Santa Clara and Camagüey provinces. Manganese is mined mainly near La Maya and El Cristo in Oriente. The traditions as to gold and silver have already been referred to. Evidences of ancient workings remain near Holguin and Gibara, and it is possible that some of these workings are still exploitable. Mining for the precious metals ceased at a very early date, after rich discoveries were made on the continent. Bituminous products, though, as already stated, widely distributed, are not as yet much developed. The most promising deposits and the most important workings are in Matanzas and Santa Clara provinces. Petroleum has been used to some extent both as a fuel and as an illuminant. Small amounts of asphalt have been sent to the United States. Locally, asphalts are used as gas enrichers. Grahamite and glance-pitch are common, and are exported for use in varnish and paint manufactures. The commercial product of stones, brick and cement is of rapidly increasing importance. The foundation of the island is in many places almost pure carbonate of lime, and there are numerous small limekilns. The product is used to bleach sugar, as well as for construction and disinfection purposes. The number of small brick plants is legion, almost all very primitive.

**Commerce.**—Commerce (resting largely upon specialized agriculture) is vastly more prominent as yet than manufacturing and mining in the island's economy. The leading articles of export are sugar, tobacco and fruit products; of import, textiles, foodstuffs, lumber and wood products, and machinery. Sugar and tobacco products together represent seven-eighths (in 1904-1907 respectively 60.3 and 27.3%) of the normal annual exports. In the quinquennial period 1890-1894 (immediately preceding the War of Independence) the average yearly commerce of the island in and out was \$86,875,663 with the United States; and \$28,161,726 with Spain.<sup>1</sup> During the American military occupation of the island in 1899-1902, of the total imports 45.9% were from the United States, 14 from other American countries, 15 from Spain, 14 from the United Kingdom, 6 from France and 4 from Germany; of the exports the corresponding percentages for the same countries were 70.7, 2, 3, 10, 4 and 7. No special favours were enjoyed by the United States in this period, and about the same percentages prevailed in the years following. The total commercial movement of the island in the five calendar years 1902-1906 averaged \$177,882,640 (for the five fiscal years 1902-1903 to 1906-1907, \$185,987,020) annually, and of this the share of the United States was \$108,431,000 yearly, representing 45.8% of all imports and

<sup>1</sup> In these same years the trade of the United States with Cuba and Porto Rico was: importations from the islands, \$59,221,444 annually; exportations to the islands, \$20,017,156. The corresponding figures for Spain were \$7,265,142 and \$20,035,183; and for the United Kingdom, \$714,837 and \$11,971,129, the trade with other countries being of much less amount.

81.9% of all exports. The proportion of imports taken from the United States is greatest in foodstuffs, metals and metal manufactures, timber and furniture, mineral oils and lard. The trade of the United States with the island was as great in 1900-1907 as with Mexico and all the other West Indies combined; as great as its trade with Spain, Portugal and Italy combined; and almost as great as its trade with China and Japan.

**Communications.**—Poor means of communication have always been a great handicap to the industries of the island. The first railroad in Cuba (and the first in Spanish lands) was opened from Havana to Güines in 1837. In succeeding years a fairly ample system was built up between the cities of Pinar del Rio and Santa Clara, with a number of short spurs from the chief ports farther eastward into the interior. After the first American occupation a private company built a line from Santa Clara to Santiago, more than half the length of the island, finally connecting its two ends (1902). The policy of the railways was always one rather of extortion than of fairness or of any interest in the development of the country, but better conditions have begun. There was ostensible government regulation of rates after 1877, but the roads were guaranteed outright against any loss of revenue, and in fact practically nothing was ever done in the way of reform in the Spanish period. In 1900 the total length of railways was 2097 m., of which 1226 were of 17 public roads and 871 m. of 107 private roads. In August 1908 the mileage of all railways (including electric) in Cuba was 2329.8 m. The telegraph and telephone systems are owned by the government. Cables connect the island with Florida, Jamaica, Haiti and San Domingo, Porto Rico, the lesser Antilles, Panama, Venezuela and Brazil. Havana, Santiago and Cienfuegos are cable ports. Wagon roads are still of small extent and primitive character save in a very few localities. The peculiar two-wheeled carts of the country, carrying enormous loads of 4 to 6 tons, destroy even the finest road. Similar carts, slightly lighter, used in the cities, quickly destroy any paving but stone block. The only good highways of any considerable length in 1908 were in the two western provinces and in the vicinity of Santiago. During the second American occupation work was begun on a network of good rural highways.

**Population.**—Various censuses were taken in Cuba beginning in 1774; but the results of those preceding the abolition of slavery, at least, are probably without exception extremely untrustworthy. The census of 1887 showed a population of 1,631,687, that of 1899 a population of 1,572,792 (the decrease of 3.6% is explained by the intervening war); and by the census of 1907 there were 2,048,980 inhabitants, 30.3% more than in 1899. The average of settlement per square mile varied from 169.7 in Havana province to 11.8 in Camagüey, and was 46.4 for all of Cuba; the percentage of urban population (in cities, that is, with more than 1000 inhabitants) in the different provinces varied from 18.2 in Pinar del Rio to 74.7 in Havana, and was 43.9 for the entire island. There were five cities having populations above 25,000—Havana, 297,159; Santiago, 45,470; Matanzas, 36,009; Cienfuegos, 30,100; Puerto Príncipe (or Camagüey), 29,616; and fourteen more above 8000—Cardenas, Manzanillo, Guanabacoa, Santa Clara, Sagua la Grande, Sancti Spiritus, Guantánamo, Trinidad, Pinar del Rio, San Antonio de los Baños, Jovellanos, Marianao, Caibarién and Güines. The proportion of the total population which in 1907 was in cities of 8000 or more was only 30.3%; and the proportion in cities of 25,000 or more was 21.4%. Mainly owing to the large element of transient foreign whites without families (long characteristic of Cuba), males outnumber females—in 1907 as 21 to 19. Native whites, almost everywhere in the majority, constituted 59.8% of all inhabitants; persons of negro and mixed blood, 29.7%; foreign-born whites, 9.9%; Chinese less than 0.6%. Foreigners constituted 25.6% of the population in the city of Havana; only 7% in Pinar del Rio province. Native blood is most predominant in the provinces of Oriente and Pinar del Rio. After the end of the war of 1895-1898 a large immigration from Spain began; the inflow from the United States was very small in comparison. The Republic strongly encourages



immigration. In 1900-1906 there were 143,122 immigrants, of whom 124,863 were Spaniards, 4557 were from the United States, 2561 were Spanish Americans, and a few were Italian, Syrian, Chinese, French, English, &c. The Chinese element is a remnant of a former coolie population; their numbers in 1907 (11,217) were less than a fourth the number in 1887. Their introduction began in 1847 and ended in 1871. Conjugal conditions in Cuba are peculiar. In 1907 only 20.7% of the total population were legally married; an additional 8.6% were living in more or less permanent consensual unions, these being particularly common among the negroes. Including all unions the total is below the European proportion, but above that of Porto Rico or Jamaica in 1899.

The negro element is strongest in the province of Oriente and weakest in Camagüey; in the former it constituted 43.1% of the population, in the latter 18.3%, and in Havana City 25.5%. In Guantánamo, in Santiago de Cuba, and in seven other towns they exceeded the whites in number. Caibarién and San Antonio de los Baños had the largest proportion of white population. The position of the negroes in Cuba is exceptional. Despite the long period of slavery they are decidedly below the whites in number. The Spanish slave laws (although in practice often frightfully abused) were always comparatively generous to the slave, making relatively easy, among other things, the purchase of his freedom, the number of free blacks being always great. Since the abolition of slavery the status of the black has been made more definite, and his rights naturally much greater. The wars of 1868-1878 and 1895-1898 and the threatened war of 1906 all helped to give to the negro element its high position. There is no antagonism between the divisions of the coloured race. All hold their own with the white in industrial usefulness to the community, and though the blacks are more backward in education and various other tests of social advancement, still their outlook is full of promise. There is practically no colour caste in Cuba; politically the negro is the white man's equal; socially there is very little ostensible inequality and almost perfect toleration. The negro in Cuba shows promising though undeveloped traits of landlordship. Women labour habitually in the fields. Miscegenation of blacks and whites was extremely common before emancipation. It is sometimes said that since then there has been a counter-tendency, but it is impossible to prove such a statement conclusively except with the aid of future censuses. Few of the negroes are black; some of the blackest have the regular features of the Caucasian; and racial mixtures are everywhere evidenced by colour of skin and by physiognomy. It seems certain that the African element has been holding its own in the population totals since emancipation.

Cuba is overwhelmingly Roman Catholic in religion, but under the new Republic there is a complete separation of church and state, and liberalism and indifference are increasing. Illiteracy is extremely widespread. In 1907 the census showed 56.6% (43.3 in 1899) of persons above ten years who could read. Of the voting population 53.2% of native white, and 37.3% of coloured Cuban citizens, and 71.6% of Spanish citizens could read. A revolution in education was begun the first year of the United States military occupation and continued under the Republic.

*Constitution.*—The constitution upon which the government of Cuba rests was framed during the period of the United States military government; it was adopted the 21st of February 1901, and certain amendments or conditions required by the United States were accepted on the 12th of June 1901. The constitution is republican and modelled on the Constitution of the United States, with some marked differences of greater centralization, due to colonial experience under the rule of Spain, notably as regards federalism; the provinces of the island being less important than the states of the American Union. The president of the Republic, who is elected for four years by an electoral college, and cannot hold office for more than two successive terms, has a cabinet whose members he may appoint and remove freely, their number being determined by law. He sanctions, promulgates and executes the laws, and supplements

them (partly co-ordinately with congress) by administrative regulations in harmony with their ends; holds a veto power and pardoning power; controls with the senate political appointments and removals; and conducts foreign relations, submitting treaties to the senate for ratification. Congress consists of two houses. The senate contains four members from each province, chosen for eight years by a provincial electoral board, which consists of the provincial councilmen plus a double number of electors (half of them paying high taxes) who are selected at a special election by their fellow citizens. Half of the senators retire every four years. The senate is the court of trial for the president, officers of the cabinet, and provincial governors when accused of political offences. It also acts jointly with the president in political appointments and treaty making. The house of representatives, whose members are chosen directly by the citizens for four years, one-half retiring every two years, has the special power of impeaching the president and cabinet officers. Congress meets twice annually, in April and November. Its powers are extensive, including, in addition to ordinary legislative powers, control of financial affairs, foreign affairs, the power to declare war and approve treaties of peace, amnesties, electoral legislation for the provinces and municipalities, control of the electoral vote for president and vice-president, and designation of an acting president in case of the death or incapacity of these officers. The subjects of legislative power are very similar to those of the United States congress; but control of railroads, canals and public roads is explicitly given to the federal government. Justice is administered by courts of various grades, with a supreme court at Havana as the head; the members of this being appointed by the president and senate. This court passes on the constitutionality of all laws, decrees and regulations.

There are six provinces—Pinar del Rio, Havana, Matanzas, Santa Clara, Camagüey or Puerto Príncipe, and Oriente. Each has a provincial governor and assembly chosen directly by the people, generally charged with independent control of matters affecting the province; but the president may interfere against an abuse of power by either the governor or the assembly. Municipalities are administered by mayors (alcaldes) and assemblies elected by the people, and control strictly municipal affairs. The "termino municipal" is the chief political and administrative civil division. It is an urban district together with contiguous rural territory. Its divisions are "barrios." The president may interfere if necessary in the municipality as in the province; and so may the governor of the province. But all interference is subject to review of claims by the courts. Both provinces and municipalities are forbidden by the constitution to contract debts without a coincident provision of permanent revenue for their settlement.

The franchise is granted to every male Cuban twenty-one years of age, not mentally incapacitated, nor previously a convict of crime, nor serving in the army or navy of the state. Foreigners may become citizens in five years by naturalization. Church and state are completely separated, toleration being guaranteed for the profession and practice of all religious beliefs, and the government may not subsidize any religion.

Primary education is declared by the constitution to be free and compulsory; and its expenses are paid by the central government so far as it may be beyond the power of the province or municipality to bear them. *Education.* Secondary and advanced education is controlled by the state. In the last days of Spanish rule (1894), there were 904 public and 704 private schools, and not more than 60,000 pupils enrolled; in 1900 there were 3550 public schools with an enrolment of 172,273 and an average attendance of 123,362. In the four school years from 1903-1904 to 1906-1907 the figures of enrolment and average attendance were: 201,824 and 110,531; 194,657 and 105,706; 186,571 and 98,329; and 189,289 and 93,865. In 1906-1907 the percentage (31.6) of attendants to children of school age was twice as large as in 1898-1899. Private schools, some of very high grade, draw many pupils. Almost all schools are primary. The university of Havana (founded

1728) was given greatly improved facilities, especially of material equipment, by the American military government, and seems to have begun an ambitious progress. In 1907 the number of students was 554. Below the university there are six provincial institutes, one in each province, in each of which there is a preparatory department, a department of secondary education, and (this due to peculiar local conditions) a school of surveying; and in that of Havana commercial departments in addition. In Havana, also, there is a school of painting and sculpture, a school of arts and trades, and a national library, all of which are supported or subventioned by the national government, as are also a public library in Matanzas, and the Agricultural Experiment Station at Santiago de las Vegas. In connexion with the university is a hotanical garden; with the national sanitary service, a biological laboratory, and special services for small-pox, glanders and yellow fever. Independent of the government are various schools and learned societies in Havana (*q.v.*). A school was established by the government in Key West, Florida (U.S.A.), in 1905, for the benefit of the Cuban colony there. Finally, the government sustains about two score of penal establishments, reform schools, hospitals, dispensaries and asylums, which are scattered all over the island,—every town of any considerable size having one or more of these charities.

Under the colonial rule of Spain the head of government was a supreme civil-military officer, the governor and captain-general. His control of the entire administrative life of the island was practically absolute. Originally residents at Santiago de Cuba, the captains-general resided after 1589 at Havana. Because of the isolation of the eastern part of the island, the dangers from pirates, and the important considerations which had caused Santiago de Cuba (*q.v.*) to be the first capital of the island, Cuba was divided in 1607 into two departments, and a governor, subordinate in military matters to the captain-general at Havana, was appointed to rule the territory east of Puerto Príncipe. In 1801, when the *audiencia*—of which the captain-general was *ex officio* president—began its functions at that point, the governor of Santiago became subordinated in political matters as much as in military. Two chief courts of justice (*audiencias*) sat at Havana (after 1832) and Puerto Príncipe (1800–1853); appeals could go to Spain; below the *audiencias* were “*alcaldes mayores*” or district judges and ordinary “*alcaldes*” or local judges. The *audiencias* also held important political powers under the Laws of the Indies. The captaincy-general of Cuba was not originally, however, by any means so broad in powers as the viceroalties of Mexico and Peru; and by the creation in 1765 of the office of intendant—the delegate of the national treasury—his faculties were very greatly curtailed. The great powers of the intendant were, however, merged in those of the governor-general in 1853; and the captain-general having been given by royal order in 1825 (several times later explicitly confirmed, and not revoked until 1870) the absolute powers (to be assumed at his initiative and discretion) of the governor of a besieged city, and by a royal order of 1834 the power to banish at will persons supposed to be inimical to the public peace; and being by virtue of his office the president and dominator of all the important administrative boards of the government, held the government of the island, and in any emergency the liberty and property of its inhabitants, in his hand. The royal orders following 1825 developed a system of extraordinary and extreme repression. In 1878, as the result of the Ten Years' War, various administrative reforms, of a decentralizing tendency, were introduced. The six provinces were created, and had governors and assemblies (“*diputaciones*”); and a municipal law was provided that in many ways was a sound basis for local government. But centralization remained very great. In the municipality the *alcalde* (mayor) was appointed by the governor-general, and the *ayuntamiento* (council) was controlled by the veto of the provincial governor and by the assembly of the province. The deputation was subject in turn to the same veto of the provincial governor, and he controlled by the governor-general. There was besides a provincial commission of five lawyers named by the

governor-general from the members of the deputation, who settled election questions, and questions of eligibility in this body, gave advice as to laws, acted for the deputation when it was not sitting, and in general facilitated centralized control of the administrative system. The character of this body was altered in 1890, and in 1898, in which latter year its functions were reduced to the essentially judicial. Despite superficial decentralization after 1878 any real growth of local self-government was rendered impossible. Moreover, no great reforms were made in the abuses naturally incident to the old personal system. Exile and imprisonment at the will of the government and without trial were common. Personal liberty, liberty of conscience, speech, assembly, petition, association, press, liberty of movement and security of home, were without real guarantee even within the extremely small limits in which they nominally existed. Under the constitution of the Republic the sphere of individual liberty is large and constitutionally protected against the government.

*Finance*.—There has been a great change in the budget of Cuba since the advent of the Republic. In 1891–1896 the average annual income was \$20,738,930, the annual average expenditure \$25,967,139. More than half of the revenue was derived from customs duties (two-thirds of the total being collected at Havana). Of the expenditure more than ten million dollars annually went for the public debt, 5.5 to 6 millions for the army and navy, as much more for civil administration (including more than two millions for purely Peninsular services with which the colony was burdened); and on an average probably one million more went for sinecures. Every Cuban paid about twice as heavy taxes as a Spaniard of the Peninsula. Very little was spent on sanitation, roads, other public works and education. The revenue receipts under the Republic have increased especially over those of the old régime in the item of customs duties; and the expenditure is very differently distributed. Lotteries which were an important source of revenue under Spain were abolished under the Republic. The debt resting on the colony in 1895 (a large part of it as a result of the war of 1868–1878, the entire cost of which was laid upon the island, but a part as the result of Spain's war adventures in Mexico and San Domingo, home loans, &c.) was officially stated at \$168,500,000. The attainment of independence freed the island from this debt, and from enormous contemplated additions to cover the expense incurred by Spain during the last insurrection. The debt of the Republic in April 1908 was \$48,146,585, including twenty-seven millions which were assumed in 1902 for the payment of the army of independence, four for agriculture, and four for the payment of revolutionary debts, and \$2,196,585, representing obligations assumed by the revolution's representative in the United States during the War of Independence. United States and British investments, always important in the agriculture and manufactures of the island, greatly increased following 1898, and by 1908 those of each nation were supposed to exceed considerably \$100,000,000.

*Archaeology*.—Archaeological study in Cuba has been limited, and has not produced results of great importance. Almost nothing is actually known of prehistoric Cuba; and a few skulls and implements are the only basis existing for conjecture. Very little also is known as to the natives who inhabited the island at the time of the discovery. They were a tall race of copper hue; fairly intelligent, mild in temperament, who lived in poor huts and practised a limited and primitive agriculture. How numerous they were when the Spaniards first came among them cannot be said; undoubtedly tradition has greatly exaggerated their number. They are supposed to have been practically extinct by 1550. Even in the 19th century reports were spread of communities in which Indian blood was supposedly still plainly dominant; but the conclusion of the competent scientists who have investigated such rumours has been that at least absolutely nothing of the language and traditions of the aborigines has survived.

*History*.—Cuba was discovered by Columbus in the course of his first voyage, on the 27th of October 1492. He died believing

Cuba was part of a continent. In 1508 Sebastian de Ocampo circumnavigated it. In 1511 Diego Velazquez began the conquest of the island. Baracoa (the landing point), Bayamo, Santiago de Cuba, Puerto Principe, Sancti Spiritus, Trinidad and the original Havana were all founded by 1515. Velazquez's reputation and legends of wealth drew many immigrants to the island. From Cuba went the expeditions that discovered Yucatan (1517), and explored the shores of Mexico, Hernando Cortés's expedition for the invasion of Mexico, and de Soto's for the exploration of Florida. The last two had a pernicious effect on Cuba, draining it of horses, money and of men. At least as early as 1523 the African slave trade was begun. In 1544 the Indians, so far as they had not succumbed to the labour of the mines and fields to which they were put by the Spaniards, were proclaimed emancipated. The administration in the 16th century was loose and violent. The local authorities were divided among themselves by bitter feuds—the ecclesiastical against the civil, the *ayuntamiento* against the governors, the administrative officers among themselves; brigandage, mutinies and intestinal struggles disturbed the peace. As a result of the transfer of Jamaica to England, the population of Cuba was greatly augmented by Jamaican immigrants to about 30,000 in the middle of the 17th century.

The activity of English and French pirates began in the 16th century, and reached its climax in the middle of the 17th century. So early also began dissatisfaction with the economic regulations of the colonial system, even grave resistance to their enforcement; and illicit trade with privateers and foreign colonies had begun long before, and in the 17th and 18th centuries was the basis of the island's wealth. In 1762 Havana was captured after a long resistance by a British force under Admiral Sir George Pocock and the earl of Albemarle, with heavy loss to the besiegers. It was returned to Spain the next year in exchange for the Floridas. From this date begins the modern history of the island. The British opened the port to commerce and the slave trade and revealed its possibilities. The government of Spain, beginning in 1764, made notable breaches in the old monopolistic system of colonial trade throughout America; and Cuba received special privileges, also, that were a basis for real prosperity. Spain paid increasing attention to the island, and in harmony with the policy of the Laws of the Indies many decrees intended to stimulate agriculture and commerce were issued by the crown, first in the form of monopolies, then with increased freedom and with bounties. Various colonial products and the slave trade were favoured in this way. After the cession of the Spanish portion of San Domingo to France hundreds of Spanish families emigrated to Cuba, and many thousand more immigrants, mainly French, followed them from the entire island during the revolution of the blacks. Most of them settled in Oriente province, where their names and blood are still apparent, and with their cafetales and sugar plantations converted that region from neglect and poverty to high prosperity.

Under a succession of liberal governors (especially Luis de las Casas, 1790-1796, and the marqués de Someruelos, 1799-1813), at the end of the 18th century and the first part of the 19th, when the wars in Europe cut off Spain almost entirely from the colony, Cuba was practically independent. Trade was comparatively free, and worked a revolution in culture and material conditions. General Las Casas, in particular, left behind him in Cuba an undying memory of good efforts. Free commerce with foreigners—a fact after 1809—was definitely legalized in 1818 (confirmed in 1824). The state tobacco monopoly was abolished in 1817. The reported populations by the (untrustworthy) censuses of 1774, 1792 and 1817 were 161,670, 273,301 and 553,033. Something of political freedom was enjoyed during the two terms of Spanish constitutional government under the constitution of 1812. The sharp division between creoles and peninsulars (*i.e.* between those born in Cuba and those born in Spain), the question of annexation to the United States or possibly to some other power, the plotting for independence, all go back to the early years of the century.

Partly because of political and social divisions thus revealed,

conspiracies being rife in the decade 1820-1830, and partly as preparation for the defence against Mexico and Colombia, who throughout these same years were threatening the island with invasion, the captains-general, in 1825, received the powers above referred to; which became, as time passed, monstrously in discord with the general tendencies of colonial government and with increasing liberties in Spain, but continued to be the spiritual basis of Spanish rule in the island. Among the governors of the 19th century Miguel Tacón, governor in 1834-1839, a forceful and high-handed soldier, deserves mention, especially in the annals of Havana; he ruled as a tyrant, made many reforms as regarded law and order, and left Havana, in particular, full of municipal improvements. The good he did was limited to the spheres of public works and police; in other respects his rule was a pernicious influence for Cuba. Politically his rule was marked by the proclamation at Santiago in 1836, without his consent, of the Spanish constitution of 1834; he repressed the movement, and in 1837 the deputies of Cuba to the Cortes of Spain (to which they were admitted in the two earlier constitutional periods) were excluded from that body, and it was declared in the national constitution that Cuba (and Porto Rico) should be governed by "special laws." The inapplicability of many laws passed for the Peninsula—all of which under a constitutional system would apply to Cuba as to any other province, unless that system be modified—was indeed notorious; and Cuban opinion had repeatedly, through official bodies, protested against laws thus imposed that worked injustice, and had pleaded for special consideration of colonial conditions. The promise of "special laws" based upon such consideration was therefore not, in itself, unjust, nor unwelcome. But as the colony had no voice in the Cortes, while the "special laws" were never passed (Cuba expected special fundamental laws, reforming her government, and the government regarded the old Laws of the Indies as satisfying the obligation of the constitution) the arbitrary rule of the captains-general remained quite supreme, under the will of the crown, and colonial discontent became stronger and stronger. The rule of Leopoldo O'Donnell was marked in 1844 by a cruel and bloody persecution of negroes for a supposed plot of servile war; O'Donnell's actions being partly due to the inquietude that had prevailed for some years over the supposed machinations of English abolitionists and even of English official residents in the island, and also over the mutual jealousies and supposed annexation ambitions of Great Britain and the United States.

A Cuban international question had arisen before 1820. Spain, the United States, England, France, Colombia and Mexico were all involved in it, the first four continually. In the eighteen-fifties a strong pro-slavery interest in the United States advocated the acquisition of the island. One feature of this was the "Ostend Manifesto" (see BUCHANAN, JAMES), in which the ministers of the United States at London, Paris and Madrid declared that if Spain refused a money offer for the colony the United States should seize it. Their government gave this document publicity. The Cuban policy of Presidents Pierce and Buchanan (during 1853-1861) was vainly directed to acquiring the island. From 1849 to 1851 there were three abortive filibustering expeditions from the United States, two being under a Spanish general, Narciso Lopez (1798-1851). The domestic problem, the problem of discontent in the island, had become acute by 1850, and from this time on to 1868 the years were full of conflict between liberal and reactionary sentiment in the colony, centreing about the asserted connivance of the captains-general in the illegal slave trade (declared illegal after 1820 by the treaties of 1817 and 1835 between Great Britain and Spain), the notorious immorality and prodigal wastefulness of the government, and the selfish exploitation of the colony by Spaniards and the Spanish government. From early in the 19th century there had always been separatists, reformists and repressionists in the island, but they were individuals rather than groups. The last were peninsulars, the others mainly creoles, and among the wealthy classes of the latter the separatists gradually gained increasing support.

An ineffective and extremely corrupt administration, a grave economic condition, new and heavy taxes, military repression, recurring heavy deficits in the budget, adding to a debt (about \$150,000,000 in 1868) already very large and burdensome, and the complete fiasco of the *junta* of inquiry of Cuban and Porto Rican representatives which met in Madrid in 1866-1867—all were important influences favouring the outbreak of the Ten Years' War. Among those who waged the war were men who fought to compel reforms, others who fought for annexation to the United States, others who fought for independence. The reformists demanded, besides the correction of the above evils, action against slavery, assimilation of rights between peninsulars and creoles and the practical recognition of equality, e.g. in the matter of office-holding, a grievance centuries old in Cuba as in other Spanish colonies, and guarantees of personal liberties. The separatists, headed by Carlos Manuel de Céspedes (1819-1874), a wealthy planter who proclaimed the revolution at Yara on the 10th of October, demanded the same reforms, including gradual emancipation of the slaves with indemnity to owners, and the grant of free and universal suffrage. War was confined throughout the ten years almost wholly to the E. provinces. The policy of successive captains-general was alternately uncompromisingly repressive and conciliatory. The Spanish volunteers committed horrible excesses in Havana and other places; the rebels also burned and killed indiscriminately, and the war became increasingly cruel and sanguinary. Intervention by the United States seemed probable, but did not come, and after alternations in the fortunes of war, Martínez Campos in January 1878 secured the acceptance by the rebels of the convention (*pacto*) of Zanjón, which promised amnesty for the war, liberty to slaves in the rebel ranks, the abolition of slavery, reforms in government, and colonial autonomy. A small rising after peace (the "Little War" of 1879-1880) was easily repressed. Gradual abolition of slavery was declared by a law of the 13th of February 1880; definitive abolition in 1886; and in 1893 the equal civil status of blacks and whites in all respects was proclaimed by General Calleja. There is no more evidence to warrant the wholly erroneous statement sometimes made that emancipation was an economic set-back to Cuba than could be gathered to support a similar statement regarding the United States. Coolie importation from China had been stopped in 1871.

As for autonomy and political reforms it has already been remarked that the change from the old régime was only superficial. The Spanish constitution of 1876 was proclaimed in Cuba in 1881. In 1878-1895 political parties had a complex development. The Liberal party was of growing radicalism, the Union Constitutional party of growing conservatism; and after 1893 a Reformist party was launched that drew the compromisers and the waverers. The demands of the Liberals were as in 1868; those for personal and property rights were much more definitely stated, and among explicit reforms demanded were the separation of civil and military power, general recognition of administrative responsibility under a colonial autonomous constitutional régime; also among economic matters, customs reforms and reciprocity with the United States were demanded. As for the representation accorded Cuba in the Spanish Cortes, as a rule about a quarter of her deputies were Cuban-born, and the choice of only a few autonomists was allowed by those who controlled the elections. Reciprocity with the United States was in force from 1891 to 1894 and was extremely beneficial to Cuba. Its cessation greatly increased disaffection.

Discontent grew, and another war was prepared for. On the 23rd of February 1895 General Calleja suspended the constitutional guarantees. The leading chiefs of the Ten Years' War took the field again—Máximo Gómez, Antonio Macéó, José Martí, Calixto García and others. Unlike that war, this was carried to the western provinces, and indeed was fiercest there. Among the military means adopted by the Spaniards to isolate their foe were "trochas" (*i.e.* entrenchments, barbed wire fences, and lines of block-houses) across the narrow parts of

the island, and "reconcentraci6n" of non-combatants in camps guarded by the Spanish forces. The latter measure produced extreme suffering and much starvation (as the reconcentrados were largely thrown upon the charity of the beggared communities in which they were huddled). In October 1897 the Spanish premier, P. M. Sagasta, announced the policy of autonomy, and the new dispensation was proclaimed in Cuba in December. But again all final authority was reserved to the captain-general. The system was never to have a practical trial, although a full government was quickly organized under it. The American people had sent food to the reconcentrados; President McKinley, while opposing recognition of the rebels, affirmed the possibility of intervention; Spain resented this attitude; and finally, in February 1898, the United States battleship "Maine" was blown up—by whom will probably never be known—in the harbour of Havana.

On the 20th of April the United States demanded the withdrawal of Spanish troops from the island. War followed immediately. A fine Spanish squadron seeking to escape from Santiago harbour was utterly destroyed by the American blockading force on the 3rd of July; Santiago was invested by land forces, and on the 15th of July the city surrendered. Other operations in Cuba were slight. By the treaty of Paris, signed on the 10th of December, Spain "relinquished" the island to the United States in trust for its inhabitants; the temporary character of American occupation being recognized throughout the treaty, in accord with the terms of the American declaration of war, in which the United States disclaimed any intention to control the island except for its pacification, and expressed the determination to leave the island thereupon to the control of its people. Spanish authority ceased on the 1st of January 1899, and was followed by American "military" rule (January 1, 1899-May 20, 1902). During these three years the great majority of offices were filled by Cubans, and the government was made as different as possible from the military control to which the colony had been accustomed. Very much was done for public works, sanitation, the reform of administration, civil service and education. Most notable of all, yellow fever was eradicated where it had been endemic for centuries. A constitutional convention sat at Havana from the 5th of November 1900 to the 21st of February 1901. The provisions of the document thus formed have already been referred to. In the determination of the relations that should subsist between the new republic and the United States certain definite conditions known as the Platt Amendment were finally imposed by the United States, and accepted by Cuba (12th of June 1901) as a part of her constitution. By these Cuba was bound not to incur debts her current revenues will not bear; to continue the sanitary administration undertaken by the military government of intervention; to lease naval stations (since located at Bahía Honda and Guantánamo) to the United States; and finally, the right of the United States to intervene, if necessary, in the affairs of the island was explicitly affirmed in the provision, "That the government of Cuba consents that the United States may exercise the right to intervene for the protection of Cuban independence, the maintenance of a government adequate for the protection of life, property and individual liberty, and for discharging the obligations with respect to Cuba imposed by the treaty of Paris on the United States, now to be assumed and undertaken by the government of Cuba." The status thus created is very exceptional in the history of international relations. The status of the Isle of Pines was left an open question by the treaty of Paris, but a decision of the Supreme Court of the United States has declared it (in a question of customs duties) to be a part of Cuba, and though a treaty to the same end did not secure ratification (1908) by the United States Senate, repeated efforts by American residents thereon to secure annexation to the United States were ignored by the United States government.

The first Cuban congress met on the 5th of May 1902, prepared to take over the government from the American military authorities, which it did on the 20th of May. Tomás Estrada Palma (1835-1908) became the first president of the Republic.

In material prosperity the progress of the island from 1902 to 1906 was very great; but in its politics, various social and economic elements, and political habits and examples of Spanish provenience that ill befitted a democracy, led once more to revolution. Congress neglected to pass certain laws which were required by the constitution, and which, as regards municipal autonomy, independence of the judiciary, and congressional representation of minority parties, were intended to make impossible the abuses of centralized government that had characterized Spanish administration. Political parties were forming without very evident basis for differences outside questions of political patronage and the good or ill use of power; and, in the absence of the laws just mentioned, the Moderates, being in power, used every instrument of government to strengthen their hold on office. The preliminaries of the elections of December 1905 and March 1906 being marked by frauds and injustice, the Liberals deserted the polls at those elections, and instead of appealing to judicial tribunals controlled by the Moderates, issued a manifesto of revolution on the 28th of July 1906.<sup>1</sup> This insurrection rapidly assumed large proportions. The government was weak and lacked moral support in the whole island. After repeated petitions from President Palma for intervention by the United States, commissioners (William H. Taft, Secretary of War, and Robert Bacon, Acting Secretary of State) were sent from Washington to act as peace mediators.

All possible efforts to secure a compromise that would preserve the Republic failed. The president resigned (on the 28th of September), Congress dispersed without choosing a successor, and as an alternative to anarchy the United States was compelled to proclaim on the 29th of September 1906 a provisional government,—to last "long enough to restore order and peace and public confidence," and hold new elections. The insurrectionists promptly disbanded. Government was maintained under the Cuban flag,—the diplomatic and consular relations with even the United States remaining in outward forms unchanged; and the regular forms of the constitution were scrupulously maintained so far as possible. No use was made of American military force save as a passive background to the government. The government of intervention at first directed its main effort simply to holding the country together, without undertaking much that could divide public opinion or seem of unpalatably foreign impulse; and later to the establishment of a few fundamental laws which, when intervention ceased, should give greater simplicity, strength and stability to a new native government. These laws strictly defined the powers of the president; more clearly separated the executive departments, so as to lessen friction and jealousies; reformed the courts; reformed administrative routine; and increased the strength of the provinces at the expense of the municipalities. On the 28th of January 1909 the American administration ceased, and the Republic was a second time inaugurated, with General José Miguel Gomez (b. 1856), the leader of the Miguelista faction of the Liberal party, as president, and Alfredo Zayas, the leader of the Zayista faction of the same party, as vice-president. The last American troops were withdrawn from the island on the 1st of April 1909.

**AUTHORITIES.—General Description.**—There is no trustworthy recent description. The best books are E. Pecharo, *Geografía de la isla de Cuba* (4 tom., Havana, 1854); M. Rodríguez-Ferrer, *Naturaleza y civilización de . . . Cuba*, vol. i. (Madrid, 1876). See also *United States Geological Survey, Bulletin 192* (1902), H. Gannett, "A Gazetteer of Cuba." Of general descriptions in English, in addition to travels cited below, may be cited R. T. Hill, *Cuba and Porto Rico with the other West Indies* (New York, 1898).

**Fauna and Flora.**—A. H. R. Grisebach, *Catalogus plantarum Cubensium* (Leipzig, 1866), and F. A. Sauvalle, *Flora Cubana: revisio catalogi Grisebachiani* (Havana, 1868); and *Flora Cubana: enumeratio nova plantarum Cubensium* (Havana, 1873); F. Poey et al., *Repertorio físico-natural de la isla de Cuba* (2 vols., Havana, 1865-1868), and F. Poey, *Memorias sobre la historia natural de . . . Cuba* (3 tom., Havana, 1851-1860); Ramon de la Sagra, with many collaborators, *Historia física, política y natural de . . . Cuba* (Paris, 1842-1851, 12 vols.; issued also in French; vols. 3-12 being the

"Historia Natural"); *Anales of the Academia de Ciencias* (Havana, 1863- . . . annual); M. Gomez de la Maza, *Flora Habanera* (Havana, 1897); S. A. de Morales, *Flora arborícola de Cuba aplicada* (Havana, 1887, only part published); D. H. Seguí, *Ojeado sobre la flora médica y tóxica de Cuba* (Havana, 1900); J. Gundlach, *Contribucion a la entomología Cubana* (Havana, 1881); J. M. Fernandez y Jimenez, *Tratado de la arboricultura Cubana* (Havana, 1867).

**Geology and Minerals.**—M. F. de Castro, "Pruebas paleontológicas de que la isla de Cuba ha estado unida al continente americano y breve idea de su constitucion geologica," *Bol. Com. Mapa Geol. de Esp.* vol. viii. (1881), pp. 357-372; M. F. de Castro and P. Salterain y Legarra, "Croquis geologico de la isla de Cuba," *ibid.* vol. viii. pl. vi. (published with vol. xi., 1884). Many articles in *Anales of the Academy*; also, R. T. Hill in *Harvard College Museum of Comparative Zoology, Bulletin*, vol. 16, pp. 243-288 (1895); *United States Geological Survey, 22nd Annual Report, 1901*, C. W. Hayes et al., "Geological Reconnaissance of Cuba"; *Civil Report of General Leonard Wood, governor of Cuba* (1902), vol. v., H. C. Brown, "Report on Mineral Resources of Cuba."

**Climate.**—See the *Boletín Oficial de la Secretaria de Agricultura*, and publications of the observatory of Havana. **Sanitation.**—For conditions 1899-1902, see *Civil Reports* of American military governors. For conditions since 1902 consult the *Informe Mensual* (1903- . . .) of the Junta Superior de Sanidad.

**Agriculture.**—Consult the *Boletín* above mentioned, publications of the Estacion Central Agronómica, and current statistical serial reports of the treasury department (Hacienda) on natural resources, live-stock interests, the sugar industry (annual), &c.

**Industries, Commerce, Communications.**—See the works of Sagra and Pezuela. For conditions about 1899 consult R. P. Porter (Special Commissioner of the United States government), *Industrial Cuba* (New York, 1899); W. J. Clark, *Commercial Cuba* (New York, 1898); reports of foreign consular agents in Cuba; and the statistical annuals of the Hacienda on foreign commerce and railways.

**Population.**—The early censuses were extremely unreliable. Illuminating discussions of them can be found in Humboldt's *Essay*, Saco's *Papeles* and Pezuela's *Diccionario*. See *United States Department of War, Report on the Census of Cuba 1899* (Washington, 1899); *U. S. Bureau of the Census, Cuba: Population, History and Resources, 1907* (1909).

**Education.**—See *Civil Reports* of the American military government, 1899-1902; United States commissioner of education, *Report, 1897-1898*; current reports in *Informe del superintendente de escuelas de Cuba . . .* (Havana, 1903- . . .). On Letters and Culture.—E. Pecharo y Tapia, *Diccionario . . . de voces Cubanas* (Havana, 1856, 4th ed., 1875; all editions with many errors); Antonio Bachiller y Morales, *Apuntes para la historia de las letras y de la instrucción pública de Cuba* (3 tom., Havana, 1859-1861); J. M. Mestre, *De la filosofía en la Habana* (Havana, 1862); A. Mitjana, *Estudio sobre el movimiento científico y literario de Cuba* (Havana, 1890); biographies of Varela and Luz Caballero by Rodriguez (see below); files of *La Revista de Cuba* (16 vols., Havana, 1877-1884) and *La Revista Cubana* (21 vols., Havana, 1885-1895). The literature of TRAVEL is rich. It suffices to mention *Letters from the Havannah*, by the English consul (London, 1821); E. M. Masse, *L'île de Cuba* (Paris, 1825); D. Turnbull, *Travels in the West* (London, 1840), and R. R. Madden, *The Island of Cuba* (London, 1853)—two very important books regarding slavery; J. B. Rosemond de Beauvallon, *L'île de Cuba* (Paris, 1844); J. G. Taylor, *The United States and Cuba* (London, 1851); F. Bremer, *The Homes of the New World* (2 vols., New York, 1853); M. M. Ballou, *History of Cuba, or Notes of a Traveller* (Boston, 1854); R. H. Dana, *To Cuba and Back* (Boston, 1859); J. von Sivers, *Die Perle der Antillen* (Leipzig, 1861); A. C. N. Gallenga, *The Pearl of the Antilles* (London, 1873); S. Hazard, *Cuba with Pen and Pencil* (Hartford, Conn., 1873); H. Piron, *L'île de Cuba* (Paris, 1876). Of later books, F. Matthews, *The New-Born Cuba* (New York, 1899); R. Davey, *Cuba Past and Present* (London, 1898). Among the writers who have left short impressions are A. Granier de Cassagnac (1844), J. J. A. Ampère (1855), A. Trollope (1860), J. A. Froude (1888).

**Administration.**—Consult the literature of history and colonial reform given below. Also: Leandro Garcia y Gragitena, *Guia del empleado de hacienda* (Havana, 1860), with very valuable historical data; Carlos de Sedano y Cruzat, *Cuba desde 1850 à 1873. Coleccion de informes, memorias, proyectos y antecedentes sobre el gobierno de la isla de Cuba* (Madrid, 1875); Vicente Vasquez Queipo, *Informe fiscal sobre fomento de la poblacion blanca* (Madrid, 1845); *Informacion sobre reformas en Cuba y Puerto Rico celebrada en Madrid en 1866 y 67 por los representantes de ambas islas* (2 tom., New York, 1867; 2nd ed., New York, 1877); and the *Diccionario* of Pezuela. These, with the works of Saco, Sagra, Arango and Alexander von Humboldt's work, *Essai politique sur l'île de Cuba* (2 vols., Paris 1826; Spanish editions, 1 vol., Paris, 1827 and 1840; English translation by J. S. Thrasher, with interpolations, New York, 1856), are indispensable. For conditions at the end of the 18th century, Fran. de Arango y Parreño, *Obras* (2 tom., Havana, 1888). For later conditions, E. Valdes Dominguez, *Los Antiguos Diputados de Cuba* (Havana, 1879); B. Huber, *Aperçu statistique de l'île de Cuba* (Paris, 1826); Humboldt; Sagra, vols. 1-2 of the book cited above,

<sup>1</sup> In the preliminary registration by Moderate officials a total electorate was registered of 432,313,—about 30% of the supposed population of the island.



being the *Historia física y política*, and also the earlier work on which they are based, *Historia económica-política y estadística de Cuba* (Havana, 1831); treatises on administrative law in Cuba by J. M. Morilla (Havana, 1847; 2nd ed., 1865, 2 vols.) and A. Govin (3 vols., Havana, 1882-1883); A. S. Rowan and M. M. Ramsay, *The Island of Cuba* (New York, 1896); *Colección de reales ordenes, decretos y disposiciones* (Havana, serial, 1857-1898); *Spanish Rule in Cuba. Laws Governing the Island. Reviews Published by the Colonial Office in Madrid* . . . (New York, for the Spanish legation, 1896); and compilations of Spanish colonial laws listed under article INDIES, LAWS OF THE. On the new Republican régime: *Gaceta Oficial* (Havana, 1903- ); reports of departments of government; M. Romero Palafox, *Agenda de la república de Cuba* (Havana, 1905). See also the *Civil Reports* of the United States military governors, J. R. Brooke (2 vols., 1899; Havana and Washington, 1900), L. Wood (33 vols., 1900-1902; Washington, 1901-1902).

**History.**—The works (see above) of Sagra, Humboldt and Arango are indispensable; also those of Francisco Calcagno, *Diccionario biográfico Cubano* (ostensibly, New York, 1878); Vidal Morales y Morales, *Iniciadores y primeros mártires de la revolución Cubana* (Havana, 1901); José Ahumada y Centurión, *Memoria histórica política de Cuba* (Havana, 1874); Jacobo de la Pezuela, *Diccionario geográfico-estadístico-histórico de Cuba* (4 tom., Madrid, 1863-1866); *Historia de Cuba*, (4 tom., Madrid, 1868-1878; supplanting his *Ensayo histórico de Cuba*, Madrid and New York, 1842); and José Antonio Saco, *Obras* (2 vols., New York, 1853), *Papeles* (3 tom., Paris, 1858-1859), and *Colección postuma de Papeles* (Havana, 1881). Also: Rodríguez Ferrer, *op. cit.* above, vol. 2 (Madrid, 1888); P. G. Guitéras, *Historia de Cuba* (2 vols., New York, 1865-1866). Of great value is J. Zaragoza, *Las Insurrecciones en Cuba. Apuntes para la historia política* (2 tom., Madrid, 1872-1873); also J. I. Rodríguez, *Vida de Félix Varela* (New York, 1878), and *Vida de D. José de la Luz* (New York, 1874; 2nd ed., 1879). On early history see *Colección de documentos inéditos relativos al descubrimiento de ultramar* (series 2, vols. 1, 4, 6, Madrid, 1885-1890). On archaeology, N. Fort y Roldan, *Cuba indígena* (Madrid, 1881); M. Rodríguez Ferrer (see above); and especially A. Bachiller y Morales, *Cuba primitiva* (Havana, 1883). For the history of the Cuban international problem consult José Ignacio Rodríguez, *Idea de la anexión de la isla de Cuba a los Estados Unidos de América* (Havana, 1900), and J. M. Callahan, *Cuba and International Relations* (Johns Hopkins University, Baltimore, 1898), which supplement each other. On the domestic reform problem there is an enormous literature, from which may be selected (see general histories above and works cited under § Administration of this bibliography): M. Torrente, *Bosquejo económico-político* (2 tom., Madrid-Havana, 1852-1853); D. A. Galiano, *Cuba en 1858* (Madrid, 1859); José de la Concha, twice Captain-General of Cuba, *Memorias sobre el estado político, gobierno y administración de Cuba* (Madrid, 1853); A. Lopez de Letona, *Isla de Cuba, reflexiones* (Madrid, 1856); F. A. Conte, *Aspiraciones del partido liberal de Cuba* (Havana, 1892); P. Vallente, *Réformes dans les îles de Cuba et de Porto Rico* (Paris, 1869); C. de Sedano, *Cuba: Estudios políticos* (Madrid, 1872); H. H. S. Aimes, *History of Slavery in Cuba, 1511-1868* (New York, 1907); F. Armas y Céspedes, *De la esclavitud en Cuba* (Madrid, 1866), and *Régimen político de las Antillas Españolas* (Palma, 1882); R. Cabrera, *Cuba y sus Jueces* (Havana, 1887; 9th ed., Philadelphia, 1895; 8th ed., in English, *Cuba and the Cubans*, Philadelphia, 1896); P. de Alzola y Minondo, *El Problema Cubano* (Bilbao, 1898); various works by R. M. de Labra, including *La Cuestión social en las Antillas Españolas* (Madrid, 1874), *Sistemas coloniales* (Madrid, 1874), &c.; R. Montoro, *Discursos* . . . 1878-1893 (Philadelphia, 1894); Labra *et al.*, *El Problema colonial contemporánea* (2 vols., Madrid, 1894); articles by Em. Castelar *et al.*, in Spanish reviews (1895-1898). On the period since 1899 the best two books in English are C. M. Pepper, *To-morrow in Cuba* (New York, 1899); A. G. Robinson, *Cuba and the Intervention* (New York, 1905). (F. S. P.)

**CUBE** (Gr. κύβος, a cube), in geometry, a solid bounded by six equal squares, so placed that the angle between any pair of adjacent faces is a right angle. This solid played an all-important part in the geometry and cosmology of the Greeks. Plato (*Timæus*) described the figure in the following terms:—"The isosceles triangle which has its vertical angle a right angle . . . combined in sets of four, with the right angles meeting at the centre, form a single square. Six of these squares joined together formed eight solid angles, each produced by three plane right angles: and the shape of the body thus formed was cubical, having six square planes for its surfaces." In his cosmology Plato assigned this solid to "earth," for "earth" is the least mobile of the four elements—"fire," "water," "air" and "earth" and most plastic of bodies: and that substance must possess this nature in the highest degree which has its bases most stable." The mensuration of the cube, and its relations to other geometrical

solids are treated in the article POLYHEDRON; in the same article are treated the Archimedean solids, the truncated and snub-cube; reference should be made to the article CRYSTALLOGRAPHY for its significance as a crystal form.

A famous problem concerning the cube, namely, to construct a cube of twice the volume of a given cube, was attacked with great vigour by the Pythagoreans, Sophists and Platonists. It became known as the "Delian problem" or the "problem of the duplication of the cube," and ranks in historical importance with the problems of "trisecting an angle" and "squaring the circle." The origin of the problem is open to conjecture. The Pythagorean discovery of "squaring a square," *i.e.* constructing a square of twice the area of a given square (which follows as a corollary to the Pythagorean property of a right-angled triangle, *viz.* the square of the hypotenuse equals the sum of the squares on the sides), may have suggested the strictly analogous problem of doubling a cube. Eratosthenes (*c.* 200 B.C.), however, gives a picturesque origin to the problem. In a letter to Ptolemy Euergetes he narrates the history of the problem. The Delians, suffering a dire pestilence, consulted their oracles, and were ordered to double the volume of the altar to their tutelary god, Apollo. An altar was built having an edge double the length of the original; but the plague was unabated, the oracles not having been obeyed. The error was discovered, and the Delians applied to Plato for his advice, and Plato referred them to Eudoxus. This story is mere fable, for the problem is far older than Plato.

Hippocrates of Chios (*c.* 430 B.C.), the discoverer of the square of a lune, showed that the problem reduced to the determination of two mean proportionals between two given lines, one of them being twice the length of the other. Algebraically expressed, if  $x$  and  $y$  be the required mean proportionals and  $a$ ,  $2a$ , the lines, we have  $a : x :: x : y :: y : 2a$ , from which it follows that  $x^3 = 2a^3$ . Although Hippocrates could not determine the proportionals, his statement of the problem in this form was a great advance, for it was perceived that the problem of trisecting an angle was reducible to a similar form which, in the language of algebraic geometry, is to solve geometrically a cubic equation. According to Proclus, a man named Hippias, probably Hippias of Elis (*c.* 460 B.C.), trisected an angle with a mechanical curve, named the quadratrix (*q.v.*). Archytas of Tarentum (*c.* 430 B.C.) solved the problems by means of sections of a half cylinder; according to Eutocius, Menaechmus solved them by means of the intersections of conic sections; and Eudoxus also gave a solution.

All these solutions were condemned by Plato on the ground that they were mechanical and not geometrical, *i.e.* they were not effected by means of circles and lines. However, no proper geometrical solution, in Plato's sense, was obtained; in fact it is now generally agreed that, with such a restriction, the problem is insoluble. The pursuit of mechanical methods furnished a stimulus to the study of mechanical loci, for example, the locus of a point carried on a rod which is caused to move according to a definite rule. Thus Nicomedes invented the conchoid (*q.v.*); Diocles the cissoid (*q.v.*); Dinostratus studied the quadratrix invented by Hippias; all these curves furnished solutions, as is also the case with the trisectrix, a special form of Pascal's limaçon (*q.v.*). These problems were also attacked by the Arabian mathematicians; Tobit ben Korra (836-901) is credited with a solution, while Abul Gud solved it by means of a parabola and an equilateral hyperbola.

In algebra, the "cube" of a quantity is the quantity multiplied by itself twice, *i.e.* if  $a$  be the quantity  $a \times a \times a (= a^3)$  is its cube. Similarly the "cube root" of a quantity is another quantity which when multiplied by itself twice gives the original quantity; thus  $a^3$  is the cube root of  $a$  (see ARITHMETIC and ALGEBRA). A "cubic equation" is one in which the highest power of the unknown is the cube (see EQUATION); similarly, a "cubic curve" has an equation containing no term of a power higher than the third, the powers of a compound term being added together.

In mensuration, "cubature" is sometimes used to denote the volume of a solid; the word is parallel with "quadrature," to determine the area of a surface (see MENSURATION; INFINITESIMAL CALCULUS).

**CUBEBS** (Arab. *kabābah*), the fruit of several species of pepper (*Piper*), belonging to the natural order Piperaceae. The cubebs of pharmacy are produced by *Piper Cubeba*, a climbing woody shrub indigenous to south Borneo, Sumatra, Prince of Wales Island and Java. It has round, ash-coloured, smooth branches; lanceolate, or ovate-oblong, somewhat leathery, shining leaves, 4 to 6½ in. long and 1½ to 2 in. broad. Male and female flowers are borne on distinct plants. The fruits are small, globose, about ½ in. in diameter, and not so large as white pepper; their contracted stalk-like bases are between ¼ and ½ in. in length; and from forty to fifty of them are borne upon a common stem. The cubeb is cultivated in Java and Sumatra, the fruits are gathered before they are ripe, and carefully dried. Commercial cubebs consist of the dried berries, usually with their stalks attached; the pericarp is greyish-brown, or blackish and wrinkled; and the seed, when present, is hard, white and oily. The odour of cubebs is agreeable and aromatic; the taste, pungent, acrid, slightly bitter and persistent. About 15% of a volatile oil is obtained by distilling cubebs with water; after rectification with water, or on keeping, this deposits rhombic crystals of camphor of cubebs, C<sub>15</sub>H<sub>26</sub>O; cubebene, the liquid portion, has the formula C<sub>15</sub>H<sub>24</sub>. Cubebin, CH<sub>2</sub>[O]<sub>2</sub>C<sub>6</sub>H<sub>5</sub>·CH:CH·CH<sub>2</sub>OH, is a crystalline substance existing in cubebs, discovered by Eugène Soubeiran and Capitaine in 1839; it may be prepared from cubebene, or from the pulp left after the distillation of the oil. The drug, along with gum, fatty oils, and malates of magnesium and calcium, contains also about 1% of cubebic acid, and about 6% of a resin.

The dose of the fruit is 30 to 60 grains, and the British Pharmacopoeia contains a tincture with a dose of ½ to 1 drachm. The volatile oil—oleum cubebae—is also official, and is the form in which this drug is most commonly used, the dose being 5 to 20 minims, which may be suspended in mucilage or given after meals in a cachet. The drug has the typical actions of a volatile oil, but exerts some of them in an exceptional degree. Thus it is liable to cause a cutaneous erythema in the course of its excretion by the skin; it has a marked diuretic action; and it is a fairly efficient disinfectant of the urinary passages. Its administration causes the appearance in the urine of a salt of cubebic acid which is precipitated by heat or nitric acid, and is therefore liable to be mistaken for albumin, when these two most common tests for the occurrence of albuminuria are applied. Cubebs is frequently used in the form of cigarettes for asthma, chronic pharyngitis and hay-fever. A small percentage of cubebs is also commonly included in lozenges designed for use in bronchitis, in which the antiseptic and expectorant properties of the drug are useful. But the most important therapeutic application of this drug is in gonorrhoea, where its antiseptic action is of much value. As compared with copaiba in this connexion cubebs has the advantages of being less disagreeable to take and somewhat less likely to disturb the digestive apparatus in prolonged administration. The introduction of the drug into medicine is supposed to have been due to the Arabian physicians in the middle ages. Cubebs were formerly candied and eaten whole, or used ground as a seasoning for meat. Their modern employment in England as a drug dates from 1815. "Cubebae" were purchased in 1284 and 1285 by Lord Clare at 2s. 3d. and 2s. 9d. per lb respectively; and in 1307 1 lb for the king's wardrobe cost 9s., a sum representing about £3, 12s. in present value (Rogers, *Hist. of Agriculture and Prices*, i. 627-628, ii. 544).

A closely allied species, *Piper Clusii*, produces the African cubebs or West African black-pepper, the berry of which is smoother than that of common cubebs and usually has a curved pedicel. In the 14th century it was imported into Europe from the Grain Coast, under the name of pepper, by merchants of Rouen and Lippe.

**CUBICLE** (Lat. *cubiculum*), a small chamber containing a couch or a bed. The small rooms opening into the atrium of a Pompeian house are known as cubacula. In modern English schools "cubicle" is the term given to the separate small bedrooms into which the dormitories are divided, as opposed to the system of large open dormitories.

**CUBITT, THOMAS** (1788-1855), English builder, was born at Buxton, near Norwich, on the 25th of February 1788. Few men have exhibited greater self-reliance in early life in the pursuit of a successful career. In his nineteenth year, when he was working as a journeyman carpenter, his father died, and he tried to better his position by going on a voyage to India, as captain's joiner. He returned to London, two years after, in the possession of a small capital, and began business as a carpenter. The growth of his establishment was steady and rapid. He was one of the first to combine several trades in a "builder's" business; and this very much increased his success. One of the earlier works which gave him reputation was the London Institution in Finsbury Circus; but it is from 1824 that the vast building operations date which identify his name with many splendid ranges of London houses, such as Tavistock, Gordon, Belgrave and Lowndes Squares, and the district of South Belgravia. While these and similar extensive operations were in progress, a financial panic, which proved ruinous to many, was surmounted in his case by a determined spirit and his integrity of character. He took great interest in sanitary measures, and published, for private circulation, a pamphlet on the general drainage of London, the substance of which was afterwards embodied in a letter to *The Times*; the plan he advocated was subsequently adopted by the conveyance of the sewage matter some distance below London. He advocated the provision of open spaces in the environs of London as places of public recreation, and was one of the originators of Battersea Park, the first of the people's parks. At a late period he received professionally the recognition of royalty, the palace at Osborne being erected after his designs, and under his superintendence; and in the *Life of the Prince Consort* he is described by Queen Victoria as one "than whom a better and kinder man did not exist." In 1851, although he was not identified with the management of the Great Exhibition, he showed the warmest sympathy with its objects, and aided its projectors in many ways, especially in the profitable investment of their surplus funds. Cubitt, when he rose to be a capitalist, never forgot the interests and well-being of his workpeople. He was elected president of the Builders' Society some time before his death, which took place at his seat Denbies, near Dorking, on the 20th of December 1855.

His son, George Cubitt (1828- ), who had a long and useful parliamentary career, as Conservative member for West Surrey (1860-1865) and Mid-Surrey (1885-1892), was in 1892 raised to the peerage as Baron Ashcombe.

**CUBITT, SIR WILLIAM** (1785-1861), English engineer, was born in 1785 at Dilham in Norfolk, where his father was a miller. After serving an apprenticeship of four years (1800-1804) as a joiner and cabinetmaker at Stalham, he became associated with an agricultural-machine maker, named Cook, who resided at Swanton. In 1807 he patented self-regulating sails for windmills, and in 1812 he entered the works of Messrs Ransome of Ipswich, where he soon became chief engineer, and ultimately a partner. Meanwhile, the subject of the employment of criminals had been much in his thoughts; and the result was his introduction of the treadmill about 1818. In 1826 he removed to London, where he gained a very large practice as a civil engineer. Among his works were the Oxford canal, the Birmingham & Liverpool Junction Canal, the improvement of the river Severn, the Bute docks at Cardiff, the Black Sluice drainage and its outfall sluice at Boston harbour, the Middlesborough docks and coal drops in the Tees, and the South-Eastern railway, of which he was chief engineer. The Hanoverian government consulted him about the harbour and docks at Harburg; the water-works of the city of Berlin were constructed under his immediate superintendence; he was asked to report on the construction of the Paris & Lyons railway; and he was consulting engineer for the line from Boulogne to Amiens. Among his later works were two floating landing stages at Liverpool, and the bridge for carrying the London turnpike across the Medway at Rochester. In 1851, when he was president of the Institution of Civil Engineers, he was knighted for his services in connexion with the buildings erected in Hyde Park for the exhibition of that year.

He retired from active work in 1858, and died on the 13th of October 1861 at his house on Clapham Common, London. His son, Joseph Cubitt (1811-1872), was trained under him, and was engineer of various railways, including the Great Northern, London, Chatham & Dover, and part of the London & South-Western.

**CUCULINN** (*Cuchulinn*; pronounced "Coohoollin"), the chief warrior in the Conchobar-Cuchulinn or older heroic (Ulster) cycle of Ireland. The story of his origin is very obscure. The god Lug is represented as having been swallowed in a draught of wine by his mother Dechtire, sister of Conchobar, who was king of Ulster. But it is not unlikely that this story was invented, to supersede the account of the incestuous union of Conchobar with his sister, which seems to be hinted at on various occasions. Usually, however, he is styled son of Sualdam, an Ulster warrior who plays a very inferior part in the cycle. His earliest name was Setanta, and he was brought up at Dun Imbrith (Louth). When he was six years of age he announced his intention of going to Conchobar's court at Emain Macha (Navan Rath near Armagh) to play with the boys there. He defeats all the boys in marvellous fashion and is received as one of their number. Shortly after he kills Culann, the smith's hound, a huge watch-dog. The smith laments that all his property is of no value now that his watchman is slain, whereupon the young hero offers to guard his domains until a whelp of the hound's has grown. From this the boy received the name of Cú Chulinn or Culann's Hound. The next year Cuchulinn receives arms, makes his first foray, and slays the three sons of Necht, redoubtable hereditary foes of the Ulstermen, in the plain of Meath. The men of Ulster decide that Cuchulinn must marry, as all the women of Ireland are in love with him. Chosen envoys fail to find a bride worthy of him after a year's search, but the hero goes straight to Emer, the daughter of Forgall the Wily, at Lusk (county Dublin). The lady is promised to him if he will go to learn chivalry of Domnall the Soldierly and the amazon Scathach in Alba. After enduring great hardships he goes through the course and leaves a son Connlaech behind in Scotland by another amazon, Aife. On his return he carries off and weds Emer. He is represented as living at Dun Delgan (Dundalk). The greatest of all the hero's achievements was the defence of the frontier of Ulster against the forces of Medb, queen of Connaught, who had come to carry off the famous Brown Bull of Cualnge (Cooley). The men of Ulster were all suffering from a strange debility, and Cuchulinn had to undertake the defence single-handed from November to February. This was when he was seventeen years of age. The cycle contains a large number of episodes, such as the gaining of the champion's portion and the tragical death by the warrior's hand of his own son Connlaech. When he was twenty-seven he met with his end at the hands of Lugaid, son of Cúrói MacDaire, the famous Munster warrior, and the children of Calatin Dána, in revenge for their father's death (see CELT: *Irish Literature*).

Medieval Christian synchronists make Cuchulinn's death take place about the beginning of the Christian era. It is not necessary to regard Cuchulinn as a form of the solar hero, as some writers have done. Most, if not all, of his wonderful attributes may be ascribed to the Irish predilection for the grotesque. It is true that Cuchulinn seems to stand in a special relation to the Tuatha De Danann leader, the god Lug, but in primitive societies there is always a tendency to ascribe a divine parentage to men who stand out pre-eminently in prowess beyond their fellows.

See A. Nutt, *Cuchulainn, the Irish Achilles* (London, 1900); E. Hull, *The Cuchulinn Saga* (London, 1898). (E. C. Q.)

**CUCKOO**, or CUCKOW, as the word was formerly spelt, the common name of a well-known and often-heard bird, the *Cuculus canorus* of Linnaeus. In some parts of the United Kingdom it is more frequently called gowk, and it is the Gr. *κόκκυξ*, the Ital. *cuculo* or *cucco*, the Fr. *coucou*, the Ger. *Kuckuk*, the Dutch *koekkoek*, the Dan. *kukker* or *gjög*, and the Swed. *gök*. The oldest English spelling of the name seems to have been *cuccu*.

No single bird has perhaps so much occupied the attention

both of naturalists and of those who are not naturalists, or has had so much written about it, as the common cuckoo, and of no bird perhaps have more idle tales been told. Its strange and, according to the experience of most people, its singular habit of entrusting its offspring to foster-parents is enough to account for much of the interest which has been so long felt in its history; but this habit is shared probably by many of its Old World relatives, as well as in the New World by birds which are not in any degree related to it. The cuckoo is a summer visitant to the whole of Europe, reaching even far within the Arctic circle, and crossing the Mediterranean from its winter quarters in Africa at the end of March or beginning of April. Its arrival is at once proclaimed by the peculiar and in nearly all languages onomatopoeic cry of the cock—a true song in the technical sense of the word, since it is confined to the male sex and to the season of love. In a few days the cock is followed by the hen, and amorous contests between keen and loud-voiced suitors are to be commonly noticed, until the respective pretensions of the rivals are decided. Even by night they are not silent; but as the season advances the song is less frequently heard, and the cuckoo seems rather to avoid observation as much as possible, the more so since whenever it shows itself it is a signal for all the small birds of the neighbourhood to be up in its pursuit, just as though it were a hawk, to which indeed its mode of flight and general appearance give it an undoubted resemblance—a resemblance that misleads some into confounding it with the birds of prey, instead of recognizing it as a harmless if not a beneficial destroyer of hairy caterpillars. Thus pass away some weeks. Towards the middle or end of June its "plain-song" cry alters; it becomes rather hoarser in tone, and its first syllable or note is doubled. Soon after it is no longer heard at all, and by the middle of July an old cuckoo is seldom to be found in the British Islands, though a stray example, or even, but very rarely, two or three in company, may occasionally be seen for a month longer. Of its breeding comparatively few have any personal experience. Yet a diligent search for and peering into the nests of several of the commonest little birds—more especially the pied wagtail (*Motacilla lugubris*), the titlark (*Anthus pratensis*), the reed-wren (*Acrocephalus streperus*), and the hedge-sparrow (*Accentor modularis*)—will be rewarded by the discovery of the egg of the mysterious stranger which has been surreptitiously introduced, and those who wait till this egg is hatched may be witnesses (as was Edward Jenner in the 18th century) of the murderous eviction of the rightful tenants of the nest by the intruder, who, hoisting them one after another on his broad back, heaves them over to die neglected by their own parents, of whose solicitous care he thus becomes the only object. In this manner he thrives, and, so long as he remains in the country of his birth his wants are anxiously supplied by the victims of his mother's dupery. The actions of his foster-parents become, when he is full grown, almost ludicrous, for they often have to perch between his shoulders to place in his gaping mouth the delicate morsels he is too indolent or too stupid to take from their bills. Early in September he begins to shift for himself, and then follows the seniors of his kin to more southern climes.

So much caution is used by the hen cuckoo in choosing a nest in which to deposit her egg that the act of insertion has been but seldom witnessed. The nest selected is moreover often so situated, or so built, that it would be an absolute impossibility for a bird of her size to lay her egg therein by sitting upon the fabric as birds commonly do; and there have been a few fortunate observers who have actually seen the deposition of the egg upon the ground by the cuckoo, who, then taking it in her bill, introduces it into the nest. Of these, the earliest in Great Britain seem to have been two Scottish lads, sons of Mr Tripeny, a farmer in Coxmuir, who, as recorded by Macgillivray (*Brit. Birds*, iii. 130, 131) from information communicated to him by Mr Durham Weir, saw most part of the operation performed, June 24, 1838. But perhaps the most satisfactory evidence on the point is that of Adolf Müller, a forester at Gladenbach in Darmstadt, who says (*Zoolog. Garten*, 1866, pp. 374, 375) that through a telescope he watched a cuckoo as she laid her egg on a

bank, and then conveyed the egg in her bill to a wagtail's nest. Cuckoos, too, have been not unfrequently shot as they were carrying a cuckoo's egg, presumably their own, in their bill, and this has probably given rise to the vulgar, but seemingly groundless, belief that they suck the eggs of other kinds of birds. More than this, Mr G. D. Rowley, who had much experience of cuckoos, declares (*Ibis*, 1865, p. 186) his opinion to be that traces of violence and of a scuffle between the intruder and the owners of the nest at the time of introducing the egg often appear, whence we are led to suppose that the cuckoo ordinarily, when inserting her egg, excites the fury (already stimulated by her hawk-like appearance) of the owners of the nest by turning out one or more of the eggs that may be already laid therein, and thus induces the dupe to brood all the more readily and more strongly what is left to her. Of the assertion that the cuckoo herself takes any interest in the future welfare of the egg she has foisted on her victim, or of its product, there is no good evidence.

But a much more curious assertion has also been made, and one that at first sight appears so incomprehensible as to cause little surprise at the neglect it long encountered. To this currency was first given by Salerne (*L'Hist. nat. &c.*, Paris, 1767, p. 42), who was, however, hardly a believer in it, and it is to the effect, as he was told by an inhabitant of Sologne, that the egg of a cuckoo resembles in colour that of the eggs normally laid by the kind of bird in whose nest it is placed. In 1853 the same notion was prominently and independently brought forward by Dr A. C. E. Baldamus (*Naumannia*, 1853, pp. 307-325), and in time became known to English ornithologists, most of whom were naturally sceptical as to its truth, since no likeness whatever is ordinarily apparent in the very familiar case of the blue-green egg of the hedge-sparrow and that of the cuckoo, which is so often found beside it.<sup>1</sup> Dr Baldamus based his notion on a series of eggs in his cabinet,<sup>2</sup> a selection from which he figured in illustration of his paper, and, however the thing may be accounted for, it seems impossible to resist, save on one supposition, the force of the testimony these specimens afford. This one supposition is that the eggs have been wrongly ascribed to the cuckoo, and that they are only exceptionally large examples of the eggs of the birds in the nests of which they were found, for it cannot be gainsaid that some such abnormal examples are occasionally to be met with. But it is well known that abnormally large eggs are not only often deficient in depth of colour, but still more often in stoutness of shell. Applying these rough criteria to Dr Baldamus's series, most of the specimens stood the test very well.

There are some other considerations to be urged. For instance, Herr Braune, a forester at Greiz in the principality of Reuss (*Naumannia*, *tom. cit.* pp. 307, 313), shot a hen cuckoo as she was leaving the nest of an icterine warbler (*Hypolais icterina*). In the oviduct of this cuckoo he found an egg coloured very like that of the warbler, and on looking into the nest he found there an exactly similar egg, which there can be no reasonable doubt had just been laid by that very cuckoo. Moreover, Herr Grunack (*Journ. für Orn.*, 1873, p. 454) afterwards found one of the most abnormally coloured specimens, quite unlike the ordinary egg of the cuckoo, to contain an embryo so fully formed as to show the characteristic zygodactyl feet of the bird, thus proving unquestionably its parentage.

On the other hand, we must bear in mind the numerous instances in which not the least similarity can be traced—as in the not uncommon case of the hedge-sparrow already mentioned, and if we attempt any explanatory hypothesis it must be one that will fit all round. Such an explanation seems to be this. We know that certain kinds of birds resent interference with their nests much less than others, and among them it may be asserted that the hedge-sparrow will patiently submit to various experiments. She will brood with complacency the egg of a redbreast (*Eriothacus rubecula*), so unlike her own, and for aught we know to the contrary may even be colour-blind. In the case

of such a species there would be no need of anything further to ensure success—the terror of the nest-owner at seeing her home invaded by a hawk-like giant, and some of her treasures tossed out, would be enough to stir her motherly feelings so deeply that she would without misgiving, if not with joy that something had been spared to her, resume the duty of incubation so soon as the danger was past. But with other species it may be, and doubtless is, different. Here assimilation of the introduced egg to those of the rightful owner may be necessary, for there can hardly be a doubt as to the truth of Dr Baldamus's theory as to the object of the assimilation being to render the cuckoo's egg "less easily recognized by the foster-parents as a substituted one." It is especially desirable to point out that there is not the slightest ground for imagining that the cuckoo, or any other bird, can voluntarily influence the colour of the egg she is about to lay. Over that she can have no control, but its destination she can determine. It would seem also impossible that a cuckoo, having laid an egg, should look at it, and then decide from its appearance in what bird's nest she should put it. That the colour of an egg-shell can be in some mysterious way affected by the action of external objects on the perceptive faculties of the mother is a notion too wild to be seriously entertained. Consequently, only one explanation of the facts can here be suggested. Every one who has sufficiently studied the habits of animals will admit the influence of heredity. That there is a reasonable probability of each cuckoo most commonly putting her eggs in the nest of the same species of bird, and of this habit being transmitted to her posterity, does not seem to be a very violent supposition. Without attributing any wonderful sagacity to her, it does not seem unlikely that the cuckoo which had once successfully foisted her egg on a reed-wren or a titlark should again seek for another reed-wren's or another titlark's nest (as the case may be), when she had another egg to dispose of, and that she should continue her practice from one season to another. It stands on record (*Zoologist*, 1873, p. 3648) that a pair of wagtails built their nest for eight or nine years running in almost exactly the same spot, and that in each of those years they fostered a young cuckoo, while many other cases of like kind, though not perhaps established on so good authority, are believed to have happened. Such a habit could hardly fail to become hereditary, so that the daughter of a cuckoo which always put her egg into a reed-wren's, titlark's or wagtail's nest would do as did her mother. Furthermore it is unquestionable that, whatever variation there may be among the eggs laid by different individuals of the same species, there is a strong family likeness between the eggs laid by the same individual, even at the interval of many years, and it can hardly be questioned that the eggs of the daughter would more or less resemble those of her mother. Hence the supposition may be fairly credited that the habit of laying a particular style of egg is also likely to become hereditary. Combining this supposition with that as to the cuckoo's habit of using the nest of the same species becoming hereditary, it will be seen that it requires only an application of the principle of natural selection to show the probability of this principle operating in the course of time to produce the facts asserted by the anonymous Solognot of the 18th century, and by Dr Baldamus and others since. The particular *gens* of cuckoo which inherited and transmitted the habit of depositing in the nest of any particular species of bird eggs having more or less resemblance to the eggs of that species would prosper most in those members of the *gens* where the likeness was strongest, and the other members would (*ceteris paribus*) in time be eliminated. As already shown, it is not to be supposed that all species, or even all individuals of a species, are duped with equal ease. The operation of this kind of natural selection would be most needed in those cases where the species are not easily duped—that is, in those cases which occur the least frequently. Here it is we find it, for observation shows that eggs of the cuckoo deposited in nests of the red-backed shrike (*Lanius collurio*), of the bunting (*Emberiza miliaria*), and of the icterine warbler approximate in their colouring to eggs of those species—species in whose nests the cuckoo rarely (in comparison with others) deposits eggs.

<sup>1</sup> An instance to the contrary has been recorded by Mr A. C. Smith (*Zoologist*, 1873, p. 3516) on Mr Brine's authority.

<sup>2</sup> This series was seen in 1861 by the writer.

Of species which are more easily duped, such as the hedge-sparrow, mention has already been made.

More or less nearly allied to the British cuckoo are many other forms of the genus from various parts of Africa, Asia and their islands, while one even reaches Australia. In some cases the chief difference is said to lie in the diversity of voice—a character only to be appreciated by those acquainted with the living birds, and though of course some regard should be paid to this distinction, the possibility of birds using different “dialects” according to the locality they inhabit must make it a slender specific diagnostic. All these forms are believed to have essentially the same habits as the British cuckoo, and, as regards parasitism the same is to be said of the large cuckoo of southern Europe and North Africa (*Coccyzus glandarius*), which victimizes pies (*Pica mauritanica* and *Cyanopica cooki*) and crows (*Corvus cornix*). True it is that an instance of this species, commonly known as the great spotted cuckoo, having built a nest and hatched its young, is on record, but the later observations of others tend to cast doubt on the credibility of the ancient report. It is worthy of remark that the eggs of this bird so closely resemble those of one of the pies in whose nest they have been found, that even expert zoologists have been deceived by them, only to discover the truth when the cuckoo's embryo had been extracted from the supposed pie's egg. This species of cuckoo, easily distinguishable by its large size and long crest, has more than once made its appearance as a straggler in the British Isles. Equally parasitic are many other cuckoos, belonging chiefly to genera which have been more or less clearly defined as *Cacomantis*, *Chrysococcyx*, *Eudynamis*, *Oxylophus*, *Polyphasia* and *Surniculus*, and inhabiting parts of the Ethiopian, Indian and Australian regions;<sup>1</sup> but there are certain aberrant forms of Old World cuckoos which unquestionably do not shirk parental responsibilities. Among these especially are the birds placed in or allied to the genera *Centropus* and *Coua*—the former having a wide distribution from Egypt to New South Wales, living much on the ground and commonly called lark-heeled cuckoos; the latter bearing no English name, and limited to the island of Madagascar. These build a nest, not perhaps in a highly finished style of architecture, but one that serves its end.

Respecting the cuckoos of America, the evidence, though it has been impugned, is certainly enough to clear them from the charge which attaches to so many of their brethren of the Old World. There are two species very well known in parts of the United States and some of the West Indian Islands (*Coccyzus americanus* and *C. erythrophthalmus*), and each of them has occasionally visited Europe. They both build nests—remarkably small structures when compared with those of other birds of their size—and faithfully incubate their delicate sea-green eggs. In the south-western states of the Union and thence into Central America is found another curious form of cuckoo (*Geococcyx*)—the chaparral-cock of northern and paisano of southern settlers. The first of these names it takes from the low brushwood (*chaparral*) in which it chiefly dwells, and the second is said to be due to its pheasant-like (*faisan* corrupted into *paisano*, properly a countryman) appearance as it runs on the ground. Indeed, one of the two species of the genus was formerly described as a *Phasianus*. They both have short wings, and seem never to fly, but run with great rapidity. Returning to arboreal forms, the genera *Neomorphus*, *Diplopterus*, *Saurothera* and *Piaya* (the last two commonly called rain-birds, from the belief that their cry portends rain) may be noticed—all of them belonging to the Neotropical region; but perhaps the most curious form of American cuckoos is the ani (*Crotophaga*), of which three species inhabit the same region. The best-known species (*C. ani*) is found throughout the Antilles and on the opposite continent. In most of the British colonies it is known as the black witch, and is accused of various malpractices—it being, in truth, a perfectly harmless if not a beneficial bird. As regards its propagation this aberrant form of cuckoo departs in one direction

<sup>1</sup> Evidence tends to show that the same is to be said of the curious channel-bill (*Scythrops novae-hollandiae*), though absolute proof seems to be wanting.

from the normal habit of birds, for several females, unite to lay their eggs in one nest. It is evident that incubation is carried on socially, since an intruder on approaching the rude nest will disturb perhaps half a dozen of its sable proprietors, who, loudly complaining, seek safety either in the leafy branches of the tree that holds it, or in the nearest available covert, with all the speed that their feeble powers of flight permit. (A. N.)

**CUCKOO-SPIT**, a frothy secretion found upon plants, and produced by the immature nymphal stage of various plant-lice of the familiar *Cercopidae* and *Jassidae*, belonging to the homopterous division of the Hemiptera, which in the adult condition are sometimes called frog-hoppers.

**CUCUMBER** (*Cucumis sativus*, Fr. *concombre*, O. Fr. *coucombre*, whence the older English spelling and pronunciation “cowmber,” the standard in England up to the beginning of the 18th century), a creeping plant of the natural order Cucurbitaceae. It is widely cultivated, and originated probably in northern India, where Alphonse de Candolle affirms (*Origin of Cultivated Plants*) that it has been cultivated for at least three thousand years. It spread westward to Europe and was cultivated by the ancient Greeks under the name *σκῦνος*; it did not reach China until two hundred years before the Christian era. It is an annual with a rough succulent trailing stem and stalked hairy leaves with three to five pointed lobes; the stem bears branched tendrils by means of which the plant can be trained to supports. The short-stalked, bell-shaped flowers are unisexual, but staminate and pistillate are borne on the same plant; the latter are recognized by the swollen warty green ovary below the rest of the flower. The ovary develops into the “cucumber” without fertilization, and unless seeds are wanted, it is advisable to pinch off the male flowers.

There are a great many varieties of cucumber in cultivation, which may be grouped under the two headings (1) forcing, (2) field varieties.

1. The former are large-leaved strong-growing plants, not suited to outdoor culture, with long smooth-rinded fruit; there are many excellent varieties such as Telegraph, Sion House, duke of Edinburgh, &c. The plants are grown in a hot-bed which is prepared towards the end of February from rich stable manure, leaves, &c. A rich turfy loam with a little well-decomposed stable manure forms a good soil. The seeds are sown singly in rich, sandy soil in small pots early in February and plunged in a bottom heat. After they have made one or two foliage-leaves the seedlings are transferred to larger pots, and ultimately about the middle of March to the hot-bed. Each plant is placed in the centre of a mound of soil about a foot deep and well watered with tepid water. The plants should be well watered during their growing period, and the foliage sprinkled or syringed two or three times a day. In bright sunshine the plants are lightly shaded. When grown in frames the tops of the main stems are pinched off when the stems are about 2 ft. long; this causes the development of side shoots on which fruits are borne. When these have produced one or two fruits, they are also stopped at the joint beyond the fruit. When grown in green-houses the vines may be allowed to reach the full length of the house before they are stopped. To keep the fruits straight they may be grown in cylindrical glass tubes about a foot long, or along narrow wooden troughs. If seeds are required one or more female flowers should be selected and pollen from male flower placed on their stigmas.

2. The outdoor varieties are known as hill or ridge cucumbers. They may be grown in any good soil. A warm, sheltered spot with a south aspect and a mound of rich, sandy loam with a little leaf-mould placed over a hot-bed of dung and leaves is recommended. The mounds or ridges should be 4 to 5 ft. apart, and one plant is placed in the centre of each. The seeds are sown in March in light, rich soil in small pots with gentle heat. The seedlings are repotted and well hardened for planting out in June. The plants must be well watered in and, until established, shaded by a hand-light from bright sunshine. When the leading shoots are from 1½ to 2 ft. long the tips are pinched off to induce the formation of fruit-bearing side-shoots. If seed is required a pistillate



flower is selected and pollinated. There are numerous varieties distinguished by size and the smooth or prickly rind. King of the Ridge has smooth fruits a foot or more long; gherkin, a short, prickly form, is much used for pickling.

Cucumber is subject to the attacks of green fly, red spider and thrips; for the two latter, infected leaves should be sponged with soapy water; for green fly careful fumigating is necessary.

The Sikkim cucumber, *C. sativus* var. *sikkimensis*, is a large fruited form, reaching 15 in. long by 6 in. thick, grown in the Himalayas of Sikkim and Nepal. It was discovered by Sir Joseph Hooker in the eastern Himalayas in 1848. He says "so abundant were the fruits, that for days together I saw gnawed fruits lying by the natives' paths by thousands, and every man, woman and child seemed engaged throughout the day in devouring them." The fruit is reddish-brown, marked with yellow, and is eaten both raw and cooked.

The West India gherkin is *Cucumis Anguria*, a plant with small, slender vines, and very abundant small ellipsoid green fruit covered with warts and spines. It is used for pickling.

Cucumbers were much esteemed by the ancients. According to Pliny, the emperor Tiberius was supplied with them daily, both in summer and winter. The kishuim or cucumbers of the scriptures (Num. xi. 5; Isa. i. 8) were probably a wild form of *C. Melo*, the melon, a plant common in Egypt, where a drink is prepared from the ripe fruit. Peter Forskäl, one of the early botanical writers on the country, describes its preparation. The pulp is broken and stirred by means of a stick thrust through a hole cut at the umbilicus of the fruit; the hole is then closed with wax, and the fruit, without removing it from its stem, is buried in a little pit; after some days the pulp is found to be converted into an agreeable liquor (see *Flora aegyptiaco-arabica*, p. 168, 1775). The squirting cucumber, *Ecballium Elaterium*, the *Σίκκος ἔλτροπος* of Theophrastus, furnishes the drug elaterium (*q.v.*).

See Naudin in *Annal. des sci. nat. ser. 4* (Botany), t. xi. (1859); G. Nicholson, *Dictionary of Gardening* (1885); L. H. Bailey, *Cyclopaedia of American Horticulture* (1900).

**CUCURBITACEAE**, a botanical order of dicotyledons, containing 87 genera and about 650 species, found in the temperate and warmer parts of the earth but especially developed in the

lobed and veined. The flowers or inflorescences are borne in the leaf-axils, in which a vegetative bud is also found, and at the side of the leaf-stalk is a simple or branched tendril. There has been much difference of opinion as to what member or members the tendril represents; the one which seems most in accordance with facts regards the tendril as a shoot, the lower portion representing the stem, the upper twining portion a leaf. The flowers are unisexual, and strikingly epigynous, the perianth and stamens being attached to a bell-shaped prolongation of the receptacle above the ovary. The five narrow pointed sepals are followed by five petals which are generally united to form a more or less bell-shaped corolla. There are five stamens in the male flowers; the anthers open towards the outside, are

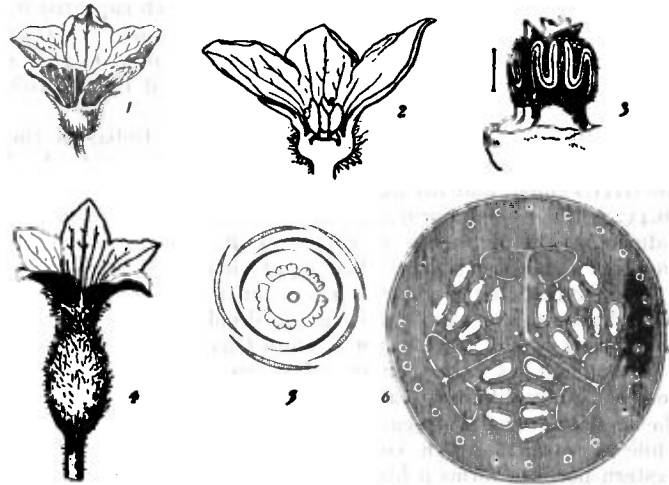

FIG. 2.

- |  |  |
|--|--|
| 1, Male flower of cucumber ( <i>Cucumis</i> ).   | 4, Female flower.                                    |
| 2, Same, in vertical section, slightly enlarged. | 5, Horizontal plan of male flower.                   |
| 3, Stamens, after removal of calyx and corolla.  | 6, Transverse section of fruit, about 1/3 nat. size. |
- 1 and 4 nat. size.

one-celled, with the pollen-sacs generally curved and variously united. The carpels, normally three in number, form an ovary with three thick, fleshy, bifid placentas bearing a large number of ovules on each side, and generally filling the interior of the ovary with a juicy mass. The short thick style has generally three branches each bearing a fleshy, usually forked stigma. The fruit is a fleshy many-seeded berry with a tough rind (known as a *pepo*), and often attains considerable size. The embryo completely fills the seed.

The order is represented in Britain by bryony (*Bryonia dioica*), (fig. 1) a hedge-climber, perennial by means of large fleshy tubers which send up each year a number of slender angular stems. The leaves are heart-shaped with wavy margined lobes. The flowers are greenish, 1/2 to 3/4 in. in diameter; the fruit, a red several-seeded berry, is about 1/4 in. in diameter.

Many genera are of economic importance; *Cucumis* (fig. 2) affords cucumber (*q.v.*) and melon (*q.v.*); *Cucurbita*, pumpkin and marrow; *Citrullus vulgaris* is water-melon, and *C. Colocynthis*, colocynth; *Ecballium Elaterium* (squirting cucumber) is medicinal; *Sechium edule* (chocho), a tropical American species, is largely cultivated for its edible fruit; it contains one large seed which germinates *in situ*. *Lagenaria* is the gourd (*q.v.*). The fruits of *Luffa aegyptiaca* have a number of closely netted vascular bundles in the pericarp, forming a kind of loose felt which supplies the well-known loofah or bath-sponge.

**CUDDALORE**, a town of British India, in the South Arcot district of Madras, on the coast 125 m. S. of Madras by rail. Pop. (1901) 52,216, showing an increase of 10% in the decade. It lies low, but is regarded as exceptionally healthy, and serves as a kind of sanatorium for the surrounding district. The principal exports are sugar, oil-seeds and indigo. There are two colleges and two high schools. In the neighbourhood are the ruins of Fort St David situated on the river Gadilam, which has



FIG. 1.—*Bryonia dioica*, Bryony, about 1/3 nat. size. 1, Part of corolla of male flower with attached stamens; 2, female flower after removal of calyx and corolla; 3, berries; 1, 2, 3 about nat. size.

tropics. The plants are generally annual herbs, climbing by means of tendrils and having a rapid growth. The long-stalked leaves are arranged alternately, and are generally palmately

as stirring a history as any spot in the Presidency. As a small fort built by a Hindu merchant it fell into the hands of the Mahrattas after the capture of Gingi by Sivaji in 1677. From them it was purchased by the English in 1690, the purchase including not only the fort but the adjacent towns and villages "within ye randome shott of a piece of ordnance." A great gun was fired to different points of the compass and all the country within its range, including the town of Cuddalore, passed into the possession of the English. The villages thus obtained are still spoken of as "cannon ball villages." From 1725 onwards the fortifications were greatly strengthened. In 1746 Fort St David became the British headquarters for the south of India, and Dupleix' attack was successfully repulsed. Clive was appointed its governor in 1756; in 1758 the French captured it, but abandoned it two years later to Sir Eyre Coote. In 1782 they again took it and restored it sufficiently to withstand a British attack in 1783. In 1785 it finally passed into British possession.

**CUDDAPAH**, a town and district of British India, in the Madras Presidency. The town is 6 m. from the right bank of the river Pennar, and 161 m. by rail from Madras. Pop. (1901) 16,432. It is now a poor place, but has some trade in cotton and indigo, and manufactures of cotton cloth. Hills surround it on three sides, and it has a bad reputation for unhealthiness.

The DISTRICT OF CUDDAPAH has an area of 8723 sq. m. It is in shape an irregular parallelogram, divided into two nearly equal parts by the range of the Eastern Ghats, which intersects it throughout its entire length. The two tracts thus formed possess totally different features. The first, which constitutes the north, east and south-east of the district, is a low-lying plain; while the other, which comprises the southern and south-western portion, forms a high table-land from 1500 to 2500 ft. above sea-level. The chief river is the Pennar, which enters the district from Bellary on the west, and flows eastwards into Nellore. Though a large and broad river, and in the rains containing a great volume of water, in the hot weather months it dwindles down to an inconsiderable stream. Its principal tributaries are the Kundaar, Saglair, Cheyair, and Papagni rivers. One of the most interesting antiquities in the district is the ancient fort of Gurramkonda. The fort is supposed to have been built by the Golconda sultans; it stands on a hill 500 ft. high, three sides of which consist of almost perpendicular precipices. According to a local legend the name Gurramkonda, meaning "horse hill," was derived from the fact that a horse was supposed to be guardian of the fort and that the place was impregnable so long as the horse remained there. The story goes that a Mahratta chief at length succeeded in scaling the precipice and in carrying off the horse, and although the thief was captured before reaching the base of the hill, the spell was broken and the fort, when next attacked, fell. The population of the district in 1901 was 1,291,267. The principal crops are millet, rice, other food grains, pulse, oil-seeds, cotton and indigo. The two last are largely exported. There are several steam factories for pressing cotton, and indigo vats. The district is served by lines of the Madras and the South Indian railways.

**CUDWORTH, RALPH** (1617-1688), English philosopher, was born at Aller, Somersetshire, the son of Dr Ralph Cudworth (d. 1624), rector of Aller, formerly fellow of Emmanuel College, Cambridge. His father died in 1624, and his mother then married the Rev. Dr Stoughton, who gave the boy a good home education. Cudworth was sent to his father's college, was elected fellow in 1639, and became a successful tutor. In 1642 he published *A Discourse concerning the true Notion of the Lord's Supper*, and a tract entitled *The Union of Christ and the Church*. In 1645 he was appointed master of Clare Hall and the same year was elected Regius professor of Hebrew. He was now recognized as a leader among the remarkable group known as the Cambridge Platonists (q.v.). The whole party were more or less in sympathy with the Commonwealth, and Cudworth was consulted by John Thurloe, Cromwell's secretary of state, in regard to university and government appointments. His sermons, such as that

preached before the House of Commons, on the 31st of March 1647, advocate principles of religious toleration and charity. In 1650 he was presented to the college living of North Cadbury, Somerset. From the diary of his friend John Worthington we learn that Cudworth was nearly compelled, through poverty, to leave the university, but in 1654 he was elected master of Christ's College, whereupon he married. On the Restoration he contributed some Hebrew verses to the *Academiae Cantabrigiensis Σῶστρον*, a congratulatory volume addressed to the king. In 1662 he was presented to the rectory of Ashwell, Herts. In 1665 he almost quarrelled with his fellow-Platonist, Henry More, because the latter had written an ethical work which Cudworth feared would interfere with his own long-contemplated treatise on the same subject. To avoid clashing, More brought out his book, the *Enchiridion ethicum*, in Latin; Cudworth's never appeared. In 1678 he published *The True Intellectual System of the Universe: the first part, wherein all the reason and philosophy of atheism is confuted and its impossibility demonstrated* (imprimatur dated 1671). No more was published, perhaps because of the theological clamour raised against this first part. Cudworth was installed prebendary of Gloucester in 1678. He died on the 26th of June 1688, and was buried in the chapel of Christ's. His only surviving child, Damaris, a devout and talented woman, became the second wife of Sir Francis Masham, and was distinguished as the friend of John Locke. Much of Cudworth's work still remains in manuscript; *A Treatise concerning eternal and immutable Morality* was published in 1731; and *A Treatise of Freewill*, edited by John Allen, in 1838; both are connected with the design of his *magnum opus*, the *Intellectual System*.

The *Intellectual System* arose, so its author tells us, out of a discourse refuting "fatal necessity," or determinism. Enlarging his plan, he proposed to prove three matters: (a) the existence of God; (b) the naturalness of moral distinctions; and (c) the reality of human freedom. These three together make up the intellectual (as opposed to the physical) system of the universe; and they are opposed respectively by three false principles, atheism, religious fatalism which refers all moral distinctions to the will of God, and thirdly the fatalism of the ancient Stoics, who recognized God and yet identified Him with nature. The immense fragment dealing with atheism is all that was published by its author. Cudworth criticizes two main forms of materialistic atheism, the atomic, adopted by Democritus, Epicurus and Hobbes; and the hylzoic, attributed to Strato, which explains everything by the supposition of an inward self-organizing life in matter. Atomic atheism is by far the more important, if only because Hobbes, the great antagonist whom Cudworth always has in view, is supposed to have held it. It arises out of the combination of two principles, neither of which is atheistic taken separately, i.e. atomism and corporealism, or the doctrine that nothing exists but body. The example of Stoicism, as Cudworth points out, shows that corporealism may be theistic. Into the history of atomism Cudworth plunges with vast erudition. It is, in its purely physical application, a theory that he fully accepts; he holds that it was taught by Pythagoras, Empedocles, and in fact, nearly all the ancient philosophers, and was only perverted to atheism by Democritus. It was first invented, he believes, before the Trojan war, by a Sidonian thinker named Moschus or Mochus, who is identical with the Moses of the Old Testament. In dealing with atheism Cudworth's method is to marshal the atheistic arguments elaborately, so elaborately that Dryden remarked "he has raised such objections against the being of a God and Providence that many think he has not answered them"; then in his last chapter, which by itself is as long as an ordinary treatise, he confutes them with all the reasons that his reading could supply. A subordinate matter in the book that attracted much attention at the time is the conception of the "Plastic Medium," which is a mere revival of Plato's "World-Soul," and is meant to explain the existence and laws of nature without referring all to the direct operation of God. It occasioned a long-drawn controversy between Pierre Bayle and Le Clerc, the former

maintaining, the latter denying, that the Plastic Medium is really favourable to atheism.

No modern reader can endure to toil through the *Intellectual System*; its only interest is the light it throws upon the state of religious thought after the Restoration, when, as Birch puts it, "irreligion began to lift up its head." It is immensely diffuse and pretentious, loaded with digressions, its argument buried under masses of fantastic, uncritical learning, the work of a vigorous but quite unoriginal mind. As Bolingbroke said, Cudworth "read too much to think enough, and admired too much to think freely." It is no calamity that natural procrastination, or the clamour caused by his candid treatment of atheism and by certain heretical tendencies detected by orthodox criticism in his view of the Trinity, made Cudworth leave the work unfinished.

A much more favourable judgment must be given upon the short *Treatise on eternal and immutable Morality*, which deserves to be read by those who are interested in the historical development of British moral philosophy. It is an answer to Hobbes's famous doctrine that moral distinctions are created by the state, an answer from the standpoint of Platonism. Just as knowledge contains a permanent intelligible element over and above the flux of sense-impressions, so there exist eternal and immutable ideas of morality. Cudworth's ideas, like Plato's, have "a constant and never-failing entity of their own," such as we see in geometrical figures; but, unlike Plato's, they exist in the mind of God, whence they are communicated to finite understandings. Hence "it is evident that wisdom, knowledge and understanding are eternal and self-subsistent things, superior to matter and all sensible beings, and independent upon them"; and so also are moral good and evil. At this point Cudworth stops; he does not attempt to give any list of Moral Ideas. It is, indeed, the cardinal weakness of this form of intuitionism that no satisfactory list can be given and that no moral principles have the "constant and never-failing entity," or the definiteness, of the concepts of geometry. Henry More, in his *Enchiridion ethicum*, attempts to enumerate the "*noemata moralia*"; but, so far from being self-evident, most of his moral axioms are open to serious controversy.

The *Intellectual System* was translated into Latin by J. L. Mosheim and furnished with notes and dissertations which were translated into English in J. Harrison's edition (1845). Our chief biographical authority is T. Birch's "Account," which appears in editions of the *Works*. There is a good chapter on Cudworth in J. Tulloch's *Rational Theology*, vol. ii. Consult also P. Janet's *Essai sur le médiateur plastique* (1860), W. R. Scott's *Introduction to Cudworth's "Treatise,"* and J. Martineau's *Types of Ethical Theory*, vol. ii. (H. St.)

**CUENCA**, a city and the capital of the province of Azuay, Ecuador, about 190 m. S. of Quito and 70 m. S.E. of Guayaquil. Pop. (1908 estimate) 30,000 (largely Indians), including the suburb of Ejido. Cuenca stands at the northern end of a broad valley, or basin, of the Andes, lying between the transverse ridges of Azuay and Loja, and is about 8640 ft. above sea-level. Near by is the hill of Tarqui which the French astronomers chose for their meridian in 1742. Communication with the coast is difficult. Cuenca is the third most important city of Ecuador, being the seat of a bishopric, and having a college, a university faculty, a cathedral, and several churches, and a considerable industrial and commercial development. It manufactures sugar, woollen goods and pottery, and exports Peruvian bark (cinchona), hats, cereals, cheese, hides, &c. It was founded in 1557 on the site of a native town called Tumibamba, and was made an episcopal see in 1786.

**CUENCA**, a province of central Spain bounded on the N. by Guadalajara, N.E. by Teruel, E. by Valencia, S. by Albacete, S.W. by Ciudad Real, W. by Toledo and N.W. by Madrid. Pop. (1900) 249,696; area, 6636 sq. m. Cuenca occupies the eastern part of the ancient kingdom of New Castile, and slopes from the Serrania de Cuenca (highest point the Cerro de San Felipe, on the north-eastern border of the province, 5905 ft.), down into the great southern Castilian plain watered by the upper streams of the Guadiana. The lowlands bordering on Ciudad

Real belong to the wide plain of La Mancha (*q.v.*). The rocky and bare highland of Cuenca on the north and east includes the upper valley of the Jucar and its tributary streams, but in the north-west the province is watered by tributaries of the Tagus. The forests are proverbial for their pine timber, and rival those of Soria; considerable quantities of timber are floated down the Tagus to Aranjuez and thence taken to Madrid for building purposes. Excessive droughts prevail; the climate of the hills and of the high plateaus is harsh and cold, but the valleys are excessively hot in summer. The soil, where well watered, is fertile, but little attention is paid to agriculture, and three-fourths of the area is left under pasture. The rearing of cattle, asses, mules and sheep is the principal employment of the people; olive oil, nuts, wine, wheat, silk, wax and honey are the chief products. Iron, copper, alum, saltpetre, jasper and agates are found, but in 1903 all the workings had been abandoned except three salt mines; and there are few manufactures except the weaving of coarse cloth. The roads are in such a backward condition that they cripple not only the mining interests but also the exports of timber, and at the beginning of the 20th century there was no railway except a branch line which passed westwards from Aranjuez through Tarancon to Cuenca, the capital (pop. 1900, 10,756). No other town has as many as 6000 inhabitants, and no other Spanish province is so thinly populated as Cuenca. In 1900 there were only 37.6 inhabitants per sq. m. Education is backward, and extreme poverty almost universal among the peasantry. See also CASTILE.

**CUENCA**, the capital of the Spanish province of Cuenca; 125 m. by rail E. by S. of Madrid. Pop. (1900) 10,756. Cuenca occupies a height of the well-wooded Serrania de Cuenca, at an elevation of 2960 ft., overlooking the confluence of the rivers Jucar and Huecar. A fine bridge, built in 1523, crosses the Jucar to the convent of San Pablo. Among several interesting churches in the city, the most noteworthy is the 13th-century Gothic cathedral, celebrated for the beautiful carved woodwork of its 16th-century doorway, and containing some admirable examples of Spanish sculpture. The city has a considerable trade in timber, and was long the headquarters of the provincial wool industry; the loss of which, in modern times, has partly been compensated by the development of soap, paper, chocolate, match and leather manufactures. Cuenca was captured from the Moors by Alphonso VIII. of Castile in 1177, and shortly afterwards became an episcopal see. In 1874 it offered a prolonged and gallant resistance to the Carlist rebels.

**CUESTA**, a name of Spanish origin used in New Mexico for low ridges of steep descent on one side and gentle slope on the other. It has been proposed as a term for the land form which consists of the two elements of a steep scarp or "strike" face, and an inclined plain or gentle "dip" slope.

**CUEVAS DE VERA**, a town of south-eastern Spain, in the province of Almería; on the right bank of the river Almanzora, 8 m. W. of the Mediterranean Sea. Pop. (1900) 20,562. Cuevas de Vera is built at the eastern extremity of the Sierra de los Filabres (6823 ft.), which isolate it from the railway system of Almería. It is, however, the chief market for the rich agricultural districts towards the south and for the argentiferous lead and other mines among the mountains. In appearance it is modern, with wide streets, two fine squares, and a parish church in Doric style, dating from 1758. But in reality the town is of considerable antiquity. One of the towers in the Moorish palace owned by the marquesses of Villafranca is probably of Roman origin.

**CUFF**. (1) (Of uncertain origin), the lower edge of a sleeve turned back to show an ornamental border, or with an addition of lace or trimming; now used chiefly of the stiff bands of linen worn under the coat-sleeve either loose or attached to the shirt. (2) Also uncertain in origin, but with no connexion, probably, with (1), a blow with the hand either open or closed, as opposed to the use of weapons.

**CUIRASS** (Fr. *cuirasse*, Lat. *coriaceus*, made of leather, from *corium*, the original breastplate being of leather), the plate armour, whether formed of a single piece of metal or other rigid material or composed of two or more pieces, which covers the

front of the wearer's person. In a suit of armour, however, since this important piece was generally worn in connexion with a corresponding defence for the back, the term *cuirass* commonly is understood to imply the complete body-armour, including both the breast and the back plates. Thus this complete body-armour appears in the middle ages frequently to have been described as a "pair of plates." The *corslet* (Fr. *corselet*, diminutive of the O. Fr. *cors*, body), a comparatively light cuirass, is more strictly a breast-plate only. As parts of the military equipment of classic antiquity, cuirasses and corslets of bronze, and at later periods also of iron or some other rigid substance, were habitually in use; but while some special kind of secondary protection for the breast had been worn in earlier times by the men-at-arms in addition to their mail hauberks and their "cotes" armed with splints and studs, it was not till the 14th century that a regular body-defence of plate can be said to have become an established component of medieval armour. As this century continued to advance, the cuirass is found gradually to have come into general use, in connexion with plate defences for the limbs, until, at the close of the century, the long familiar inter-linked chain-mail is no longer visible in knightly figures, except in the camail of the bassinet and at the edge of the hauberk. The prevailing, and indeed almost the universal, usage throughout this century was that the cuirass was worn covered. Thus, the globose form of the breast-armour of the Black Prince, in his effigy in Canterbury cathedral, 1376, intimates that a cuirass as well as a hauberk is to be considered to have been covered by the royalty-embazoned jupon of the prince. The cuirass, thus worn in the 14th century, was always made of sufficient length to rest on the hips; otherwise, if not thus supported, it must have been suspended from the shoulders, in which case it would have effectually interfered with the free and vigorous action of the wearer. Early in the 15th century, the entire panoply of plate, including the cuirass, began to be worn without any surcoat; but in the concluding quarter of the century the short surcoat, with full short sleeves, known as the tabard, was in general use over the armour. At the same time that the disuse of the surcoat became general, small plates of various forms and sizes (and not always made in pairs, the plate for the right or sword-arm often being smaller and lighter than its companion), were attached to the armour in front of the shoulders, to defend the otherwise vulnerable points where the plate defences of the upper-arms and the cuirass left a gap on each side. About the middle of the century, instead of being formed of a single plate, the breast-plate of the cuirass was made in two parts, the lower adjusted to overlap the upper, and contrived by means of a strap or sliding rivet to give flexibility to this defence. In the second half of the 15th century the cuirass occasionally was superseded by the "brigandine jacket," a defence formed of some textile fabric, generally of rich material, lined throughout with overlapping scales (resembling the earlier "imbricated" form) of metal, which were attached to the jacket by rivets, having their heads, like studs, visible on the outside. In the 16th century, when occasionally, and by personages of exalted rank, splendid surcoats were worn over the armour, the cuirass—its breast-piece during the first half of the century, globular in form—was constantly reinforced by strong additional plates attached to it by rivets or screws. About 1550 the breast-piece of the cuirass was characterized by a vertical central ridge, called the "tapul" having near its centre a projecting point; this projection, somewhat later, was brought lower down, and eventually the profile of the plate, the projection having been carried to its base, assumed the singular form which led to this fashion of the cuirass being distinguished as the "peascod cuirass."

Corslets provided with both breast and back pieces were worn by foot-soldiers in the 17th century, while their mounted comrades were equipped in heavier and stronger cuirasses; and these defences continued in use after the other pieces of armour, one by one, had gradually been laid aside. Their use, however, never altogether ceased, and in modern armies mounted cuirassiers, armed as in earlier days with breast and back plates, have in some degree emulated the martial splendour of the body-

armour of the era of medieval chivalry. Some years after Waterloo certain historical cuirasses were taken from their repose in the Tower of London, and adapted for service by the Life Guards and the Horse Guards. For parade purposes, the Prussian *Gardes du Corps* and other corps wear cuirasses of richly decorated leather.

**CUIRASSIERS**, a kind of heavy cavalry, originally developed out of the men-at-arms or gendarmerie forming the heavy cavalry of feudal armies. Their special characteristic was the wearing of full armour, which they retained long after other troops had abandoned it. Hence they became distinguished as cuirassiers. The first Austrian corps of *kyrassers* was formed in 1484 by the emperor Maximilian and was 100 strong. In 1705 Austria possessed twenty regiments of cuirassiers. After the war of 1866, however, the existing regiments were converted into dragoons. Russia has likewise in modern times abolished all but a few guard regiments of cuirassiers. The Prussian cuirassiers were first so called under Frederick William I., and in the wars of his successor Frederick the Great they bore a conspicuous part. After the Seven Years' War they ceased to wear the cuirass on service, but after 1814 these were reintroduced, the spoils taken from the French cuirassiers being used to equip the troops. The cuirass is now worn only on ceremonial parades. In France the cuirassiers date from 1666, when a regiment, subsequently numbered 8th of the line, was formed. During the first Empire many regiments were created, until in 1812 there were fourteen. The number was reduced after the fall of Napoleon, but in modern times it has been again increased. The French regiments alone in Europe wear the cuirass on all parades and at manœuvres.

**CUJAS** (or **CUJACIUS**), **JACQUES** (or as he called himself, **JACQUES DE CUJAS**) (1520-1590), French juriconsult, was born at Toulouse, where his father, whose name was Cujaus, was a fuller. Having taught himself Latin and Greek, he studied law under Arnoul Ferrier, then professor at Toulouse, and rapidly gained a great reputation as a lecturer on Justinian. In 1554 he was appointed professor of law at Cahors, and about a year after L'Hôpital called him to Bourges. Duaren, however, who also held a professorship at Bourges, stirred up the students against the new professor, and such was the disorder produced in consequence that Cujas was glad to yield to the storm, and accept an invitation he had received to the university of Valence. Recalled to Bourges at the death of Duaren in 1559, he remained there till 1567, when he returned to Valence. There he gained a European reputation, and collected students from all parts of the continent, among whom were Joseph Scaliger and de Thou. In 1573 Charles IX. appointed Cujas counsellor to the parlement of Grenoble, and in the following year a pension was bestowed on him by Henry III. Margaret of Savoy induced him to remove to Turin; but after a few months (1575) he once more took his old place at Bourges. But the religious wars drove him thence. He was called by the king to Paris, and permission was granted him by the parlement to lecture on civil law in the university of the capital. A year after, however, he finally took up his residence at Bourges, where he remained till his death in 1590, in spite of a handsome offer made him by Gregory XIII. in 1584 to attract him to Bologna.

The life of Cujas was altogether that of a scholar and teacher. In the religious wars which filled all the thoughts of his contemporaries he steadily refused to take any part. *Nihil hoc ad edictum praetoris*, "this has nothing to do with the edict of the praetor," was his usual answer to those who spoke to him on the subject. His surpassing merit as a juriconsult consisted in the fact that he turned from the ignorant commentators on Roman law to the Roman law itself. He consulted a very large number of manuscripts, of which he had collected more than 500 in his own library; but, unfortunately, he left orders in his will that his library should be divided among a number of purchasers, and his collection was thus scattered, and in great part lost. His emendations, of which a large number were published under the title of *Animadversiones et observationes*, were not confined to law-books, but extended to many of the Latin and Greek classical

authors. In jurisprudence his study was far from being devoted solely to Justinian; he recovered and gave to the world a part of the Theodosian Code, with explanations; and he procured the manuscript of the *Basilica*, a Greek abridgment of Justinian, afterwards published by Fabrot (see *BASILICA*). He also composed a commentary on the *Consuetudines Feudorum*, and on some books of the Decretals. In the *Paratilla*, or summaries which he made of the Digest, and particularly of the Code of Justinian, he condensed into short axioms the elementary principles of law, and gave definitions remarkable for their admirable clearness and precision. His lessons, which he never dictated, were continuous discourses, for which he made no other preparation than that of profound meditation on the subjects to be discussed. He was impatient of interruption, and upon the least noise he would instantly quit the chair and retire. He was strongly attached to his pupils, and Scaliger affirms that he lost more than 4000 livres by lending money to such of them as were in want.

In his lifetime Cujas published an edition of his works (Neville, 1577). It is beautiful and exact, but incomplete; it is now very scarce. The edition of Colombet (1634) is also incomplete. Fabrot, however, collected the whole in the edition which he published at Paris (1658), in 10 vols. folio, and which was reprinted at Naples (1722, 1727), in 11 vols. folio, and at Naples and at Venice (1758), in 10 vols. folio, with an index forming an eleventh volume. In the editions of Naples and Venice there are some additions not to be found in that of Fabrot, particularly a general table, which will be found very useful, and interpretations of all the Greek words used by Cujas.

See Papiere-Masson, *Vie de Cujas* (Paris, 1590); Terrasson, *Histoire de la jurisprudence romaine*, and *Mélanges d'histoire, de littérature, et de jurisprudence*; Bernardi, *Eloge de Cujas* (Lyons, 1775); Hugo, *Civilistisches Magazin*; Berriat Saint Prix, *Mémoires de Cujas*, appended to his *Histoire du droit romain*; *Biographie universelle*; Gravina, *De ortu et progressu juris civilis*; Spangenberg, *Cujacius und seine Zeitgenossen* (Leipzig, 1882).

**CULDEES**, an ancient monastic order with settlements in Ireland and Scotland. It was long fondly imagined by Protestant and especially by Presbyterian writers that they had preserved primitive Christianity free from Roman corruptions in one remote corner of western Europe, a view enshrined in Thomas Campbell's *Reullura*:

"Peace to their shades. The pure Culdees  
Were Albyn's earliest priests of God,  
Ere yet an island of her seas  
By foot of Saxon monk was trod."

Another view, promulgated like the above by Hector Boece in his Latin history of Scotland (1516), makes them the direct successors in the 9th to the 12th century of the organized Irish and Iona monasticism of the 6th to the 8th century. Both these views were disproved by William Reeves (1815-1892), bishop of Down, Connor and Dromore.

As found in the Irish MSS. the name is *Céle Dé*, i.e. God's comrade or sworn ally. It was latinized as *Coli dei*, whence Boece's *culdei*. The term seems, like the Latin *vir dei*, to have been applied generally to monks and hermits. There are very few trustworthy ancient sources of information, but it seems probable that the Rule of Chrodegang,<sup>1</sup> archbishop of Metz (d. 766), was brought by Irish monks to their native land from the monasteries of north-eastern Gaul, and that Irish anchorites originally unfettered by the rules of the cloister bound themselves by it. In the course of the 9th century we find mention of nine places in Ireland (including Armagh, Clonmacnoise, Clones, Devenish and Sligo) where communities of these Culdees were established as a kind of annexe to the regular monastic institutions. They seem especially to have had the care of the poor and the sick, and were interested in the musical part of worship. Meanwhile in Scotland the Iona monks had been expelled by the Pictish king Nechtan in 717, and the vacancies thus caused were by no means filled by the Roman monks who thronged into the north from Northumbria. Into

<sup>1</sup> Devised originally for the clergy of Chrodegang's cathedral, it was largely an adaptation of St Benedict's rule to secular clergy living in common. In 816 it was confirmed, with certain modifications, by the synod of Aix-la-Chapelle, and became the law for collegiate and cathedral churches in the Frankish empire. See *CANON*.

the gap, towards the end of the 8th century, came the Culdees from Ireland. The features of their life in Scotland, which is the most important epoch in the history of the order, seem to resemble closely those of the secular canons of England and the continent. From the outset they were more or less isolated, and, having no fixed forms or common head, tended to decay. In the 12th century the Celtic Church was completely metamorphosed on the Roman pattern, and in the process the Culdees also lost any distinctiveness they may formerly have had, being brought, like the secular clergy, under canonical rule. The pictures that we have of Culdee life in the 12th century vary considerably. The chief houses in Scotland were at St Andrews, Dunkeld, Lochleven, Monymusk in Aberdeenshire, Abernethy and Brechin. Each was an independent establishment controlled entirely by its own abbot and apparently divided into two sections, one priestly and the other lay and even married. At St Andrews about the year 1100 there were thirteen Culdees holding office by hereditary tenure and paying more regard to their own prosperity and aggrandizement than to the services of the church or the needs of the populace. A much-needed measure of reform, inaugurated by Queen Margaret, was carried through by her sons Alexander I. and David I.; gradually the whole position passed into the hands of Turgot and his successors in the bishopric. Canons Regular were instituted and some of the Culdees joined the new order. Those who declined were allowed a life-rent of their revenues and lingered on as a separate but ever-dwindling body till the beginning of the 14th century, when, excluded from voting at the election of the bishop, they disappear from history. At Dunkeld, Crinan, the grandfather of Malcolm Canmore, was a lay abbot, and tradition says that even the clerical members were married, though like the priests of the Eastern Church, they lived apart from their wives during their term of sacerdotal service. The Culdees of Lochleven lived on St Serf's Inch, which had been given them by a Pictish prince, Brude, about 850. In 1093 they surrendered their island to the bishop of St Andrews in return for perpetual food and clothing, but Robert, who was bishop in 1144, handed over all their vestments, books,<sup>2</sup> and other property, with the island, to the newly founded Canons Regular, in which probably the Culdees were incorporated. There is no trace of such partial independence as was experienced at St Andrews itself, possibly because the bishop's grant was backed up by a royal charter. In the same fashion the Culdees of Monymusk, originally perhaps a colony from St Andrews, became Canons Regular of the Augustinian order early in the 13th century, and those of Abernethy in 1273. At Brechin, famous like Abernethy for its round tower, the Culdee prior and his monks helped to form the chapter of the diocese founded by David I. in 1145, though the name persisted for a generation or two. Similar absorptions no doubt account for the disappearance of the Culdees of York, a name borne by the canons of St Peter's about 925, and of Snowdon and Bardsey Island in north Wales mentioned by Giraldus Cambrensis (c. 1190) in his *Speculum Ecclesiae* and *Itinerarium* respectively. The former community was, he says, sorely oppressed by the covetous Cistercians. These seem to be the only cases where the Culdees are found in England and Wales. In Ireland the Culdees of Armagh endured until the dissolution in 1541, and enjoyed a fleeting resurrection in 1627, soon after which their ancient property passed to the vicars choral of the cathedral.

See W. Reeves, *The Culdees of the British Islands* (Dublin, 1864); W. F. Skene, *Celtic Scotland* (1876-1880), especially vol. ii.; W. Beveridge, *Makers of the Scottish Church* (1908). The older view will be found in J. Jamieson's *Historical Account of the Ancient Culdees* (1811).

**CULEBRA**, the smaller of two islands lying in the Virgin Passage immediately E. of Porto Rico and known as the *Islas de Passaje*. It is about 18 m. distant from Cape San Juan and rises from the same submerged plateau with the larger islands of the Antilles. Its extreme dimensions are 3 by 6 m., and its surface is low and comparatively uniform, which gives the

<sup>2</sup> The list of these in the deed of transfer is the oldest Scottish library catalogue.



prevailing winds an unbroken sweep across it. For this reason the rainfall is limited to a short season, and the population is compelled to store rainwater in cisterns for drinking purposes. Its soil is fertile, and cattle, poultry, vegetables and small fruits are produced. The island has been a dependency of Porto Rico since 1879, when its colonization was formally undertaken, and it is now described as a ward of the Vieques district of the department of Humacao. In 1902 the American naval authorities selected the Playa Sardinias harbour on the S. side of Culebra as a rendezvous of the fleet and marine encampments were located on shore. The strategic position of the island, its healthiness and its continued use as a naval station have given it considerable importance. Its population was 704 in 1899, which had increased to nearly 1200 in 1903.

**CULLEN, PAUL** (1803-1878), cardinal and archbishop of Dublin, was born near Ballytore, Co. Kildare, and educated first at the Quaker school at Carlow and afterwards at Rome, where he joined the Urban College of the Propaganda and, after passing a brilliant course, was ordained in 1829. He then became vice-rector, and afterwards rector, of the Irish National College in Rome; and during the Mazzini revolution of 1848 he was rector of the Urban College, saving the property under the protection of the American flag. In 1849, on the strong recommendation of Archbishop John MacHale of Tuam, Cullen was nominated as successor to the primatial see of Armagh; and, on his return to Ireland, presided as papal delegate at the national council of Thurles in the August of 1850. Taking a strong line on the educational question which was then agitating Ireland, he took a leading part in the national movement of 1850-1852, and at first supported the Tenant Rights League. In May 1852 he was translated to Dublin, and soon a divergence of opinion broke out between him and the more ardent Nationalists under Archbishop MacHale. When the Irish university was started, with Newman, appointed by Cullen, at its head, the scheme was wrecked by the personal opposition to the archbishop of Dublin. As time went on, his distrust of the national movement grew deeper; and in 1853 he sternly forbade his clergy to take part publicly in politics, and for this he was denounced by the *Tablet* newspaper. His own political opinion had best be told in his own words. "For thirty years I have studied the revolution on the continent, and for nearly thirty years I have watched the Nationalist movement in Ireland. It is tainted at its sources with the revolutionary spirit. If any attempt is made to abridge the rights and liberties of the Catholic Church in Ireland, it will not be by the English government nor by a 'No Popery' cry in England, but by the revolutionary and irreligious Nationalists of Ireland" (Purcell's *Life of Manning*, ii. 610). Cullen, therefore, while an ardent patriot, was consistently an opponent of Fenianism. He was made cardinal in 1866, being the first Irish cardinal. Energetic as an administrator, churches and schools rose throughout his diocese; and the excellent Mater Misericordiae Hospital and the seminary at Clonlife are lasting memorials of his zeal. He took part in the Vatican Council as an ardent infallibilist. In 1873 he was defendant in a libel action brought against him by the Rev. R. O'Keeffe, parish priest of Callan, on account of two sentences of ecclesiastical censure pronounced by the cardinal as papal delegate. The damages were laid at £10,000. Three of the four judges allowed the defence of the cardinal to be valid; but it was held that the papal rescript upon which he relied for his extraordinary powers as delegate was illegal under statute; and the lord chief justice decided that the plaintiff could not renounce his natural and civil liberty. After several days' trial, during which Cullen was submitted to a very close examination, the verdict was given for the plaintiff with ¼d. damages. The cardinal died in Dublin on the 24th of October 1878. (E. TN.)

**CULLEN, WILLIAM** (1710-1790), Scottish physician and medical teacher, was born at Hamilton, Lanarkshire, on the 15th of April 1710. He received his early education at the grammar-school of Hamilton, and he appears to have subsequently attended some classes at the university of Glasgow. He began his medical career as apprentice to John Paisley, a

Glasgow surgeon, and after completing his apprenticeship he became surgeon to a merchant vessel trading between London and the West Indies. On his return to Scotland in 1732 he settled as a practitioner in the parish of Shotts, Lanarkshire, and in 1734-1736 studied medicine at Edinburgh, where he was one of the founders of the Royal Medical Society. In 1736 he began to practise in Hamilton, where he rapidly acquired a high reputation. From 1737 to 1740 William Hunter was his resident pupil, and at one time they proposed to enter into partnership. In 1740 Cullen took the degree of M.D. at Glasgow, whither he removed in 1744. During his residence at Hamilton, besides the arduous duties of medical practice, he found time to devote to the study of the natural sciences, and especially of chemistry. On coming to Glasgow he appears to have begun to lecture in connexion with the university, the medical school of which was as yet imperfectly organized. Besides the subjects of theory and practice of medicine, he lectured systematically on botany, materia medica and chemistry. His great abilities, enthusiasm and power of conveying instruction made him a successful and highly popular teacher, and his classes increased largely in numbers. At the same time he diligently pursued the practice of his profession. Chemistry was the subject which at this time seems to have engaged the greatest share of his attention. He was himself a diligent investigator and experimenter, and he did much to encourage original research among his pupils, one of whom was Dr Joseph Black. In 1751 he was appointed professor of medicine, but continued to lecture on chemistry, and in 1756 he was elected joint professor of chemistry at Edinburgh along with Andrew Plummer, on whose death in the following year the sole appointment was conferred on Cullen. This chair he held for ten years—his classes always increasing in numbers. He also practised his profession as a physician with eminent success. From 1757 he delivered lectures on clinical medicine in the Royal Infirmary. This was a work for which his experience, habits of observation, and scientific training peculiarly fitted him, and in which his popularity as a teacher, no less than his power as a practical physician, became more than ever conspicuous. On the death of Charles Alston in 1760, Cullen at the request of the students undertook to finish his course of lectures on materia medica; he delivered an entirely new course, which were published in an unauthorized edition in 1771, but which he re-wrote and issued as *A Treatise on Materia Medica* in 1789.

On the death of Robert Whytt (1714-1766), the professor of the institutes of medicine, Cullen accepted the chair, at the same time resigning that of chemistry. In the same year he had been an unsuccessful candidate for the professorship of the practice of physic, but subsequently an arrangement was made between him and John Gregory, who had gained the appointment, by which they agreed to deliver alternate courses on the theory and practice of physic. This arrangement proved eminently satisfactory, but it was brought to a close by the sudden death of Gregory in 1773. Cullen was then appointed sole professor of the practice of physic, and he continued in this office till a few months before his death, which took place on the 5th of February 1790.

As a lecturer Cullen appears to have stood unrivalled in his day. His clearness of statement and power of imparting interest to the most abstruse topics were the conspicuous features of his teaching, and in his various capacities as a scientific lecturer, a physiologist, and a practical physician, he was ever surrounded with large and increasing classes of intelligent pupils, to whom his eminently suggestive mode of instruction was specially attractive. Living at the time he did, when the doctrines of the humoral pathologists were carried to an extreme extent, and witnessing the ravages which disease made on the solid structures of the body, it was not surprising that he should oppose a doctrine which appeared to him to lead to a false practice and to fatal results, and adopt one which attributed more to the agency of the solids and very little to that of the fluids of the body. His chief works were *First Lines of the Practice of Physic* (1774); *Institutions of Medicine* (1770); and *Synopsis*

*Nosologicae Medicæ* (1785), which contained his classification of diseases into four great classes—(1) Pyrexiae, or febrile diseases, as typhus fever; (2) Neuroses, or nervous diseases, as epilepsy; (3) Cachexiae, or diseases resulting from bad habit of body, as scurvy; and (4) Locales, or local diseases, as cancer.

Cullen's eldest son Robert became a Scottish judge in 1796 under the title of Lord Cullen, and was known for his powers of mimicry.

The first volume of an account of *Cullen's Life, Lectures and Writings* was published by Dr John Thomson in 1832, and was re-issued with the second volume (completing the work) by Drs W. Thomson and D. Craigie in 1859.

**CULLEN**, a royal, municipal and police burgh of Banffshire, Scotland. Pop. (1901) 1936. It is situated on Cullen Bay, 11½ m. W. by N. of Banff and 66½ m. N.W. of Aberdeen by the Great North of Scotland railway. Deskford Burn, after a course of 7½ m., enters the sea at Cullen, which it divides into two parts, Seatown, the older, and Newtown, dating only from 1822. St Mary's, the parish church, a cruciform structure, was founded by Robert Bruce, whose second wife died at Cullen. The industries include rope and sail making, boat-building, brewing and fishing. The harbour, constructed between 1817 and 1834, though artificial, is one of the best on this coast. About 1 m. to the S. is Cullen House, a seat of the earl of Seafield, which contains some fine works of art. A mile and a half to the W. is the picturesque fishing village of Port Knockie with a deep-sea harbour, built in 1891. On the cliffs, 2 m. to the E., stand the ruins of Findlater Castle, fortified in 1455. From 1638 to 1811, when the title expired, it gave the title of earl to the Ogilvies, whose name was adopted in addition to his own by Sir Lewis Alexander Grant, when he succeeded, as 5th earl of Seafield, to the surviving dignities. Five miles to the E. of Cullen is the thriving fishing town of Portsoy, with a small, safe harbour and a station on the Great North of Scotland railway. Besides the fisheries there is fish-curing and a distillery; and the quarrying of a pink-coloured variety of granite and of Portsoy marble is carried on. Good limestone is also found in the district. Pop. (1901) 2061.

**CULLERA**, a seaport of eastern Spain, in the province of Valencia; on the Mediterranean Sea, at the mouth of the river Jucar, and at the southern terminus of the Valencia-Silla-Cullera railway. Pop. (1900) 11,947. Cullera is a walled town, containing a ruined Moorish citadel, large barracks, several churches and convents and a hospital. It occupies the Jucar valley, south of the Sierra de Zorras, a low range of hills which terminates eastward in Cape Cullera, a conspicuous headland surmounted by a lighthouse. To the south and west extends a rich agricultural district, noted for its rice. Besides farming and fishing, the inhabitants carry on a coasting trade with various Mediterranean ports. In 1903 the harbour was entered by 66 vessels of about 25,000 tons, engaged in the exportation of grain, rice and fruit, and the importation of guano. The town of Sueca (q.v.) is 4 m. W.N.W. by rail.

**CULLINAN**, a town of the Transvaal, 36 m. by rail E. by N. of Pretoria. It grew up round the Premier diamond mine and dates from 1903, being named after T. Cullinan, the purchaser of the ground on which the mine is situated. Here was discovered in January 1905 a diamond—the largest on record—weighing 3025½ carats. This diamond was in 1907 presented by the Transvaal government to Edward VII. and was subsequently cut into two stones, one of 516½ carats, the other of 309 carats, intended to ornament the sceptre and crown of England. The "chippings" yielded several smaller diamonds (see DIAMOND).

**CULLODEN**, a desolate tract of moorland, Inverness-shire, Scotland. It forms part of the north-east of Drumrossie Muir, and is situated about 6 m. by road E. of Inverness, and ½ m. from Culloden Muir station on the Highland railway from Aviemore to Inverness via Daviot. It is celebrated as the scene of the battle of the 16th of April 1746 (see CUMBERLAND, WILLIAM AUGUSTUS, DUKE OF, and MURRAY, LORD GEORGE), by which the fate of the house of Stuart was decided. By Highlanders the battle is more generally described as the battle of Drumrossie.

Memorial stones bearing the names of the clans engaged in the conflict were erected in 1881 at the head of each trench where the clansmen—about 1000 in number—were buried. A monumental cairn, 20 ft. high, marks the chief scene of the fight, and the Cumberland Stone, a huge boulder, indicates the spot where the English commander took up his position. A mile to the north is Culloden House, which belonged to Duncan Forbes, the president of the Court of Session. The *Culloden Papers*, a number of historical documents ranging from 1625 to 1748, were discovered in this mansion in 1812 and published in 1815 by Duncan George Forbes. On the death of the 10th laird, the collection of Jacobite relics and works of art was sold by auction in 1897. About 1 m. to the south of the field, on the right bank of the Nairn, is the plain of Clava, containing several stone circles, monoliths, cairns and other prehistoric remains. The circles, some apparently never completed, vary in circumference from 12 yds. to 140 yds.

**CULM**, in geology, the name applied to a peculiar local phase of the Carboniferous system. In 1837 A. Sedgwick and R. I. Murchison classified into two divisions the dark shales, grits and impure limestones which occupy a large area in Devonshire and extend into the neighbouring counties of Somerset and Cornwall. These two divisions were the Upper and Lower Culm Measures, so named from certain impure coals, locally called "culm,"<sup>1</sup> contained within the shales near Bideford. Subsequently, these two geologists, when prosecuting their researches in Germany and Austria, applied the same name to similar rocks which contained, amongst others, *Posidonomya Becheri*, common to the phase of sedimentation in both areas.

The Culm measures of the Devonshire district are folded into a broad syncline with its axis running east and west; but within this major fold the rocks have been subjected to much compression accompanied by minor folding. This circumstance, together with the apparent barrenness of the strata, has always made a correct interpretation of their position and relationships a matter of difficulty; and for long they were regarded as an abnormal expression of the Lower Carboniferous, with the uppermost beds as doubtful equivalents of the Millstone Grit of other parts of Britain. The labours of W. A. E. Ussher and of G. J. Hinde and H. Fox have resulted in the differentiation of the following subdivisions in the Devonshire Culm:—(1) *Upper Culm Measures* or Eggesford grits; (2) *Middle Culm Measures*, comprising the Morchard, Tiverton and Ugbrooke lithological types overlying the Exeter type; (3) *Lower Culm*, the *Posidonomya* limestone and shale overlying the Coddon Hill beds with radiolaria. Ussher's subdivisions were introduced to satisfy the exigencies of geological mapping, but, as he pointed out, while they are necessary in some parts of the district and convenient in others, the lithological characters upon which they are founded are variable and inconstant. More recently E. A. N. Arber (1904–1907) clearly demonstrated that no palaeontological subdivision of the Upper Culm (Middle and Upper) is possible, and that these strata, on the evidence of the fossil plants, represent the Middle Coal Measures of other parts of the country. Wheelton Hind has called attention to the probability that the *Posidonomya* limestone and shale may represent the Pendleside group of Lancashire, Derbyshire, &c. The Coddon Hill beds may belong to this or to a lower horizon. Thus the English Culm measures comprise an Upper Carboniferous and a Lower Carboniferous group, while in Germany, Austria and elsewhere, as it is important to bear in mind, the Culm, or "Kulm," stage is shown by its contained fossils to belong to the lower division alone.

The typical Carboniferous limestone of the Franco-Belgian area changes as it is traced towards the east and south into the sandy, shaly Culm phase, with the characteristic "*Posidonia*" (*Posidonomya*) schists. This aspect of the Culm is found in Saxony, where there are workable coals, in Bohemia, Thuringia, the Fichtelgebirge, the Harz, where the beds are traversed by mineral veins, and in Moravia and Silesia. In the last-mentioned region the thickness of the Culm formation has been estimated

<sup>1</sup> This word is possibly connected with *col*, coal; distinguish "culm," the stem of a plant, Lat. *culmus*.

by D. Stur at over 45,000 ft. In the east and south of the Schiefergebirge (a general term for the slaty mountains of the Hunsrück and Taunus range, the Westerwald and part of the Eifel district), the Culm shales pass upwards into a coarser deposit, the "Culm-grauwacke," which attains a considerable thickness and superficial extent. Culm fossils appear in the Carnic Alps, in the Balkans and parts of Spain, also in Spitzbergen and part of New Guinea.

The most characteristic fossil is of course *Posidonomya Becheri*; others are *Glyphioceras sphaericum*, *Rhodesa patentissima*, *Asterocalamites scrobiculatus* (Schloth), *Lepidodendron veltheimianum*, *Gastrioceras carbonarium*.

See E. A. N. Arber, "On the Upper Carboniferous Rocks of West Devon and North Cornwall," *Q.J.G.S.* lxiii. (1907), which contains a bibliography of the English Culm; E. Holzappel, *Paläont. Abhandl.* Bd. v. Heft i. (1889); H. Potonié, *Abhandl. preuss. geol. Landesanst.*, Neue Folge, 36 (1901); D. Stur, "Die Culm Flora," *Abhandl. k.k. geol. Reichsanst.* viii. (Vienna, 1875). (J. A. H.)

**CULMINATION** (from Lat. *culmen*, summit), the attainment of the highest point. In astronomy the term is given to the passage of a heavenly body over the meridian of a place. Two culminations take place in the course of the day, one above and the other below the pole. The first is called the upper, the second the lower. Either or both may occur below the horizon and therefore be invisible.

**CULPRIT**, properly the prisoner at the bar, one accused of a crime; so used, generally, of one guilty of an offence. In origin the word is a combination of two Anglo-French legal words, *culpable*, guilty, and *prît* or *prist*, i.e. *prest*, Old French for *prêt*, ready. On the prisoner at the bar pleading "not guilty," the clerk of the crown answered "culpable," and stated that he was ready (*prest*) to join issue. The words *cul. prist* (or *prît*) were then entered on the roll as showing that issue had been joined. When French law terms were discontinued the words were taken as forming one word addressed to the prisoner. The formula "Culprit, how will you be tried?" in answer to a plea of "not guilty," is first found in the trial for murder of the 7th earl of Pembroke in 1678.

**CULROSS** (locally pronounced *Coo-rus*), a royal and police burgh, Fifeshire, Scotland, 6½ m. W. by S. of Dunfermline and 2½ m. from East Grange station on the North British railway company's line from Dunfermline to Stirling. Pop. 348. Until 1890 it belonged to the detached portion of Perthshire. Attractively situated on a hillside sloping gently to the Forth, its placid old-world aspect is in keeping with its great antiquity. Here St Serf carried on his missionary labours, and founded a church and cemetery, and here he died and was buried. For centuries the townsfolk used to celebrate his day (July 1st) by walking in procession bearing green boughs. Kentigern, the apostle to Cumbria and first bishop of Glasgow, was born at Culross, his mother having been driven ashore during a tempest, and was adopted by St Serf as his son. These religious associations, coupled with the fertility of the soil, led to the founding of a Cistercian abbey in 1217. Of this structure the only remains are the western tower and the choir, which, greatly altered as well as repaired early in the 19th century, now forms the parish church. It is supposed that a chapel of which some traces exist in the east end of the town was dedicated to Kentigern. James VI. made Culross a royal burgh in 1588. In 1808 there was discovered in the abbey church, embalmed in a silver casket, still preserved there, bearing his name and arms, the heart of Edward, Lord Bruce of Kinloss, who was killed in August 1613 near Bergen-op-Zoom in a duel with Sir Edward Sackville, afterwards earl of Dorset. Robert Pont (1524-1606), the Reformer, was born at Shirresmiln, or Shiresmill, a hamlet in Culross parish. Nearly all its old industries—the coal mines, salt works, linen manufacture, and even the making of iron girdles for the baking of scones—have dwindled, but its pleasant climate and picturesqueness make it a holiday resort. Dunimarle Castle, a handsome structure on the sea-shore, adjoins the site of the castle where, according to tradition, Macbeth slew the wife and children of Macduff. Culross belongs to the Stirling district group of parliamentary burghs.

**CULTIVATOR**,<sup>1</sup> also called SCUFFLER, SCARIFIER or GRUBBER, an agricultural implement employed in breaking up land or in stirring it after ploughing. The first all-iron cultivator, known as Finlayson's grubber, was a large harrow with curved teeth carried on wheels, and was brought out about 1820. It was designed to meet the need for some implement of intermediate character between the plough and harrow, which should stir the soil deeply and expeditiously without reversing it, and bring the weeds unbroken to the surface. The chief modern improvement has been the imparting of vibratory movement and hence greater stirring capacity to the tines, either by making them of spring steel or by fitting springs to the point of attachment of the tine to the framework of the machine. In its

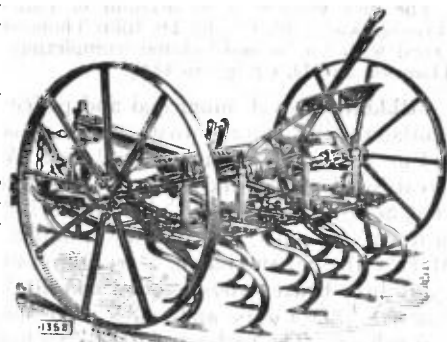

Ransome's Spring Tine Cultivator.

modern form the implement consists of a framework fitted with rows of curved stems or tines, which may be raised clear of the ground or lowered into work by means of a lever, and differs from the harrow in that it is provided with two wheels, which prevent the tines from embedding themselves too deeply in the soil. The stems may be fitted either with chisel-points or with broad shares, according as it is required to merely stir the soil or to bring up weeds and clean the surface. In the disk cultivator revolving disks take the place of tines. The implement is usually provided with a seat for the driver and is drawn by horses, but steam power is also commonly applied to it, the speed of the operation in that case increasing its effectiveness. The method is the same as that of steam-ploughing (see PLOUGH).

**CUMAE** (Gr. *Κύμη*), an ancient city of Campania, Italy, about 12 m. W. of Neapolis, on the W. coast of Campania, on a volcanic eminence, overlooking the plain traversed by the Volturno.

There are many legends as to its foundation, but even the actual period of its colonization by the Greeks is so early (ancient authorities give it as 1050 B.C.) that there is some doubt as to who established it, whether Chalcidians from Euboea or Aeolians from *Κύμη* (Cyme), and it should probably be regarded as a joint settlement. It was certainly, as Strabo says, the oldest of the Greek colonies on the mainland of Italy or in Sicily. Livy tells us (viii. 22) that the settlers first landed on Pithecusae (Ischia) and thence transferred their position to the mainland, which seems a probable story. We find it in 721 B.C. founding Zancle (Messina) in Sicily jointly with Chalcis, and it extended its power gradually over the coast of the Gulf of Puteoli and the harbours of the promontory of Misenum. Puteoli itself under the name Dicaearchia was probably founded by Cumae. In the 7th century, according to the legends, Parthenope, whither the demos of Cumae had taken refuge after an unsuccessful rising against the aristocracy, was attacked by the latter and destroyed, but soon rebuilt under the name of Neapolis (New City, the present Naples).<sup>2</sup> The most fertile portion of the Campanian plain was also under its dominion; the name "fossa Graeca" still lingered on in 205 B.C. to testify to its ancient limits. Cumae was now at the height of its power, and many fine coins testify to its prosperity. In 524 B.C. it was the object of a joint attack by the Etruscans of Capua, the Daunians of the district of Nola, and the Aurunci of the Mons Massicus. A brilliant victory was, however, won in the hilly district outside the town, largely owing

<sup>1</sup> From Late Lat. *cultivare*, through *cultivus*, from *colere*, to till, cultivate; whence *cultus*, worship, form of religion, cult.

<sup>2</sup> Mommsen, however (*Corpus Inscript. Latin.* x., Berlin, 1883, p. 170), rightly throws considerable doubt on the existence of Parthenope and even of Palaeopolis, of which there is some mention in Roman annals; under both he is inclined to trace Cumae itself.

to the bravery of Aristodemus, who then led a force to the relief of Aricia, which was being attacked by the Etruscans, and, returning at the head of his victorious army, overturned the aristocracy and made himself tyrant, but was ultimately murdered by the aristocrats. These were unable to repel a renewed Etruscan attack without the help of Hiero of Syracuse, who in the battle of Cumae of 474 B.C. drove the Etruscan fleet from the sea, and broke their power in Campania.

The Samnites finally destroyed the Etruscan supremacy by the capture of Capua in the latter half of the 5th century (see CAPUA; CAMPANIA), and the Greeks of Cumae were overwhelmed by the same invasion, either in 420 B.C. (Livy iv. 44) or in 421 (Diodor. Sic. xii. 76), if his statement is drawn from Greek sources, 428 if it is to be dated by the Roman consuls to whose year he ascribes it. This catastrophe brought to an end the beautiful series of Greek coins from the town (B. V. Head, *Historia Numorum*, p. 31), and Oscan became its language, though in many respects the Greek character of the town survived (Strabo v. 4. 3, and the other references given by R. S. Conway, *Italic Dialects*, p. 84). One or two inscriptions in Oscan survive (*id. ib.* 88-92), one of which is a Iovila or heraldic dedication. The date of the general disuse of Oscan in the town appears to be fixed about 180 B.C. by the request (Livy xl. 44) which the Cumaeans addressed to Rome that they might be allowed to use Latin for public purposes. Cumae now ceased to have any independent history. It came under the supremacy of Rome in 343 (or 340) as Capua did, obtained the *civitas sine suffragio* and was governed after 318 by the *praefecti Capuam Cumas*.

(R. S. C.)

In the Hannibalic wars it remained faithful to Rome. It probably acquired civic rights in the Social War and remained a *municipium* until Augustus established a colony here. Under the empire it is spoken of as a quiet country town, in contrast to the gay and fashionable Baiae, which, however, with the *lacus Avernus* and *lacus Lucrinus*, formed a part of its territory. Cicero's villa on the east bank of the latter, for example, which he called the Academia, was also known as Cumanum. In the Gothic wars the acropolis of Cumae was, except Naples, the only fortified town in Campania, and it retained its military importance until it was destroyed by the Neapolitans in 1205, since which time it has been deserted.

The acropolis hill (269 ft. above sea-level), a mass of trachyte which has broken through the surrounding tufa, lies hardly 100 yds. from the low sandy shore. It is traversed by caves, which are at three different levels with many branches. Some of them may belong to a remote date, while others may be quarries, but they have not been thoroughly investigated. They are famous in legend as the seat of the oracle of the Cumaean Sibyl.

The acropolis has only one approach, on the south-east; on all other sides it falls away steeply. Remains of fortifications of all ages run round the edge of the hill; some of the original Greek work, in finely hewn rectangular tufa blocks, exists on the east. The medieval line follows the ancient, except on the N.E., where it takes in a larger area.

Within the acropolis stood the temple of Apollo, erected, according to tradition, by Daedalus himself, the remains of which, restored in Roman times, were discovered in 1817, on the eastern and lower summit. On the higher western summit stood another temple, excavated in 1792, but now covered up again. This may be that of the Olympian Zeus (Liv. xxvii. 23).

There are also various remains of buildings of the imperial period, and these are far more frequent on the site of the lower town (now occupied by vineyards) which lies below the acropolis to the south. The line of the city walls can be traced both on the E. and on the W., though the remains on the E. are insignificant, and on the W. (the seaward side) only the scarping of the hill remains. To the S. of the town, just outside the wall, is the amphitheatre. To the N. of it is the point where the roads from Liternum (the Via Domitiana running along the sandy coast), Capua (a branch of the Via Campana), Misenum and Puteoli meet. The last passes through the Arco Felice, an arch

of brick-faced concrete 63 ft. high which spans a cutting through the Monte Grillo, made by Domitian to shorten the course of the road, which had hitherto run farther north. The Grotto della Pace leads to the shores of Avernus. On the E. side of Cumae are considerable remains of the Roman period, among them those of the temple of Demeter, as restored by the family of the Lucceii.

The cemeteries of Cumae extended on all sides of the ancient city, except towards the sea, but the most important lay on the north, between this temple and the Lago di Licola. Excavations during the 19th century in Greek, Samnite and Roman graves have produced many important objects, now in the various museums of Europe, but especially at Naples. Recent discoveries in this necropolis (including that of a circular archaic tomb with a conical roof) have led to considerable discussion as to the true date of the foundation of Cumae, and have made it clear that, in any case, a pre-Hellenic indigenous settlement existed here—a result of great importance.

See J. Beloch, *Campanien* (Breslau, 1890), 145 seq.; G. Pellegrini, *Monumenti dei Lincei*, xiii. (1903); G. Patroni, *Atti del Congresso di Scienze Storiche* (1904), vol. v. p. 215 seq. (T. As.)

**CUMANÁ**, a city and port of Venezuela, capital of the state of Bermudez, situated on the Manzanares river about 1 m. above its mouth, 52 ft. above sea-level and 180 m. E. of Caracas. It is the oldest existing European settlement on the South American continent, having been founded by Diego Castellon in 1523 under the name of Nueva Toledo. The city was almost totally destroyed by an earthquake in 1766, and again in 1797. Slight shocks are very frequent, some of them severe enough to cause considerable damage to the buildings. The mean annual temperature is 83° F. and the climate is enervating. In colonial times the city was rich and prosperous and enjoyed a lucrative trade with the mother country, its population at that time being estimated at 30,000, but much of its prosperity has disappeared and its population is now estimated at 10,000. Excellent fruits are produced in its vicinity, and its exports include cacao, coffee, sugar, hides, tobacco and sundry products in small quantities. A tramway connects the city with its port at the mouth of the Manzanares.

**CUMBERLAND, DUKES AND EARLS OF.** The earldom of Cumberland was held by the family of Clifford (*q.v.*) from 1525 to 1643, when it became extinct by the death of Henry, the 5th earl. The 1st earl of Cumberland was Henry, 11th Lord Clifford (1493-1542), a son of Henry, 10th Lord Clifford (*c.* 1454-1523). Created an earl by Henry VIII. in 1525, Henry remained loyal during the great rising in the north of England in 1536, and died on the 22nd of April 1542. His son and successor, Henry, the 2nd earl (*c.* 1517-1570), married Eleanor (*d.* 1547), a daughter of Charles Brandon, duke of Suffolk, and Mary, daughter of King Henry VII.; he had the tastes of a scholar rather than a soldier, and died early in 1570. By his first wife, Eleanor, he left an only daughter Margaret (1540-1596), who married Henry Stanley, 4th earl of Derby, and who in 1557 was regarded by many as the rightful heiress to the English throne. By his second wife he left two sons and a daughter; his elder son George succeeding to the earldom in 1570, and his younger son Francis succeeding his brother in 1605. George, 3rd earl of Cumberland (1558-1605), was born on the 8th of August 1558, and married Margaret (*c.* 1560-1616), daughter of his guardian, Francis, 2nd earl of Bedford. Although interested in mathematics and geography he passed his early years in dissipation and extravagance; then he took to the sea, commanded the "Bonaventure" against the Spanish Armada, and from this time until his death on the 30th of October 1605 was mainly engaged in fitting out and leading plundering expeditions, some of which, especially the one undertaken in 1580, gained a large amount of booty. The earl left no sons, and his barony was claimed by his only daughter Anne (1590-1676), the wife successively of Richard Sackville, 3rd earl of Dorset, and of Philip Herbert, 4th earl of Pembroke and Montgomery; while his earldom was inherited by his brother Francis (1559-1641). A long law-suit between the new earl and the countess Anne over the possession of the

family estates was settled in 1617. The 5th earl was Francis's only son Henry (1591-1643), who was born on the 28th of February 1591, and was educated at Christ Church, Oxford. He was a supporter of Charles I. during his two short wars with the Scots, and also during the Civil War until his death on the 11th of December 1643. He left no sons; his earldom became extinct; his new barony of Clifford, created in 1628, passed to his daughter Elizabeth (1618-1691), wife of Richard Boyle, earl of Cork and Burlington; and the Cumberland estates to his cousin Anne, countess of Dorset and Pembroke.

In 1644 the English title of duke of Cumberland was created in favour of Rupert, son of Frederick V., elector palatine of the Rhine, and nephew of Charles I. Having lapsed on Rupert's death without legitimate issue in 1682, it was created again in 1689 to give an English title to George, prince of Denmark, who had married the lady who afterwards became Queen Anne. It again became extinct when George died in 1708, but was revived in 1726 in favour of William Augustus, third son of George II. As this duke was never married the title lapsed on his death in 1765, but was revived in the following year in favour of Henry Frederick (1745-1790), son of Frederick, prince of Wales, and brother of George III. Having again become extinct on Henry Frederick's death, the title of duke of Cumberland was created for the fifth time in favour of Ernest Augustus, who was made duke of Cumberland and Teviotdale in 1799. In 1837 Ernest (*q.v.*) became king of Hanover, and on his death in 1851 the title descended with the kingdom of Hanover to his son King George V. (*q.v.*), and on George's death in 1878 to his grandson Ernest Augustus (b. 1845). In 1866 Hanover was annexed by Prussia, but King George died without renouncing his rights. His son Ernest, while maintaining his claim to the kingdom of Hanover, is generally known by his title of duke of Cumberland.

**CUMBERLAND, RICHARD** (1632-1718), English philosopher and bishop of Peterborough, the son of a citizen of London, was born in the parish of St Ann, near Aldersgate. He was educated in St Paul's school, and at Magdalene College, Cambridge, where he obtained a fellowship. He took the degree of B.A. in 1653; and, having proceeded M.A. in 1656, was next year incorporated to the same degree in the university of Oxford. For some time he studied medicine; and although he did not adhere to this profession, he retained his knowledge of anatomy and medicine. He took the degree of B.D. in 1663 and that of D.D. in 1680. Among his contemporaries and intimate friends were Dr Hezekiah Burton, Sir Samuel Morland, who was distinguished as a mathematician, Sir Orlando Bridgeman, who became keeper of the great seal, and Samuel Pepys. To this academical connexion he appears to have been in a great measure indebted for his advancement in the Church. When Bridgeman was appointed lord keeper, he nominated Cumberland and Burton as his chaplains, nor did he afterwards neglect the interest of either. Cumberland's first preferment, bestowed upon him in 1658 by Sir John Norwich, was the rectory of Brampton in Northamptonshire. In 1661 he was appointed one of the twelve preachers of the university. The lord keeper, who obtained his office in 1667, invited him to London, and soon afterwards bestowed upon him the rectory of Allhallows at Stamford, where he acquired new credit by the fidelity with which he discharged his duties. In addition to his ordinary work he undertook the weekly lecture. This labour he constantly performed, and in the meantime found leisure to prosecute his scientific and philological studies.

At the age of forty he published his earliest work, entitled *De legibus naturae disquisitio philosophica, in qua earum forma, summa capita, ordo, promulgatio, et obligatio e rerum natura investigantur; quin etiam elementa philosophiae Hobbiana, cum moralis tum civilis, considerantur et refutantur* (London, 1672). It is dedicated to Sir Orlando Bridgeman, and is prefaced by an "Alloquium ad Lectorem," contributed by Dr Burton. It appeared during the same year as Pufendorf's *De jure naturae et gentium*, and was highly commended in a subsequent publication by Pufendorf, whose approbation must have had the effect of making it known on the continent. Having thus established

a solid reputation, Cumberland next prepared a work on a very different subject—*An Essay towards the Recovery of the Jewish Measures and Weights, comprehending their Monies; by help of ancient standards, compared with ours of England: useful also to state many of those of the Greeks and Romans, and the Eastern Nations* (London, 1686). This work, dedicated to Pepys, obtained a copious notice from Leclerc, and was translated into French.

About this period he was depressed by apprehensions respecting the growth of Popery; but his fears were dispelled by the Revolution, which brought along with it another material change in his circumstances. One day in 1691 he went, according to his custom on a post-day, to read the newspaper at a coffee-house in Stamford, and there, to his surprise, he read that the king had nominated him to the bishopric of Peterborough. The bishop elect was scarcely known at court, and he had resorted to none of the usual methods of advancing his temporal interest.

"Being then sixty years old," says his great-grandson, "he was with difficulty persuaded to accept the offer, when it came to him from authority. The persuasion of his friends, particularly Sir Orlando Bridgeman, at length overcame his repugnance; and to that see, though very moderately endowed, he for ever after devoted himself, and resisted every offer of translation, though repeatedly made and earnestly recommended. To such of his friends as pressed an exchange upon him he was accustomed to reply, that Peterborough was his first espoused, and should be his only one."

He discharged his new duties with energy and kept up his episcopal visitations till his eightieth year. His charges to the clergy are described as plain and unambitious, the earnest breathings of a pious mind. When Dr Wilkins (David Wilke) published the New Testament in Coptic he presented a copy to the bishop, who began to study the language at the age of eighty-three. "At this age," says his chaplain, "he mastered the language, and went through great part of this version, and would often give me excellent hints and remarks, as he proceeded in reading of it." He died in 1718, in the eighty-seventh year of his age; he was found sitting in his library, in the attitude of one asleep, and with a book in his hand.<sup>1</sup> His great-grandson was Richard Cumberland, the dramatist.

Bishop Cumberland was distinguished by his gentleness and humility. He could not be roused to anger, and spent his days in unbroken serenity. The basis of his ethical theory is Benevolence, and is the natural outcome of his temperament. He was a man of a sound understanding, improved by extensive learning, and left behind him several monuments of his talents and industry. His favourite motto was that a man had better "wear out than rust out."

The philosophy of Cumberland is expounded in the treatise *De legibus naturae*. The merits of the work are almost confined to its speculative theories; its style is destitute of strength and grace, and its reasoning is diffuse and unmethodical. Its main design is to combat the principles which Hobbes had promulgated as to the constitution of man, the nature of morality, and the origin of society, and to prove that self-advantage is not the chief end of man, that force is not the source of personal obligation to moral conduct nor the foundation of social rights, and that the state of nature is not a state of war. The views of Hobbes seem

<sup>1</sup> The care of his posthumous publications devolved upon his domestic chaplain and son-in-law, Squier Payne, who soon after the bishop's death edited "*Sanchoniat's Phoenician History*, translated from the first book of Eusebius, *De praeparatione evangelica*: with a continuation of Sanchoniat's history of Eratosthenes Cyrenaeus's Canon, which Dicaearchus connects with the first Olympiad. These authors are illustrated with many historical and chronological remarks, proving them to contain a series of Phoenician and Egyptian chronology, from the first man to the first Olympiad, agreeable to the Scripture accounts" (London, 1720). The preface contains an account of the life, character and writings of the author, which was likewise published in a separate form, and exhibits a pleasing picture of his happy old age. A German translation appeared under the title of *Cumberland's phönizische Historie des Sanchoniatoms*, übersetzt von Joh. Phil. Cassel (Magdeburg, 1755). The sequel to the work was likewise published by Payne—*Origines gentium antiquissimae; or Attempts for discovering the Times of the First Planting of Nations: in several Tracts* (London, 1724).



to Cumberland utterly subversive of religion, morality and civil society, and he endeavours, as a rule, to establish directly antagonistic propositions. He refrains, however, from denunciation, and is a fair opponent up to the measure of his insight.

Laws of nature are defined by him as "immutably true propositions regulative of voluntary actions as to the choice of good and the avoidance of evil, and which carry with them an obligation to outward acts of obedience, even apart from civil laws and from any considerations of compacts constituting government." This definition, he says, will be admitted by all parties. Some deny that such laws exist, but they will grant that this is what ought to be understood by them. There is thus common ground for the two opposing schools of moralists to join issue. The question between them is, Do such laws exist or do they not? In reasoning thus Cumberland obviously forgot what the position maintained by his principal antagonist really was. Hobbes must have refused to accept the definition proposed. He did not deny that there were laws of nature, laws antecedent to government, laws even in a sense eternal and immutable. The virtues as means to happiness seemed to him to be such laws. They precede civil constitution, which merely perfects the obligation to practise them. He expressly denied, however, that "they carry with them an obligation to outward acts of obedience, even apart from civil laws and from any consideration of compacts constituting governments." And many besides Hobbes must have felt dissatisfied with the definition. It is ambiguous and obscure. In what sense is a law of nature a "proposition"? Is it as the expression of a constant relation among facts, or is it as the expression of a divine commandment? A proposition is never in itself an ultimate fact although it may be the statement of such a fact. And in what sense is a law of nature an "immutably true" proposition? Is it so because men always and everywhere accept and act on it, or merely because they always and everywhere ought to accept and act on it? The definition, in fact, explains nothing.

The existence of such laws may, according to Cumberland, be established in two ways. The inquirer may start either from effects or from causes. The former method had been taken by Grotius, Robert Sharrock (1630-1684) and John Selden. They had sought to prove that there were universal truths, entitled to be called laws of nature, from the concurrence of the testimonies of many men, peoples and ages, and through generalizing the operations of certain active principles. Cumberland admits this method to be valid, but he prefers the other, that from causes to effects, as showing more convincingly that the laws of nature carry with them a divine obligation. It shows not only that these laws are universal, but that they were intended as such; that man has been constituted as he is in order that they might be. In the prosecution of this method he expressly declines to have recourse to what he calls "the short and easy expedient of the Platonists," the assumption of innate ideas of the laws of nature. He thinks it ill-advised to build the doctrines of natural religion and morality on a hypothesis which many philosophers, both Gentile and Christian, had rejected, and which could not be proved against Epicureans, the principal impugners of the existence of laws of nature. He cannot assume, he says, that such ideas existed from eternity in the divine mind, but must start from the data of sense and experience, and thence by search into the nature of things discover their laws. It is only through nature that we can rise to nature's God. His attributes are not to be known by direct intuition. He, therefore, held that the ground taken up by the Cambridge Platonists could not be maintained against Hobbes. His sympathies, however, were all on their side, and he would do nothing to diminish their chances of success. He would not even oppose the doctrine of innate ideas, because it looked with a friendly eye upon piety and morality. He granted that it might, perhaps, be the case that ideas were *both* born with us and afterwards impressed upon us from without.

Cumberland's ethical theory (see ETHICS) is summed up in his principle of universal Benevolence, the one source of moral good. "No action can be morally good which does not in its own nature

contribute somewhat to the happiness of men." The theory is important in comparison (1) with that of Hobbes, and (2) with modern utilitarianism.

1. Cumberland's Benevolence is, deliberately, the precise antithesis to the Egoism of Hobbes. To this fact it owes its existence and also its extravagance. Feeling that the most forcible method of attacking Hobbes was to assert the opposite in the same form, he maintained that the whole-hearted pursuit of the good of all contributes to the good of each and brings personal happiness; that the opposite process involves misery to individuals including the self. If, then, Hobbes went to the one extreme of postulating selfishness as the sole motive of human action, Cumberland was equally extravagant as regards Benevolence. The testimony of history shows, *prima facie* at least, that both motives have operated throughout, and just as self-interest has been increasingly modified by conscious benevolence, so benevolence alone does not explain all personal virtue nor love to God. But it is essential to notice that Cumberland never appealed to the evidence of history, although he believed that the law of universal benevolence had been accepted by all nations and generations; and he carefully abstains from arguments founded on revelation, feeling that it was indispensable to establish the principles of moral right on nature as a basis. His method was the deduction of the propriety of certain actions from the consideration of the character and position of rational agents in the universe. He argues that all that we see in nature is framed so as to avoid and reject what is dangerous to the integrity of its constitution; that the human race would be an anomaly in the world had it not for end its conservation in its best estate; that benevolence of all to all is what in a rational view of the creation is alone accordant with its general plan; that various peculiarities of man's body indicate that he has been made to co-operate with his fellow men and to maintain society; and that certain faculties of his mind show the common good to be more essentially connected with his perfection than any pursuit of private advantage. The whole course of his reasoning proceeds on, and is pervaded by, the principle of final causes.

2. To the question, What is the foundation of rectitude?, he replies, the greatest good of the universe of rational beings. He may be regarded as the founder of English utilitarianism, but his utilitarianism is distinct from what is known as the selfish system; it goes to the contrary extreme, by almost absorbing individual in universal good. Nor does it look merely to the lower pleasures, the pleasures of sense, for the constituents of good, but rises above them to include especially what tends to perfect, strengthen and expand our true nature. Existence and the extension of our powers of body and mind are held to be good for their own sakes without respect to enjoyment. Cumberland's views on this point were long abandoned by utilitarians as destroying the homogeneity and self-consistency of their theory; but J. S. Mill and some recent writers have reproduced them as necessary to its defence against charges not less serious than even inconsistency.

The answer which Cumberland gives to the question, Whence comes our obligation to observe the laws of nature?, is that happiness flows from obedience, and misery from disobedience to them, not as the mere results of a blind necessity, but as the expressions of the divine will. Reward and punishment, supplemented by future retribution, are, in his view, the sanctions of the laws of nature, the sources of our obligation to obey them. To the other great ethical question, How are moral distinctions apprehended?, he replies that it is by means of right reason. But by right reason he means merely the power of rising to general laws of nature from particular facts of experience. It is no peculiar faculty or distinctive function of mind; it involves no original element of cognition; it begins with sense and experience; it is gradually generated and wholly derivative. This doctrine lies only in germ in Cumberland, but will be found in full flower in Hartley, Mackintosh and later associationists.

BIBLIOGRAPHY.—Editions of the *De legibus naturae* (Lübeck, 1683 and 1694; English versions by John Maxwell, prebendary of

Connor, *A Treatise of the Laws of Nature* (London, 1727), and John Towers (Dublin, 1750); French translation by Jean Barbeyrac (Amsterdam, 1744); James Tyrrell (1642-1718), grandson of Archbishop Ussher, published an abridgment of Cumberland's views in *A Brief Disquisition of the Laws of Nature according to the Principles laid down in the Rev. Dr Cumberland's Latin Treatise* (London, 1692; ed. 1701). For biographical details see Squier Payne, *Account of the Life and Writings of R. Cumberland* (London, 1720); Cumberland's *Memoirs* (1807), i. 3-6; Pepys's *Diary*. For his philosophy, see E. Albee, *Philosophical Review*, iv. 3 (1895), pp. 264 and 371; F. E. Spaulding, *R. Cumberland als Begründer der englischen Ethik* (Leipzig, 1894); and text-books on ethics.

**CUMBERLAND, RICHARD** (1732-1811), English dramatist, was born in the master's lodge of Trinity College, Cambridge, on the 19th of February 1732. He was the great-grandson of the bishop of Peterborough; and his father, Dr Denison Cumberland, became successively bishop of Clonfert and of Kilmore. His mother was Joanna, the youngest daughter of the great scholar Richard Bentley, and the heroine of John Byrom's once popular little eclogue, *Colin and Phoebe*. Of the great master of Trinity his grandson has left a kindly account; he afterwards collected all the pamphlets bearing on the *Letters of Phalaris* controversy, and piously defended the reputation of his ancestor in his *Letter to Bishop Lowth*, who had called Bentley "aut caprimulgus aut fossor." Cumberland was in his seventh year sent to the grammar-school at Bury St Edmunds, and he relates how, on the head-master Arthur Kinsman undertaking, in conversation with Bentley, to make the grandson as good a scholar as the grandfather himself, the latter retorted: "Pshaw, Arthur, how can that be, when I have forgot more than thou ever knewest?" Bentley died during his grandson's Bury school-days; and in 1744 the boy, who, while rising to the head of his school, had already begun to "try his strength in several slight attempts towards the drama," was removed to Westminster, then at the height of its reputation under Dr Nicholls. Among his schoolfellows here were Warren Hastings, George Colman (the elder), Lloyd, and (though he does not mention them as such) Churchill and Cowper. From Westminster Cumberland passed, in his fourteenth year, to Trinity College, Cambridge, where in 1750 he took his degree as tenth wrangler. His account of his degree examination, as well as that for a fellowship at his college, part of which he underwent in the "judges' chamber," where he was born, is curious; he was by virtue of an alteration in the statutes elected to his fellowship in the second year of his degree.

Meanwhile his projects of work as a classical scholar had been interspersed with attempts at imitating Spenser—whom, by his mother's advice, he "laid upon the shelf"—and a dramatic effort (unprinted) on the model of Mason's *Elfrida*, called *Caractacus*. He had just begun to read for his fellowship, when he was offered the post of private secretary by the earl of Halifax, first lord of trade and plantations in the duke of Newcastle's ministry. His family persuaded him to accept the office, to which he returned after his election as fellow. It left him abundant leisure for literary pursuits, which included the design of a poem in blank verse on India. He resigned his Trinity fellowship on his marriage—in 1759—to his cousin Elizabeth Ridge, to whom he had paid his addresses on receiving through Lord Halifax "a small establishment as crown-agent for Nova Scotia." In 1761 he accompanied his patron (who had been appointed lord-lieutenant) to Ireland as Ulster secretary; and in acknowledgment of his services was afterwards offered a baronetcy. By declining this he thinks he gave offence; at all events, when in 1762 Halifax became secretary of state, Cumberland in vain applied for the post of under-secretary, and could only obtain the clerkship of reports at the Board of Trade under Lord Hillsborough. While he takes some credit to himself for his incorruptibility when in Ireland, he showed zeal for his friend and secured a bishopric for his father. On the accession to office of Lord George Germaine (Sackville) in 1775, Cumberland was appointed secretary to the Board of Trade and Plantations, which post he held till the abolition of that board in 1782 by Burke's economical reform. Before this event he had, in 1780, been sent on a confidential mission to Spain, to negotiate a

separate treaty of peace with that power; but though he was well received by King Charles III. and his minister Floridablanca, the question of Gibraltar proved a stumbling-block, and the Gordon riots at home a most untoward occurrence. He was recalled in 1781, and was refused repayment of the expenses he had incurred, towards which only £1000 had been advanced to him. He thus found himself £4500 out of pocket: in vain, he says, "I wearied the door of Lord North till his very servants drove me from it"; his memorial remained unread or unnoticed either by the prime minister or by secretary Robinson, through whom the original promise had been made. Soon after this experience he lost his office, and had to retire on a compensation allowance of less than half-pay. He now took up his residence at Tunbridge Wells; but during his last years he mostly lived in London, where he died on the 7th of May 1811. He was buried in Westminster Abbey, a short oration being pronounced on this occasion by his friend Dean Vincent.

Cumberland's numerous literary productions are spread over the whole of his long life; but it is only by his contributions to the drama, and perhaps by his *Memoirs*, that he is likely to be remembered. The collection of essays and other pieces entitled *The Observer* (1785), afterwards republished together with a translation of *The Clouds*, found a place among *The British Essayists*. For the accounts given in *The Observer* of the Greek writers, especially the comic poets, Cumberland availed himself of Bentley's MSS. and annotated books in his possession; his translations from the Greek fragments, which are not inelegant but lack closeness, are republished in James Bailey's *Comicoorum Graecorum* (part i., 1840) and *Hermesianactis, Archilochi, et Pratinæ fragmenta*. Cumberland further produced *Anecdotes of Eminent Painters in Spain* (1782 and 1787); a *Catalogue of the King of Spain's Paintings* (1787); two novels—*Arundel* (1789), a story in letters, and *Henry* (1795), a "diluted comedy" on the construction and polishing of which he seems to have expended great care; a religious epic, *Calvary, or the Death of Christ* (1792); his last publication was a poem entitled *Retrospection*. He is also supposed to have joined Sir James Bland Burges in an epic, the *Exodiad* (1807), and in *John de Lancaster*, a novel. Besides these he wrote the *Letter to the Bishop of Oxford* in vindication of Bentley (1767); another to the *Bishop of Llandaff* (Richard Watson) on his proposal for equalizing the revenues of the Established Church (1783); a *Character of the late Lord Sackville* (1785), whom in his *Memoirs* he vindicates from the stigma of cowardice; and an anonymous pamphlet, *Curtius rescued from the Gulf*, against the redoubtable Dr Parr. He was also the author of a version of fifty of the Psalms of David; of a tract on the evidences of Christianity; and of other religious exercises in prose and verse, the former including "as many sermons as would make a large volume, some of which have been delivered from the pulpits." Lastly, he edited, in 1809, a short-lived critical journal called *The London Review*, intended to be a rival to the *Quarterly*, with signed articles.

Cumberland's *Memoirs*, which he began at the close of 1804, and concluded in September 1805, were published in 1806, and a supplement was added in 1807. This narrative, which includes a long account of his Spanish mission, contains some interesting reminiscences of several persons of note—more especially Bubb Dodington, Single-Speech Hamilton, and Lord George Sackville among politicians, and of Garrick, Foote and Goldsmith; but the accuracy of some of the anecdotes concerning the last-named is not beyond suspicion. The book exhibits its author as an amiable egotist, careful of his own reputation, given to prolixity and undistinguished by wit, but a good observer of men and manners. The uneasy self-absorption which Sheridan immortalized in the character of Sir Fretful Plagiary in *The Critic* is apparent enough in this autobiography, but presents itself there in no offensive form. The incidental criticisms of actors have been justly praised.

Cumberland was hardly warranted in the conjecture that no English author had yet equalled his list of dramas in point of number; but his plays, published and unpublished, have been

computed to amount to fifty-four. About 35 of these are regular plays, to which have been added 4 operas and a farce; and about half of the whole list are comedies. The best known of them belong to what he was pleased to term "legitimate comedy," and to that species of it known as "sentimental." The essential characteristic of these plays is the combination of plots of domestic interest with the rhetorical enforcement of moral precepts, and with such small comic humour as the author possesses. These comedies are primarily, to borrow Cumberland's own phraseology, designed as "attempts upon the heart." He takes great credit to himself for weaving his plays out of "homely stuff, right British druggut," and for eschewing "the vile refuse of the Gallic stage"; on the other hand, he borrowed from the sentimental fiction of his own country, including Richardson, Fielding and Sterne. The favourite theme of his plays is virtue in distress or danger, but safe of its reward in the fifth act; their most constant characters are men of feeling and young ladies who are either prudes or coquettes. Cumberland's comic power—such as it was—lay in the invention of comic characters taken from the "outskirts of the empire," and professedly intended to vindicate from English prejudice the good elements in the Scotch, the Irish and the colonial character. For the rest, patriotic sentiment liberally asserts itself by the side of general morality. If Cumberland's dialogue lacks brilliance and his characters reality, the construction of the plots is as a rule, skilful, and the situations are contrived with what Cumberland indisputably possessed—a thorough insight into the secrets of theatrical effect. It should be added that, though Cumberland's sentimentality is often wearisome, his morality is generally sound; that if he was without the genius requisite for elevating the national drama, he did his best to keep it pure and sweet; and that if he borrowed much, as he undoubtedly did, it was not the vicious attractions of other dramatists of which he was the plagiarist.

His début as a dramatic author was made with a tragedy, *The Banishment of Cicero*, published in 1761 after its rejection by Garrick; this was followed in 1765 by a musical drama, *The Summer's Tale*, subsequently compressed into an afterpiece *Amelia* (1768). Cumberland first essayed sentimental comedy in *The Brothers* (1769). The theme of this comedy is inspired by Fielding's *Tom Jones*; its comic characters are the jolly old tar Captain Ironsides, and the henpecked husband Sir Benjamin Dove, whose progress to self-assertion is genuinely comic, though not altogether original. Horace Walpole said that it acted well, but read ill, though he could distinguish in it "strokes of Mr Bentley." The epilogue paid a compliment to Garrick, who helped the production of Cumberland's second comedy *The West-Indian* (1771). The hero of this comedy, which probably owes much to the suggestion of Garrick, is a young scapegrace fresh from the tropics, "with rum and sugar enough belonging to him to make all the water in the Thames into punch,"—a libertine with generous instincts, which in the end prevail. This early example of the modern *drame* was received with the utmost favour; it was afterwards translated into German by Boden, and Goethe acted in it at the Weimar court. *The Fashionable Lover* (1772) is a sentimental comedy of the most pronounced type. *The Choleric Man* (1774), founded on the *Adelphi* of Terence, is of a similar type, the comic element rather predominating, but philanthropy being duly represented by a virtuous lawyer called Manlove. Among his later comedies may be mentioned *The Natural Son* (1785), in which Major O'Flaherty who had already figured in *The West-Indian*, makes his reappearance; *The Impostors* (1789), a comedy of intrigue; *The Box Lobby Challenge* (1794), a protracted farce; *The Jew* (1794), a serious play, highly effective when the character of Sheva was played by the great German actor Theodor Döring; *The Wheel of Fortune* (1795), in which John Kemble found a celebrated part in the misanthropist Penruddock, who cannot forget but learns to forgive (a character declared by Kotzebue to have been stolen from his *Menschenhass und Reue*), while the lawyer Timothy Weasel was made comic by Richard Suett; *First Love* (1795); *The Last of the Family* (1795); *False*

*Impressions* (1797); *The Sailor's Daughter* (1804); and a *Hint to Husbands* (1806), which, unlike the rest, is in blank verse. The other works printed during his lifetime include *The Note of Hand* (1774), a farce; the songs of his musical comedy, *The Widow of Delphi* (1780); his tragedies of *The Battle of Hastings* (1778); and *The Carmelite* (1784), a romantic domestic drama in blank verse, in the style of Home's *Douglas*, furnishing some effective scenes for Mrs Siddons and John Kemble as mother and son; and the domestic drama (in prose) of *The Mysterious Husband* (1783). His posthumously printed plays (published in 2 vols. in 1813) include the comedies of *The Walloons* (acted in 1782); *The Passive Husband* (acted as *A Word for Nature*, 1798); *The Eccentric Lover* (acted 1798); and *Lovers' Resolutions* (once acted in 1802); the serious quasi-historic drama *Confession*; the drama *Don Pedro* (acted 1796); and the tragedies of *Alcanor* (acted as *The Arab*, 1785); *Torrendal*; *The Sibyl, or The Elder Brutus* (afterwards amalgamated with other plays on the subject into a very successful tragedy for Edmund Kean by Payne); *Tiberius in Capreae*; and *The False Demetrius* (on a theme which attracted Schiller). Cumberland translated the *Clouds* of Aristophanes (1797), and altered for the stage Shakespeare's *Timon of Athens* (1771), Massinger's *The Bondman* and *The Duke of Milan* (both 1779).

In 1806–1807 appeared *Memoirs of R. Cumberland, written by himself*. Cumberland's novel, *Henry*, was printed in Ballantyne's Novelists' Library (1821), with a prefatory notice of the author by Sir Walter Scott. A so-called *Critical Examination* of Cumberland's works and a memoir of the author based on his autobiography, with the addition of some more or less feeble criticisms, by William Madford, appeared in 1812. An excellent account of Cumberland is included in "George Paston's" *Little Memoirs of the Eighteenth Century* (1901). Hettner well characterizes Cumberland's position in the history of the English drama in *Literaturgesch. d. 18. Jahrhunderts* (2nd ed., 1865), i. 520. Cumberland's portrait by Romney (whose talent he was one of the first to encourage) is in the National Portrait Gallery. (A. W. W.)

**CUMBERLAND, WILLIAM AUGUSTUS, DUKE OF** (1721–1765), son of King George II. and Queen Caroline, was born on the 15th of April 1721, and when five years of age was created duke of Cumberland. His education was well attended to, and his courage and capacity in outdoor exercises were notable from his early years. He was intended by the king and queen for the office of lord high admiral, and in 1740 he sailed as a volunteer in the fleet under the command of Sir John Norris; but he quickly became dissatisfied with the navy, and early in 1742 he began a military career. In December 1742 he was made a major-general, and in the following year he first saw active service in Germany. George II. and the "martial boy" shared in the glory of Dettingen (June 27), and Cumberland, who was wounded in the action, displayed an energy and valour, the report of which in England founded his military popularity. After the battle he was made lieutenant-general. In 1745, having been made captain-general of the British land forces at home and in the field, the duke was again in Flanders as commander-in-chief of the allied British, Hanoverian, Austrian and Dutch troops. Advancing to the relief of Tournay, which was besieged by Marshal Saxe, he engaged that great general in the battle of Fontenoy (*q. v.*) on the 11th of May. It cannot now be doubted that, had the duke been supported by the allies in his marvellously courageous attack on the superior positions of the French army, Fontenoy would not have been recorded as a defeat to the British arms. He himself was in the midst of the heroic column which penetrated the French centre, and his conduct of the inevitable retreat was unusually cool and skilful.

Notwithstanding the severity of his discipline, the young duke had the power to inspire his men with a strong attachment to his person and a very lively *esprit de corps*. As a general his courage and resolution were not sufficiently tempered with sagacity and tact; but he displayed an energy and power in military affairs which pointed him out to the British people as the one commander upon whom they could rely to put a decisive stop to the successful career of Prince Charles Edward in the rebellion of 1745–1746. John (Earl) Ligonier wrote of him at this time: "Ou je suis fort trompé ou il se forme là un grand capitaine."

He was recalled from Flanders, and immediately proceeded with his preparations for quelling the insurrection. He joined the midland army under Sir John Ligonier, and was at once in pursuit of his swift-footed foe. But the retreat of Charles Edward from Derby disconcerted his plans; and it was not till they had reached Penrith, and the advanced portion of his army had been repulsed on Clifton Moor, that he became aware how hopeless an attempt to overtake the retreating Highlanders would then be. Carlisle having been retaken, he retired to London, till the news of the defeat of Hawley at Falkirk roused again the fears of the English people, and centred the hopes of Britain on the royal duke. He was appointed commander of the forces in Scotland.

Having arrived in Edinburgh on the 30th of January 1746, he at once proceeded in search of the young Pretender. He diverged, however, to Aberdeen, where he employed his time in training the well-equipped forces now under his command for the peculiar nature of the warfare in which they were about to engage. What the old and experienced generals of his time had failed to accomplish or even to understand, the young duke of Cumberland, as yet only twenty-four years of age, effected with simplicity and ease. He prepared to dispose his army so as to withstand with firmness that onslaught on which all Highland successes depended; and he reorganized the forces and restored their discipline and self-confidence in a few weeks.

On the 8th of April 1746 he set out from Aberdeen towards Inverness, and on the 15th he fought the decisive battle of Culloden, in which, and in the pursuit which followed, the forces of the Pretender were completely destroyed. He had become convinced that the sternest measures were needed to break down the Jacobitism of the Highlanders. He told his troops to take notice that the enemy's orders were to give no quarter to the "troops of the elector," and they took the hint. No trace of such orders remains (see MURRAY, LORD GEORGE), and it is probable that Cumberland had merely received word of wild talk in the enemy's camp, which he credited the more easily as he thought that those who were capable of rebellion were capable of any crime. On account of the merciless severity with which the fugitives were treated, Cumberland received the nickname of the "Butcher." That the implied taunt was unjust need not be laboured. It was used for political purposes in England, and his own brother, the prince of Wales, encouraged, it appears, the virulent attacks which were made upon the duke. In any case there is a marked similarity between Cumberland's conduct in Scotland and that of Cromwell in Ireland. Both dared to do acts which they knew would be cast against them for the rest of their lives, and terrorized an obstinate and unyielding enemy into submission. How real was the danger of a protracted guerrilla warfare in the Highlands may be judged from the explicit declarations of Jacobite leaders that they intended to continue the struggle. As it was, the war came to an end almost at once. Here, as always, Cumberland preserved the strictest discipline in his camp. He was inflexible in the execution of what he deemed to be his duty, without favour to any man. At the same time he exercised his influence in favour of clemency in special cases that were brought to his notice. Some years later James Wolfe spoke of the duke as "for ever doing noble and generous actions."

The relief occasioned to Britain by the duke's victorious efforts was acknowledged by his being voted an income of £40,000 per annum in addition to his revenue as a prince of the royal house. The duke took no part in the Flanders campaign of 1746, but in 1747 he again opposed the still victorious Marshal Saxe; and received a heavy defeat at the battle of Lauffeld, or Val, near Maestricht (2nd of July 1747). During the ten years of peace Cumberland occupied himself chiefly with his duties as captain-general, and the result of his work was clearly shown in the conduct of the army in the Seven Years' War. His unpopularity, which had steadily increased since Culloden, interfered greatly with his success in politics, and when the death of the prince of Wales brought a minor next in succession to the throne the duke was not able to secure for himself the contingent

regency, which was vested in the princess-dowager of Wales. In 1757, the Seven Years' War having broken out, Cumberland was placed at the head of a motley army of allies to defend Hanover. At Hastenbeck, near Hameln, on the 26th of July 1757, he was defeated by the superior forces of D'Estrées (see SEVEN YEARS' WAR). In September of the same year his defeat had almost become disgrace. Driven from point to point, and at last hemmed in by the French under Richelieu, he capitulated at Klosterzeven on the 8th of the month, agreeing to disband his army and to evacuate Hanover. His disgrace was completed on his return to England by the king's refusal to be bound by the terms of the duke's agreement. In chagrin and disappointment he retired into private life, after having formally resigned the public offices he held. In his retirement he made no attempt to justify his conduct, applying in his own case the discipline he had enforced in others. For a few years he lived quietly at Windsor, and subsequently in London, taking but little part in politics. He did much, however, to displace the Bute ministry and that of Grenville, and endeavoured to restore Pitt to office. Public opinion had now set in his favour, and he became almost as popular as he had been in his youth. Shortly before his death the duke was requested to open negotiations with Pitt for a return to power. This was, however, unsuccessful. On the 31st of October 1765 the duke died.

A *Life of the duke of Cumberland* by Andrew Henderson was published in 1766, and anonymous (Richard Rolt) *Historical Memoirs* appeared in 1767. See especially A. N. Campbell Maclachlan, *William Augustus, Duke of Cumberland* (1876).

**CUMBERLAND**, the north-westernmost county of England, bounded N. by the Scottish counties of Dumfries and Roxburgh, E. by Northumberland, S. by Westmorland and Lancashire, and W. by the Irish Sea. Its area is 1520.4 sq. m. In the south the county includes about one-half of the celebrated LAKE DISTRICT (*q.v.*), with the highest mountain in England, Scafell Pike (3210 ft.), and the majority of the principal lakes, among which are Derwentwater and Bassenthwaite, Buttermere and Crummock Water, Ennerdale, Westwater, and, on the boundary with Westmorland, Ullswater. From this district valleys radiate north, west and south to a flat coastal belt, the widest part of which (about 8 m.) is found in the north in the Solway Plain, bordering Solway Firth, which here intervenes between England and Scotland. The valley of the Eden, opening upon this plain from the south-east, separates the mountainous Lake District from the straight westward face of a portion of the Pennine Chain (*q.v.*), which, though little of it lies within this county, reaches its highest point within it in Cross Fell (2930 ft.). A well-marked pass, called the Tyne Gap, at the water-parting between the rivers Irthing and South Tyne, traversed by the Newcastle & Carlisle railway, intervenes between these hills and their northward continuation in the hills of the Scottish border. Besides the waters of the Eden, Solway Firth receives those of the Esk, which enter Cumberland from Scotland. Liddel Water, joining this river from the north east from Liddisdale, forms a large part of the boundary with Scotland. The Eden receives the Irthing from the east, and from the Lake District the Caldew, rising beneath Skiddaw and joining the main river at Carlisle, and the Eamont, draining Ullswater and forming part of the boundary with Westmorland. The principal streams flowing east and south from the Lake District are the Derwent, from Borrowdale and Derwentwater, the Eden from Ennerdale, the Esk from Eskdale, and the Duddon, forming the greater part of the boundary with Lancashire. There are valuable salmon fisheries in the Eden, and trout are taken in many of the streams and lakes.

*Geology.*—The mountainous portion of Cumberland is built up of two different types of rock. The older, a sedimentary slaty series of Ordovician age, the Skiddaw slates, surrounds Bassenthwaite, Saddleback, Crummock Water, Keswick and Cockermouth and the western end of Ennerdale Water. The same formation is found in the northern flanks of Ullswater also north and east of Whitbeck. The other type of rock is volcanic; it gives a more rugged aspect to the scenery, as may be seen in comparing the rough outlines of Scafell and Honister Crags or Helvellyn with the smoother form of Saddleback or Skiddaw. These volcanic rocks, owing to much

alteration, are often slaty; they have been called the "green slates and porphyries" or the Borrowdale Series. The Skiddaw slates are usually separated from the newer green slates above them by a plane of differential movement, for both have been thrust by earth-pressures from south to north, but the former rocks have travelled farther than the latter which have lagged behind; hence Messrs Marr and Harker describe the plane of separation as a "lag-fault." Much general faulting and folding have resulted from the movement; the thrusting took place in Devonian times. About the same period great masses of granitic rock were intruded into the slates in the form of laccolites, which often lie along the lag planes. Such rocks are the granophyre hills of Buttermere and Ennerdale, the micro-granite patches on either side of the Vale of St John, and the great mass of Eskdale granite which reaches from Wastwater to the flanks of Black Combe. At Carrock Fell, N.E. of Skiddaw, is an extremely interesting complex of volcanic rocks, and in many other places are diabase and other forms, e.g. the well-known rock at Castle Head, Keswick.

From Pooley Bridge, Ullswater, on the east, by Udale round to Egremont on the west, the mountainous region just described, is surrounded by the Carboniferous Limestone series, with a conglomerate at the base. Upon these rocks the coalfield of Whitehaven rests and extends as far as Maryport. The coal seams are worked for some distance beneath the sea. The vale of Eden between Penrith, Hornsby and Wreay is occupied by Permian sandstone, usually bright red in colour. Red Triassic rocks form a strip about 4 m. broad east of the Permian outcrop; a similar strip forms a coastal fringe from St Bees Head to Duddon Sands. The same formations are spread out round Carlisle, Brampton, Longtown, Wigton and Aspatria. East of Carlisle they are covered by an outlier of Lias. A great dislocation, the Pennine Fault, runs along the eastern side of the vale of Eden; it throws up the Lower Carboniferous limestones with their associated shales and sandstones to form the elevated ground in the north and north-east of the county. Several basic intrusions penetrate the limestone series, the best known being the Whin Sill, which may be traced for a number of miles northward from Crossfell. Evidences of glacial action are abundant; till with sands and gravel lie on the lower ground; striated rocks and *roches moutonnées* are common; perched blocks are found on the plateau by Sprinkling Tarn and elsewhere. Moraine mounds are quite numerous in the valleys, and have frequently been the cause of small lakes.

*Climate and Agriculture.*—The climate is generally temperate, but in the higher parts bleak, snow sometimes lying fully six months of the year on Cross Fell and the mountains of the Lake District. As regards rainfall, the physical configuration makes for contrast. At Carlisle, on the Solway plain, the mean annual fall is 30.6 in. At Penrith, on the north-eastern flank of the Lake District, it is 31.67; on the western flank 42.3 in. are recorded at Ravenglass, close to the coast, and 51.78 at Cocker-mouth, some miles inland. In the heart of the district, however, the fall is as a rule much heavier, in fact, the heaviest recorded in the British Isles (see LAKE DISTRICT). Somewhat less than three-fifths of the total area of the county is under cultivation, the proportion being higher than that of the neighbouring counties of Northumberland and Westmorland, but still much below the average of the English counties. Black peaty earth is the most prevalent soil in the mountainous districts; but dry loams occur in the lowlands, and are well adapted to green crops, grain and pasture. Wheat and barley are practically neglected, but large crops of oats are grown. Turnips and swedes form the bulk of the green crops. Hill pasture amounts to nearly 270,000 acres, and a good number of cattle are reared, but the principal resource of the farmer is sheep-breeding. The sheep on the lowland farms are generally of the Leicester class or cross-bred between the Leicester and Herdwick, with a few Southdowns. Throughout the mountainous districts the Herdwicks have taken the place of the smaller black-faced heath variety of sheep once so commonly met with on the sheep farms. They are peculiar to this part of England; the ewes and wethers and many of the rams are polled, the faces and legs are speckled, and the wool is finer and heavier in fleece than that of the heath breed. They originally came from the neighbourhood of Muncaster in the Duddon and Esk district, and tradition ascribes their origin variously to introduction by Scandinavian settlers, or to parents that escaped from a wrecked ship of the Spanish Armada. In general they belong to the proprietors of the sheep-walks, and have been farmed out with them from time immemorial, from which circumstance it is said they obtained the name of "Herdwicks." Long after the Norman Conquest Cumberland

remained one of the most densely forested regions of England, and much of the low-lying land is still well wooded, the Lake District in particular displaying beautiful contrasts between bare mountain and tree-clad valley. The oak, ash and birch are the principal natural trees, while sycamores have been planted for shelter round many farmsteads. Plantations of larch are also numerous, and the holly, yew, thorn and juniper flourish locally.

Landed property was formerly much divided in this county, and the smaller holdings were generally occupied by their owners, who were known as "statesmen," i.e. "estatesmen," a class of men long noted for their sturdy independence and attachment to routine husbandry. Most of these estates were held of the lords of manors under customary tenure, which subjected them to the payments of fines and heriots on alienation as well as on the death of the lord or tenant. According to the *Agricultural Survey* printed in 1794, about two-thirds of the county was held by this tenure, in parcels worth from £15 to £30 rental. On large estates, also, the farms were in general rather small, few then reaching £200 a year, held on verbal contracts, or very short leases, and burdened like the small estates with payments or services over and above a money rent. In modern times these conditions have changed, the "statesmen" gradually becoming extinct as a class, and many of the small holdings falling into the hands of the larger landed proprietors.

*Other Industries.*—Carlisle is the seat of a variety of manufactures; there are also in the county cotton and woollen industries, pencil mills at Keswick, and iron shipbuilding yards at Whitehaven. But the mining industry is the most important, coal being raised principally in the district about Whitehaven, Workington and Maryport. Side by side with this industry much iron ore is raised, and there is a large output of pig-iron, and ore is also found in the south, in the neighbourhood of Millom. Gypsum, zinc and some lead are mined. Copper was formerly worked near Keswick, and there was a rich deposit of black lead at the head of Borrowdale. Granite and limestone are extensively quarried. Stone is very largely used even for housebuilding, a fine green slate being often employed. Shap and other granites are worked for building and roadstones.

*Communications.*—The chief ports of Cumberland are Whitehaven, Workington, Maryport, Harrington and Silloth. The London & North-Western railway enters the county near Penrith, and terminates at Carlisle, which is also served by the Midland. The Caledonian, North British and Glasgow & South-Western lines further serve this city, which is thus an important junction in through communications between England and Scotland. The North-Eastern railway connects Carlisle with Newcastle. The Maryport & Carlisle, the Cocker-mouth, Keswick & Penrith, and the Cleator & Workington Junction lines serve the districts indicated by their names, while the Furness railway passes along the west coast from the district of Furness in Lancashire as far north as Whitehaven, also serving Cleator and Egremont. The Ravenglass & Eskdale light railway gives access from this system to Boot in Eskdale. Coaches and motor cars maintain passenger communications in the Lake District where the railways do not penetrate.

*Population and Administration.*—The area of the ancient and the administrative county is 973,086 acres, with a population in 1891 of 266,549 and in 1901 of 266,933. The county contains five wards, divisions which in this and neighbouring counties correspond to hundreds, and also appear in Lanarkshire and Renfrewshire in Scotland. The municipal boroughs are Carlisle (pop. 45,480), a city and the county town, Whitehaven (19,324), and Workington (26,143). The other urban districts are Arlecdon and Frizington (5341), Aspatria (2885), Cleator Moor (8120), Cocker-mouth (5355), Egremont (5761), Harrington (3679), Holme Cultram (4275), Keswick (4451), Maryport (11,897), Millom (10,426), Penrith (9182), Wigton (3692). Of these all except Keswick, Millom and Penrith are in the industrial district of the west and north-west. The urban district of Holme Cultram includes the port of Silloth. Among lesser towns may be mentioned St Bees (1236), on the coast south of Whitehaven,



until 1897 the seat of a Church of England theological college. The grammar school here, founded in 1533, is liberally endowed, with scholarships and exhibitions. Cumberland is in the northern circuit, and assizes are held at Carlisle. It has one court of quarter sessions and 12 petty sessional divisions. The city of Carlisle has a separate commission of the peace and court of quarter sessions. There are 213 civil parishes. Cumberland is in the diocese of Carlisle, with a small portion in that of Newcastle. There are 167 ecclesiastical parishes or districts within the county. There are four parliamentary divisions, the Northern or Eskdale, Mid or Penrith, Cockermouth and Western or Egremont, each returning one member; while the parliamentary boroughs of Carlisle and Whitehaven each return one member.

*History.*—After the withdrawal of the Romans (of whose occupation there are various important relics in the county) little is known of the region which is now Cumberland, until the great battle of Ardderyd in 573 resulted in its consolidation with the kingdom of Strathclyde. About 670–680 the western district between the Solway and the Mersey was conquered by the Angles of Northumbria and remained an integral portion of that kingdom until the Danish invasion of the 9th century. In 875 the kingdom of the Cumbri is referred to, but without any indication of its extent, and the first mention of Cumberland to denote a geographical area occurs in 945 when it was ceded by Edmund to Malcolm of Scotland. At this date it included the territory north and south of the Solway from the Firth of Forth to the river Duddon. The Scottish supremacy was not uninterrupted, for the district at the time of its invasion by Ethelred in 1000 was once more a stronghold of the Danes, whose influence is clearly traceable in the nomenclature of the Lake District. At the time of the Norman invasion Cumberland was a dependency of the earldom of Northumbria, but its history at this period is very obscure, and no notice of it occurs in the Domesday Survey of 1086; Kirksanton, Bootle and Whicham, however, are entered under the possessions of the earl of Northumbria in the West Riding of Yorkshire. The real Norman conquest of Cumberland took place in 1092, when William Rufus captured Carlisle, repaired the city, built the castle, and after sending a number of English husbandmen to till the land, placed the district under the lordship of Ranulf Meschines. The fief of Ranulf was called the Power or Honour of Carlisle, and a sheriff of Carlisle is mentioned in 1106. The district was again captured by the Scots in the reign of Stephen, and on its recovery in 1157 the boundaries were readjusted to include the great barony of Coupland. At this date the district was described as the county of Carlisle, and the designation county of Cumberland is not adopted in the sheriff's accounts until 1177. The five present wards existed as administrative areas in 1278, when they were termed bailiwicks, the designation ward not appearing until the 16th century, though the bailiwicks of the Forest of Cumberland are termed wards in the 14th century. In the 17th and 18th centuries each of the five wards was under the administration of a chief constable.

Owing to its position on the Border Cumberland was the scene of constant warfare from the time of its foundation until the union of England and Scotland, and families like the Tilliols, the Lucies, the Greystokes, and the Dacres were famous for their exploits in checking or avenging the depredations of the Scots. During the War of Independence in the reign of Edward I. Carlisle was the headquarters of the English army. In the Wars of the Roses the prevailing sympathy was with the Lancastrian cause, which was actively supported by the representatives of the families of Egremont, Dacre and Greystoke. In 1542 the Scottish army under James V. suffered a disastrous defeat at Solway Moss. After the union of the crowns of England and Scotland in 1603, the countries hitherto known as "the Borders" were called "the Middle Shires," and a period of comparative peace ensued. On the outbreak of the Civil War of the 17th century the northern counties associated in raising forces for the king, and the families of Howard, Dalston, Dacre and Musgrave rendered valuable service to the royalist cause. In

1645 Carlisle was captured by the parliamentary forces, but in April 1648 it was retaken by Sir Philip Musgrave and Sir Thomas Glenham, and did not finally surrender until the autumn of 1648. Cumberland continued, however, to support the Stuarts; it was one of the first counties to welcome back Charles II.; in 1715 it was associated with the rising on behalf of the Pretender, and Carlisle was the chief seat of operations in the 1745 rebellion.

In 685 Carlisle and the surrounding district was annexed by Egfrith king of Northumbria to the diocese of Lindisfarne, to which it continued subject, at least until the Danish invasion of the 9th century. In 1133 Henry I. created Carlisle (*q.v.*) a bishopric. The diocese included the whole of modern Cumberland (except the barony of Coupland and the parishes of Alston, Over-Denton and Kirkandrews), and also the barony of Appleby in Westmorland. The archdeaconry of Carlisle, co-extensive with the diocese, comprised four deaneries. Coupland was a deanery in the archdeaconry of Richmond and diocese of York until 1541; when it was annexed to the newly created diocese of Chester. In 1856 the area of the diocese of Carlisle was extended, so as to include the whole of Cumberland except the parish of Alston, the whole of Westmorland, and the Furness district of Lancashire. In 1858 the deaneries were made to number eighteen, and in 1870 were increased to twenty.

The principal industries of Cumberland have been from earliest times connected with its valuable fisheries and abundant mineral wealth. The mines of Alston and the iron mines about Egremont were worked in the 12th century. The Keswick copper mines were worked in the reign of Henry III., but the black-lead mine was not worked to any purpose until the 18th century. Coal-mining is referred to in the 15th century, and after the revival of the mining industries in the 16th century, rose to great importance. The salt pans about the estuaries of the Esk and the Eden were a source of revenue in the 12th century.

Cumberland returned three members for the county to the parliament of 1290, and in 1295 returned in addition two members for the city of Carlisle and two members each for the boroughs of Cockermouth and Egremont. The boroughs did not again return members until in 1640 Cockermouth regained representation. Under the Reform Act of 1832, Cumberland returned four members for two divisions, and Whitehaven returned one member. The county now returns six members to parliament; one each for the four divisions of the county, Egremont, Cockermouth, Eskdale and Penrith, one for the city of Carlisle and one for the borough of Whitehaven.

*Antiquities.*—Very early crosses, having Celtic or Scandinavian characteristics, are seen at Gosforth, Bewcastle and elsewhere. In ecclesiastical architecture Cumberland is not rich as a whole, but it possesses Carlisle cathedral, with its beautiful choir, and certain monastic remains of importance. Among these are the fine remnants of Lanercost priory (see BRAMPTON). Calder Abbey, near Egremont, a Cistercian abbey founded in 1134, has ruins of the church and cloisters, of Norman and Early English character, and is very beautifully situated on the Calder. The parish Church of St Bees, with good Norman and Early English work, belonged to a Benedictine priory of 1120; but according to tradition the first religious house here was a nunnery founded c. 650 by St Bega, who became its abbess. Among the parish churches there are a few instances of towers strongly fortified for purposes of defence; that at Burgh-on-the-Sands, near Carlisle, being a good illustration. Castles, in some cases ruined, in others modernized, are fairly numerous, both near the Scottish border and elsewhere. Naworth Castle near Brampton is the finest example; others are at Bewcastle, Carlisle, Kirkoswald, Egremont, Cockermouth and Millom. Among many notable country seats, Rose Castle, the palace of the bishops of Carlisle; Greystoke Castle and Armathwaite Hall may be mentioned.

See J. Nicolson and R. Burn, *History and Antiquities of the Counties of Westmorland and Cumberland* (London, 1777); W. Hutchinson, *History of Cumberland* (Carlisle, 1794); S. Jefferson, *History and Antiquities of Cumberland* (Carlisle, 1840–1842); S. Gilpin, *Songs and Ballads of Cumberland* (London, 1866); W. Dickinson, *Glossary of Words and Phrases of Cumberland* (London, English Dialect

Society, 1878, with a supplement, 1881; Sir G. F. Duckett, *Early Sheriffs of Cumberland* (Kendal, 1879); J. Denton, "Account of Estates and Families in the County of Cumberland, 1066-1603," in *Antiquarian Society's Transactions* (1887); R. S. Ferguson, *History of Cumberland* (London, 1890); "Archaeological Survey of Cumberland," in *Archaeologia*, vol. liii. (London, 1893); W. Jackson, *Papers and Pedigrees relating to Cumberland* (2 vols., London, 1892); T. Ellwood, *The Landnama Book of Iceland as it illustrates the Dialect and Antiquities of Cumberland* (Kendal, 1894); *Victoria County History, Cumberland*; and *Transactions of the Cumberland and Westmorland Antiquarian and Archaeological Society*.

**CUMBERLAND**, a city and the county-seat of Allegany county, Maryland, U.S.A., on the Potomac river, about 178 m. W. by N. of Baltimore and about 153 m. S. by E. of Pittsburg. Pop. (1890) 12,729; (1900) 17,128, of whom 1113 were foreign-born and 1100 were of negro descent; (1910) 21,839. Cumberland is served by the Baltimore & Ohio, the Western Maryland, the Pennsylvania, the Cumberland & Pennsylvania (from Cumberland to Piedmont, Virginia), and the George's Creek & Cumberland railways, the last a short line extending to Lonaconing (19 m.); by an electric line extending to Western Port, Maryland; and by the Chesapeake & Ohio Canal, of which it is a terminus. The city is about 635 ft. above sea-level, and from a distance appears to be completely shut in by lofty ranges of hills, which are cut through to the westward by a deep gorge called "The Narrows," making a natural gateway of great beauty. Cumberland has a large trade in coal, which is mined in the vicinity. As a manufacturing centre it ranked in 1905 second in the state, the chief products being iron, steel, bricks, flour, cement, silk and leather; there is also a large dyeing and cleaning establishment. The value of the city's factory products increased from \$2,900,267 in 1900 to \$4,595,023 in 1905, or 58.4%. Cumberland is an important jobbing centre also. The municipality owns and operates its water-works and electric lighting plant. The first settlement of the place was made in 1750; in 1754 Fort Cumberland was erected within what are now the city limits, and in the year following this fort was occupied by General Edward Braddock. Cumberland was laid out in 1763, but there was little growth until 1787, and it was not incorporated as a town until 1815; it was chartered as a city in 1850.

**CUMBERLAND**, a township of Providence county, Rhode Island, U.S.A., in the N.E. part of the state, about 6 m. N. of Providence and having the Blackstone river for most of its W. boundary. Pop. (1890) 8090; (1900) 8925, of whom 3473 were foreign-born; (1910) 10,107; area, 27.5 sq. m. It is served by the New York, New Haven & Hartford railway. Within its borders are the villages of Cumberland Hill, Diamond Hill, Arnold Mills, Abbott Run, Berkeley, Robin Hollow, Happy Hollow, East Cumberland, and parts of Manville, Ashton, Lonsdale and Valley Falls. The surface of the township is generally hilly and rocky. In the N. part is a valuable granite quarry; and limestone, and some coal, iron and gold are also found. Cumberland has been called the "mineral pocket of New England." The Blackstone and its tributaries provide considerable water power; and there are various manufactures, including cotton goods, silk goods, and horse-shoes and other iron ware. The value of the township's factory product in 1905 was \$3,171,318, an increase of 80.6% since 1900, this ratio of increase being greater than that shown by any other "municipality" in the state having a population in 1900 of 8000 or more. At Lonsdale, William Blackstone (c. 1595-1675), the first permanent white settler within the present limits of Rhode Island, built his residence, "Study Hall," about 1635. Cumberland was originally a part of Rehoboth, and then of Attleborough, Massachusetts, and for many years was called, like other sparse settlements, the Gore, or Attleborough Gore. In 1747, by the royal decree establishing the boundary between Massachusetts and Rhode Island, Attleborough Gore, with other territory formerly under the jurisdiction of Massachusetts, was annexed to Rhode Island, and the township of Cumberland was incorporated, the name being adopted in honour of William Augustus, duke of Cumberland. In 1867 a part of Cumberland was set off to form the township of Woonsocket.

**CUMBERLAND MOUNTAINS** (or more correctly the Cumberland Plateau or Highlands), the westernmost of the three great divisions of the Appalachian uplift in the United States, composed of many small ranges of mountains (of which Cumberland Mountain in eastern Kentucky is one). It extends from Pennsylvania to Alabama, attaining its greatest height (about 4000 ft.) in Virginia. The plateau is rich in a variety of mineral products, of which special mention may be made of coal, which occurs in many places, and of the beautiful marbles quarried in that portion of the plateau which lies between Virginia and Kentucky and crosses Tennessee. The plateau has an abrupt descent, almost an escarpment, into the great Appalachian Valley on its E., while the W. slope is deeply and roughly broken. The whole mass is eroded in Virginia into a maze of ridges. Cumberland Mountain parts the waters of the Cumberland and Tennessee rivers. This range and the other ranges about it are perhaps the loveliest portion of the whole plateau. The peaks here and in the Blue Ridge to the E. are the highest of the Appalachian system. Forest-filled valleys, rounded hills and rugged gorges afford in every part scenery of surpassing beauty. The Cumberland Valley between the Cumberland range and the Pine range is one of special fame. In the former range there are immense caverns and subterranean streams. Cumberland Gap, crossing the ridge at about 167 ft. above the sea, where Kentucky, Virginia and Tennessee meet, is a gorge about 500 ft. deep, with steep sides that barely give room in places for a roadway. The mountains, river and gap were all discovered by a party of Virginians in 1748, and named in honour of the victor of Culloden, William, duke of Cumberland. Afterwards the gap gained a place in American history as one of the main pathways by which emigrants crossed the mountains to Kentucky and Tennessee. During the Civil War it was a position of great strategic importance, as it afforded an entrance to eastern and central Tennessee from Kentucky, which was held by the Union arms; and it was repeatedly occupied in alternation by the opposing forces.

The mountaineers of Kentucky and Tennessee are a strange stock, who retain in their customs and habits the primitive conditions of a life that has elsewhere long since disappeared. They have been pictured in the novels of Miss Murfree and John Fox, Junr. They are a tall, straight, angular folk, of fine physical development; the volunteers for the Union army from Kentucky and Tennessee during the Civil War—most of whom came from the non-slave-holding mountain region—exceeded in physical development the volunteers from all other states. For the education of these mountaineers Major-General Oliver Otis Howard founded in 1895 at Cumberland Gap, Tennessee, the Lincoln Memorial University (co-educational; non-sectarian; opened in 1897), which has collegiate, normal training and industrial courses, and an affiliated school of medicine, Tennessee Medical College, at Knoxville. The university had in 1907-1908 14 instructors and 570 students. Berea College in Kentucky was a pioneer institution for the education of mountaineers.

**CUMBERLAND RIVER**, a large southern branch of the Ohio river, U.S.A., rising in the highest part of the Cumberland plateau in south-east Kentucky, and emptying into the Ohio in Kentucky (near Smithland) after a devious course of 688 m. through that state and Tennessee. It drains a basin of somewhat more than 18,000 sq. m., and is navigable for light-draught steamers through about 500 m. under favourable conditions—Burnside, Pulaski county, 518 m. from the mouth, is the head of navigation—and through 193 m.—to Nashville—all the year round; for boats drawing not more than 3 ft. the river is navigable to Nashville for 6 to 8 months. At the Great Falls, in Whitley county, Kentucky, it drops precipitously 63 ft. Above the falls it is a mountain stream, of little volume in the dry months. It descends rapidly at its head to the highland bench below the mountains and traverses this to the falls, then flows in rapids (the Great Shoals) for some 10 m. through a fine gorge with cliffs 300-400 ft. high, and descends between bluffs of decreasing height and beauty into its lower level. Save in the mountains its gradient is slight, and below the falls, except for a number of small rapids, the

flow of the stream is equable. Timbered ravines lend charm to much of its shores, and in the mountains the scenery is most beautiful. Below Nashville the stream is some 400 to 500 ft. wide, and its high banks are for the most part of alluvium, with rocky bluffs at intervals. At the mouth of the river lies Cumberland Island, in the Ohio. During low water of the latter stream the Cumberland discharges around both ends of the island, but in high water of the Ohio the gradient of the Cumberland is so slight that its waters are held back, forming a deep quiet pool that extends some 20 m. up the river. A system of locks and dams below Nashville was planned in 1846 by a private company, which accomplished practically nothing. Congress appropriated \$155,000 in 1832-1838; in the years immediately after 1888 \$305,000 was expended, notably for deepening the shoals at the junction of the Cumberland and the Ohio; in 1892 a project was undertaken for 7 locks and dams 52 ft. wide and 280 ft. long below Nashville. Above Nashville \$346,000 was expended on the open channel project (of 1871-1872) from Nashville to Cumberland Ford (at Pineville); in 1886 a canalization project was undertaken and 22 locks and dams below Burnside and 6 above Burnside were planned, but by the act of 1907 the project was modified—\$2,319,000 had been appropriated up to 1908 for the work of canalization. During the Civil War Fort Donelson on the Cumberland, and Fort Henry near by on the Tennessee were erected by the Confederates, and their capture by Flag-officer A. H. Foote and General Grant (Feb. 1862) was one of the decisive events of the war, opening the rivers as it did for the advance of the Union forces far into Confederate Territory.

**CUMBRAES, THE**, two islands forming part of the county of Bute, Scotland, lying in the Firth of Clyde, between the southern shores of Bute and the coast of Ayrshire. **GREAT CUMBRAE ISLAND**, about 1½ m. W.S.W. of Largs, is 3¼ m. long and 2 m. broad, and has a circumference of 10 m. and an area of 3200 acres or 5 sq. m. Its highest point is 417 ft. above the sea. There is some fishing and a little farming, but the mainstay of the inhabitants is the custom of the visitors who crowd every summer to Millport, which is reached by railway steamer from Largs. This town (pop. 1901, 1663) is well situated at the head of a fine bay and has a climate that is both warm and bracing. Its chief public buildings include the cathedral, erected in Gothic style on rising ground behind the town, the college connected with it, the garrison, a picturesque seat belonging to the marquis of Bute, who owns the island, the town hall, a public hall, library and reading room, the Lady Margaret fever hospital, and a marine biological station. The cathedral, originally the collegiate church, was founded in 1849 by the earl of Glasgow and opened in 1851. In 1876 it was constituted the cathedral of Argyll and the Isles. Millport enjoys exceptional facilities for boating and bathing, and there is also a good golf-course. Pop. (1901) 1754, of whom 1028 were females, and 59 spoke both English and Gaelic. **LITTLE CUMBRAE ISLAND** lies to the north, separated by the Tan, a strait half a mile wide. It is 1¼ m. long, barely 1 m. broad, and has an area of almost a square mile. Its highest point is 409 ft. above sea-level. On the bold cliffs of the west coast stands a lighthouse. Robert II. is said to have built a castle on the island which was demolished by Cromwell's soldiers in 1653.

The strata met with in the Great and Little Cumbrae belong to the Upper Old Red Sandstone and Carboniferous systems. The former, consisting of false-bedded sandstones and conglomerates, are confined to the larger island. The Carboniferous rocks of the Cumbrae belong to the lower part of the Calciferous Sandstone series with the accompanying volcanic zone. In the larger island these sediments, comprising sandstones, red, purple and mottled clays with occasional bands of nodular limestone or corncornstone, occupy a considerable area on the north side of Millport Bay. In the Little Cumbrae they appear on the east side, where they underlie and are interbedded with the lavas. The interesting geological feature of these islands is the development of Lower Carboniferous volcanic rocks. They cover nearly the whole of the Little Cumbrae, where they give rise to marked terraced features and are arranged in a gentle synclinal fold. The flows are often scoriaceous at the top and sometimes display columnar structure, as in the crags at the lighthouse. Those rocks examined microscopically consist of basalts which are often porphyritic.

In Great Cumbrae the intrusive rocks mark four periods of eruption, three of which may be of Carboniferous age. The oldest, consisting of trachytes, occur as sheets and dikes trending generally E.N.E., and are confined chiefly to the Upper Old Red Sandstone. They seem to be of older date than the Carboniferous lavas of Little Cumbrae and south Bute. Next come dikes of olivine basalt of the type of the Lion's Haunch on Arthur's Seat, which, though possessing the same general trend as the trachytes, are seen to cut them. The members of the third group comprise dikes of dolerite or basalt with or without olivine, which have a general east and west trend, and as they intersect the two previous groups they must be of later date. They probably belong to the east and west quartz dolerite dikes which are now referred to late Carboniferous time. Lastly there are representatives of the basalt dikes of Tertiary age with a north-west trend.

**CUMIN**, or **CUMMIN** (*Cuminum Cuminum*), an annual herbaceous plant, a member of the natural order Umbelliferae and probably a native of some part of western Asia, but scarcely known at the present time in a wild state. It was early cultivated in Arabia, India and China, and in the countries bordering the Mediterranean. Its stem is slender and branching, and about a foot in height; the leaves are deeply cut, with filiform segments; the flowers are small and white. The fruits, the so-called seeds, which constitute the cummin of pharmacy, are fusiform or ovoid in shape and compressed laterally; they are two lines long, are hotter to the taste, lighter in colour, and larger than caraway seeds, and have on each half nine fine ridges, overlying as many oil-channels or vittae. Their strong aromatic smell and warm bitterish taste are due to the presence of about 3% of an essential oil. The tissue of the seeds contains a fatty oil, with resin, mucilage and gum, malates and albuminous matter; and in the pericarp there is much tannin. The volatile oil of cummin, which may be separated by distillation of the seed with water, is mainly a mixture of cymol or cymene, C<sub>10</sub>H<sub>14</sub>, and cumic aldehyde, C<sub>6</sub>H<sub>4</sub>(C<sub>3</sub>H<sub>7</sub>)COH. Cummin is mentioned in Isaiah xxviii. 25, 27, and Matthew xxiii. 23, and in the works of Hippocrates and Dioscorides. From Pliny we learn that the ancients took the ground seed medicinally with bread, water or wine, and that it was accounted the best of condiments as a remedy for squeamishness. It was found to occasion pallor of the face, whence the expression of Horace, *exsangue cuminum* (*Epist.* i. 19), and that of Persius, *pallentis grana cumini* (*Sat.* v. 55). Pliny relates the story that it was employed by the followers of Porcius Latro, the celebrated rhetorician, in order to produce a complexion such as bespeaks application to study (xx. 57). In the middle ages cummin was one of the commonest spices of European growth. Its average price per pound in England in the 13th and 14th centuries was 2d. or, at present value, about 1s. 4d. (Rogers, *Hist. of Agric. and Prices*, i. 631). It is stimulant and carminative, and is employed in the manufacture of curry powder. The medicinal use of the drug is now confined to veterinary practice. Cummin is exported from India, Mogador, Malta and Sicily.

**CUMMERBUND**, a girdle or waistbelt (Hindustani *kamar-band*, a loin-band). In the East the principle of health is to keep the head cool and the stomach warm; the turban protects the one from the sun, and the cummerbund ensures the other against changes of temperature. In India the cummerbund consists of many folds of muslin or bright-coloured cloth.

**CUMMING, JOSEPH GEORGE** (1812-1868), English geologist and archaeologist, was born at Matlock in Derbyshire on the 15th of February 1812. He was educated at Oakham grammar school, and Emmanuel College, Cambridge, taking the degree of M.A., and entering holy orders in 1835. In 1841 he was appointed vice-principal of King William's College, Castletown, in the Isle of Man, and this position he held until 1856. During this period his leisure time was devoted to a study of the geology and archaeology of the island. The results were published in a classic volume *The Isle of Man; its History, Physical, Ecclesiastical, Civil and Legendary* (1848). In 1856 he became master of King Edward's grammar school at Lichfield, in 1858 warden and professor of classical literature and geology in Queen's College, Birmingham, in 1862 rector of Mellis, in Suffolk, and in 1867 vicar of St John's, Bethnal Green, London. He died in London on the 21st of September 1868.

**CUMNOCK AND HOLMHEAD**, a police burgh of Ayrshire, Scotland, on the Lugar, 33½ m. S. of Glasgow by road, with two stations (Cumnock and Old Cumnock) on the Glasgow & South-Western railway. Pop. (1901) 3088. It lies in the parish of Old Cumnock (pop. 5144), and is a thriving town, with a town hall, cottage hospital, public library and an athenaeum. Coal and ironstone are extensively mined in the neighbourhood, and the manufactures include woollens, tweeds, agricultural implements and pottery. When Alexander Peden (1626-1686), the persecuted Covenanter, died, he was buried in the Boswell aisle of Auchinleck church; but his corpse was borne thence with every indignity by a company of dragoons to the foot of the gallows at Cumnock, where they intended to hang it in chains. This proving to be impracticable they buried it at the gallows-foot. After the Revolution the inhabitants out of respect for the "Prophet's" memory abandoned their then burying-ground and turned the old place of execution into the present cemetery. Five miles S.E. lies the parish of New Cumnock (pop. 5367) at the confluence of Afton Water and the Nith. It is rich in minerals, iron, coal, limestone and freestone, and has a station on the Glasgow & South-Western railway. Two miles N.W. of Cumnock is Auchinleck (pronounced Affleck), with a station on the Glasgow & South-Western railway. Coal and iron mining and farming are important industries. It is the seat of the Boswell family, three generations of which achieved greatness—Lord Auchinleck, the judge (who dubbed Dr Johnson "Ursa Major"), his son James, the biographer, and his grandson Sir Alexander, the author of "Gude nicht and joy be wi' you a'," "Jenny's Bawbee," "Jenny dang the weaver," and other songs and poems, who perished miserably in a duel. Pop. of Auchinleck parish (1901) 6605.

**CUNARD, SIR SAMUEL**, Bart. (1787-1865), British civil engineer, founder of the Cunard line of steam-ships, was born at Halifax, Nova Scotia, on the 21st of November 1787. He was the son of a merchant, and was himself trained for the pursuits of commerce, in which, by his abilities and enterprising spirit, he attained a conspicuous position. When, in the early years of steam navigation, the English government made known its desire to substitute steam vessels for the sailing ships then employed in the mail service between England and America, Cunard heartily entered into the scheme, came to England, and accepted the government tender for carrying it out. In conjunction with Messrs Burns of Glasgow and Messrs MacIver of Liverpool, proprietors of rival lines of coasting steamers between Glasgow and Liverpool, he formed a company, and the first voyage of a Cunard steamship was successfully made by the "Britannia" from Liverpool to Boston, U.S.A., between July 4 and 19, 1840 (see STEAMSHIP LINES). In acknowledgment of his energetic and successful services Cunard was, in 1859, created a baronet. He died in London on the 28th of April 1865.

**CUNAS**, a tribe of Central American Indians. Their home is the Isthmus of Panama, from the Chagres to the Atrato. They are sometimes called Darien or San Blas Indians. They are a small active people, with remarkably light complexions.

**CUNDINAMARCA**, till 1909 a department of the eastern plateau of Colombia, South America, having the departments of Quesada and Tundama on the N., Tolima on the W. and S., and the Meta territory on the S.E. and E. The territorial redistribution of 1905 deprived Cundinamarca of its territories on the eastern plains, and a part of its territory in the Eastern Cordillera out of which Quesada and the Federal district were created—its area being reduced from 79,691 to 5060 sq. m., and its estimated population from 500,000 to 225,000. A considerable part of its area consists of plateaus enjoying a temperate climate and producing the fruits and cereals of the temperate zone, and another important part lies in the valley of the Magdalena and is tropical in character. The district of Fusagasuga in the southern part of this region is celebrated for the excellence of its coffee. The capital of the department was Facatativá (est. population, 7500), situated on the western margin of the *sabana* of Bogotá, 25 m. N.W. from that capital

by rail. Other important towns are Caqueza, Sibaté, La Meza and Tocaima.

**CUNEIFORM** (from Lat. *cuneus*, a wedge), a form of writing, extensively used in the ancient world, especially by the Babylonians and Assyrians. The word "cuneiform" was first applied in 1700 by Thomas Hyde, professor of Hebrew in the university of Oxford, in the expression "dactuli pyramidales seu cuneiformes," and it has found general acceptance, though efforts have been made to introduce the expression "arrow-headed" writing. The name "cuneiform" is fitting, for each character or sign is composed of a wedge (∟ or ▸), or a combination of wedges (E, H, etc.), written from left to right. The wedge is always pointed towards the right (▸) or downwards (∟) or aslant (∖), or two may be so combined as to form an angle (◁) called by German Assyriologists a *Winkelhaken*, a word now sometimes adopted by English writers on the subject. The word cuneiform has passed into most modern languages, but the Germans use *Keilschrift* (i.e. wedge-script) and the Arabs *mismāri* (مسماري) or nail-writing.

In Persia, 40 m. N.E. of Shiraz, is a range of hills, Mount Rachmet, in front of which, in a semicircular form, rises a vast terrace-like platform. It is partly natural, but was walled up in front, levelled off and used as the base of great temples and palaces. The earliest European, at present known to us, who visited the site was a wandering friar Odoricus (about A.D. 1320), who does not seem to have noticed the inscriptions cut in the stone. These were first observed by Josaphat Barbaro, a Venetian traveller, about 1472. In 1621 the ruins were visited by Pietro della Valle, who was the first to copy a few of the signs, which he sent in a letter to a friend in Naples. His copy was not well made, but it served



the useful purpose of directing attention to an unknown script which was certain to attract scholars to the problem of its decipherment. To this end it was necessary that complete inscriptions and not merely separate signs should be made accessible to European scholars. The first man to attempt to satisfy this need was Sir John Chardin, in whose volumes of travels published at Amsterdam in 1711 one of the small inscriptions found at the ruins of Persepolis was carefully and accurately reproduced. It was now plainly to be seen, as indeed others had surmised, that these inscriptions at Persepolis had been written in three languages, distinguished each from other by an increasing complexity in the signs with which they were written. The three languages have since been determined as Persian, Susian and Babylonian. But before the decipherment could begin it was necessary that all the available material should be copied and published. The honour of performing this great task fell to Carsten Niebuhr, who visited Persepolis in March 1765, and in three weeks and a half copied all the texts, so well that little improvement has been made in them since. When Niebuhr returned to Denmark he studied carefully the little inscriptions and convinced himself that the guesses of some of his predecessors were correct, and that the inscriptions were to be read from left to right. He observed that three systems of writing were discernible, and that these were always kept distinct in the inscriptions. He did not, however, draw the natural conclusion that they represented three languages, but supposed that the proud builders of Persepolis had written their inscriptions in threefold form. He divided the little inscriptions into three classes, according to the manner of their writing, calling them classes I., II. and III. He then arranged all those he had copied that belonged to class I., and by careful comparison decided that in them there were employed altogether but forty-two signs. These he copied out and set in order in one of his plates. This list of signs was so nearly complete and accurate that later study has made but slight changes in it. When

Niebuhr had made his list of signs he naturally enough decided that this language, whatever it might be, was written in alphabetic characters, a conclusion which later investigation has not overthrown. Beyond this Niebuhr was not able to go, and not even one sign revealed its secret to his inquiry. When, however, he had published his copies (in 1777) there were other scholars ready to take up the difficult task. Two scholars independently, Olav Tychsen of Rostock and Friedrich Münter of Copenhagen, began work upon the problem. Tychsen first observed that there occurred at irregular intervals in the inscriptions of the first class a wedge that pointed neither directly to the right nor downward, but inclined diagonally. This he suggested was the dividing sign used to separate words. This very simple discovery later became of great importance in the hands of Münter. Tychsen also correctly identified the alphabetic signs for "a," "d," "u" and "s," but he failed to decipher an entire inscription, chiefly perhaps because, through an error in history, he supposed that they were written during the Parthian dynasty (246 B.C.—A.D. 227). Münter was more fortunate than Tychsen in his historical researches, and this made him also more successful in linguistic attempts. He rightly identified the builders of Persepolis with the Achaemenian dynasty, and so located in time the authors of the inscriptions (538-465 B.C.). Independently of Tychsen he identified the oblique wedge as a divider between words, and found the meaning of the sign for "b." These may appear to be small matters, but it must be remembered that they were made without the assistance of any bilingual text, and were indeed taken bodily out of the gloom which had settled upon these languages centuries before. They did not, however, bring us much nearer to the desired goal of a reading of any portion of the inscriptions. The whole case indeed seemed now perilously near a stalemate. New methods must be found, and a new worker; with patience, persistence, power of combination, insight, the historical sense and the feeling for archaeological indications.

In 1802 Georg Friedrich Grotefend (*q.v.*) was persuaded by the librarian of Göttingen University to essay the task. He began with the assumption that there were three languages, and that of these the first was ancient Persian, the language of the Achaemenians, who had erected these palaces and caused these inscriptions to be written. For his first attempts at decipherment he chose two of these old Persian inscriptions and laid them side by side. They were of moderate length, and the frequent recurrence of the same signs in them seemed to indicate that their contents were similar. The method which he now pursued was so simple, yet so sure, as he advanced step by step, that there seemed scarcely a chance of error. Münter had observed in all the Persian texts a word which occurred in two forms, a short and a longer form. This word appeared in Grotefend's two texts in both long and short forms. Münter had suggested that it meant "king" in the short form and "kings" in the longer, and that when the two words occurred together the expression meant "king of kings." But further, this word occurred in both inscriptions in the first line, and in both cases was followed by the same word. This second word Grotefend supposed to mean "great," the combined expression being "king great," that is, "great king." All this found support in the phraseology of the lately deciphered Sassanian inscriptions, and it was plausible in itself. It must, however, be supported by definite facts, and furthermore each word must be separated into its alphabetic parts, every one of them identified, and the words themselves be shown to be philologically possible by the production of similar words in related languages. In other words, the archaeological method must find support in a philological method. To this Grotefend now devoted himself with equal energy. His method was as simple as before. He had made out to his own satisfaction the titles "great king, king of kings." Now, in the Sassanian inscriptions, the first word was always the king's name, followed immediately by "great king, king of kings," and Grotefend reasoned that this was probably true in his texts. But if true, then these two texts were set up by two different kings, for the names were not the same at the

beginning. Furthermore the name with which his text No. I. began appears in the third line of text No. II., but in a somewhat longer form, which Grotefend thought was a genitive and meant "of N." It followed the word previously supposed to be "king" and another which might mean son (N king son), so that the whole expression would be "son of N king." From these facts Grotefend surmised that in these two inscriptions he had the names of three rulers, grandfather, father and son. It was now easy to search the list of the Achaemenian dynasty and to find three names which would suit the conditions, and the three which he ventured to select were Hystaspes, Darius, Xerxes. According to his hypothesis the name at the beginning of inscription I. was Darius, and he was ready to translate his texts in part as follows:—

- I. Darius, great king, king of kings . . . son of Hystaspes. . . .
- II. Xerxes, great king, king of kings . . . son of Darius king.

The form which he provisionally adopted for Darius was Darheush; later investigation has shown that it ought really to be read as Daryavush, but the error was not serious, and he had safely secured at least the letters D, A, R, SH. It was a most wonderful achievement, the importance of which he did not realize, for in it was the key to the decipherment of three ancient languages. To very few men has it been given to make discoveries so important both for history and for philology.

To Grotefend it was, however, not given to translate a whole text, or even to work out all the words whose meaning he had surmised. Rasmus Christian Rask (1787-1832), who followed him, found the plural ending in Persian, which had baffled him; and Eugène Burnouf (1801-1852), by the study of a list of Persian geographical names found at Naksh-i-Rustam, discovered at a single stroke almost all the characters of the Persian alphabet, and incidentally confirmed the values already determined by his predecessors.

At the same time as Burnouf, the eminent Sanskrit scholar Professor Christian Lassen (1800-1876), of Bonn, was studying the same list of names; and his results were published at the same time. The controversy which resulted as to priority of discovery may be here passed over while we sum up the results in general conclusions. Lassen may certainly claim in the final court of history that he discovered independently of Burnouf the values of at least six and possibly of eight signs. But in another respect he made very definite progress over Burnouf. He discovered that, if the system of Grotefend were rigidly followed, and to every sign were given the value Grotefend had assigned, some words would be left wholly or almost wholly without vowels; and therefore unpronounceable. As instances of such words he mentioned ÇPRD, THTGUS, KTPTUK, FRAISJM. This situation led Lassen to a very important discovery, towards which his knowledge of the Sanskrit alphabet did much to bring him. He came, in short, to the conclusion that the ancient Persian signs were not entirely alphabetic, but were at least partially syllabic, that is, that certain signs were used to represent not merely an alphabetic character like "b," but also a syllable such as "ba," "bi" or "bu." He claimed that he had successfully demonstrated that the sign for "a" was only used at the beginning of a word, or before a consonant, or before another vowel, and that in every other case it was included in the consonant sign. Thus in the inscription No I. in the second line the signs should be read VA-ZA-RA-KA. This was a most important discovery, and may be said to have revolutionized the study of these long puzzling texts.

During the entire time of this slow process of decipherment, from the first essays of Grotefend in 1802 until the publication of Lassen's book in 1836, there were more sceptics than believers in the results of the deciphering process. Indeed the history of all forms of decipherment of unknown languages shows that scepticism concerning them is far more prevalent than credulity or even a too ready acceptance. There was need for a man of another people, of different training and a fresh and unbiased mind, to put the capstone upon the decipherment, and he was already at work when Lassen's important researches appeared.



Major (afterward Sir) Henry Rawlinson had gone out to India, in the service of the East India Company, while still a boy. There he had learned Persian and several of the Indian vernaculars. That was not the sort of training that had prepared Grotefend, Burnouf or Lassen, but it was the kind that the early travellers and copyists had enjoyed. In 1833 young Rawlinson went to Persia, to work with other British officers in the reorganization of the Persian army. While engaged in this service his attention was drawn to the ancient Persian cuneiform inscriptions. In 1835 he copied with great care the texts at Hamadan, and began their decipherment. Of all the eager work which had been going on in Europe he knew little. It is no longer possible to ascertain when he gained his first information of Grotefend's work, for Norris, the secretary of the Royal Asiatic Society, has left us no record of when he began to send notices of the German's work. Whenever it was, there seems to be no doubt that Rawlinson worked independently for a time. His method was strikingly like Grotefend's. He had copied two trilingual inscriptions, and recognized at once that he had three languages before him. In 1839 (*Journal of the Royal Asiatic Society*, x. pp. 5, 6) he thus wrote of his method: "When I proceeded . . . to compare and interline the two inscriptions (or rather the Persian columns of the two inscriptions, for, as the compartments exhibiting the inscription in the Persian language occupied the principal place in the tablets, and were engraved in the least complicated of the three classes of cuneiform writing, they were naturally first submitted to examination) I found that the characters coincided throughout, except in certain particular groups, and it was only reasonable to suppose that the grounds which were thus brought out and individualized must represent proper names. I further remarked that there were but three of these distinct groups in the two inscriptions; for the group which occupied the second place in one inscription, and which, from its position, suggested the idea of its representing the name of the father of the king who was there commemorated, corresponded with the group which occupied the first place in the other inscription, and thus not only served determinately to connect the two inscriptions together, but, assuming the groups to represent proper names, appeared also to indicate a genealogical succession. The natural inference was that in these three groups of characters I had obtained the proper names belonging to three consecutive generations of the Persian monarchy; and it so happened that the first three names of Hystaspes, Darius and Xerxes, which I applied at hazard to the three groups, according to the succession, proved to answer in all respects satisfactorily and were, in fact, the true identification."

Rawlinson's next work was the copying of the great inscription of Darius on the rocks at Behistun (*q.v.*). He had first seen it in 1835, and as it was high up on the rocky face, and apparently inaccessible, he had studied it by means of a field-glass. He was not able to copy the whole of the Persian text, but in 1837, when he was more skilled in the script, he secured more of it. In the next year he forwarded to the Royal Asiatic Society of London his translation of the first two paragraphs of the Persian text, containing the name, titles and genealogy of Darius. This was little less than a *tour de force*, for it must be remembered that this had been accomplished without the knowledge of other ancient languages which his European competitors had enjoyed. The translation, received in London on the 14th of March, made a sensation, and a transcript sent in April to the Asiatic Society of Paris secured him an honorary membership in that distinguished body. He was now known, and many made haste to send him copies of everything important which had been published in Europe. The works of Burnouf, Niebuhr, le Brun and Porter came to his hands, and with such assistance he made rapid progress, and in the winter of 1838-1839 his alphabet of ancient Persian was almost complete. In 1839 he was in Bagdad, his work written out and almost ready for publication. But he delayed, hoping for more light, and revising sign by sign with exhaustless patience. He expected to publish his preliminary memoir in the spring of 1840, when he was suddenly sent to Afghanistan as political agent at Kandahar. Here he was too

busily engaged in war administration to attend to his favourite studies, which were not renewed until 1843 when he returned to Bagdad. There he received fresh copies and corrections of the Persepolis inscriptions which had been made by Westergaard, and later made a journey to Behistun to perfect his own copies of the texts which had formed the basis of his own first study. At last, after many delays and discouragements, he published, in 1846, in the *Journal of the Royal Asiatic Society*, his memoir, or series of memoirs, on the ancient Persian inscriptions, in which for the first time he gave a nearly complete translation of the Persian text of Behistun. In this one publication Rawlinson attained imperishable fame in Oriental research. His work had been carried on under greater difficulties than those in the path of his European colleagues, but he had surpassed them all in the making of an intelligible and connected translation of a long inscription. He had indeed not done it without assistance from the work of Burnouf, Grotefend and Lassen, but when all allowance is made for these influences his fame is not diminished nor the extent of his services curtailed. His method was adopted before he knew of Lassen's work. That two men of such different training and of such opposite types of mind should have lighted upon the same method, and by it have attained the same results, confirmed in the eyes of many the truth of the decipherment.



The work of the decipherment of the old Persian texts was now complete for all practical purposes. But in 1846 there appeared a paper read before the Royal Irish Academy by the Rev. Edward Hincks of Killyleagh, County Down, Ireland, whose keen criticisms of Lassen's work, and original contributions to the definite settlement of syllabic values, may be regarded as closing the period of decipherment of Persian cuneiform writing.





The next problem in the study of cuneiform was the decipherment of the second language in each of the trilingual groups. The first essay in this difficult task was made in 1844 by Niels Louis Westergaard. His method was very similar to that used by Grotefend in the decipherment of Persian. He selected the names of Darius, Hystaspes, Persians and others, and compared them with their equivalents in the Persian texts. By this means he learned a number of signs, and sought by their use in other words to spell out syllables or words whose meanings were then ascertained by conjecture or by comparison. He estimated the number of characters at eighty-two or eighty-seven, and judged the writing to be partly alphabetic and partly syllabic. The language he called Median, and classified it in "the Scythian, rather than in the Japhetic family." The results of Westergaard were subjected to incisive criticism by Hincks, who made a distinct gain in the problem. It next passed to the hands of de Saulcy, who was able to see further than either. But the matter moved with difficulty because the copied texts were not accurate. By the generosity of Sir Henry Rawlinson his superb copies of the Behistun text, second column, were placed in the hands of Mr Edwin Norris, who was able in 1852 to present a paper to the Royal Asiatic Society deciphering nearly all of it. Mordtmann followed him, naming the language Susian, which was met with general acceptance and was not displaced by the name Amardian, suggested by A. H. Sayce in two papers which otherwise made important contributions to the subject. With his contributions the problem of decipherment of Susian may be considered as closed. The latter workers could only be builders on foundations already laid.

The decipherment of the third of the three languages found at Persepolis and Behistun followed quickly on the success with Susian. The first worker was Isadore Löwenstern, who made out the words for "king" and "great" and the sign for the plural, but little more. The first really great advance was made by Hincks in 1846 and 1847. In these he determined successfully the values of several signs, settled the numerals, and was apparently on the high-road toward the translation of an entire Assyrian text. He was, however, too cautious to proceed so far, and the credit of first translating a short Assyrian text belongs to Longperier, who in 1847 published the following as the translation of an entire text: "Glorious is Sargon, the great king, the (. . .) king, king of kings, king of the land of Assyria."

It was nearly all correct, but it advanced our knowledge but slightly because it did not give the forms of the words—because (to put it in another way) he was not able to transliterate the Assyrian words. This was the great problem. In the Persian texts there were but forty-four signs, but in the third column of the Persepolis texts Grotefend had counted one hundred and thirty different characters, and estimated that in all the Babylonian texts known to him there were about three hundred different signs, while Botta discovered six hundred and forty-two in the texts found by him at Khorsabad. That was enough to make the stoutest heart quail, for a meaning must be found for every one of these signs. There could not be so many syllables, and it was, therefore, quite plain that the Babylonian language must have been written in part at least in ideograms. But in 1851 Rawlinson published one hundred and twelve lines of the Babylonian column from Behistun, accompanied by an inter-linear transcription into Roman characters, and a translation into Latin. That paper, added to Hinck's still more acute detail studies, brought to an end the preliminary decipherment of Babylonian. There were still enormous difficulties to be surmounted in the full appreciation of the complicated script, but these would be solved by the combined labours of many workers.















The cuneiform script had its origin in Babylonia and its inventors were a people whom we call the Sumerians. Before the Semitic Babylonians conquered the land it was inhabited by a people of unknown origin variously classified, by different scholars, with the Ural-altaic or even with the Indo-European family, or as having blood relationship with both. This people is known to us from thousands of cuneiform inscriptions written entirely in their language, though our chief knowledge of them was for a long time derived from Sumerian inscriptions with interlinear translations in Assyrian. Their language is called Sumerian (li-ša-an Su-me-ri) by the Assyrians (Br. Mus. 81-7-27, 130), and its characteristics are being slowly developed by the elaborate study of the immense literature which has come down to us. In 1884 Halévy denied the existence of the Sumerian language, and claimed that it was merely a cabalistic script invented by the priests of the Semites. His early success has not been sustained, and the vast majority of scholars have ceased to doubt the existence of the language.

The Sumerians developed their script from a rude picture-writing, some early forms of which have come down to us. In course of time they used the pictures to represent sounds, apart from ideas. They wrote first on stone, and when clay was adopted soon found that straight lines in soft clay when made by a single pressure of the stylus tend to become wedges, and the pictures therefore lost their character and came to be mere conventional groups of wedges. Some of these wedge-shaped signs are of such character that we are still able to recognize or re-construct the original picture from which they came. The Assyrian sign , which means heaven, appears in early texts in the form  in which its star-like form is quite evident (star=heaven) and from which the linear form  may be not improbably pre-supposed. A number of other cases were enumerated by the Assyrians themselves (see *Cuneiform Texts from Bab. Tab. in Brit. Museum*, vol. v., 1898), and there can be no reasonable doubt that this is the origin of the script.

The number of the original picture-signs cannot have been great, but the development of new signs never ceased till the cuneiform script passed wholly from use. The simplest form of development was doubling, to express plurality or intensity. After this came the working of two signs into one; thus  "water," when placed in  "mouth" gave the new sign  "to drink," and many others. Other signs were formed by the addition of four lines, either vertically or horizontally, to intensify the original meaning. Thus, for instance, the old linear sign  means dwelling, but with four additional signs, thus , it means "great house."

**Development and characteristics.**

This sign gradually changed in form until it came to be . This method of development was called by the Sumerians *gunnu*, and signs thus formed are now commonly called by us, *gunnu* signs. They number hundreds and must be reckoned with in our study of the script development, though perhaps recent scholars have somewhat exaggerated their importance. The process of development is obscure and must always remain so.

The script as finally developed and used by the Assyrians is cumbersome and complicated, and very ill adapted to the sounds of the Semitic alphabet. It has (1) simple syllables, consisting of one vowel and a consonant, or a vowel by itself, thus  "a,"  ab,  ib,  ub,  ba,  bi,  bu. In addition to these the Assyrian had also (2) compound syllables, such as  bit,  bal, and (3) ideograms, or signs which express an entire word, such as  bellu, lady,  abu, father. The difficulty of reading this script is enormously increased by the fact that many signs are polyphonous, i.e. they may have more than one syllabic value and also be used as an ideogram. Thus the sign  has the ideographic values of *matu*, land, *shadu*, mountain, *kashadu*, to conquer, *napachu*, to arise (of the sun), and also the syllabic values *kur*, *mad*, *mat*, *shad*, *shat*, *lat*, *nad*, *nat*, *kin* and *gin*. This method of writing must lead to ambiguity, and this difficulty is helped somewhat by (4) determinatives, which are signs intended to indicate the class to which the word belongs. Thus, the  is placed before names of persons, and  (the ideogram for *matu*, country, and *shadu*, mountain) is placed before names of countries and mountains, and  (*ilu*, god) before the names of gods.

The cuneiform writing, begun by the Sumerians in a period so remote that it is idle to speculate concerning it, had a long and very extensive history. It was first adopted by the Semitic Babylonians, and as we have seen was modified, developed, nay almost made over. Their inscriptions are written in it from circa 4500 B.C. to the 1st century B.C. From their hands it passed to the Assyrians, who simplified some characters and conventionalized many more, and used the script during the entire period of their national existence from 1500 B.C. to 607 B.C. From the Babylonian by a slow process of evolution the much simplified Persian script was developed, and with the Babylonian is also to be connected the Susian, less complicated than the Babylonian, but less simple than the Persian. The Chaldeans (not Chaldaeans), who lived about Lake Van, also adopted the cuneiform script with values of their own, and expressed a considerable literature in it. The discovery in 1887 of the Tell-el-Amarna tablets in upper Egypt showed that the same script was in use in the 15th century B.C., from Elam to the Mediterranean and from Armenia to the Persian Gulf for purposes of correspondence. There is good reason to expect the discovery of its use by yet other peoples. It was one of the most widely used of all the forms of ancient writing.

**BIBLIOGRAPHY.**—The history of the decipherment may be further studied in R. W. Rogers, *History of Babylonia and Assyria*, vol. i. (N. Y. and London, 1900); and in A. J. Booth, *The Discovery and Decipherment of the Trilingual Cuneiform Inscriptions* (London, 1902), which is very exhaustive and accurate. The Sumerian question may best be studied in F. H. Weissbach, *Die Sumerische Frage* (Leipzig, 1898), and Charles Fossey, *Manuel d'Assyriologie*, tome i. (Paris, 1904). For development and characteristics, see Friedrich Delitzsch, *Die Entstehung des ältesten Schriftsystems* (Leipzig, 1897); Paul Toscanne, *Les Signes sumériens dérivés* (Paris, 1905). (R. W. R.)

**CUNEO** (Fr. *Coni*), a town and episcopal see of Piedmont, Italy, the capital of the province of Cuneo, 55 m. by rail S. of Turin, 1722 ft. above sea-level. Cuneo lies on the railway from Turin to Ventimiglia, which farther on passes under the Col di Tenda (tunnel 5 m. long). It is also a junction for Mondovì and Saluzzo, and has steam tramways to Borgo S. Dalmazzo, Boves, Saluzzo and Dronero. Pop. (1901) 15,412 (town), 26,879 (commune). Its name ("wedge") is due to its position on a hill between two streams, the Stura and the Gesso, with fine views of the mountains. The Franciscan church, now converted into a military storehouse, belongs to the 12th century, but there are no other buildings of special interest. The fortifications have

been converted into promenades. Cuneo was founded about 1120 by refugees from local baronial tyranny, who, after the destruction of Milan by Barbarossa, were joined by Lombards. In 1382 it swore fealty to Amedeus VI., duke of Savoy. It was an important fortress, and was ceded by the treaty of Cherasco (1796), with Ceva and Tortona, to the French. In 1799 it was taken after ten days' bombardment by the Austrian and Russian armies, and, in 1800, after the victory of Marengo, the French demolished the fortifications.

**CUNEUS** (Latin for "wedge"; plural, *cunei*), the architectural term applied to the wedge-shaped divisions of the Roman theatre separated by the *scalae* or stairways; see Vitruvius v. 4.

**CUNITZ, MARIA** (c. 1610–1664), Silesian astronomer, was the eldest daughter of Dr Heinrich Cunitz of Schweinitz, and the wife (1630) of Dr Elias von Löven, of Pitschen in Silesia—both of them men of learning and distinction. From her universal accomplishments she was called the "Silesian Pallas," and the publication of her work, *Urania propitia* (Oels, 1650), a simplification of the Rudolphine Tables, gained her a European reputation. It was composed at the village of Luginitz, close by the convent of Olobok (Posen), where, with her husband, she had taken refuge at the outbreak of the Thirty Years' War, and was dedicated to the emperor Frederick III. The author became a widow in 1661, and died at Pitschen on the 24th of August 1664.

See A. G. Kästner, *Geschichte der Mathematik*, iv. 430 (1800); N. Henelli, *Silesiographia renovata*, cap. vi. p. 684; J. C. Ebert's *Schlesiens wohlgelehrtes Frauenszimmer*, p. 25 (Breslau, 1727); *Allgemeine deutsche Biographie* (Schimmelpfening); &c.

**CUNNINGHAM, ALEXANDER** (c. 1655–1730), Scottish classical scholar and critic, was born in Ayrshire. Very little is known of his uneventful life. It is probable that he completed his education at Leiden or Utrecht. He was tutor to the son of the first duke of Queensberry, through whose influence he was appointed professor of civil law in the university of Edinburgh. In 1710, the Edinburgh magistrates, regarding the university patronage as their privilege, appointed another professor, ignoring the appointment of Cunningham, who had been installed in the office for at least ten years. Cunningham thereupon left England for the Hague, where he resided until his death. He is chiefly known for his edition of Horace (1721) with notes, mostly critical, which included a volume of *Animadversiones* upon Richard Bentley's notes and emendations. They marked him as one of the most able critics of Bentley's (in many cases) rash and tasteless conjectural alterations of the text. Cunningham also edited the works of Virgil and Phaedrus (together with the *Sententiae* of Publilius Syrus and others). He had also been engaged for some years in the preparation of an edition of the Pandects and of a work on Christian evidences.

Life by D. Irving in *Lives of Scottish Writers* (1839).

The above must not be confused with Alexander Cunningham, British minister to Venice (1715–1720), a learned historian and author of *The History of Great Britain* (from 1688 to the accession of George I.), originally written in Latin and published in an English translation after his death.

**CUNNINGHAM, ALLAN** (1784–1842), Scottish poet and man of letters, was born at Keir, Dumfriesshire, on the 7th of December 1784, and began life as a stone mason's apprentice. His father was a neighbour of Burns at Ellisland, and Allan with his brother James visited James Hogg, the Ettrick shepherd, who became a friend to both. Cunningham contributed some songs to Roche's *Literary Recreations* in 1807, and in 1809 he collected old ballads for Robert Hartley Cromek's *Remains of Nithsdale and Galloway Song*; he sent in, however, poems of his own, which the editor inserted, even though he may have suspected their real authorship. In 1810 Cunningham went to London, where he supported himself chiefly by newspaper reporting till 1814, when he became clerk of the works in the studio of Francis Chantrey, retaining this employment till the sculptor's death in 1841. He meanwhile continued to be busily engaged in literary work. Cunningham's prose is often spoiled by its misplaced and too ambitious rhetoric; his verse also is often over-ornate, and both are full of mannerisms. Some of his songs, however, hold a high place among

British lyrics. "A Wet Sheet and a Flowing Sea" is one of the best of our sea-songs, although written by a landsman; and many other of Cunningham's songs will bear comparison with it. He died on the 30th of October 1842.

He was married to Jean Walker, who had been servant in a house where he lived, and had five sons and one daughter. JOSEPH DAVEY CUNNINGHAM (1812–1851) entered the Bengal Engineers, and is known by his *History of the Sikhs* (1849). SIR ALEXANDER CUNNINGHAM (1814–1893) also entered the Bengal Engineers; attaining the rank of major-general; he was director general of the Indian Archaeological Survey (1870–1885), and wrote an *Ancient Geography of India* (1871) and *Coins of Medieval India* (1894). PETER CUNNINGHAM (1816–1869) published several topographical and biographical studies, of which the most important are his *Handbook of London* (1849) and *The Life of Drummond of Hawthornden* (1833). FRANCIS CUNNINGHAM (1820–1875) joined the Indian army, and published editions of Ben Jonson (1871), Marlowe (1870) and Massinger (1871).

The works of Allan Cunningham include *Lives of the Most Eminent British Painters, Sculptors and Architects* (1829–1833); *Sir Marmaduke Maxwell* (1820), a dramatic poem; *Traditionary Tales of the Peasantry* (1822), several novels (*Paul Jones*, *Sir Michael Scott*, *Lord Roldan*); the *Maid of Elwar*, a sort of epic romance; the *Songs of Scotland* (1825); *Biographical and Critical History of the Literature of the Last Fifty Years* (1833); an edition of *The Works of Robert Burns*, with notes and a life containing a good deal of new material (1834); *Biographical and Critical Dissertations* affixed to Major's *Cabinet Gallery of Pictures*; and *Life, Journals and Correspondence of Sir David Wilkie*, published in 1843. An edition of his *Poems and Songs* was issued by his son, Peter Cunningham, in 1847.

**CUNNINGHAM, WILLIAM** (1805–1861), Scottish theologian and ecclesiastic, was born at Hamilton, in Lanarkshire, on the 2nd of October 1805, and educated at the university of Edinburgh. He was licensed to preach in 1828, and in 1830 was ordained to a collegiate charge in Greenock, where he remained for three years. In 1834 he was transferred to the charge of Trinity College parish, Edinburgh. His removal coincided with the commencement of the period known in Scottish ecclesiastical history as the Ten Years' Conflict, in which he was destined to take a leading share. In the stormy discussions and controversies which preceded the Disruption the weight and force of his intellect, the keenness of his logic, and his firm grasp of principle made him one of the most powerful advocates of the cause of spiritual independence; and he has been generally recognized as one of three to whom mainly the existence of the Free Church is due, the others being Chalmers and Candlish. On the formation of the Free Church in 1843 Cunningham was appointed professor of church history and divinity in the New College, Edinburgh, of which he became principal in 1847 in succession to Thomas Chalmers. His career was very successful, his controversial sympathies combined with his evident desire to be rigidly impartial qualifying him to be an interesting delineator of the more stirring periods of church history, and a skilful disentangler of the knotty points in theological polemics. In 1859 he was appointed moderator of the General Assembly. He had received the degree of D.D. from the university of Princeton in 1842. He died on the 14th of December 1861. He was one of the founders of the Evangelical Alliance. A theological lectureship at the New College, Edinburgh, was endowed in 1862, to be known as the Cunningham lectureship.

*A Life of Cunningham*, by Rainy and Mackenzie, appeared in 1871.

**CUNNINGHAM, WILLIAM** (1849– ), English economist, was born at Edinburgh on the 29th of December 1849. Educated at Edinburgh Academy and University and Trinity College, Cambridge, he graduated 1st class in the Moral Science tripos in 1873, and in the same year took holy orders. He was university lecturer in history from 1884 to 1891, in which year he was appointed professor of economics at King's College, London, a post which he held until 1897. He was lecturer in economic history at Harvard University (1899), and Hulsean lecturer at Cambridge (1885). He became vicar of Great St Mary's, Cambridge, in 1887, and was made a fellow of the British Academy. In 1906 he was appointed archdeacon of Ely. Dr Cunningham's

*Growth of English Industry and Commerce during the Early and Middle Ages* (1890; 4th ed., 1905) and *Growth of English Industry and Commerce in Modern Times* (1882; 3rd ed., 1903) are the standard works of reference on the industrial history of England. He also wrote *The Use and Abuse of Money* (1891); *Alien Immigration* (1897); *Western Civilization in its Economic Aspect in Ancient Times* (1898), and in *Modern Times* (1900), and *The Rise and Decline of Free Trade* (1905). Dr Cunningham's eminence as an economic historian gave special importance to his attitude as one of the leading supporters of Mr Chamberlain from 1903 onwards in criticizing the English free-trade policy and advocating tariff reform.

**CUP** (in O.E. *cuppe*; generally taken to be from Late Lat. *cuppa*, a variant of Lat. *cupa*, a cask, cf. Gr. *κύπελλον*), a drinking vessel, usually in the form of a half a sphere, with or without a foot or handles. The footless type with a single handle is preserved in the ordinary tea-cup. The cup on a stem with a base is the usual form taken by the cup as used in the celebration of the eucharist, to which the name "chalice" (Lat. *calix*, Gr. *κάλυξ*, a goblet) is generally given. (See DRINKING VESSELS and PLATE.)

**CUPAR**, a royal, municipal and police burgh, and capital of the county of Fifeshire, Scotland, 11 m. W. by S. of St Andrews by the North British railway. Pop. (1901) 4511. It is situated on the left bank of the Eden, in the east of the Howe (Hollow) of Fife, and is sometimes written Cupar-Fife to distinguish it from Coupar-Angus in Perthshire. Among the chief buildings are the town hall, county buildings, corn exchange, Duncan Institute, cottage hospital, Union Street Hall and the Bell-Baxter school. The school, formerly called the Madras Academy, was originally endowed (1832) by Dr Bell, founder of the Madras system of education, but, having been enriched at a later date by a bequest of Sir David Baxter (1873), it was afterwards called the Bell-Baxter school. The Mercat Cross stands at "the Cross" in the main street, where it was set up in 1897, having been removed from Hilltarvit, an eminence in the neighbourhood of Cupar, on the western slope of which, at Garliebank, the truce was signed between Mary of Guise and the lords of the Congregation. In the parish, but at a distance from the town, are the Fife and Kinross asylum and the Adamson institute, a holiday home for poor children from Leith. The town received its charter in 1356 from David II., and, being situated between Falkland and St Andrews, was constantly visited by Scottish sovereigns, James VI. holding his court there for some time in 1583. The site of the 12th-century castle, one of the strongholds of the Macduffs, thanes or earls of Fife, is occupied by a public school. On the esplanade in front of Macduff Castle, still called the Playfield, took place in 1552 one of the first recorded performances of Sir David Lindsay's *Ane Satyre of the Three Estaitis* (1540); his *Tragedy of the Cardinal* (1547), referring to the murder of Beaton, being also performed there. Sir David sat in the Scottish parliament as commissioner for Cupar, his place, the Mount, being within 3 m. north-west of the town. Lord Chancellor Campbell (1799-1861) was a native of Cupar.

Cupar is an agricultural and legal centre. Its chief industry is the manufacture of linen, and tanning is carried on. At Cupar Muir, 1½ m. to the west, there are a sandstone quarry and brick works. The town has also some repute for the quality of its printing, both in black and colour. This was largely due to the Tullis press, which produced about the beginning of the 19th century editions of Virgil, Horace and other classical writers, under the recension of Professor John Hunter of St Andrews, which were highly esteemed for the accuracy of their typography. Cupar belongs to the St Andrews district group of burghs for returning one member to parliament, the other constituents being Craig, the two Anstruthers, Killrenny, Pittenweem and St Andrews.

There are several interesting places within a few miles. To the north-east is the parish of Dairsie, where one of the few parliaments that ever met in Fife assembled in 1335. The castle in which the senate sat was also the residence for a period of

Archbishop Spottiswood, who founded the parish church in 1621. Two miles and a half north of Dairsie is situated Kilmany, which was the first charge of Thomas Chalmers. He was ordained to it in May 1803 and held it for twelve years. David Hackston, the Covenanter, who was a passive assister at the assassination of Archbishop Sharp, belonged to this parish, his place being named Rathillet. After his execution at Edinburgh (1680) one of his hands was buried at Cupar, where a monument inscription records the circumstances of his death. To the west of Kilmany lies Creich, where Alexander Henderson (1583-1646), the Covenanted divine and diplomatist, and John Sage (1652-1711), the non-juring archbishop of Glasgow, were born. Henderson took a keen interest in education and gave the school at Creich a small endowment. Some 3 m. to the south-west of Cupar is Cults, where Sir David Wilkie, the painter, was born. His father was minister of the parish, and Pitlessie, the fair of which provided the artist with the subject of the first picture in which he showed distinct promise, lies within a mile of the manse. In the sandstone of Dura Den, a ravine on Ceres Burn, 2½ m. E. of Cupar, have been found great quantities of fossils of ganoid fishes. The rocks belong to the Upper Old Red Sandstone.

**CUPBOARD**, a fixed or movable closet usually with shelves. As the name suggests, it is a descendant of the credence or buffet, the characteristic of which was a series of open shelves for the reception of drinking vessels and table requisites. After the word lost its original meaning—and down to the end of the 16th century we still find the expression "on the cupboard"—this piece of furniture was, as it to some extent remains, movable, but it is now most frequently a fixture designed to fill a corner or recess. Throughout the 18th century the cupboard was a distinguished domestic institution, and the housewife found her chief joy in accumulating cupboards full of china, glass and preserves. With the exception of a very few examples of fine ecclesiastical cupboards which partook chiefly of the nature of the armoire in that they were intended for the storage of vestments, the so-called court-cupboard is perhaps the oldest form of the contrivance. The derivation of the expression is somewhat obscure, but it is generally taken to refer to the French word *court*, short. This particular type was much used from the Elizabethan to the end of the Carolinian period. It was really a sideboard with small square doors below, and a recessed superstructure supported upon balusters. Of these many examples remain. Less frequent is the livery cupboard, the meaning of which may be best explained by the following quotation from Spenser's *Account of the State of Ireland*:—"What livery is we by common use in England know well enough, namely, that it is an allowance of horse-meat, as they commonly use the word stabling, as to keep horses at livery; the which word I guess is derived of livering or delivering forth their nightly food; so in great houses the livery is said to be served up for all night—that is, their evening allowance for drink." The livery cupboard appears usually to have been placed in bedrooms, so that a supply of food and drink was readily available when a very long interval separated the last meal of the evening from the first in the morning. The livery cupboard was often small enough to stand upon a sideboard or cabinet, and had an open front with a series of turned balusters. It was often used in churches to contain the loaves of bread doled out to poor persons under the terms of ancient charities. They were then called dole cupboards; there are two large and excellent examples in St Alban's Abbey. The butter, or bread and cheese cupboard, was a more ordinary form, with the back and sides bored with holes, sometimes in a geometrical pattern, for the admission of air to the food within. The corner cupboard, which is in many ways the most pleasing and artistic form of this piece of furniture, originated in the 18th century, which as we have seen was the golden age of the cupboard. It was often of oak, but more frequently of mahogany, and had either a solid or a glass front. The older solid-fronted pieces are fixed to the wall half-way up, but those of the somewhat more modern type, in which there is much glass, usually have a wooden base with glazed superstructure. Most corner cupboards are attractive

in form and treatment, and many of them, inlaid with satinwood, ebony, holly or box, are extremely elegant.

**CUPID** (*Cupido*, "desire"), the Latin name for the god of love, *EROS* (*q.v.*). Cupid is generally identical with *Amor*. The idea of the god of love in Roman poetry is due to the influence of Alexandrian poets and artists, in whose hands he degenerated into a mischievous boy with essentially human characteristics. His usual attribute is the bow. For the story of Cupid and *Psyche*, see under *PSYCHE*.

**CUPOLA** (Ital., from Lat. *cupula*, small cask or vault, *cupa*, tub), a term, in architecture, for a spherical or spheroidal covering to a building, or to any part of it. In fortification the word is used of a form of armoured structure, in which guns or howitzers are mounted. It is a low flat turret resembling an overturned saucer and showing little above the ground except the muzzles of the guns. See for details and illustrations *FORTIFICATION AND SIEGECRAFT*; also *ORDNANCE*.

**CUPPING**. The operation of cupping is one of the methods that have been adopted by surgeons to draw blood from an inflamed part in order to relieve the inflammation. The skin is washed and dried; a glass cup with a rounded edge is then firmly applied, after the air in it has been heated; the cooling of the air causes the formation of a partial vacuum, and the blood is thus drawn from the neighbouring parts to the skin under the cup. Either the blood is drawn from the patient's body through a number of small wounds which are made in the skin, with a special instrument, before the cup is applied; or the cup is simply applied to the unbroken skin and the blood drawn into the subcutaneous tissue within the circumference of the cup. The result of both methods is the same,—namely, a withdrawal of blood locally from the inflamed part. The former is called moist cupping, the latter dry cupping. This operation has naturally declined in vogue with the obsolescence of blood-letting as a remedy.

**CUPRA**, the name of two ancient Italian *municipia* in Picenum.

1. *Cupra Maritima* (*Civita di Marano* near the modern *Cupra Marittima*), on the Adriatic coast, 48 m. S.S.E. of *Ancona*, erected in the neighbourhood of an ancient temple of the Sabine goddess *Cupra*, which was restored by *Hadrian* in A.D. 127, and probably (though there is some controversy on the point) occupied the site of the church of *S. Martino*, some way to the south, in which the inscription of *Hadrian* exists. At *Civita* the remains of what was believed to be the temple were more probably those of the forum of the town, as is indicated by the discovery of fragments of a calendar and of a statue of *Hadrian*. Some statuettes of *Juno* were also among the finds. An inscription of a water reservoir erected in 7 B.C. is also recorded. But the more ancient *Picene* town appears to have been situated near the hill of *S. Andrea*, a little way to the south, where pre-Roman tombs have been discovered.

See *C. Hülsen* in *Pauly-Wissowa, Realencyclopädie* (Stuttgart, 1901), iv. 1760; *G. Speranza, Il Piceno* (*Ascoli Piceno*, 1900), i. 119 seq.

2. *Cupra Montana*, 10 m. S.W. of *Aesis* (mod. *Jesi*) by road. The village, formerly called *Massaccio*, has resumed the ancient name. Its site is fixed by inscriptions—cf. *Th. Mommsen in Corp. Inscript. Lat.* ix. (Berlin, 1883), p. 543; and various ruins, perhaps of baths, and remains of subterranean aqueducts have been discovered near the church of *S. Eleuterio*.

See *F. Menicucci* in *G. Colucci, Antichità Picene*, xx. (1793).

**CUPRITE**, a mineral consisting of cuprous oxide,  $\text{Cu}_2\text{O}$ , crystallizing in the cubic system, and forming an important ore of copper, of which element cuprite contains 88.8%. The name cuprite (from Lat. *cuprum*, copper) was given by *W. Haidinger* in 1845; earlier names are red copper ore and ruby copper, which at once distinguish this mineral from the other native copper oxide—cupric oxide—known as black copper ore or *melaconite*. Well-developed crystals are of common occurrence; they usually have the form of the regular octahedron, sometimes in combination with the cube and the rhombic dodecahedron. A few Cornish crystals have been observed with faces of a form  $\{hkl\}$  known as the pentagonal icositetrahedron,

since it is bounded by twenty-four irregular pentagons. In this class of cubic crystals there are no planes or centre of symmetry, but the full number (thirteen) of axes of symmetry; it is known as the trapezohedral hemihedral class, and cuprite affords the best example of this type of symmetry. The etching figures do not, however, conform to this lower degree of symmetry, nor do crystals of cuprite rotate the plane of polarization of plane-polarized light. The colour of the mineral is cochineal-red, and the lustre brilliant and adamantine to sub-metallic in character; crystals are often translucent, and show a crimson-red colour by transmitted light. On prolonged exposure to light the crystals become dull and opaque. The streak is brownish-red. Hardness  $3\frac{1}{2}$ ; specific gravity 6.0; refractive index 2.85.

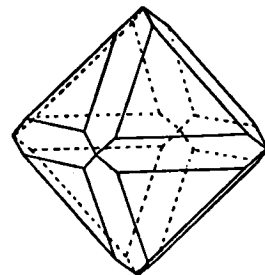

Compact to granular masses also occur, and there are two curious varieties—*chalcotrichite* and *tile-ore*—which require special mention. *Chalcotrichite* (from Gr. *χαλκός*, copper, and *θρίξ*, *τριχός*, hair) or "plush copper ore" is a capillary form with a rich carmine colour and silky lustre; the delicate hairs are loosely matted together, and each one is an individual crystal enormously elongated in the direction of the diagonal or the edge of the cube. *Tile-ore* (Ger. *Ziegelerz*) is a soft earthy variety of a brick-red to brownish-red colour; it contains admixed limonite, and has been formed by the alteration of *chalcopyrite* (copper and iron sulphide).

Cuprite occurs in the upper part of copper-bearing lodes, and is of secondary origin, having been produced by the alteration of copper sulphides. Beautifully crystallized specimens were formerly found in *Wheal Gorland* and *Wheal Unity* at *Gwennap*, and in *Wheal Phoenix* near *Liskeard* in *Cornwall*; they also occur in the copper mines of the *Urals*, and in *Arizona*. Isolated crystals bounded by faces on all sides, and an inch or more in diameter, are found embedded in a soft white clay at *Chessy* near *Lyons*; they are usually altered on the surface, or through-out, to *malachite*. *Chalcotrichite* comes from *Wheal Phoenix* and *Fowey Consols* mine in *Cornwall*, and from *Morenci* in *Arizona*; *tile-ore* from *Bogoslovsk* in the *Urals*, *Atacama* in *South America*, and other localities. Small crystals of cuprite, together with *malachite*, *azurite* and *cerussite*, are sometimes found encrusting ancient objects of copper and bronze, such as *celts* and *Roman coins*, which have for long periods remained buried in the soil. Artificially formed crystals have been observed in furnace products. (L. J. S.)

**CUPULIFERAE**, a botanical order, or, in recent arrangements, group of orders, containing several familiar trees. The plants are trees or shrubs with simple leaves alternately arranged and small unisexual flowers generally arranged in catkins and pollinated by wind-agency. The generally one-seeded nut-like fruit is associated with the persistent often hardened or greatly enlarged bracts forming the so-called cupule which gives the name to the group. The group is subdivided as follows, and these subdivisions are now generally regarded either as distinct natural orders or the first two as sub-orders of one natural order.

*Betuleae* or *Betulaceae*. Female flowers arranged, two to three together on scale-like structures formed by the union of bracts, in catkins; ovary two-celled; fruit small, flattened, protected between the ripened scales of the catkin. Includes *Betula* (birch) and *Alnus* (alder).

*Coryleae* or *Corylaceae*. Female flowers in pairs, the bracts enlarging in the fruit to form a membranous cup (hazel), or a flat three-lobed structure (hornbeam). Ovary two-celled. Includes *Corylus* (hazel) and *Carpinus* (hornbeam).

*Fagaceae* (Cupuliferae in a restricted sense). Bracts forming a fleshy or hard cupule which envelops the one to several fruits. Ovary three-celled. Includes *Quercus* (oak), *Fagus* (beech), *Castanea* (sweet-chestnut).

Detailed accounts of the trees will be found under separate headings.



**CURAÇAO**, or CURAÇOA, an island in the Dutch West Indies. It lies 40 m. from the north coast of Venezuela, in 12° N. and 69° W., being 40 m. long from N.W. to S.E., with an average width of 10 m. and an area of 212 sq. m. The surface is generally flat, but in the south-west there are hills attaining an elevation of 1200 ft. The shores are in places deeply indented, forming several natural harbours, the chief of which is that of St Anna on the south-west coast. Curaçao consists of eruptive rocks, chiefly diorite and diabase, and is surrounded by coral reefs. Streams are few and the rainfall is scanty, averaging only 16 in. per annum. Although the plains are for the most part arid wastes, sugar, aloes, tobacco and divi-divi are produced with much toil in the more fertile glens. Salt, phosphates and cattle are exported. The commerce is mainly with the United States, and there is a large carrying trade with Venezuela. The famous Curaçoa liqueur (see below) was originally made on the island from a peculiar variety of orange, the *Citrus Aurantium curasaviensis*. Willemstad (pop. about 8000), on the harbour of St. Anna, is the principal town. It bears a strong resemblance to a Dutch town, for the houses are built in the style of those of Amsterdam, and the narrow channel separating it from its western suburb of Overzijde and the waters of the Waigat, which intersect it, recall the canals. The narrow entrance leading to the Schottegat or Inner Harbour is protected by forts. The negroes of the island speak a curious dialect called *Papamento*, composed of Spanish, Dutch, English and native words. Curaçao gives name to the government of the Dutch West Indies, which consists of Aruba, an island lying W. of Curaçao, with an area of 69 sq. m. and a population of 9591; Buen Ayre, lying 20 m. N.E., with an area of 95 sq. m. and a population of 4926; together with St Eustatius, Saba and part of St Martin. The governor is assisted by a council of four members and a colonial council of eight members nominated by the crown. The island of Curaçao has a population of 30,119; and altogether the Dutch West Indies have a population of 51,693.

Curaçao was discovered by Hojeda about 1499 and occupied by the Spaniards in 1527. In 1634 it fell into the hands of the Dutch, who have held it ever since, except during the year 1798 and from 1806 to 1814 when it passed into the possession of Great Britain.

See Wynmalen, "Les Colonies néerlandaises dans les Antilles," *Revue colon. internat.* (1887), ii. p. 391; K. Martin, *West-Indische Skizzen* (Leiden, 1887); De Veer, *La Colonie de Curaçoa* (Les Pays Bas, 1898). Also several articles on all the islands in *Tijdschrift v. h. Ned. Aardr. Genootschap* (1883-1886).

**CURAÇOA**, a liqueur, chiefly manufactured in Holland. It is relatively simple in composition, the predominating flavour being obtained from the dried peel of the Curaçoa orange. The method of preparation is in principle as follows. The peel is first softened by maceration; then a part of the softened peel is distilled with spirit and water, and the remainder is macerated in a portion of the distillate so obtained. After two or three days the infusion is strained and added to the remainder of the original distillate. This simple method is subject to variations in manufacture, and the addition of a small quantity of Jamaica rum, in particular, is said to much improve the flavour. Dry Curaçoa contains about 39%, the sweet variety about 36% of alcohol. A lighter variety of Curaçoa, made with fine brandy, is known as "Grand Marnier."

**CURASSOW** (*Cracinae*), a group of gallinaceous birds forming one of the subfamilies of *Cracidae*, the species of which are among the largest and most splendid of the game birds of South America, where they may be said to represent the pheasants of the Old World. They are large, heavy birds, many of them rivalling the turkey in size, with short wings, long and broad tail, and strong bill. In common with the family to which they belong, they have the hind toe of the foot placed on a level with the others, thus resembling the pigeons, and unlike the majority of gallinaceous birds. With the exception of a single species found north of Panama, the curassows are confined to the tropical forests of South America, east of the Andes, and not extending south of Paraguay. They live in small flocks, and are arboreal in their habits, only occasionally descending to the

ground, while always roosting and building their nests on the branches of trees. Their nests are neat structures, made of slender branches interlaced with stems of grass, and lined internally with leaves. They feed on fruits, seeds and insects. They are often tamed in several parts of South America, but have never been thoroughly domesticated anywhere. Large numbers of these birds were, according to K. J. Temminck, brought to Holland from Dutch Guiana towards the end of the 18th century, and got so completely acclimatized and domesticated as to breed in confinement like ordinary poultry; but the establishments in which these were kept were broken up during the troubles that followed on the French Revolution. Their flesh is said to be exceedingly white and delicate, and this, together with their size and the beauty of their plumage, would make the curassows an important gain to the poultry yards of Europe, if they were not such bad breeders. The subfamily of curassows contains four genera and twelve species, all confined to South America, with the exception of *Crax globicera*—a Central American species, which extends northward into Mexico. This bird is about 3 ft. in length, of a glossy black colour over the whole body, excepting the abdomen and tail coverts, which are white. In common with the other species of this genus its head bears a crest of feathers curled forward at the tips, which can be raised or depressed at will. The female is of a reddish-brown colour, although varying greatly in this respect, and was formerly described as a separate species—the red curassow. In another species, *Crax incommoda*, the greater part of the black plumage is beautifully varied with narrow transverse bars of white. The galeated curassow (*Pauxi galeata*) is peculiar in having a large blue tubercle, hard and stony externally, but cellular within, and resembling a hen's egg in size and shape, situated at the base of the bill. It only appears after the first moulting, and is much larger in the male than in the female.

**CURATE** (from the Lat. *curare*, to take care of), properly a presbyter who has the cure of souls within a parish. The term is used in this general sense in certain rubrics of the English Book of Common Prayer, in which it is applied equally to rectors and vicars as to perpetual curates. So, on the continent of Europe, it is applied in this sense to parish priests, as the Fr. *curé*, Ital. *curato*, Span. *cura*, &c. In a more limited sense it is applied in the Church of England to the incumbent of a parish who has no endowment of tithes, as distinguished from a perpetual vicar, who has an endowment of small tithes, which are for that reason sometimes styled vicarial tithes. The origin of such unendowed curacies is traceable to the fact that benefices were sometimes granted to religious houses *pleno jure*, and with liberty for them to provide for the cure; and when such appropriations were transferred to lay persons, being unable to serve themselves, the impropiators were required to nominate a clerk in full orders to the ordinary for his licence to serve the cure. Such curates, being not removable at the pleasure of the impropiators, but only on due revocation of the licence of the ordinary, came to be entitled perpetual curates. The term "curate" in the present day is almost exclusively used to signify a clergyman who is assistant to a rector or vicar, by whom he is employed and paid; and a clerk in deacon's orders is competent to be licensed by a bishop to the office of such assistant curate. The consequence of this misuse of the term "curate" was that the title of "perpetual curate" fell into desuetude in the Anglican Church, and an act of parliament (1868) was passed to authorize perpetual curates to style themselves vicars (see VICAR). The term is in use in the Roman Catholic Church in Ireland to designate an assistant clergyman, and also to a certain extent in the American Episcopal Church, though "assistant minister" is usually preferred.

**CURATOR** (Lat. for "one who takes care," *curare*, to take care of), in Roman law the "caretaker" or guardian of a spendthrift (*prodigus*) or of a person of unsound mind (*furiosus*), and, more particularly, one who takes charge of the estate of an *adolescens*, i.e. of a person *sui juris*, above the age of a *pupillus*, fourteen or twelve years, according to sex, and below the full age of twenty-five. Such persons were known as "minors,"

*i.e. minores viginti quinque annis.* While the tutor, the guardian of the *pupillus*, was said to be appointed for the care of the person, the curator took charge of the property. The term survives in Scots law for the guardian of one in the second stage of minority, *i.e.* below twenty-one, and above fourteen, if a male, and twelve, if a female. Under the Roman empire the title of curator was given to several officials who were in charge of departments of public administration, such as the *curatores annonae*, of the public supplies of corn and oil, or the *curatores regionum*, who were responsible for order in the fourteen *regiones* or districts into which the city of Rome was divided, and who protected the citizen from exaction in the collection of taxes; the *curatores aquarum* had the charge of the aqueducts. Many of these curatorships were instituted by Augustus. In modern usage "curator" is applied chiefly to the keeper of a museum, art collection, public gallery, &c., but in many universities to an official or member of a board having a general control over the university, or with the power of electing to professorships. In the university of Oxford "curators" are nominated to administer certain departments, such as the University Chest.

**CURCI, CARLO MARIA** (1810-1891), Italian theologian, was born at Naples. He joined the Jesuits in 1826, and for some time was devoted to educational work and the care of the poor and prisoners. He became one of the first editors of the Jesuit organ, the *Civiltà Cattolica*; but then came under the influence of Gioberti, Rosmini and other advocates for reform. He wrote a preface to Gioberti's *Primato* (1843), but dissented from his *Prolegomena*. After the events of 1870, Curci, at Florence, delivered a course on Christian philosophy; and in 1874 began to publish several Scriptural works. In his edition of the New Testament (1879-1880) he makes some severe remarks on the neglect of the study of Scripture amongst the Italian clergy. In the meantime he began to attack the political action of the Vatican, and in his *Il Moderno Dissidio tra la Chiesa e l'Italia* (1878) he advocated an understanding between the church and state. This was followed by *La Nuova Italia ed i Vecchi Zelanti* (1881), another attack on the Vatican policy; and by his *Vaticano Regio* (1883), in which he accuses the Vatican of trafficking in holy things and declares that the taint of worldliness came from the false principles accepted by the Curia. His former work at Naples drew him also in the direction of Christian Socialism. He was condemned at Rome, and in a letter to *The Times* (10th of September 1884) declares that it was on account of his disobedience to the decrees of the Roman Congregation: "I am a dutiful son of the Church who hesitates to obey an order of his mother because he does not see clear enough the maternal authority in it." He was cast out of the Society of Jesus and suspended, and during this time Cardinal Manning put his purse at Curci's disposal. Finally he accepted the decrees against him and retracted "all that he said contrary to the faith, morals and discipline of the Church." He passed the remainder of his life in retirement at Florence, and, a few months before his death, was readmitted to the Jesuit Society. He died on the 8th of June 1891.

(E. IN.)

**CUREL, FRANÇOIS, VICOMTE DE** (1854- ), French dramatist, was born at Metz on the 10th of June 1854. He was educated at the École Centrale as a civil engineer, the family wealth being derived from smelting works. He began his literary career with two novels, *L'Été des fruits secs* (1885) and *Le Sauvetage du grand duc* (1889). In 1891 three pieces were accepted by the Théâtre Libre. The list of his plays includes *L'Envers d'une sainte* (1892); *Les Fossiles* (1892), a picture of the prejudices of the provincial nobility; *L'Invitée* (1893), the story of a mother who returns to her children after twenty years' separation; *L'Amour brode* (1893), which was withdrawn by the author from the Théâtre Français after the second representation; *La Figurante* (1896); *Le Repas du lion* (1898), dealing with the relations between capital and labour; *La Fille sauvage* (1902), the history of the development of the religious idea; *La Nouvelle Idole* (1899), dealing with the worship of science; and *Le Coup d'aile* (1906).

See also *Contemporary Review* for August 1903.

**CURÉLY, JEAN NICOLAS** (1774-1827), French cavalry leader, was the son of a poor peasant of Lorraine. Joining, in 1793, a regiment of hussars, he served with great distinction as private and as *sous-officier* in the Rhine campaigns from 1794 to 1800. He was, however, still a non-commissioned officer of twelve years' service, when at Afflenz (12th of November 1805) he attacked and defeated, with twenty-five men, a whole regiment of Austrian cavalry. This brilliant feat of arms won him the grade of *sous-lieutenant*, and the reputation of being one of the men of the future. The next two campaigns of the *Grande Armée* gained him two more promotions, and as a captain of hussars he performed, in the campaign of Wagram, a feat of even greater daring than the affair of Afflenz. Entrusted with despatches for the viceroy of Italy, Curély, with forty troopers, made his way through the Austrian lines, reconnoitred everywhere, even in the very headquarters-camp of the archduke John, and finally accomplished his mission in safety. This exploit, only to be compared to the famous raids of the American Civil War, and almost unparalleled in European war, gained him the grade of *chef d'escadrons*, in which for some years he served in the Peninsular War. Under Gouvion St Cyr he took part in the Russian War of 1812, and in 1813 was promoted colonel. In the campaign of France (1814) Curély, now general of brigade, commanded a brigade of "improvised" cavalry, and succeeded in infusing into this unpromising material some of his own daring spirit. His regiments distinguished themselves in several combats, especially at the battle of Arcis-sur-Aube. The Restoration government looked with suspicion on the most dashing cavalry leader of the younger generation, and in 1815 Curély, who during the Hundred Days had rallied to his old leader, was placed on the retired list. Withdrawing to the little estate of Jaulny (near Thiaucourt), which was his sole property, he lived in mournful retirement, which was saddened still further when in 1824 he was suddenly deprived of his rank. This last blow hastened his death. Curély, had he arrived at high command earlier, would have been ranked with Lasalle and Montbrun, but his career, later than theirs in beginning, was ended by the fall of Napoleon. His devoted friend, De Brack, in his celebrated work *Light Cavalry Outposts*, considers Curély incomparable as a leader of light cavalry, and the portrait of Curély to be found in its pages is justly ranked as one of the masterpieces of military literature. The general himself left but a modest manuscript, which was left for a subsequent generation to publish.

See also Thoumas, *Le Général Curély: itinéraires d'un Cavalier léger, 1793-1815* (Paris, 1887).

**CURES**, a Sabine town between the left bank of the Tiber and the Via Salaria, about 26 m. from Rome. According to the legend, it was from Cures that Titus Tatius led to the Quirinal the Sabine settlers, from whom, after their union with the settlers on the Palatine, the whole Roman people took the name Quirites. It was also renowned as the birthplace of Numa, and its importance among the Sabines at an early period is indicated by the fact that its territory is often called simply *ager Sabinus*. At the beginning of the imperial period it is spoken of as an unimportant place, but seems to have risen to greater prosperity in the 2nd century. It appears as the seat of a bishop in the 5th century, but seems to have been destroyed by the Lombards in A.D. 589. The site consists of a hill with two summits, round the base of which runs the Fosso Corese: the western summit was occupied by the necropolis, the eastern by the citadel, and the lower ground between the two by the city itself. A temple, the forum, the baths, &c., were excavated in 1874-1877.

See T. Ashby in *Papers of the British School at Rome*, iii. 34. (T. As.)

**CURETES** (Gr. *Kolophnes* and *Kouphnes*). (1) A legendary people mentioned by Homer (*Il.* ix. 529 ff.) as taking part in the quarrel over the Calydonian boar. They were identified in antiquity as either Aetolians or Acarnanians (Strabo 462, 26), and were also represented by a stock in Chalcis in Euboea. (2) In mythology (unconnected with the above), the attendants of Rhea. The story went that they saved the infant Zeus from his father Cronus in Crete by surrounding his cradle and with

clashing of sword and shield preventing his cries from being heard, and thus became the body-guard of the god and the first priests of Zeus and Rhea. In historic times the cult of the Curetes was widely known in Greece in connexion with that of Rhea (*q.v.*). Its ceremonies consisted principally in the performance of the Pyrrhic dance to the accompaniment of hymns and flute music, by the priests, who represented and thus commemorated the original act of the Curetes themselves. The dance was originally distinguished from that of the Corybantes by its comparative moderation, and took on the full character of the latter only after the cult of the Great Mother, Cybele, to which it belonged, spread to Greek soil. The origin of the dance may have lain in the supposed efficacy of noise in averting evil.

The Curetes are represented in art with shield and sword performing the sacred dance about the infant Zeus, sometimes in the presence of a female figure which may be Rhea. Their number in art is usually two or three, but in literature is sometimes as high as ten. Of their names the following have survived: Kures, Kres, Biennos, Eleuther, Itanos, Labrandos, Panamoros, Palaxos; but no complete list of names is possible because of their confusion with the names of the Corybantes and other like deities. Their origin is variously related: they were earth-born, sprung of the rain, sons of Zeus and Hera, sons of Apollo and Danaï, sons of Rhea, of the Dactyli, contemporary with the Titans (Diod. Sic. v. 66). Rationalism made them the mortal sons of a mortal Zeus, or originators of the Pyrrhic dance, inventors of weapons, fosterers of agriculture, regulators of social life, &c. A plausible theory is that of Georg Kaibel (*Göttinger Nachrichten*, 1901, pp. 512-514), who sees in them, together with the Corybantes, Cabeiri, Dactyli, Telchines, Titans, &c., only the same beings under different names at different times and in different places. Kaibel holds that they all had a phallic significance, having once been great primitive deities of procreation, and that having fallen to an indistinct, subordinate position in the course of the development and formalization of Greek religion, they survive in historic times only as half divine, half demonic beings, worshipped in connexion with the various forms of the great nature goddess. The resemblances, especially between Rhea and her Curetes and the Great Mother and her Corybantes (*q.v.*), were so striking that their origins were inextricably confused even in the minds of the ancients: *e.g.* Demetrius of Scepsis (Strabo 469, 12) derives the Curetes and Rhea from the cult of the Great Mother in Asia, while Virgil (*Aen.* iii. 111) looks upon the latter and the Corybantes as derivations from the former. The worship of both was akin in nature to that of the Dactyli, the Cabeiri, and even of Dionysus, the special visible bond being the orgiastic character of their rites.

Consult Immisch in Roscher's *Lexicon*, s. v. "Kureten." (G. SN.)

**CURETON, WILLIAM** (1808-1864), English Orientalist, was born at Westbury, in Shropshire. After being educated at the free grammar school of Newport, and at Christ Church, Oxford, he took orders in 1832, became chaplain of Christ Church, sub-librarian of the Bodleian, and, in 1837, assistant keeper of MSS. in the British Museum. He was afterwards appointed select preacher to the university of Oxford, chaplain in ordinary to the queen, rector of St Margaret's, Westminster, and canon of Westminster. He was elected a fellow of the Royal Society and a trustee of the British Museum, and was also honoured by several continental societies. He died on the 17th of June 1864.

Cureton's most remarkable work was the edition with notes and an English translation of the Epistles of Ignatius to Polycarp, the Ephesians and the Romans, from a Syriac MS. that had been found in the monastery of St Mary Deipara, in the desert of Nitria, near Cairo. He held that the MS. he used gave the truest text, that all other texts were inaccurate, and that the epistles contained in the MS. were the only genuine epistles of Ignatius that we possess—a view which received the support of F. C. Baur, Bunsen, and many others, but which was opposed by Charles Wordsworth and by several German scholars, and is now generally abandoned (see *IGNATIUS*). Cureton supported his view by his *Vindiciae Ignatianae* and his *Corpus Ignatianum*,—a Complete Collection of the Ignatian Epistles, genuine, interpolated and spurious. He also edited a partial Syriac text of the *Festal Letters of St Athanasius*, which was translated into English by Henry Burgess (1854), and published in the *Library of*

*Fathers of the Holy Catholic Church; Remains of a very Ancient Recension of the Four Gospels in Syriac, hitherto unknown in Europe; Spicilegium Syriacum, containing Remains of Bardesan, Meliton, Ambrose, Mara Bar Serapion; The third Part of the Ecclesiastical History of John, Bishop of Ephesus, which was translated by Payne Smith; Fragments of the Iliad of Homer from a Syriac Palimpsest; an Arabic work known as the Thirty-first Chapter of the Book entitled The Lamp that guides to Salvation, written by a Christian of Tekrit; The Book of Religious and Philosophical Sects, by Muhammed al Sharastani; a Commentary on the Book of Lamentations, by Rabbi Tanchum; and the Pillar of the Creed of the Sunnites.* Cureton also published several sermons, among which was one entitled *The Doctrine of the Trinity not Speculative but Practical*. After his death Dr W. Wright edited with a preface the *Ancient Syriac Documents relative to the earliest Establishment of Christianity in Edessa and the neighbouring Countries, from the Year of our Lord's Ascension to the beginning of the Fourth Century; discovered, edited and annotated by the late W. Cureton.*

**CURETUS**, a tribe of South American Indians, inhabiting the country between the rivers of Japura and Uaupés, north-western Brazil. They are short but sturdy, wear their hair long, and paint their bodies. Their houses are circular, with walls of thatch and a high conical roof. They are a peaceable people, living in small villages, each of which is governed by a chief.

**CURFEW**, *CURFEU* or *COUVRE-FEU*, a signal, as by tolling a bell, to warn the inhabitants of a town to extinguish their fires or cover them up (hence the name) and retire to rest. This was a common practice throughout Europe during the middle ages, especially in cities taken in war. In the law Latin of those times it was termed *ignilegium* or *pyrilegium*. In medieval Venice it was a regulation from which only the Barbers' Quarter was exempt, doubtless because they were also surgeons and their services might be needed during the night. The curfew originated in the fear of fire when most cities were built of timber. That it was a most useful and practical measure is obvious when it is remembered that the household fire was usually made in a hole in the middle of the floor, under an opening in the roof through which the smoke escaped. The custom is commonly said to have been introduced into England by William the Conqueror, who ordained, under severe penalties, that at the ringing of the curfew-bell at eight o'clock in the evening all lights and fires should be extinguished. But as there is good reason to believe that the curfew-bell was rung each night at Carfax, Oxford (see Peshall, *Hist. of Oxford*), in the reign of Alfred the Great, it would seem that all William did was to enforce more strictly an existing regulation. The absolute prohibition of lights after the ringing of the curfew-bell was abolished by Henry I. in 1100. The practice of tolling a bell at a fixed hour in the evening, still extant in many places, is a survival of the ancient curfew. The common hour was at first seven, and it was gradually advanced to eight, and in some places to nine o'clock. In Scotland ten was not an unusual hour. In early Roman times curfew may possibly have served a political purpose by obliging people to keep within doors, thus preventing treasonable nocturnal assemblies, and generally assisting in the preservation of law and order. The ringing of the "prayer-bell," as it is called, which is still practised in some Protestant countries, originated in that of the curfew-bell. In 1848 the curfew was still rung at Hastings, Sussex, from Michaelmas to Lady-Day, and this was the custom too at Wrexham, N. Wales.

**CURIA**, in ancient Rome, a section of the Roman people, according to an ancient division traditionally ascribed to Romulus. He is said to have divided the people into three tribes, and to have subdivided each of these into ten *curiae*, each of which contained a number of families (*gentes*). It is more probable that the *curiae* were not purely artificial creations, but represented natural associations of families, artificially regulated and distributed to serve a political purpose. The local names of *curiae* which have come down to us suggest a local origin for the groups; but as membership was hereditary, the local tie doubtless grew weak with successive generations. Each *curia* was organized as a political and religious unit. As a political corporation it had no recognized activities beyond the command of a vote in the *Comitia Curiata* (see *COMITIA*), a vote whose nature was determined by a majority in the votes of the individual members

(*curiales*). But as a religious unit the *curia* had more individual activity. There were, it is true, ceremonies (*sacra*) performed by all the *curiae* to *Juno Curis* in which each *curia* offered its part in a collective rite of the whole people; but each *curia* had also its peculiar *sacra* and its own special place of worship. The religious affairs of each were conducted by a priest called *curio* assisted by a *flamen curialis*. The thirty *curiae* must always have comprised the whole Roman people; for citizenship depended on membership of a *gens* (*gentilitas*) and every member of a *gens* was *ipso facto* attached to a *curia*. They therefore included plebeians as well as patricians (*q.v.*) from the date at which plebeians were recognized as free members of the body politic. But, just as enjoyment of the full rights of *gentilitas* was only very gradually granted to plebeians, so it is probable that a plebeian did not, when admitted through a *gens* into a *curia*, immediately exercise all the rights of a *curialis*. It is unlikely, for instance, that plebeians voted in the *Comitia Curiata* at the early date implied by the authorities; but it is probable that they acquired the right early in the republican period, and certain that they enjoyed it in Cicero's time. A plebeian was for the first time elected *curio maximus* in 209 B.C. The *curia* ceased to have any importance as a political organization some time before the close of the republican period. But its religious importance survived during the principate; for the two festivals of the Fornacalia and the Fordicidia were celebrated by the *Curiales* (Ovid, *Fasti*, ii. 527, iv. 635).

The term *curia* seems often to have been applied to the common shrine of the *curiales*, and thus to other places of assembly. Hence the ancient senate house at Rome was known as the Curia Hostilia. The *curia* was also adopted as a state division in a large number of municipal towns; and the term was often applied to the senate in municipal towns (see *DECURIO*), probably from the name of the old senate house at Rome.

AUTHORITIES.—Mommsen, *Römisches Staatsrecht*, iii. p. 89 ff. (Leipzig, 1887); *Römische Forschungen* i. p. 140 ff. (Berlin, 1864, &c.); Clason, "Die Zusammensetzung der Curien und ihrer Comitien" (*Kritische Erörterungen* i., Rostock, 1871); Karlowa, *Römische Rechtsgeschichte*, i. p. 382 ff. (Leipzig, 1885); E. Hofmann, *Patrische und plebeische Curien* (Wien, 1879); for the *Fornacalia*, &c., Marquardt, *Staatsverwaltung*, iii. p. 197 (Leipzig, 1885); for local names of *curiae*, Pauly-Wissowa, *Realencyclopädie*, iv. p. 1822 (new edition, 1893, &c.); O. Gilbert, *Geschichte und Topographie der Stadt Rom* (Leipzig, 1883); for municipal *curiae*, Mommsen, in *Ephemeris epigraphica*, ii. p. 125; Schmidt, in *Rheinisches Museum*, xlv. (1890) p. 599 ff. On the Roman comitia in general see also G. W. Botsford, *Roman Assemblies* (1909). (A. M. CL.)

In medieval Latin the word *curia* was used in the general sense of "court." It was thus used of "the court," meaning the royal household (*aula*); of "courts" in the sense of solemn assemblies of the great nobles summoned by the king (*curiae solennes*, &c.); of courts of law generally, whether developed out of the imperial or royal *curia* (see *CURIA REGIS*) or not (*e.g. curia baronis*, Court Baron, *curia christianitalis*, Court Christian). Sometimes *curia* means jurisdiction, or the territory over which jurisdiction is exercised; whence possibly its use, instead of *cortis*, for an enclosed space, the court-yard of a house, or for the house itself (cf. the English "court," *e.g.* Hampton Court, and the Ger. *Hof*). The word *Curia* is now only used of the court of Rome, as a convenient term to express the sum of the organs that make up the papal government (see *CURIA ROMANA*).

See Du Cange, *Gloss. med. et inf. Lat.* (1883), s.v. "Curia."

**CURIA REGIS**, or **AULA REGIS**, a term used in England from the time of the Norman Conquest to about the end of the 13th century to describe a council and a court of justice, the composition and functions of which varied considerably from time to time. Meaning in general the "king's court," it is difficult to define the *curia regis* with precision, but it is important and interesting because it is the germ from which the higher courts of law, the privy council and the cabinet, have sprung. It was, at first the general council of the king, or the *commune concilium*, *i.e.* the feudal assembly of the tenants-in-chief; but it assumed a more definite character during the reign of Henry I., when its members, fewer in number, were the officials of the royal household and other friends and attendants of the king. It was thus

practically a committee of the larger council, and assisted the king in his judicial work, its authority being as undefined as his own. About the same time the *curia* undertook financial duties, and in this way was the parent of the court of exchequer (*curia regis ad scaccarium*). The members were called "justices," and in the king's absence the chief justiciar presided over the court. A further step was taken by Henry II. In 1178 he appointed five members of the *curia* to form a special court of justice, and these justices, unlike the other members of the *curia*, were not to follow the king's court from place to place, but were to remain in one place. Thus the court of king's bench (*curia regis de banco*) was founded, and the foundation of the court of common pleas was provided for in one of the articles of Magna Carta. The court of chancery is also an offshoot of the *curia regis*. About the time of Edward I. the executive and advising duties of the *curia regis* were discharged by the king's secret council, the later privy council, which is thus connected with the *curia regis*, and from the privy council has sprung the cabinet.

In his work *Tractatus de legibus Angliae*, Ranulf de Glanvill treats of the procedure of the *curia regis* as a court of law. See W. Stubbs, *Constitutional History*, vol. i. (Oxford, 1883); R. Gneist, *Englische Verfassungsgeschichte*, English translation by P. A. Ashworth (London, 1891); A. V. Dicey, *The Privy Council* (London, 1887); and the article *PRIVY COUNCIL*. (A. W. H.\*)

**CURIA ROMANA**, the name given to the whole body of administrative and judicial institutions, by means of which the pope carries on the general government of the Church; the name is also applied by an extension of meaning to the persons who form part of it, and sometimes to the Holy See itself. Rome is almost the only place where the word *curia* has preserved its ancient form; elsewhere it has been almost always replaced by the word court (*cour*, *corte*), which is etymologically the same. Even at Rome, however, the expression "papal court" (*corte romana*) has acquired by usage a sense different from that of the word *curia*; as in the case of royal courts it denotes the whole body of dignitaries and officials who surround and attend on the pope; the pope, however, has two establishments: the civil establishment, in which he is surrounded by what is termed his "family" (*familia*); and the religious establishment, the members of which form his "chapel" (*capella*). The word *curia* is more particularly reserved to the tribunals and departments which actually deal with the general business of the Church.

I. In order to understand the organization of the various constituent parts of the Roman Curia, we must remember that the modern principle of the separation of powers is unknown to the Church; the functions of each department are limited solely by the extent of the powers delegated to it and the nature of the business entrusted to it; but each of them may have a share at the same time in the legislative, judicial and administrative power. Similarly, the necessity for referring matters to the pope in person, for his approval or ratification of the decisions arrived at, varies according to the department and the nature of the business. But on the whole, all sections of the Curia hold their powers direct from the pope, and exercise them in his name. Each of them, then, has supreme authority within its own sphere, while the official responsibility belongs to the pope, just as in all governments it is the government that is responsible for the acts of its departments. Of these official acts, however, it is possible to distinguish two categories: those emanating directly from the heads of departments are generally called Acts of the Holy See (and in this sense the Holy See is equivalent to the Curia); those which emanate direct from the pope are called Pontifical Acts. The latter are actually the Apostolic Letters, *i.e.* those documents in which the pope speaks in his own name (bulls, briefs, encyclicals, &c.) even when he does not sign them, as we shall see. The Apostolic Letters alone may be *ex cathedra* documents, and may have the privilege of infallibility, if the matter admit of it. There are also certain differences between the two sorts of documents with regard to their penal consequences. But in all cases the disciplinary authority is evidently the same; we need only note that acts concerning individuals

General  
remarks.

do not claim the force of general law; the legal decisions serve at most to settle matters of jurisprudence, like the judgments of all sovereign courts.

The constituent parts of the Roman Curia fall essentially into two classes: (1) the tribunals and offices, which for centuries served for the transaction of business and which continue their activity; (2) the permanent commissions of cardinals, known by the name of the Roman Congregations. These, though more recent, have taken precedence of the former, the work of which they have, moreover, greatly relieved; they are indeed composed of the highest dignitaries of the church, the cardinals (*q.v.*), and are, as it were, subdivisions of the consistory (*q.v.*), a council in which the whole of the Sacred College takes part.

II. *The Roman Congregations.*—The constitution of all of these is the same; a council varying in numbers, the members of which are cardinals, who alone take part in the deliberations. One of the cardinals acts as president, or prefect, as he is called; the congregation is assisted by a secretary and a certain number of inferior officials, for secretarial and office work. They have also consultors, whose duty it is to study the subjects for consideration. Their deliberations are secret and are based on prepared documents bearing on the case, written, or more often printed, which are distributed to all the cardinals about ten days in advance. The deliberations follow a simplified procedure, which is founded more on equity than on the more strictly legal forms, and decisions are given in the shortest possible form, in answer to carefully formulated questions or *dubia*. The cardinal prefect, aided by the secretariate, deals with the ordinary business, only important matters being submitted for the consideration of the general meeting. To have the force of law the acts of the congregations must be signed by the cardinal prefect and secretary, and sealed with his seal. Practically the only exception is in the cases of the Holy Office, and of the Consistorial Congregation of which the pope himself is prefect; the acts of the first are signed by the "notary," and the acts of the second by the assessor.

We may pass over those temporary congregations of cardinals known also as "special," the authority and existence of which extend only to the consideration of one particular question; and also those which had as their object various aspects of the temporal administration of the papal states, which have ceased to exist since 1870. We deal here only with the permanent ecclesiastical congregations, the real machinery of the papal administration. Some of them go quite far back into the 16th century; but it was Sixtus V. who was their great organizer; by his bull *Immensa* of the 22nd of January 1587, he apportioned all the business of the Church (including that of the papal states) among fifteen Congregations of cardinals, some of which were already in existence, but most of which were established by him; and these commissions, or those of them at least which are concerned with spiritual matters, are still working. A few others have been added by his successors. Pius X., by the constitution *Sapienti Consilio* of the 29th of June 1908, proceeded to a general reorganization of the Roman Curia: Congregations, tribunals and offices. In this constitution he declared that the competency of these various organs was not always clear, and that their functions were badly arranged; that certain of them had only a small amount of business to deal with, while others were overworked; that strictly judicial affairs, with which the Congregations had not to deal originally, had developed to an excessive extent, while the tribunals, the Rota and the Signatura, had nothing to do. He consequently withdrew all judicial affairs from the Congregations, and handed them over to the two tribunals, now revived, of the Rota and the papal Signatura; all affairs concerning the discipline of the sacraments were entrusted to a new Congregation of that name; the competency of the remaining Congregations was modified, according to the nature of the affairs with which they deal, and certain of them were amalgamated with others; general rules were laid down for the expedition of business and regarding *personnel*; in

short, the work of Sixtus V. was repeated and adapted to later conditions. We will now give the nomenclature of the Roman Congregations, as they were until 1908, and mentioning the modifications made by Pius X.

(1) The Holy Inquisition, Roman and universal, or Holy Office (*Sacra Congregatio Romanae et universalis Inquisitionis seu Sancti Officii*), the first of the Congregations, hence called the supreme. It is composed of twelve cardinals, assisted by a certain number of officials: the assessor, who practically fulfils the functions of the secretary, the commissary general, some consultors and the qualificators, whose duty it is to determine the degree of theological condemnation deserved by erroneous doctrinal propositions (*haeretica, erronea, temeraria*, &c.). The presidency is reserved to the pope, and the cardinal of longest standing takes the title of secretary. This Congregation, established in 1542 by Paul III., constitutes the tribunal of the Inquisition (*q.v.*), of which the origins are much older, since it was instituted in the 13th century against the Albigenses. It deals with all questions of doctrine and with the repression of heresy, together with those crimes which are more or less of the character of heresy. Its procedure is subject to the strictest secrecy. Pius X. attached to it all matters concerning indulgences; on the other hand, he transferred to the Congregation of the Council matters concerning the precepts of the Church such as fasting, abstinence and festivals. The choosing of bishops, which had in recent times been entrusted to the Holy Office, was given to the Consistorial Congregation, and dispensations from religious vows to the Congregation of the Religious Orders. The Holy Office continues, however, to deal with mixed marriages and marriages with infidels.

(2) The Consistorial Congregation (*Sacra Congregatio Consistorialis*), established by Sixtus V., has as its object the preparation of business to be dealt with and decided in secret consistory (*q.v.*); notably promotions to cathedral churches and consistorial benefices, the erection of dioceses, &c. To this congregation is also subject the administration of the common property of the college of cardinals. Pius X. restored this Congregation to a position of great importance; in the first place he gave it the effective control of all matters concerning the erection of dioceses and chapters and the appointment of bishops, except in the case of countries subject to the Propaganda, and save that for countries outside Italy it has to act upon information furnished by the papal secretary of state. He further entrusted to this Congregation everything relating to the supervision of bishops and of the condition of the dioceses, and business connected with the seminaries. It has also the duty of deciding disputes as to the competency of the other Congregations. The pope continues to be its prefect, and the cardinal secretary of the Holy Office and the secretary of state are *ex officio* members of it; the cardinal who occupies the highest rank in it, with the title of secretary, is chosen by the pope; he is assisted by a prelate with the title of assessor, who is *ex officio* secretary of the Sacred College. The assessor of the Holy Office and the secretary for extraordinary ecclesiastical affairs are *ex officio* consultors.

(3) The Pontifical Commission for the reunion of the dissident Churches, established by Leo XIII. in 1895 after his constitution *Orientalium*. The pope reserved the presidency for himself; its activity is merely nominal. It was attached by Pius X. to the Congregation of the Propaganda.

(4) The Congregation of the Apostolic Visitation (*Sacra Congregatio Visitationis apostolicae*). The Visitation is the personal inspection of institutions, churches, religious establishments and their *personnel*, to correct abuses and enforce the observation of rules. Through this Congregation the pope, as bishop of Rome, made the inspection of his diocese; it is for this reason that he was president of this commission, the most important member of which was the cardinal vicar. He takes the place of the pope in the administration of the diocese of Rome; he has his own offices and diocesan assistants as in other bishoprics. The Congregation of the Visitation was suppressed by Pius X. as a separate Congregation,



and was reduced to a mere commission which is attached, as before, to the Vicariate.

(5) The Congregation on the discipline of the sacraments (*Sacra Congregatio de Disciplina Sacramentorum*), established by Pius X., thus comes to occupy the third rank. With the reservation of those questions, especially of a dogmatic character, which belong to the Holy Office, and of purely ritual questions, which come under the Congregation of Rites, this Congregation brings under one authority all disciplinary questions concerning the sacraments, which were formerly distributed among several Congregations and offices. It deals with dispensations for marriages, ordinations, &c., concessions with regard to the mass, the communion, &c.

(6) The Congregation of the Bishops and Regulars, of which the full official title was, Congregation for the Affairs and Consultations of the Bishops and Regulars (*Sacra Congregatio super negotiis Episcoporum et Regularium*; now *Sacra Congregatio negotiis religiosorum sodalium praeposita*).

It is the result of the fusion of two previous commissions; that for the affairs of bishops, established by Gregory XIII., and that for the affairs of the regular clergy, founded by Sixtus V.; the fusion dates from Clement VIII. (1601). This congregation was very much occupied, being empowered to deal with all disciplinary matters concerning both the secular and regular clergy, whether in the form of consultations or of contentious suits; it had further the exclusive right to regulate the discipline of the religious orders and congregations bound by the simple vows, the statutes of which it examined, corrected and approved; finally it judged disputes and controversies between the secular and regular clergy. On the 26th of May 1906, Pius X. incorporated in this Congregation two others having a similar object: that on the discipline of the regular clergy (*Congregatio super Disciplina Regularium*), founded by Innocent XII. in 1695, and that on the condition of the regular clergy (*Congregatio super Statu Regularium*), established by Pius IX. in 1846. In 1908 Pius X. withdrew from this Congregation all disciplinary matters affecting the secular clergy, and limited its competency to matters concerning the religious orders, both as regards their internal affairs and their relations with the bishops.

(7) The Congregation of the Council (*Sacra Congregatio Cardinalium Concilii Tridentini interpretum*), i.e. a number of cardinals whose duty it is to interpret the disciplinary decrees of the council of Trent, was instituted by Pius IV. in 1563, and reorganized by Sixtus V.; its mission is to promote the observation of these disciplinary decrees, to give authoritative interpretations of them, and to reconcile disputes arising out of them. Pius X. in 1908 entrusted to this Congregation the supervision of the general discipline of the secular clergy and the faithful laity, empowering it to deal with matters concerning the precepts of the Church, festivals, foundations, church property, benefices, provincial councils and episcopal assemblies. Proceedings for annulling marriages, which used to be reserved to it, were transferred to the tribunal of the Rota; reports on the condition of the dioceses were henceforth to be addressed to the Consistorial Congregation, which involved the suppression of the commission which had hitherto dealt with them. The other commission, formerly charged with the revision of the decrees of provincial councils, was merged in the Congregation itself. The Congregation of Immunity (*Sacra Congregatio Jurisdictionis et Immunitatis ecclesiasticae*) was created by Urban VIII. (1626) to watch over the immunities of the clergy in respect of person or property, whether local or general. This, having no longer any object, was also attached to the Congregation of the Council, and is now amalgamated with it.

(8) The Congregation of the Propaganda (*Sacra Congregatio de Propaganda Fide*) was established by Gregory XV. in 1622, and added to by Urban VIII., who founded the celebrated College of the Propaganda for the education of missionaries, and his polyglot press for printing the liturgical books of the East. It had charge of the administration of the Catholic churches in all non-Catholic countries, for which it discharged the functions of all the Congregations, except

in doctrinal and strictly legislative matters. Its sphere was very wide; it administered all non-European countries, except Latin America and the old colonies of the Catholic countries of Europe; in Europe it had also charge of the United Kingdom and the Balkan States. But the constitution "*Sapienti*" of 1908 withdrew from the Propaganda and put under the common law of the Church most of those parts in which the episcopal hierarchy had been re-established, i.e. in Europe, the United Kingdom, Holland and Luxemburg; in America, Canada, Newfoundland and the United States. Further, even for those countries which it continues to administer, the Propaganda has to submit to the various Congregations all questions affecting the Faith, marriage and rites. The missions begin by establishing apostolic prefectures under the charge of priests; the prefecture is later transformed into an apostolic vicariate, having at its head a bishop; finally, the hierarchy, i.e. the diocesan episcopate, is established in the country, with residential sees. Thus the hierarchy was re-established in England in 1850 by Pius IX., in 1878 by Leo XIII. in Scotland, in 1886 in India, in 1891 in Japan. It is also the work of the Propaganda to appoint the bishops for the countries it administers. Under the same cardinal prefect is found that section of the Propaganda which deals with matters concerning oriental rites (*Congregatio specialis pro negotiis ritus Orientalis*), the object of which is indicated by its name. To the former were attached two commissions, one for the approbation of those religious congregations which devote themselves to missions, which is now transferred to the Congregation of the Religious Orders; the other for the examination of the reports sent in by the bishops and vicars apostolic on their dioceses or missions. With the latter is connected the commission for the examination of the liturgical books of the East (*Commissio pro corrigendis libris ecclesiae Orientalis*). Finally, the popes have devoted to the missions the income arising from the Chamber of Spoils (*Camera Spoliorum*), i.e. that portion of the revenue from church property which cannot be bequeathed by the holders of benefices as their own property; this source of income, however, has decreased greatly.

(9) The Congregation of the Index (*Congregatio indicis librorum prohibitorum*), founded by St Pius V. in 1571 and reorganized by Sixtus V., has as its object the examination and the condemnation or interdiction of bad or dangerous books which are submitted to it, or, since the constitution "*Sapienti*," of those which it thinks fit to examine on its own initiative (see INDEX).

(10) The Congregation of Rites (*Congregatio sacrarum Rituum*), founded by Sixtus V., has exclusive charge of the liturgy and liturgical books; it also deals with the proceedings in the beatification and canonization of saints. Of late years there have been added to it a Liturgical Commission, a Historico-liturgical Commission, and a Commission for church song, the functions of which are sufficiently indicated by their names.

(11) The Ceremonial Congregation (*Sacra Congregatio caeremonialis*), the prefect of which is the cardinal dean, was instituted by Sixtus V.; its mission is to settle questions of precedence and etiquette, especially at the papal court; it is nowadays but little occupied.

(12) The Congregation of Indulgences and Relics (*Sacra Congregatio Indulgentiarum et Sacrarum Reliquiarum*), founded in 1669 by Clement IX., devoted itself to eradicating any abuses which might creep into the practice of indulgences and the cult of relics. It had also the duty of considering applications for the concession of indulgences and of interpreting the rules with regard to them. In 1904 Pius X. attached this Congregation to that of Rites, making the personnel of both the same, without suppressing it. In 1908, however, it was suppressed, as stated above, and its functions as to indulgences were transferred to the Holy Office, and those as to relics to the Congregation of Rites.

(13) The Congregation of the Fabric of St Peter's (*Sacra Congregatio reverendae Fabricae S. Petri*) is charged with the upkeep, repairs and temporal administration of the great basilica;

in this capacity it controls the famous manufacture of the Vatican mosaics. It also formerly enjoyed certain spiritual powers for the reduction of the obligations imposed by pious legacies and foundations, the objects of which, for want of funds or any other reason, could not be fully carried out, and for the condonation of past omission of such obligations, e.g. of priests to celebrate the foundation masses of their benefices. In 1908 these powers were taken away from it by Pius X., and transferred to the Congregation of the Council, which already exercised some of them.

(14) The Congregation of Loretto (*Congregatio Lauretana*) discharged the same functions for the sanctuary of that name; its temporal administration was latterly very much reduced, and in 1908 it was united by Pius X. with the Congregation of the Council.

(15) The Congregation for extraordinary ecclesiastical affairs (*Sacra Congregatio super negotiis ecclesiasticis extraordinariis*), established by Pius VI. at the end of the 18th century to study the difficult questions relative to France, was afterwards definitively continued by Pius VII.; and there has been no lack of fresh extraordinary matters. It also dealt with the administration of the churches of Latin America, not to mention certain European countries, such as Russia, under the same conditions as the Propaganda in countries under missions. Since the constitution *Sapientis*, its competency has been confined to the examination, at the request of the secretary of state, of questions which are submitted to it, and especially those arising from civil laws and concordats.

(16) The Congregation of Studies (*Congregatio pro Universitate studii Romani, Congregazione degli Studi*), founded by Sixtus V. to act as a higher council for the Roman university of La Sapienza, had ceased to have any functions when in 1824 it was re-established by Leo XII. to supervise education in Rome and the Papal States; since 1870 it has been exclusively concerned with the Catholic universities, so far as the sacred sciences are concerned. With this should be connected the commission for historical studies, instituted in 1883 by Leo XIII., at the same time as he threw the Vatican archives freely open to scholars.

III. *The Tribunals and Offices.*—Though it has been relieved of the functions allotted to the Congregations of cardinals, the old machinery of the ecclesiastical administration has not been abolished; and the process of centralization which has been accentuated in the course of the last few centuries, together with the facility of communication, ensured for them a fresh activity, new offices having even been added. The chief thing to be observed is that the prelates who were formerly at the head of these departments have almost all been replaced by cardinals. The following is the list of the tribunals and offices, including the changes introduced by the reorganization of the Curia by Pius X. in 1908. The tribunals are three in number: one for the *forum internum*, the Penitentiary; the other two for judicial matters *in foro externo*, the Rota and the papal Signatura.

(1) The Penitentiary (*Sacra poenitentiaria Apostolica*) is the tribunal having exclusive jurisdiction in matters of conscience (*in foro interno*), e.g. dispensations from secret impediments and private vows, the absolution of reserved cases. These concessions are applied for anonymously.

It also had, previously to the constitution *Sapientis*, a certain jurisdiction *in foro externo*, such as over matrimonial dispensations for poor people. Its concessions are absolutely gratuitous. Since the 12th century, the papal court had already had officials known as penitentiaries (*poenitentarii*) for matters of conscience; the organization of the Penitentiary, after several modifications, was renewed by Benedict XIV. in 1748. At the head of it is the cardinal grand penitentiary (*major poenitentiarius*), assisted by the *regens* (It. *regente*) and various other functionaries and officials.

(2) The court of the Rota (*Sacra Rota Romana*) used to be the supreme ecclesiastical tribunal for civil affairs, and its decisions had great authority. This tribunal goes back at least

as far as the 14th century, but its activity had been reduced as a result of the more expeditious and summary, and less costly, procedure of the Congregations. The constitution *Sapientis* restored the Rota to existence and activity:

it is now once more the ecclesiastical court of appeal for both civil and criminal cases. Pius X. also made special regulations for it, by which its ancient usages are adapted to modern circumstances. The tribunal of the Rota consists of ten judges called auditors (*uditori*), of whom the most senior is president with the title of dean. Each judge has an auxiliary; to the tribunal are attached a *promotor fiscalis*, charged with the duty of securing the due application of the law, and an official charged with the defence of marriage and ordination; there is also a clerical staff (notaries, scribes) attached to the court. Cases are judged by three auditors, who succeed each other periodically (*per turnum*) according to the order in which the cases are entered, and in exceptional cases by all the auditors (*videntibus omnibus*). Under the jurisdiction of the Rota, in addition to cases of first instance submitted to it by the pope, are such judgments of episcopal courts as are strictly speaking subject to appeal; for petitions against non-judicial decisions are referred to the Congregations. Appeal is sometimes allowed from one "turn" to another; if the second sentence of the Rota confirms the first, it is definitive; if not, a third may be obtained.

(3) The supreme tribunal of the papal Signatura (*Signatura Apostolica*). There were formerly two sections: the Signatura Justitiae and the Signatura Gratiae; by the constitution *Sapientis* they were suppressed and amalgamated into one body, the Signatura Apostolica, which is the exact equivalent of other modern courts of cassation. This tribunal is composed of six cardinals, one of whom is the prefect, assisted by a prelate secretary, consultors and the necessary inferior officials. It judges cases in which auditors of the Rota are concerned, such as personal objections, but especially objections (*querelae*) lodged against sentences of the Rota, with a view to their being annulled or revised (*restitutio in integrum*).

Next come the offices, now reduced to six in number.

(1) The Chancery (*Cancellaria Apostolica*), the department from which are sent out the papal letters, has for a long time drawn up only those letters written in solemn form known as bulls. The bull, so called from the leaden seal (*bulia*), is written on thick parchment; the special writing known as Lombard, which used to be used for bulls, was abolished by Leo XIII., and the leaden seal reserved for the more important letters; on the others it has been replaced by a red ink stamp bearing both the emblems represented on the leaden seal: the two heads, face to face, of St Peter and St Paul, and the name of the reigning pope. Bulls are written in the name of the pope, who styles himself "*(Pius) Episcopus servus servorum Dei*"; (Pius); bishop, servant of the servants of God." They were formerly dated by kalends and from the era of the Incarnation, which begins on the 25th of March, but in 1908 Pius X. ordered them to be dated according to the common era. It is practically only bulls of canonization which are signed by the pope and all the cardinals present in Rome; the signature of the pope is then "*(Pius) Episcopus Ecclesiae catholicae*," while his ordinary signature bears only his name and number, "Pius PP. X." Ordinary bulls are signed by several officials of the chancery, and a certain number only by the cardinal at its head, who until 1908 was styled vice-chancellor, because the chancellor used formerly to be a prelate, not a cardinal; but since the constitution *Sapientis* has been entitled chancellor. He is assisted by several officials, beginning with the *regens* of the chancery. To the chancery were attached the *abbreviatores de parco majori vel minori* (see ABBREVIATORS), formerly charged with the drawing up or "extension" of bulls; they were suppressed by Pius X., and their functions transferred to the *Protonotarii apostolici participantes* (i.e. active). Further, Pope Pius confined the functions of the chancery to the sending out of bulls under the leaden seal (*sub plumbo*), for the erection of dioceses, the provision of bishoprics and

consistorial benefices, and other affairs of importance, these bulls being sent out by order of the Consistorial Congregation.

(2) The Apostolic Dataria is the department dealing with matters of grace, e.g. the concession of privileges, nominations to benefices and dispensations *in foro externo*, especially matrimonial ones; but its functions have been greatly reduced by the reforms of Pius X.; the matrimonial section has been suppressed, dispensations for marriages now belonging to the Congregation for the discipline of the sacraments; the section dealing with benefices, which is the only one preserved, deals with non-consistorial benefices reserved to the Holy See; it examines the claims of the candidates, draws up and sends out the letters of collation, gives dispensations, when necessary, in matters concerning the benefices, and manages the charges (i.e. pensions to incumbents who have resigned, &c.) imposed on the benefices by the pope. It has at its head a cardinal formerly called the *pro-datarius*, the *datarius* having formerly been a prelate; and now *datarius*, since the reform by Pius X. The cardinal is assisted by a prelate called the *sub-datarius*, and other officials.

(3) The Apostolic Chamber (*Reverenda Camera Apostolica*) was before the abolition of the temporal power of the papacy the ministry of finance, at once treasury and exchequer, of the popes as heads of the Catholic Church as well as sovereigns of the papal states. Although it is necessarily diminished in importance, it has retained the administration of the property of the Holy See, especially during a vacancy. At its head is the cardinal camerlengo (*Sacrae Romanae Ecclesiae Cardinalis Camerarius*), who, as we know, exercises the external authority during the vacancy of the Holy See.

(4) Next come the palatine secretariates, the first and principal of which is the secretariate of state (*Secretaria status*). The cardinal secretary of state is as it were the pope's prime minister, gathering into one centre the internal administration and foreign affairs, by means of the nunciatures and delegations depending on his department. The secretary of state is the successor of what was called in the 17th century the cardinal nephew; his functions and importance have increased more and more. The secretariate of state is the department dealing with the political affairs of the Church. To it belongs the internal administration of the apostolic palaces, with the library, archives, museums, &c. In 1908 Pius X. divided the departments of the secretariate of state into three sections, under the authority of the cardinal secretary. The first is the department of extraordinary ecclesiastical affairs, having at its head the secretary of the Congregation of the same name; the second, that of ordinary affairs, directed by a substitute, is the department dealing, among other things, with the concession of honorary distinctions, both for ecclesiastics and laymen; the third is that of the briefs, which hitherto

formed a separate secretariate. It is this department which sends out, at the command of the secretary of state or the various Congregations those papal letters which are written in less solemn form, *brevi manu*, hence the word "brief." They are written in the pope's name, but he only takes the less solemn style of: "Pius PP. X." The brief is written on thin parchment, and dated by the ordinary era and the day of the month; they were formerly signed only by the cardinal secretary of briefs or his substitute, but now by the cardinal secretary of state or the head of the office, called the chancellor of Briefs (*cancellarius Brevium*). The seal is that of the fisherman's ring, hence the formula of conclusion, "*Datum Romae, sub annulo Piscatoris.*" The "fisherman's ring" is a red ink stamp representing St Peter on a boat casting out his nets, with the name of the reigning pope.

The reform of Pius X. maintained untouched the two offices called the secretariate of briefs to princes, and the secretariate of Latin Letters, the names of which are sufficient indication of their functions. The secretariate of memorials (*Secretaria Memorialium*), through which pass requests addressed to the pope for the purpose of obtaining certain favours, was formerly of great importance; it is now suppressed and the

requests are addressed to the proper departments. Finally, the pope has his special secretary, his *auditor*, with his offices, as well as the papal almonry, the officials of which administer the papal charities.

IV. The pontifical "family" (*familia*) forms the pope's civil court. First come the palatine cardinals, i.e. those who, on account of their office, have the right of living in the papal palaces. These were formerly four in number: the *pro-datarius* (now *datarius*), the secretary of state, the secretary of briefs, and the secretary of the memorials; the two last of these were suppressed in 1908. Next come the four palatine prelates, the majordomo, the superintendent of the household and its staff, and successor of the ancient *vicedominus*; the master of the chamber, who presides over the arrangement of audiences; the *auditor*, or private secretary; and finally the master of the sacred palace (*magister sacri palatii*), a kind of theological adviser, always a Dominican, whose special duty is nowadays the revision of books published at Rome. Other prelates rank with the above, but in a lower degree, notably the almoner and the various secretaries. All ecclesiastics admitted, by virtue of their office or by a gracious concession of the pope, to form part of the "family," are called domestic prelates, prelates of the household; this is an honorary title conferred on many priests not resident in Rome. The external service of the palace is performed by the Swiss Guard and the *gendarmerie*; the service of the ante-chamber by the lay and ecclesiastical chamberlains; this service has also given rise to certain honorary titles both for ecclesiastics, e.g. honorary chamberlain, and for laymen, e.g. secret chamberlain (*cameriere segreto*). (See CHAMBERLAIN.)

V. The pontifical "chapel" (*capella*) is the papal court for purposes of religious worship. In it the pope is surrounded by the cardinals according to their order; by the patriarchs, archbishops and bishops attending at the throne; and others; by the prelates of the Curia; and by all the clergy both secular and regular. Among the prelates we should mention the protonotaries, the successors of the old notaries or officials of the papal chancery in the earliest centuries; the seven *protonotarii participantes* were restored by Pope Pius X. to the chancery, as noted above, but they have kept important honorary privileges; this is yet another source of distinctions conferred upon a great number of priests outside of Rome, the protonotaries of different classes. In a lower degree there are also the chaplains of honour. Since 1870 the great pontifical ceremonies have lost much of their splendour.

BIBLIOGRAPHY.—*La Gerarchia cattolica*, an annual directory published at Rome; Lunadoro, *Relazione della corte di Roma* (Rome, 1765); Moroni, *Dizionario di erudizione*, under the various headings; Card. De Luca, *Relatio curiae romanae* (Cologne, 1683); Bouix, *De curia romana* (Paris, 1859); Ferraris, *Prompta bibliotheca* (addit. *Cassinenses*), s.v. *Congregatio*; Grimaldi, *Les Congrégations romaines* (Sienna, 1891); *Dictionnaire de théologie catholique*, s.v. *Curie romaine* (Paris, 1907); Publications of the acts of the Roman Congregations; Bishops and regulars—Bizzarri, *Collectanea in usum Secretariae* (Rome, 1866, 1885). Council: the *Thesaurus resolutionum* has published all business since 1700; a volume is issued every year, and the contents have been published in alphabetical order by Zamboni (4 vols., Rome, 1812; Arras, 1860) and by Pallottini (18 vols., Rome, 1868, &c.). Immunity: Ricci, *Synopsis, decreta et resolutiones* (Palestrina, 1708). Propaganda: De Martinis, *Juris pontificii de Propaganda Fide*, &c. (Rome, 1888, &c.); *Collectanea S. C. de Prop. Fide* (2nd ed., Rome, 1907). Index: *Index librorum prohibitorum* (Rome, 1900). Rites: *Decreta authentica* (Rome, 1898). Indulgences: *Decreta authentica* (Regensburg, 1882); *Rescripta authentica* (ib., 1885). (A. Bo.)\*

CURICÓ, a province of central Chile, lying between the provinces of Colchagua and Talca and extending from the Pacific to the Argentine frontier; area, 2978 sq. m.; pop. (1895) 103,242. The eastern and western sections are mountainous, and are separated by the fertile valley of central Chile. The mineral resources are undeveloped, but are said to include copper, gold and silver. Cattle, wheat and wine are the principal products, but Indian corn and fruit also are produced. On the coast are important salt-producing industries. The climate is mild and the rainfall more abundant than at the northern part of the valley, and the effects of this are to be seen in the better

**Dataria**  
**Apos-**  
**tolica.**

**Apostolic**  
**chamber.**

**Secretary-**  
**ship of**  
**State.**

**Briefs.**

**Other**  
**offices.**

*The*  
*pontifical*  
*"family."*

*Pontifical*  
*chapel.*

pasturage. Irrigation is used to a large extent. The province was created in 1865 by a division of Colchagua. The capital is Curicó, on the Mataquito river, in lat. 34° 58' S. long. 71° 19' W., 114 m. S. of Santiago by the Chilean Central railway, which crosses the province. The city stands on the great central plain, 748 ft. above sea-level, and in the midst of a comparatively well-cultivated district. It was founded in 1742 by José de Manso, and is one of the more cultured and progressive provincial towns of Chile. Pop. (1895) 12,669. Vichiquen, on a tide-water lake on the coast, is a prosperous town, the centre of the salt trade.

**CURIE, PIERRE** (1859–1906), French physicist, was born in Paris on the 15th of May 1859, and was educated at the Sorbonne, where he subsequently became professor of physics. Although he had previously published meritorious researches on piezoelectricity, the magnetic properties of bodies at different temperatures, and other topics, he was chiefly known for his work on radium carried out jointly with his wife, Marie Sklodowska, who was born at Warsaw on the 7th of November 1867. After the discovery of the radioactive properties of uranium by Henri Becquerel in 1896, it was noticed that some minerals of uranium, such as pitchblende, were more active than the element itself, and this circumstance suggested that such minerals contained small quantities of some unknown substance or substances possessing radioactive properties in a very high degree. Acting on this surmise M. and Mme Curie subjected a large amount of pitchblende to a laborious process of fractionation, with the result that in 1898 they announced the existence in it of two highly radioactive substances, polonium and radium. In subsequent years they did much to elucidate the remarkable properties of these two substances, one of which, polonium, came to be regarded as one of the transformation-products of the other (see RADIOACTIVITY). In 1903 they were awarded the Davy medal of the Royal Society in recognition of this work, and in the same year the Nobel prize for physics was divided between them and Henri Becquerel. Professor Curie, who was elected to the Academy of Sciences in 1905, was run over by a dray and killed instantly in Paris on the 19th of April 1906.

His elder brother, **PAUL JACQUES CURIE**, born at Paris on the 29th of October 1856, published an elaborate memoir on the specific inductive capacities of crystalline bodies (*Ann. Chim. Phys.* 1889, 17 and 18).

**CURIO, GAIUS SCRIBONIUS**, Roman statesman and orator, son of a distinguished orator of the same name, flourished during the 1st century B.C. He was tribune of the people in 90 B.C., and afterwards served in Sulla's army in Greece against Archelaus, general of Mithradates, and as his legate in Asia, where he was commissioned to restore order in the kingdoms abandoned by Mithradates. In 76 he was consul, and as governor of Macedonia carried on war successfully against the Thracians and Dardanians, and was the first Roman general who penetrated as far as the Danube. On his return he was granted the honour of a triumph. During the discussion as to the punishment of the Catilinarian conspirators he supported Cicero, but he spoke in favour of P. Clodius (*q.v.*) when the latter was being tried for the Bona Dea affair. This led to a violent attack on the part of Cicero, but it does not appear to have interfered with their friendship. Curio was a vehement opponent of Caesar, against whom he wrote a political pamphlet in the form of a dialogue. He was pontifex maximus in 57, and died in 53. His reputation as an orator was considerable, but according to Cicero he was very illiterate, and his only qualifications were brilliancy of style and the purity of his Latin. He was nicknamed Burbuleius (after an actor) from the way in which he moved his body while speaking.

Orelli, *Onomasticon* to Cicero; Florus iii. 4; Eutropius vi. 2; Val. Max. ix. 14, 5; Quintilian, *Instit.*, vi. 3, 76; Dio Cassius xxxviii. 16.

His son, **GAIUS SCRIBONIUS CURIO**, was first a supporter of Pompey, but after his tribuneship (50 B.C.) went over to Caesar, by whom he was said to have been bribed. But, while breaking off relations with Pompey, Curio desired to keep up the appearance of impartiality. When it was demanded that Caesar should lay down his imperium before entering Rome, Curio proposed

that Pompey should do the same, adding that, if the rivals refused to do so, they ought both to be declared public enemies. His proposal was carried by a large majority, but a report having spread that Caesar was on the way to attack Rome, the consuls called upon Pompey to undertake the command of all the troops stationed in Italy. Curio's appeal to the people to prevent the levying of an army by Pompey was disregarded; whereupon, feeling himself in danger, he fled to Ravenna to Caesar. He was commissioned by Caesar, who was still unwilling to proceed to extremities, to take a message to the senate. But Curio's reception was so hostile that he hurriedly returned during the night to Caesar. It was now obvious that civil war would break out. Curio collected troops in Umbria and Etruria for Caesar, who sent him to Sicily as propraetor in 49. After having fought with considerable success there against the Pompeians, Curio crossed over to Africa, where he was defeated and slain by Juba, king of Numidia. Curio, although a man of profligate character, possessed conspicuous ability, and was a distinguished orator. In spite of his faults, Cicero, as an old friend of his father, took a great interest in him and did his utmost to reform him. Seven of Cicero's letters (*Ad. Fam.* ii. 1–7) are addressed to him. There can be no doubt that Curio's behaviour in regard to the laying down of the imperium by Caesar and Pompey in great measure contributed to the outbreak of civil war. The first amphitheatre in Rome was erected by him (50), for the celebration of the funeral games in honour of his father.

Orelli, *Onomasticon* to Cicero; Livy, *Epit.* 109, 110; Caesar, *Bell. Civ.*, ii. 23, for Curio's African campaign; Appian, *Bell. Civ.*, ii. 26–44; Vell. Pat. ii. 48.

**CURITYBA** (also **CORITYBA** and **CURITIBA**), capital of the state of Paraná, Brazil, situated on an elevated plateau (2916 ft. above sea-level) 68 m. W. of its seaport Paranaguá, with which it is connected by a railway remarkable for the engineering difficulties overcome and for the beautiful scenery through which it passes. Pop. (1890) 22,694; of the municipality, 24,553. There is a large foreign element in the population, the Germans preponderating. The city has a temperate, healthy climate, and is surrounded by a charming *campo* country, which, however, is less fertile than the forested river valleys. Maté is the principal export.

**CURLEW** (Fr. *Courlis* or *Corlieu*), a name given to two birds, of whose cry it is an imitation, both belonging to the group *Limicolae*, but possessing very different habits and features.

1. The long-billed curlew, or simply curlew of most British writers, the *Numenius arquata* of ornithologists, is one of the largest of the family *Scolopacidae*, or snipes and allied forms. It is common on the shores of the United Kingdom and most parts of Europe, seeking the heaths and moors of the interior and more northern countries in the breeding-season, where it lays its four brownish-green eggs, suffused with cinnamon markings, in an artless nest on the ground. In England it has been ascertained to breed in Cornwall and in the counties of Devon, Dorset, Salop, and Derby—though sparingly. In Yorkshire it is more numerous, and thence to the extreme north of Scotland, as well as throughout Ireland, it is, under the name of whaup, familiar to those who have occasion to traverse the wild and desolate tracts that best suit its habits. So soon as the young are able to shift for themselves, both they and their parents resort to the sea-shore or mouths of rivers, from the muddy flats of which they at low tide obtain their living, and, though almost beyond any other birds wary of approach, form an object of pursuit to numerous gunners. While leading this littoral life the food of the curlew seems to consist of almost anything edible that presents itself. It industriously probes the mud or sand in quest of the worms that lurk therein, and is also active in seeking for such crustaceans and molluscs as can be picked up on the surface, while vegetable matter as well has been found in its stomach. During its summer-sojourn on the moorlands insects and berries, when they are ripe, enter largely into its diet. In bulk the curlew is not less than a crow, but it looks larger still from its long legs, wings and neck. Its bill, from 5 to 7 in. in length, and terminating in the delicate nervous apparatus

common to all birds of its family, is especially its most remarkable feature. Its plumage above is of a drab colour, streaked and mottled with very dark brown; beneath it is white, while the flight-quills are of a brownish black.

Nearly allied to the curlew, but smaller and with a more northern range, is the whimbrel (*N. phaeopus*), called in some parts jack-curlew, from its small size; May-fowl, from the month in which it usually arrives; and titterel, from one of its cries.<sup>1</sup> This so much resembles the former in habit and appearance that no further details need be given of it. In the countries bordering on the Mediterranean occurs a third species (*N. tenuirostris*). Some fifteen other species, or more, have been described, but it is probable that this number is too great. The genus *Numenius* is almost cosmopolitan. In North America three very easily recognized species are found—the first (*N. longirostris*) closely agreeing with the European curlew, but larger and with a longer bill; the second (*N. hudsonicus*) representing the British whimbrel; and the third (*N. borealis*), which has several times found its way to Britain, very much less in size—indeed the smallest of the genus. All these essentially agree with the species of the Old World in habit; but it is remarkable that the American birds can be easily distinguished by the rufous colouring of their axillary feathers—a feature which is also presented by the American godwits (*Limosa*).

2. The curlew of inlanders, or stone-curlew—called also, by some writers, from its stronghold in England, the Norfolk plover, and sometimes the thick-knee—is usually classed among the *Charadriidae*, but it offers several remarkable differences from the more normal plovers. It is the *Charadrius oediconemus* of Linnaeus, the *C. scolopax* of Sam. Gottl. Gmelin, and the *Oediconemus crepitans* of K. J. Temminck. With much the same cry as that of the *Numenius*, only uttered in a far sweeter tone, it is as fully entitled to the name of curlew as the bird most commonly so called. In England it is almost solely a summer visitor, though an example will occasionally linger throughout a mild winter; and is one of the few birds whose distribution is affected by geological formation, since it is nearly limited to the chalk-country—the open spaces of which it haunts, and its numbers have of late years been sensibly diminished by their inclosure. The most barren spots in these districts, even where but a superficial coating of light sand and a thin growth of turf scarcely hide the chalk below, supply its needs; though at night (and it chiefly feeds by night) it resorts to moister and more fertile places. Its food consists of snails, coleopterous insects, and earth-worms, but larger prey, as a mouse or a frog, is not rejected. Without making the slightest attempt at a nest, it lays its two eggs on a level spot, a bare fallow being often chosen. These are not very large, and in colour so closely resemble the sandy, flint-strewn surface that their detection except by a practised eye is difficult. The bird, too, trusts much to its own drab colouring to elude observation, and, on being disturbed, will frequently run for a considerable distance and then squat with outstretched neck so as to become almost invisible. In such a case it may be closely approached, and its large golden eye, if it do not pass for a tuft of yellow lichen, is perhaps the first thing that strikes the searcher. As autumn advances the stone-curlew gathers in large flocks, and then is as wary as its namesake. Towards October these take their departure, and their survivors return, often with wonderful constancy, to their beloved haunts. In size this species exceeds any other European plover, and looks even still larger than it is. The bill is short, blunt, and stout; the head large, broad, and flat at the top; the wings and legs long—the latter presenting the peculiarity of a singular enlargement of the upper part of the tarsus, whence the names *Oediconemus* and Thick-knee have been conferred. The toes are short and fleshy, and the hind-toe is wanting. This bird seems to have been an especial favourite with Gilbert White, in whose classical writings mention of it is often made. Its range extends to North Africa and India. Five other species of *Oediconemus* from Africa

<sup>1</sup>The name spowe (cf. Icelandic *Spói*) also seems to have been anciently given to this bird (see Stevenson's *Birds of Norfolk*, ii. 201).

have also been described as distinct. Australia possesses a very distinct species (*O. gallarius*), and the genus has two members in the Neotropical Region (*O. bistriatus* and *O. superciliosus*). An exaggerated form of *Oediconemus* is found in *Aesacus*, of which two species have been described, one (*A. recurvirostris*) from the Indian, and the other (*A. magnirostris*) from the northern parts of the Australian region. (A. N.)

**CURLING, THOMAS BLIZARD** (1811–1888), British surgeon, was born in London in 1811. Through his uncle, Sir William Blizard, he became assistant-surgeon to the London hospital in 1833, becoming full surgeon in 1849. After filling other important posts in the College of Surgeons, he was appointed president in 1873. In 1843 he won the Jacksonian prize for his investigations on tetanus; and he became famous for his skill in treating diseases of the testes and rectum, his published works on which went through many editions. He died on the 4th of March 1888.

**CURLING**, a game in which the players throw large rounded stones upon a rink or channel of ice, towards a mark called the tee. Where the game originated is not precisely known; but it has been popular in Scotland for three centuries at least. Some writers, looking to the name and technical terms of the game, trace its invention to the Netherlands; thus "curl" may have been derived from the Ger. *kurzweil*, a game; "tee" from the Teutonic *tighen*, to point out; "bonspiel," a district curling competition, from the Belgic *bonne*, a district, and *spel*, play; the further supposition that "rink" is merely a modification of the Saxon *hrink*, a strong man, seems scarcely tenable. Curling is called "kuting" in some parts of Lanarkshire and Ayrshire, and very much resembles quoiting on the ice, so that the name may have some connexion with the Dutch *coete*, a quoit; while Cornelis Kiliaan (1528–1607) in his *Teutonic Dictionary* gives the term *khuytlen* as meaning a pastime in which large globes of stone like the quoit or discus are thrown upon ice. Possibly some of the Flemish merchants who settled in Scotland towards the close of the 16th century may have brought the game to the country. Unfortunately, however, for the theory that assigns to it a far-away origin, we find no early mention of it in the literature of the continent; while Camden, when describing the Orkney Islands in 1607, tells us that one of them supplies "plenty of excellent stones for the game called curling"; and incidental references to it as a game played in Scotland are made by several authors during the first half of the same century.

If the game be not indigenous to Scotland it certainly owes its development to that country, and in the course of time it has come to be the national sport. It was played at first with very rude engines—random whin boulders fashioned by nature alone, or misshapen granite blocks, bored through to let in the thumb of the player, having been the primitive channel stones. In course of years the rough block was superseded by a symmetrical object usually made of whinstone or granite, beautifully rounded, brilliantly polished, and supplied with a convenient handle.

Although curling boasts a literature of its own and songs innumerable, yet it has received but the scantiest notice from such important Scottish writers as Scott and Burns, or from contemporary literature in general. In 1834 an "Amateur Curling Club of Scotland" was formed, but this "mutual admiration amateur society came to nothing, as might be expected." Far more businesslike were the methods of the men who set afoot the "Grand Caledonian Curling Club," which began its existence on the 15th of November 1838, and which, under its present title of "The Royal Caledonian Curling Club," is regarded in all parts of the world as the mother-club and legislative body, even in Canada, where, however, curling conditions differ widely from those of Scotland; devotion to the mother-club does not by any means imply submission. Starting with 28 allied clubs the Royal Club grew so rapidly that there were 500 such in 1880 and 720 in 1903. It was under the auspices of the Royal Caledonian that a body of Scottish curlers visited Canada and the United States in the winter of 1902–1903, and, while a slight margin of victory remained with the home players under their own climatic con-



ditions, the visit did much to bring together the lovers of the game on both sides of the Atlantic. The assumption of the title "Royal" in place of "Grand" was due to the visit of Queen Victoria and the prince consort to Scotland in 1842, on which occasion they were initiated into the mysteries of the game on the polished floor of the drawing-room in the Palace of Scone; and the prince consort, who was presented with a pair of curling-stones, consented to become patron of the club. On his death he was succeeded by the prince of Wales, who, as Edward VII., still continued his patronage. The Club's main duties are to further the interests of the game, to revise the laws and to arrange the important matches, especially the grand match, played annually between the Scottish clubs north of the Forth & Clyde Canal and those south of it. In the first of these matches (1847) only twelve "rinks" were played; in 1903 there were no fewer than 286. During this time the southern clubs were usually victorious. Curlers claim to be a united brotherhood within which peer and peasant are equal "on the ice." To the same end the laws of the club are framed with a due regard to economy, not forgetting conviviality in the matter of "beef and greens," the curler's traditional dish, washed down with whisky. A formal freemasonry exists among curlers, who must be initiated into the mysteries and instructed in the grip, password and ceremony, being liable at any moment to be examined in these essentials and fined for lapses of memory. Betting, excepting for the smallest stakes, is discountenanced.

*Glossary.*—As curling has a language which contains many curious terms, puzzling to the uninitiated, the English equivalents of some of them are here given. *Baugh ice*, rough or soft ice. *Bias*, a slope on the ice. *Boardhead* (also house or parish), the large circle round the tee. *Bonspiel*, a match between two clubs. *Break an egg on a stone*, touch it very slightly. *Broughs*, the small circles round the tee. *Chipping*, striking a stone of which a small part can be seen. *Core*, old name for rink. *Cove* or *kove*, a besom made of broom-twigs. *Draw*, to play gently. *Drive*, to play hard. *Drug ice*, soft bad ice. *Fill the port*, to block the interval between two stones. *Gogsee*, tee. *Guard*, a stone that covers and protects another. *Hack*, a hollow cut in the ice for the player's foot, used in place of a crampit. *Hands up!* stop sweeping. *Hog*, a stone that stops short of the *hog-score*, a line drawn one-sixth of the length of the rink from the tee. *Head*, an innings, both sides delivering all their stones once. *Howe*, the middle of the rink, gradually hollowed by stones. *In-ringing*, gaining a good position by rebounding off another stone. *In-wick*, the same. *Lie shot*, the stone resting nearest the tee. *Mar*, to interfere with a stone while running. *Out-Turn*, to make the stone twist to the left. *In-Turn*, to make one turn to the right. *Out-wick*, to strike a stone on the edge so as to drive it towards the tee. *Pat-lid*, a stone that lies on the tee. *Pillycock*, the oldest form of curling-stone. *Raise*, to drive a "friendly" stone nearer the tee. *Rebut*, to deliver the stone with great force, so as to scatter the stones on the boardhead. *Red the ice*, clear away the opponents' stones. *Rink*, the space in which the game is played; also the members of a side. *Sole*, the under part of the stone; also to deliver the stone. *Soop*, to sweep. *Souter*, to win without allowing the opponents to score at all; a term derived from a famous team of cobblers (souters) of Lochmaben, whose opponents seldom or never scored a point. *Spiel*, a match between members of the same club. *Spend the stone*, to waste a shot by playing wide intentionally. *Stug*, a fluke. *Tee*, the mark in the centre of the boardhead, against which it is the curler's object to lay the stone. The tee may be any kind of a mark; a small iron plate with a spike in it is often used. *Tosee*, tee. *Tramp*, *crampit*, *trigger* or *tricker*, an iron plate fitted with spikes which the player stands upon to deliver the stone. *Willyr*, tee.

*The Rink and Implements.*—The rink is marked out in the ice, which should be very hard and smooth, in curling language "keen and clear." To keep it swept every curler carries a broom, sometimes a mere bundle of broom-twigs, more often an ordinary housemaid's broom. Good "sooping," or sweeping, is part of the curler's art, and is performed subject to strict rules and under the direction of the skip, or captain; its importance lying in the fact that the progress of a stone is retarded by the ice-dust caused by the play, the sweeping of which in front of a running stone consequently prolongs its course. Apart from the broom and the crampit, the "roarin' game," as curlers love to call it, requires no further implement than the stone, a flattened, polished disk, fitted with a handle. In weight it must not exceed 44 lb, 35 to 40 lb being usual. It must not exceed 36 in. in circumference or be less in height than one-eighth of the circumference. The two flat sides, or soles, are so shaped that

one is serviceable for keen ice and the other for ice that is soft, rough or "baugh." The handle can be fitted to either side, as the case demands. The cost of a pair of stones is not less than £2, generally more. In the intense cold of Canada and the United States iron is found more serviceable than stone, and the irons weigh from 60 to 70 lb. Even these are light compared with the earlier rough boulder-stones, some of which weighed over 115 lb, although the very early ones were much lighter. The modern stone took shape at the beginning of the 19th century. The ancient stones had no handles, but notches were hewn in them for finger and thumb, and, as their weight varied from 5 to 25 lb, it is probable that they were thrown after the manner of quoits. Channel-stones, stones rounded by the action of water in a river-bed, were the favourites, while the shape was a matter of individual taste, oblong and triangular stones having been common. The soles were artificially flattened. During the next period we find the heavy boulder-stones, un-hewn blocks fitted with handles and probably used at shorter distances, 70 or 80 lb being no uncommon weight. The rounded stone, made on scientific principles, did not appear until about 1800. Even then it was of all shapes and sizes, with and without handles, and not uncommonly made of wood. The stones of to-day are named after the places in which they are quarried, Ailsa Craigs, Burnocks, Carsphairn Reds and Crawfordjohns being some of the best-known varieties. The stones are quarried and never blasted, as the shock of the explosion is apt to strain or split the rock.

*The Game.*—Curling is practically bowls played on the ice, the place of the "jack" being taken by a fixed mark, as at quoits, called the tee, to which the curler aims his stone; every stone that finally lies nearer than any of the opposing stones counting a point or "shot." As each side has four players, each playing two stones, it is possible for one side to score eight points at a "head" or innings; but in practice it is found wiser, when a good shot has been made, to play some or all following stones to such positions as will prevent opposing stones from disturbing the stone lying near the tee. Stones thus placed are called "guards." Strategic matters like this are decided by the skip, or captain, of the rink, who plays last, and who is an autocrat whose will is law. The "lead," or first player, is expected to play quietly up the rink, leaving his stone as close to the tee as possible, but on no account beyond it. He is followed by the "lead" of the other side, who, instructed by his skip, will either try to drive away the first stone, if well placed, or put his own stone in a better position. When the skip's turn comes he is "skipped," or directed, by another player, appointed by himself, usually the third player. When all sixteen stones have been delivered the players cross over, the scores are counted, and the game proceeds from the other end of the rink. If a stone fails to cross the "hog-score" it is a "hog" and is removed from the rink, unless it has struck another stone in position. Stones that pass the back-score or touch the swept snow on either side are also removed. By a cleverly imparted twist a stone may be made to curve round a guard and either drive away an opposing winner or find a favourable lie for itself. This, the equivalent of "bias" in the game of bowls, is the height of scientific play. If the situation seems desperate a very hard throw, a "thunderin' cast," may succeed in clearing away the opponents' stones from the neighbourhood of the tee. Different methods are adopted in delivering the stone, but in all of them a firm stand should be taken on the crampit, and the stone swung, either quietly, or, if the skip calls for a "thunderin' cast," vigorously; but care must be taken to avoid striking the ice with the stone so as to crack or "star" the ice. All matches are for a certain number of "heads" or of points, or for all that can be made within a certain time limit, as may be agreed.

*Abridged Rules.*—Tees shall be 38 yds. apart, and with the tee as centre a circle having a radius of 7 ft. shall be drawn. In alignment with the tees, lines, to be called Central Lines, are drawn from the tees to points 4 yds. behind each tee, and at these points Foot Scores 18 in. long shall be drawn at right angles, on which, at 6 in. from Central Line, the heel of the Crampit shall be placed. All matches shall be of a certain number of heads, or shots, or by time, as agreed.

Every rink of players shall be composed of four a side. No shoes likely to break the ice may be worn.

The skips opposing each other shall settle by lot, or in any other way they may agree upon, which party shall lead at the first head, after which the winning party shall do so.

All curling stones shall be of a circular shape. No stone shall be of a greater weight than 44 lb imperial, or of greater circumference than 36 in., or of less height than one-eighth part of its greatest circumference.

No stone, or side of a stone, shall be changed after a match has been begun, or during its continuance, unless by consent.

Should a stone happen to be broken, the largest fragment shall be considered in the game for that end—the player being entitled afterwards to use another stone or another pair.

If a played stone rolls over, or stops, on its side or top, it shall be put off the ice. Should the handle quit the stone in delivery, the player must keep hold of it, otherwise he shall not be entitled to replay the shot.

Players, during the course of each end, to be arranged along the sides of the rink, anywhere skips may direct; and no party, except when sweeping according to rule, shall go upon the middle of the rink, or cross it, under any pretence whatever. Skips alone to stand at or about the tee—that of the playing party having the choice of place, and not to be obstructed by the other.

If a player should play out of turn, the stone so played may be stopped in its progress, and returned to the player. Should the mistake not be discovered till the stone be at rest, or has struck another stone, the opposite skip shall have the option of adding one to his score, allowing the game to proceed, or declaring the end null and void. But if a stone be played before the mistake has been discovered, the head must be finished as if it had been properly played from the beginning.

The sweeping shall be under the direction and control of the skips. The player's party may sweep the ice anywhere from the centre line to the tee, and behind it,—the adverse party having liberty to sweep behind the tee, and in front of any of their own stones when moved by another, and till at rest. Skips to have full liberty to clean and sweep the ice behind the tee at any time, except when a player is being directed by his skip.

If in sweeping or otherwise, a running stone be marred by any of the party to which it belongs, it may, at the option of the opposite skip, be put off the ice; if by any of the adverse party, it may be placed where the skip of the party to which it belongs shall direct. If otherwise marred, it shall be replayed.

Every player to be ready to play when his turn comes, and not to take more than a reasonable time to play. Should he play a wrong stone, any of the players may stop it while running; but if not stopped till at rest, the one which ought to have been played shall be placed instead, to the satisfaction of the opposing skip.

No measuring of shots allowable previous to the termination of the end. Disputed shots to be determined by the skips, or, if they disagree, by the umpire, or, when there is no umpire, by some neutral person chosen by the skips. All measurements to be taken from the centre of the tee, to that part of the stone which is nearest it. No stone shall be considered without a circle, or over a line, unless it clear it;—and in every case, this is to be determined by placing a square on the ice, at the circle or line.

Skips shall have the exclusive regulation and direction of the game for their respective parties, and may play last stone, or in what part of it they please; and, when their turn to play comes, they may name one of their party to take charge for them.

If any player shall speak to, taunt or interrupt another, not being of his own party, while in the act of delivering his stone, one shot shall be added to the score of the party so interrupted.

If from any change of weather after a match has been begun, or from any other reasonable cause, one party shall desire to shorten the rink, or to change to another one, and, if the two skips cannot agree, the umpire shall, after seeing one end played, determine whether the rink shall be shortened, and how much or whether it shall be changed, and his decision shall be final.

See *Annual* of the Royal Caledonian Curling Club, Edinburgh.

**CURL, EDMUND** (1675–1747), English bookseller, was born in 1675 in the west of England. His parents were in humble circumstances. After being apprenticed to an Exeter bookseller he came to London and started business on his own account, advertising himself by a system of newspaper quarrels. His connexion with the anonymously-published *Court Poems* in 1716 led to the long quarrel with Pope, who took his revenge by immortalizing Curl in the *Dunciad*. Curl became notorious for his indecent publications, so much so that "Curlicism" was regarded as a synonym for literary indecency. In 1716 and again in 1721 he had to appear at the bar of the House of Lords for publishing matter concerning its members. In 1725 he was convicted of publishing obscene books, and fined in 1728 for publishing *The Nun in her Smock* and *De Usu Flagrorum*, while his *Memories*

of *John Ker of Kersland* cost him an hour in the pillory. When Curl in 1735 announced the forthcoming publication of "*Mr Pope's Literary Correspondence*," his stock, at Pope's instigation, was seized. It has since been proved that the publication was really instigated by Pope, who wanted an excuse to print his letters, as he actually did (1737–1741). In his forty years of business Curl published a great variety of books, of which a very large number, fortunately, were quite free from "Curlicisms." A list of his publications contains, indeed, 167 standard works. He died on the 11th of December 1747.

For Curl's relations with Pope, see the *Life of Pope*, by Sir Leslie Stephen in the *English Men of Letters* series.

**CURRAGH**, a level stretch of open ground in Co. Kildare, Ireland, famous for its race-course and its military camp. It has an area of upwards of 4800 acres; and its soft natural sward, which has never been broken by the plough, affords excellent pasture for sheep. From the peculiarity of its herbage, the district is known in the neighbourhood as "the short grass"; and the young men of Kildare are jocularly distinguished as the "boys of the short grass." The land is the property of the crown, which appoints a special officer as the ranger of the Curragh; but the right of pasturage is possessed by the land-owners of the vicinity. The oldest mention of the Curragh occurs in the *Liber Hymnorum* (the manuscript of which probably dates from the 10th century) in connexion with St Bridget, who is said to have received a grant of the district from the king of Leinster, and is popularly credited with the honour of having turned it into a common. It is evident, however, that long before the days of the saint the downs of Kildare had afforded a regular place of assembly for the people of the south of Ireland. The word *cuirrech*, cognate with the Lat. *cursus*, signifies a race-course, and chariot-races are spoken of as taking place on the Curragh as early as the 1st century A.D. The *Aenach Colmain* (Curragh fair), also called *Aenach Liffey* (the fair on the plain of the Liffey), is frequently mentioned in the Irish annals, and both racing and other sports were carried on at this, the principal meeting of its kind in southern Ireland, and the plain appears from time to time as the scene of hostile encounters between the kings of Meath, Leinster and Offaly. In 1234 the earl of Pembroke was defeated here by the viceroy of Ireland, Lord Geoffrey de Monte Marisco; and in 1406 the Irish under the prior of Connell were routed by the English. In 1789 the Curragh was the great rendezvous for the volunteers, and in 1804 it saw the gathering of 30,000 United Irishmen. The camp was established at the time of the Crimean War, and is capable of accommodating 12,000 men. The races are held in April, June, September and October.

See W. M. Hennessy, in *Proceedings of Royal Irish Acad.*, 1866.

**CURRAN, JOHN PHILPOT** (1750–1817), Irish politician and judge, was born on the 24th of July 1750, at Newmarket, Cork, where his father, a descendant of one of Cromwell's soldiers, was seneschal to the manor-court. He was educated at Middleton, through the kind help of a friend, the Rev. Nathaniel Boyse, and at Trinity College, Dublin; and in 1773, having taken his M.A. degree, he entered the Middle Temple. In 1774 he married a lady who brought him a small dowry; but the marriage proved unhappy, and Mrs Curran finally eloped from her husband.

In 1775 Curran was called to the Irish bar, where he very soon obtained a practice. On his first rising in court excessive nervousness prevented him from even reading distinctly the few words of a legal form, and when requested by the judge to read more clearly he became so agitated as to be totally unable to proceed. But, his feelings once roused, all nervousness disappeared. His effective and witty attack upon a judge who had sneered at his poverty, the success with which he prosecuted a nobleman for a disgraceful assault upon a priest, the duel which he fought with one of the witnesses for this nobleman, and other similar exploits, gained him such a reputation that he was soon the most popular advocate in Ireland.

In 1783 Curran was appointed king's counsel; and in the same year he was presented to a seat in the Irish House of Commons. His conduct in connexion with this affair displays his conduct

in a most honourable light; finding that he differed radically in politics from the gentleman from whom he had received his seat, he expended £1500 in buying another to replace that which he occupied. In his parliamentary career Curran was throughout sincere and consistent. He spoke vigorously on behalf of Catholic emancipation, and strenuously attacked the ministerial bribery which prevailed. His declamations against the government party led him into two duels—the first with John Fitzgibbon, then attorney-general, afterwards Lord Clare; the second with the secretary of state, Major Hobart, afterwards earl of Buckinghamshire. The Union caused him the bitterest disappointment; he even talked of leaving Ireland, either for America or for England.

Curran's fame rests most of all upon his speeches on behalf of the accused in the state trials that were so numerous between 1794 and 1803; and among them may be mentioned those in defence of Hamilton Rowan, the Rev. William Jackson, the brothers John and Henry Sheares, Peter Finnerty, Lord Edward Fitzgerald, Wolfe Tone and Owen Kirwan. Another of his most famous and characteristic speeches is that against the marquis of Headfort, who had eloped with the wife of a clergyman named Massey. On the arrest of Robert Emmet, who had formed an attachment to his daughter, Curran was himself under suspicion; but, on examination before the privy council, nothing was brought forward to implicate him in the intended rebellion.

In 1806, on the death of Pitt and the formation of the Fox ministry, Curran received the post of master of the rolls, with a seat in the privy council, much to his disappointment, for he had desired a position of greater political influence. For eight years, however, he held this office. He then retired on a pension of £3000; and the three remaining years of his life were spent in London, where he became one of the most brilliant members of the society which included Sheridan, Erskine, Thomas Moore, and William Godwin. He died at his house in Brompton on the 14th of October 1817.

Curran's legal erudition was never profound; and though he was capable of the most ingenious pleading, his appeal was always to the emotions of his audience. His best speeches are one fiery torrent of invective, pathos, national feeling and wit. His diction was lofty and sonorous. He was, too, a most brilliant wit and of wonderful quickness in repartee. To his personal presence he owed nothing; for he was short, slim and boyish-looking, and his voice was thin and shrill.

See *Curran and his Contemporaries*, a most entertaining work, by Charles Phillips, a personal friend of Curran's (1818), and *Life of Curran*, by his son, W. H. Curran (1819), and with additions by Dr Shelton Mackenzie, New York, 1855), both of which contain numerous samples of Curran's eloquence. See also *Curran's Speeches* (1805, 1808, 1845); *Memoirs of Curran*, by Wm. O'Regan (1817); *Letters to Rev. H. Weston* (1819); *T. Moore's Memoirs* (1853).

**CURRANT.** (1) The dried seedless fruit of a variety of the grape-vine, *Vitis vinifera*, cultivated principally in Zante, Cephalonia and Ithaca, and near Patras, in the Morea (see GREECE). Currants were brought originally from Corinth, whence their name; in the 13th and 14th centuries they were known as *raisins de Coraunte*. In the Ionian Islands the currant-vine is grown on the sides of the lower hills, or in the valleys, the grape-vine occupying the higher and less open and rich ground. Gypseous marls, or calcareous marls containing a little gypsum, are preferred to limestone soils, as they allow of deep penetration of the roots of the vines. The most favourable situations are those where a good supply of water can be obtained for the irrigation of the plantations. This is carried on from the end of October to the close of the year, after which all that is necessary is to keep the ground moist. The vines are planted in rows 3 or 4 ft. apart. Propagation is effected by grafting on stocks of the grape-vine, or by planting out in spring the young, vigorous shoots obtained at the end of the previous year from old currant-vines that have been cut away below the ground. The grafts bear fruit in three years, the slips in about double that time. The vine stock for grafting is cut down to the depth of a foot below the surface of the soil; two or three perpendicular incisions are made near the bark with a chisel; and into these

are inserted shoots of the last year's growth. The engrafted part then receives an application of moist marls, is wrapped in leaves and bound with rushes, and is covered with earth, two or three eyes of the shoots being left projecting above ground. In December the currant plantations are cleared of dead and weak wood. In February the branches are cut back, and pruned of median shoots, which are said to prevent the lateral ones proceeding from the same bud from bearing fruit. In order effectually to water the trees, the earth round about them is in February and March hoed up so as to leave them in a kind of basin, or is piled up against their stems. In March, when the leaves begin to show, the ground is thoroughly turned, and if requisite manured, and is then re-levelled. By the middle of April the leaves are fully out, and in June it is necessary to break back the newly-formed shoots. The fruit begins to ripen in July, and in the next month the vintage takes place. At this season rain is greatly dreaded, as it always damages and may even destroy the ripe fruit. The plantations, which are commonly much exposed, are watched by dogs and armed men. In Cephalonia the currant-grape is said to ripen at least a week earlier than in Zante. To destroy the oïdium, a fungal pest that severely injures the plantations, the vines are dusted, at the time the fruit is maturing, with finely-ground brimstone. The currants when sufficiently ripe are gathered and placed on a drying ground, where they are exposed to the sun in layers half an inch thick; from time to time they are turned and swept into heaps, until they become entirely detached from stalk. They are then packed in large butts for exportation. The wine made from the currant-grape is inferior in quality, but is said to be capable of much improvement. The fresh fruit is luscious and highly flavoured, but soon cloy the palate.

(2) The currants of British kitchen-gardens—so called from a resemblance to the foregoing—are the produce of *Ribes nigrum* and *R. rubrum*, deciduous shrubs of the natural order *Ribesiacæ*, indigenous to Britain, northern and central Europe, Siberia and Canada. The former species bears the black, the latter the red currant. White currants are the fruit of a cultivated variety of *R. rubrum*. Both red and black currants are used for making tarts and pies, jams, jellies and wine; the latter are also employed in lozenges, popularly supposed to be of value in relieving a sore throat, are occasionally preserved in spirits, and in Russia are fermented with honey to produce a strong liquor.

Currants will flourish in any fairly good soil, but to obtain large crops and fine fruit a good rich loam is desirable; with an annual dressing of farmyard manure or cowdung, after the winter pruning, for established trees. The plants are best propagated by cuttings, which should consist of strong well-ripened young shoots taken off close to the old wood. These should be planted as soon as possible after the wood is matured in autumn about 6 in. apart. The plants are grown with the best results as bushes, but may also be trained against a wall or trellis. In the matter of pruning it must be borne in mind that red and white currants form their fruit buds on wood two to three years old, and the main shoots and side branches may therefore be cut back. Black currants on the other hand form fruit buds on the new wood of the previous year, hence the old wood should be cut away and the young left.

The black currant is subject to the attacks of a mite, *Phytoptus ribis*, which destroys the unopened buds. The buds, when attacked, recognized by their swollen appearance, should be picked off and burned. The attacks of the caterpillars of the gooseberry and other moths may be met by dusting the bushes with lime and soot when the plants are moist with dew or after syringing.

The following forms are recommended for cultivation:—*Black*: Lee's Prolific, Baldwin's or Carter's Champion and Black Naples; *Red*: Cherry, Raby Castle, Red Dutch and Comet; *White*: White Dutch. A kind of black currant (*Ribes magellanicum*), bearing poor and acid fruit, is indigenous to Tierra del Fuego.

**CURRICLE** (Lat. *curriculum*, a small car), a light two-wheeled vehicle, generally for driving with two horses.

**CURRIE, SIR DONALD** (1825-1909), British shipowner, was born at Greenock on the 17th of September 1825. At a very early age he was employed in the office of a shipowner in that port, but at the age of eighteen left Scotland for Liverpool, where shipping business offered more scope. By a fortunate chance he attracted the notice of the chief partner in the newly started Cunard steamship line, who found him a post in that company. In 1849 the Cunard Company started a service between Havre and Liverpool to connect with their transatlantic service. Currie was appointed Cunard agent at Havre and Paris, and secured for his firm a large share of the freight traffic between France and the United States. About 1856 he returned to Liverpool, where till 1862 he held an important position at the Cunard Company's headquarters. In 1862 he determined to strike out for himself, and leaving the Cunard established the "Castle" line of sailing-ships between Liverpool and Calcutta. Business prospered, but in 1864 Currie found it profitable to substitute London for Liverpool as the home port of his vessels, and himself settled in London. In 1872 he came to the conclusion, after a careful study of all the circumstances, that the development of Cape Colony justified the starting of a new line of steamers between England and South Africa. The result of this decision was the founding of the successful Castle line of steamers (see under STEAMSHIP LINES), which after 1876 divided the South African mail contract with the older Union line, and was finally amalgamated with the latter under the title Union Castle line in 1900. Currie's intimate knowledge of South African conditions and persons was on several occasions of material service to the British government. His acquaintance with Sir John Brand, the president of what was then the Orange Free State, caused him to be entrusted by the home government with the negotiations in the dispute concerning the ownership of the Kimberley diamond-fields, which were brought to a successful conclusion. He introduced the two Transvaal deputations which came to England in 1877 and 1878 to protest against annexation, and though his suggestions for a settlement were disregarded by the government of the day, the terms on which the Transvaal was subsequently restored to the Boers agreed, in essentials, with those he had advised. The first news of the disaster of Isandhlwana in the Zulu War was given to the home government through his agency. At that time there was no cable between England and South Africa, and the news was sent by a Castle liner to St Vincent, and telegraphed thence to Currie. At the same time by diverting his outward mail-boat then at sea from its ordinary course to St Vincent, he enabled the government to telegraph immediate instructions to that island for conveyance thence by the mail, thus saving serious delay, and preventing the annihilation of the British garrison at Eshowe. The present arrangement under which the British admiralty is enabled to utilize certain fast steamers of the mercantile marine as armed cruisers in war-time was suggested and strongly urged by Currie in 1880. In the same year he was returned to parliament as Liberal member for Perthshire, but, though a strong personal friend of W.E. Gladstone, he was unable to follow that statesman on the Home Rule question, and from 1885 to 1900 he represented West Perthshire as a Unionist. In 1881 his services in connexion with the Zulu War were rewarded with knighthood, and in 1897 he was created G.C.M.G. He died at Sidmouth on the 13th of April 1909.

**CURRIE, JAMES** (1756-1805), Scottish physician and editor of Burns, son of the minister of Kirkpatrick-Fleming, in Dumfriesshire, was born there on the 31st of May 1756. Attracted by the stories of prosperity in America he went in 1771 to Virginia, where he spent five hard years, much of the time ill and always in unprofitable commercial business. The outbreak of war between the Colonies and England ended any further chance of success, and sailing for home in the spring of 1776 after many delays he reached England a year later. He then proceeded to study medicine at Edinburgh, and after taking his degree at Glasgow he settled at Liverpool in 1780, where three years later he became physician to the infirmary. He died at Sidmouth on the 31st of August 1805. Among other pamphlets Currie

was the author of *Medical Reports on the Effects of Water, Cold and Warm, as a Remedy in Fevers and Febrile Diseases* (1797), which had some influence in promoting the use of cold water affusion, and contains the first systematic record in English of clinical observations with the thermometer. But he is best known for his edition (1800), long regarded as the standard, of Robert Burns, which he undertook in behalf of the family of the poet. It contained an introductory criticism and an essay on the character and condition of the Scottish peasantry.

See the *Memoir* by W. W. Currie, his son (1831).

**CURRY.** (1) (Through the O. Fr. *correier*, from Late Lat. *conredare*, to make ready, prepare; a later form of the French is *courroyer*, and modern French is *corroyer*), to dress a horse by rubbing down and grooming with a comb; to dress and prepare leather already tanned. The currier pares off roughnesses and inequalities, makes the leather soft and pliable, and gives it the necessary surface and colour (see LEATHER). The word "currier," though early confused in origin with "to curry," is derived from the Late Lat. *coriarius*, a leather dresser, from *corium*, hide. The phrase "to curry favour," to flatter or cajole, is a 16th century corruption of "to curry favel," i.e. a chestnut horse. This older phrase is an adaptation of an Old French proverbial expression *estriller fauvel*, and is paralleled in German by the similar *den fahlen Hengst streichen*. A chestnut or fallow horse seems to have been taken as typical of deceit and trickery, at least since the appearance of a French satirical beast romance the *Roman de fauvel* (1310), the hero of which is a counterpart of Reynard the Fox (*q.v.*).

(2) A name applied to a great variety of seasoned dishes, especially those of Indian origin. The word is derived from the Tamil *kari*, a sauce or relish for rice. In the East, where the staple food of the people consists of a dish of rice, wheaten cakes, or some other cereal, some kind of relish is required to lend attraction to this insipid food; and that is the special office of curry. In India the following are employed as ingredients in curries: anise, coriander, cumin, mustard and poppy seeds; allspice, almonds, assafoetida, butter or ghee, cardamoms, chillies, cinnamon, cloves, cocoa-nut and cocoanut milk and oil, cream and curds, fenugreek, the tender unripe fruit of *Buchanania lancifolia*, cheroonjie nuts (the produce of another species, *B. latifolia*), garlic and onions, ginger, lime-juice, vinegar, the leaves of *Bergera Koenigii* (the curry-leaf tree), mace, mangoes, nutmeg, pepper, saffron, salt, tamarinds and turmeric.

The cumin and coriander seeds are generally used roasted. The various materials are cleaned, dried, ground, sifted, thoroughly mixed and bottled. In the East the spices are ground freshly every day, which gives the Indian curry its superiority in flavour over dishes prepared with the curry-powders of the European market.

**CURSOR, LUCIUS PAPIRIUS**, Roman general, five times consul and twice dictator. In 325 he was appointed dictator to carry on the second Samnite War. His quarrel with Q. Fabius Maximus Rullianus, his *magister equitum*, is well known. The latter had engaged the enemy against the orders of Cursor, by whom he was condemned to death, and only the intercession of his father, the senate and the people, saved his life. Cursor treated his soldiers with such harshness that they allowed themselves to be defeated; but after he had regained their good-will by more lenient treatment and lavish promises of booty, they fought with enthusiasm and gained a complete victory. After the disaster of the Caudine Forks, Cursor to some extent wiped out the disgrace by compelling Luceria (which had revolted) to surrender. He delivered the Roman hostages who were held in captivity in the town, recovered the standards lost at Caudium, and made 7000 of the enemy pass under the yoke. In 309, when the Samnites again rose, Cursor was appointed dictator for the second time, and gained a decisive victory at Longula, in honour of which he celebrated a magnificent triumph. Cursor's strictness was proverbial; he was a man of immense bodily strength, while his bravery was

beyond dispute. He was surnamed Cursor from his swiftness of foot.

Livy viii. ix.; Aurelius Victor, *De viris illustribus*, 31; Eutropius ii. 8. 9.

His son of the same name, also a distinguished general, completed the subjection of Samnium (272). He set up a sun-dial, the first of its kind in Rome, in the temple of Quirinus.

Livy x. 39-47; Pliny, *Nat. Hist.*, vii. 60.

**CURSOR MUNDI**, an English poem in the Northern dialect dating from the 13th century. It is a religious epic of 24,000 lines "over-running" the history of the world as related in the Old and New Testaments. "Cursur o werld man aght it call, For almost it over-rennes all." The author explains in his prologue his reasons for undertaking the work. Men desire to read old romances of Alexander, Julius Caesar, Greece, Troy, Brut, Arthur, of Tristram, Sweet Ysode and others. But better than tales of love is the story of the Virgin who is man's best lover, therefore in her honour he will write this book, founded on the steadfast ground of the Holy Trinity. He writes in English for the love of English people of merry England, so that those who know no French may understand. The history is treated under seven ages. The first four include the period from the creation of the world to the successors of Solomon, the fifth deals with Mary and the birth and childhood of Jesus, the sixth with the lives of Christ and the chief apostles, and with the finding of the holy cross, and the seventh with Doomsday. Four short poems follow, more in some MSS. The bulk of the poem is written in rhyming couplets of short lines of four accents, and maintains a fair level throughout. The narrative is enlivened by many legends and much entertaining matter drawn from various sources; and the numerous transcripts of it prove that it was able to hold its own against profane romance.

The chief sources of the compilation have been identified by Dr Haenisch. For the Old Testament history the author draws largely from the *Historia scholastica* of Peter Comestor; for the history of the Virgin he often translates literally from Wace's *Établissement de la fête de la conception Notre Dame*; the parables of the king and four daughters, and of the castle of Love and Grace, are taken from "Sent Robert bok" (19516), that is, from the *Chateau d'Amour* of Robert Grosseteste, bishop of Lincoln; other sources are the apocryphal gospels of Matthew and Nicodemus, a southern English poem on the Assumption of Our Lady, attributed by the writer of *Cursor mundi* to Edmund Rich of Pontigny, the Vulgate, the *Legenda aurea* of Jacobus de Voragine, and the *De vita et morte sanctorum* of Isidore of Seville. The original of the section on the invention of the holy cross is still to seek. In its general plan the work is similar to the *Livre de sapience* of Herman de Valenciennes.

Of the author nothing is known. In the Cotton MS. Vespasian (A III.) the name of the owner William Cosyn is given (for particulars of this family, which is mentioned in Lincolnshire records as early as 1276, see Dr H. Hupe in the E.E.T.S. ed. of *Cursor mundi*, vol. i. p. 124 \*). The date of the book was placed by Dr J.A.H. Murray (*The Dialect of the Southern Counties of Scotland*, 1873, p. 30) in the last quarter of the 13th century, and the place of writing near Durham. Dr Hupe (*loc. cit.* p. 186 \*) gives good reasons for believing that the author was a Lincolnshire man, who wrote between 1260 and 1290, although the Cotton MS. probably belongs to the late 14th century. In the Göttingen MS. there are lines (17099-17110) desiring the reader to pray for John of Lindbergh, "that this bock gart dight," and cursing anybody who shall steal it. Lindbergh is probably Limber Magna, near Ulceby, in north Lincolnshire. Dr Hupe hazards an identification of the author with this John of Lindbergh, who may have been a member of the Cistercian Abbey of Lindbergh; but this is improbable.

*Cursor mundi* was edited for the Early English Text Society in 1874-1893 by Dr Richard Morris in parallel columns from four MSS.:—Cotton Vespasian A III., British Museum; Fairfax MS. 14, in the Bodleian library, Oxford; MS. theol. 107 at Göttingen; and MS. R. 3.8 in Trinity College, Cambridge. The edition includes a "Preface" by the editor, "An Inquiry into the Sources of the *Cursor*

*mundi*" (1885), by Dr Haenisch, an essay "On the Filiation and the Text of the MSS. of *Cursor mundi*" (1885), by Dr H. Hupe, "Cursor Studies and Criticisms on the Dialects of its MSS." (1888), by Dr Hupe and a glossary by Dr Max Kaluza.

**CURTAIN**, a screen of any textile material, running by means of rings fixed to a rod or pole. Curtains are now used chiefly to cover windows and doors, but for many centuries every bed of importance was surrounded by them, and sometimes, as in France, the space thus screened off was much larger than the actual bed and was called the *ruelle*. The curtain is very ancient—indeed the absence of glass and ill-fitting windows long made it a necessity. Originally single curtains were used; it would appear that it was not until the 17th century that they were employed in pairs. Curtains are made in an infinite variety of materials and styles; when placed over a door they are usually called *portières*. In fortification the "curtain" is that part of the enceinte which lies between two bastions, towers, gates, &c.

The word comes into English through the O. Fr. *corline* or *courtine* from the Late Lat. *cortina*. According to Du Cange (*Glossarium*, s.v. "Cortis") this is a diminutive of *cortis*, an enclosed space, a court. It is used in the various senses of the English "curtain." Classical Latin had also a word *cortina*, meaning a caldron or round kettle. It was very rarely applied to round objects generally. In the Vulgate *cortina* is used of the curtains of the tabernacle (Exodus xxvi). There is some difficulty in connecting the classical and the Late Latin words. The earliest use in English is, according to the *New English Dictionary*, for the hangings of a bed.

**CURTANA** (a latinized form of the A.-Fr. *curtein*, from Lat. *curtus*, shortened), the pointless sword of mercy, known also as Edward the Confessor's sword, borne at the coronation of the kings of England between the two pointed swords of temporal and spiritual justice (see REGALLA).

**CURTEA DE ARGESH** (Rumanian, *Curtea de Argeş*; also written *Curtea d'Argesh*, *Curtea d'Arđges*, *Argiş* and *Ardjish*), the capital of the department of Argesch, Rumania; situated on the right bank of the river Argesch, where it flows through a valley of the lower Carpathians; and on the railway from Pitesci to the Rothenthurm Pass. Pop. (1900) 4210. The city is one of the oldest in Rumania. According to tradition it was founded early in the 14th century by Prince Radu Negru, succeeding Câmpulung as capital of Walachia. Hence its name *Curtea*, "the court." It contains a few antique churches, and was created a bishopric at the close of the 18th century.

The cathedral of Curtea de Argesch, by far the most famous building in Rumania, stands in the grounds of a monastery, 1½ m. N. of the city. It resembles a very large and elaborate mausoleum, built in Byzantine style, with Moorish arabesques. In shape it is oblong, with a many-sided annexe at the back. In the centre rises a dome, fronted by two smaller cupolas; while a secondary dome, broader and loftier than the central one, springs from the annexe. Each summit is crowned by an inverted pear-shaped stone, bearing a triple cross, emblematic of the Trinity. The windows are mere slits; those of the tambours, or cylinders, on which the cupolas rest, are curved, and slant at an angle of 70°, as though the tambours were leaning to one side. Between the pediment and the cornice a thick corded moulding is carried round the main building. Above this comes a row of circular shields, adorned with intricate arabesques, while bands and wreaths of lilies are everywhere sculptured on the windows, balconies, tambours and cornices, adding lightness to the fabric. The whole is raised on a platform 7 ft. high, and encircled by a stone balustrade. Facing the main entrance is a small open shrine, consisting of a cornice and dome upheld by four pillars. The cathedral is faced with pale grey limestone, easily chiselled, but hardening on exposure. The interior is of brick, plastered and decorated with frescoes. Close by stands a large royal palace, Moorish in style. The archives of the cathedral were plundered by Magyars and Moslems, but several inscriptions, Greek, Slav and Ruman, are left. One tablet records that the founder was Prince Neagoe Bassarab (1512-1521); another that Prince John Radu



completed the work in 1526. A third describes the repairs executed in 1681 by Prince Sherban Cantacuzino; a fourth, the restoration, in 1804, by Joseph, the first bishop. Between 1875 and 1885 the cathedral was reconstructed; and in 1886 it was re-consecrated. Its legends have inspired many Rumanian poets, among them the celebrated V. Alexandri (1821-1890). One tradition describes how Neagoe Bassarab, while a hostage in Constantinople, designed a splendid mosque for the sultan, returning to build the cathedral out of the surplus materials. Another version makes him employ one Manole or Manoli as architect. Manole, being unable to finish the walls, the prince threatened him and his assistant with death. At last Manole suggested that they should follow the ancient custom of building a living woman into the foundations; and that she who first appeared on the following morning should be the victim. The other masons warned their families, and Manole was forced to sacrifice his own wife. Thus the cathedral was built except the roof. So arrogant, however, did the masons become, that the prince bade remove the scaffolding, and all, save Manole, perished of hunger. He fell to the ground, and a spring of clear water, which issued from the spot, is still called after him.

**CURTESY** (a variant of "courtesy," *q.v.*), in law, the life interest which a husband has in certain events in the lands of which his wife was in her lifetime actually seised for an estate of inheritance. As to the historical origin of the custom and the meaning of the word there is considerable doubt. It has been said to be an interest peculiar to England and to Scotland, hence called the "curtesy of England" and the "curtesy of Scotland"; but this is erroneous, for it is found also in Germany and France. The *Miroir des Justices* ascribes it to Henry I. K. E. Digby (*Hist. Real Prop.* chap. iii.) says that it is connected with *curia*, and has reference either to the attendance of the husband as tenant of the lands at the lord's court, or to mean simply that the husband is acknowledged tenant by the courts of England (*tenens per legem Angliæ*). The requisites necessary to make tenancy by the curtesy are: (1) a legal marriage; (2) an estate in possession of which the wife must have been actually seised; (3) issue born alive and during the mother's existence, though it is immaterial whether the issue live or die, or whether it is born before or after the wife's seisin; in the case of gavelkind lands the husband has a right to curtesy, whether there is issue born or not; but the curtesy extends only to a moiety of the wife's lands and ceases if the husband marries again. The issue must have been capable of inheriting as heir to the wife, *e.g.* if a wife were seised of lands in tail male the birth of a daughter would not entitle the husband to a tenancy by curtesy; (4) the title to the tenancy vests only on the death of the wife. The Married Women's Property Act 1882 has not affected the right of curtesy so far as relates to the wife's undisposed-of realty (*Hope v. Hope*, 1892, 2 Ch. 336), and the Settled Land Act 1884, s. 8; provides that for the purposes of the Settled Land Act 1882 the estate of a tenant by curtesy is to be deemed an estate arising under a settlement made by the wife.

See Pollock and Maitland, *Hist. Eng. Law*; K. E. Digby, *Hist. Real Prop.*; Goodeve, *Real Property*.

**CURTILAGE** (Med. Lat. *curtilagium*, from *curtile* or *cortile*, a court or yard, cf. "court"), the area of land which immediately surrounds a dwelling-house and its yard and outbuildings. In feudal times every castle with its dependent buildings was protected by a surrounding wall, and all the land within the wall was termed the curtilage; but the modern legal interpretation of the word, *i.e.* what area is enclosed by the curtilage, depends upon the circumstances of each individual case, such as the terms of the grant or deed which passes the property, or upon what is held to be a convenient amount of land for the occupation of the house, &c. The importance of the word in modern law depends on the fact that the curtilage marks the limit of the premises in which housebreaking can be committed.

**CURTIN, ANDREW GREGG** (1817-1894), American political leader, was born at Bellefonte, Centre county, Pennsylvania, on the 22nd of April 1817, the son of a native of Ireland who was a pioneer iron manufacturer in Pennsylvania. He graduated

from the law department of Dickinson College in 1837, was admitted to the bar in 1839, and successfully practised his profession. Entering politics as a Whig, he was chairman of the Whig state central committee in 1854, and from 1855 to 1858 was secretary of the commonwealth. In this capacity he was also *ex officio* the superintendent of common schools, and rendered valuable services to his state in perfecting and expanding the free public school system, and in establishing state normal schools. Upon the organization of the Republican party he became one of its leaders in Pennsylvania, and in October 1860 was chosen governor of the state on its ticket, defeating Henry D. Foster, the candidate upon whom the Douglas and Breckinridge Democrats and the Constitutional Unionists had united, by 32,000 votes, after a spirited campaign which was watched with intense interest by the entire country as an index of the result of the ensuing presidential election. During the Civil War he was one of the closest and most constant advisers of President Lincoln, and one of the most efficient, most energetic and most patriotic of the "war governors" of the North. Pennsylvania troops were the first to reach Washington after the president's call, and from first to last the state, under Governor Curtin's guidance, furnished 387,284 officers and men to the Northern armies. One of his wisest and most praiseworthy acts was the organization of the famous "Pennsylvania Reserves," by means of which the state was always able to fill at once its required quota after each successive call. In raising funds and equipping and supplying troops the governor showed great energy and resourcefulness, and his plans and organizations for caring for the needy widows and children of Pennsylvania soldiers killed in battle, and for aiding and removing to their homes the sick and wounded were widely copied throughout the North. He was re-elected governor in 1863 and served until January 1867. He was United States minister to Russia from 1869 until 1872, when he returned to America and took part in the Liberal Republican revolt against President U. S. Grant. In 1872-1873 he was a member of the state constitutional convention. Subsequently he joined the Democratic party and was a representative in Congress from 1881 to 1887. He died at his birthplace, Bellefonte, Pennsylvania, on the 7th of October 1894.

See William H. Egle's *Life and Times of Andrew Gregg Curtin* (Philadelphia, 1896), which contains chapters written by A. K. McClure, Jno. Russell Young, Wayne McVeagh, Fitz John Porter and others.

**CURTIS, GEORGE TICKNOR** (1812-1894), American lawyer, legal writer and constitutional historian, was born in Watertown, Massachusetts, on the 28th of November 1812. He graduated at Harvard in 1832, was admitted to the bar in 1836, and practised in Worcester, Boston, New York and Washington, appearing before the United States Supreme Court in many important cases, including the *Dred Scott* case, in which he argued the constitutional question for Scott, and the "legal tender" cases. In Boston he was for many years the United States commissioner, and in this capacity, despite the vigorous protests of the abolitionists and his own opposition to slavery, ordered the return to his owner of the famous fugitive slave, Thomas Sims, in 1852. He was the nephew and close friend of George Ticknor, the historian of Spanish literature, and his association with his uncle was influential in developing his scholarly tastes; while his other personal friendships with eminent Bostonians during the period of conservative Whig ascendancy in Massachusetts politics were of direct influence upon his political opinions and published estimates. He is best known as the author of *A History of the Origin, Formation and Adoption of the Constitution of the United States, with Notices of its principal Framers* (1854), republished, with many additions, as *The Constitutional History of the United States from their Declaration of Independence to the Close of their Civil War* (2 vols., 1889-1896). This history, which had been watched in its earlier progress by Daniel Webster, may be said to present the old Federalist or "Webster-Whig" view of the formation and powers of the Constitution; and it was natural that Curtis should follow it with

a voluminous *Life of Daniel Webster* (2 vols., 1870), the most valuable biography of that statesman. Both these works are characterized by solidity and comprehensiveness rather than by rhetorical attractiveness or literary perspective. In his later years Mr Curtis, like so many of the followers of Webster, turned towards the Democratic party; and he wrote, among other works of minor importance, an exculpatory life of President James Buchanan (2 vols., 1883) and two vindications of General George B. McClellan's career (1886 and 1887). He died in New York on the 28th of March 1894.

In addition to the works above mentioned he published: *Digest of the English and American Admiralty Decisions* (1839); *Rights and Duties of Merchant Seamen* (1841), which elicited the hearty praise of Justice Joseph Story; *Law of Patents* (1849); *Equity Precedents* (1850); *Commentaries on the Jurisprudence, Practice and Peculiar Jurisdiction of the Courts of the United States* (1854-1858); *Creation or Evolution: A Philosophical Inquiry* (1887); and a novel, *John Chambers: A Tale of the Civil War in America* (1889).

His brother, BENJAMIN ROBBINS CURTIS (1809-1874), also an eminent jurist, was born on the 4th of November 1809, in Watertown, Massachusetts, graduated at Harvard in 1829, studied law at Cambridge and at Northfield, Mass., where, after his admission to the bar in 1832, he practised law for two years, and then in Boston in 1834-1851. In 1851, being then a member of the lower house of the Massachusetts legislature, he was on the 22nd of September appointed to the Supreme Court of the United States, where he gained his greatest fame in 1857 by his dissenting opinion in the Dred Scott case, in which he argued that the Missouri Compromise was constitutional, and that negroes could become citizens. His argument was immediately published as an anti-slavery document. On the 1st of September 1857 he resigned from the Supreme Court and resumed his private practice. In 1868 he was one of the counsel for President Andrew Johnson in his impeachment trial, and opened for the defence in a remarkable two-days' speech. He died at Newport, Rhode Island, on the 15th of September 1874. He prepared *Decisions of the Supreme Court* (22 vols.) and a *Digest* of its decisions down to 1854.

A *Memoir of Benjamin Robbins Curtis, with Some of his Professional and Miscellaneous Papers*, edited by his son Benjamin R. Curtis, was published at Boston in 1879, the *Memoir* being by George Ticknor Curtis.

**CURTIS, GEORGE WILLIAM** (1824-1892), American man of letters, was born in Providence, Rhode Island, on the 24th of February 1824, of old New England stock. His mother died when he was two years old. At six he was sent with his elder brother to school in Jamaica Plain, Massachusetts, where he remained for five years. Then, his father having again married happily, the boys were brought home to Providence, where they stayed till, in 1839, their father removed to New York. Three years later, Curtis, being allowed to determine for himself his course of life, and being in sympathy with the spirit of the so-called Transcendental movement, became a boarder at the community of Brook Farm. He was accompanied by his brother, James Burrill Curtis, whose influence upon him was strong and helpful. He remained there for two years, brought into stimulating and serviceable relations with many interesting men and women. Then came two years, passed partly in New York, partly in Concord in order mainly to be in the friendly neighbourhood of Emerson, and then followed four years spent in Europe, Egypt and Syria.

Curtis returned from Europe in 1850, handsome, attractive, accomplished, ambitious of literary distinction. He instantly plunged into the whirl of life in New York, obtained a place on the staff of the *Tribune*, entered the field as a popular lecturer, set himself to work on a volume published in the spring of 1851, under the title of *Nile Notes of a Howadji*, and became a favourite in society. He wrote much for *Putnam's Magazine*, of which he was associate editor; and a number of volumes, composed of essays written for that publication and for *Harper's Monthly*, came in rapid succession from his pen. The chief of these were the *Potiphar Papers* (1853), a satire on the fashionable society of the day; and *Prue and I* (1856), a pleasantly sentimental, fancifully tender and humorous study of life. In 1855 he married

Miss Anna Shaw. Not long after his marriage he became, through no fault of his own, deeply involved in debt owing to the failure of *Putnam's Magazine*; and his high sense of honour compelled him to devote the greater part of his earnings for many years to the discharge of obligations for which he had become only by accident responsible, and from which he might have freed himself by legal process. In the period just preceding the Civil War other interests became subordinate to those of national concern. Curtis made his first important speech on the questions of the day at Wesleyan University in 1856; he engaged actively in the presidential campaign of that year, and was soon recognized not only as an effective public speaker, but also as one of the ablest, most high-minded, and most trustworthy leaders of public opinion. In 1863 he became the political editor of *Harper's Weekly*, and no other journal exercised during the war and after it a more important part in shaping public opinion. His writing was always clear, direct, forcible; his fairness of mind and sweetness of temper were invincible. He never became a mere partisan, and never failed to apply the test of moral principle to political measures. From month to month he contributed to *Harper's Monthly*, under the title of "The Easy Chair," brief essays on topics of social and literary interest, charming in style, touched with delicate humour and instinct with generous spirit. His service to the Republican party was such, that more than once he was offered nominations to office of high distinction, and might have been sent as minister to England; but he refused all offers of the kind, feeling that he could render more essential service to the country as editor and public speaker.

In 1871 he was appointed by President Grant chairman of the commission to report on the reform of the civil service. The report which he wrote was the foundation of every effort since made for the purification and regulation of the service and for the destruction of political patronage. From that time till his death Curtis was the leader in this reform, and to his sound judgment, his vigorous presentation of the evils of the corrupt prevailing system, and his untiring efforts, the progress of the reform is mainly due. He was president of the National Civil Service Reform League and of the New York Civil Service Reform Association. In 1884 he refused to support the nomination of James G. Blaine as candidate for the presidency, and thus broke with the Republican party, of which he had been one of the founders and leaders. From that time he stood as the typical independent in politics. In April 1892 he delivered at Baltimore his eleventh annual address as president of the National Civil Service Reform League, and in May he appeared for the last time in public, to repeat in New York an admirable address on James Russell Lowell, which he had first delivered in Brooklyn on the 22nd of the preceding February, the anniversary of Lowell's birth. On the 31st of the following August he died. He was a man of consistent virtue, whose face and figure corresponded with the traits and stature of his soul. The grace and charm of his manner were the expression of his nature. Of the Americans of his time few were more widely beloved, and the respect in which he was held was universal.

See *George William Curtis*, by Edward Cary, in the "American Men of Letters" series (Boston, 1894), an excellent biography; "An Epistle to George William Curtis," by James Russell Lowell (1874-1887), in Lowell's *Poems*; *George William Curtis*, a Commemorative Address delivered before The Century Association, 17th December 1892, by Parke Godwin (New York, 1893); *Orations and Addresses by George William Curtis*, edited by Charles Eliot Norton (3 vols. New York, 1894). (C. E. N.)

**CURTIUS, ERNST** (1814-1896), German archaeologist and historian, was born at Lübeck on the 2nd of September 1814. On completing his university studies he was chosen by C. A. Brandis to accompany him on a journey to Greece for the prosecution of archaeological researches. Curtius then became Otfried Müller's companion in his exploration of the Peloponnese, and on Müller's death in 1840 returned to Germany. In 1844 he became an extraordinary professor at the university of Berlin, and in the same year was appointed tutor to Prince Frederick William (afterwards the Emperor Frederick III.)—a post which he held till 1850. After holding a professorship at Göttingen and

undertaking a further journey to Greece in 1862, Curtius was appointed (in 1863) ordinary professor at Berlin. In 1874 he was sent to Athens by the German government, and concluded an agreement by which the excavations at Olympia (*q.v.*) were entrusted exclusively to Germany. Curtius died at Berlin on the 11th of July 1896. His best-known work is his *History of Greece* (1857-1867, 6th ed. 1887-1888; Eng. trans. by A. W. Ward, 1868-1873). It presented in an attractive style what were then the latest results of scholarly research, but was criticized as wanting in erudition. It is now superseded (see GREECE: *History, Ancient*, § Bibliography). His other writings are chiefly archaeological. The most important are: *Die Akropolis von Athen* (1844); *Naxos* (1846); *Peloponnesos, eine historisch-geographische Beschreibung der Halbinsel* (1851); *Olympia* (1852); *Die Ionier vor der ionischen Wanderung* (1855); *Attische Studien* (1862-1865); *Ephesos* (1874); *Die Ausgrabungen zu Olympia* (1877, &c.); *Olympia und Umgegend* (edited by Curtius and F. Adler, 1882); *Olympia. Die Ergebnisse der von dem deutschen Reich veranstalteten Ausgrabung* (with F. Adler, 1890-1898); *Die Stadtgeschichte von Athen* (1891); *Gesammelte Abhandlungen* (1894). His collected speeches and lectures were published under the title of *Altertum und Gegenwart* (5th ed., 1903 foll.), to which a third volume was added under the title of *Unter drei Kaisern* (2nd ed., 1895).

A full list of his writings will be found in L. Gurlitt, *Erinnerungen an Ernst Curtius* (Berlin, 1902); see also article by O. Kern in *Allgemeine deutsche Biographie*, lvii. (1903), to which may be added *Ernst Curtius. Ein Lebensbild in Briefen*, by F. Curtius (1903); T. Hodgkin, *Ernst Curtius* (1905).

His brother, GEORG CURTIUS (1820-1885), philologist, was born at Lübeck on the 16th of April 1820. After an education at Bonn and Berlin he was for three years a schoolmaster in Dresden, until (in 1845) he returned to Berlin University as *privat-docent*. In 1849 he was placed in charge of the Philological Seminary at Prague, and two years later was appointed professor of classical philology in Prague University. In 1854 he removed from Prague to a similar appointment at Kiel, and again in 1862 from Kiel to Leipzig. He died at Hermsdorf on the 12th of August 1885. His philological theories exercised a widespread influence. The more important of his publications are: *Die Sprachvergleichung in ihrem Verhältniss zur classischen Philologie* (1845; Eng. trans. by F. H. Trithen, 1851); *Sprachvergleichende Beiträge zur griechischen und lateinischen Grammatik* (1846); *Grundzüge der griechischen Etymologie* (1858-1862, 5th ed. 1879); *Das Verbum der griechischen Sprache* (1873). The last two works have been translated into English by A. S. Wilkins and E. B. England. From 1878 till his death Curtius was general editor of the *Leipziger Studien zur classischen Philologie*. His *Griechische Schulgrammatik*, first published in 1852, has passed through more than twenty editions, and has been edited in English. In his last work, *Zur Kritik der neuesten Sprachforschung* (1885), he attacks the views of the "new" school of philology.

*Opuscula* of Georg Curtius were edited after his death by E. Windisch (*Kleine Schriften von E. C.*, 1886-1887). For further information consult articles by R. Meister in *Allgemeine deutsche Biographie*, lvii. (1903), and by E. Windisch in C. Bursian's *Biographisches Jahrbuch für Alterthumskunde* (1886).

**CURTIUS, MARCUS**, a legendary hero of ancient Rome. It is said that in 362 B.C. a deep gulf opened in the forum, which the seers declared would never close until Rome's most valuable possession was thrown into it. Then Curtius, a youth of noble family, recognizing that nothing was more precious than a brave citizen, leaped, fully armed and on horseback, into the chasm, which immediately closed again. The spot was afterwards covered by a marsh called the Lacus Curtius. Two other explanations of the name Lacus Curtius are given: (1) a Sabine general, Mettius (or Mettus) Curtius, hard pressed by the Romans under Romulus, leaped into a swamp which covered the valley afterwards occupied by the forum, and barely escaped with his life; (2) in 445 B.C. the spot was struck by lightning, and enclosed as sacred by the consul, Gaius Curtius. It was marked by an altar which was removed to make room for the games in celebration of Caesar's funeral (Pliny, *Nat. Hist.* xv. 77), but

restored by Augustus (cf. Ovid, *Fasti*, vi. 403), in whose time there was apparently nothing but a dry well. The altar seems to have been restored early in the 4th century A.D. In April 1904, on the N. side of the Via Sacra and 20 ft. N.W. of the Equus Domitiani, remains of the buildings were discovered.

See Livy i. 12, vii. 6; Dion Halic. ii. 42; Varro, *De lingua Latina*, v. 148; Ch. Hülsen, *The Roman Forum* (Eng. trans. of 2nd ed., J. B. Carter, 1906); O. Gilbert, *Geschichte und Topographie der Stadt Rom im Altertum*, i. (1883), 334-338.

**CURTIUS RUFUS, QUINTUS**, biographer of Alexander the Great. Of his personal history nothing is known, nor can his date be fixed with certainty. Modern authorities regard him as a rhetorician who flourished during the reign of Claudius (A.D. 41-54). His work (*De Rebus gestis Alexandri Magni*) originally consisted of ten books, of which the first two are entirely lost, and the remaining eight are incomplete. Although the work is uncritical, and shows the author's ignorance of geography, chronology and military matters, it is written in a picturesque style.

There are numerous editions: (text) T. Vogel (1889), P. H. Damste (1897), E. Hedicke (1908); (with notes), T. Vogel (1885 and later), M. Croiset (1885); H. W. Reich (1895), C. Lebaigue (1900), T. Stangl (1902). There is an English translation by P. Pratt (1821). See S. Dosson, *Étude sur Quinte-Curce, sa vie, et ses œuvres* (1887) a valuable work; F. von Schwarz, *Alexander des Grossen Feldzüge in Turkestan* (1893), a commentary on Arrian and Curtius based upon the author's personal knowledge of the topography; C. Wachsmuth, *Einleitung in das Studium der alten Geschichte* (1895), p. 574, cf. p. 567, note 2; Schwarz, "Curtius Rufus" No. 31 in Pauly-Wissowa (1901).

**CURULE** (Lat. *currus*, "chariot"), in Roman antiquities, the epithet applied to the chair of office, *sella curulis*, used by the "curule" or highest magistrates and also by the emperors. This chair seems to have been originally placed in the magistrate's chariot (hence the name). It was inlaid with ivory or in some cases made of it, had curved legs but no back, and could be folded up like a camp-stool. In English the word is used in the general sense of "official." (See CONSUL, PRAETOR and AEDILE.)

**CURVE** (Lat. *curvus*, bent), a word commonly meaning a shape represented by a line bending continuously out of the straight without making an angle, but only properly to be defined in its geometrical sense in the terms set out below. This subject is treated here from an historical point of view, for the purpose of showing how the different leading ideas were successively arrived at and developed.

1. A curve is a line, or continuous singly infinite system of points. We consider in the first instance, and chiefly, a plane curve described according to a law. Such a curve may be regarded geometrically as actually described, or kinematically as in the course of description by the motion of a point; in the former point of view, it is the locus of all the points which satisfy a given condition; in the latter, it is the locus of a point moving subject to a given condition. Thus the most simple and earliest known curve, the circle, is the locus of all the points at a given distance from a fixed centre, or else the locus of a point moving so as to be always at a given distance from a fixed centre. (The straight line and the point are not for the moment regarded as curves.)

Next to the circle we have the conic sections, the invention of them attributed to Plato (who lived 430-347 B.C.); the original definition of them as the sections of a cone was by the Greek geometers who studied them soon replaced by a proper definition *in plano* like that for the circle, viz. a conic section (or as we now say a "conic") is the locus of a point such that its distance from a given point, the focus, is in a given ratio to its (perpendicular) distance from a given line, the directrix; or it is the locus of a point which moves so as always to satisfy the foregoing condition. Similarly any other property might be used as a definition; an ellipse is the locus of a point such that the sum of its distances from two fixed points (the foci) is constant, &c., &c.

The Greek geometers invented other curves; in particular, the conchoid (*q.v.*), which is the locus of a point such that its distance from a given line, measured along the line drawn through

it to a fixed point, is constant; and the cissoid (*q.v.*), which is the locus of a point such that its distance from a fixed point is always equal to the intercept (on the line through the fixed point) between a circle passing through the fixed point and the tangent to the circle at the point opposite to the fixed point. Obviously the number of such geometrical or kinematical definitions is infinite. In a machine of any kind, each point describes a curve; a simple but important instance is the "three-bar curve," or locus of a point in or rigidly connected with a bar pivoted on to two other bars which rotate about fixed centres respectively. Every curve thus arbitrarily defined has its own properties; and there was not any principle of classification.

2. *Cartesian Co-ordinates.*—The principle of classification first presented itself in the *Géométrie* of Descartes (1637). The idea was to represent any curve whatever by means of a relation between the co-ordinates ( $x, y$ ) of a point of the curve, or say to represent the curve by means of its equation. (See GEOMETRY: *Analytical.*)

Any relation whatever between ( $x, y$ ) determines a curve, and conversely every curve whatever is determined by a relation between ( $x, y$ ).

Observe that the distinctive feature is in the *exclusive* use of such determination of a curve by means of its equation. The Greek geometers were perfectly familiar with the property of an ellipse which in the Cartesian notation is  $x^2/a^2 + y^2/b^2 = 1$ , the equation of the curve; but it was as one of a number of properties, and in no wise selected out of the others for the characteristic property of the curve.

3. *Order of a Curve.*—We obtain from the equation the notion of an algebraical as opposed to a transcendental curve, viz. an algebraical curve is a curve having an equation  $F(x, y) = 0$  where  $F(x, y)$  is a rational and integral function of the co-ordinates ( $x, y$ ); and in what follows we attend throughout (unless the contrary is stated) only to such curves. The equation is sometimes given, and may conveniently be used, in an irrational form, but we always imagine it reduced to the foregoing rational and integral form, and regard this as the equation of the curve. And we have hence the notion of a curve of a *given order*, viz. the order of the curve is equal to that of the term or terms of highest order in the co-ordinates ( $x, y$ ) conjointly in the equation of the curve; for instance,  $xy - 1 = 0$  is a curve of the second order.

It is to be noticed here that the axes of co-ordinates may be any two lines at right angles to each other whatever; and that the equation of a curve will be different according to the selection of the axes of co-ordinates; but the order is independent of the axes, and has a determinate value for any given curve.

We hence divide curves according to their order, viz. a curve is of the first order, second order, third order, &c., according as it is represented by an equation of the first order,  $ax + by + c = 0$ , or say  $(*\text{I}) x, y, 1 = 0$ ; or by an equation of the second order,  $ax^2 + 2hxy + by^2 + 2fy + 2gx + c = 0$ , say  $(*\text{II}) x, y, 1^2 = 0$ ; or by an equation of the third order, &c.; or what is the same thing, according as the equation is linear, quadric, cubic, &c.

A curve of the first order is a right line; and conversely every right line is a curve of the first order. A curve of the second order is a conic, and is also called a quadric curve; and conversely every conic is a curve of the second order or quadric curve. A curve of the third order is called a cubic; one of the fourth order a quartic; and so on.

A curve of the order  $m$  has for its equation  $(*\text{III}) x, y, 1^m = 0$ ; and when the coefficients of the function are arbitrary, the curve is said to be the general curve of the order  $m$ . The number of coefficients is  $\frac{1}{2}(m+1)(m+2)$ ; but there is no loss of generality if the equation be divided by one coefficient so as to reduce the coefficient of the corresponding term to unity, hence the number of coefficients may be reckoned as  $\frac{1}{2}(m+1)(m+2) - 1$ , that is,  $\frac{1}{2}m(m+3)$ ; and a curve of the order  $m$  may be made to satisfy this number of conditions; for example, to pass through  $\frac{1}{2}m(m+3)$  points.

It is to be remarked that an equation may *break up*; thus a

quadric equation may be  $(ax + by + c)(a'x + b'y + c') = 0$ , breaking up into the two equations  $ax + by + c = 0$ ,  $a'x + b'y + c' = 0$ , viz. the original equation is satisfied if either of these is satisfied. Each of these last equations represents a curve of the first order, or right line; and the original equation represents this pair of lines, viz. the pair of lines is considered as a quadric curve. But it is an *improper* quadric curve; and in speaking of curves of the second or any other given order, we frequently imply that the curve is a proper curve represented by an equation which does not break up.

4. *Intersections of Curves.*—The intersections of two curves are obtained by combining their equations; viz. the elimination from the two equations of  $y$  (or  $x$ ) gives for  $x$  (or  $y$ ) an equation of a certain order, say the resultant equation; and then to each value of  $x$  (or  $y$ ) satisfying this equation there corresponds in general a single value of  $y$  (or  $x$ ), and consequently a single point of intersection; the number of intersections is thus equal to the order of the resultant equation in  $x$  (or  $y$ ).

Supposing that the two curves are of the orders  $m, n$ , respectively, then the order of the resultant equation is in general and at most  $= mn$ ; in particular, if the curve of the order  $n$  is an arbitrary line ( $n = 1$ ), then the order of the resultant equation is  $= m$ ; and the curve of the order  $m$  meets therefore the line in  $m$  points. But the resultant equation may have all or any of its roots imaginary, and it is thus not always that there are  $m$  real intersections.

The notion of imaginary intersections, thus presenting itself, through algebra, in geometry, must be accepted in geometry;—and it in fact plays an all-important part in modern geometry. As in algebra we say that an equation of the  $m$ th order has  $m$  roots, viz. we state this generally without in the first instance, or it may be without ever, distinguishing whether these are real or imaginary; so in geometry we say that a curve of the  $m$ th order is met by an arbitrary line in  $m$  points, or rather we thus, through algebra, obtain the proper geometrical definition of a curve of the  $m$ th order, as a curve which is met by an arbitrary line in  $m$  points (that is, of course, in  $m$ , and not more than  $m$ , points).

The theorem of the  $m$  intersections has been stated in regard to an *arbitrary* line; in fact, for particular lines the resultant equation may be or appear to be of an order less than  $m$ ; for instance, taking  $m = 2$ , if the hyperbola  $xy - 1 = 0$  be cut by the line  $y = \beta$ , the resultant equation in  $x$  is  $\beta x - 1 = 0$ , and there is apparently only the intersection  $(x = 1/\beta, y = \beta)$ ; but the theorem is, in fact, true for every line whatever: a curve of the order  $m$  meets every line whatever in precisely  $m$  points. We have, in the case just referred to, to take account of a point at infinity on the line  $y = \beta$ ; the two intersections are the point  $(x = 1/\beta, y = \beta)$ , and the point at infinity on the line  $y = \beta$ .

It is, moreover, to be noticed that the points at infinity may be all or any of them imaginary, and that the points of intersection, whether finite or at infinity, real or imaginary, may coincide two or more of them together, and have to be counted accordingly; to support the theorem in its universality, it is necessary to take account of these various circumstances.

5. *Line at Infinity.*—The foregoing notion of a point at infinity is a very important one in modern geometry; and we have also to consider the paradoxical statement that in plane geometry, or say as regards the plane, infinity is a right line. This admits of an easy illustration in solid geometry. If with a given centre of projection, by drawing from it lines to every point of a given line, we project the given line on a given plane, the projection is a line, i.e. this projection is the intersection of the given plane with the plane through the centre and the given line. Say the projection is *always* a line, then if the figure is such that the two planes are parallel, the projection is the intersection of the given plane by a parallel plane, or it is the system of points at infinity on the given plane, that is, these points at infinity are regarded as situate on a given line, the line infinity of the given plane.<sup>1</sup>

<sup>1</sup> In solid geometry infinity is a plane—its intersection with any given plane being the right line which is the infinity of this given plane.

Reverting to the purely plane theory, infinity is a line, related like any other right line to the curve, and thus intersecting it in  $m$  points, real or imaginary, distinct or coincident.

Descartes in the *Géométrie* defined and considered the remarkable curves called after him the ovals of Descartes, or simply Cartesians, which will be again referred to. The next important work, founded on the *Géométrie*, was Sir Isaac Newton's *Enumeratio linearum tertii ordinis* (1706), establishing a classification of cubic curves founded chiefly on the nature of their infinite branches, which was in some details completed by James Stirling (1692-1770), Patrick Murdoch (d. 1774) and Gabriel Cramer; the work also contains the remarkable theorem (to be again referred to), that there are five kinds of cubic curves giving by their projections every cubic curve whatever. Various properties of curves in general, and of cubic curves, are established in Colin Maclaurin's memoir, "De linearum geometricarum proprietatibus generalibus Tractatus" (posthumous, say 1746, published in the 6th edition of his *Algebra*). We have in it a particular kind of correspondence of two points on a cubic curve, viz. two points correspond to each other when the tangents at the two points, again meet the cubic in the same point.

6. *Reciprocal Polars. Intersections of Circles. Duality. Trilinear and Tangential Co-ordinates.*—The *Géométrie descriptive*, by Gaspard Monge, was written in the year 1794 or 1795 (7th edition, Paris, 1847), and in it we have stated, *in plano* with regard to the circle, and in three dimensions with regard to a surface of the second order, the fundamental theorem of reciprocal polars, viz. "Given a surface of the second order and a circumscribed conic surface which touches it . . . then if the conic surface moves so that its summit is always in the same plane, the plane of the curve of contact passes always through the same point." The theorem is here referred to partly on account of its bearing on the theory of imaginaries in geometry. It is in Charles Julian Brianchon's memoir "Sur les surfaces du second degré" (*Jour. Polyt.* t. vi. 1806) shown how for any given position of the summit the plane of contact is determined, or reciprocally; say the plane XY is determined when the point P is given, or reciprocally; and it is noticed that when P is situate in the interior of the surface the plane XY does not cut the surface; that is, we have a real plane XY intersecting the surface in the imaginary curve of contact of the imaginary circumscribed cone having for its summit a given real point P inside the surface.

Stating the theorem in regard to a conic, we have a real point P (called the pole) and a real line XY (called the polar), the line joining the two (real or imaginary) points of contact of the (real or imaginary) tangents drawn from the point to the conic; and the theorem is that when the point describes a line the line passes through a point, this line and point being polar and pole to each other. The term "pole" was first used by François Joseph Servois, and "polar" by Joseph Diez Gergonne (*Gerg.* t. i. and iii., 1810-1813); and from the theorem we have the method of reciprocal polars for the transformation of geometrical theorems, used already by Brianchon (in the memoir above referred to) for the demonstration of the theorem called by his name, and in a similar manner by various writers in the earlier volumes of Gergonne. We are here concerned with the method less in itself than as leading to the general notion of duality.

Bearing in a somewhat similar manner also on the theory of imaginaries in geometry (but the notion presents itself in a more explicit form), there is the memoir by L. Gaultier, on the graphical construction of circles and spheres (*Jour. Polyt.* t. ix., 1813). The well-known theorem as to radical axes may be stated as follows. Consider two circles partially drawn so that it does not appear whether the circles, if completed, would or would not intersect in real points, say two arcs of circles; then we can, by means of a third circle drawn so as to intersect in two real points each of the two arcs, determine a right line, which, if the complete circles intersect in two real points, passes through the points, and which is on this account regarded as a line passing through two (real or imaginary) points of intersection of the two circles. The construction in fact is, join the two

points in which the third circle meets the first arc, and join also the two points in which the third circle meets the second arc, and from the point of intersection of the two joining lines, let fall a perpendicular on the line joining the centre of the two circles; this perpendicular (considered as an indefinite line) is what Gaultier terms the "radical axis of the two circles"; it is a line determined by a real construction and itself always real; and by what precedes it is the line joining two (real or imaginary, as the case may be) intersections of the given circles.

The intersections which lie on the radical axis are two out of the four intersections of the two circles. The question as to the remaining two intersections did not present itself to Gaultier; but it is answered in Jean Victor Poncelet's *Traité des propriétés projectives* (1822), where we find (p. 49) the statement, "deux cercles placés arbitrairement sur un plan . . . ont idéalement deux points imaginaires communs à l'infini"; that is, a circle *qua* curve of the second order is met by the line infinity in two points; but, more than this; they are the same two points for any circle whatever. The points in question have since been called (it is believed first by Dr George Salmon) the circular points at infinity, or they may be called the circular points; these are also frequently spoken of as the points I, J; and we have thus the circle characterized as a conic which passes through the two circular points at infinity; the number of conditions thus imposed upon the conic is = 2, and there remain three arbitrary constants, which is the right number for the circle. Poncelet throughout his work makes continual use of the foregoing theories of imaginaries and infinity, and also of the before-mentioned theory of reciprocal polars.

Poncelet's two memoirs *Sur les centres des moyennes harmoniques* and *Sur la théorie générale des polaires réciproques*, although presented to the Paris Academy in 1824, were only published (*Crelle*, t. iii. and iv., 1828, 1829) subsequent to the memoir by Gergonne, *Considérations philosophiques sur les élémens de la science de l'étendue* (*Gerg.* t. xvi., 1825-1826). In this memoir by Gergonne, the theory of duality is very clearly and explicitly stated; for instance, we find "dans la géométrie plane; à chaque théorème il en répond nécessairement un autre qui s'en déduit en échangeant simplement entre eux les deux mots *points* et *droites*; tandis que dans la géométrie de l'espace ce sont les mots *points* et *plans* qu'il faut échanger entre eux pour passer d'un théorème à son corrélatif"; and the plan is introduced of printing correlative theorems, opposite to each other, in two columns. There was a reclamation as to priority by Poncelet in the *Bulletin universel* reprinted with remarks by Gergonne (*Gerg.* t. xix., 1827), and followed by a short paper by Gergonne, *Rectifications de quelques théorèmes, &c.*, which is important as first introducing the word *class*. We find in it explicitly the two correlative definitions: "a plane curve is said to be of the  $m$ th degree (order) when it has with a line  $m$  real or ideal intersections," and "a plane curve is said to be of the  $m$ th class when from any point of its plane there can be drawn to it  $m$  real or ideal tangents."

It may be remarked that in Poncelet's memoir on reciprocal polars, above referred to, we have the theorem that the number of tangents from a point to a curve of the order  $m$ , or say the class of the curve, is in general and at most =  $m(m-1)$ , and that he mentions that this number is subject to reduction when the curve has double points or cusps.

The theorem of duality as regards plane figures may be thus stated: two figures may correspond to each other in such manner that to each point and line in either figure there correspond in the other figure a line and point respectively. It is to be understood that the theorem extends to all points or lines, drawn or not drawn; thus if in the first figure there are any number of points on a line drawn or not drawn, the corresponding lines in the second figure, produced if necessary, must meet in a point. And we thus see how the theorem extends to curves; their points and tangents; if there is in the first figure a curve of the order  $m$ , any line meets it in  $m$  points; and hence from the corresponding point in the second figure there must be to the corresponding curve  $m$  tangents; that is, the corresponding curve must be of the class  $m$ .



Trilinear co-ordinates (see GEOMETRY: *Analytical*) were first used by E. E. Bobillier in the memoir *Essai sur un nouveau mode de recherche des propriétés de l'étendue* (Gerg. t. xviii., 1827-1828). It is convenient to use these rather than Cartesian co-ordinates. We represent a curve of the order  $m$  by an equation  $(*\!\!\int x, y, z)^m = 0$ , the function on the left hand being a homogeneous rational and integral function of the order  $m$  of the three co-ordinates  $(x, y, z)$ ; clearly the number of constants is the same as for the equation  $(*\!\!\int x, y, z)^m = 0$  in Cartesian co-ordinates.

The theorem of duality is considered and developed, but chiefly in regard to its metrical applications, by Michel Chasles in the *Mémoire de géométrie sur deux principes généraux de la science, la dualité et l'homographie*, which forms a sequel to the *Aperçu historique sur l'origine et le développement des méthodes en géométrie* (Mém. de Brux. t. xi., 1837).

We now come to Julius Plücker; his "six equations" were given in a short memoir in *Crelle* (1842) preceding his great work, the *Theorie der algebraischen Curven* (1844). Plücker first gave a scientific dual definition of a curve, viz.; "A curve is a locus generated by a point, and enveloped by a line—the point moving continuously along the line, while the line rotates continuously about the point"; the point is a point (ineunt.) of the curve, the line is a tangent of the curve. And, assuming the above theory of geometrical imaginaries, a curve such that  $m$  of its points are situate in an arbitrary line is said to be of the order  $m$ ; a curve such that  $n$  of its tangents pass through an arbitrary point is said to be of the class  $n$ ; as already appearing, this notion of the order and class of a curve is, however, due to Gergonne. Thus the line is a curve of the order 1 and class 0; and corresponding dually thereto, we have the point as a curve of the order 0 and class 1.

Plücker, moreover, imagined a system of line-co-ordinates (tangential co-ordinates). (See GEOMETRY: *Analytical*.) The Cartesian co-ordinates  $(x, y)$  and trilinear co-ordinates  $(x, y, z)$  are point-co-ordinates for determining the position of a point; the new co-ordinates, say  $(\xi, \eta, \zeta)$  are line-co-ordinates for determining the position of a line. It is possible, and (not so much for any application thereof as in order to more fully establish the analogy between the two kinds of co-ordinates) important, to give independent quantitative definitions of the two kinds of co-ordinates; but we may also derive the notion of line-co-ordinates from that of point-co-ordinates; viz. taking  $\xi x + \eta y + \zeta z = 0$  to be the equation of a line, we say that  $(\xi, \eta, \zeta)$  are the line-co-ordinates of this line. A linear relation  $a\xi + b\eta + c\zeta = 0$  between these co-ordinate determines a point, viz. the point whose point-co-ordinates are  $(a, b, c)$ ; in fact, the equation in question  $a\xi + b\eta + c\zeta = 0$  expresses that the equation  $\xi x + \eta y + \zeta z = 0$ , where  $(x, y, z)$  are current point-co-ordinates, is satisfied on writing therein  $x, y, z = a, b, c$ ; or that the line in question passes through the point  $(a, b, c)$ . Thus  $(\xi, \eta, \zeta)$  are the line-co-ordinates of any line whatever; but when these, instead of being absolutely arbitrary, are subject to the restriction  $a\xi + b\eta + c\zeta = 0$ , this obliges the line to pass through a point  $(a, b, c)$ ; and the last-mentioned equation  $a\xi + b\eta + c\zeta = 0$  is considered as the line-equation of this point.

A line has only a point-equation, and a point has only a line-equation; but any other curve has a point-equation and also a line-equation; the point-equation  $(*\!\!\int x, y, z)^m = 0$  is the relation which is satisfied by the point-co-ordinates  $(x, y, z)$  of each point of the curve; and similarly the line-equation  $(*\!\!\int \xi, \eta, \zeta)^n = 0$  is the relation which is satisfied by the line-co-ordinates  $(\xi, \eta, \zeta)$  of each line (tangent) of the curve.

There is in analytical geometry little occasion for any explicit use of line-co-ordinates; but the theory is very important; it serves to show that in demonstrating by point-co-ordinates any purely descriptive theorem whatever, we demonstrate the correlative theorem; that is, we do not demonstrate the one theorem, and then (as by the method of reciprocal polars) deduce from it the other, but we do at one and the same time demonstrate the two theorems; our  $(x, y, z)$  instead of meaning point-co-ordinates may mean line-co-ordinates, and the demonstration is then in every step of it a demonstration of the correlative theorem.

7. *Singularities of a Curve. Plücker's Equations.*—The above dual generation explains the nature of the singularities of a plane curve. The ordinary singularities, arranged according to a cross division, are

	<i>Proper.</i>	<i>Improper.</i>
Point-singularities—	{ 1. The stationary point, cusp or spinode;	2. The double point or node;
Line-singularities—		
	{ 3. The stationary tangent or inflection;	4. The double tangent;

arising as follows:—

1. The cusp: the point as it travels along the line may come to rest, and then reverse the direction of its motion.
3. The stationary tangent: the line may in the course of its rotation come to rest, and then reverse the direction of its rotation.
2. The node: the point may in the course of its motion come to coincide with a former position of the point, the two positions of the line not in general coinciding.
4. The double tangent: the line may in the course of its motion come to coincide with a former position of the line, the two positions of the point not in general coinciding.

It may be remarked that we cannot with a real point and line obtain the node with two imaginary tangents (conjugate or isolated point or acnode), nor again the real double tangent with two imaginary points of contact; but this is of little consequence, since in the general theory the distinction between real and imaginary is not attended to.

The singularities (1) and (3) have been termed proper singularities, and (2) and (4) improper; in each of the first-mentioned cases there is a real singularity, or peculiarity in the motion; in the other two cases there is not; in (2) there is not when the point is first at the node, or when it is secondly at the node, any peculiarity in the motion; the singularity consists in the point coming twice into the same position; and so in (4) the singularity is in the line coming twice into the same position. Moreover (1) and (2) are, the former a proper singularity, and the latter an improper singularity, *as regards the motion of the point*; and similarly (3) and (4) are, the former a proper singularity, and the latter an improper singularity, *as regards the motion of the line*.

But as regards the representation of a curve by an equation, the case is very different.

First, if the equation be in point-co-ordinates, (3) and (4) are in a sense not singularities at all. The curve  $(*\!\!\int x, y, z)^m = 0$ , or general curve of the order  $m$ , has double tangents and inflections; (2) presents itself as a singularity, for the equations  $d_x(*\!\!\int x, y, z)^m = 0, d_y(*\!\!\int x, y, z)^m = 0, d_z(*\!\!\int x, y, z)^m = 0$ , implying  $(*\!\!\int x, y, z)^m = 0$ , are not in general satisfied by any values  $(a, b, c)$  whatever of  $(x, y, z)$ , but if such values exist, then the point  $(a, b, c)$  is a node or double point; and (1) presents itself as a further singularity or sub-case of (2), a cusp being a double point for which the two tangents becomes coincident.

In line-co-ordinates all is reversed:—(1) and (2) are not singularities; (3) presents itself as a sub-case of (4).

The theory of compound singularities will be referred to farther on.

In regard to the ordinary singularities, we have

$m$	the order,
$n$	„ class,
$\delta$	„ number of double points,
$\kappa$	„ „ cusps,
$\tau$	„ „ double tangents,
$\iota$	„ „ inflections;

and this being so, Plücker's "six equations" are

- (1)  $n = m(m-1) - 2\delta - 3\kappa,$
- (2)  $\iota = 3m(m-2) - 6\delta - 8\kappa,$
- (3)  $\tau = \frac{1}{2}m(m-2)(m^2-9) - (m^2-m-6)(2\delta+3\kappa) + 2\delta(\delta-1) + 6\delta\kappa + \frac{1}{2}\kappa(\kappa-1),$
- (4)  $m = n(n-1) - 2\tau - 3\iota,$
- (5)  $\kappa = 3n(n-2) - 6\tau - 8\iota,$
- (6)  $\delta = \frac{1}{2}n(n-2)(n^2-9) - (n^2-n-6)(2\tau+3\iota) + 2\tau(\tau-1) + 6\tau\iota + \frac{1}{2}\iota(\iota-1).$

It is easy to derive the further forms—

- (7)  $\iota - \kappa = 3(n-m),$
- (8)  $2(\tau - \delta) = (n-m)(n+m-9),$
- (9)  $\frac{1}{2}m(m+3) - \delta - 2\kappa = \frac{1}{2}n(n+3) - \tau - 2\iota,$
- (10)  $\frac{1}{2}(m-1)(m-2) - \delta - \kappa = \frac{1}{2}(n-1)(n-2) - \tau - \iota,$
- (11, 12)  $m^2 - 2\delta - 3\kappa = n^2 - 2\tau - 3\iota, = m + n,$

the whole system being equivalent to three equations only; and it may be added that using  $a$  to denote the equal quantities  $3m + \iota$  and  $3n + \kappa$  everything may be expressed in terms of  $m, n, a$ . We have

$$\begin{aligned} \kappa &= a - 3n, \\ \iota &= a - 3m, \\ 2\delta &= m^2 - m + 8n - 3a, \\ 2\tau &= n^2 - n + 8m - 3a. \end{aligned}$$

It is implied in Plücker's theorem that,  $m, n, \delta, \kappa, \tau, \iota$  signifying as above in regard to any curve, then in regard to the reciprocal curve,  $n, m, \tau, \iota, \delta, \kappa$  will have the same significations, viz. for the reciprocal curve these letters denote respectively the order, class, number of nodes, cusps, double tangent and inflections.

The expression  $\frac{1}{2} m(m+3) - \delta - 2\kappa$  is that of the number of the disposable constants in a curve of the order  $m$  with  $\delta$  nodes and  $\kappa$  cusps (in fact that there shall be a node is 1 condition, a cusp 2 conditions) and the equation (9) thus expresses that the curve and its reciprocal contain each of them the same number of disposable constants.

For a curve of the order  $m$ , the expression  $\frac{1}{2} m(m-1) - \delta - \kappa$  is termed the "deficiency" (as to this more hereafter); the equation (10) expresses therefore that the curve and its reciprocal have each of them the same deficiency.

The relations  $m^2 - 2\delta - 3\kappa = n^2 - 2\tau - 3\iota = m + n$ , present themselves in the theory of envelopes, as will appear farther on.

With regard to the demonstration of Plücker's equations it is to be remarked that we are not able to write down the equation in point-co-ordinates of a curve of the order  $m$ , having the given numbers  $\delta$  and  $\kappa$  of nodes and cusps. We can only use the general equation  $(x, y, z)^m = 0$ , say for shortness  $u = 0$ , of a curve of the  $m$ th order, which equation, so long as the coefficients remain arbitrary, represents a curve without nodes or cusps. Seeking then, for this curve, the values,  $n, \iota, \tau$  of the class, number of inflections, and number of double tangents,—first, as regards the class, this is equal to the number of tangents which can be drawn to the curve from an arbitrary point, or what is the same thing, it is equal to the number of the points of contact of these tangents. The points of contact are found as the intersections of the curve  $u = 0$  by a curve depending on the position of the arbitrary point, and called the "first polar" of this point; the order of the first polar is  $= m - 1$ , and the number of intersections is thus  $= m(m-1)$ . But it can be shown, analytically or geometrically, that if the given curve has a node, the first polar passes through this node, which therefore counts as two intersections, and that if the curve has a cusp, the first polar passes through the cusp, touching the curve there, and hence the cusp counts as three intersections. But, as is evident, the node or cusp is not a point of contact of a proper tangent from the arbitrary point; we have, therefore, for a node a diminution 2, and for a cusp a diminution 3, in the number of the intersections; and thus, for a curve with  $\delta$  nodes and  $\kappa$  cusps, there is a diminution  $2\delta + 3\kappa$ , and the value of  $n$  is  $n = m(m-1) - 2\delta - 3\kappa$ .

Secondly, as to the inflections, the process is a similar one; it can be shown that the inflections are the intersections of the curve by a derivative curve called (after Ludwig Otto Hesse who first considered it) the Hessian, defined geometrically as the locus of a point such that its conic polar (§ 8 below) in regard to the curve breaks up into a pair of lines, and which has an equation  $H = 0$ , where  $H$  is the determinant formed with the second differential coefficients of  $u$  in regard to the variables  $(x, y, z)$ ;  $H = 0$  is thus a curve of the order  $3(m-2)$ , and the number of inflections is  $= 3m(m-2)$ . But if the given curve has a node, then not only the Hessian passes through the node, but it has there a node the two branches at which touch respectively the two branches of the curve; and the node thus counts as six intersections; so if the curve has a cusp, then the Hessian not only passes through the cusp, but it has there a cusp through which it again passes, that is, there is a cuspidal branch touching the cuspidal branch of the curve, and besides a simple branch passing through the cusp, and hence the cusp counts as eight intersections. The node or cusp is not an inflection, and we have thus for a node a diminution 6, and for a cusp a diminution 8, in the number of the intersections; hence for a curve with  $\delta$  nodes and  $\kappa$  cusps, the diminution is  $= 6\delta + 8\kappa$ , and the number of inflections is  $\iota = 3m(m-2) - 6\delta - 8\kappa$ .

Thirdly, for the double tangents; the points of contact of

these are obtained as the intersections of the curve by a curve  $\Pi = 0$ , which has not as yet been geometrically defined, but which is found analytically to be of the order  $(m-2)(m^2-9)$ ; the number of intersections is thus  $= m(m-2)(m^2-9)$ ; but if the given curve has a node then there is a diminution  $= 4(m^2-m-6)$ , and if it has a cusp then there is a diminution  $= 6(m^2-m-6)$ , where, however, it is to be noticed that the factor  $(m^2-m-6)$  is in the case of a curve having only a node or only a cusp the number of the tangents which can be drawn from the node or cusp to the curve, and is used as denoting the number of these tangents, and ceases to be the correct expression if the number of nodes and cusps is greater than unity. Hence, in the case of a curve which has  $\delta$  nodes and  $\kappa$  cusps, the apparent diminution  $2(m^2-m-6)(2\delta+3\kappa)$  is too great, and it has in fact to be diminished by  $2\{2\delta(\delta-1) + 6\delta\kappa + \frac{3}{2}\kappa(\kappa-1)\}$ , or the half thereof is 4 for each pair of nodes, 6 for each combination of a node and cusp, and 9 for each pair of cusps. We have thus finally an expression for  $2\tau = m(m-2)(m^2-9) - \&c.$ ; or dividing the whole by 2, we have the expression for  $\tau$  given by the third of Plücker's equations.

It is obvious that we cannot by consideration of the equation  $u = 0$  in point-co-ordinates obtain the remaining three of Plücker's equations; they might be obtained in a precisely analogous manner by means of the equation  $v = 0$  in line-co-ordinates, but they follow at once from the principle of duality, viz. they are obtained by the mere interchange of  $m, \delta, \kappa$ , with  $n, \tau, \iota$  respectively.

To complete Plücker's theory it is necessary to take account of compound singularities; it might be possible, but it is at any rate difficult, to effect this by considering the curve as in course of description by the point moving along the rotating line; and it seems easier to consider the compound singularity as arising from the variation of an actually described curve with ordinary singularities. The most simple case is when three double points come into coincidence, thereby giving rise to a triple point; and a somewhat more complicated one is when we have a cusp of the second kind, or node-cusp arising from the coincidence of a node, a cusp, an inflection, and a double tangent, as shown in the annexed figure, which represents the singularities as on the

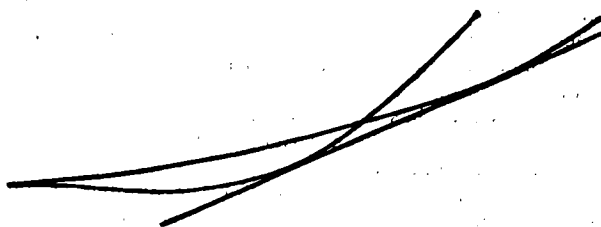

point of coalescing. The general conclusion (see Cayley, *Quart. Math. Jour.* t. vii., 1866, "On the higher singularities of plane curves"; *Collected Works*, v. 520) is that every singularity whatever may be considered as compounded of ordinary singularities, say we have a singularity  $= \delta'$  nodes,  $\kappa'$  cusps,  $\tau'$  double tangents and  $\iota'$  inflections. So that, in fact, Plücker's equations properly understood apply to a curve with any singularities whatever.

By means of Plücker's equations we may form a table—

$m$	$n$	$\delta$	$\kappa$	$\tau$	$\iota$
0	1	—	—	0	0
1	0	0	0	—	—
2	2	0	0	0	0
3	6	0	0	0	9
"	4	1	0	0	3
"	3	0	1	0	1
4	12	0	0	28	24
"	10	1	0	16	18
"	9	0	1	10	16
"	8	2	0	8	12
"	7	1	1	4	10
"	6	0	2	1	8
"	6	3	0	4	6
"	5	2	1	2	4
"	4	1	2	1	2
"	3	0	3	1	0

The table is arranged according to the value of  $m$ ; and we have  $m=0$ ,  $n=1$ , the point;  $m=1$ ,  $n=0$ , the line;  $m=2$ ,  $n=2$ , the conic; of  $m=3$ , the cubic, there are three cases, the class being 6, 4 or 3, according as the curve is without singularities, or as it has 1 node or 1 cusp; and so of  $m=4$ , the quartic, there are ten cases, where observe that in two of them the class is =6,—the reduction of class arising from two cusps or else from three nodes. The ten cases may be also grouped together into four, according as the number of nodes and cusps ( $\delta+\kappa$ ) is =0, 1, 2 or 3.

The cases may be divided into sub-cases, by the consideration of compound singularities; thus when  $m=4$ ,  $n=6$ ,  $\delta=3$ , the three nodes may be all distinct, which is the general case, or two of them may unite together into the singularity called a tacnode, or all three may unite together into a triple point or else into an oscnode.

We may further consider the inflections and double tangents, as well in general as in regard to cubic and quartic curves.

The expression for the number of inflections  $3m(m-2)$  for a curve of the order  $m$  was obtained analytically by Plücker, but the theory was first given in a complete form by Hesse in the two papers "Über die Elimination, u.s.w.," and "Über die Wendepuncte der Curven dritter Ordnung" (*Crelle*, t. xxviii., 1844); in the latter of these the points of inflection are obtained as the intersections of the curve  $u=0$  with the Hessian, or curve  $\Delta=0$ , where  $\Delta$  is the determinant formed with the second derived functions of  $u$ . We have in the Hessian the first instance of a covariant of a ternary form. The whole theory of the inflections of a cubic curve is discussed in a very interesting manner by means of the canonical form of the equation  $x^3+y^3+z^3+6xyz=0$ ; and in particular a proof is given of Plücker's theorem that the nine points of inflection of a cubic curve lie by threes in twelve lines.

It may be noticed that the nine inflections of a cubic curve represented by an equation with real coefficients are three real, six imaginary; the three real inflections lie in a line, as was known to Newton and Maclaurin. For an acnodal cubic the six imaginary inflections disappear, and there remain three real inflections lying in a line. For a crunodal cubic the six inflections which disappear are two of them real, the other four imaginary, and there remain two imaginary inflections and one real inflection. For a cuspidal cubic the six imaginary inflections and two of the real inflections disappear, and there remains one real inflection.

A quartic curve has 24 inflections; it was conjectured by George Salmon, and has been verified by H. G. Zeuthen that at most eight of these are real.

The expression  $\frac{1}{2}m(m-2)(m^2-9)$  for the number of double tangents of a curve of the order  $m$  was obtained by Plücker only as a consequence of his first, second, fourth and fifth equations. An investigation by means of the curve  $\Pi=0$ , which by its intersections with the given curve determines the points of contact of the double tangents, is indicated by Cayley, "Recherches sur l'élimination et la théorie des courbes" (*Crelle*, t. xxxiv., 1847; *Collected Works*, vol. i. p. 337), and in part carried out by Hesse in the memoir "Über Curven dritter Ordnung" (*Crelle*, t. xxxvi., 1848). A better process was indicated by Salmon in the "Note on the Double Tangents to Plane Curves," *Phil. Mag.*, 1858; considering the  $m-2$  points in which any tangent to the curve again meets the curve, he showed how to form the equation of a curve of the order  $(m-2)$ , giving by its intersection with the tangent the points in question; making the tangent touch this curve of the order  $(m-2)$ , it will be a double tangent of the original curve. See Cayley, "On the Double Tangents of a Plane Curve" (*Phil. Trans.* t. cxlviii., 1859; *Collected Works*, iv. 186), and O. Dersch (*Math. Ann.* t. vii., 1874). The solution is still in so far incomplete that we have no properties of the curve  $\Pi=0$ , to distinguish one such curve from the several other curves which pass through the points of contact of the double tangents.

A quartic curve has 28 double tangents, their points of contact determined as the intersections of the curve by a curve  $\Pi=0$  of the order 14, the equation of which in a very elegant form was first obtained by Hesse (1849). Investigations in regard to them

are given by Plücker in the *Theorie der algebraischen Curven*, and in two memoirs by Hesse and Jacob Steiner (*Crelle*, t. xlv., 1855), in respect to the triads of double tangents which have their points of contact on a conic and other like relations. It was assumed by Plücker that the number of real double tangents might be 28, 16, 8, 4 or 0, but Zeuthen has found that the last case does not exist.

8. *Invariants and Covariants. Polar Curves.*—The Hessian  $\Delta$  has just been spoken of as a covariant of the form  $u$ ; the notion of invariants and covariants belongs rather to the form  $u$  than to the curve  $u=0$  represented by means of this form; and the theory may be very briefly referred to. A curve  $u=0$  may have some invariative property, viz. a property independent of the particular axes of co-ordinates used in the representation of the curve by its equation; for instance, the curve may have a node, and in order to this, a relation, say  $A=0$ , must exist between the coefficients of the equation; supposing the axes of co-ordinates altered, so that the equation becomes  $u'=0$ , and writing  $A'=0$  for the relation between the new coefficients, then the relations  $A=0$ ,  $A'=0$ , as two different expressions of the same geometrical property, must each of them imply the other; this can only be the case when  $A$ ,  $A'$  are functions differing only by a constant factor, or say, when  $A$  is an invariant of  $u$ . If, however, the geometrical property requires two or more relations between the coefficients, say  $A=0$ ,  $B=0$ , &c., then we must have between the new coefficients the like relations,  $A'=0$ ,  $B'=0$ , &c., and the two systems of equations must each of them imply the other; when this is so, the system of equations,  $A=0$ ,  $B=0$ , &c., is said to be invariative, but it does not follow that  $A$ ,  $B$ , &c., are of necessity invariants of  $u$ . Similarly, if we have a curve  $U=0$  derived from the curve  $u=0$  in a manner independent of the particular axes of co-ordinates, then from the transformed equation  $u'=0$  deriving in like manner the curve  $U'=0$ , the two equations  $U=0$ ,  $U'=0$  must each of them imply the other; and when this is so,  $U$  will be a covariant of  $u$ . The case is less frequent, but it may arise, that there are covariant systems  $U=0$ ,  $V=0$ , &c., and  $U'=0$ ,  $V'=0$ , &c., each implying the other, but where the functions  $U$ ,  $V$ , &c., are not of necessity covariants of  $u$ .

If we take a fixed point  $(x', y', z')$  and a curve  $u=0$  of order  $m$ , and suppose the axes of reference altered, so that  $x'$ ,  $y'$ ,  $z'$  are linearly transformed in the same way as the current  $x$ ,  $y$ ,  $z$ , the curves  $(x' \frac{\partial}{\partial x} + y' \frac{\partial}{\partial y} + z' \frac{\partial}{\partial z})^r u=0$ , ( $r=1, 2, \dots, m-1$ ) have the covariant property. They are the polar curves of the point with regard to  $u=0$ .

The theory of the invariants and covariants of a ternary cubic function  $u$  has been studied in detail, and brought into connexion with the cubic curve  $u=0$ ; but the theory of the invariants and covariants for the next succeeding case, the ternary quartic function, is still very incomplete.

9. *Envelope of a Curve.*—In further illustration of the Plückerian dual generation of a curve, we may consider the question of the envelope of a variable curve. The notion is very probably older, but it is at any rate to be found in Lagrange's *Théorie des fonctions analytiques* (1798); it is there remarked that the equation obtained by the elimination of the parameter  $a$  from an equation  $f(x, y, a)=0$  and the derived equation in respect to  $a$  is a curve, the envelope of the series of curves represented by the equation  $f(x, y, a)=0$  in question. To develop the theory, consider the curve corresponding to any particular value of the parameter; this has with the consecutive curve (or curve belonging to the consecutive value of the parameter) a certain number of intersections and of common tangents, which may be considered as the tangents at the intersections; and the so-called envelope is the curve which is at the same time generated by the points of intersection and enveloped by the common tangents; we have thus a dual generation. But the question needs to be further examined. Suppose that in general the variable curve is of the order  $m$  with  $\delta$  nodes and  $\kappa$  cusps, and therefore of the class  $n$  with  $\tau$  double tangents and  $\iota$  inflections,  $m$ ,  $n$ ,  $\delta$ ,  $\kappa$ ,  $\tau$ ,  $\iota$  being connected by the Plückerian equations,—the number of nodes or cusps may be

greater for particular values of the parameter, but this is a speciality which may be here disregarded. Considering the variable curve corresponding to a given value of the parameter, or say simply the variable curve, the consecutive curve has then also  $\delta$  and  $\kappa$  nodes and cusps, consecutive to those of the variable curve; and it is easy to see that among the intersections of the two curves we have the nodes each counting twice, and the cusps each counting three times; the number of the remaining intersections is  $=m^2-2\delta-3\kappa$ . Similarly among the common tangents of the two curves we have the double tangents each counting twice, and the stationary tangents each counting three times, and the number of the remaining common tangents is  $=n^2-2\tau-3\iota$  ( $=m^2-2\delta-3\kappa$ , inasmuch as each of these numbers is as was seen  $=m+n$ ). At any one of the  $m^2-2\delta-3\kappa$  points the variable curve and the consecutive curve have tangents distinct from yet infinitesimally near to each other, and each of these two tangents is also infinitesimally near to one of the  $n^2-2\tau-3\iota$  common tangents of the two curves; whence, attending only to the variable curve, and considering the consecutive curve as coming into actual coincidence with it, the  $n^2-2\tau-3\iota$  common tangents are the tangents to the variable curve at the  $m^2-2\delta-3\kappa$  points respectively, and the envelope is at the same time generated by the  $m^2-2\delta-3\kappa$  points, and enveloped by the  $n^2-2\tau-3\iota$  tangents; we have thus a dual generation of the envelope, which only differs from Plücker's dual generation, in that in place of a single point and tangent we have the group of  $m^2-2\delta-3\kappa$  points and  $n^2-2\tau-3\iota$  tangents.

The parameter which determines the variable curve may be given as a point upon a given curve, or say as a parametric point; that is, to the different positions of the parametric point on the given curve correspond the different variable curves, and the nature of the envelope will thus depend on that of the given curve; we have thus the envelope as a derivative curve of the given curve. Many well-known derivative curves present themselves in this manner; thus the variable curve may be the normal (or line at right angles to the tangent) at any point of the given curve; the intersection of the consecutive normals is the centre of curvature; and we have the evolute as at once the locus of the centre of curvature and the envelope of the normal. It may be added that the given curve is one of a series of curves, each cutting the several normals at right angles. Any one of these is a "parallel" of the given curve; and it can be obtained as the envelope of a circle of constant radius having its centre on the given curve. We have in like manner, as derivatives of a given curve, the caustic, catacaustic or diacaustic as the case may be, and the secondary caustic, or curve cutting at right angles the reflected or refracted rays.

10. *Forms of Real Curves.*—We have in much that precedes disregarded, or at least been indifferent to, reality; it is only thus that the conception of a curve of the  $m$ -th order, as one which is met by every right line in  $m$  points, is arrived at; and the curve itself, and the line which cuts it, although both are tacitly assumed to be real, may perfectly well be imaginary. For real figures we have the general theorem that imaginary intersections, &c., present themselves in conjugate pairs; hence, in particular, that a curve of an even order is met by a line in an even number (which may be  $=0$ ) of points; a curve of an odd order in an odd number of points, hence in one point at least; it will be seen further on that the theorem may be generalized in a remarkable manner. Again, when there is in question only one pair of points or lines, these, if coincident, must be real; thus, a line meets a cubic curve in three points, one of them real, and other two real or imaginary; but if two of the intersections coincide they must be real, and we have a line cutting a cubic in one real point and touching it in another real point. It may be remarked that this is a limit separating the two cases where the intersections are all real, and where they are one real, two imaginary.

Considering always real curves, we obtain the notion of a branch; any portion capable of description by the continuous motion of a point is a branch; and a curve consists of one or more branches. Thus the curve of the first order or right line

consists of one branch; but in curves of the second order, or conics, the ellipse and the parabola consist each of one branch, the hyperbola of two branches. A branch is either re-entrant, or it extends both ways to infinity, and in this case, we may regard it as consisting of two legs (*crura*, Newton), each extending one way to infinity, but without any definite separation. The branch, whether re-entrant or infinite, may have a cusp or cusps, or it may cut itself or another branch, thus having or giving rise to crunodes or double points with distinct real tangents; an acnode, or double point with imaginary tangents, is a branch by itself, or it may be considered as an indefinitely small re-entrant branch. A branch may have inflections and double tangents, or there may be double tangents which touch two distinct branches; there are also double tangents with imaginary points of contact, which are thus lines having no visible connexion with the curve. A re-entrant branch not cutting itself may be everywhere convex, and it is then properly said to be an oval; but the term oval may be used more generally for any re-entrant branch not cutting itself; and we may thus speak of a once indented, twice indented oval, &c., or even of a cuspidate oval. Other descriptive names for ovals and re-entrant branches cutting themselves may be used when required; thus, in the last-mentioned case a simple form is that of a figure of eight; such a form may break up into two ovals or into a doubly indented oval or hour-glass. A form which presents itself is when two ovals, one inside the other, unite, so as to give rise to a crunode—in default of a better name this may be called, after the curve of that name, a limaçon (*q.v.*). Names may also be used for the different forms of infinite branches, but we have first to consider the distinction of hyperbolic and parabolic. The leg of an infinite branch may have at the extremity a tangent; this is an asymptote of the curve, and the leg is then hyperbolic; or the leg may tend to a fixed direction, but so that the tangent goes further and further off to infinity, and the leg is then parabolic; a branch may thus be hyperbolic or parabolic as to its two legs; or it may be hyperbolic as to one leg and parabolic as to the other. The epithets hyperbolic and parabolic are of course derived from the conic hyperbola and parabola respectively. The nature of the two kinds of branches is best understood by considering them as projections, in the same way as we in effect consider the hyperbola and the parabola as projections of the ellipse. If a line  $\Omega$  cut an arc  $aa'$  at  $b$ , so that the two segments  $ab, ba'$  lie on opposite sides of the line, then projecting the figure so that the line  $\Omega$  goes off to infinity, the tangent at  $b$  is projected into the asymptote, and the arc  $ab$  is projected into a hyperbolic leg touching the asymptote at one extremity; the arc  $ba'$  will at the same time be projected into a hyperbolic leg touching the same asymptote at the other extremity (and on the opposite side); but so that the two hyperbolic legs may or may not belong to one and the same branch. And we thus see that the two hyperbolic legs belong to a simple intersection of the curve by the line infinity. Next, if the line  $\Omega$  touch at  $b$  the arc  $aa'$  so that the two portions  $ab, ba'$  lie on the same side of the line  $\Omega$ , then projecting the figure as before, the tangent at  $b$ , that is, the line  $\Omega$  itself, is projected to infinity; the arc  $ab$  is projected into a parabolic leg, and at the same time the arc  $ba'$  is projected into a parabolic leg, having at infinity the same direction as the other leg, but so that the two legs may or may not belong to the same branch. And we thus see that the two parabolic legs represent a contact of the line infinity with the curve,—the point of contact being of course the point at infinity determined by the common direction of the two legs. It will readily be understood how the like considerations apply to other cases,—for instance, if the line  $\Omega$  is a tangent at an inflection, passes through a crunode, or touches one of the branches of a crunode, &c.; thus, if the line  $\Omega$  passes through a crunode we have pairs of hyperbolic legs belonging to two parallel asymptotes. The foregoing considerations also show (what is very important) how different branches are connected together at infinity, and lead to the notion of a complete branch or circuit.

The two legs of a hyperbolic branch may belong to different asymptotes, and in this case we have the forms which Newton

calls inscribed, circumscribed, ambigene, &c.; or they may belong to the same asymptote, and in this case we have the serpentine form, where the branch cuts the asymptote, so as to touch it at its two extremities on opposite sides, or the conchoidal form, where it touches the asymptote on the same side. The two legs of a parabolic branch may converge to ultimate parallelism, as in the conic parabola, or diverge to ultimate parallelism, as in the semi-cubical parabola  $y^2 = x^3$ , and the branch is said to be convergent, or divergent, accordingly; or they may tend to parallelism in opposite senses, as in the cubical parabola  $y = x^3$ . As mentioned with regard to a branch generally, an infinite branch of any kind may have cusps, or, by cutting itself or another branch, may have or give rise to a crunode, &c.

11. *Classification of Cubic Curves.*—We may now consider the various forms of cubic curves as appearing by Newton's *Enumeratio*, and by the figures belonging thereto. The species are reckoned as 72, which are numbered accordingly 1 to 72; but to these should be added 10<sup>a</sup>, 13<sup>a</sup>, 22<sup>a</sup> and 22<sup>b</sup>. It is not intended here to consider the division into species, nor even completely that into genera, but only to explain the principle of classification. It may be remarked generally that there are at most three infinite branches, and that there may besides be a re-entrant branch or oval.

The genera may be arranged as follows:—

1,2,3,4	redundant hyperbolas
5,6	defective hyperbolas
7,8	parabolic hyperbolas
9	hyperbolisms of hyperbola
10	" " ellipse
11	" " parabola
12	trident curve
13	divergent parabolas
14	cubic parabola;

and thus arranged they correspond to the different relations of the line infinity to the curve. First, if the three intersections by the line infinity are all distinct, we have the hyperbolas; if the points are real, the redundant hyperbolas, with three hyperbolic branches; but if only one of them is real, the defective hyperbolas, with one hyperbolic branch. Secondly, if two of the intersections coincide, say if the line infinity meets the curve in a onefold point and a twofold point, both of them real, then there is always one asymptote: the line infinity may at the twofold point touch the curve, and we have the parabolic hyperbolas; or the twofold point may be a singular point,—viz., a crunode giving the hyperbolisms of the hyperbola; an acnode, giving the hyperbolisms of the ellipse; or a cusp, giving the hyperbolisms of the parabola. As regards the so-called hyperbolisms, observe that (besides the single asymptote) we have in the case of those of the hyperbola two parallel asymptotes; in the case of those of the ellipse the two parallel asymptotes become imaginary, that is, they disappear; and in the case of those of the parabola they become coincident, that is, there is here an ordinary asymptote, and a special asymptote answering to a cusp at infinity. Thirdly, the three intersections by the line infinity may be coincident and real; or say we have a threefold point: this may be an inflection, a crunode or a cusp, that is, the line infinity may be a tangent at an inflection, and we have the divergent parabolas; a tangent at a crunode to one branch, and we have the trident curve; or lastly, a tangent at a cusp, and we have the cubical parabola.

It is to be remarked that the classification mixes together non-singular and singular curves, in fact, the five kinds presently referred to: thus the hyperbolas and the divergent parabolas include curves of every kind, the separation being made in the species; the hyperbolisms of the hyperbola and ellipse, and the trident curve, are nodal; the hyperbolisms of the parabola, and the cubical parabola, are cuspidal. The divergent parabolas are of five species which respectively belong to and determine the five kinds of cubic curves; Newton gives (in two short paragraphs without any development) the remarkable theorem that the five divergent parabolas by their shadows generate and exhibit all the cubic curves.

The five divergent parabolas are curves each of them symmetrical with regard to an axis. There are two non-singular kinds, the one with, the other without, an oval, but each of them has an infinite (as Newton describes it) *campaniform* branch; this cuts the axis at right angles, being at first concave, but ultimately convex, towards the axis, the two legs continually tending to become at right angles to the axis. The oval may unite itself with the infinite branch, or it may dwindle into a point, and we have the crunodal and the acnodal forms respectively; or if simultaneously the oval dwindles into a point and unites itself to the infinite branch, we have the cuspidal form. (See PARABOLA.) Drawing a line to cut any one of these curves and projecting the line to infinity, it would not be difficult to show how the line should be drawn in order to obtain a curve of any given species. We have herein a better principle of classification; considering cubic curves, in the first instance, according to singularities, the curves are non-singular, nodal (viz. crunodal or acnodal), or cuspidal; and we see further that there are two kinds of non-singular curves, the complex and the simplex. There is thus a complete division into the five kinds, the complex, simplex, crunodal, acnodal and cuspidal. Each singular kind presents itself as a limit separating two kinds of inferior singularity; the cuspidal separates the crunodal and the acnodal, and these last separate from each other the complex and the simplex.

The whole question is discussed very fully and ably by A. F. Möbius in the memoir "Ueber die Grundformen der Linien dritter Ordnung" (*Abh. der K. Sachs. Ges. zu Leipzig*, t. i., 1852). The author considers not only plane curves, but also cones, or, what is almost the same thing, the spherical curves which are their sections by a concentric sphere. Stated in regard to the cone, we have there the fundamental theorem that there are two different kinds of sheets; viz., the single sheet, not separated into two parts by the vertex (an instance is afforded by the plane considered as a cone of the first order generated by the motion of a line about a point), and the double or twin-pair sheet, separated into two parts by the vertex (as in the cone of the second order). And it then appears that there are two kinds of non-singular cubic cones, viz. the simplex, consisting of a single sheet, and the complex, consisting of a single sheet and a twin-pair sheet; and we thence obtain (as for cubic curves) the crunodal, the acnodal and the cuspidal kinds of cubic cones. It may be mentioned that the single sheet is a sort of wavy form, having upon it three lines of inflection, and which is met by any plane through the vertex in one or in three lines; the twin-pair sheet has no lines of inflection, and resembles in its form a cone on an oval base.

In general a cone consists of one or more single or twin-pair sheets, and if we consider the section of the cone by a plane, the curve consists of one or more complete branches, or say circuits, each of them the section of one sheet of the cone; thus, a cone of the second order is one twin-pair sheet, and any section of it is one circuit composed, it may be, of two branches. But although we thus arrive by projection at the notion of a circuit, it is not necessary to go out of the plane, and we may (with Zeuthen, using the shorter term *circuit* for his *complete branch*) define a circuit as any portion (of a curve) capable of description by the continuous motion of a point, it being understood that a passage through infinity is permitted. And we then say that a curve consists of one or more circuits; thus the right line, or curve of the first order, consists of one circuit; a curve of the second order consists of one circuit; a cubic curve consists of one circuit or else of two circuits.

A circuit is met by any right line always in an even number, or always in an odd number, of points, and it is said to be an even circuit or an odd circuit accordingly; the right line is an odd circuit, the conic an even circuit. And we have then the theorem, two odd circuits intersect in an odd number of points; an odd and an even circuit, or two even circuits, in an even number of points. An even circuit not cutting itself divides the plane into two parts, the one called the internal part, incapable of containing any odd circuit, the other called the external part, capable of containing an odd circuit.



We may now state in a more convenient form the fundamental distinction of the kinds of cubic curve. A non-singular cubic is simplex, consisting of one odd circuit, or it is complex, consisting of one odd circuit and one even circuit. It may be added that there are on the odd circuit three inflections, but on the even circuit no inflection; it hence also appears that from any point of the odd circuit there can be drawn to the odd circuit two tangents, and to the even circuit (if any) two tangents, but that from a point of the even circuit there cannot be drawn (either to the odd or the even circuit) any real tangent; consequently, in a simplex curve the number of tangents from any point is two; but in a complex curve the number is four, or none,—four if the point is on the odd circuit, none if it is on the even circuit. It at once appears from inspection of the figure of a non-singular cubic curve, which is the odd and which the even circuit. The singular kinds arise as before; in the crunodal and the cuspidal kinds the whole curve is an odd circuit, but in an acnodal kind the acnode must be regarded as an even circuit.

12. *Quartic Curves.*—The analogous question of the classification of quartics (in particular non-singular quartics and nodal quartics) is considered in Zeuthen's memoir "Sur les différentes formes des courbes planes du quatrième ordre" (*Math. Ann.* t. vii., 1874). A non-singular quartic has only even circuits; it has at most four circuits external to each other, or two circuits one internal to the other, and in this last case the internal circuit has no double tangents or inflections. A very remarkable theorem is established as to the double tangents of such a quartic: distinguishing as a double tangent of the first kind a real double tangent which either twice touches the same circuit, or else touches the curve in two imaginary points, the number of the double tangents of the first kind of a non-singular quartic is  $=4$ ; it follows that the quartic has at most 8 real inflections. The forms of the non-singular quartics are very numerous, but it is not necessary to go further into the question.

We may consider in relation to a curve, not only the line infinity, but also the circular points at infinity; assuming the curve to be real, these present themselves always conjointly; thus a circle is a conic passing through the two circular points, and is thereby distinguished from other conics. Similarly a cubic through the two circular points is termed a circular cubic; a quartic through the two points is termed a circular quartic, and if it passes twice through each of them, that is, has each of them for a node, it is termed a bicircular quartic. Such a quartic is of course binodal ( $m=4$ ,  $\delta=2$ ,  $\kappa=0$ ); it has not in general, but it may have, a third node or a cusp. Or again, we may have a quartic curve having a cusp at each of the circular points: such a curve is a "Cartesian," it being a complete definition of the Cartesian to say that it is a bicuspidal quartic curve ( $m=4$ ,  $\delta=0$ ,  $\kappa=2$ ), having a cusp at each of the circular points. The circular cubic and the bicircular quartic, together with the Cartesian (being in one point of view a particular case thereof), are interesting curves which have been much studied, generally, and in reference to their focal properties.

13. *Foci.*—The points called *foci* presented themselves in the theory of the conic, and were well known to the Greek geometers, but the general notion of a focus was first established by Plücker (in the memoir "Über solche Punkte der bei Curven einer höheren Ordnung den Brennpuncten der Kegelschnitte entsprechen" (*Crelle*, t. x., 1833). We may from each of the circular points draw tangents to a given curve; the intersection of two such tangents (belonging of course to the two circular points respectively) is a focus. There will be from each circular point  $\lambda$  tangents ( $\lambda$ , a number depending on the class of the curve and its relation to the line infinity and the circular points,  $=2$  for the general conic,  $1$  for the parabola,  $2$  for a circular cubic, or bicircular quartic, &c.); the  $\lambda$  tangents from the one circular point and those from the other circular point intersect in  $\lambda$  real foci (viz. each of these is the only real point on each of the tangents through it), and in  $\lambda^2 - \lambda$  imaginary foci; each pair of real foci determines a pair of imaginary foci (the so-called antipoints of the two real foci), and the  $\frac{1}{2}\lambda(\lambda - 1)$  pairs of real foci thus determine the  $\lambda^2 - \lambda$  imaginary foci. There are in some cases

points termed centres, or singular or multiple foci (the nomenclature is unsettled), which are the intersections of improper tangents from the two circular points respectively; thus, in the circular cubic, the tangents to the curve at the two circular points respectively (or two imaginary asymptotes of the curve) meet in a centre.

14. *Distance and Angle. Curves described mechanically.*—The notions of *distance* and of lines at *right angles* are connected with the circular points; and almost every construction of a curve by means of lines of a determinate length, or at right angles to each other, and (as such) mechanical constructions by means of linkwork, give rise to curves passing the same definite number of times through the two circular points respectively, or say to circular curves, and in which the fixed centres of the construction present themselves as ordinary, or as singular, foci. Thus the general curve of three bar-motion (or locus of the vertex of a triangle, the other two vertices whereof move on fixed circles) is a tricircular sextic, having besides three nodes ( $m=6$ ,  $\delta=3+3+3=9$ ), and having the centres of the fixed circles each for a singular focus; there is a third singular focus, and we have thus the remarkable theorem (due to S. Roberts) of the triple generation of the curve by means of the three several pairs of singular foci.

Again, the normal, *qua* line at right angles to the tangent, is connected with the circular points, and these accordingly present themselves in the before-mentioned theories of evolutes and parallel curves.

15. *Theories of Correspondence.*—We have several recent theories which depend on the notion of *correspondence*: two points whether in the same plane or in different planes, or on the same curve or in different curves, may determine each other in such wise that to any given position of the first point there correspond  $a'$  positions of the second point, and to any given position of the second point  $a$  positions of the first point; the two points have then an  $(a, a')$  correspondence; and if  $a, a'$  each  $=1$ , then the two points have a  $(1, 1)$  or rational correspondence. Connecting with each theory the author's name, the theories in question are G. F. B. Riemann, the rational transformation of a plane curve; Luigi Cremona, the rational transformation of a plane; and Chasles, correspondence of points on the same curve, and united points. The theory first referred to, with the resulting notion of "Geschlecht," or *deficiency*, is more than the other two an essential part of the theory of curves, but they will all be considered.

Riemann's results are contained in the memoirs on "Abelian Integrals," &c. (*Crelle*, t. liv., 1857), and we have next R. F. A. Clebsch, "Über die Singularitäten algebraischer Curven" (*Crelle*, t. lxxv., 1865), and Cayley, "On the Transformation of Plane Curves" (*Proc. Lond. Math. Soc.* t. i., 1865; *Collected Works*, vol. vi. p. 1). The fundamental notion of the rational transformation is as follows:—

Taking  $u, X, Y, Z$  to be rational and integral functions ( $X, Y, Z$  all of the same order) of the co-ordinates  $(x, y, z)$ , and  $u', X', Y', Z'$  rational and integral functions ( $X', Y', Z'$  all of the same order) of the co-ordinates  $(x', y', z')$ , we transform a given curve  $u=0$ , by the equations of  $x' : y' : z' = X : Y : Z$ , thereby obtaining a transformed curve  $u'=0$ , and a converse set of equations  $x : y : z = X' : Y' : Z'$ ; viz. assuming that this is so, the point  $(x, y, z)$  on the curve  $u=0$  and the point  $(x', y', z')$  on the curve  $u'=0$  will be points having a  $(1, 1)$  correspondence. To show how this is, observe that to a given point  $(x, y, z)$  on the curve  $u=0$  there corresponds a single point  $(x', y', z')$  determined by the equations  $x' : y' : z' = X : Y : Z$ ; from these equations and the equation  $u=0$  eliminating  $x, y, z$ , we obtain the equation  $u'=0$  of the transformed curve. To a given point  $(x', y', z')$  not on the curve  $u'=0$  there corresponds, not a single point, but the system of points  $(x, y, z)$  given by the equations  $x' : y' : z' = X : Y : Z$ , viz., regarding  $x', y', z'$  as constants (and to fix the ideas, assuming that the curves  $X=0, Y=0, Z=0$ , have no common intersections), these are the points of intersection of the curves  $X : Y : Z = x' : y' : z'$ , but no one of these points is situate on the curve  $u=0$ . If, however, the point  $(x', y', z')$  is situate on the curve  $u'=0$ , then one point of the system of points in question is situate on the curve  $u=0$ , that is, to a given point of the curve  $u'=0$  there corresponds a single point of the curve  $u=0$ ; and hence also this point must be given by a system of equations such as  $x : y : z = X' : Y' : Z'$ .

It is an old and easily proved theorem that, for a curve of

the order  $m$ , the number  $\delta + \kappa$  of nodes and cusps is at most  $= \frac{1}{2}(m-1)(m-2)$ ; for a given curve the deficiency of the actual number of nodes and cusps below this maximum number, viz.  $\frac{1}{2}(m-1)(m-2) - \delta - \kappa$ , is the "Geschlecht" or "deficiency," of the curve, say this is  $D$ . When  $D=0$ , the curve is said to be unicursal, when  $=1$ , bicursal, and so on.

The general theorem is that two curves corresponding rationally to each other have the same deficiency. [In particular a curve and its reciprocal have this rational or  $(1, 1)$  correspondence, and it has been already seen that a curve and its reciprocal have the same deficiency.]

A curve of a given order can in general be rationally transformed into a curve of a lower order; thus a curve of any order for which  $D=0$ , that is, a unicursal curve, can be transformed into a line; a curve of any order having the deficiency 1 or 2 can be rationally transformed into a curve of the order  $D+2$ , deficiency  $D$ ; and a curve of any order deficiency  $=0$  or  $>3$  can be rationally transformed into a curve of the order  $D+3$ , deficiency  $D$ .

Taking  $x', y', z'$  as co-ordinates of a point of the transformed curve, and in its equation writing  $x' : y' : z' = 1 : \theta : \phi$  we have  $\phi$  a certain irrational function of  $\theta$ , and the theorem is that the co-ordinates  $x, y, z$  of any point of the given curve can be expressed as proportional to rational and integral functions of  $\theta, \phi$ , that is, of  $\theta$  and a certain irrational function of  $\theta$ .

In particular if  $D=0$ , that is, if the given curve be unicursal, the transformed curve is a line,  $\phi$  is a mere linear function of  $\theta$ , and the theorem is that the co-ordinates  $x, y, z$  of a point of the unicursal curve can be expressed as proportional to rational and integral functions of  $\theta$ ; it is easy to see that for a given curve of the order  $m$ , these functions of  $\theta$  must be of the same order  $m$ .

If  $D=1$ , then the transformed curve is a cubic; it can be shown that in a cubic, the axes of co-ordinates being properly chosen,  $\phi$  can be expressed as the square root of a quartic function of  $\theta$ ; and the theorem is that the co-ordinates  $x, y, z$  of a point of the bicursal curve can be expressed as proportional to rational and integral functions of  $\theta$ , and of the square root of a quartic function of  $\theta$ .

And so if  $D=2$ , then the transformed curve is a nodal quartic;  $\phi$  can be expressed as the square root of a sextic function of  $\theta$  and the theorem is, that the co-ordinates  $x, y, z$  of a point of the tricusar curve can be expressed as proportional to rational and integral functions of  $\theta$ , and of the square root of a sextic function of  $\theta$ . But  $D=3$ , we have no longer the like law, viz.  $\phi$  is not expressible as the square root of an octic function of  $\theta$ .

Observe that the radical, square root of a quartic function, is connected with the theory of elliptic functions, and the radical, square root of a sextic function, with that of the first kind of Abelian functions, but that the next kind of Abelian functions does not depend on the radical, square root of an octic function.

It is a form of the theorem for the case  $D=1$ , that the co-ordinates  $x, y, z$  of a point of the bicursal curve, or in particular the co-ordinates of a point of the cubic, can be expressed as proportional to rational and integral functions of the elliptic functions  $\text{snu}, \text{cnu}, \text{dnu}$ ; in fact, taking the radical to be  $\sqrt{1 - \theta^2 - k^2\theta^4}$ , and writing  $\theta = \text{snu}$ , the radical becomes  $= \text{cnu}, \text{dnu}$ ; and we have expressions of the form in question.

It will be observed that the equations  $x' : y' : z' = X : Y : Z$  before mentioned do not of themselves lead to the other system of equations  $x : y : z = X' : Y' : Z'$ , and thus that the theory does not in anywise establish a  $(1, 1)$  correspondence between the points  $(x, y, z)$  and  $(x', y', z')$  of two planes or of the same plane; this is the correspondence of Cremona's theory.

In this theory, given in the memoirs "Sulle trasformazioni geometriche delle figure piane," *Mem. di Bologna*, t. ii. (1863) and t. v. (1865), we have a system of equations  $x' : y' : z' = X : Y : Z$  which does lead to a system  $x : y : z = X' : Y' : Z'$ , where, as before,  $X, Y, Z$  denote rational and integral functions, all of the same order, of the co-ordinates  $x, y, z$ , and  $X', Y', Z'$  rational and integral functions, all of the same order, of the co-ordinates  $x', y', z'$ , and there is thus a  $(1, 1)$  correspondence given by these equations between the two points  $(x, y, z)$  and  $(x', y', z')$ . To explain this, observe that starting from the equations  $x' : y' : z' = X : Y : Z$ , to a given point  $(x, y, z)$  there corresponds one point  $(x', y', z')$ , but that if  $n$  be the order of the functions  $X, Y, Z$ , then to a given point  $x', y', z'$  there would, if the curves  $X=0, Y=0, Z=0$  had no common intersections, correspond  $n^2$  points  $(x, y, z)$ . If, however, the functions are such that the curves  $X=0, Y=0, Z=0$  have  $k$  common intersections, then among the  $n^2$  points are included these  $k$  points, which are fixed points independent of the point  $(x', y', z')$ ; so that, disregarding

these fixed points, the number of points  $(x, y, z)$  corresponding to the given point  $(x', y', z')$  is  $= n^2 - k$ ; and in particular if  $k = n^2 - 1$ , then we have one corresponding point; and hence the original system of equations  $x' : y' : z' = X : Y : Z$  must lead to the equivalent system  $x : y : z = X' : Y' : Z'$ ; and in this system by the like reasoning the functions must be such that the curves  $X'=0, Y'=0, Z'=0$  have  $n^2 - 1$  common intersections. The most simple example is in the two systems of equations  $x' : y' : z' = yz : zx : xy$  and  $x : y : z = y'z' : z'x' : x'y'$ ; where  $yz=0, zx=0, xy=0$  are conics (pairs of lines) having three common intersections, and where obviously either system of equations leads to the other system. In the case where  $X, Y, Z$  are of an order exceeding 2 the required number  $n^2 - 1$  of common intersections can only occur by reason of common multiple points on the three curves; and assuming that the curves  $X=0, Y=0, Z=0$  have  $a_1 + a_2 + a_3 + \dots + a_{n-1}$  common intersections, where the  $a_1$  points are ordinary points, the  $a_2$  points are double points, the  $a_3$  points are triple points, &c., on each curve, we have the condition

$$a_1 + 4a_2 + 9a_3 + \dots + (n-1)^2 a_{n-1} = n^2 - 1;$$

but to this must be joined the condition

$$a_1 + 3a_2 + 6a_3 + \dots + \frac{1}{2}n(n-1)a_{n-1} = \frac{1}{2}n(n+3) - 2$$

(without which the transformation would be illusory); and the conclusion is that  $a_1, a_2, \dots, a_{n-1}$  may be any numbers satisfying these two equations. It may be added that the two equations together give

$$a_2 + 3a_3 + \dots + \frac{1}{2}(n-1)(n-2)a_{n-1} = \frac{1}{2}(n-1)(n-2),$$

which expresses that the curves  $X=0, Y=0, Z=0$  are unicursal. The transformation may be applied to any curve  $u=0$ , which is thus rationally transformed into a curve  $u'=0$ , by a rational transformation such as is considered in Riemann's theory: hence the two curves have the same deficiency.

Coming next to Chasles, the principle of correspondence is established and used by him in a series of memoirs relating to the conics which satisfy given conditions, and to other geometrical questions, contained in the *Comptes rendus*, t. lviii. (1864) et seq. The theorem of united points in regard to points in a right line was given in a paper, June-July 1864, and it was extended to unicursal curves in a paper of the same series (March 1866), "Sur les courbes planes ou à double courbure dont les points peuvent se déterminer individuellement—application du principe de correspondance dans la théorie de ces courbes."

The theorem is as follows: if in a unicursal curve two points have an  $(\alpha, \beta)$  correspondence, then the number of united points (or points each corresponding to itself) is  $= \alpha + \beta$ . In fact in a unicursal curve the co-ordinates of a point are given as proportional to rational and integral functions of a parameter, so that any point of the curve is determined uniquely by means of this parameter; that is, to each point of the curve corresponds one value of the parameter, and to each value of the parameter one point on the curve; and the  $(\alpha, \beta)$  correspondence between the two points is given by an equation of the form  $(\theta, 1)^\alpha (\phi, 1)^\beta = 0$  between their parameters  $\theta$  and  $\phi$ ; at a united point  $\phi = \theta$ , and the value of  $\theta$  is given by an equation of the order  $\alpha + \beta$ . The extension to curves of any given deficiency  $D$  was made in the memoir of Cayley, "On the correspondence of two points on a curve,"—*Proc. Lond. Math. Soc.* t. i. (1866; *Collected Works*, vol. vi. p. 9),—viz. taking  $P, P'$  as the corresponding points in an  $(\alpha, \alpha')$  correspondence on a curve of deficiency  $D$ , and supposing that when  $P$  is given the corresponding points  $P'$  are found as the intersections of the curve by a curve  $\theta$  containing the co-ordinates of  $P$  as parameters, and having with the given curve  $k$  intersections at the point  $P$ , then the number of united points is  $\alpha = \alpha + \alpha' + 2kD$ ; and more generally, if the curve  $\theta$  intersect the given curve in a set of points  $P'$  each  $p$  times, a set of points  $Q'$  each  $q$  times, &c., in such manner that the points  $(P, P')$  the points  $(P, Q')$  &c., are pairs of points corresponding to each other according to distinct laws; then if  $(P, P')$  are points having an  $(\alpha, \alpha')$  correspondence with a number  $= a$  of united points,  $(P, Q')$  points having a  $(\beta, \beta')$  correspondence with a number  $= b$  of united points, and so on, the theorem is that we have

$$p(a - \alpha - \alpha') + q(b - \beta - \beta') + \dots = 2kD.$$

The principle of correspondence, or say rather the theorem of united points, is a most powerful instrument of investigation, which may be used in place of analysis for the determination of the number of solutions of almost every geometrical problem. We can by means of it investigate the class of a curve, number of inflections, &c.—in fact, Plücker's equations; but it is necessary to take account of special solutions: thus, in one of the most simple instances, in finding the class of a curve, the cusps present themselves as special solutions.

Imagine a curve of order  $m$ , deficiency  $D$ , and let the corresponding points  $P, P'$  be such that the line joining them passes through a given

point O; this is an  $(m-1, m-1)$  correspondence, and the value of  $k$  is 1, hence the number of united points is  $=2m-2+2D$ ; the united points are the points of contact of the tangents from O and (as special solutions) the cusps, and we have thus the relation  $n+k=2m-2+2D$ ; or, writing  $D=\frac{1}{2}(m-1)(m-2)-\delta-k$ , this is  $n=m(m-1)-2\delta-3k$ , which is right.

The principle in its original form as applying to a right line was used throughout by Chasles in the investigations on the number of the conics which satisfy given conditions, and on the number of solutions of very many other geometrical problems.

There is one application of the theory of the  $(a, a')$  correspondence between two planes which it is proper to notice.

Imagine a curve, real or imaginary, represented by an equation (involving, it may be, imaginary coefficients) between the Cartesian co-ordinates  $u, u'$ ; then, writing  $u=x+iy, u'=x'+iy'$ , the equation determines real values of  $(x, y)$ , and of  $(x', y')$ , corresponding to any given real values of  $(x', y')$  and  $(x, y)$  respectively: that is, it establishes a real correspondence (not of course a rational one) between the points  $(x, y)$  and  $(x', y')$ ; for example in the imaginary circle  $u^2+u'^2=(a+bi)^2$ , the correspondence is given by the two equations  $x^2-y^2+x'^2-y'^2=a^2-b^2, xy+x'y'=ab$ . We have thus a means of geometrical representation for the portions, as well imaginary as real, of any real or imaginary curve. Considerations such as these have been used for determining the series of values of the independent variable, and the irrational functions thereof in the theory of Abelian integrals, but the theory seems to be worthy of further investigation.

16. *Systems of Curves satisfying Conditions.*—The researches of Chasles (*Comptes Rendus*, t. lviii., 1864, et seq.) refer to the conics which satisfy given conditions. There is an earlier paper by J. P. E. Fauque de Jonquières, "Théorèmes généraux concernant les courbes géométriques planes d'un ordre quelconque," *Liouv.* t. vi. (1861), which establishes the notion of a system of curves (of any order) of the index  $N$ , viz. considering the curves of the order  $n$  which satisfy  $\frac{1}{2}n(n+3)-1$  conditions, then the index  $N$  is the number of these curves which pass through a given arbitrary point. But Chasles in the first of his papers (February 1864), considering the conics which satisfy four conditions, establishes the notion of the two characteristics  $(\mu, \nu)$  of such a system of conics, viz.  $\mu$  is the number of the conics which pass through a given arbitrary point, and  $\nu$  is the number of the conics which touch a given arbitrary line. And he gives the theorem, a system of conics satisfying four conditions, and having the characteristics  $(\mu, \nu)$  contains  $2\nu-\mu$  line-pairs (that is, conics, each of them a pair of lines), and  $2\mu-\nu$  point-pairs (that is, conics, each of them a pair of points,—coniques infiniment aplyées), which is a fundamental one in the theory. The characteristics of the system can be determined when it is known how many there are of these two kinds of degenerate conics in the system, and how often each is to be counted. It was thus that Zeuthen (in the paper *Nyt Bydrag*, "Contribution to the Theory of Systems of Conics which satisfy four Conditions" (Copenhagen, 1865), translated with an addition in the *Nouvelles Annales*) solved the question of finding the characteristics of the systems of conics which satisfy four conditions of contact with a given curve or curves; and this led to the solution of the further problem of finding the number of the conics which satisfy five conditions of contact with a given curve or curves (Cayley, *Comptes Rendus*, t. lxiii., 1866; *Collected Works*, vol. v. p. 542), and "On the Curves which satisfy given Conditions" (*Phil. Trans.* t. clviii., 1868; *Collected Works*, vol. vi. p. 191).

It may be remarked that although, as a process of investigation, it is very convenient to seek for the characteristics of a system of conics satisfying 4 conditions, yet what is really determined is in every case the number of the conics which satisfy 5 conditions; the characteristics of the system  $(4p)$  of the conics which pass through  $4p$  points are  $(5p), (4p, 1)$ , the number of the conics which pass through 5 points, and which pass through 4 points and touch 1 line; and so in other cases. Similarly as regards cubics, or curves of any other order: a cubic depends on 9 constants, and the elementary problems are to find the number of the cubics  $(9p), (8p, 1)$ , &c., which pass through 9 points, pass through 8 points and touch 1 line, &c.; but it is in the investigation convenient to seek for the characteristics of the systems of cubics  $(8p)$ , &c., which satisfy 8 instead of 9 conditions.

The elementary problems in regard to cubics are solved very completely by S. Maillard in his *Thèse, Recherche des caractéristiques des systèmes élémentaires des courbes planes du troisième ordre* (Paris, 1871). Thus, considering the several cases of a cubic

	No. of consts.
1. With a given cusp	5
2. " cusp on given line	6
3. " cusp	7
4. " a given node	6
5. " node on given line	7
6. " node	8
7. non-singular	9

he determines in every case the characteristics  $(\mu, \nu)$  of the corresponding systems of cubics  $(4p), (3p, 1)$ , &c. The same problems, or most of them, and also the elementary problems in regard to quartics are solved by Zeuthen, who in the elaborate memoir "Almindelige Egenskaber, &c.," *Danish Academy*, t. x. (1873), considers the problem in reference to curves of any order, and applies his results to cubic and quartic curves.

The methods of Maillard and Zeuthen are substantially identical; in each case the question considered is that of finding the characteristics  $(\mu, \nu)$  of a system of curves by consideration of the special or degenerate forms of the curves included in the system. The quantities which have to be considered are very numerous. Zeuthen in the case of curves of any given order establishes between the characteristics  $\mu, \nu$ , and 18 other quantities, in all 20 quantities, a set of 24 equations (equivalent to 23 independent equations), involving (besides the 20 quantities) other quantities relating to the various forms of the degenerate curves, which supplementary terms he determines, partially for curves of any order, but completely only for quartic curves. It is the discussion and complete enumeration of the special or degenerate forms of the curves, and of the supplementary terms to which they give rise, that the great difficulty of the question seems to consist; it would appear that the 24 equations are a complete system, and that (subject to a proper determination of the supplementary terms) they contain the solution of the general problem.

17. *Degeneration of Curves.*—The remarks which follow have reference to the analytical theory of the degenerate curves which present themselves in the foregoing problem of the curves which satisfy given conditions.

A curve represented by an equation in point-co-ordinates may break up: thus if  $P_1, P_2, \dots$  be rational and integral functions of the co-ordinates  $(x, y, z)$  of the orders  $m_1, m_2, \dots$  respectively, we have the curve  $P_1^{a_1} P_2^{a_2} \dots = 0$ , of the order  $m = a_1 m_1 + a_2 m_2 + \dots$  composed of the curve  $P_1 = 0$  taken  $a_1$  times, the curve  $P_2 = 0$  taken  $a_2$  times, &c.

Instead of the equation  $P_1^{a_1} P_2^{a_2} \dots = 0$ , we may start with an equation  $u = 0$ , where  $u$  is a function of the order  $m$  containing a parameter  $\theta$ , and for a particular value say  $\theta = 0$ , of the parameter reducing itself to  $P_1^{a_1} P_2^{a_2} \dots$ . Supposing  $\theta$  indefinitely small, we have what may be called the penultimate curve, and when  $\theta = 0$  the ultimate curve. Regarding the ultimate curve as derived from a given penultimate curve, we connect with the ultimate curve, and consider as belonging to it, certain points called "summits" on the component curves  $P_1 = 0, P_2 = 0$  respectively; a summit  $\Sigma$  is a point such that, drawing from an arbitrary point O the tangents to the penultimate curve, we have  $O\Sigma$  as the limit of one of these tangents. The ultimate curve together with its summits may be regarded as a degenerate form of the curve  $u = 0$ . Observe that the positions of the summits depend on the penultimate curve  $u = 0$ , viz. on the values of the coefficients in the terms multiplied by  $\theta, \theta^2, \dots$ ; they are thus in some measure arbitrary points as regards the ultimate curve  $P_1^{a_1} P_2^{a_2} \dots = 0$ .

It may be added that we have summits only on the component curves  $P_1 = 0$ , of a multiplicity  $a_1 > 1$ ; the number of summits on such a curve is in general  $= (a_1^2 - a_1) m_1^2$ . Thus assuming that the penultimate curve is without nodes or cusps, the number of the tangents to it is  $m^2 - m = (a_1 m_1 + a_2 m_2 + \dots)^2 - (a_1 m_1 + a_2 m_2 + \dots)$ . Taking  $P_1 = 0$  to have  $\delta_1$  nodes and  $\kappa_1$  cusps, and therefore its class  $n_1$  to be  $m_1^2 - m_1 - 2\delta_1 - 3\kappa_1$ , &c., the expression for the number of tangents to the penultimate curve is

$$= (a_1^2 - a_1) m_1^2 + (a_2^2 - a_2) m_2^2 + \dots + 2a_1 a_2 m_1 m_2 + a_1 (n_1 + 2\delta_1 + 3\kappa_1) + a_2 (n_2 + 2\delta_2 + 3\kappa_2) + \dots$$

where a term  $2a_1 a_2 m_1 m_2$  indicates tangents which are in the limit the lines drawn to the intersections of the curves  $P_1 = 0, P_2 = 0$  each line  $2a_1 a_2$  times; a term  $a_1 (n_1 + 2\delta_1 + 3\kappa_1)$  tangents which are in the

limit the proper tangents to  $P_1=0$  each  $a_1$  times, the lines to its nodes each  $2a_1$  times, and the lines to its cusps each  $3a_1$  times; the remaining terms  $(a_1^2 - a_1)m_1^2 + (a_2^2 - a_2)m_2^2 + \dots$  indicate tangents which are in the limit the lines drawn to the several summits, that is, we have  $(a_1^2 - a_1)m_1^2$  summits on the curve  $P_1=0$ , &c.

There is, of course, a precisely similar theory as regards line-co-ordinates; taking  $\Pi_1, \Pi_2, \dots$  to be rational and integral functions of the co-ordinates  $(\xi, \eta, \zeta)$  we connect with the ultimate curve  $\Pi_1^{\alpha_1}\Pi_2^{\alpha_2}\dots=0$ , and consider as belonging to it, certain lines, which for the moment may be called "axes," tangents to the component curves  $\Pi_1=0, \Pi_2=0$  respectively. Considering an equation in point-co-ordinates, we may have among the component curves right lines, and if in order to put these in evidence we take the equation to be  $L_1\gamma \dots P_1^{\alpha_1} \dots = 0$ , where  $L_1=0$  is a right line,  $P_1=0$  a curve of the second or any higher order, then the curve will contain as part of itself summits not exhibited in this equation, but the corresponding line-equation will be  $\Lambda_1^{\alpha_1} \dots \Pi_1^{\alpha_1} = 0$ , where  $\Lambda_1=0, \dots$  are the equations of the summits in question,  $\Pi_1=0, \dots$ , are the line-equations corresponding to the several point-equations  $P_1=0, \dots$ ; and this curve will contain as part of itself axes not exhibited by this equation, but which are the lines  $L_1=0, \dots$  of the equation in point-co-ordinates.

18. *Twisted Curves*.—In conclusion a little may be said as to curves of double curvature, otherwise twisted curves or curves in space. The analytical theory by Cartesian co-ordinates was first considered by Alexis Claude Clairaut, *Recherches sur les courbes à double courbure* (Paris, 1731). Such a curve may be considered as described by a point, moving in a line which at the same time rotates about the point in a plane which at the same time rotates about the line; the point is a point, the line a tangent, and the plane an osculating plane, of the curve; moreover the line is a generating line, and the plane a tangent plane, of a developable surface or torse, having the curve for its edge of regression. Analogous to the order and class of a plane curve we have the order, rank and class of the system (assumed to be a geometrical one), viz. if an arbitrary plane contains  $m$  points, an arbitrary line meets  $r$  lines, and an arbitrary point lies in  $n$  planes, of the system, then  $m, r, n$  are the order, rank and class respectively. The system has singularities, and there exist between  $m, r, n$  and the numbers of the several singularity equations analogous to Plücker's equations for a plane curve.

It is a leading point in the theory that a curve in space cannot in general be represented by means of two equations  $U=0, V=0$ ; the two equations represent surfaces, intersecting in a curve; but there are curves which are not the complete intersection of any two surfaces; thus we have the cubic in space, or skew cubic, which is the residual intersection of two quadric surfaces which have a line in common; the equations  $U=0, V=0$  of the two quadric surfaces represent the cubic curve, not by itself, but together with the line.

**AUTHORITIES.**—In addition to the copious authorities mentioned in the text above, see Gabriel Cramer, *Introduction à l'analyse des lignes courbes algébriques* (Geneva, 1750). Bibliographical articles are given in the *Ency. der math. Wiss.* Bd. iii. 2, 3 (Leipzig, 1902-1906); H. C. F. von Mangoldt, "Anwendung der Differential- und Integralrechnung auf Kurven und Flächen," Bd. iii. 3 (1902); F. R. v. Lillenthal, "Die auf einer Fläche gezogenen Kurven," Bd. iii. 3 (1902); G. W. Scheffers, "Besondere transcendente Kurven," Bd. iii. 3 (1903); H. G. Zeuthen, "Abzählende Methoden," Bd. iii. 2 (1906); L. Berzolari, "Allgemeine Theorie der höheren ebenen algebraischen Kurven," Bd. iii. 2 (1906). Also A. Brill and M. Noether, "Die Entwicklung der Theorie der algebraischen Funktionen in älterer und neuerer Zeit" (*Jahresb. der deutschen math. ver.*, 1894); E. Kötter, "Die Entwicklung der synthetischen Geometrie" (*Jahresb. der deutschen math. ver.*, 1898-1901); E. Pascal, *Repertorio di matematiche superiori*, ii. "Geometria" (Milan, 1900); H. Wieleitner, *Bibliographie der höheren algebraischen Kurven für den Zeitabschnitt von 1800-1894* (Leipzig, 1905).

**Text-books:**—G. Salmon, *A Treatise on the Higher Plane Curves* (Dublin, 1852, 3rd ed., 1879); translated into German by O. W. Fiedler, *Analytische Geometrie der höheren ebenen Kurven* (Leipzig, 2te Aufl., 1882); L. Cremona, *Introduzione ad una teoria geometrica delle curve piane* (Bologna, 1861); J. H. K. Durège, *Die ebenen Kurven dritter Ordnung* (Leipzig, 1871); R. F. A. Clebsch and C. L. F. Lindemann, *Vorlesungen über Geometrie*, Band i. and ii (Leipzig, 1875-1876); H. Schroeter, *Die Theorie der ebenen Kurven dritter Ordnung* (Leipzig, 1888); H. Andoyer, *Leçons sur la théorie des formes et la géométrie analytique supérieure* (Paris, 1900); Wieleitner, *Theorie der ebenen algebraischen Kurven höherer Ordnung* (Leipzig, 1905). (A. CA.; E. B. EL.)

**CURVILINEAR**, in architecture, that which is formed by curved or flowing lines; the roofs over the domes and vaults of the Byzantine churches were generally curvilinear. The term is also given to the flowing tracery of the Decorated and the Flamboyant styles.

**CURWEN, HUGH** (d. 1568), English ecclesiastic and statesman, was a native of Westmorland, and was educated at Cambridge, afterwards taking orders in the church. In May 1533 he expressed approval of Henry VIII.'s marriage with Anne Boleyn in a sermon preached before the king. In 1541 he became dean of Hereford, and in 1555 Queen Mary nominated him to the archbishopric of Dublin, and in the same year he was appointed lord chancellor of Ireland. He acted as one of the lords justices during the absence from Ireland of the lord deputy, the earl of Sussex, in 1557. On the accession of Elizabeth, Curwen at once accommodated himself to the new conditions by declaring himself a Protestant, and was continued in the office of lord chancellor. He was accused by the archbishop of Armagh of serious moral delinquency, and his recall was demanded both by the primate and the bishop of Meath. In 1567 Curwen resigned the see of Dublin and the office of lord chancellor, and was appointed bishop of Oxford. He died on the 1st of November 1568.

See John Strype, *Life and Acts of Archbishop Parker* (3 vols., Oxford, 1824), and *Memorials of Thomas Cranmer* (2 vols., Oxford, 1840); John D'Alton, *Memoirs of the Archbishops of Dublin* (Dublin, 1838).

**CURWEN, JOHN** (1816-1880), English Nonconformist minister and founder of the Tonic Sol-Fa system of musical teaching, was born at Heckmondwike, Yorkshire, of an old Cumberland family. His father was a Nonconformist minister, and he himself adopted this profession, which he practised till 1864, when he gave it up in order to devote himself to his new method of musical nomenclature, designed to avoid the use of the staff with its lines and spaces. He adapted it from that of Miss Sarah Ann Glover (1785-1867) of Norwich, whose Sol-Fa system was based on the ancient gamut; but she omitted the constant recital of the alphabetical names of each note and the arbitrary syllable indicating key relationship, and also the recital of two or more such syllables when the same note was common to as many keys (e.g. "C, Fa, Ut," meaning that C is the subdominant of G and the tonic of C). The notes were represented by the initials of the seven syllables, still in use in Italy and France as their names; but in the "Tonic Sol-Fa" the seven letters refer to key relationship and not to pitch. Curwen was led to feel the importance of a simple way of teaching how to sing by note by his experiences among Sunday-school teachers. Apart from Miss Glover, the same idea had been elaborated in France since J. J. Rousseau's time, by Pierre Galin (1786-1821), Aimé Paris (1798-1866) and Emile Chevê (1804-1864), whose method of teaching how to read at sight also depended on the principle of "tonic relationship" being inculcated by the reference of every sound to its tonic, by the use of a numeral notation. Curwen brought out his *Grammar of Vocal Music* in 1843, and in 1853 started the Tonic Sol-Fa Association; and in 1879, after some difficulties with the education department, the Tonic Sol-Fa College was opened. Curwen also took to publishing, and brought out a periodical called the *Tonic Sol-fa Reporter*, and in his later life was occupied in directing the spreading organization of his system. He died at Manchester on the 26th of May 1880. His son John Spencer Curwen (b. 1847), who became principal of the Tonic Sol-Fa College, published *Memorials of J. Curwen* in 1882. The Sol-Fa system has been widely adopted for use in education, as an easily teachable method in the reading of music at sight, but its more ambitious aims, which are strenuously pushed, for providing a superior method of musical notation generally, have not recommended themselves to musicians at large.

**CURZOLA** (Serbo-Croatian *Korčula* or *Karkar*), an island in the Adriatic Sea, forming part of Dalmatia, Austria; and lying west of the Sabioncello promontory, from which it is divided by a strait less than 2 m. wide. Its length is about 25 m.; its average breadth, 4 m. Curzola (*Korčula*), the capital and

principal port, is a fortified town on the east coast, and occupies a rocky foreland almost surrounded by the sea. Besides the interesting church (formerly a cathedral), dating from the 12th or 13th century, the *loggia* or council chambers, and the palace of its former Venetian governors, it possesses the noble mansion of the Arnieri, and other specimens of the domestic architecture of the 15th and 16th centuries, together with the massive walls and towers, erected in 1420, and the 15th-century Franciscan monastery, with its beautiful Venetian Gothic cloister. The main resources of the islanders are boat-building (for which they are celebrated throughout the Adriatic), fishing and sea-faring, the cultivation of the vine, corn and olives, and breeding of mules. Pop. (1900) of island, 17,377; of capital (town and commune), 6486. Prehistoric grave-mounds are common on the hills of the interior, and in later times Curzola may have been a Phoenician settlement. Its early history is very obscure, but it was certainly colonized by Greeks from Cnidus. The present name is a corruption of the Gr. *Κέρκυρα Μέλαινα*, or Lat. *Corcyra Nigra*, "Black Corcyra"; and is perhaps due to the dark pines which still partly cover the island. In 908 Curzola first came under Venetian suzerainty. During the 12th century it was ruled by Hungary and Genoa in turn, and enjoyed a brief period of independence; but after 1255 its hereditary counts again submitted to Venice. The Roman Catholic see of Curzola, created in 1301, was only suppressed in 1806. Curzola surrendered to the Hungarians in 1358, was purchased by Ragusa (1413-1417), and finally declared itself subject to Venice in 1420. In 1571 it defended itself so gallantly against the Turks that it obtained the designation *fideliissima*. From 1776 to 1797 it succeeded Lesina as the main Venetian arsenal in this region. During the Napoleonic wars it was ruled successively by Russians, French and British, ultimately passing to Austria in 1815.

**CURZON OF KEDLESTON, GEORGE NATHANIEL**, 1ST BARON (1859— ), English statesman, eldest son of the 4th baron Scarsdale, rector of Kedleston, Derbyshire, was born on the 11th of January 1859, and was educated at Eton and Balliol College, Oxford. At Oxford he was president of the Union, and after a brilliant university career was elected a fellow of All Souls College in 1883. He became assistant private secretary to Lord Salisbury in 1885, and in 1886 entered parliament as member for the Southport division of S.W. Lancashire. He was appointed under secretary for India in 1891-1892 and for foreign affairs in 1895-1898. In the meantime he had travelled in Central Asia, Persia, Afghanistan, the Pamirs, Siam, Indo-China and Korea, and published several books describing central and eastern Asia and the political problems connected with those regions. In 1895 he married Mary Victoria Leiter (d. 1906), daughter of a Chicago millionaire. In January 1899 he was appointed governor-general of India, where his extensive knowledge of Asiatic affairs showed itself in the inception of a strong foreign policy, while he took in hand the reform of every department of Indian administration. He was created an Irish peer on his appointment, the creation taking this form, it was understood, in order that he might remain free during his father's lifetime to re-enter the House of Commons. Reaching India shortly after the suppression of the frontier risings of 1897-98, he paid special attention to the independent tribes of the north-west frontier, inaugurated a new province called the North West Frontier Province, and carried out a policy of conciliation mingled with firmness of control. The only trouble on this frontier during the period of his administration was the Mahsud Waziri campaign of 1901. Being mistrustful of Russian methods he exerted himself to encourage British trade in Persia, paying a visit to the Persian Gulf in 1903; while on the north-east frontier he anticipated a possible Russian advance by the Tibet Mission of 1903, which rendered necessary the employment of military force for the protection of the British envoys. The mission, which had the ostensible support of China as suzerain of Tibet, penetrated to Lhasa, where a treaty was signed in September 1904. In pursuance of his reforming policy Lord Curzon appointed a number of commissions to inquire into Indian education, irrigation, police and other branches of administration, on whose

reports legislation was based during his second term of office as viceroy. With a view to improving British relations with the native chiefs and raising the character of their rule, he established the Imperial Cadet corps, settled the question of Berar with the nizam of Hyderabad, reduced the salt tax, and gave relief to the smaller income-tax payers. Lord Curzon exhibited much interest in the art and antiquities of India, and during his viceroyalty took steps for the preservation and restoration of many important monuments and buildings of historic interest. In January 1903 he presided at the durbar held at Delhi in honour of the coronation of King Edward VII. It was attended by all the leading native princes and by large numbers of visitors from Europe and America; and the magnificence of the spectacle surpassed anything that had previously been witnessed even in the gorgeous ceremonial of the East. On the expiration of his first term of office, Lord Curzon was reappointed governor-general. His second term of office was marked by the passing of several acts founded on the recommendations of his previous commissions, and by the partition of Bengal (1905), which roused bitter opposition amongst the natives of that province. A difference of opinion with the commander-in-chief, Lord Kitchener, regarding the position of the military member of council in India, led to a controversy in which Lord Curzon failed to obtain support from the home government. He resigned (1904) and returned to England. In 1904 he was appointed lord warden of the Cinque Ports; in the same year he was given the honorary degree of D.C.L. by Oxford University, and in 1908 he was elected chancellor of the university. In the latter year he was elected a representative peer for Ireland, and thus relinquished any idea of returning to the House of Commons. In 1909-1910 he took an active part in defending the House of Lords against the Liberals. Lord Curzon's publications include *Russia in Central Asia* (1889); *Persia and the Persian Question* (1892); *Problems of the Far East* (1894; new ed., 1896).

See Caldwell Lipsett, *Lord Curzon in India, 1898-1903* (1906); and C. J. O'Donnell, *The Failure of Lord Curzon* (1903).

**CUSANUS, NICOLAUS (NICHOLAS OF CUSA)** (1401-1464), cardinal, theologian and scholar, was the son of a poor fisherman named Krypffs or Krebs, and derived the name by which he is known from the place of his birth, Kues or Cusa, on the Moselle, in the archbishopric of Trier (Treves). In his youth he was employed in the service of Count Ulrich of Manderscheid, who, seeing in him evidence of exceptional ability, sent him to study at the school of the Brothers of the Common Life at Deventer, and afterwards at the university of Padua, where he took his doctor's degree in law in his twenty-third year. Failing in his first case he abandoned the legal profession, and resolved to take holy orders. After filling several subordinate offices he became archdeacon of Liège. He was a member of the council of Basel, and dedicated to the assembled fathers a work entitled *De concordantia Catholica*, in which he maintained the superiority of councils over popes, and assailed the genuineness of the False Decretals and the Donation of Constantine. A few years later, however, he had reversed his position, and zealously defended the supremacy of the pope. He was entrusted with various missions in the interests of Catholic unity, the most important being to Constantinople, to endeavour to bring about a union of the Eastern and Western churches. From 1440 to 1447 he was in Germany, acting as papal legate at the diets of 1441, 1442, 1445 and 1446. In 1448, in recognition of his services, Nicholas V. raised him to the cardinalate; and in 1450 he was appointed bishop of Brixen against the wish of Sigismund, archduke of Austria, who opposed the reforms the new bishop sought to introduce into the diocese. In 1451 he was sent to Germany and the Netherlands to check ecclesiastical abuses and bring back the monastic life to the original rule of poverty, chastity and obedience—a mission which he discharged with well-tempered firmness. Soon afterwards his dispute with the archduke Sigismund in his own diocese was brought to a point by his claiming certain dues of the bishopric, which the temporal prince had appropriated. Upon this the bishop was imprisoned by the archduke, who, in his turn, was excommunicated by the pope.



These extreme measures were not persisted in; but the dispute remained unsettled at the time of the bishop's death, which occurred at Lodi in Umbria on the 11th of August 1464. In 1459 he had acted as governor of Rome during the absence of his friend Pope Pius II. at the assembly of princes at Milan; and he wrote his *Crebratio Alcorani*, a treatise against Mahomedanism, in support of the expedition against the Turks proposed at that assembly. Some time before his death he had founded a hospital in his native place for thirty-three poor persons, the number being that of the years of the earthly life of Christ. To this institution he left his valuable library.

Although one of the great leaders in the reform movement of the 15th century, Nicholas of Cusa's interest for later times lies in his philosophical much more than in his political or ecclesiastical activity. As in religion he is entitled to be called one of the "Reformers before the Reformation," so in philosophy he was one of those who broke with scholasticism while it was still the orthodox system. In his principal work, *De docta ignorantia* (1440), supplemented by *De conjecturis libri duo* published in the same year, he maintains that all human knowledge is mere conjecture, and that man's wisdom is to recognize his ignorance. From scepticism he escapes by accepting the doctrine of the mystics that God can be apprehended by intuition (*intuitio*, *speculatio*), an exalted state of the intellect in which all limitations disappear. God is the absolute maximum and also the absolute minimum, who can be neither greater nor less than He is, and who comprehends all that is or that can be ("deum esse omnia, ut non possit esse aliud quam est"). Cusanus thus laid himself open to the charge of pantheism, which did not fail to be brought against him in his own day. His chief philosophical doctrine was taken up and developed more than a hundred years later by Giordano Bruno, who calls him the divine Cusanus. In mathematical and physical science Cusanus was much in advance of his age. In a tract, *Reparatio Calendarii*, presented to the council of Basel, he proposed the reform of the calendar after a method resembling that adopted by Gregory. In his *De Quadratura Circuli* he professed to have solved the problem; and in his *Conjectura de novissimis diebus* he prophesied that the world would come to an end in 1734. Most noteworthy, however, in this connexion is the fact that he anticipated Copernicus by maintaining the theory of the rotation of the earth.

The works of Cusanus were published in a complete form by Henri Petrie (1 vol. fol., Basel, 1565). See F. A. Scharpf's *Der Kardinal und Bischof Nikolaus von Cusa als Reformator in Kirche, Reich, und Philos. des 15. Jahrhunderts*. (Tübingen, 1871); J. M. Düx, *Der deutsche Kard. Nicolaus von Cusa und die Kirche seiner Zeit* (Regensburg, 1848); R. Falckenberg, *Grundsätze d. Philos. d. Nikolaus Cusanus* (Breslau, 1880) and *Aufgabe und Wesen d. Erkenntniss bei Nikolaus von Kues* (Breslau, 1880); T. Stumpf, *Die politischen Ideen des Nikolaus von Cues* (Cologne, 1865); M. Glossner, *Nikolaus von Cusa und Marius Nizolius als Vorläufer der neueren Philosophie* (Münster, 1891); F. Fiorentino, *Il Risorgimento filosofico nel quattro cento* (Naples, 1885); Axel Herrlin, *Studien i Nicolaus af Cues' Filosofi* (Lund, 1892); H. Höffding, *Hist. of Mod. Phil.* (Eng. trans., 1900), bk. i. chap. x.; F. J. Clemens, *Giordano Bruno und Nikolaus Cusanus* (Bonn, 1847); R. Zimmermann, *Der Card. Nikolaus Cusanus als Vorläufer Leibnizens* (Vienna, 1832); J. Übinger, *Philosophie des Nikolaus Cusanus* (Würzburg, 1881); art. by R. Schmid in Herzog-Hauck, *Realencyk.* s.v. "Cusanus"; see also MYSTICISM.

**CUSH**, the eldest son of Ham, in the Bible, from whom seems to have been derived the name of the "Land of Cush," commonly rendered "Ethiopia" by the Septuagint and by the Vulgate. The locality of the land of Cush has long been a much-vexed question. Bochart maintained that it was exclusively in Arabia; Schulthess and Gesenius held that it should be sought for nowhere but in Africa (see ETHIOPIA). Others again, like Michaelis and Rosenmüller, have supposed that the name Cush was applied to tracts of country both in Arabia and in Africa, but the defective condition of the ancient knowledge of countries and peoples, as also the probability of early migrations of "Cushite" tribes (carrying with them their name), will account for the main facts. The existence of an African Cush cannot reasonably be questioned, though the term is employed in the Old Testament with some latitude. The African Cush covers Upper Egypt, and extends

southwards from the first cataract (Syene, Ezek. xxix. 10). That the term was also applied to parts of Arabia is evident from Gen. x. 7, where Cush is the "father" of certain tribal and ethnical designations, all of which point very clearly to Arabia, with the very doubtful exception of Seba, which Josephus (*Ant.* ii. 10. 2) identifies with Meroë.<sup>1</sup> Even in the 5th century A.D. the Himyarites, in the south of Arabia, were styled by Syrian writers Cushaeans and Ethiopians. Moreover, the Babylonian inscriptions mention the Kashshi, an Elamite race, whose name has been equated with the classical *Κασσαίοι*, *Κίσαίοι*, and it has been held that this affords a more appropriate explanation of Cush (perhaps rather Kash), the ancestor of (the Babylonian) Nimrod in Gen. x. 8. Although decisive evidence is lacking, it seems extremely probable that several references to Cush in the Old Testament cannot refer to Ethiopia, despite the likelihood that considerable confusion existed in the minds of early writers. The Cushite invasion in 2 Chron. xiv. (see ASA) is intelligible if the historical foundation for the story be a raid by Arabians, but in xvi. 8 the inclusion of Libyans shows that the enemy was subsequently supposed to be African. In several passages the interpretation is bound up with that of Mizraim (*q.v.*), and depends in general upon the question whether Ethiopia at a given time enjoyed the prominence given to it.

On Num. xii. 1 see JETHRO; and consult H. Winckler, *Keil. u. das alte Test.*, 3rd ed., p. 144 sq., and *Im Kampfe um den alten Orient*, ii. pp. 36 seq., and the literature cited under MIZRAIM. (S. A. C.)

**CUSHING, CALEB** (1800–1879), American political leader and lawyer, was born in Salisbury, Massachusetts, on the 17th of January 1800. He graduated at Harvard in 1817, was tutor in mathematics there in 1820–1821, was admitted to practice in the court of common pleas in December 1821, and began the practice of law in Newburyport, Mass., in 1824. After serving, as a Democratic-Republican, in the state house of representatives in 1825, in the state senate in 1826, and in the house again in 1828, he spent two years, from 1829 to 1831, in Europe, again served in the state house of representatives in 1833 and 1834, and in the latter year was elected by the Whigs a representative in Congress. He served in this body from 1835 until 1843, and here the marked inconsistency which characterized his public life became manifest; for when John Tyler had become president, had been "read out" of the Whig party, and had vetoed Whig measures (including a tariff bill), for which Cushing had voted, Cushing first defended the vetoes and then voted again for the bills. In 1843 President Tyler nominated him for secretary of the treasury, but the senate refused to confirm him for this office. He was, however, appointed later in the same year commissioner of the United States to China, holding this position until 1845, and in 1844 negotiating the first treaty between China and the United States. In 1847, while again a representative in the state legislature, he introduced a bill appropriating money for the equipment of a regiment to serve in the Mexican War; although the bill was defeated, he raised the necessary funds privately, and served in Mexico first as colonel and afterwards as brigadier-general of volunteers. In 1847 and again in 1848 the Democrats nominated him for governor of Massachusetts, but on each occasion he was defeated at the polls. He was again a representative in the state legislature in 1851, became an associate justice of the supreme court of Massachusetts in 1852, and during the administration (1853–1857) of President Pierce, was attorney-general of the United States. In 1858, 1859, 1862 and 1863 he again served in the state house of representatives. In 1860 he presided over the National Democratic Convention which met first at Charleston and later at Baltimore, until he joined those who seceded from the regular convention; he then presided also over the convention of the seceding delegates, who nominated John C. Breckinridge for the presidency. During the Civil War, however, he supported the National Administration. At the Geneva conference for the settlement of the "Alabama" claims in 1871–1872 he was one of the counsel for the United States.

<sup>1</sup> For Seba, see SABAEANS, and cf. generally the commentaries on Gen. x. 7. In Hab. iii. 7 Cushan (obviously a related form) is parallel to Midian.

In 1873 President Grant nominated him for chief justice of the United States, but in spite of his great learning and eminence at the bar, his ante-war record and the feeling of distrust experienced by many members of the senate on account of his inconsistency, aroused such vigorous opposition that his nomination was soon withdrawn. From 1874 to 1877 Cushing was United States minister to Spain. He died at Newburyport, Mass., on the 2nd of January 1879. He published *History and Present State of the Town of Newburyport, Mass.* (1826); *Review of the late Revolution in France* (1833); *Reminiscences of Spain* (1833); *Oration on the Growth and Territorial Progress of the United States* (1839); *Life and Public Services of William H. Harrison* (1840); and *The Treaty of Washington* (1873).

**CUSHING, WILLEAM BARKER** (1842-1874), American naval officer, was born in Delafield, Wisconsin, on the 4th of November 1842. He entered the Naval Academy from New York in 1857, but resigned in March 1861. When, however, the Civil War began, he volunteered into the navy, was rated acting master's mate, and became a midshipman in October 1861, and a lieutenant in July 1862, serving in the North Atlantic blockading squadron. The work of blockade, and of harassing the Confederates on the coast and the rivers of the Atlantic seaboard, called for much service in boats, and entailed a great deal of exposure. Cushing was distinguished by his readiness to volunteer, his indefatigability, and by his good fortune, the reward of vigilance and intelligence. The feat by which he will be remembered was the destruction of the Confederate ironclad "Albemarle" in the Roanoke river on the 27th of October in 1864. The vessel had done much damage to the Federal naval forces, and her destruction was greatly desired. She was at anchor surrounded by baulks of timber, and a cordon of boats had been stationed to row guard against an expected Federal attack. Lieutenant Cushing undertook the attack on her with a steam launch carrying a spar-torpedo and towing an armed cutter. He eluded the Confederate lookout and reached the "Albemarle" unseen. When close to he was detected, but he had time to drive the steam launch over the baulks and to explode the torpedo against the "Albemarle" with such success that a hole was made in her and she sank. Cushing's own launch was destroyed. He and the few men with him were compelled to take to the water; one was killed, another was drowned, Cushing and one other escaped, and the rest were captured. Cushing himself swam to the swamps on the river bank, and after wading among them for hours reached a Federal picket boat. For destroying the "Albemarle" he was thanked by Congress and was promoted to be lieutenant-commander. On the 15th of January 1865 he took a conspicuous part in the land attack on the sea-front wall of Fort Fisher. After the war he commanded the "Lancaster" (1866-1867) and the "Maumee" (1868-1869) in the Asiatic Squadron. In 1872 he was promoted commander at what was an exceptionally early age, but he died on the 17th of December 1874 of brain fever. He had suffered extreme pain for years before his death, and in fact broke down altogether under disease contracted in the discharge of his duty.

**CUSHION** (from O. Fr. *coisson*, *coussin*; according to the *New English Dict.*, from Lat. *coxa*, a hip; others say from Lat. *culcita*, a quilt), a soft bag of some ornamental material, stuffed with wool, hair, feathers, or even paper torn into fragments. It may be used for sitting or kneeling upon, or to soften the hardness or angularity of a chair or couch. It is a very ancient article of furniture, the inventories of the contents of palaces and great houses in the early middle ages constantly making mention of it. It was then often of great size, covered with leather, and firm enough to serve as a seat, but the steady tendency of all furniture has been to grow smaller. It was, indeed, used as a seat, at all events in France and Spain, at a very much later period, and in Saint-Simon's time we find that at the Spanish court it was still regarded as a peculiarly honourable substitute for a chair. In France the right to kneel upon a cushion in church behind the king was jealously guarded and strictly regulated, as we may learn again from Saint-Simon. This type of cushion was called

a *carroon* or square. When seats were rude and hard the cushion may have been a necessity; it is now one of the minor luxuries of life.

The term "cushion" is given in architecture to the sides of the Ionic capital. It is also applied to an early and simple form of the Romanesque capitals of Germany and England, which consist of cubical masses, square at the top and rounded off at the four corners, so as to reduce the lower diameter to a circle of the same size as the shaft.

**CUSHMAN, CHARLOTTE SAUNDERS** (1816-1876), American actress, was born in Boston, Massachusetts, on the 23rd of July 1816. Her father, a West India merchant, left his family in straitened circumstances, and Charlotte, who had a fine contralto voice, went on the operatic stage. In 1835 she successfully appeared at the Tremont theatre as the countess Almaviva in *The Marriage of Figaro*. But her singing voice failing her she entered the drama, and played Lady Macbeth in the same year. She then engaged herself as a stock actress, but was soon given leading parts. In 1842 she managed and played in the Walnut Street theatre in Philadelphia. She accompanied Macready on an American tour, winning a great reputation in tragedy, and in 1845 and in 1854-1855 she fulfilled successful engagements in London. She was a keen student, and acquired a large range of classic rôles. Her best parts were perhaps Lady Macbeth and Queen Katherine, her most popular Meg Merrilies, in a dramatization of Scott's *Guy Mannering*. Her figure was commanding and her face expressive, and she was animated by a temperament full of vigour and fire. These qualities enabled her to play with success such male parts as Romeo and Cardinal Wolsey. During her later years Miss Cushman worked hard as a dramatic reader, in which capacity she was much appreciated. Her last appearance on the stage took place on the 15th of May 1875, at the Globe theatre, Boston, in which city she died on the 18th of February 1876.

See Emma Stebbins's *Charlotte Cushman, her Letters and Memories of her Life* (Boston, 1878); H. A. Clapp's *Reminiscences of a Dramatic Critic* (Boston, 1902); and W. T. Price, *A Life of Charlotte Cushman* (New York, 1894).

**CUSP** (Lat. *cuspis*, a spear, point), a projecting point, or pointed end. In architecture (Fr. *feuille*, Ital. *cuspidè*, Ger. *Knöpfe*), a cusp is the point where the foliations of tracery intersect. The earliest example of a plain cusp is probably that at Pythagoras school, at Cambridge,—of an ornamented cusp at Ely cathedral, where a small roll, with a rosette at the end, is formed at the termination of a cusp. In the later styles the terminations of the cusps were more richly decorated; they also sometimes terminate not only in leaves or foliages, but in rosettes, heads and other fanciful ornaments. The term "feathering" is used of the junction of the foliated cusps in window tracery, but is usually restricted to those cases where it is ornamented with foliage, &c.

**CUSTARD<sup>1</sup> APPLE**, a name applied to the fruit of various species of the genus *Anona*, natural order *Anonaceæ*. The members of this genus are shrubs or small trees having alternate, exstipulate leaves, and flowers with three small sepals, six petals arranged in a double row and numerous stamens. The fruit of *A. reticulata*, the common custard apple, or "bullock's heart" of the West Indies, is dark brown in colour, and marked with depressions, which give it a quilted appearance; its pulp is reddish-yellow, sweetish and very soft (whence the name); the kernels of the seeds are said to be poisonous. The sour-sop is the fruit of *A. muricata*, native of the West Indies. The plant, which is a small tree, has become naturalized in some parts of India where it is extensively cultivated, as elsewhere in the tropics. It is covered with soft prickles, is of a light-greenish hue, and has a peculiar but agreeable sour taste, and a scent resembling that of black currants. The sweet-sop is produced by *A. squamosa*, also a native of the West Indies and widely cultivated

<sup>1</sup> The term "custard," now given to a dish made with eggs beaten up with milk, &c., and either served in liquid form or baked to a stiff consistency, originally denoted a kind of open pie. It represents the older form "crustade," Fr. *croûstade*, Ital. *crostata*, from *crostare*, to encrust.

in the tropics. It is known as the custard apple by Europeans in India. It is an egg-shaped fruit, with a thick rind and luscious pulp. An acid principle, fatal to insects, is contained in its seeds, leaves and unripe fruits, which, powdered and mixed with the flour of gram (*Cicer arietinum*), are used to destroy vermin. *A. Cherimolia* yield the Peruvian cherimoyer, which is held to be a fruit of very superior flavour, and is much esteemed by the creoles. *A. palustris*, alligator apple, or cork-wood, a native of South America and the West Indies, is valued for its wood, which serves the same purposes as cork; the fruit, commonly known as the alligator-apple, is not eaten, being reputed to contain a dangerous narcotic principle.

**CUSTER, GEORGE ARMSTRONG** (1839-1876), American cavalry soldier, was born in New Rumley, Harrison county, Ohio, on the 5th of December 1839. He graduated from West Point in 1861, and was at once sent to the theatre of war in Virginia, joining his regiment on the battlefield of Bull Run. Afterwards he served on the staff of General Kearny, and on that of General W. F. Smith in the Peninsular Campaign. His daring and energy, and in particular a spirited reconnaissance on the Chickahominy river, brought him to the notice of General McClellan, who made him an aide-de-camp on his own staff, with the rank of captain. A few hours afterwards Custer attacked a Confederate picket post and drove back the enemy. He continued to serve with McClellan until the general was relieved of his command, when Custer returned to duty with his regiment as a lieutenant. Early in 1863 General Pleasonton selected him as his aide-de-camp, and in June 1863 Custer was promoted to the rank of brigadier-general of volunteers. He distinguished himself at the head of the Michigan cavalry brigade in the battle of Gettysburg, and frequently did good service in the remaining operations of the campaign of 1863. When the cavalry corps of the Army of the Potomac was reorganized under Sheridan in 1864, Custer retained his command, and took part in the various actions of the cavalry in the Wilderness and Shenandoah campaigns. At the end of September 1864, he was appointed to command a division, and on the 9th of October fought, along with General Merritt, the brilliant cavalry action called the battle of Woodstock. Soon afterwards he was made brevet-major-general, U.S.V., having already won the brevets of major, lieutenant-colonel and colonel U.S.A., for his services at Gettysburg, Yellow Tavern and Winchester. His part in the decisive battle of Cedar Creek (*q.v.*) was most conspicuous. He served with Sheridan in the last great cavalry raid, won the action of Waynesboro, and in the final campaign added to his laurels by his conduct at Dinwiddie and Five Forks, and in other operations. At the close of the war he received the brevets of brigadier and major-general in the regular army, and was promoted major-general of volunteers. In 1866 Custer was made lieutenant-colonel of the 7th U.S. Cavalry, and took part under General Hancock in the expedition against the Cheyenne Indians, upon whom he inflicted a crushing defeat at Washita river on the 27th of November 1868. In 1873 he was sent to Dakota Territory to serve against the Sioux.

In 1876 an expedition, of which Custer and his regiment formed part, was made against the Sioux and their allies. As the advanced guard of the troops under General Terry, Custer's force arrived at the junction of Big Horn and Little Big Horn rivers, in what is now the state of Montana, on the night of June 24; the main body was due to join him on the 26th. Unfortunately, the presence of what was judged to be a small isolated force of Indians was reported to the general. On the 25th, dividing his regiment into three parties, he moved forward to surround this force. But instead of meeting only a small force of Indians, the 7th were promptly attacked by the full forces of the enemy. The flanking columns maintained themselves with difficulty until Terry came up. Custer and 264 men of the centre column rode into the midst of the enemy and were slaughtered to a man.

The general's wife, ELIZABETH BACON CUSTER, who accompanied him in many of his frontier expeditions, wrote *Boots and Saddles, Life with General Custer in Dakota* (1885), *Tenting on the*

*Plains* (1887) and *Following the Guidon* (1891). General Custer himself wrote *My Life on the Plains* (1874).

See F. Whittaker, *Life of General George A. Custer* (1876).

His brother THOMAS WARD CUSTER (1845-1876), in spite of his youth, fought in the early campaigns of the Civil War. Becoming aide-de-camp to General Custer, he accompanied him throughout the latter part of the war, distinguishing himself by his daring on all occasions, and winning successively the brevets of captain, major and lieutenant-colonel, though he was barely twenty years of age when the war ended. He was first lieutenant in the 7th cavalry when he fell with his brother at the Little Big Horn.

**CUSTINE, ADAM PHILIPPE, COMTE DE** (1740-1793), French general, began his military career in the Seven Years' War. He next served with distinction against the English in the War of American Independence. In 1789 he was elected to the states-general by the *bailliage* of Metz. In October 1791 he again joined the army, with the rank of lieutenant-general and became popular with the soldiers, amongst whom he was known as "*général moustache*." General-in-chief of the army of the Vosges, he took Spire, Worms, Mainz and Frankfort in September and October 1792. He carried on the revolutionary propaganda by proclamations, and levied heavy taxes on the nobility and clergy. During the winter a Prussian army forced him to evacuate Frankfort, re-cross the Rhine and fall back upon Landau. He was accused of treason, defended by Robespierre, and sent back to the army of the north. But he dared not take the offensive, and did nothing to save Condé, which the Austrians were besieging. Sent to Paris to justify himself, he was found guilty by the Revolutionary Tribunal of having intrigued with the enemies of the republic, and guillotined on the 28th of August 1793. (See FRENCH REVOLUTIONARY WARS.)

See A. Rambaud, *Les Français sur le Rhin* (Paris, 1880); A. Chuquet, *Les Guerres de la Révolution* (1886-1895; vol. vi. "L'Expédition de Custine").

**CUSTOM** (from O. Fr. *custume, costume* or *coustume*; Low Lat. *costuma*, a shortened form of *consuetudo*), in general, a habit or practice. Thus a tradesman calls those who deal with him his "customers," and the trade resulting as their "custom." The word is also used for a toll or tax levied upon goods; there was at one time a distinction between the tax on goods exported or imported, termed *magna custuma* (the great custom), and that on goods taken to market within the realm, termed *parva custuma* (the little custom), but the word is now used in this sense only in the plural, to signify the duties levied upon imported goods. It is also used as a name for that department of the public service which is employed in levying the duty.

In law, such long-continued usage as has by common consent become a rule of conduct is termed custom. Jessel, M. R. (*Hammerton v. Honey*, 24 W. R. 603), has defined it as "local common law. It is common law because it is not statute law; it is local law because it is the law of a particular place, as distinguished from the general common law. Local common law is the law of the country (*i.e.* particular place) as it existed before the time of legal memory." There has been much discussion among jurists as to whether custom can properly be reckoned a source of law (see JURISPRUDENCE). As to the distinction between prescription (which is a personal claim) and custom, see PRESCRIPTION. The adoption of local customs by the judiciary has undoubtedly been the origin of a great portion of the English common law. Blackstone divides custom into (1) general, which is the common law properly so called, and (2) particular, which affects only the inhabitants of particular districts. The requisites necessary to make a particular custom good are: (1) it must have been used so long that the memory of man runneth not to the contrary; (2) it must have been continued, and (3) enjoyed peaceably; (4) it must be reasonable, and (5) certain; (6) it must be compulsory, and not left to the option of every man whether he will use it or no; (7) it must be consistent with other customs, for one custom cannot be set up in opposition to another. Customs may be of various kinds, for example, customs of merchants, customs of a certain district

(such as gavelkind and borough English), customs of a particular manor, &c. The word custom is also generally employed for the *usage* of a particular trade or market; for a trade custom to be established to the satisfaction of the law it must be a uniform and universal practice so well defined and recognized that contracting parties must be assumed to have had it in their minds when they contracted (Russell, C. J., *Fox-Bourne v. Vernon*, 10 *Times Rep.* 649).

In the history of France the term "custom" was given to those special usages of different districts which had grown up into a body of local law, as the "custom of Paris," the "custom of Normandy" (see FRANCE: *Law and Institutions*).

**CUSTOMARY FREEHOLD**, in English law, a species of tenure which may be described as a variety of copyhold. It is also termed privileged copyhold or copyhold of frank tenure. It is a tenure by copy of court roll, but not expressed to be at the will of the lord. It is, in fact, only a superior kind of copyhold, and the freehold is in the lord. It is subject to the general law of copyholds, except where the law may be varied by the custom of the particular manor. (See COPYHOLD.)

**CUSTOM-HOUSE**, the house or office appointed by a government where the taxes or duties (if any) are collected upon the importation and exportation of commodities; where duties, bounties or drawbacks payable or receivable upon exportation or importation are paid or received, and where vessels are entered and cleared. In the United Kingdom there is usually a custom-house established at every port or harbour to which any considerable amount of shipping resorts, the officer in charge being called "collector of customs"; in the minor ports the officer is usually termed "superintendent of customs" or "principal coast officer."

**CUSTOMS DUTIES**, the name given to taxes on the import and export of commodities. They rank among the most ancient, as they continue to prevail as one of the most common modes, in all countries, of levying revenue for public purposes. In an insular country like the United Kingdom customs duties came in process of time to be levied only or chiefly in the seaports, and thus applied only to the foreign commerce, where they may be brought under the control of fair and reasonable principles of taxation. But this simplification of customs duties was only reached by degrees; and during a long period special customs were levied on goods passing between England and Scotland; and the trade of Ireland with Great Britain and with foreign countries was subjected to fiscal regulations which could not now stand in the light of public reason. The taxes levied, on warrant of some ancient grant or privilege, upon cattle or goods at a bridge or a ferry or other point of passage from one county or province to another, of which there are some lingering remains even in the United Kingdom, and those levied at the gates of cities on the produce of the immediate country—a not uncommon form of municipal taxation on the European continent—are all of the nature of customs dues. It is from the universality of this practice that the English term "customs" appears to have been derived.

See TAXATION; PROTECTION; TARIFF.

**CUSTOS ROTULORUM**, the keeper of the English county records, and by virtue of that office the highest civil officer in the county. The appointment until 1545 lay with the lord chancellor, but is now exercised by the crown under the royal sign-manual, and is usually held by a person of rank, most frequently the lord-lieutenant of the county. He is one of the justices of the peace. In practice the records are in the custody of the clerk of the peace. This latter official was, until 1888, appointed by the *custos rotulorum*, but since the passing of the Local Government Act of that year, the appointment is made by the standing joint-committee of the county council. Lambarde described the *custos rotulorum* as a "man for the most part especially picked out either for wisdom, countenance or credit."

**CUSTOZZA**, a village of Italy, in the province of Verona, 11 m. S.W. of Verona, famous as the scene of two battles between the Austrians and the Italians in the struggle for Italian unity. The first battle of Custozza was fought on the 23rd-25th of July

1848, the Austrians commanded by Field-Marshal Radetzky being victorious over the Piedmontese army under King Charles Albert. The second battle was fought on the 24th of June 1866, and resulted in the complete victory of the Austrians under the archduke Albert, over the Italian army of King Victor Emmanuel I. (See ITALIAN WARS, 1848-1870.)

**CÜSTRIN**, or KÜSTRIN, a town of Germany, in the kingdom of Prussia, a fortress of the first rank, at the confluence of the Oder and Warthe, 18 m. N.E. from Frankfort-on-Oder and 51 m. N.E. of Berlin by rail. Pop. (1900) 16,473 (including the garrison). It consists of the town proper within the strong fortifications, a suburb on the left bank of the Oder, and one on the right bank of the Warthe. There are three Evangelical churches and one Roman Catholic, and a handsome town hall. There are bridges over both rivers. Cüstrin has some manufactories of potato-meal, machinery, pianos, furniture, cigars, &c., and there is a considerable river trade.

About 1250 a town was erected on the site of Cüstrin, where a fishing village originally stood. From 1535 till 1571 it was the residence of John, margrave of Brandenburg-Cüstrin, who died without male heirs in 1571. Cüstrin was the prison of Frederick the Great when crown-prince, and the scene of the execution of his friend Hans Hermann von Katte on the 6th of November 1730.

**CUTCH**, or KACH, a native state of India within the Gujarat division of Bombay, with an area of 7616 sq. m. It is a peninsular tract of land, enclosed towards the W. by the eastern branch of the Indus, on the S. by the Indian Ocean and the Gulf of Cutch, and on the N. and E. towards the interior, by the great northern Runn, a salt morass or lake. The interior of Cutch is studded with hills of considerable elevation, and a range of mountains runs through it from east to west, many of them of the most fantastic shapes, with large isolated masses of rock scattered in all directions. The general appearance of Cutch is barren and uninteresting. The greater part is a rock destitute of soil, and presenting the wildest aspect; the ground is cold, poor and sterile; and the whole face of the country bears marks of volcanic action. From the violence of tyranny, and the rapine of a disorderly banditti, by which this district long suffered, as well as from shocks of earthquakes, the villages have a ruinous and dilapidated appearance; and, with the exception of a few fields in their neighbourhood, the country presents a rocky and sandy waste, with in many places scarcely a show of vegetation. Water is scarce and brackish, and is chiefly found at the bottom of low ranges of hills, which abound in some parts; and the inhabitants of the extensive sandy tracts suffer greatly from the want of it. Owing to the uncertainty of the periodical rains in Cutch, the country is liable to severe famines, and it has suffered greatly from plague.

The temperature of Cutch during the hot season is high, the thermometer frequently rising to 100° or 105° F.; and in the months of April and May clouds of dust and sand, blown about by hurricanes, envelop the houses, the glass windows scarcely affording any protection. The influence of the monsoon is greatly moderated before it reaches this region, and the rains sometimes fail altogether. Bhuj, the capital of the state, is situated inland, and is surrounded by an amphitheatre of hills, some of which approach within 3 or 4 m. of the city. The hill of Bhuj, on which the fort is situated, rises to the height of 500 ft. in the middle of the plain, and is detached from other high ground. The residency is 4 m. distant in a westerly direction. There are many mountain streams, but no navigable rivers. They contain scarcely any water except in the rainy season, when they are very full and rapid, and discharge themselves into the Runn, all along the coast of which the wells and springs are more or less impregnated with common salt and other saline ingredients.

Various causes have contributed to thin the population of this country. In 1813 it was ravaged by a famine and pestilence, which destroyed a great proportion of its inhabitants,—according to some accounts, nearly one-half. This, joined to the tyranny and violence of the government until the year 1819, and subsequently to a succession of unfavourable seasons, forced many

of the cultivators to remove to Sind and other countries. The inhabitants numbered 488,022 in 1901, being a decrease of 13% during the decade, due to the famines of 1899-1900. One-third are Mahomedans and the remainder Hindus of various castes. The Jareja Rajputs form a particular class, being the aristocracy of the country; and all are more or less connected with the family of the rao or prince. There are in Cutch about 200 of these Jareja chiefs, who all claim their descent from a prince who reigned in Sind about 1000 years ago. From him also the reigning sovereign is lineally descended, and he is the liege lord of whom all the chiefs or nobles hold their lands in feu, for services which they or their ancestors had performed, or in virtue of their relationship to the family. They are all termed the brotherhood of the rao or Bhayad, and supposed to be his hereditary advisers, and their possessions are divided among their male children. To prevent the breaking down of their properties, the necessary consequence of this law of inheritance, there is no doubt that infanticide was common among them, and that it extended to the male as well as the female progeny, but it has been put down by the Infanticide Rules, which provide for the registration of Jareja children. The Jarejas have a tradition that when they entered Cutch they were Mahomedans, but that they afterwards adopted the customs and religion of the Hindus. It is certain, indeed, that they still retain many Mahomedan customs. They take oaths equally on the Koran or on the Shastras; they employ Mussulman books; they eat from their hands; the rao, when he appears in public, alternately worships God in a Hindu pagoda and a Mahomedan mosque; and he fits out annually at Mandvi a ship for the conveyance of pilgrims to Mecca, who are maintained during the voyage chiefly by the liberality of the prince. The Mahomedans in Cutch are of the same degenerate class as those usually found in the western parts of India. The natives are in general of a stronger and stouter make, and even handsomer, than those of western India; and the women of the higher classes are also handsome. The peasants are described as intelligent, and the artizans are justly celebrated for their ingenuity and mechanical skill. The palace at Mandvi, and a tomb of one of their princes at Bhuj, are fair specimens of their architectural skill. The estimated gross revenue is £126,322. There are special manufactures of silver filigree-work and embroidery. The maritime population supplies the best sailors in India. There are cotton presses and ginning factories.

The country of Cutch was invaded about the 13th century by a body of Mahomedans of the Summa tribe, who under the guidance of five brothers emigrated from Sind, and who gradually subdued or expelled the original inhabitants, consisting of three distinct races. Cutch continued tranquil under their sway for many years, until some family quarrel arose, in which the chief of an elder branch of the tribe was murdered by a rival brother. His son Khengayi fled to Ahmedabad to seek the assistance of the viceroy, who reinstated him in the sovereignty of Cutch, and Morvi in Kathiawar, and in the title of rao, about the year 1540. The succession continued in the same line from the time of this prince until 1697, when a younger brother, Pragji, murdered his elder brother and usurped the sovereignty. This line of princes continued till 1760 without any remarkable event, when, in the reign of Rao Ghodji, the country was invaded four times by the Sinds, who wasted it with fire and sword. The reign of this prince, as well as that of his son Rao Rayadan; by whom he was succeeded in 1778, was marked by cruelty and blood. The latter prince was dethroned, and, being in a state of mental derangement, was during his lifetime confined by Fateh Mahommed, a native of Sind, who continued, with a short interval (in which the party of the legal heir, Bhaji Bawa, gained the ascendancy), to rule the country until his death in 1813. It was in the reign of Fateh Mahommed that a communication first took place with the British government. During the contests for the sovereignty between the usurper and the legal heir, the leader of the royal party, Hansraj, the governor of Mandvi, sought the aid of the British. But no closer connexion followed at that time than an agreement for the suppression of piracy, or of inroads of troops to the eastward of the Runn or Gulf of

Cutch. But the gulf continued notwithstanding to swarm with pirates, who were openly encouraged or connived at by the son of Hansraj, who had succeeded his father, as well as by Fateh Mahommed. The latter left several sons by different wives, who were competitors for the vacant throne. Husain Miyan succeeded to a considerable portion of his father's property and power. Jugjevan, a Brahman, the late minister of Fateh Mahommed, also received a considerable share of influence; and the hatred of these two factions was embittered by religious animosities, the one being Hindu and the other Mahomedan. The deceased rao had declared himself a Mahomedan, and his adherents were preparing to inter his body in a magnificent tomb, when the Jarejas and other Hindus seized the corpse and consigned it to the flames, according to Hindu custom.

The administration of affairs was nominally in the hands of Husain Miyan and his brother Ibrahim Miyan. Many sanguinary broils now ensued, in the course of which Jugjevan was murdered, and the executive authority was much weakened by the usurpations of the Arabs and other chiefs. In the meantime Ibrahim Miyan was assassinated; and after various other scenes of anarchy, the rao Bharmulji, son of Rao Rayadan, by general consent, assumed the chief power. But his reign was one continued series of the grossest enormities; his hostility to the British became evident, and accordingly a force of 10,500 men crossed the Runn in November 1815, and were within five miles of Bhuj, the capital of the country, when a treaty was concluded, by which the rao Bharmulji was confirmed in his title to the throne, on agreeing, among other stipulations, to cede Anjar and its dependencies in perpetuity to the British. He was, however, so far from fulfilling the terms of this treaty that it was determined to depose him; and an army being sent against him, he surrendered to the British, who made a provision for his maintenance, and elevated his infant son Desalji II. to the throne (1819).

In 1822 the relations subsisting between the ruler of Cutch and the British were modified by a new treaty, under which the territorial cessions made by the rao in 1816 were restored in consideration of an annual payment. The sum fixed was subsequently thought too large, and in 1852 the arrears, amounting to a considerable sum, were remitted, and all future payments on this account relinquished. From that time the rao has paid a subsidy of £13,000 per annum to the British for the maintenance of the military force stationed within his dominions.

Rao Desalji II. did much to suppress infanticide, suttee and the slave trade in his state. His successor Maharao Pragmalji in recognition of his excellent administration was in 1871 honoured with the title of knight grand commander of the Star of India. During his rule harbour works were built at Mandvi, an immense reservoir for rain water in the Chadwa hills was constructed, and many schools and colleges were endowed. In 1876 he was succeeded by Maharaja Rao Khengarji III., who was also a keen advocate for education and especially the education of women. He founded museums, libraries and schools, and inaugurated scholarships and a fund from which deserving scholars desirous of studying in England and America could obtain their expenses.

**CUTCH, GULF OF**, an inlet of the sea on the coast of western India. It lies between the peninsula of Kathiawar and that of Cutch, leading into the Runn of Cutch.

**CUTCH, RUNN OF**, or RANN OF KACH, a salt morass on the western coast of India in the native state of Cutch. From May to October it is flooded with salt water and communicates, at its greatest extent, with the Gulf of Cutch on the west and the Gulf of Cambay on the east, these two gulfs being united during the monsoon. It varies in breadth from five to eighty miles across, and during the rains is nearly impassable for horsemen. The total area of this immense morass is estimated at about 8000 sq. m., without including any portion of the Gulf of Cutch, which is in parts so shallow as to resemble a marshy fen rather than an arm of the sea. The Runn is said to be formed by the overflow of the rivers Pharan, Luni, Banas and others, during the monsoon; but in December it is quite dry, and in most places hard, but in some moist and muddy. The soil is impregnated



with salt, and the Rumm is an important source for the supply of salt. The present condition of the Rumm is probably the result of some natural convulsion, but the exact method of its formation is disputed. The wild ass is very common on the borders of this lake, being seen in herds of 60 or 70 together.

**CUTHBERT, SAINT** (d. 687), bishop of Lindisfarne, was probably a Northumbrian by birth. According to the extant *Lives* he was led to take the monastic vows by a vision at the death of bishop Aidan, and the date of his entry at Melrose would be 651. At this time Eata was abbot there, and Boisel, who is mentioned as his instructor, prior, in which office Cuthbert succeeded him about 661, having previously spent some time at the monastery of Ripon with Eata. Bede gives a glowing picture of his missionary zeal at Melrose, but in 664 he was transferred to act as prior at Lindisfarne. In 676 he became an anchorite on the island of Farne, and it is said that he performed miracles there. In 684 at the council of Twyford in Northumberland, Egfrith, king of Northumbria, prevailed upon him to give up his solitary life and become a bishop. He was consecrated at York in the following year as bishop of Hexham, but afterwards he exchanged his see with Eata for that of Lindisfarne. In 687 he retired to Farne, and died on the island on the 20th of March 687; the same day as his friend Hereberht, the anchorite of Derwentwater. He was buried in the island of Lindisfarne, but his remains were afterwards deposited at Chester-le-Street, and then at Durham.

Another Cuthbert was bishop of Hereford from 736 to about 740, and archbishop of Canterbury from the latter date until his death in October 758.

There are several lives of St Cuthbert, the best of which is the prose life by Bede, which is published in Bede's *Opera*, edited by J. Stevenson (1841). See also C. Eyre, *The History of St Cuthbert* (1887); and J. Raine, *St Cuthbert* (1828).

**CUTLASS**, the naval side-arm, a short cutting sword with a slightly curved blade, and a solid basket-shaped guard (see **SWORD**). The word is derived from the Fr. *couteas*, or *couteace*, a form of *couteil*, modern *couteau*, a knife, from Lat. *cultellus*, diminutive of *culter*, a ploughshare, or cutting instrument. Two variations appear in English: "curtelace," where the *r* represents probably the *l* of the original Latin word, or is a further variant of the second variation; and "curtelaxe," often spelled as two words, "curtal axe," where the prefix *curtal* is confused with various English words such as "curtan," "curtal" and "curtail," which all mean "shortened," and are derived from the Lat. *curtus*; the word thus wrongly derived has been supposed to refer to some non-existent form of battle-axe. In every case the weapon to which these various forms apply is a broad cutting or slashing sword.

**CUTLER, MANASSEH** (1742-1823), American clergyman, was born in Killingly, Connecticut, on the 13th of May 1742. He graduated at Yale College in 1765, and after being a school teacher and a merchant, and occasionally appearing in the courts as a lawyer, he decided to enter the ministry, and from 1771 until his death was pastor of the Congregational church at what is now Hamilton, but until 1793 was a parish of Ipswich, Massachusetts. During the War of Independence he was for several months in 1776 chaplain to the regiment of Colonel Ebenezer Francis, raised for the defence of Boston; and in 1778, as chaplain to the brigade of General Jonathan Titcomb (1728-1817), he took part in General John Sullivan's expedition to Rhode Island. Soon after his return from this expedition he fitted himself for the practice of medicine, in order to supplement the scanty income of a minister, and in 1782 he established a private boarding school, which he conducted for about a quarter of a century. In 1786 he became interested in the settlement of western lands, and in the following year, as agent of the Ohio Company (*q.v.*), which he had taken a prominent part in organizing, he made a contract with Congress, whereby his associates, former soldiers in the War of Independence, might purchase, with the certificates of indebtedness issued to them by the government for their services, 1,500,000 acres of land in the region north of the Ohio at the mouth of the Maskingum

river. He also took a leading part in drafting the famous Ordinance of 1787 for the government of the Northwest Territory, the instrument as it was finally presented to Congress by Nathan Dane (1752-1835), a Massachusetts delegate, probably being largely Cutler's work. From 1801 to 1805 he was a Federalist representative in Congress. He died at Hamilton, Massachusetts, on the 28th of July 1823. A versatile man, Cutler was one of the early members of the American Academy of Arts and Sciences, and besides being proficient in the theology, law and medicine of his day, conducted painstaking astronomical and meteorological investigations, and was one of the first Americans to make researches of a real scientific value in botany. In 1789 the degree of doctor of laws was conferred upon him by Yale.

See William P. and Julia P. Cutler, *The Life, Journals, and Correspondence of Manasseh Cutler* (2 vols., Cincinnati, 1888); and an article, "The Ordinance of 1787 and Dr Manasseh Cutler," by W. F. Poole, in vol. 122 of the *North American Review*.

**CUTLERY** (Fr. *coutellerie*, from the Lat. *cultellus*, a little knife), a branch of industry which originally embraced the manufacture of all cutting instruments of whatever form or material. The progress of manufacturing industry has, however, detached from it the fabrication of several kinds of edge-tools, saws and similar implements, the manufacture of which is now regarded as forming distinct branches of trade. On the other hand modern cutlery includes a great number of articles which are not strictly cutting instruments, but which, owing to their more or less intimate relation to table or pocket cutlery, are classed with such articles for convenience' sake. A steel table or carving fork, for example, is an important article of cutlery, although it is not a cutting tool.

The original cutting instruments used by the human race consisted of fragments of flint, obsidian, or similar stones, rudely flaked or chipped to a cutting edge; and of these tools numerous remains yet exist. Stone knives and other tools must have been employed for a long period by the prehistoric races of mankind, as their later productions show great perfection of form and finish. In the Bronze period, which succeeded the Stone Age, the cutlery of our ancestors was fabricated of that alloy. The use of iron was introduced at a later but still remote period; and it now, in the form of steel, is the staple article from which cutlery is manufactured.

From the earliest period in English history the manufacture of cutlery has been peculiarly associated with the town of Sheffield, the prominence of which in this manufacture in his own age is attested by Chaucer, who says of the miller of Trumpington—

"A Sheffield thwitel baar he in his hoe."

That town still retains a practical monopoly of the ordinary cutlery trade of Great Britain, and remains the chief centre of the industry for the whole world. Its influence on methods of production has also been widely extended; for instance, many Sheffield workmen emigrated to the United States of America to take part in the manufacture of pocket-knives when it was started in Connecticut towards the middle of the 19th century.

The thwitel or whittle of Chaucer's time was a very poor made implement, consisting of a blade of bar steel fastened into a wooden or horn handle. It was used for cutting food as well as for the numerous miscellaneous duties which now fall to the pocket-knife. To the whittle succeeded the Jack knife,—the Jacques-de-Liège, or Jock-te-leg of the Scottish James VI;—which formed the prototype of the modern clasp-knife, inasmuch as the blade closed into a groove in the handle. About the beginning of the 17th century, the pocket-knife with spring back was introduced, and no marked improvement thereafter took place till the early part of the 19th century. In 1624, two centuries after the incorporation of the Cutlers' Company of London, the cutlers of Hallamshire—the name of the district of which Sheffield is the centre—were formed into a body corporate for the protection of the "industry, labour, and reputation" of the trade, which was being disgraced by the "deceitful and unworkmanlike wares of various persons." The act of incorporation specifies the manufacture of "knives, scissors, shears, sickles and

other cutlery," and provides that all persons engaged in the business shall "make the edge of all steel implements manufactured by them of steel, and steel only, and shall strike on their wares such mark, and such only, as should be assigned to them by the officers of the said company." Notwithstanding these regulations, and the pains and penalties attached to their infringement, the corporation was not very successful in maintaining the high character of Sheffield wares. Most manufacturers made cutlery to the order of their customers, on which the name of the retailer was stamped, and very inferior malleable or cast iron blades went forth to the public with "London made," "best steel," and other falsehoods stamped on them to order. The corporate mark and name of a few firms, among which Joseph Rodgers & Sons stand foremost, are a guarantee of the very highest excellence of material and finish; and such firms decline to stamp any name or mark other than their own on their manufactures. In foreign markets, however, the reputation of such firms is much injured by impudent forgeries; and so far was this system of fraud carried that inferior foreign work was forwarded to London to be transhipped and sent abroad ostensibly as English cutlery. To protect the trade against frauds of this class the Trades Mark Act of 1862 was passed chiefly at the instigation of the Sheffield chamber of commerce.

The variety of materials which go to complete any single article of cutlery is very considerable; and as the stock list of a cutler embraces a vast number of articles different in form, properties and uses, the cutlery manufacturer must have a practical knowledge of a wide range of substances. The leading articles of the trade include carving and table knives and forks, pocket or clasp knives, razors, scissors, daggers, hunting knives and similar articles, surgical knives and lancets, butchers' and shoemakers' knives, gardeners' pruning-knives, &c. The blades or cutting portions of a certain number of these articles are made of shear steel, and for others crucible cast steel is employed. Sometimes the cutting edge alone is of steel, backed or strengthened with iron, to which it is welded. The tang, or part of the blade by which it is fastened to the handles, and other non-cutting portions, are also very often of iron. Brass, German silver, silver, horn, tortoise-shell, ivory, bone, mother-of-pearl, and numerous fancy woods are all brought into requisition for handles and other parts of cutlery, each demanding special treatment according to its nature. The essential processes in making a piece of steel cutlery are (1) forging, (2) hardening and tempering, (3) grinding, (4) polishing, and (5) putting together the various pieces and finishing the knife, the workmen who perform these last operations being the only ones known in the trade as "cutlers."

The following outline of the stages in the manufacture of a razor will serve to indicate the sequence of operations in making an article which, though simple in form, demands the highest care and skill. The first essential of a good razor is that it be made of the finest quality of cast steel. The steel for razors is obtained in bars the thickness of the back of the instrument. Taking such a bar, the forger heats one end of it to the proper forging temperature, and then dexterously fashions it upon his anvil, giving it roughly the required form, edge and concavity. It is then separated from the remainder of the bar, leaving only sufficient metal to form the tang, if that is to be made of steel. The tang of the "mould," as the blade in this condition is termed, is next drawn out, and the whole "smithed" or beaten on the anvil to compact the metal and improve the form and edge of the razor. At this stage the razor is said to be "forged in the rough," and so neatly can some workmen finish off this operation that a shaving edge may be given to the blade by simple whetting. The forged blade is next "shaped" by grinding on the dry stone; this operation considerably reduces its weight, and removes the oxidized scale, thereby allowing the hardening and tempering to be done with certainty and proper effect. The shaped razor is now returned to the forge, where the tang is file-cut and pierced with the joint-hole, and into the blade is stamped either the name and corporate mark of the maker, or any mark and name ordered by the tradesman for whom the goods are being manufactured. The hardening is accomplished by heating the blade to a cherry-

red heat and suddenly quenching it in cold water, which leaves the metal excessively hard and brittle. To bring it to the proper temper for a razor, it is again heated till the metallic surface assumes a straw colour, and after being plunged into water, it is ready for the process of wet grinding. The wet grinding is done on stones which vary in diameter from 1½ to 12 in. according to the concavity of surface desired ("hollow-ground," "half hollow-ground," &c.). "Lapping," which is the first stage in polishing, is performed on a wheel of the same diameter as the wet-grinding stone. The lap is built up of segments of wood having the fibres towards the periphery, and covered with a metallic alloy of tin and lead. The lap is fed with a mixture of emery powder and oil. "Glazing" and "polishing," which follow, are for perfecting the polish on the surface of the razor, leather-covered wheels with fine emery being used; and the work is finished off with crocus. The finished blade is then riveted into the scales or handle, which may be of ivory, bone, horn or other material; and when thereafter the razor is set on a hone it is ready for use.

The processes employed in making a table-knife do not differ essentially from those required for a razor. Table-knife blades are forged from shear and other steels, and, if they are not in one piece, a bit of malleable iron sufficient for the bolster or shoulder and tang is welded to each, often by machinery, especially in the case of the cheaper qualities. The bolster is formed with the aid of a die and swage called "prints," and the tang is drawn out. The tang is variously formed, according to the method by which it is to be secured in the haft, and the various processes of tempering, wet grinding and polishing are pursued as described above. Steel forks of an inferior quality are cast and subsequently cleaned and polished; but the best quality are forged from bar steel, and the prongs are cut or stamped out of an extended flattened extremity called the mould or "mood." In the United States of America machinery has been extensively adopted for performing the various mechanical operations in forging and fitting table cutlery, and in Sheffield it is employed to a great extent in the manufacture of table and pocket knife blades, scissors and razors. The cutler of the 18th century was an artisan who forged and ground the blades and fitted them in the hafts ready for sale; to-day the division of labour is carried to an extreme degree. In the making of a common pocket-knife with three blades not fewer than one hundred separate operations are involved, and these may be performed by as many workmen composed of five distinct classes—the scale and spring makers (the scale being the metal lining which is covered by the handle proper), the blade forgers, the grinders, the cutters of the coverings of ivory, horn, &c., that form the handles, and the hafters or cutlers proper. Grinders are divided into three classes—dry, wet and mixed grinders, according as they work at dry or wet stones. This branch of trade is, in Sheffield, conducted in distinct establishments called "wheels," which are divided up into separate apartments or "hulls," the dry grinding being as much as possible separated from the wet grinding. Dry grinding, such as is practised in the shaping of razors described above, the "humping" or rounding of scissors, and other operations, used to be a process especially dangerous to health, lung diseases being induced by the fine dust of silica and steel with which the atmosphere was loaded; but a great improvement has been effected by resorting to wet grinding as much as possible, by arranging fans to remove the dust by suction, and by general attention to sanitary conditions.

**CUTTACK**, a city and district of British India in the Orissa division of Bengal. The city is situated at the head of the delta of the Mahanadi. Pop. (1901) 51,364. It is the centre of the Orissa canal system, and an important station on the East Coast railway from Madras to Calcutta. It contains the government college, named after Mr Ravenshaw, a former commissioner; a high school, a training school, a survey school, a medical school and a law school. The city formed one of the five royal strongholds of ancient Orissa and was founded by a warlike Hindu prince, Makar Kesari, who reigned from 953 to 961. Native kings protected it from the rivers by a masonry embankment several miles long, built of enormous blocks of hewn stone, and

in some places 25 ft. high. A fortress defended the north-west corner of the town, and was captured by the English from the Mahrattas in October 1803. It is now abandoned as a place of defence.

The DISTRICT OF CUTTACK lies in the centre of Orissa, occupying the deltas of the Mahanadi and Brahmani, together with a hilly tract inland. Its area is 3654 sq. m. It consists of three physical divisions: first, a marshy woodland strip along the coast, from 3 to 30 m. in breadth; second, an intermediate stretch of rice plains; third, a broken hilly region, which forms the western boundary of the district. The marshy strip along the coast is covered with swamps and malaria-breeding jungles. Towards the sea the solid land gives place to a vast network of streams and creeks, whose sluggish waters are constantly depositing silt, and forming morasses or quicksands. Cultivation does not begin till the limits of this dismal region are passed. The intermediate rice plains stretch inland for about 40 m. and occupy the older part of the delta between the sea-coast strip and the hilly frontier. They are intersected by three large rivers, the Baitarani, Brahmani and Mahanadi. These issue in magnificent streams through three gorges in the frontier hills. The Cuttack delta is divided into two great valleys, one of them lying between the Baitarani and the Brahmani, the other between the Brahmani and the Mahanadi. The rivers having, by the silt of ages, gradually raised their beds, now run along high levels. During floods they pour over their banks upon the surrounding valleys, by a thousand channels which interlace and establish communication between the main streams. After numerous bifurcations they find their way into the sea by three principal mouths. Silt-banks and surf-washed bars render the entrance to these rivers perilous. The best harbour in Cuttack district is at False Point, on the north of the Mahanadi estuary. It consists of an anchorage, land-locked by islands or sand-banks, and with two fair channels navigable towards the land. The famine commissioners in 1867 reported it to be the best harbour on the coast of India from the Hugli to Bombay.

The intermediate tract is a region of rich cultivation, dotted with great banyan trees, thickets of bamboos, exquisite palm foliage and mango groves. The hilly frontier separates the delta of British Orissa from the semi-independent tributary states. It consists of a series of ranges, 10 to 15 m. in length, running nearly due east and west, with densely-wooded slopes and lovely valleys between. The timber, however, is small, and is of little value except as fuel. The political character of these three tracts is as distinct as are their natural features. The first and third are still occupied by feudal chiefs, and have never been subjected to a regular land-settlement, by either the Mussulman or the British government. They pay a light fixed tribute. The intermediate rice plains, known as the Mogholbandi, from their having been regularly settled by the Mahommedans, have yielded to the successive dynasties and conquerors of Orissa almost the whole of the revenues derived from the province. The deltaic portions are of course a dead level; and the highest hills within the district in the western or frontier tract do not exceed 2500 ft. They are steep, and covered with jungle, but can be climbed by men. The most interesting of them are the Assa range, with its sandal trees and Buddhist remains; Udayagiri (Sunrise-hill), with its colossal image of Buddha, sacred reservoir, and ruins; and Assagiri, with its mosque of 1719. The Mahavi-nayaka peak, visible from Cuttack, has been consecrated for ages to Siva-worship by ascetics and pilgrims.

The population of the district in 1901 was 2,062,758, showing an increase of 6% in the preceding decade. The aboriginal tribes here, as elsewhere, cling to their mountains and jungles. They chiefly consist of the Bhumij, Tala, Kol and Savara peoples, the Savaras being by far the most numerous, numbering 14,775. They are regarded by the orthodox Hindus as little better than the beasts of the wildernesses which they inhabit. Miserably poor, they subsist for the most part by selling firewood or other products of their jungle; but a few of them have patches of cultivated land, and many earn wages as day labourers to the Hindus. They occupy, in fact, an intermediate stage of de-

gradation between the comparatively well-to-do tribes in the tributary states (the stronghold and home of the race), and the Pans, Bauris, Kandrass and other semi-aboriginal peoples on the lowlands, who rank as the basest castes of the Hindu community. The great bulk of the Indo-Aryan or Hindu population consists of Uriyas, with a residue of immigrant Bengalis, Lala Kayets from Behar and northern India, Telingas from the Madras coast, Mahrattas from central and western India, a few Sikhs from the Punjab and Marwaris from Rajputana. The Mahommedans are chiefly the descendants of the Pathans who took refuge in Orissa after the subversion of their kingdom in Bengal by the Moguls in the 16th century.

Rice forms the staple product of the district; its three chief varieties are *biali* or early rice, *sarad* or winter rice, and *dalua* or spring rice. The other cereal crops consist of *mandua* (a grass-like plant producing a coarse grain resembling rice), wheat, barley, and *china*, a rice-like cereal. *Suan*, another rice-like cereal, not cultivated, grows spontaneously in the paddy fields. Pulses of different sorts, oilseeds, fibres, sugar-cane, tobacco, spices and vegetables also form crops of the district. The cultivators consist of two classes—the resident husbandmen (*thani*) and the non-resident or migratory husbandmen (*pahé*).

The Orissa canal system, which lies mainly within Cuttack district, is used both for irrigation and transport purposes. The railway across the district towards Calcutta, a branch of the Bengal-Nagpur system, was opened in 1899. Considerable trade is carried on at the mouth of the rivers along the coast.

**CUTTLE-FISH.** The more familiar and conspicuous types of the molluscan class Cephalopoda (*q.v.*) are popularly known in English as cuttle-fish, squid, octopus and nautilus. The first of these names (from the A.S. *cuðele*) is applied more particularly to the common *Sepia* (fig. 1), characterized by its internal calcareous shell, sometimes known as cuttle-bone, and its ink-sac, the contents of which have been long in use as a pigment (*sepia*). The term squid is employed among fishermen for the ten-armed Cephalopods in which the shell is represented by an uncalcified flexible structure somewhat resembling a pen. Hence in Italian a squid is called *calamaio*, from *calamus* a reed or pen, and in English the similar term calamary is sometimes used. Like the *Sepia*, squids also possess the ink-sac, whence they have sometimes been called pen and ink fish, and in German both *Sepia* and squid and their allies are known as *Tinten-fische*. The squids have generally softer and more watery tissues than the *Sepia*, but the former term is not in general use, and the distinction not generally understood. The term cuttle-fishes is sometimes extended to include all the Cephalopoda, but as the peculiarities of the remarkable shell of the true nautilus, and those of the shell-less Octopoda are widely known, we shall consider the name here as applying only to those forms which have ten arms, an ink-sac, an internal shell-rudiment, and only one pair of gills in the mantle cavity. Technically these form the sub-order Decapoda, of the order Dibranchia.

The cuttle-fishes are characteristically swimming animals, in contrast with the octopods, which creep about by means of their suckers among the rocks, and lurk in holes. In *Sepia* the integument is produced laterally into two muscular fins, rather narrow and of uniform breadth running the whole length of the body, but separated by a notch behind. There are four pairs of short non-retractile arms surrounding the mouth, and furnished with suckers on their oral surface, and between the third and fourth of these arms on each side is a much longer tentacular arm, which is usually kept entirely withdrawn into a pocket of the skin. The mantle cavity is on the posterior side of the body, which is the lower side in the swimming position, and the funnel is a tube open at both ends and connected with the body within the mouth of the mantle cavity. The mantle during life performs regular respiratory movements by which water is drawn into the cavity, passing between mantle and funnel, and is expelled through the funnel. In swimming the short arms are directed forwards, the fins undulate, and the motion is slow and deliberate; but if the animal is threatened or alarmed it swims suddenly and rapidly backwards by expelling water

forcibly from the mantle cavity through the funnel, at the same time expelling a cloud of ink from its ink-sac.

The *Sepia* feeds principally on Crustacea, and in aquaria has been observed to pursue and capture prawns. The method in

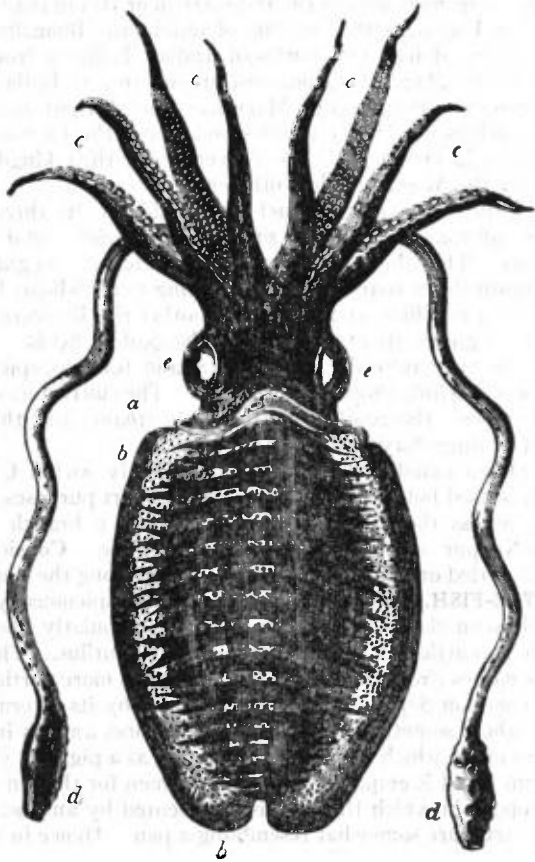

FIG. 1.—*Sepia officinalis*, L., half the natural size, as seen when dead, the long prehensile arms being withdrawn from the pouches at the side of the head, in which they are carried during life when not actually in use. *a*, Neck; *b*, lateral fin of the mantle-sac; *c*, the eight shorter arms of the fore-foot; *d*, the two long prehensile arms; *e*, the eyes.

which it secures its prey has been carefully observed and described by the present writer, who studied the living animal in the aquarium of the biological laboratory at Plymouth. The prawns support themselves on their long slender legs on convenient points of the rockwork, and the *Sepia* stalks them with great caution and determination, the rapid play of its chromatophores giving evidence of its excitement. When it has arrived within striking distance, the two tentacular arms are shot out with great rapidity, and the prawn is seized between the two expanded ends, drawn within the circle of short arms, and devoured; unless, as sometimes happens, the prawn springs away and the *Sepia* misses its aim.

Two species of *Sepia* occur in British and European waters, including the Mediterranean, namely, *S. elegans* and *S. officinalis*. The usual length of the body is about 9 or 10 in. They live mostly between ten and forty fathoms, coming into shallower water in July and August to deposit their eggs, which are about as large as black currants and of somewhat similar colour, and are connected by elongated stalks into a cluster attached to the seabottom. Other species occur in various parts of the world, e.g. *S. caltrata*, which is common on the coasts of Australia. The *Sepiidae* form the only family of cuttle-fishes in which the shell is calcified. They belong to the tribe Myopsida, characterized by the complete closure of the external corneal covering of the eye outside the iris and the lens.

*Sepiolo* and *Rossia* belong to another family of the Myopsida. Both are British genera living in shallow water, and entering estuaries. The animals of both genera are small, not more than

2 or 3 in. in length, with the body rounded at the aboral end, and the fins short and rounded, inserted in the middle of the body length, instead of extending from end to end. *Sepiolo*, although it swims by means of its fins and funnel when active, spends much of its time buried in the sand for concealment. *Rossia* has similar habits. The shell is chitinous and shorter than the body. In other genera of the *Sepioidae* the shell is entirely absent. *Idiosepius* is the smallest of the Cephalopoda, only 1.5 in. in length. It inhabits the Indian Ocean. The body is elongated and the fins rudimentary. In the *Sepiadaridae* also the shell is absent. The body is short and the mantle united with the head dorsally. The two genera *Sepiadarium* and *Sepioloidea* occur in the Pacific Ocean. The common squid *Loligo* is the type of the only remaining family of the Myopsida. In this species the shell is a well-developed chitinous pen or gladius with a thickened axis narrowing to a point behind, but bearing posteriorly a wide thin plate on each side. The shape closely resembles that of a quill pen with the quill in front. The fins are large and triangular, extending over rather more than half of the length of the body aborally. The tentacular arms are only partly retractile. The body is elongated and conical, and reaches about a foot in length. The squid is gregarious, and forms a favourite food of the larger fishes, especially of conger. All the Myopsida are more or less littoral in habit, and the British forms are familiar in consequence of their frequent capture in the nets of fishermen. The shell, or "bone" as it is commonly called, of the common *Sepia* frequently occurs in abundance on the shore among the sea-weed and other refuse left by the tide.

The Oigopsida, or cuttle-fishes in which the corneal covering of the eye is perforated, are on the whole more oceanic than littoral, and many of the species are abyssal. *Ommatostrephes sagittatus* is one of the forms that occurs off the British coasts,

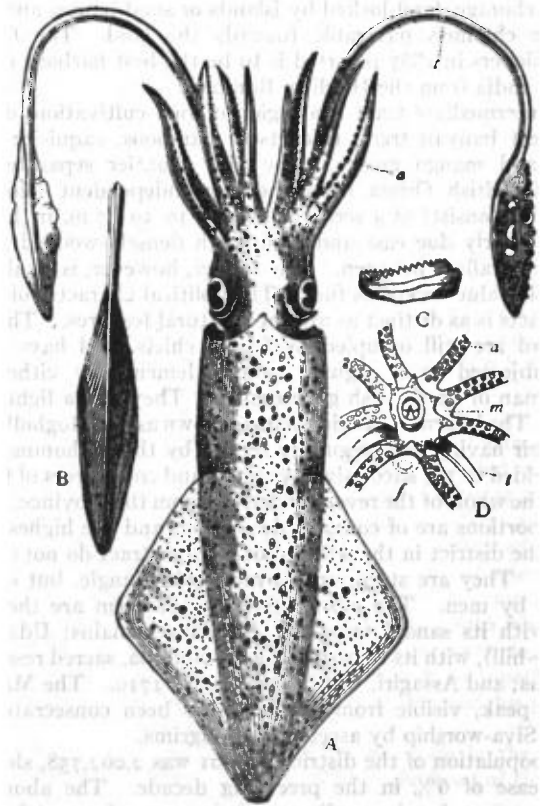

FIG. 2.—A, *Loligo vulgaris*; *a*, arms; *t*, tentacles. B, Pen of the same reduced in size. C, Side-view of one of the suckers, showing the horny hooks surrounding the margin. D, View of the head from in front, showing the arms (*a*), the tentacles (*t*), the mouth (*m*), and the funnel (*f*).

especially the more northern, e.g. in the Firth of Forth. In general appearance it resembles the common squid, but the fins are broader and shorter, not extending to the middle of the body.



The shell is similar to that of *Loligo*, but ends aborally in a little hollow cone. The suckers bear chitinous rings which are toothed along the outer edge. The tentacular arms are rather short and thick. Two specimens of allied species have been taken on British coasts, one of which, captured off, Salcombe in Devonshire in 1892, had a body 66 cm. (22 in.) long, and tentacular arms 64 cm. long, or nearly the same length as the body. Most of the species of *Ommatostrephes* are naturally gregarious and oceanic, and occur in the open seas in all latitudes, swimming near the surface and often leaping out of the water. They are largely devoured by albatrosses and other marine birds, and by Cetacea. They are used as bait in the Newfoundland cod fishery.

Some of the oceanic cuttle-fishes reach a very large size, and the stories of these ocean monsters which are narrated by the older writers, though to some extent exaggerated, are now known to be founded on fact. The figure given by one author of a gigantic Cephalopod rising from the surface of the ocean and embracing with its arms a full-rigged ship does not accurately represent an actual occurrence, but on the other hand there are authentic instances on record of fishermen in small boats on the banks of Newfoundland being in great peril in consequence of large squids throwing their arms across their boats. In November 1874 a specimen was brought ashore at St John's, Newfoundland, which had been caught in herring nets. Its body was 7 ft. long, its fins 22 in. broad, and its tentacular arms 24 ft. long. Several others have been recorded, taken in the same region, which were as large or larger, the total length of the body and tentacles together varying from 30 to 52 ft., and the estimated weight of one of them being 1000 lb.

In April 1875 one of these large squids occurred off Boffin's Island on the Irish coast. The crew of a curragh rowed out to it and attacked it, cutting off two of its arms and its head. The shorter arms measured 8 ft. in length and 15 in. in circumference; the tentacular arms are said to have been 30 ft. long. In the Natural History Museum in London there is one of the shorter arms of a specimen; this arm is 9 ft. in length and 11 in. in circumference, and the total length of the specimen, including body and tentacles, is stated to have been 40 ft. The maximum known length of these giant squids is stated to be 18 metres or about 58½ ft. All these gigantic specimens belong, so far as at present known, to one genus called *Architeuthis*, referred to the same family as *Ommatostrephes*. They are the largest known invertebrates.

These huge cuttle-fishes as well as those of various other oceanic species form the food of the cachalot or sperm whale, and F. T. Bullen, in his *Cruise of the Cachalot* and other writings, has graphically described contests which came under his own observation between the cachalot and its prey. The prince of Monaco in his yacht the "Princess Alice" was fortunate enough to be able to make a very complete scientific investigation in the case of one specimen of the cachalot, which not only confirmed the most important of Mr Bullen's statements, but added considerably to our knowledge of oceanic cuttle-fishes. Off the Azores in July 1895 the prince in his yacht witnessed the killing of a cachalot 13.70 metres long (about 45 ft. 8 in.) by the crew of a whaler. The animal in its death-agony vomited the contents of its stomach, most of which were carefully collected and preserved, and afterwards examined by Professor Joubin. On the lips of the whale were found impressions several centimetres wide which corresponded exactly to the toothed suckers of the largest cuttle-fish arms obtained from its stomach. The contents of the stomach consisted entirely of cuttle-fish or parts of cuttle-fish, including the giant *Architeuthis*, and among them was the body, without the head, of a form new to science, distinguished by a condition of the external surface which occurs in no other species of the group. The surface of the skin was divided into small angular flat projections like scales, arranged in a regular spiral like the scales of a pine cone. From this character the new genus was called *Lepidoteuthis*. The body, without the head, of the specimen obtained was 86 cm. (nearly 3 ft.) in length.

The family *Onychoteuthidae* is remarkable for the formidable chitinous hooks borne on the arms. These hooks are special modifications of the toothed chitinous ring which covers the

sucker-rim in the Decapoda generally. The teeth of the ring are often unequal in size, and in the *Onychoteuthidae* one tooth is enormously developed. The maximum development occurs in *Veranya*, found in the Mediterranean, where the suckers have lost their function and are merely fleshy projections bearing the hooks at their extremities. *Onychoteuthis* reaches a large size, the length of the body without the arms being in one specimen from the Pacific coast of America 8 ft. Figures of this and several of the following genera are given in the article CEPHALOPODA.

In the family *Cheiroteuthidae* many of the species occur at abyssal depths of the ocean, and exhibit curious modifications of structure. In *Cheiroteuthis* itself the tentacular arms are very long and slender, and are not capable of retraction into pockets. In several species of this genus the suckers are no longer organs of adhesion, but are simple cups containing a network of filaments resembling a fishing net. In *Histioteuthis* and *Histiopsis*, as in some Octopods, the six dorsal arms are more or less completely united by a web, which also probably serves for capturing fish. In these two genera and in *Calliteuthis* the skin bears luminous organs. *Cheiroteuthis* has been taken at 2600 fms., *Calliteuthis* at 2200, *Histiopsis* at nearly 2000. *Bathyleuthis*, placed in the same family as *Ommatostrephes*, has been taken at 1700 fms.

The *Cranchiidae* are remarkable for their small size, the shortness of the ordinary arms, and the protuberance of the eyes, which in *Taonius* are actually on the ends of stalk-like outgrowths of the body. *Cranchia* is a deep-sea form taken at 1700 fms. Its body is pear-shaped, swollen posteriorly and quite narrow at the neck.

*Spirula* is distinguished from all other existing Cephalopods by the structure of its coiled shell, which in many respects resembles those of the extinct Ammonites, and is not completely internal. In the structure of the body the animal is a true cuttle-fish in the sense in which the term is here used, having ten arms and a perforated cornea. Three species are distinguished, and their empty shells occur abundantly on the shores of the tropical regions of the Atlantic, Pacific and Indian Oceans. In German the shells are known from their shape as *Posthörnchen*. They are common on the shores of the Azores. But the animal has very rarely been obtained; only a few specimens occur in museum collections. One specimen was taken by the "Challenger" in a deep-sea trawl, at a depth between 300 and 400 fathoms off Banda Neira in the Moluccas. Dr Willemoes Suhm, in describing the capture, stated that the specimen seemed to have been in the stomach of a fish, as its surface was slightly digested, and he thought it must have habits of concealment which usually prevent its capture, and that it was secured on this occasion only by the capture of the fish which had swallowed it. The fact that the shells are washed ashore in such large numbers is not fully explained. Possibly when freed from the animal the air in the chambers of the shell causes it to float, and in that case it would naturally be sooner or later washed ashore. (J. T. C.)

**CUTTS OF GOWRAN, JOHN CUTTS, BARON** (1661-1707), British soldier and author, came of an Essex family. After a short university career at Catherine Hall, Cambridge, he came into the enjoyment of the family estates, but evinced a decided preference for the life of court and camp. The double ambition for military and literary fame inspired his first work, which appeared in 1685 under the name *La Muse de cavalier, or An Apology for such Gentlemen as make Poetry their Diversion not their Business*. The next year saw Cutts serving as a volunteer under Charles of Lorraine in Hungary, and it is said that he was the first to plant the imperialist standard on the walls at the storm of Buda (July 1686). In 1687 he published a book of verse entitled *Poetical Exercises*, and the following year we find him serving as lieutenant-colonel in Holland. General Hugh Mackay describes Cutts about this time as "pretty tall, lusty and well shaped, an agreeable companion with abundance of wit, affable and familiar, but too much seized with vanity and self-conceit."

Lieutenant-Colonel Cutts was one of William's companions in the English revolution of 1688, and in 1690 he went in command of a regiment of foot to the Irish war. He served with distinction



at the battle of the Boyne, and at the siege of Limerick (where he was wounded), and King William created him Baron Cutts of Gowran in the kingdom of Ireland. In 1691 he succeeded to the command of the brigade of the prince of Hesse (wounded at Aughrim), and on the surrender of Limerick was appointed commandant of the town. Next year he served again in Flanders as a brigadier, his brigade of Mackay's division being one of those almost destroyed at Steinkirk. At this battle Cutts himself was wounded. For some time after this, Lord Cutts was lieutenant-governor of the Isle of Wight, but he returned to active service in 1694, holding a command in the disastrous Brest expedition. He was one of Carmarthen's companions in the daring reconnaissance of Camaret Bay, and was soon afterwards again wounded. He succeeded Talmash, the commander of the expedition (who died of his wounds), as colonel of the Coldstream Guards. Next year, after serving as a commissioner for settling the bank of Antwerp, he distinguished himself once more at the famous siege of Namur, winning for himself the name of "Salamander" by his indifference to the heaviest fire. Henceforward court service and war service alternated. He was deep in the confidence of William III., and acted as a diplomatic agent in the negotiations which ended in the peace of Ryswick. On the occasion of the great fire in Whitehall (1698) Cutts, at the head of the Coldstreams, earned afresh the honourable nickname of "the Salamander." A little later we find Captain Richard Steele acting as his private secretary. In 1702, now a major-general, Cutts was serving under Marlborough in the opening campaign of the War of the Spanish Succession, and at the siege of Venloo, conspicuous as usual for romantic bravery, he led the stormers at Fort Saint Michael. His enemies, and even the survivors of the assault, were amazed at the success of a seemingly hare-brained enterprise. Probably, however, Cutts, who was now a veteran of great and varied experience, measured the factors of success and failure better than his critics. It was on this occasion that Swift lampooned the lieutenant-general in his *Ode to a Salamander*. He made the campaign of 1703 in Flanders, and in 1704, after a visit to England, he rejoined Marlborough on the banks of the Danube. At Blenheim he was third in command, and it was his division that bore the brunt of the desperate fighting at the village which gave its name to the battle.

Blenheim was Cutts's last battle. His remaining years were spent at home, and, at the time of his death, he was the holder of eight distinct political and military offices. He sat in five parliaments for the county of Cambridge, and in Queen Anne's first Parliament he was returned for Newport in the Isle of Wight, for which he sat until the time of his death. He was twice married, but left no issue.

**CUVIER, GEORGES LÉOPOLD CHRÉTIEN FRÉDÉRIC DAGOBERT, BARON** (1769-1832), French naturalist, was born on the 23rd of August 1769 at Montbéliard, and was the son of a retired officer on half-pay belonging to a Protestant family which had emigrated from the Jura in consequence of religious persecution. He early showed a bent towards the investigation of natural phenomena, and was noted for his studious habits and marvellous memory. After spending four years at the Academy of Stuttgart, he accepted the position of tutor in the family of the Comte d'Héricy, who was in the habit of spending the summer near Fécamp. It thus came about that he made the acquaintance of the agriculturist, A. H. Tessier, who was then living at Fécamp, and who wrote strongly in favour of his protégé to his friends in Paris—with the result that Cuvier, after corresponding with the well-known naturalist E. Geoffroy Saint-Hilaire, was appointed in 1795 assistant to the professor of comparative anatomy at the Muséum d'Histoire Naturelle. The National Institute was founded in the same year and he was elected a member. In 1796 he began to lecture at the École Centrale du Panthéon, and at the opening of the National Institute in April, he read his first palaeontological paper, which was subsequently published in 1800 under the title *Mémoires sur les espèces d'éléphants vivants et fossiles*. In 1798 was published his first separate work, the *Tableau élémentaire de l'histoire naturelle des animaux*, which was an abridgment of his course of lectures at the École du

Panthéon, and may be regarded as the foundation and first and general statement of his natural classification of the animal kingdom.

In 1799 he succeeded L. J. M. Daubenton as professor of natural history in the Collège de France, and in the following year he published the *Leçons d'anatomie comparée*, a classical work, in the production of which he was assisted by A. M. C. Dumeril in the first two volumes, and by G. L. Duvernoy in three later ones. In 1802 Cuvier became titular professor at the Jardin des Plantes; and in the same year he was appointed commissary of the Institute to accompany the inspectors-general of public instruction. In this latter capacity he visited the south of France; but he was in the early part of 1803 chosen perpetual secretary of the National Institute in the department of the physical and natural sciences, and he consequently abandoned the appointment just mentioned and returned to Paris.

He now devoted himself more especially to three lines of inquiry—one dealing with the structure and classification of the mollusca, the second with the comparative anatomy and systematic arrangement of the fishes, and the third with fossil mammals and reptiles primarily, and secondarily with the osteology of living forms belonging to the same groups. His papers on the mollusca began as early as 1792, but most of his memoirs on this branch were published in the *Annales du muséum* between 1802 and 1815; they were subsequently collected as *Mémoires pour servir à l'histoire et à l'anatomie des mollusques*, published in one volume at Paris in 1817. In the department of fishes, Cuvier's researches, begun in 1801, finally culminated in the publication of the *Histoire naturelle des poissons*, which contained descriptions of 5000 species of fishes, and was the joint production of Cuvier and A. Valenciennes, its publication (so far as the former was concerned) extending over the years 1828-1831. The department of palaeontology dealing with the Mammalia may be said to have been essentially created and established by Cuvier. In this region of investigation he published a long list of memoirs, partly relating to the bones of extinct animals, and partly detailing the results of observations on the skeletons of living animals specially examined with a view of throwing light upon the structure and affinities of the fossil forms. In the second category must be placed a number of papers relating to the osteology of the *Rhinoceros Indicus*, the tapir, *Hyrax Capensis*, the hippopotamus, the sloths, the manatee, &c. In the former category must be classed an even greater number of memoirs, dealing with the extinct mammals of the Eocene beds of Montmartre, the fossil species of hippopotamus, the *Didelphys gyporum*, the *Megalonyx*, the *Megatherium*, the cave-hyaena, the extinct species of rhinoceros, the cave-bear, the mastodon, the extinct species of elephant, fossil species of manatee and seals, fossil forms of crocodilians, chelonians, fishes, birds, &c. The results of Cuvier's principal palaeontological and geological investigations were ultimately given to the world in the form of two separate works. One of these is the celebrated *Recherches sur les ossements fossiles de quadrupèdes*, published in Paris in 1812, with subsequent editions in 1821 and 1825; and the other is his *Discours sur les révolutions de la surface du globe*, published in Paris in 1825.

But none of his works attained a higher reputation than his *Règne animal distribué d'après son organisation*, the first edition of which appeared in four octavo volumes in 1817, and the second in five volumes in 1829-1830. In this classical work Cuvier embodied the results of the whole of his previous researches on the structure of living and fossil animals. The whole of the work was his own, with the exception of the *Insecta*, in which he was assisted by his friend P. A. Latreille.

Apart from his own original investigations in zoology and palaeontology Cuvier carried out a vast amount of work as perpetual secretary of the National Institute, and as an official connected with public education generally; and much of this work appeared ultimately in a published form. Thus, in 1808 he was placed by Napoleon upon the council of the Imperial University, and in this capacity he presided (in the years 1809,

1811 and 1813) over commissions charged to examine the state of the higher educational establishments in the districts beyond the Alps and the Rhine which had been annexed to France, and to report upon the means by which these could be affiliated with the central university. Three separate reports on this subject were published by him. In his capacity, again, of perpetual secretary of the Institute, he not only prepared a number of *Éloges historiques* on deceased members of the Academy of Sciences, but he was the author of a number of reports on the history of the physical and natural sciences, the most important of these being the *Rapport historique sur le progrès des sciences physiques depuis 1789*, published in 1810. Prior to the fall of Napoleon (1814) he had been admitted to the council of state, and his position remained unaffected by the restoration of the Bourbons. He was elected chancellor of the university, in which capacity he acted as interim president of the council of public instruction, whilst he also, as a Lutheran, superintended the faculty of Protestant theology. In 1819 he was appointed president of the committee of the interior, and retained the office until his death. In 1826 he was made grand officer of the Legion of Honour; and in 1831 he was raised by Louis Philippe to the rank of peer of France, and was subsequently appointed president of the council of state. In the beginning of 1832 he was nominated to the ministry of the interior, but on the 13th of May he died in Paris after a brief illness.

See P. J. M. Flourens, *Éloge historique de G. Cuvier*, published as an introduction to the *Éloges historiques* of Cuvier; *Histoire des travaux de Georges Cuvier* (3rd ed., Paris, 1858); A. P. de Candolle, "Mort de G. Cuvier," *Bibliothèque universelle* (1832, 59, p. 442); C. L. Laurillard, "Cuvier," *Biographie universelle*, supp. vol. 61 (1836); Sarah Lee, *Memoirs of Cuvier*, translated into French by T. Lacordaire (1833).

**CUVILLES, FRANÇOIS DE** (1698-c. 1767), French architect and engraver. He helped to carry the French rococo taste to Germany—he was summoned about 1720 to Cologne by the elector James Clement; in 1738 he became architect to the elector of Bavaria, and afterwards occupied the same position towards the emperor Charles VII. His style, while essentially thin, is often painfully elaborate and bizarre. He designed mirrors and consoles, balustrades for staircases, ceilings and fireplaces, and in furniture, beds and commodes especially. He also laid out parks and gardens. He wrote several treatises on artistic and decorative subjects, which were edited by his son, François de Cuvilles the younger, who succeeded his father at the court of Munich.

**CUXHAVEN**, or **KUXHAVEN**, a seaport town of Germany, belonging to the state of Hamburg, and situated at the extremity of the west side of the mouth of the Elbe, 71 m. by rail N.W. from Hamburg. Pop. (1900) 6898. The harbour is good and secure, and is much frequented by vessels delayed in the Elbe by unfavourable weather. A new harbour was made in 1891-1896, having a depth of 26½ ft., with a fore port 1000 ft. long by 800 ft. wide; and it is now the place of departure and arrival of the mail steamers of the Hamburg-American Steamship Company, who in 1901 transferred here a part of their permanent staff. The port is free, *i.e.* outside the customs union (*Zollverein*), the imports being principally coals, bricks and timber, and the exports fish. There is a fishing fleet, for which a new harbour was opened in 1892. Though lying on a bare strand, the town is much frequented as a bathing place by Hamburgers. It is strongly fortified, and there are a lighthouse, and lifeboat and pilot stations. The town only dates from 1873, having been formed by uniting the villages of Ritzebüttel and Cuxhaven, which had belonged to Hamburg since 1394.

**CUYABÁ**, or **CUIABÁ**, capital of the inland state of Matto Grosso, Brazil, about 972 m. N.W. of Rio de Janeiro, on the Cuyabá river near its discharge into the São Lourenço, the principal Brazilian tributary of the Paraguay. Pop. (1890) 14,507; of the municipality, 17,815. The surrounding country is thickly populated. Cuyabá has uninterrupted steamer communication with Montevideo, about 2500 m. distant, but has no land communication with the national capital, except by telegraph. The climate is hot and malaria is prevalent. Cuyabá

was founded in 1719 by Paulista gold hunters, and its gold-washings, now apparently exhausted, yielded rich results in the 18th century. It is the see of a bishopric and headquarters of an important military district, having an arsenal and military barracks.

**CUYAPO**, a town of the province of Nueva Ecija, Luzon, Philippine Islands, 28 m. N.N.W. of San Isidro, the capital. Pop. (1903) 16,292. Rice is grown here. In 1907 the town of Nampicuan was formed from part of Cuyapo.

**CUYP**, the name of a Dutch family which produced two generations of painters. The Cuyp family were long settled at Dordrecht, in the neighbourhood of which they had a country house, where Albert Cuyp (the most famous) was born and bred.

The eldest member of the family who acquired fame was JACOB GERRITZ CUYP, born it is said at Dordrecht in 1575, and taught by Abraham Bloemaert of Utrecht. He is known to have been alive in 1649, and the date of his death is obscure. J. G. Cuyp's pictures are little known. But he produced portraits in various forms, as busts and half-lengths thrown upon plain backgrounds, or groups in rooms, landscapes and gardens. Solid and clever as an imitator of nature in its ordinary garb, he is always spirited, sometimes rough, but generally plain, and quite as unconscious of the sparkle conspicuous in Frans Hals as incapable of the concentrated light-effects peculiar to Rembrandt. In portrait busts, of which there are signed examples dated 1624, 1644, 1646 and 1649, in the museums of Berlin, Rotterdam, Marseilles, Vienna and Metz, his treatment is honest, homely and true; his touch and tone firm and natural. In portraying children he is fond of introducing playthings and pets—a lamb, a goat or a roe deer; and he reproduces animal life with realistic care. In a family scene at the Amsterdam Museum we have likenesses of men, women, boys and girls with a cottage and park. In the background is a coach with a pair of horses. These examples alone give us a clue to the influences under which Albert Cuyp grew up, and explain to some extent the direction which his art took as he rose to manhood.

ALBERT CUYP (1620-1691), the son of Jacob Gerritsz by Grietche Dierichsdochter (Dierich's daughter), was born at Dordrecht. He married in 1658 Cornelia Bosman, a rich widow, by whom he had an only daughter. By right of his possessions at Dordwyck, Cuyp was a vassal of the county of Holland, and privileged to sit in the high court of the province. As a citizen he was sufficiently well known to be placed on the list of those from whom William III., stadtholder of the Netherlands, chose the regency of Dordrecht in 1672. His death, and his burial on the 7th of November 1691 in the church of the Augustines of Dordrecht, are historically proved. But otherwise the known facts concerning his life are few. He seldom dates his pictures, but it appears probable that he ceased to paint about 1675. It has been said that Albert was the pupil of his father. The scanty evidence of Dutch annalists to this effect seems confirmed by a certain coincidence in the style and treatment of father and son. That he was a pupil of van Goyen has been surmised on the strength of the style of his early works. It has been likewise stated that Albert was skilled, not only in the production of portraits, landscapes and herds, but in the representation of still life. His works are supposed to be divisible into such as bear the distinctive marks C. or A. C. in cursive characters, the letters A. C. in Roman capitals, and the name "A. Cuyp" in full. A man of Cuyp's acknowledged talent may have been versatile enough to paint in many different styles. But whether he was as versatile as some critics have thought is a question not quite easy to answer. It is to be observed that pieces assigned to Cuyp representing game, shell-fish and fruit, and inscribed A. C. in Roman capitals (Rotterdam, Amsterdam and Berlin museums), though cleverly executed, are not in touch or treatment like other pictures of less dubious authenticity, signed either with C. or A. C. or "A. Cuyp" in cursive letters. The panels marked C. and A. C. in cursive are portraits or landscapes, with herds, and interiors of stables or sheds, in which there are cows, horses and poultry. The subjects and their handling are akin to those which strike us in panels bearing the master's full

signature, though characterized, as productions of an artist in the first phase of his progress would naturally be, by tones more uniform, touch more flat, and colour more deep than we find in the delicate and subtle compositions of the painter's later time. Generally speaking, the finished examples of Cuyp's middle and final period all bear his full signature. They are all remarkable for harmonies attained by certain combinations of shade in gradations with colours in contraposition.

Albert Cuyp, a true child of the Netherlands, does not seem to have wandered much beyond Rotterdam on the one hand or Nijmegen on the other. His scenery is that of the Meuse or Rhine exclusively; and there is little variety to notice in his views of water and meadows at Dordrecht, or the bolder undulations of the Rhine banks east of it, except such as results from diversity of effect due to change of weather or season or hour. Cuyp is to the river and its banks what Willem Van de Velde is to calm seas and Hobbema to woods. There is a poetry of effect, an eternity of distance in his pictures, which no Dutchman ever expressed in a similar way. His landscapes sparkle with silvery sheen at early morning, they are bathed in warm or sultry haze at noon, or glow with heat at eventide. Under all circumstances they have a peculiar tinge of auburn which is Cuyp's and Cuyp's alone. Bürger truly says van Goyen is gray, Ruysdael is brown, Hobbema olive, but Cuyp "is blond." The utmost delicacy may be observed in Cuyp's manner of defining reflections of objects in water, or of sight from water on ship's sides. He shows great cleverness in throwing pale-yellow clouds against clear blue skies, and merging yellow mists into olive-green vegetation. He is also very artful in varying light and shade according to distance, either by interchange of cloud-shadow and sun-gleam or by gradation of tints. His horses and cattle are admirably drawn, and they relieve each other quite as well if contrasted in black and white and black and red, or varied in subtler shades of red and brown. Rich weed-growth is expressed by light but marrowy touch, suggestive of detail as well as of general form. The human figure is given with homely realism in most cases, but frequently with a charming elevation, when, as often occurs, the persons represented are meant to be portraits. Whatever the theme may be it remains impressed with the character and individuality of Cuyp. Familiar subjects of the master's earlier period are stables with cattle and horses (Rotterdam, Amsterdam, Petersburg and Brussels museums). Occasionally he painted portraits in the bust form familiar to his father, one of which is dated 1649, and exhibited in the National Gallery, London. More frequently he produced likenesses of ladies and gentlemen on horseback, in which the life and dress of the period and the forms of horses are most vividly represented (Buckingham Palace, Bridgewater Gallery, Louvre and Dresden Museum). Later on we find him fondest of expansive scenery with meadows and cattle and flocks, or rivers and barges in the foreground and distances showing the towers and steeples of Dordrecht. Cuyp was more partial to summer than to winter, to noon than to night, to calm than to storm. But some of his best groups are occasionally relieved on dark and gusty cloud (Louvre and Robarts's collection). A few capital pieces show us people sledging and skating or netting ice-holes (Yarborough, Neeld and Bedford collections). A lovely "Night on the Banks of a River," in the Grosvenor collection, reminds us that Cuyp's friend and contemporary was the painter of moonlights, Aart van der Neer, to whom he was equal in the production of these peculiar effects and superior in the throw of figures. Sometimes Cuyp composed fancy subjects. His "Orpheus charming the Beasts," in the Bute collection, is judiciously arranged with the familiar domestic animals in the foreground, and the wild ones, to which he is a comparative stranger, thrown back into the distance. One of his rare gospel subjects is "Philip baptizing the Eunuch" (Marchmont House, Berwickshire), described as a fine work by Waagen. The best and most attractive of Cuyp's pieces are his Meuse and Rhine landscapes, with meadows, cattle, flocks and horsemen, and occasionally with boats and barges. In these he brought together and displayed—during his middle and final period—all the skill of one who is at once a poet and a finished artist; grouping, tinting,

touch, harmony of light and shade, and true chords of colours are all combined. Masterpieces of acknowledged beauty are the "Riders with the Boy and Herdsman" in the National Gallery; the Meuse, with Dordrecht in the distance, in three or four varieties, in the Bridgewater, Grosvenor, Holford and Brownlow collections; the "Huntsman" (Ashburton); "Herdsman with Cattle," belonging to the marquess of Bute; and the "Piper with Cows," in the Louvre. The prices paid for Cuyp's pictures in his own time were comparatively low. In 1750, 30 florins was considered to be the highest sum to which any one of his panels was entitled. But in more recent times the value of the pictures has naturally risen very largely. At the sale of the Clewer collection at Christie's in 1876 a small "Hilly Landscape in Morning Light" was sold for £5040, and a view on the Rhine, with cows on a bank, for £3150. (J. A. C.)

John Smith's *Catalogue raisonné* of the Dutch and Flemish painters, in 9 vols. (1840), enumerated 335 of Albert Cuyp's works, of which in 1877 Sir J. A. Crowe wrote in this encyclopaedia that "it would be difficult now to find more than a third of them." In C. Hofstede de Groot's *Catalogue raisonné*, vol. ii. (1909), revising Smith's, the number is extended to nearly 850, but he accepts too readily the attributions of sale catalogues; the work is, however, the best modern authority on the painter.

**CUZA** (or **COUZA**), **ALEXANDER JOHN** [*Alexandru Joan*] (1820–1873), first prince of Rumania, was born on the 20th of March 1820, at Galatz in Moldavia, and belonged to an ancient *boiar*, or noble, family. He was educated at Jassy, Pavia, Bologna and Athens; and, after a brief period of military service, visited Paris from 1837 to 1840 for a further course of study. In 1845 he married the daughter of another *boiar*, Elena Rosetti, who in 1862 founded the Princess Elena refuge for orphans, at Bucharest. Cuza was imprisoned by the Russian authorities for taking part in the Rumanian revolution of 1848, but escaped to Vienna. On his return, in 1850, he was appointed prefect of Galatz. In 1857 he rejoined the army, and within a few months rose to the rank of colonel. He became minister of war in 1858, and represented Galatz in the Assembly which was elected in the same year to nominate a prince for Moldavia. Cuza was a prominent speaker in the critical debates which ensued when the assembly met at Jassy, and strongly advocated the union of the two Danubian principalities, Moldavia and Walachia. In default of a foreign prince, he was himself elected prince of Moldavia by the assembly at Jassy (17th Jan. 1859), and prince of Walachia by the assembly at Bucharest (5th Feb.). He thus became ruler of the united principalities, with the title Prince Alexander John I.; but as this union was forbidden by the congress of Paris (18th Oct. 1858), his authority was not recognized by his suzerain, the sultan of Turkey, until the 23rd of December 1861, when the union of the principalities under the name of Rumania was formally proclaimed. For a full account of Cuza's reign see **RUMANIA**. The personal vices of the prince, and the drastic and unconstitutional reforms which he imposed on all classes, alienated his subjects, although many of these reforms proved to be of lasting excellence. Financial distress supervened, and the popular discontent culminated in revolution. At four o'clock on the morning of the 22nd of February 1866, a band of military conspirators broke into the palace, and compelled the prince to sign his abdication. On the following day they conducted him safely across the frontier. Prince Alexander spent the remainder of his life chiefly in Paris, Vienna and Wiesbaden. He died at Heidelberg on the 15th of May 1873.

**CUZCO**, an inland city of southern Peru, capital of an Andean department of the same name, about 360 m. E.S.E. of Lima, in lat. 13° 31' S., long. 73° 03' W. The population, largely composed of Indians and *mestizos*, was estimated at 30,000 in 1896, but according to the official estimate of 1906, it was then about 25% less. The city stands at the head of a small valley, 11,380 ft. above sea-level, and is nearly enclosed by mountains of considerable elevation. The valley itself is 9 m. in length and extends S.E. to the valley of Vilcamayu. Overlooking the city from the N. is the famous hill of Sacsahuaman, crowned by ruins of the cyclopean fortress of the Incas and their predecessors, and separated from adjacent heights by the deep ravines of two

streams, called the Huatenay and Rodadero. The principal part of the city lies between these two streams, with its great plaza in the centre. On the W. side of the Huatenay are two more fine squares, called the Cabildo and San Francisco. The houses of the city are built of stone, their walls commonly showing the massive masonry of the Incas at the bottom, crowned with a light modern superstructure roofed with red tiles. The streets cross each other at right angles and afford fine vistas on every side. The principal public buildings are the cathedral, which is classed among the best in South America, the convent of San Domingo, which partly occupies the site of the great Temple of the Sun of the Incas, the *cabildo* or government-house, a university founded in 1508, a college of science and arts, a public library, hospital, mint and museum of Incarial antiquities. Cuzco was made the see of a bishopric soon after it was occupied by the Spaniards. The Church has always exercised a dominating influence in this region, and the city has many churches and religious establishments. There are a number of small manufacturing industries in Cuzco, including the manufacture of cotton and woollen fabrics, leather, beer, embroidery and articles of gold and silver. Its trade is not large, however, owing to the costs of transportation. The climate is cool and bracing, and the products of the vicinity include many of the temperate zone. A railway from Juliaca (a station on the line from Mollendo to Puno) to Cuzco was virtually completed early in 1908. This railway gives Cuzco an outlet to the coast, and also direct connexion with La Paz, the Bolivian capital. A branch of the Callao & Oroya railway is also projected southward to Cuzco, and reached Huancayo in 1908. Cuzco was the capital of a remarkable empire ruled by the Incas previous to the discovery of Peru, and it was one of the largest and most civilized of the native cities of the New World. It was captured by Pizarro in 1533, and it is said that its size and the magnificence of its principal edifices filled the Spaniards with surprise. It was for many years an object of contention among the Spanish factions, but ultimately the greater attractions of Lima and its own isolation diminished its importance.

The department of Cuzco is the second largest in Peru, having an area of 156,317 sq. m., and a population, according to a reduced official estimate of 1906, of only 328,980. It occupies an extremely mountainous region on the frontier of Bolivia, E. of the departments of Junin, Ayacucho and Apurimac, and extends from Loreto on the N. to Puno and Arequipa on the S. Its area, however, includes a large district E. of the Andes which is claimed by Bolivia, and the settlement of the dispute may materially diminish its size. The elevation of a large part of the department gives it a temperate climate and permits the cultivation of cereals and other products of the temperate zone. Cattle and sheep are produced in large numbers in some of the provinces, while in others mining forms the chief industry. On the eastern forested slopes and in the lower valleys tropical conditions prevail. The population is chiefly composed of Indians who form a sturdy, docile labouring class, but are in great part strongly disinclined to accept the civilization of the dominant white race.

**CYANAMIDE**,  $\text{NC}\cdot\text{NH}_2$ , the amide of normal cyanic acid, obtained by the action of ammonia on cyanogen chloride, bromide or iodide, or by the desulphurization of thio-urea with mercuric oxide; it is generally prepared by the latter process. It forms white crystals, which melt at  $40^\circ\text{C}$ ., and are readily soluble in water, alcohol and ether. Heated above its melting point it polymerizes to di-cyandiamide ( $\text{CN}_2\text{H}_2$ )<sub>2</sub>, which at  $150^\circ\text{C}$ . is transformed into the polymer *n*-tri-cyantri- amide or melamine ( $\text{CN}_2\text{H}_2$ )<sub>3</sub>, the mass solidifying. Nascent hydrogen reduces cyanamide to ammonia and methylamine. It gives mono-metallic salts of the type  $\text{NC}\cdot\text{NHM}$  when treated with aqueous or alcoholic solutions of alkalis. Di-metallic salts are obtained by heating cyanates alone, e.g. calcium, or cyanides in a current of nitrogen, e.g. barium.

Calcium cyanamide has assumed importance in agriculture since the discovery of its economic production in the electric furnace, wherein calcium carbide takes up nitrogen from the atmosphere to form the cyanamide with the simultaneous

liberation of carbon. It may also be produced by heating lime or chalk with charcoal to  $2000^\circ$  in a current of air. The commercial product (which is known in Germany as "*Kalkstickstoff*") contains from 14 to 22 % of nitrogen, which is liberated as ammonia when the substance is treated with water; to this decomposition it owes its agricultural value. It appears that with soils which are not rich in humus or not deficient in lime, calcium cyanamide is almost as good, nitrogen for nitrogen, as ammonium sulphate or sodium nitrate; but it is of doubtful value with peaty soils or soils containing little lime, nor is it usefully available as a top-dressing or for storing.

**CYANIC ACID AND CYANATES.** Cyanic acid,  $\text{CN}\cdot\text{OH}$ , was discovered by F. Wöhler in 1824, and may be obtained by distilling its polymeride, cyanuric acid, in a current of carbon dioxide (F. Wöhler and J. v. Liebig, *Berzelius Jahresberichte*, 1827, 11, p. 84), the vapours which distil over being condensed in a freezing mixture. It is a very volatile liquid of strong acid reaction, and is only stable below  $0^\circ\text{C}$ . It has a smell resembling that of acetic acid. At  $0^\circ\text{C}$ . it is rapidly converted into a mixture of cyanuric acid,  $\text{C}_3\text{N}_3\text{O}_3\text{H}_3$ , and another polymer, cyamelide ( $\text{CNOH}$ )<sub>x</sub>; this latter substance is a white amorphous powder, insoluble in water. An aqueous solution of cyanic acid is rapidly hydrolysed (above  $0^\circ\text{C}$ .) into a mixture of carbon dioxide and ammonia. Cyanogen chloride,  $\text{CNCl}$ , may be regarded as the chloride of cyanic acid. It may be prepared by the action of chlorine on hydrocyanic acid or on mercury cyanide. It is a very poisonous volatile liquid, which boils at  $15.5^\circ\text{C}$ . It polymerizes readily to cyanuric chloride,  $\text{C}_3\text{N}_3\text{Cl}_3$ . Caustic alkalis hydrolyse it readily to the alkaline chloride and cyanate.

The salts of cyanic acid are known as the cyanates, the two most important being potassium cyanate ( $\text{KOCN}$ ) and ammonium cyanate ( $\text{NH}_4\text{OCN}$ ). Potassium cyanate may be prepared by heating potassium cyanide with an oxidizing agent, or by heating potassium ferrocyanide with manganese dioxide, potassium carbonate or potassium dichromate (J. v. Liebig, *Ann.*, 1841, 38, p. 108; C. Lea, *Jahresb.*, 1861, p. 789; L. Gattermann, *Ber.*, 1890, 23, p. 1224), the fused mass being extracted with boiling alcohol. It crystallizes in flat plates and is readily soluble in cold water. It is a somewhat important reagent, and has been used by Emil Fischer in various syntheses in the uric acid group (see PURIN). Ammonium cyanate possesses considerable theoretical importance since the first synthetical production of an organic from inorganic compounds was accomplished by warming its aqueous solution for some time, urea being formed (F. Wöhler, *Berzelius Jahresberichte*, 1828, 12, p. 266). J. Walker and J. K. Wood (*Jour. Chem. Soc.*, 1900, 77, p. 24) prepared pure ammonium cyanate by the union of gaseous ammonia and cyanic acid, special precautions being taken to keep the temperature below the point at which the salt is transformed into urea. It crystallizes in fine needles, which melt suddenly at about  $80^\circ\text{C}$ ., then resolidify, and melt again at about  $128^\circ$  to  $130^\circ\text{C}$ . (this temperature being that of the melting point of urea). Substituted ammonias were also made to combine with cyanic acid, and it was found that the substituted ammonium cyanates produced pass much more readily into the corresponding ureas than ammonium cyanate itself. (On the constitution of cyanic acid see F. D. Chattaway and J. M. Wadmore, *Jour. Chem. Soc.*, 1902, 81, p. 191.)

Esters of normal cyanic acid are not known, but those of isocyanic acid ( $\text{HN}\cdot\text{CO}$ ) may be prepared by the action of alkyl halides on silver cyanate, or by oxidizing the isonitriles with mercuric oxide. They are volatile liquids which boil without decomposition, and possess a nauseating smell. When hydrolysed with caustic alkalis, they yield primary amines (this reaction determines their constitution):  $\text{C}_2\text{H}_5\text{NCO} + \text{H}_2\text{O} = \text{C}_2\text{H}_5\text{NH}_2 + \text{CO}_2$ . When heated with water they yield carbon dioxide and symmetrical dialkyl ureas; with ammonia and amines they form alkyl ureas; and with acid anhydrides they yield tertiary amides.

Ethyl isocyanate,  $\text{C}_2\text{H}_5\text{NCO}$ , was first prepared by A. Wurtz (*Ann. chim.*, 1854 (3), 42, p. 43) by distilling a mixture of potassium

ethyl sulphate and potassium cyanate. It is a colourless liquid which boils at 60° C.

**Cyanuric acid**,  $H_2C_3N_3O_3$ , was obtained by Wöhler and Liebig by heating urea, and by A. Wurtz by passing chlorine into melting urea. It forms white efflorescent crystals. Treatment with phosphorus pentachloride gives cyanuric chloride,  $C_3N_3Cl_3$ , which is also formed by the combination of anhydrous chlorine and prussic acid in the presence of sunlight. These substances contain a ring of three carbon and three nitrogen atoms, *i.e.* they are symmetrical triazines.

**CYANIDE**, in chemistry, a salt of prussic or hydrocyanic acid, the name being more usually restricted to inorganic salts, *i.e.* the salts of the metals, the organic salts (or esters) being termed nitriles. The preparation, properties, &c., of cyanides are treated in the article PRUSSIC ACID; reference should also be made to the articles on the particular metals. The most important cyanide commercially is potassium cyanide, which receives application in the "cyanide process" of gold extraction (see GOLD).

**CYANITE**, a native aluminium silicate,  $Al_2SiO_5$ , crystallizing in the anorthic system. It has the same percentage chemical composition as andalusite and sillimanite, but differs from these in its crystallographic and physical characters. P. Groth writes the formula as a metasilicate  $(AlO)_2SiO_3$ . The name cyanite was given by A. G. Werner in 1789, from *κίανος*, blue, in allusion to the characteristic colour of the mineral; the form kyanite is also in common use, and the name disthène, proposed by R. J. Haüy in 1801, is used by French writers.

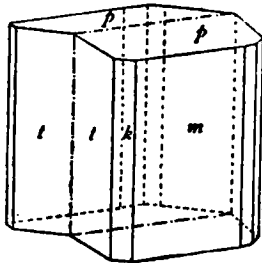

Distinctly developed crystals with terminal planes are rare, the mineral being commonly found as lamellar cleavage masses or long blade-shaped crystals embedded in crystalline rocks.

The colour is usually a pale sky-blue, but may be white, greenish or yellowish; it varies in intensity in different bands, so that the crystals usually present a more or less striped appearance. There is a perfect cleavage parallel to the broad face *m* (100), and a less perfect one parallel to *t* (010): the basal plane *p* (001), oblique to the prism zone, is a gliding plane on which secondary twinning is produced by pressure, giving rise to characteristic horizontal striations on the cleavage face *m*. The accompanying figure represents a crystal twinned on the plane *m* (100). A negative biaxial optic figure is seen in convergent polarized light through the cleavage plane *m*, the axial plane being inclined at about 30° to the edge between *m* and *t*. A remarkable feature of cyanite is the great difference in hardness on different faces of the same crystal and in different directions on the same face: on the face *m* in a direction parallel to the edge between *m* and *p* the hardness is 7, whilst in a direction parallel to the edge between *m* and *t* it is 4½. The name disthène, from *δίσ*, two, and *σθέρως*, strong, has reference to these differences in hardness.

Analyses of cyanite often show the presence of a small amount (usually less than 1%) of ferric oxide and sometimes traces of copper, and to these constituents the blue or green colour of the mineral is doubtless due. The mineral is infusible before the blowpipe, and is not decomposed by acids. At a high temperature, about 1350° C., it becomes transformed into sillimanite, changing in specific gravity from 3.6 to 3.2.

Cyanite is a characteristic mineral of the metamorphic crystalline rocks—gneiss, schist, granulite and eclogite—and is often associated with garnet and staurolite. A typical occurrence is in the white, fine-scaled paragonite-schist of Monte Campione, near St Gotthard in Switzerland, where long transparent crystals of a fine blue colour are abundant. In the gneiss of the Pfäferscher Tal near Sterzing in Tirol a white variety known as rhaetizite is found. It occurs at several places in Scotland, for instance, at Botriphnie in Banffshire, with muscovite in a quartz-vein. Fine specimens are found in mica-schist at Chesterfield in

Massachusetts, and at several other localities in the United States. It is found in the gold-washings of the southern Urals and in the diamond-washings of Brazil. As minute crystal fragments it is met with in many sands and sandstones.

When of sufficient transparency and depth of colour (deep cornflower-blue) the mineral has a limited application as a gem-stone; it is usually cut *en cabochon*. (L. J. S.)

**CYANOGEN** (Gr. *κίανος*, blue *γεννᾶν*, to produce),  $C_2N_2$ , in chemistry, a gas composed of carbon and nitrogen. The name was suggested by Prussian blue, the earliest known compound of cyanogen. It was first isolated in 1815 by J. Gay-Lussac, who obtained it by heating mercury or silver cyanide; this discovery is of considerable historical importance, since it recorded the isolation of a "compound radical." It may also be prepared by heating ammonium oxalate; by passing induction sparks between carbon points in an atmosphere of nitrogen (see H. von Wartenburg, *Abh. J.C.S.*, 1907, i. p. 299), or by the addition of a concentrated solution of potassium cyanide to one of copper sulphate, the mixed solutions being then heated. It also occurs in blast-furnace gases. When cyanogen is prepared by heating mercuric cyanide, a residue known as para-cyanogen,  $(CN)_2$ , is left; this is to be regarded as a polymer of cyanogen. It is a brownish amorphous solid, which is insoluble in water. Cyanogen is a colourless gas, possessing a peculiar characteristic smell, and is very poisonous. It burns with a purple flame, forming carbon dioxide and nitrogen; and may be condensed (by cooling to -25° C.) to a colourless liquid, and further to a solid, which melts at -34.4° C. (M. Faraday, *Ann.*, 1845, 56, p. 158). It dissolves readily in water and the aqueous solution decomposes on standing; a dark-brown flocculent precipitate of azulmic acid,  $C_8H_8N_8O$ , separating whilst ammonium oxalate, urea and hydrocyanic acid are found in the solution. In many respects it resembles chlorine in its chemical behaviour, a circumstance noted by Gay-Lussac; it combines directly with hydrogen (at 500° to 550° C.) to form hydrocyanic acid, and with chlorine, bromine, iodine and sulphur, to form cyanogen chloride, &c.; it also combines directly with zinc, cadmium and iron to form cyanides of these metals. It combines with sulphuretted hydrogen, in the presence of water, to form the compound  $C_2N_2 \cdot H_2S$ , and in the presence of alcohol, to form the compound  $C_2N_2 \cdot 2H_2S$ . Concentrated hydrochloric acid converts it into oxamide. Potash solution converts it into a mixture of potassium cyanide and cyanate. When heated with hydriodic acid (specific gravity 1.96) it forms amino-acetic acid, and with tin and hydrochloric acid it yields ethylene diamine.

**CYAXARES** (Pers. *Uvakhshatra*), king of Media, reigned according to Herodotus (i. 107) forty years, about 624–584 B.C. That he was the real founder of the Median empire is proved by the fact that in Darius's time a Median usurper, Fravartish, pretended to be his offspring (Behistun inscr. 2. 43); but about his history we know very little. Herodotus narrates (i. 103 ff.) that he renewed the war against the Assyrians, in which his father Phraortes had perished, but was, while he besieged Nineveh, attacked by a great Scythian army under Madyas, son of Protothyas, which had come from the northern shores of the Black Sea in pursuit of the Cimmerians. After their victory over Cyaxares, the Scythians conquered and wasted the whole of western Asia, and ruled twenty-eight years, till at last they were made drunk and slain by Cyaxares at a banquet (cf. another story about Cyaxares and a Scythian host in Herod. i. 73). As we possess scarcely any contemporary documents it is impossible to find out the real facts. But we know from the prophecies of Jeremiah and Zephaniah that Syria and Palestine were really invaded by northern barbarians in 626 B.C., and it is probable that this invasion was the principal cause of the downfall of the Assyrian empire (see MEDIA and PERSIA: *Ancient History*).

After the destruction of the Scythians Cyaxares regained the supremacy, renewed his attack on Assyria, and in 606 B.C. destroyed Nineveh and the other capitals of the empire (Herod. i. 106; Berossus *ap.* Euseb. *Chron.* i. 29, 37, confirmed by a stele of Nabonidus found in Babylon: Scheil in *Recueil de*



*travaut*, xviii.; Messerschmidt, "Die Inschrift der Stele Nabonaid," in *Mitteilungen der vorderasiatischen Gesellschaft*, i., 1806). According to Berossus he was allied with Nabopolassar of Babylon, whose son Nebuchadrezzar married Amyitis, the daughter of the Median king (who is wrongly called Astyages). The countries north and east of the Tigris and the northern part of Mesopotamia with the city of Harran (Carrhae) became subject to the Medes. Armenia and Cappadocia were likewise subdued; the attempt to advance farther into Asia Minor led to a war with Alyattes of Lydia. The decisive battle, in the sixth year, was interrupted by the famous solar eclipse on the 28th of May 585 predicted by Thales. Syennesis of Cilicia and Nebuchadrezzar (in Herodotus named Labynetus) of Babylon interceded and effected a peace, by which the Halys was fixed as frontier between the two empires, and Alyattes's daughter married to Cyaxares's son Astyages (Herod. i. 74). If Herodotus's dates are correct, Cyaxares died shortly afterwards.

In a fragmentary letter from an Assyrian governor to King Sargon (about 715 B.C.) about rebellions of Median chieftains, a dynast Uvakshatar (*i.e.* Cyaxares) is mentioned as attacking an Assyrian fortress (Kharkhar, in the chains of the Zagros). Possibly he was an ancestor of the Median king. (ED. M.)

**CYBELE**, or **CYBEBE** (Gr. Κυβέλη, Κυβήθη), a goddess native to Asia Minor and worshipped by most of the peoples of the peninsula, was known to the Romans most commonly as the GREAT MOTHER OF THE GODS (*q.v.*), or the Great Idaean Mother of the Gods—*Magna Deum Mater*, *Mater Deum Magna Idaea*. She was known by many other names, such as *Mater Idaea*, Dindymene, Sipyrene, derived from famous seats of worship, and Mountain Mother, &c., in token of her character, but Cybele is the name by which she is most frequently known in literature. Her cult became centralized in Phrygia, had found its way into Greece, where it never flourished greatly, as early as the latter 6th century B.C., and was introduced at Rome in 204 B.C. Under the Empire it attained to great importance, and was one of the last pagan cults to die. Cybele was usually worshipped in connexion with Attis (*q.v.*), as Aphrodite with Adonis, the two being a duality interpreted by the philosophers as symbolic of Mother Earth and her vegetation. (G. SN.)

**CYCLADES**, a compact group of islands in the Greek Archipelago, forming a cluster around the island of Syra (Syros), the principal town of which, now officially known as Hermoupolis, is the capital of a department. Population of the group (1907) 130,378. The islands, though seldom visited by foreigners, are for the most part highly interesting and picturesque, notwithstanding their somewhat barren appearance when viewed from the sea; many of them bear traces of the feudal rule of Venetian families in the middle ages, and their inhabitants in general may be regarded as presenting the best type of the Greek race. To the student of antiquity the most interesting are: Delos (*q.v.*), one of the greatest centres of ancient religious, political and commercial life, where an important series of researches has been carried out by French archaeologists; Melos (*q.v.*), where, in addition to various buildings of the Hellenic and Roman periods, the large prehistoric stronghold of Phylakopi has been excavated by members of the British school at Athens; and Thera (see SANTORIN), the ancient capital of which has been explored by Baron Hiller von Gaertringen. Thera is also of special interest to geologists owing to its remarkable volcanic phenomena. Naxos, the largest and most fertile island of the group, contains the highest mountain in the Cyclades (Zia, 3290 ft.); the island annually exports upwards of 2000 tons of emery, a state monopoly the proceeds of which are now hypothecated to the foreign debt. The oak woods of Ceos (Zeá) and Ios furnish considerable supplies of valonia. Kimolos, which is absolutely treeless, produces fuller's-earth. The famous marble quarries of Paros have been practically abandoned in modern times; the marble of Tenos is now worked by a British syndicate. The mineral wealth of the Cyclades has hitherto been much neglected; iron ore is exported from Seriphos, manganese and sulphur from Melos, and volcanic cement (pozzolana) from Santorin. Other articles

of export are wine, brandy, hides and tobacco. Cythnos, Melos and other islands possess hot springs with therapeutic qualities. The prosperity of Syra, formerly an important distributing centre for the whole Levant, has been declining for several years.

—Population (1907):—Syra 31,939 (communes, Hermoupolis 18,132, Mykonos 4589, Syra 9218); Andros 18,035 (Andros 8536, Arni 2166, Gaurio 2897, Corthion 4436); Thera 19,597 (Thera 4226, Egiale 1513, Amorgos 2627, Anaphe 579, Emporium 2172, Therasia 679, Ios 2090, Kalliste 3519, Oea 2192); Ceos 11,032 (Ceos 3817, Dryopis 1628, Cythnos 1563, Seriphos 4024); Melos, 12,774 (Melos 4864, Adamas 529, Siphnos 3777, Kimolos 2015, Pholegandros 962, Sikinos 627); Naxos 25,185 (Naxos 2064, Apiranthé 2421, Vivlos 4343, Coronis 3205, Marpessa 1313, Naoussa 1670, Paros 3586, Tragea 4661, Hyrie 1922); Tenos 11,816 (Tenos 4697, Panorme 2658, Peree 2801, Sosthenion 1660).

**CYCLAMEN**, in botany, a genus belonging to the natural order Primulaceae, containing about ten species native in the mountains of central Europe and the Mediterranean region. *C. europaeum* (Sow-bread) is found as an introduced plant in copses in Kent and Sussex. The plants are low-growing herbs with large tuberous rootstocks, from the surface of which spring a number of broad, generally heart-shaped or kidney-shaped, long-stalked leaves, which in cultivated forms are often beautifully marbled, ribbed or splashed. The flowers are nodding, and white, pink, lilac or crimson in colour. The corolla has a short tube and five large reflexed lobes. After flowering the stalk becomes spirally coiled, drawing the fruit down to the soil. Cyclamen is a favourite winter and spring flowering plant. *C. persicum* is probably the best known. It is a small-growing kind bearing medium-sized leaves and numerous flowers. *C. giganteum* is a large, strong-growing species; not quite so free flowering as *C. persicum*, but in all other respects superior to it when well grown. *C. papilio* differs in the fringed character of the petals. It has been obtained by selection from *C. persicum*. There is also a very beautiful crested race, probably derived from *C. giganteum*.

The plants are raised from seed, and, with good cultivation, flower in fifteen to eighteen months from date of sowing. Seed should be sown as soon as ripe, in July or August, in pots or pans, filled up to 2½ in. of the rim with broken crocks for drainage. The soil should consist of fibrous yellow loam, leaf-mould in flakes, and coarse silver-sand, in equal parts. Sow the seed thinly—¼ in. to ½ in. apart—and cover with a very thin sprinkling of the soil. Protect with a square of glass covered with a piece of brown paper for shade, and place on a shelf in a warm greenhouse. The soil should never be allowed to get dry.

When the seedlings appear, remove the covering, care being taken that they do not suffer for want of shade, water or a moist atmosphere. As soon as the third leaf appears, repot singly into thumb-pots in slightly coarser soil, so that the crowns of the little plants are just above the level of the soil. In December transfer into a little richer soil, consisting of two parts fibrous loam broken into small bits by hand and the fine particles rejected, one part flaked leaf-mould, passed through a half-inch sieve, half a part of plant ash from the burnt refuse heap and half a part of coarse silver-sand. Keep through the winter in a moist atmosphere at a temperature not below 50° Fahr., and as near the glass as possible. In March they should be ready for their next shift into 5-in. pots. The potting compost should be the same as for the last shift, with the addition of half a part of well-sweetened manure, such as a spent mushroom bed. Keep in a warm moist atmosphere and shade from strong sunlight. In June remove to cold frames and stand them on inverted pots well clear of one another. Slugs show a marked partiality for the succulent young leaves and should be excluded by dusting round the frames occasionally with newly slaked lime. The inverted pots serve as traps. The frames may thus be frequently syringed without keeping the plants unduly wet. Shade heavily from direct sunlight, but afford as much diffused light as practicable. Ventilate on all favourable occasions, and close the frames early after copious syringing.

By the end of the month they will be ready for the final shift into 7-in. pots. Much care must be used in handling them, the leaves being large, tender and numerous. The soil is as for the last potting. The frames should be kept close and heavily shaded

for a few days after potting; then gradually reduce shade and increase ventilation. By the end of July the elegance of the foliage alone should well repay the care bestowed on them. From this time onwards very little shading will be needed, the object of the cultivator being to harden the growth already made. With the advent of cool weather in September, remove to flowering quarters in a warm greenhouse. Flowering will begin in November and will continue through the winter and spring. The damping off of the flower-buds may occasionally prove troublesome during winter. This may generally be traced to checks, such as sudden changes in temperature, too low a temperature, careless watering, &c. During spring plants that are flowering freely will require weak manure water about twice a week.

Plants selected to bear seed should be set aside for that purpose, and as soon as the capsules are found to be developing properly they should be reduced to six or seven per plant, and all flower-buds picked off as soon as they are large enough to handle. The production of strong seeds is of the utmost importance.

Plants grown for market purposes, either for decoration or for seed, are sown later than the above, are kept cooler, and during summer receive more ventilation and less shade. This results in the production of plants with much smaller and more erect leaves, which travel well. They are flowered in spring and early summer. The species grown for this purpose is *C. persicum*.

A few species are hardy in dry sheltered positions, such as rockeries, under walls and old trees, provided the positions are well drained. Such are *C. europaeum*, with reddish-purple flowers in summer; *C. hederifolium* in autumn; and *C. neapolitanum*, with large leaves marbled with silver and rosy-pink flowers.

**CYCLE** (Gr. κύκλος, a circle), in astronomy, a period of time at the end of which some aspect or relation of the heavenly bodies recurs. The more important cycles are discussed in the articles CALENDAR and ECLIPSE. In physics, the term is applied to a series of operations which, performed upon a system, brings it back to its original state; "Carnot's Cycle" is an example (see THERMODYNAMICS). From the use of the word for any period at the end of which the same events recur in the same order or for any complete series of phenomena, it is used loosely of any long period of time. The name ὁ ἐπικός κύκλος, the epic cycle, was given to the poems which complete the Homeric account of the Trojan War (see below). It is this use which has given rise to the application of the term "cycle" to a series of prose or poetical romances which have for a centre one subject, whether a person, as in the Alexander, Arthurian or Charlemagne cycles, or an object, such as the ring of the Nibelungenlied. In music "Song-cycle" (Ger. *Liederkreis*) is similarly used of a series of songs written round one subject or set to poems by the same author. Beethoven's *An die ferne Geliebte* (Op. 98), published in 1816, is the earliest instance. Schubert's *Die schöne Müllerin*, Schumann's *Dichterliebe* and Brahms's *Magelone-Lieder* are well-known instances.

**Epic Cycle.**—This is a collection or corpus of lays written about 776–580 B.C. by poets of the Ionian School, introductory or complementary to the Homeric poems, dealing with the legends of the Trojan and Theban wars. At a later date they were arranged so as to form a continuous narrative (the *Iliad* and the *Odyssey* included), perhaps after certain alterations had been made, to fill up gaps and remove inconsistencies and repetitions. By whom, and when, they were so arranged, cannot be decided; it is possible that it was the work of Zenodotus of Ephesus, who had the care of the epic section of the Alexandrian library. In order to furnish the general reader with a comprehensive sketch of mythological history, Proclus—according to Welcker and Valesius (Valois), not the neo-Platonist, but an unknown 2nd or 3rd century grammarian, perhaps Eutyichius Proclus of Sicca<sup>1</sup> in Africa, one of the tutors of Marcus Aurelius (see PROCLUS)—compiled a prose summary (Γραμματικὴ Χρηστομῆθεια)

<sup>1</sup> An objection to this view is that according to the Augustan historian Capitolinus (*Antoninus*, 2) Eutyichius of Sicca was a Latin not a Greek grammarian.

of the contents of the poems, to serve as a sort of primer to Greek literature. Extracts from this are preserved in the *Codex Venetus* of Homer and Photius (cod. 239), according to which the epic cycle began with the union of Uranus and Ge and ended with the death of Odysseus on his return to Ithaca at the hands of his son Telegonus. The cycle was in existence in his (Proclus's) time, and was in request not so much for its artistic merit, as for the "sequence of the events described in it." Further light is thrown on the subject by pictorial representations, intended for school use during the Roman imperial period, the most famous of which is the *Tabula Iliaca* in the Capitoline museum.

The expression "epic cycle" in the sense of a poetical collection does not occur before the Christian era; the word κύκλος ("cycle," "circle") is used of a special kind of short poem and also of a prose abstract of mythological history; the adjective has the general sense of "hackneyed," "conventional," and is applied contemptuously (by Callimachus and Horace) to a particular Alexandrian school of poetry.

The most important poems of the Trojan legendary cycle are the *Cypria* of Stasinus (*q.v.*); the *Aethiopsis* and *Iliou Persis* (Sack of Troy) of Arctinus (*q.v.*); the *Little Iliad* of Lesches (*q.v.*); the *Nosti* of Hagias or Agias; the *Telegonia* of Eugammon. To the Theban cycle belong: the *Thebais* or *Expedition of Amphiarauus* and the *Epigoni* of Antimachus. The *Oechalias Halosis* (capture of *Oechalia*) of Creophylus (*q.v.*); the *Phocais* (or *Minyas*) of Prodicus; and the *Danaïs* of Cercops, although belonging to the old Homeric epos, cannot with certainty be included in the epic cycle. The names of the authors are in several cases exceedingly doubtful.

**BIBLIOGRAPHY.**—The standard work on the subject is F. G. Welcker, *Der epische Cyclus* (1865–1882); see also T. W. Allen, "The Epic Cycle," in *Classical Quarterly*, Jan. and April 1908 (summary of sources and authorities); Wilamowitz-Möllendorff, *Homerische Untersuchungen* (1884), who regards the traditional names and personalities of the poets of the cycle with great scepticism; D. B. Monro, *Journal of Hellenic Studies*, iv. (1883), appendix to his edition of the *Odyssey*, xiii.–xxiv. (1900), and on the *Codex Venetus* fragment of Proclus; J. E. Sandys, *Hist. of Class. Schol.* (2nd ed., 1906), vol. i. ch. 2; J. B. Bury, *Ancient Greek Historians* (1909), pp. 2–8 on the epics as history; articles by H. Flach in Ersch and Gruber, *Allgemeine Encyclopädie*, and by E. Schwartz and others in Pauly-Wissowa, *Realencyclopädie*.

**CYCLING**, the clipped term now given comprehensively to the sport or exercise of riding a bicycle (*q.v.*) or tricycle (*q.v.*).

Suggestions of vehicles having two or more wheels and propelled by the muscular effort of the rider or riders are to be found in very early times, even on the bas-reliefs of Egypt and **History.** Babylon and the frescoes of Pompeii; but though sporadic examples of such contrivances are recorded in the 17th and 18th centuries, it was apparently not till the beginning of the 19th century that they were used to any considerable extent. A "velocipede" invented by Blanchard and Magurier, and described in the *Journal de Paris* on the 27th of July 1779, differed little from the *céléristère* proposed by another Frenchman, de Sivrac, in 1690; it consisted of a wooden bar rigidly connecting two wheels placed one in front of the other, and was propelled by the rider, seated astride the bar, pushing against the ground with his feet. The next advance was made in the *draisine* of Freiherr Karl Drais von Sauerbrunn (1785–1851), described in his *Abbildung und Beschreibung seiner neu erfundenen Laufmaschine* (Nuremberg, 1817). In this the front wheel was pivoted on the frame so that it could be turned sideways by a handle, thus serving to steer the machine (figs. 1 and 2). A similar machine, the "celeripede," also with a movable front wheel, is said to have been ridden by J. N. Niepce in Paris some years before. In England the *draisine* achieved a great, though temporary, vogue under various names, such as velocipede, patent accelerator, bivector, bicipedes, pedestrian curriole (patented by Dennis Johnson in 1818), dandy horse, hobby horse, &c., and for a time it was popular in America also. The propulsion of the *draisine* by pushing with the feet being alleged to give rise to diseases of the legs, arrangements were soon suggested, as by Louis Gompertz in England in 1821, by which the front wheel could be rotated by the hands with the aid of a system

of gearing, but the idea of providing mechanical connexions between the feet and the wheels was apparently not thought of till later. Pedals with connecting rods working on the rear axle are said to have been applied to a tricycle in 1834 by Kirk-



FIG. 1.—Gentleman's Hobby Horse.

patrick McMillan, a Scottish blacksmith of Keir, Dumfriesshire, and to a draisine by him in 1840, and by a Scottish cooper, Gavin Dalzell, of Lesmahagow, Lanarkshire, about 1845. The draisine thus fitted had wooden wheels, with iron tires, the leading one about 30 in. in diameter and the driving one about 40 in., and thus it formed the prototype, though not the ancestor, of the modern rear-driven safety bicycle.

For the next 20 years little was done, and then began the evolution of the high "ordinary" bicycle with a large driving wheel in front and a small trailing one behind. About 1865

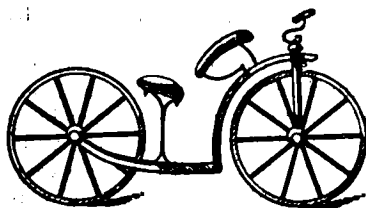

FIG. 2.—Lady's Hobby Horse.

who was a carriage repairer. Lallement took his machine to the United States, and in 1866 was granted a patent which had an important influence on the subsequent course of the cycle industry in that country. This machine, consisting of a wooden frame supported on two wooden wheels (fig. 3), soon became popular in England, as well as in France and America, and came to be called bicycle (or bysicle) by those who took it seriously and "boneshaker" by those who did not. Improvements quickly followed, chiefly in England, for in America the popularity of the machine was short-lived, and in France the industry was checked by the Franco-

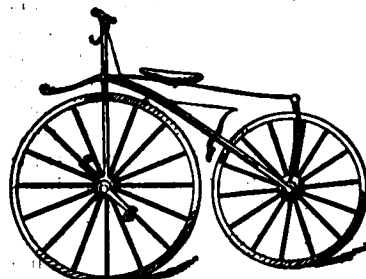

FIG. 3.—The Boneshaker, 1868.

German war. Rubber tires, in place of iron ones, appeared in 1868, and in two or three years were made very large, 2 in. or more in width. Suspension wheels, with wire spokes in tension, were seen at the Crystal Palace, London, on the "Phantom" (fig. 4) of W. F. Reynolds and J. A. Mays in 1869, and early in

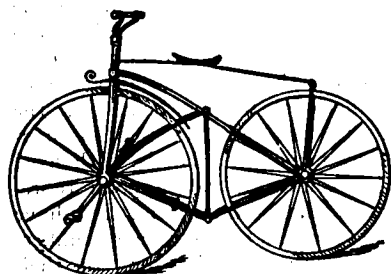

FIG. 4.—The "Phantom," 1869.

the same year the manufacture of bicycles, at first for export to France, was begun in England by the Coventry Sewing Machine Company, till then makers of sewing machines. There was a rapid growth in the size of the front wheel, which in the boneshaker normally measured 36 or 38 in. in diameter, with a corresponding shrinkage in the rear wheel (fig. 5), until by 1874, the date of the invention of the tangent wheel by J. K. Starley 54-in. wheels were being made. The high bicycle was now fairly established in form, and the changes made in the subsequent 10 or 15 years during which it

retained its supremacy were chiefly in the details of construction, such as the adoption of steel tubing for the frames, the use of hollow rims in the wheels and the application first of cone and then of ball bearings to points of friction. The weight of a 54-in. bicycle, which in 1874-1875 exceeded 50 or even 60 lb, was thus reduced to well under 40 lb in machines intended for use on ordinary roads, and to not much over 20 lb in the case of racers.

The high "ordinary" bicycle (fig. 6) gave unquestionable pleasure to many riders, and very fast times were made with it both on the road and on the racing path. In 1882 H. L. Cortis rode 20 m. 300 yds. in one hour, and in April 1884 Thomas Stevens started

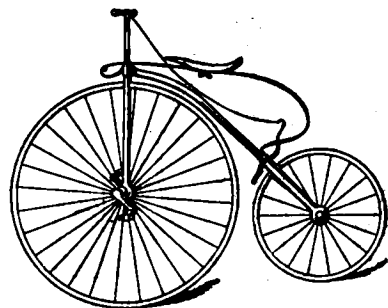

FIG. 5.—Humber's "Spider," 1872.

from San Francisco to ride round the world, a feat which he accomplished in December 1886. But it had various disadvantages. The vibration set up by the small back wheel was very trying, and in spite of the size of the front one the rider had to move his pedals at an uncomfortably rapid rate if he wished to maintain a good speed. Moreover his seat was placed in such a position that he was liable to be pitched over the handlebar if his wheel encountered a comparatively small obstacle. Attempts were made to remedy these inconveniences in various ways. From the early 'eighties much attention was devoted to tricycles, and these were produced in innumerable designs, whether for a single rider, or for two in the form of "sociables," in which the riders sat side by side, or of "tandems," in which one sat behind the other. But their weight, and consequently the exertion of propelling them, was

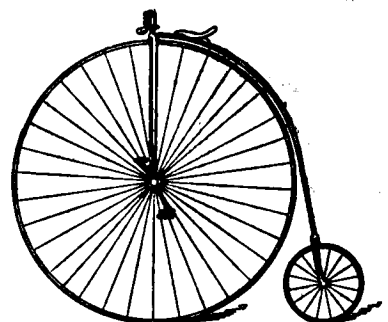

FIG. 6.—Rudge Racing Ordinary, 1887.

necessarily greater than in the case of the bicycle, and by the end of the decade, the demand for them had fallen off, though they are still made to a certain extent, chiefly for carrying purposes. The two-track bicycle (fig. 7), invented by E. C. F. Otto about 1879, in which the rider balanced himself between two equal wheels placed abreast, also failed to secure lasting success.

The improvement of the high bicycle was attempted in two directions. On the one hand it was modified by placing the rider farther back, his position "over his work" being ensured by arranging the pedals immediately below him and connecting them to the front wheel, which was usually reduced in size, by levers and cranks or by chain-gearing, often with a multiplying action. On the other, the rear wheel was enlarged and made the driving wheel. The "Xtraordinary" (fig. 8), "Facile" (fig. 9) and "Kangaroo" were examples of the former kind, which were often spoken of as "dwarf-safeties"; but though a good many of them were used about 1880 and following years, both they and the "ordinary" bicycle ultimately disappeared before machines of the second kind, which developed into the modern rear-driven safety. There are numerous claimants for the invention—or rather the reinvention—of this type,

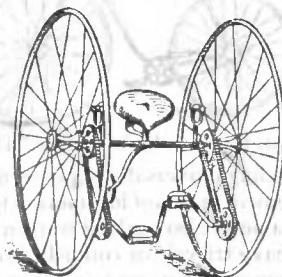

FIG. 7.—Otto Bicycle, 1879.

but it appears that the credit for its practical and commercial introduction in substantially its present form is due to J. K. Starley in England. His "Rover" (fig. 10), brought out late in 1885, had two nearly equal wheels, the driving wheel 30 in. in diameter and the steering 32 in., and the rider sat so far back that he could not be thrown forward over the handles. The

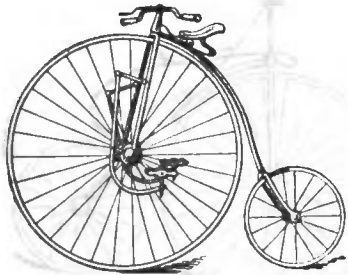

FIG. 8.—Singers' "Xtraordinary," 1879.

motion imparted by the pedals to a sprocket wheel mounted between the wheels was transmitted by an endless chain to the rear wheel, and by sufficiently increasing the size of this sprocket wheel the machine could be made to travel as far or farther than the "ordinary" for each complete revolution of the pedals. From about 1890 the "safety" monopolized the field. At first it was fitted with the narrow rubber tires customary at the time, but these gave way to pneumatic tires, invented in 1888 by J. B. Dunlop, a veterinary surgeon of Belfast, whose idea, however, had been anticipated in the English patent taken out by R. W. Thomson in 1845. The result was a great gain in comfort, due to reduction of vibration, and a remarkable increase of speed or, alternatively, decrease of exertion. Subsequent progress was mainly in the details of design and manufacture, tending to secure lightness combined with adequate strength, and such was the success attained, by the application

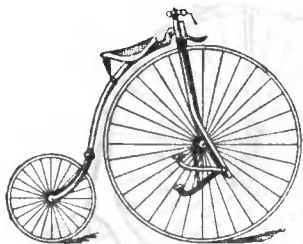

FIG. 9.—The "Facile," 1879.

of scientific principles and of improved methods and materials to the construction of the frames and other parts, that while the weight of the original "Rover" was about 50 lb, that of its successors 20 years later with 28-in. wheels was reduced by 35 or 45%, or even 60% in the case of racing machines. The beginning of the 20th century saw the introduction of two innovations: one was the "free-wheel," a device which allows the driving wheel to rotate independently of the chain and pedals, so that the rider, controlling his speed with powerful brakes, can "coast" down a hill using the stationary pedals as foot-rests; and the other was the motor-cycle, in which a petrol-engine relieves him, except at starting, from all personal exertion, though at the cost of considerable vibration. A third contrivance, which, however, was an idea of considerably older date, also began to find favour about the same period in the shape of two-speed and three-speed gears, enabling the rider at will to alter the ratio between the speed of revolution of his pedals and of his driving wheel, and thereby accommodate himself to the varying gradients of the road he is traversing (see also BICYCLE, TRICYCLE and TIRE).

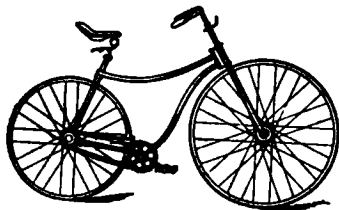

FIG. 10.—Starley's "Rover," 1885. The safety bicycle, with pneumatic tires, rendered cycling universally popular, not merely as a pastime but as a convenient means of locomotion for everyday use. Made with a drop-frame, it also enabled women to cycle without being confined to a heavy tricycle or compelled to assume "rational dress." In consequence there was an enormous expansion in the cycle industry. In England the demand for machines had become so great by 1895 that the makers were unable to cope with it. Numbers of new factories were started, small shops grew into large companies, and the capital invested advanced by millions of pounds. The makers who had devoted their mechanical skill to perfecting

the methods of cycle-construction were swallowed up by company promoters and adventurers, bent simply upon filling their own pockets. The march of mechanical invention and improvement was arrested, and machines, instead of being built by mechanics proud of their work, in many cases were merely put together in the shortest possible time and in a few standard patterns. For these the world clamoured, and for a year they could not be produced fast enough. Then the demand fell off, the British market became over-stocked, and as the British makers declined to consider the wants of foreign customers, their store-rooms remained crowded with machines that could not be sold. Speculative finance, such as was exemplified in 1896 by the flotation for £5,000,000 of the Dunlop tire company, which had been started in 1889 with a capital of £25,000, had its natural effects. There ensued widespread and continuing disorganization of the trade, which had to be met by extensive reconstructions of over-capitalized companies. English makers too had lost the commanding international position they once enjoyed, when they supplied almost the entire demand for bicycles in many parts of the world, including the United States. In America the manufacture of bicycles was not begun until about 1878, when it was introduced by A. A. Pope (1843-1909), and even by 1890 the value of the products barely exceeded 2½ million dollars, while for several years later much of the steel tubing required for bicycle manufacture continued to be imported from Great Britain. The industry, however, thanks to automatic machinery and perfect organization, grew rapidly, and in 1900 the value of its products was nearly 32 million dollars. In the two years 1897 and 1898 the exports of cycles and cycle parts alone were worth nearly 14 million dollars, though they fell off in subsequent years, and English makers had to contend with an American invasion in addition to their domestic troubles. But the competition was short-lived. The American makers sent over machines with single tube tires and wooden rims which did not secure the approval of the British purchaser, and so they too lost their hold. In the opening years of the 20th century the industry in Great Britain gradually recovered itself. More attention was paid to the production of cheap machines which were sound and trustworthy, and sales were further stimulated by the introduction of systems of deferred payments. In 1905 about 600,000 machines were made in Great Britain, and 47,604 were exported, the total value of the home-market for cycles and their parts being about 3½ millions sterling, and of the export trade about one million. In the same year the number of machines imported was only 2345.

Cycle tours were taken and cycle clubs established almost as soon as the cycle appeared, the Pickwick Bicycle Club in London, founded in 1870, being the oldest in the world. The organization of these clubs is chiefly of a social character, and a few possess well-appointed club-houses. To a great extent they have been superseded by the large touring organizations. The Cyclists' Touring Club, organized in 1878 as the Bicycle Touring Club, has members scattered through Europe, America and even the East. Many other countries possess national clubs, as for instance the League of American Wheelmen, founded in 1880, and the Touring Club de France, founded in 1895, of whose objects cycling is only one, though the chief. The aim of these national associations, which have formed an international touring league, is the promotion of cycle touring. To this end they publish road-books, maps and journals; they recommend hotels, with fixed tariffs, in their own and other countries; they appoint representatives to aid their members when touring; and they have succeeded in inducing most governments to allow their members to travel freely across frontiers without paying duty on their machines. In all countries they have erected warning-boards at dangerous places; in France the best route is suggested by a sign-post, and cyclists who meet with accidents in lonely places find repair outfits provided for their free use. Another important part of the work of these clubs, either directly or indirectly, is the improvement of the roads. France has done more for the cyclist than any other country, owing to the fact

Touring clubs.

that she possesses the best roads, kept up to a certain extent by the cycle tax, whereby the cyclist acquires a certain official position and right; moreover cycles accompanied by their owners are conveyed without extra charge on the railways, and aid is given to the sport and pastime from public funds. In Belgium the cycle has worked a veritable revolution in the national life. The surface of the greater part of the country being loose and sandy, the roads have been paved, and this paving is so bad as to be impossible for light traffic. The cycle tax has consequently been devoted, first, to the construction of paths on which cyclists have equal rights with pedestrians, and secondly to the replacing of the paving by macadam. In this way alone cycling has proved of inestimable benefit to Belgium and Luxembourg. In the United States measures for securing good roads and side paths have been introduced in various states, mainly at the instigation first of cyclists and then of motorists, and in Great Britain the Roads Improvement Association has worked for the same end.

Each country also possesses an organization for the government of cycle racing; and although these unions, one object of which—usually the main one—is the encouragement

**Racing.** of cycle racing and cycle legislation, boast an enormous membership, their membership is often composed of clubs and not individuals. Among the most important are the National Cyclists' Union of England and the Union Vélocipédique of France. These bodies are also bound together by the International Cyclists' Association, which is devoted mainly to the promotion of racing and legislation connected with it all over the world. The National Cyclists' Union, originally the Bicycle Union, which was the parent body of all, formed in February 1878, was the first to put up danger-boards, and also was early instrumental, alone and with the C.T.C., in framing or suggesting laws for the proper government and regulation of cycle traffic, notably in establishing its position as a vehicle in securing universal rights, in endeavouring, again in conjunction with the C.T.C., to increase facilities for the carriage of cycles on the railways, in securing the opening of parks, and in promoting many other equally praiseworthy objects. For a number of years, however, it has been more prominent as the ruling race-governing body. But cycle racing has fallen upon evil days. At one time cycle racing attracted a large number of spectators, but gradually it lost the public favour, or rather was ignored by the public because it became mainly an advertisement for cycle makers. The presence of the man, directly or indirectly, in the employ of, or aided by a maker, and the consequent mixing up of trade and sport, lowered racing not only in the public estimation, but in that of all genuine amateurs. There have always been a few amateurs who have raced for the love of the sport, but the greater number of prominent racing men have raced for the benefit of a firm, so much so that, at one time, an entire section of racing men were classed as "makers' amateurs." They did not confine themselves to the race track, but appropriated the public roads until they became a danger and a nuisance, and road-racing finally was abolished, though record rides, as they are called, are still indulged in, being winked at by the police and by the cycling authorities. The makers' amateurs at least rode to win and to make the best time possible. But the scandal was so great that a system of licensing riders was adopted by the N.C.U., and if this did not effectively kill the sport, the introduction of waiting races did. There probably is considerable skill in riding two-thirds of a race as slowly as possible, and only hurrying the last part of the last lap, but it does not amuse the public, who want to see a fast race as well as a close finish. The introduction of pacing by multicycles and motors next took from cycle racing what interest was left. A motor race, in which the machines are run at top speed, is more exciting than the spectacle of a motor being driven at a rate which the cyclist can follow with the protection of a wind-shield. In America this system of proving what cyclists can do with racing machines was carried so far that in 1899 a board track was laid down on the Long Island railway for about 2 m. between the metals, and a cyclist named Murphy, followed a train, and protected by enormous wind-shields, succeeded in covering a mile

in less than a minute in the autumn of 1900. Other cyclists have devoted themselves, at the instigation of makers, to the riding of 100 m. a day every day for a year. It would be difficult to say what advantage there is in these trials and contests. They are not convincing records, and only prove that some people are willing to take great personal risks for the benefit of their employers. E. Hale, during 1899-1900, covered 32,496 m. in 313 days. For many years also long-distance races, mostly of six days' duration, have been promoted on covered tracks, and though condemned by all cycling organizations, they find a great deal of pecuniary support.

The cycle has also been taken up for military purposes. For this idea the British army is indebted to Colonel A. R. Savile, who in 1887 organized the first series of cycle manœuvres **Military.** in England. Since then military cycling has undergone a great development, not only in the country of its origin but in most others.

Cycling has produced a literature of its own, both of the pastime and of the trade. Owing to the enormous profits which, for several years, were obtained by cycle makers, a trade press **Literature.** appeared which simply lived by, and out of, its advertisers; and though each country has one or more genuine trade journals, the large proportion of these sheets have been worth, in a business aspect, as little practically as from a literary standpoint. On the other hand a vast mass of practical and unpractical, scientific and medical, historical and touring treatises and records have appeared, but mostly of a rather ephemeral character.

**CYCLOID** (from Gr. κύκλος, circle, and εἶδος, form), in geometry, the curve traced out by a point carried on a circle which rolls along a straight line. The name cycloid is now restricted to the curve described when the tracing-point is on the circumference of the circle; if the point is either within or without the circle the curves are generally termed *trochoids*, but they are also known as the *prolate* and *curtate* cycloids respectively. The cycloid is the simplest member of the class of curves known as roulettes.

No mention of the cycloid has been found in writings prior to the 15th century. Francis Schooten (*Commentary on Descartes*) assigns the invention of the curve to René Descartes and the first publication on this subject after Descartes to Marin Mersenne. Evangelista Torricelli, in the first regular dissertation on the cycloid (*De dimensione cycloidis*, an appendix to his *De dimensione parabolae*, 1644), states that his friend and tutor Galileo discovered the curve about 1599. John Wallis discussed both the history and properties of the curve in a tract *De cycloide* published at Oxford in 1659. He there shows that the cycloid was investigated by Carolus Bovillus about 1500, and by Cardinal Cusanus (Nicolaus de Cusa) as early as 1451. Honoré Fabri (*Synopsis geometrica*, 1669) treated of the curve and enumerated many theorems concerning it. Many other mathematicians have written on the cycloid—Blaise Pascal, W. G. Leibnitz, the Bernoullis, Roger Cotes and others—and so assiduously was it studied that it was sometimes named the "Helen of Geometers." The determination of the area was the subject of many investigations and much controversy. Galileo attempted the evaluation by weighing the curve against the generating circle; this rough method gave only an approximate value, viz., a little less than thrice the generating circle. Torricelli, by employing the "method of indivisibles," deduced that the area was exactly three times that of the generating circle; this result had been previously established in 1640 in France by G. P. de Roberval, but his investigation was unknown in Italy. Blaise Pascal determined the area of the section made by any line parallel to the base and the volumes and centres of gravity of the solids generated by revolving the curve about its axis and base. Before publishing his results he proposed these problems for public competition in 1658 under the assumed name of Amos Dettonville. John Wallis in England, and A. la Louère in France, accepted the challenge, but the former could only submit incorrect solutions, while the latter failed completely. Having established his priority, Pascal published his investigations, which occasioned a great sensation among his contemporaries, and Wallis was enabled to correct his methods. Sir Christopher Wren, the famous architect, determined the length of the arc and



its centre of gravity, and Pierre Fermat deduced the surface of the spindle generated by its revolution. A famous period in the history of the cycloid is marked by a bitter controversy which sprang up between Descartes and Roberval. The evaluation of the area of the curve had made Roberval famous in France, but Descartes considered that the value of his investigation had been grossly exaggerated; he declared the problem to be of an elementary nature and submitted a short and simple solution. At the same time he challenged Roberval and Fermat to construct the tangent; Roberval failed but Fermat succeeded. This problem was solved independently by Vincenzo Viviani in Italy. The cartesian equation was first given by Wilhelm Gottfried Leibnitz (*Acta eruditorum*, 1686) in the form  $y = (2x - x^2)^{\frac{1}{2}} + \int (2x - x^2)^{\frac{1}{2}} dx$ . Among other early writers on the cycloid were Philippe de Lahire (1640-1718) and François Nicole (1683-1758).

The mechanical properties of the cycloid were investigated by Christiaan Huygens, who proved the curve to be tautochronous. His enquiries into evolutes enabled him to prove that the evolute of a cycloid was an equal cycloid, and by utilizing this property he constructed the isochronal pendulum generally known as the *cycloidal pendulum*. In 1697 John Bernoulli proposed the famous problem of the *brachistochrone* (see MECHANICS), and it was proved by Leibnitz, Newton and several others that the cycloid was the required curve.

The method by which the cycloid is generated shows that it consists of an infinite number of cusps placed along the fixed line and separated by a constant distance equal to the circumference of the rolling circle. The name cycloid is usually restricted to the portion between two consecutive cusps (fig. 1, curve a); the fixed line LM is termed the *base*, and the line PQ which divides the curve symmetrically is the *axis*. The co-ordinates of any point R on the cycloid are expressible in the form  $x = a(\theta + \sin \theta)$ ;  $y = a(1 - \cos \theta)$ , where the co-ordinate axes are the tangent at the vertex O and the axis of the curve,  $a$  is the radius of the generating circle, and  $\theta$  the

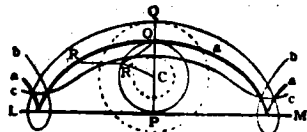

FIG. 1.

angle R'CO, where RR' is parallel to LM and C is the centre of the circle in its symmetric position. Eliminating  $\theta$  between these two relations the equation is obtained in the form  $x = (2ay - y^2)^{\frac{1}{2}} + a$  vers.<sup>1</sup>  $y/a$ . The clumsiness of the relation renders it practically useless, and the two separate relations in terms of a single parameter  $\theta$  suffice for the deduction of most of the properties of the curve. The length of any arc may be determined by geometrical considerations or by the methods of the integral calculus. When measured from the vertex the results may be expressed in the forms  $s = 4a \sin \frac{1}{2}\theta$  and  $s = \sqrt{8ay}$ ; the total length of the curve is  $8a$ . The intrinsic equation is  $s = 4a \sin \psi$ , and the equation to the evolute is  $s = 4a \cos \psi$ , which proves the evolute to be a similar cycloid placed as in fig. 2, in which the curve QOP is the evolute and QPR the original cycloid. The radius of curvature at any point is readily deduced from the

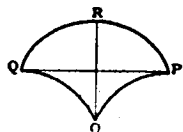

FIG. 2.

intrinsic equation and has the value  $\rho = 4 \cos \frac{1}{2}\theta$ , and is equal to twice the normal which is  $2a \cos \frac{1}{2}\theta$ .

The *trochoids* were studied by Torricelli and F. van Schooten, and more completely by John Wallis, who showed that they possessed properties similar to those of the common cycloid. The cartesian equation in terms similar to those used above is  $x = a\theta + b \sin \theta$ ;  $y = a - b \cos \theta$ , where  $a$  is the radius of the generating circle and  $b$  the distance of the carried point from the centre of the circle. If the point is without the circle, i.e. if  $a < b$ , then the curve exhibits a succession of nodes or loops (fig. 1, curve b); if within the circle, i.e. if  $a > b$ , the curve has the form shown in fig. 1, curve c.

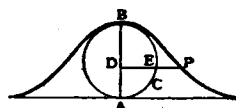

FIG. 3.

The *companion to the cycloid* is a curve so named on account of its similarity of construction, form and equation to the common cycloid. It is generated as follows: Let ABC be a circle having AB for a diameter. Draw any line DE perpendicular to AB and meeting the circle in E, and take a point P on DE such that the line DP = arc BE; then the locus of P is the companion to the cycloid. The curve is shown in fig. 3. The cartesian equation, referred to the fixed diameter and the tangent at B as axes may be expressed in the forms  $x = a\theta$ ,  $y = a(1 - \cos \theta)$  and  $y - a = a \sin(x/a - \frac{1}{2}\pi)$ ; the latter form shows that the locus is the harmonic curve.

For epi- and hypo-cycloids and epi- and hypo-trochoids see EPICYCLOID.

REFERENCES.—Geometrical constructions relating to the curves above described are to be found in T. H. Eagles, *Constructive Geometry of Plane Curves*. For the mechanical and analytical investigation, reference may be made to articles MECHANICS and INFINITESIMAL CALCULUS. A historical bibliography of these curves is given in Brocard, *Notes de bibliographie des courbes géométriques* (1897). See also Moritz Cantor, *Geschichte der Mathematik* (1894-1901).

**CYCLOMETER** (Gr. κύκλος, circle, and μέτρον, measure), an instrument used especially by cyclists to determine the distance they have traversed. In a common form a stud attached to one spoke of the wheel engages with a toothed pinion and moves it on one tooth at each revolution. The pinion is connected with a train of clockwork, the gearing of which bears such a ratio to the circumference of the wheel that the distance corresponding to the number of times it has revolved is shown on a dial in miles or other units.

**CYCLONE** (Gr. κυκλών, whirling, from κύκλος, a circle), an atmospheric system where the pressure is lowest at the centre. The winds in consequence tend to blow towards the centre, but being diverted according to Ferrel's law they rotate spirally inwards at the surface of the earth in a direction contrary to the movement of the hands of a watch in the northern hemisphere, and the reverse in the southern hemisphere. The whole system has a motion of translation, being usually carried forward with the great wind-drifts like eddies upon a swift stream. Thus their direction of movement over the British Islands is usually from S.W. to N.E., though they may remain stationary or move in other directions. The strength of the winds depends upon the atmospheric gradients. (See METEOROLOGY.)

**CYCLOPEAN MASONRY** (from the Cyclopes, the supposed builders of the walls of Mycenae), a term in architecture, used, in conjunction with Pelagic, to define the rude polygonal construction employed by the Greeks and the Etruscans in the walls of their cities. In the earliest examples they consist only of huge masses of rock, of irregular shape, piled one on the other and trusting to their great size and weight for cohesion; sometimes smaller pieces of rock filled up the interstices. The walls and gates of Tiryns and Mycenae were thus constructed. Later, these blocks were rudely shaped to fit one another. It is not always possible to decide the period by the type of construction, as this depended on the material; where stratified rocks could be obtained, horizontal coursing might be adopted; in fact, there are instances in Greece, where a later wall of cyclopean construction has been built over one with horizontal courses.

**CYCLOPES** (Κύκλωπες, the round-eyed, plural of Cyclops), a type of beings variously described in Greek mythology. In Homer they are gigantic cave-dwellers, cannibals having only one eye, living a pastoral life in the far west (Sicily), ignorant of law and order, fearing neither gods nor men. The most prominent among them was Polyphemus. In Hesiod (*Theogony*, 264) they are the three sons of Uranus and Gaea—Briotes, Steropes and Arges,—storm-gods belonging to the family of the Titans, who furnished Zeus with thunder and lightning out of gratitude for his having released them from Tartarus. They were slain by Apollo for having forged the thunderbolt with which Zeus slew Asclepius. Later legend transferred their abode to Mt Aetna, the Lipari islands or Lemnos, where they assisted Hephaestus at his forge. A third class of Cyclopes are the builders of the so-called "Cyclopean" walls of Mycenae and Tiryns, giants with arms in their belly, who were said to have been brought by Proetus from Lycia to Argos, his original home (Pausanias ii. 16. 5; 25. 8). Like the Curetes and Telchines they are mythical types of prehistoric workmen and architects, and as such the objects of worship.

The standard work on these and similar mythological characters is M. Mayer, *Die Giganten und Titanen* (1887); see also A. Boltz, *Die Kyklopen* (1885), who endeavours to show that they were an historical people; W. Mannhardt, *Wald- und Feldkulte* (1904); J. E. Harrison, *Myths of the Odyssey*, 1882; and article in Roscher's *Lexikon der Mythologie* (bibliography).

**CYCLOSTOMATA**, or MARSIPOBRANCHII, a group of fishes including the ordinary lampreys and hagfish, and so called from the wide permanently gaping mouth which is without the hinged jaws characteristic of other vertebrates (GNATHOSTOMATA).

The class Cyclostomata consists of two orders, the Myxinoids (or Hyperotreti) and the Petromyzontes (or Hyperoartii), which, while showing sufficient resemblance in structure to warrant their inclusion in the same class, are yet marked off by such deep-seated differences as to indicate that they commenced to diverge from one another far back in evolutionary time. The order Myxinoids includes the hagfish (*Myxine*), common off the eastern, and occurring also, though less commonly, off the western coasts of the north Atlantic, and the genus *Bdellostoma* (also known as *Homea*, *Eptatretus*, in part—*Polistotrema*), including the "borers" of the western American coast, New Zealand and the Cape of Good Hope. The order Petromyzontes includes the widely distributed lampreys. The original genus *Petromyzon* (which it is now customary to subdivide into a number of genera) includes the large sea lamprey (*P. marinus*) of the north Atlantic coasts and the two fresh-water lampreys of European streams (*P. fluviatilis* and *P. planeri*, the latter of which is possibly only a small-sized variety of the former species). In North America nine or ten species of lampreys are known to occur, descriptions of which are given by Jordan and Evermann (1). In the southern hemisphere occur the two genera *Mordacia* (Chile, Tasmania) and *Geotria* (Chile, Australia, New Zealand) (2).

The Cyclostomes are remarkable among vertebrates in that they are semiparasitic in habit. The lampreys—except some of the small fresh-water forms—attach themselves to other fishes by their suction mouth and proceed to rasp off the flesh by means of the horny teeth carried by the highly-developed tongue. The Myxinoids have gone a step further and actually bore their way right into the body of their prey, devouring all the soft parts and leaving the skin behind as a mere shell, empty but for the bones. Where the hagfish or borers are abundant, as in certain localities off the east coast of Scotland and off the west coast of California, they may do great damage to fisheries from their habit of attacking fishes which are in difficulties through being caught by a hook or in a net; the fish when drawn up being frequently completely deprived of their flesh.

The Myxinoids retain the ancestral marine habitat, but the lampreys have sought refuge from the struggle for existence by taking to fresh water to a less or greater extent. Such a form as *Petromyzon marinus* or *Entosphenus tridentatus* of the west coast of America is what is known as anadromous in habit, i.e. it takes refuge in fresh water during the breeding season, ascending rivers like the salmon for the purpose of spawning. Certain species of lampreys, on the other hand, have completely deserted the sea and spend their whole lives in fresh-water streams or lakes. The lake lampreys show a reminiscence of their ancestral migratory habits in leaving lakes and ascending streams in order to deposit their spawn.

**Anatomy.**—In structural features, the Cyclostomes show a curious mixture of features which must be looked on as primitive with others which are indicative of high specialization for their peculiar mode of life. In general appearance they are "eel-like": they are elongated in shape and adapted for swimming in eel fashion, i.e. the body is propelled forward by the backward passage along it of waves of lateral flexure. There are, however, certain conspicuous differences which at once serve to distinguish a Cyclostome from any other fishes of eel-like shape:—(1) the circular permanently open mouth, (2) the absence of all trace of paired limbs, (3) the absence of paired external nasal openings, and (4) the presence on the roof or at the tip of the head of a conspicuous median opening—the pituitary opening.

It will be convenient, in describing the structural features of the group, to take as a basis for the description the marine lamprey, *Petromyzon marinus*. A marine lamprey is an eel-like creature 70 to 75 cm. in length. At the anterior end and situated somewhat ventrally is the circular widely gaping mouth or buccal cavity, its lining studded with sharply pointed thorn-like "teeth" and its edge fringed with numerous sensory papillae. On the dorsal side of the head is the conspicuous circular pituitary opening with prominent lips, while on the sides are seen the eyes, and behind these a row of somewhat rounded branchial openings or gill-clefts. At about the beginning of the posterior fourth of the body, and in the midventral line, is the anal opening, and immediately behind it is the prominent papilla carrying the opening of the urogenital sinus. The hinder

portion of the body, in accordance with its function in locomotion is flattened from side to side, while its surface is increased by the development of a median fin fold, divided, except in early stages of development, into three portions, known as the first and second dorsal fins and the caudal fin. The last mentioned is of the primitive protocercal type. The whole surface of the body—which shows a conspicuous dark marbling, especially dorsally, on a light ground—is covered with highly glandular epidermis. An important feature is the complete absence of all trace of the calcified placoid plates which are so characteristic of the Elasmobranchii.

The Myxinoids differ from the lampreys in regard to several of the above-mentioned characters. The edges of the mouth carry tentacle-like barbels. The pituitary opening is close to the anterior edge of the mouth opening instead of being right up on the dorsal side of the head. The eyes are invisible, being greatly reduced and sunk far below the surface, and in *Myxine*, though not in *Bdellostoma*, the row of gill openings is represented by a single opening on each side nearly in the midventral line and situated at about the end of the first quarter of the body length. Ventrally the Myxinoid possesses on each side of the body a row of remarkable epidermal glands which can produce at will enormous quantities of glutinous slime. This secretion, which, no doubt, is of much value as a protection from attack, is composed of very fine threads, formed by the conversion of the protoplasm of certain cells of the epidermal glands ("thread cells") into an extremely fine, tightly coiled filament, which becomes unwound when discharged to the exterior.

**Pituitary Tube.**—A remarkable peculiarity of the Cyclostomes lies in the fact that the pituitary ingrowth of ectoderm does not, as in other forms, become involved in the inpushing of ectoderm



From D. Starr Jordan, *A Guide to the Study of Fishes*, by permission of A. Constable & Co., Ltd.

FIG. 1.—The Marine Lamprey (*Petromyzon marinus*, L.).

which forms the buccal cavity. On the contrary, it lies outside the edge of the stomodaeum, and in the case of the lampreys active growth takes place in the tissue between the pituitary and stomodaeal ingrowths, so that the two openings come to be widely separated, the pituitary opening being pushed back on to the dorsal side of the head. The pituitary opening remains patent throughout life, as is the case with Crossopterygians alone amongst Gnathostomata. In *Myxine* a further remarkable peculiarity in regard to the hypophysis, probably adaptive in nature, occurs, inasmuch as the pituitary invagination develops an opening at its posterior end into the pharynx.

**Nervous System.**—The anterior end of the nervous tube is enlarged and differentiated to form a brain as in other Vertebrates, but this brain in the lampreys at least shows remarkably primitive features. The enlargement as compared with the spinal cord is seen to be comparatively slight: the brain is much elongated, and its various regions lie in a straight line one behind the other: the roof of the brain retains to a great extent the primitive epithelial condition. On each side anteriorly there is present a comparatively large olfactory lobe, and this is continued posteriorly into a small cerebral hemisphere.

The lampreys are amongst those vertebrates in which there is an eye-like apparatus (3) connected with the roof of the thalamencephalon. There grow out from the roof of the thalamencephalon two processes, a posterior (the pineal process), and an anterior (the parapineal process). The pineal process grows forwards so as to overlie the parapineal process. Each of these projections from the roof of the thalamencephalon dilates to form a vesicle, and each vesicle shows certain eye-like characteristics, its deep wall forming a "retina" and its superficial wall being clear and translucent ("pellucida"). The retinal cells are packed in the case of the pineal organ with opaque white pigment: similar pigment occurs in smaller quantity in the parapineal organ. Definite sensory cells are also present with rod-like structures projecting into the lumen of the vesicle. Nerve fibres have been traced—from the pineal organ into the posterior commissure and possibly into the right habenular ganglion. As regards other parts of the brain, the chief point to note is that the cerebellum is in a most rudimentary condition, forming merely a slight transverse thickening of the hind-brain roof at its anterior end. In Myxinoids the brain is much larger as compared with the spinal cord, and it differs from that of the lampreys by being relatively much shorter in an anteroposterior direction. A remarkable negative feature lies in the complete absence of the pineal and parapineal organs so conspicuous in the lampreys. The olfactory organ of Cyclostomes is remarkable for two special characteristics, firstly, that the two olfactory organs of other vertebrates are here represented by a single median structure, and secondly,

that the olfactory organ becomes sunk down beneath the surface through becoming involved in the ectodermal ingrowth which forms the pituitary tube. As a further consequence in the case of the lampreys the olfactory organ becomes transported to the roof of the head along with the pituitary opening, which latter functions as an external nostril. That the unpaired olfactory organ of existing Cyclostomes has passed through, in their ancestors, a paired condition such as exists in other vertebrates, is indicated by the fact that it retains a pair of olfactory nerves.

The eyes in adult lampreys are of moderate size, while in the Myxinoids they are greatly reduced—sunk beneath the skin (*Bdellostoma*) or even in amongst the muscles of the head (*Myxine*). The lens is completely absent, also the ocular muscles. The otocyst or auditory organ is unique amongst craniate vertebrates in regard to the semicircular canals. In the lampreys there are only two instead of the normal three, while the Myxinoids have only one.

**Alimentary Canal.**—The widely gaping buccal funnel is morphologically an inpushing of the outer skin, *i.e.* it is stomodaeal in nature. The thorn-like teeth which stud its lining are formed simply by cornification of the epidermal cells (4) like the provisional horny teeth of a tadpole, and are not homologous with the true teeth of ordinary vertebrates. As to whether they represent the remnant of a once present system of epidermal scales, which may have preceded the coating of placoid elements in the evolution of the vertebrate, there is no evidence.

The pharyngeal region, closely associated with the respiratory function, possesses, on each side, a series of gill-sacs (six in *Myxine*; seven in *Petromyzon*, besides an anterior one which is laid down in the embryo but disappears later: up to as many as fourteen in *Bdellostoma*) opening on the one hand to the pharynx and on the other to the exterior. In *Bdellostoma* and in the larva of *Petromyzon*

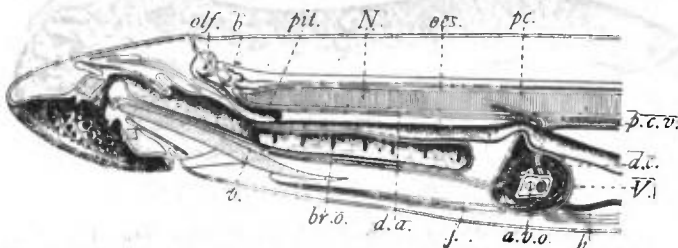

Modified from T. J. Parker, *Zoology*, fig. 4, by permission of Macmillan & Co., Ltd

FIG. 2.—Median longitudinal section through anterior end of *Petromyzon*.

a.v.o.	Atrio-ventricular opening.	oes.	Oesophagus.
br.	Brain.	olf.	Olfactory organ.
br.o.	Internal opening of gill sac.	pc.	Pericardium.
d.a.	Dorsal aorta.	p.c.v.	Left posterior cardinal vein.
d.c.	Ductus Cuvieri.	pit.	Pituitary tube.
h.v.	Hepatic vein.	V.	Ventricle.
i.j.v.	Inferior jugular vein.	v.	Velum.
N.	Notochord.		

the gill-sacs open directly from the pharynx to the exterior, but in the adult lamprey and in *Myxine* the original relations are modified. In *Myxine*, the external openings of the gill-sacs have migrated backwards along the side of the body and become coincident at a point slightly posterior to the last sac. It follows from this that each sac is connected with the common aperture by a tube, longest in the case of the first sac, shortest in the case of the last. In the adult lamprey a different modification is found. Here the dorsal portion of the pharynx has become nipped off as a narrow tube which functions as an oesophagus from the larger ventral portion, which forms an elongated saccular structure ending blindly at its hinder end and having in its lateral wall the internal openings of the gill-sacs.

**Breathing.**—The inspiratory current passes inwards by the mouth opening in the larval lamprey, by the pituitary tube in *Myxine*, while in the adult lamprey both expiration and inspiration takes place through the external gill-openings. In the case of the lampreys the elastic skeleton of the branchial region (see below) plays an important part in respiration. The branchial region shows rhythmic contraction through the agency of the transverse muscles—and expansion, through the elasticity of the branchial skeleton—in the adult lamprey. These rhythmic movements of the branchial region cause successive inflow and outflow through the branchial openings. In the larva, on the other hand, the respiratory current always passes in one direction—backwards. This is helped by the presence of a velar fold at the front end of the pharynx, which acts as a valve opening only backwards, and to the presence of membranous flaps projecting back from the anterior border of each gill-opening and acting as valves which open only outwards.

Behind the pharynx comes the truly digestive part of the alimentary canal in the form of a straight tube showing little differentiation into special regions. The lining of the intestine is increased in area by an inwardly projecting fold, which is compared by some morphologists with the spiral valve of certain other groups. In the

mature river lamprey the digestive tract becomes in great part degenerate.

**Coelomic Organs.**—The chief point of interest about the splanchnocoel or perivisceral cavity is that in the Myxinoids the adult shows a persistent embryonic condition in that the pericardiac portion never becomes isolated from the main body cavity.

The renal organs are of special interest in the Myxinoids from their very simple character. The kidney duct is seen running along the roof of the coelom on either side. Into the duct open short segmentally arranged tubes, each possessing at its closed rounded extremity a Malpighian body. Each of these short tubes is morphologically a nephric tubule, which, however, in correlation with its shortness, is without the turns and twists so characteristic of such tubules generally. A further consequence of the short simple character of the tubules is that they are quite separate from one another, instead of being massed together to form a compact gland such as the kidney is elsewhere. In *Petromyzon* the kidney has the ordinary compact form, and here also the Malpighian bodies are shut off from the splanchnocoel.

The ovary or testis is a large unpaired structure hanging from the dorsal wall of the splanchnocoel and shedding its products into it; from the coelomic space the genital products pass into the urogenital sinus—formed by the fusion of the kidney ducts at their hinder ends—through a small opening, one at each side. This opening, which leads directly from coelom into urogenital sinus, is known as the genital pore. Its morphological significance is doubtful.

**Skeleton.**—The vertebral column of the lamprey is represented by a persistent notochord surrounded by a thick sheath, which shows no signs of invasion by cartilage cells or of segmentation. Resting on the sheath are paired dorsal arch elements, more numerous than the neuromuscular segments. In the tail region these are united into a continuous band of cartilage on each side: similar cartilaginous bands represent the ventral arch elements of the tail region. The skeleton of the head region consists of a cartilaginous cranium, into the formation of which enter typical parachordal and trabecular elements, together with olfactory and auditory capsules. In addition to these, there are a number of other cartilaginous pieces present in the head region, the homologies of which are doubtful.

**Branchial Basket.**—One of the most characteristic features of the skeleton of the lamprey is the remarkable cartilaginous "branchial basket," which supports the gill region. In an adult river lamprey the basketwork consists on each side of a series of eight vertical half-hoops of cartilage. The hoops of each side are connected together dorsally by a pair of longitudinal bars, lying ventral to the notochord, and ventrally by a similar pair of rods which are fused in the middle line. Slender cartilaginous projections arise from the anterior and posterior sides of the hoops, and certain of these meeting at their ends form additional longitudinal bars connecting together successive hoops. Connected with the basketwork posteriorly is a remarkable cup-shaped cartilage, which supports the hind wall of the pericardium. The series of cartilaginous half-hoops naturally suggest the half-hoops of cartilage which form the skeleton of the visceral arches in the Gnathostomata. They are, however, more superficial in position, and this has led many to doubt their actual homology with the cartilaginous visceral arches. Taking into account, however, our present knowledge of the development of the two sets of structures, it seems on the whole probable that a true homology exists and that the branchial basket of the lamprey represents merely a set of visceral arches modified in accordance with the peculiar breathing methods of the creature. In the Myxinoids the branchial basket is reduced to a few vestigial masses of cartilage.

**Vascular System.**—The heart (5) of the lamprey consists of an atrium and a single ventricle, the atrium on the left, the ventricle on the right. Into the atrium, on its right side, and behind the atrio-ventricular opening, there opens a nearly vertical chamber usually termed the sinus venosus (see below), the opening guarded by a pair of vertically placed valves. The ventricle passes anteriorly into what is clearly the homologue of the conus arteriosus of other forms. In its interior are present a pair of laterally placed longitudinal ridges similar to the ridges which occur in other forms in the conus. The opening from ventricle into conus is guarded by a pair of laterally placed pocket valves situated just within the boundary of the ventricle.

The arterial system is of the ordinary piscine type. From the heart there passes forwards a ventral aorta, split into two separate vessels in its anterior half, and giving off on each side a series of efferent vessels to the gill-sacs, one passing between each two gill-sacs and an additional one to the front wall of the front sac and to the posterior wall of the last. The blood is collected from the walls of the gill-sacs by a series of efferent vessels which open into the dorsal aorta. It is to be noted that the dorsal aorta retains the probably primitive unpaired condition, except for a very short extent at its anterior end, where it is split so as to form two short aortic roots.

**Venous System.**—The main venous channels are like those in other fishes, though their connexion with the heart becomes modified in the adult. The two posterior cardinals—with their continuations forwards, the anterior cardinals—approach the median plane and undergo fusion in the region of their opening into the two ductus Cuvieri. The left ductus Cuvieri then atrophies so that all the blood from the cardinals reaches the heart by way of the originally right

ductus Cuvieri. It is this right ductus Cuvieri which forms the dorsal part of what is usually termed the sinus venosus. The inferior jugular veins which return the blood from the ventral side of the head also become replaced in the adult by a median unpaired vein which opens posteriorly into the sinus venosus by what probably represents the hinder end of the original right inferior jugular. It is interesting to note that in *Polypterus*, one of the Crossopterygian ganoids, there is a somewhat similar asymmetrical condition of inferior jugulars and ductus Cuvieri.

**Oviposition of Lamprey (6).**—The lamprey chooses as spawning ground a part of the stream with fairly rapid current and where the bottom is composed of sand with scattered stones. By means of the suctorial mouth, stones are removed from more or less circular area so as to form a shallow excavation. The male and female frequently work together at the task of preparing the nest. When oviposition is about to take place, the male may be seen to suddenly attach himself to the dorsal surface of the head of the female which holds on to one of the stones at the upper margin of the nest. The urogenital opening of the male, with its specially prominent papilla, is approximated to that of the female, and with a peculiar quivering movement the eggs and sperms are emitted synchronously amidst clouds of sand stirred up by the movements of the tail. The eggs fertilized thus at the moment of exit are very sticky from their coating of albumen, and become weighted down by adherent grains of sand.

**Development.**—The development of the lamprey is of much morphological importance from the archaic nature of the creature and from the fact that the egg is comparatively small (about 1 mm. in diameter), so that development is not greatly modified by a large mass of yolk. It has been worked out so far only in the river lamprey (7). Segmentation is complete and unequal. It, as well as the process of gastrulation, agrees in its main features with the same phenomenon in *Amia*, Dipnoans and Urodele amphibians. The blastopore persists as the anal opening of the adult. The mesoderm arises in a manner closely comparable with that which occurs in *Amphioxus*, the chief difference being that the mesoderm segments are solid instead of hollow, except in the anterior head region, where they are true hollow enterocoelic pouches. The rudiment of the central nervous system has the form of a solid keel-like ingrowth of ectoderm along the mid-dorsal line, which only secondarily becomes hollowed out—just as happens in Teleostean fishes. The young lamprey, after completing its embryonic development, passes three or four years, in fact its whole life up to the time of sexual maturity, in a prolonged larval condition in which its structure shows important differences from that of the adult. This larval stage of the freshwater lamprey of Europe was long supposed to be a separate genus of Cyclostomes and was called *Ammocoetes*. The *Ammocoetes* lives in the mud and breathes and feeds by means of a current of water produced by ciliary action, which carries Flagellates and other microscopic organisms in through the mouth opening. Correlated with this mode of feeding the buccal cavity is without the teeth so characteristic of the adult. A number of complicated branched sensory processes grow into and nearly occlude the cavity, forming a kind of sieve with only narrow chinks through which the ingoing current passes. The water passes out by the gill openings, which in *Ammocoetes* open direct from pharynx to exterior. Certain arrangements of the pharyngeal wall of *Ammocoetes* show a remarkable resemblance to what is found in *Amphioxus*. The thyroid, which in the adult is a complicated ductless gland, has in the young *Ammocoetes* the form of a longitudinal groove of the ventral wall of the pharynx. This groove is lined by columnar cells, some carrying cilia, others being glandular and secreting sticky slime. These gland cells are arranged in four longitudinal bands. The thyroid is, in fact, in this stage in a condition corresponding exactly with the endostyle of *Amphioxus*. The agreement extends to function the secretion, forming sticky threads which entangle food particles. Anteriorly a pair of peripharyngeal bands pass dorsalwards, one on each side, to bend back suprapharyngeal banus which are continued to the hinder end of the pharynx. Here again the resemblance to what occurs in *Amphioxus* is very close.

The *Ammocoetes* possesses a functional liver with bileduct, while in the adult river lamprey the alimentary canal is degenerate. It has no arch elements on its notochord. Its eyes are sunk beneath the surface and nonfunctional, and they retain to a great extent an embryonic character (8). There is a rapid process of metamorphosis from the larval to the adult condition, the details of which are by no means sufficiently known. After the metamorphosis the now mature lamprey accomplishes the act of reproduction and then apparently dies almost immediately. The development of the Myxinoidea is much less well known than that of the lampreys. As regards the common hagfish (*Myxine glutinosa*), we are indeed still in complete ignorance in regard to its developmental history in spite of persistent efforts to obtain embryological material. It seems probable that during the breeding period the hagfishes retire into some particularly inaccessible habitat. Within the last few years, however, abundant material illustrating the developmental history of *Bdellostoma* (9) has been obtained off the Californian coast, and this when fully worked out will give us a good idea of the general lines of Myxinooid development. The egg differs greatly from that of the lampreys. It is—as is that of *Myxine*—of large size, richly

yolked and of a shortened-up sausage shape. It measures about 22 mm. by 8 mm. Surrounding the egg is a protective capsule of a yellow horny appearance. At one end a cap-like portion of which forms a detachable operculum, in the middle of which is a minute opening, the micropyle. Each end of the capsule is prolonged into a group of stiff processes with anchor-like expansions at their tips. Segmentation is, as in other richly yolked eggs, incomplete, confined to the germinal disk at the opercular pole. The central nervous system in *Bdellostoma* develops by the overarching of medullary folds, not out of a solid keel as is the case with the lampreys.

**History in Time.**—The softness of the skeletal tissues and the absence of scales in Cyclostomata provide little opportunity for the preservation of fossil remains of this group, and no known fossils can be referred with certainty to the Cyclostomata. The Devonian *Palaeospondylus gunni* has been regarded as a Cyclostome by some authors, but this relationship is at the least doubtful. Other authors have associated the Ostracoderms, the oldest known vertebrates, with this group.

**REFERENCES.**—1. D. S. Jordan and B. W. Evermann, *Fishes of North and Middle America* (Washington, 1896), part i. p. 8; 2. L. Plate, *SB. Ges. Naturf.* (Berlin, Jg. 1897), p. 137; 3. F. Studnička in Oppel's *Lehrbuch der vergleichenden mikroskopischen Anatomie der Wirbeltiere* (Jena, 1905), Teil v. s. i.; 4. E. Warren, *Q. J. Micr. Sci.* xlv. (1902) p. 631; 5. L. Vialleton, *Arch. d'anat. micr.* T. vi. (1903) p. 283; 6. H. A. Surface in D. S. Jordan's *Fishes* (1905), vol. i. p. 494; 7. A. E. Shipley, *Q. J. Micr. Sci.* xxvii. (1887), W. B. Scott, *Journ. Morphol.* i. (1887), C. Kupffer, *Arch. mikr. Anat.* xxxv. (1890), A. Goette, *Entwick. des Flussneunauges* (Hamburg and Leipzig, 1890); 8. C. Kohl, in *Bibliotheca zoologica*, Heft 13 (Cassel, 1892); 9. Bashford Dean in Kupffer's *Festschrift* (Jena, 1899). (J. G. K.)

**CYCLOSTYLE** (Gr. κύκλος, a circle, and στυλος, a column), a term used in architecture. A structure composed of a circular range of columns without a core is cyclostylar; with a core the range would be peristyle. This is the species of edifice called by Vitruvius monopteral.

**CYGNUS** ("The Swan"), in astronomy, a constellation of the northern hemisphere, mentioned by Eudoxus (4th century B.C.) and Aratus (3rd century B.C.), and fabled by the Greeks to be the swan in the form of which Zeus seduced Leda. Ptolemy catalogued 19 stars, Tycho Brahe 18, and Hevelius 47. In this constellation  $\beta$  *Cygni* is a fine coloured double star, consisting of a yellow star, magnitude 3, and a blue star, magnitude 5½. The fine double star,  $\mu$  *Cygni*, separated by Sir William Herschel in 1779, has magnitudes 4 and 5; it has a companion, of magnitude 7½, which, however, does not form part of the system. A double star,  $\delta$  *Cygni*, of magnitudes 5.3 and 5.9, was the first star whose distance was determined; its parallax is 0".39, and it is therefore the nearest star in the northern hemisphere with the exception of  $\sigma$  *Centauri*. A regular variable,  $\chi$  *Cygni*, has extreme magnitudes of 5 to 13.5, and its period is 406 days. *Nova Cygni* is a "new" star discovered by Johann Schmidt in 1876. There is also an extended nebula in the constellation.

**CYLINDER** (Gr. κύλινδρος, from κλίνδω, to roll). A cylindrical surface, or briefly a cylinder, is the surface traced out by a line, named the generatrix, which moves parallel to itself and always passes through the circumference of a curve, named the directrix; the name cylinder is also given to the solid contained between such a surface and two parallel planes which intersect a generatrix. A "right cylinder" is the solid traced out by a rectangle which revolves about one of its sides, or the curved surface of this solid; the surface may also be defined as the locus of a line which passes through the circumference of a circle, and is always perpendicular to the plane of the circle. If the moving line be not perpendicular to the plane of the circle, but moves parallel to itself, and always passes through the circumference, it traces an "oblique cylinder." The "axis" of a circular cylinder is the line joining the centres of two circular sections; it is the line through the centre of the directrix parallel to the generators. The characteristic property of all cylindrical surfaces is that the tangent planes are parallel to the axis. They are "developable" surfaces, i.e. they can be applied to a plane surface without crinkling or tearing (see SURFACE).

Any section of a cylinder which contains the axis is termed a "principal section"; in the case of the solids this section is a rectangle; in the case of the surfaces, two parallel straight lines. A section of the right cylinder parallel to the base is obviously a circle; any other section, excepting those limited by two



generators, is an ellipse. This last proposition may be stated in the form:—"The orthogonal projection of a circle is an ellipse"; and it permits the ready deduction of many properties of the ellipse from the circle. The section of an oblique cylinder by a plane perpendicular to the principal section, and inclined to the axis at the same angle as the base, is named the "subcontrary section," and is always a circle; any other section is an ellipse.

The mensuration of the cylinder was worked out by Archimedes, who showed that the volume of any cylinder was equal to the product of the area of the base into the height of the solid, and that the area of the curved surface was equal to that of a rectangle having its sides equal to the circumference of the base, and to the height of the solid. If the base be a circle of radius  $r$ , and the height  $h$ , the volume is  $\pi r^2 h$  and the area of the curved surface  $2\pi r h$ . Archimedes also deduced relations between the sphere (*q.v.*) and cone (*q.v.*) and the circumscribing cylinder.



The name "cylindroid" has been given to two different surfaces. Thus it is a cylinder having equal and parallel elliptical bases; *i.e.* the surface traced out by an ellipse moving parallel to itself so that every point passes along a straight line, or by a line moving parallel to itself and always passing through the circumference of a fixed ellipse. The name was also given by Arthur Cayley to the conoidal cubic surface which has for its equation  $z(x^2+y^2) = 2mxy$ ; every point on this surface lies on the line given by the intersection of the planes  $y = x \tan \theta$ ,  $z = m \sin 2\theta$ , for by eliminating  $\theta$  we obtain the equation to the surface.

**CYLLENE** (mod. *Ziria*), a mountain in Greece, in the N.E. of Arcadia (7789 ft.). It was specially sacred to Hermes, who was born in a cave on the mountain, and had a temple and an ancient statue on its summit. The name Cyllene belongs also to an ancient port town in Elis, and, owing to doubtful identification with this, to a modern port at Glarentza, and also to some mineral baths a little to the south of it.

**CYMA** (Gr. *κύμα*, wave), in architecture, a moulding of double curvature, concave at one end, convex at the other. When the concave part is uppermost, it is called a *cyma recta*; but if the convex portion is at the top, it is called a *cyma reversa*. When the crowning moulding of an entablature is of the cyma form, it is called a "cymatium."

**CYMBALS** (Fr. *cymbales*; Ger. *Becken*; Ital. *piatti* or *cinelli*), a modern instrument of percussion of indefinite musical pitch, whereas the small ancient cup-shaped cymbals sounded a definite note. Cymbals consist of two thin round plates of an alloy containing 8 parts of copper to two of tin, each having a handle-strap set in the little knob surmounting the centre of the plate. The sound is obtained not by clashing them against each other, but by rubbing their edges together by a sliding movement. Sometimes a weird effect is obtained by suspending one of the cymbals by the strap and letting a drummer execute a roll upon it as it swings; or by holding a cymbal in the left hand and striking it with the soft stick of the bass drum, which produces a sound akin to that of the tam-tam. All gradations of *piano* and *forte* can be obtained on the cymbals. The composer indicates his intention of letting the cymbals vibrate by "Let them vibrate," and the contrary effect by "Damp the sound." To stop the vibrations the performer presses the cymbals against his chest, as soon as he has played a note. The duration of the vibration is indicated by the *value* of the note placed upon the staff; the name signifies nothing, since the pitch of the cymbals is indefinite. The instrument is played from the same part of the score as the bass drum, unless otherwise indicated by *senza piatti*, or *piatti soli* if the bass drum is to remain silent. Although cymbals are not often required they form part of every orchestra; their chief use is for marking the rhythm and for producing weird, fantastic effects or adding military colour, and their shrill notes hold their own against a full orchestra playing *fortissimo*. Cymbals are specially suited for suggesting frenzy, fury or bacchanalian revels, as in the Venus music in Wagner's *Tannhäuser* and Grieg's *Peer Gynt* suite. Damping gives a suggestion of impending evil or tragedy. The *timbre* of the ancient cymbals is entirely different, more like that of small

hand-bells or of the notes of the keyed harmonica. They are not struck full against each other, but by one of their edges, and the note given out by them is higher in proportion as they are thicker and smaller. Berlioz in *Romeo and Juliet* scored for two pairs of cymbals, modelled on some ancient Pompeian instruments no larger than the hand (some are no larger than

a crown piece), and tuned to  and .

The origin of the cymbals must be referred to prehistoric times. The ancient Egyptian cymbals closely resembled our own. The British Museum possesses two pairs, 5½ in. in diameter, one of which was found in the coffin of the mummy of Ankh-hafē, a sacred musician; they are shown in the same case as the mummy, and have been reproduced by Carl Engel.<sup>1</sup> Those used by the Assyrians were both plate- and cup-shaped. The Greek cymbals were cup- or bell-shaped, and are to be seen in the hands of fauns and satyrs innumerable in sculptures and on painted vases. The word cymbal is derived from *κύμβα* (Lat. *cymba*), a hollow vessel, and *κύμβαλα* = small cymbals. During the middle ages the word cymbal was applied to the *Glockenspiel*, or peal of small bells, and later to the dulcimer, perhaps on account of the clear bell-like tone produced by the hammers striking the wire strings. After the introduction or invention of the keyed dulcimer or clavichord, and of the spinet, the word *clavicymbal* was used in the Romance languages to denote the varieties of spinet and harpsichord. Ancient cymbals are among the instruments played by King David and his musicians in the 9th-century illuminated MS. known as the Bible of Charles the Bald in the Bibliothèque Nationale, Paris. (K. S.)

**CYNEGILS** (d. 643), king of the West Saxons, succeeded his uncle King Ceolwulf in 611. With his son Cwichelm (d. 636), he defeated the advancing Britons at Bampton in Oxfordshire in 614, and Cwichelm sought to arrest the growing power of the Northumbrian king Eadwine by procuring his assassination; the attempt, however, failed, and in 626 the West Saxons were defeated in battle and forced to own Eadwine's supremacy. Cyne-gils' next struggle was with Penda of Mercia, and here again he was worsted, the battle being fought in 628 at Cirencester, and was probably compelled to surrender part of his kingdom to Mercia. Cyne-gils was converted to Christianity through the preaching of Birinus, and was baptized in 635 at Dorchester in Oxfordshire, where he founded a bishopric. He was succeeded as king by his son Cenwalh.

**CYNEWULF** (d. 785), king of Wessex, succeeded to the throne in 757 on the deposition of Sigeberht. He was constantly at war with the Welsh. In 779 Offa of Mercia defeated him and took Bensington. In 785 he was surprised and killed, with all his thegns present, at Marten, Wilts (Merantune), by Cyneheard, brother of the deposed Sigeberht.

See Earle and Plummer's edition of the *Anglo-Saxon Chronicle*, 755. 779 (Oxford, 1892).

**CYNEWULF**, the only Old-English vernacular poet, known by name, of whom any undisputed writings are extant. He is the author of four poems preserved in two MSS., the *Exeter Book* and the *Vercelli Book*, both of the early 11th century. An epilogue to each poem contains the runic characters answering to the letters *c, y, n (e), w, u, l, f*. The runes are to be read as the words that served as their names; these words enter into the metre of the verse, and (except in one poem) are significant in their context. The poems thus signed are the following. (1) A meditation on *The Ascension*, which stands in the *Exeter Book* between two similar poems on the Incarnation and the Last Judgment. The three are commonly known as *Cynewulf's Christ*, but the runic signature attests only the second. (2) A version of the legend of the martyr *St Juliana*, also in the *Exeter Book*. (3) *Elene*, in the *Vercelli Book*, on the story of the empress Helena and the "Invention of the Cross." (4) A short poem on *The Fates of the Apostles*, in the same MS. The page containing the signature to this poem was first discovered by Professor A. S. Napier in 1888, so that the piece is not included in earlier enumerations of the poet's signed works.

In *Juliana* and *Elene* the name is spelt Cynewulf; in *The Ascension* the form is Cynwulf. In *The Fates of the Apostles* the page is defaced, but the spelling Cynwulf is almost certain.

<sup>1</sup> *The Music of the Most Ancient Nations*, fig. 75, p. 227.



The absence of the E in *The Ascension* can hardly be due to a scribal omission, for the name of this letter (meaning "horse") would not suit the context; this was perhaps the motive for the choice of the shorter form. The orthography (authenticated as the poet's own by the nature of his device) has chronological significance. If the poems had been written before 740, the spelling would almost certainly have been Cyniwulf. If it were safe to judge from the scanty extant evidence, we should conclude that the form Cynwulf came in about 800; and presumably the poet would not vary his accustomed signature until the new form had become common. In *Elene* Cynewulf speaks of himself as an old man; and the presence of the runic signature in the four works suggests that they are not far apart in date. They may therefore be referred provisionally to the beginning of the 9th century, any lower date being for linguistic and metrical reasons improbable.

The MSS. of the poems are in the West-Saxon dialect, with occasional peculiarities that indicate transcription from Northumbrian or Mercian. Professor E. Sievers's arguments for a Northumbrian original have considerable weight; for the Mercian theory no linguistic arguments have been adduced, but it has been advocated on grounds of historical probability which seem to be of little value.

Cynewulf's unquestioned poems show that he was a scholar, familiar with Latin and with religious literature, and they display much metrical skill and felicity in the use of traditional poetic language; but of the higher qualities of poetry they give little evidence. There are pleasing passages in *Elene*, but the clumsy and tasteless narration of the Latin original is faithfully reproduced, and the added descriptions of battles and voyages are strings of conventional phrases, with no real imagination. In *The Ascension* the genuine religious fervour imparts a higher tone to the poetry; the piece has real but not extraordinary merit. Of the other two poems no critic has much to say in praise. If Cynewulf is to be allowed high poetic rank, it must be on the ground of his authorship of other works than those which he has signed. At one time or other nearly the whole body of extant Old English poetry (including *Beowulf*) has been conjecturally assigned to him. Some of the attributed works show many striking resemblances in style and diction to his authentic writings. But it is impossible to determine with certainty how far the similarities may be due to imitation or to the following of a common tradition.

Until recently, it was commonly thought that Cynewulf's authorship of the Riddles (*q.v.*) in the *Exeter Book* was beyond dispute. The monodramatic lyric *Wulf and Eadwacer*, imagined to be the first of these Riddles, was in 1857 interpreted by Heinrich Leo as a charade on the name Cynewulf. This absurd fancy was for about thirty years generally accepted as a fact, but is now abandoned. Some of the Riddles have been shown by Professor E. Sievers to be older than Cynewulf's time; that he may have written some of the rest remains a bare possibility.

The similarity of tone in the three poems known as the *Christ* affords some presumption of common authorship, which the counter arguments that have been urged seem insufficient to set aside. Both *The Incarnation* and *The Last Judgment* contain many passages of remarkable power and beauty. It is unlikely that the author regarded the three as forming one work. The *Christ* is followed in the MS. by two poems on *Saint Guthlac*, the second of which is generally, and with much probability, assigned to Cynewulf. The first Guthlac poem is almost universally believed to be by another hand. Cynewulf's celebration of a midland saint is the strongest of the arguments that have been urged against his Northumbrian origin; but this consideration is insufficient to outweigh the probability derived from the linguistic evidence.

Cynewulf's reputation can gain little by the attribution to him of *Guthlac*, which is far inferior even to *Juliana*. Very different would be the effect of the establishment of his much disputed claim to *Andreas*, a picturesque version of the legend of the Apostle Andrew. The poem abounds to an astonishing extent in "Cynewulfian" phrases, but it is contended that these

are due to imitation. If the author of *Andreas* imitated *Elene* and *Juliana*, he bettered his model. The question whether Cynewulf may not have been the imitator has apparently never been discussed. The poem (so far agreeing with *The Fates of the Apostles*) copies the style of the old heroic poetry.

Cynewulf's authorship has been asserted by some scholars for *The Dream of the Rood*, the noblest example of Old English religious poetry. But an extract from this poem is carved on the Ruthwell Cross; and, notwithstanding the arguments of Prof. A. S. Cook, the language of the inscription seems too early for Cynewulf's date. The similarities between the *Dream* and *Elene* are therefore probably due to Cynewulf's acquaintance with the older poem.

The only remaining attribution that deserves notice is that of the *Phoenix*. The author of this fine poem was, like Cynewulf, a scholar, and uses many of his turns of expression, but he was a man of greater genius than is shown in Cynewulf's signed compositions.

Professor M. Trautmann, following J. Grimm and F. Dietrich, would identify the poet with Cynewulf, bishop of Lindisfarne, who died in 783. This speculation conflicts with the chronology suggested in this article, and is destitute of evidence. Cynewulf was indeed probably a Northumbrian churchman, but it is unlikely that there were not many Northumbrian churchmen bearing this common name; and as the bishop is not recorded to have written anything, the identification is at best an unsupported possibility. Professor A. S. Cook has suggested that our Cynewulf may have been the "Cynulf," priest of Dunwich, whose name is among those appended to a decree of the council of Clofesho in 803, and of whom nothing else is known. This conjecture suits the probable date of Cynewulf, but otherwise there is nothing in its favour.

For the older literature relating to Cynewulf, see R. Wülker, *Grundriss der angelsächsischen Literatur* (1885). References to the most important later discussions will be found in M. Trautmann, *Kynewulf, der Bischof und Dichter* (1898), and the introductions and notes to the editions of *Cynewulf's Christ*, by I. Gollancz (1892) and A. S. Cook (1900). For the arguments for Cynewulf's authorship of *Andreas*, see F. Ramhorst, *Andreas und Cynewulf* (1885). (H. BR.)

**CYNICS**, a small but influential school of ancient philosophers. Their name is variously derived from the building in Athens called Cynosarges, the earliest home of the school, and from the Greek word for a dog (*κυν*), in contemptuous allusion to the uncouth and aggressive manners adopted by the members of the school. Whichever of these explanations is correct, it is noticeable that the Cynics agreed in taking a dog as their common badge or symbol (see **DIOGENES**). From a popular conception of the intellectual characteristics of the school comes the modern sense of "cynic," implying a sneering disposition to disbelieve in the goodness of human motives and a contemptuous feeling of superiority.

As regards the members of the school, the separate articles on **ANTISTHENES**, **CRATES**, **DIOGENES** and **DEMETRIUS** contain all biographical information. We are here concerned only to examine the general principles of the school in its internal and external relations as forming a definite philosophic unit. The importance of these principles lies not only in their intrinsic value as an ethical system, but also in the fact that they form the link between Socrates and the Stoics, between the essentially Greek philosophy of the 4th century B.C. and a system of thought which has exercised a profound and far-reaching influence on medieval and modern ethics. From the time of Socrates in unbroken succession up to the reign of Hadrian, the school was represented by men of strong individuality. The leading earlier Cynics were Antisthenes, Diogenes of Sinope, Crates of Thebes, and Zeno; in the later Roman period, the chief names are Demetrius (the friend of Seneca), Oenomaus and Demonax. All these men adhered steadfastly to the principles laid down by Antisthenes.

Antisthenes was a pupil of Socrates, from whom he imbibed the fundamental ethical precept that virtue, not pleasure, is the end of existence. He was, therefore, in the forefront of that intellectual revolution in the course of which speculation ceased

to move in the realms of the physical<sup>1</sup> and focused itself upon human reason in its application to the practical conduct of life. "Virtue," says Socrates, "is knowledge": in the ultimate harmony of morality with reason is to be found the only true existence of man. Antisthenes adopted this principle in its most literal sense, and proceeded to explain "knowledge" in the narrowest terms of practical action and decision, excluding from the conception everything except the problem of individual will realizing itself in the sphere of ordinary existence. Just as in logic the inevitable result was the purest nominalism, so in ethics he was driven to individualism, to the denial of social and national relations, to the exclusion of scientific study and of almost all that the Greeks understood by education. This individualism he and his followers carried to its logical conclusion. The ordinary pleasures of life were for them not merely negligible but positively harmful inasmuch as they interrupted the operation of the will. Wealth, popularity and power tend to dethrone the authority of reason and to pervert the soul from the natural to the artificial. Man exists for and in himself alone; his highest end is self-knowledge and self-realization in conformity with the dictates of his reason, apart altogether from the state and society. For this end, disrepute and poverty are advantageous, in so far as they drive back the man upon himself, increasing his self-control and purifying his intellect from the dross of the external. The good man (*i.e.* the wise man) wants nothing: like the gods, he is *αὐταρκής* (self-sufficing); "let men gain wisdom—or buy a rope"; he is a citizen of the world, not of a particular country (cf. Diogenes Laërtius vi. 11 *μόνην τε ὀρθήν πολιτείαν εἶναι τὴν, ἐν κόσμῳ*).

It is not surprising that the pioneers of such a system were criticized and ridiculed by their fellows, and this by no means unjustly. We learn that Diogenes and Crates sought to force their principles upon their fellows in an obtrusive, tactless manner. The very essence of their philosophy was the negation of the graces of social courtesy; it was impossible to "return to nature" in the midst of a society clothed in the accumulated artificiality of evolved convention without shocking the ingrained sensibilities of its members. Nor is it unjust to infer that the sense of opposition provoked some of the Cynics to an overweening display of superiority. At the same time, it is absurd to regard the eccentricities of a few as the characteristics of the school, still more as a condemnation of the views which they held.

In logic Antisthenes was troubled by the problem of the One and the Many. A nominalist to the core, he held that definition and predication are either false or tautological. Ideas do not exist save for the consciousness which thinks them. "A horse," said Antisthenes, "I can see, but horsehood I cannot see." Definition is merely a circuitous method of stating an identity: "a tree is a vegetable growth" is logically no more than "a tree is a tree."

Cynicism appears to have had a considerable vogue in Rome in the 1st and 2nd centuries A.D. Demetrius (*q.v.*) and Demonax are highly eulogized by Seneca and Lucian respectively. It is probable that these later Cynics adapted themselves somewhat to the times in which they lived and avoided the crude extravagance of Diogenes and others. But they undoubtedly maintained the spirit of Antisthenes unimpaired and held an honourable place in Roman thought. This very popularity had the effect of attracting into their ranks charlatans of the worst type. So that in Rome also Cynicism was partly the butt of the satirist and partly the ideal of the thinker.

Disregarding all the accidental excrescences of the doctrine, Cynicism must be regarded as a most valuable development and as a real asset in the sum of ethical speculation. With all its defective psychology, its barren logic, its immature technique, it emphasized two great and necessary truths, firstly, the absolute responsibility of the individual as the moral unit, and, secondly, the autocracy of the will. These two principles are sufficient ground for our gratitude to these "athletes of righteousness" (as Epictetus calls them). Furthermore they are profoundly

<sup>1</sup> See IONIAN SCHOOL OF PHILOSOPHY.

important as the precursors of Stoicism. The closeness of the connexion is illustrated by Juvenal's epigram that a Cynic differed from a Stoic only by his cloak. Zeno was a pupil of Crates, from whom he learned the moral worth of self-control and indifference to sensual indulgence (see STOICIS).

Finally it is necessary to point out two flaws in the Cynic philosophy. In the first place, the content of the word "knowledge" is never properly developed. "Virtue is knowledge"; knowledge of what? and how is that knowledge related to the will? These questions were never properly answered by them. Secondly they fell into the natural error of emphasizing the purely animal side of the "nature," which was their ethical criterion. Avoiding the artificial restraints of civilization, they were prone to fall back into animalism pure and simple. Many of them upheld the principle of community of wives (see Diogenes Laërtius vi. 11); some of them are said to have outraged the dictates of public decency. It was left to the Stoics to separate the wheat from the chaff, and to assign to the words "knowledge" and "nature" a saner and more comprehensive meaning.

For relation of Cynicism to contemporary thought, compare CYRENAICS, MEGARIAN SCHOOL. See also ASCETICISM.

See F. W. Mullach, *Fragmenta philosophorum Graecorum* (Paris, 1867), ii. 261-438; H. Ritter and L. Preller, *Hist. phil. Graec. et Rom.* ch. v.; histories of ancient philosophy, and specially Ed. Zeller, *Socrates and the Socratic Schools*, Eng. trans., O. J. Reichel (1868, 2nd ed. 1877); Th. Gomperz, *Greek Thinkers*, Eng. trans., vol. ii., G. G. Berry (1905); E. Caird, *Evolution of Theology in the Greek Philosophers* (1904), ii. 44 seq., 55 seq., 62 seq.; arts. STOICIS and SOCRATES.

**CYNOSURE** (Lat. *cynosura*, Gr. *κυνόσουρα*, from *κυνός*, genitive of *κύων*, a dog, and *οὐρά*, tail), the name given by the Greeks and Romans to the constellation of the Little Bear, *Ursa Minor*; the word is applied in English to the pole-star which appears in that constellation, and hence to something bright which, like a "guiding-star," draws all attention to it, as in Milton's "cynosure of neighbouring eyes."

**CYPERACEAE**, in botany, a natural order of the monocotyledonous group of seed-bearing plants. They are grass-like herbs, sometimes annual, but more often persist by means of an underground stem from which spring erect solitary or clustered, generally three-sided aerial stems, with leaves in three rows. The minute flowers are arranged in spikelets somewhat as in grasses, and these again in larger spike-like or paniced inflorescences. The flower has in rare cases a perianth of six scale-like leaves arranged in two whorls, and thus conforming to the common monocotyledonous type of flower. Generally the perianth is represented by hairs, bristles or similar developments, often indefinite in number; in the two largest genera, *Cyperus*, (fig. 1) and *Carex* (fig. 2), the flowers are naked. In a few cases two whorls of stamens are present, with three members in each, but generally only three are present; the pistil consists of three or two carpels, united to form an ovary bearing a corresponding number of styles and containing one ovule. The flowers, which are often unisexual, are wind-pollinated. The fruit is one-seeded, with a tough, leathery or hard wall. There are nearly 70 genera containing about 3000 species and widely distributed throughout the earth, chiefly as marsh-plants. In the arctic zone they form 10% of the flora; they will flourish in soils rich in humus which are too acid to support grasses. The large genus *Cyperus* contains about 400 species, chiefly in the warmer parts of the earth; *C. Papyrus* is the Egyptian Papyrus. *Carex*,



FIG. 1.—Partial inflorescence of *Cyperus longus* (Galingale), slightly reduced. 1, Spikelet of same; 2, flower.

the largest genus of the order, the sedges, is widely distributed in the temperate, alpine and arctic regions of both hemispheres, and is represented by 60 species in Britain. *Carex arenaria*, the sea-bent, grows on sand-dunes and helps to bind the sand

testator cannot be carried into effect, the court will apply the funds to some other purpose, as near the original as possible (whence the name). For instance, a testator having left a fund to be divided into four parts—one-fourth to be used for "the redemption of British slaves in Turkey and Barbary," and the other three-fourths for various local charities—it was found that there were no British slaves in Turkey or Barbary, and as to that part of the gift therefore the testator's purpose failed. Instead of allowing the portion of the fund devoted to this impossible purpose to lapse to the next of kin, the court devoted it to the purposes specified for the rest of the estate. This doctrine is only applied where "a general intention of charity is manifest" in the will, and not where one particular object only was present to the mind of the testator. Thus, a testator having left money to be applied in building a church in a particular parish, and that having been found to be impossible, the fund will not be applied *cy-près*, but will go to the next of kin.

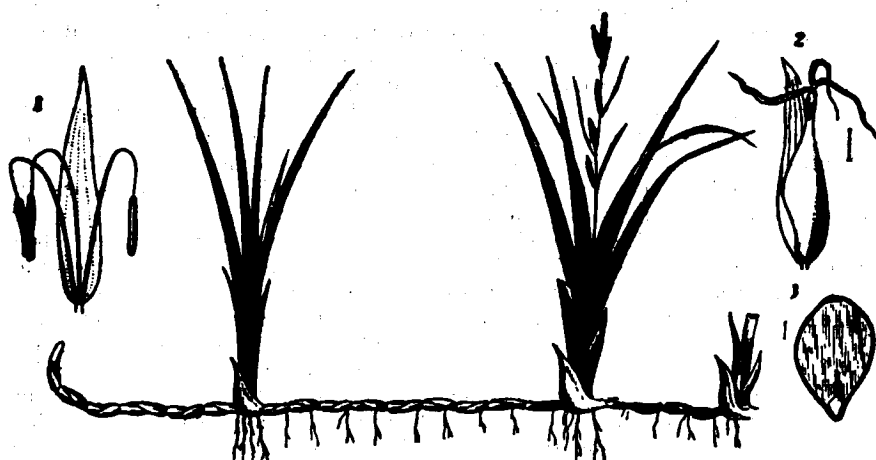

FIG. 2.—*Carex riparia*, the largest British sedge, from 3 to 5 ft. high. 1, Male flower of *Carex*; 2, female flower of *Carex*; 3, seed of *Carex*, cut lengthwise.

with its long cord-like underground stem which branches widely. *Scirpus lacustris* (fig. 3, 1) the true bulrush, occurs in lakes, ditches and marshes; it has a spongy, green, cylindrical stem, reaching nearly an inch in thickness and 1 to 8 ft. high, which is usually leafless with a terminal branched inflorescence. *Eriophorum* (fig. 3), cotton grass,

of the country has progressed, and are regarded with increasing favour by the courts. The *cy-près* doctrine has been either expressly or virtually applied to uphold them in several of the states, and in some there has been legislation in the same direction. In others the doctrine has been repudiated, e.g. in Michigan, Tennessee, Indiana and Virginia. For many years the New York courts held that this doctrine was not in force there, but in 1893 the legislature repealed the provisions of the revised statutes on which these decisions rested and restored the ancient law. Statutes passed in Pennsylvania have established the doctrine there, and dissolved any doubt as to its being in force in that state.

**CYPRESS** (*Cupressus*), in botany, a genus of fifteen species belonging to the tribe Cupressineae, natural order Coniferae, represented by evergreen aromatic trees and shrubs indigenous to the south of Europe, western Asia, the Himalayas, China, Japan, north-western and north-eastern America, California and Mexico. The leaves of the cypresses are scale-like, overlapping and generally in four rows; the female catkins are roundish, and fewer than the male; the cones consist of from six to ten peltate woody scales, which end in a curved point, and open when the seeds are ripe; the seeds are numerous and winged. All the species exude resin, but no turpentine.

*C. sempervirens*, the common cypress, has been well known throughout the Mediterranean region since classic times; it may have been introduced from western Asia where it is found wild. It is a tapering, flame-shaped tree resembling the Lombardy poplar; its branches are thickly covered with small, imbricated, shining-green leaves; the male catkins are about 3 lines in length; the cones are between 1 and 1½ in. in diameter, sessile, and generally in pairs, and are made up of large angular scales, slightly convex exteriorly, and with a sharp point in the centre. In Britain the tree grows to a height of 40 ft., in its native soil to 70 or 90 ft. It thrives best on a dry, deep, sandy loam, on airy sheltered sites at no great elevation above the sea. It was introduced into Great Britain before the middle of the 16th century. In the climate of the south of England its rate of growth when young is between 1 and 1½ ft. a year. The seeds are sown in April, and come up in three or four weeks; the plants require protection from frost during their first winter.

The timber of the cypress is hard, close-grained, of a fine reddish hue, and very durable. Among the ancients it was in request for poles, rafters, joists, and for the construction of wine-presses, tables and musical instruments; and on that account was so valuable that a plantation of cypresses was considered a sufficient dowry for a daughter. Owing to its durability the wood was employed for mummy cases, and images of the gods;

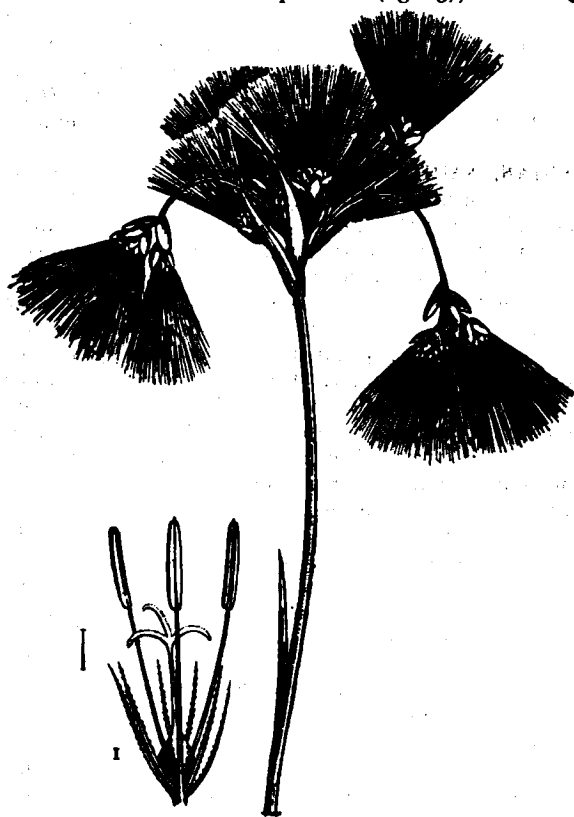

FIG. 3.—Inflorescence of Cotton-grass (*Eriophorum polystachion*), about ¾ nat. size. 1, Flower of true bulrush (*Scirpus lacustris*).

is represented in Britain by several species in boggy land; they are small tufted herbs with cottony heads due to the numerous hair-like bristles which take the place of the perianth and become much elongated in the fruiting stage.

**CY-PRÈS** (A.-Fr. for "so near"), in English law, a principle adopted by the court of chancery in dealing with trusts for charitable purposes. When the charitable purpose intended by a

a statue of Jupiter carved out of cypress is stated by Pliny to have existed 600 years without showing signs of decay. The cypress doors of the ancient St Peter's at Rome, when removed by Eugenius IV., were about 1100 years old, but nevertheless in a state of perfect preservation. Laws were engraved on cypress by the ancients, and objects of value were preserved in receptacles made of it; thus Horace speaks of poems *levi servanda cupresso*.

The cypress, which grows no more when once cut down, was regarded as a symbol of the dead, and perhaps for that reason was sacred to Pluto; its branches were placed by the Greeks and Romans on the funeral pyres and in the houses of their departed friends. Its supposed ill-boding nature is alluded to in Shakespeare's *Henry VI.*, where Suffolk desires for his enemies "their sweetest shade, a grove of cypress trees." The cypress was the tree into which Cyparissus, a beautiful youth beloved by Apollo, was transformed, that he might grieve to all time (Ovid, *Mét.* x. 3). In Turkish cemeteries the cypress—

"Dark tree, still sad when others' grief is fled,  
The only constant mourner o'er the dead"—

is the most striking feature, the rule being to plant one for each interment. The tree grows straight, or nearly so, and has a gloomy and forbidding, but wonderfully stately aspect. With advancing age its foliage becomes of a dark, almost black hue. William Gilpin calls the cypress an architectural tree: "No Italian scene," says he, "is perfect without its tall spiral form, appearing as if it were but a part of the picturesquely disposed edifices which rise from the middle ground against the distant landscape." The cypress of Somma, in Lombardy, is believed to have been in existence in the time of Julius Caesar; it is about 121 ft. in height, and 23 ft. in circumference. Napoleon, in making the road over the Simplon, deviated from the straight line in order to leave it standing. The cypress, as the olive, is found everywhere in the dry hollows and high eastern slopes of Corfu, of the scenery of which it is characteristic. As an ornamental tree in Britain the cypress is useful to break the outline formed by round-headed low shrubs and trees. The *berosh*, or *beroth*, of the Hebrew Scriptures, translated "fir" in the authorized version, in 1 Kings v. 8 and vi. 15, 2 Chron. ii. 8 and many other passages, is supposed to signify the cypress.

The common or tall variety of *C. sempervirens* is known as *C. fastigiata*; the other variety, *C. horizontalis*, which is little planted in England, is distinguished by its horizontally spreading branches, and its likeness to the cedar. The species *C. torulosa* of North India, so called from its twisted bark, attains an altitude of 150 ft.; its branches are erect or ascending, and grow so as to form a perfect cone. In the Kulu and Ladakh country the tree is sacred to the deities of the elements. It has been introduced into England, but does not thrive where the winter is severe. The wood, which in Indian temples is burnt as incense, is yellowish-red, close-grained, tough, hard, readily worked, durable, and equal in quality to that of the deodar. Another species, *C. lusitanica* or *glauca*, the "cedar of Goa," is a handsome tree, 50 ft. in height when full-grown, with spreading branches drooping at their extremities; it has been much planted in Portugal, especially in the neighbourhood of Cintra. Its origin is doubtful. It was well established in Portugal before the middle of the 17th century, and has since been cultivated generally in the south of Europe, but is nowhere believed to be indigenous. The name "cedar of Goa" is misleading, as no cypress is found wild anywhere near Goa. It was cultivated in England in the 17th century, and the name *C. lusitanica* was given by Philip Miller, the curator of the Chelsea Physick garden, in 1768, in reference to its supposed Portuguese origin. Experience has shown this cypress to be too tender for British climate generally, though good specimens are to be found in the milder climate of the south and west of England and in Ireland.

The species *G. Lawsoniana*, the Port Orford cedar, a native of south Oregon and north California, where it attains a height of 100 ft., was introduced into Scotland in 1854; it is much grown for ornamental purposes in Britain, a large number of varieties of garden origin being distinguished by differences in habit and by colour of foliage. Other Californian cypresses

are *C. macrocarpa*, the Monterey cypress, which is 60 ft. high when mature, with a habit suggesting that of cedar of Lebanon, and *C. Joveniana* and *C. Macnabiana*, smaller trees generally from 20 to 30 ft. in height. *C. funebris* is a native of the north of China, where it is planted near pagodas. *C. nootkaensis*, the Nootka Sound cypress or Alaska cedar, was introduced into Britain in 1850. It is a hardy species, reaching a height of from 80 to 100 ft. Several varieties are distinguished by habit and colour of foliage. *C. obtusa*, a native of Japan, is a tall tree reaching 100 ft. in height, and widely planted by the Japanese for its timber, which is one of the best for interior construction. It is also cultivated by them as a decorative plant, in many forms, including dwarf forms not exceeding a foot in height.

The "deciduous cypress," "swamp cypress" or "bald cypress," *Taxodium distichum*, is another member of the order Coniferae (tribe Taxodineae), a native of the southern United States and Mexico. It is a lofty tree reaching a height of 170 ft. or more, with a massive trunk 10 to 15 ft. or more in diameter, growing in or near water or on low-lying land which is subject to periodical flooding. The lower part of the trunk bears huge buttresses, each of which ends in a long branching far-spreading root, from the branches of which spring the peculiar knees which rise above the level of the water. The knees are of a soft spongy texture and act as breathing organs, supplying the roots with air, which they would otherwise be unable to obtain when submerged. The stout horizontally spreading branches give a cedar-like appearance; the foliage is light and feathery; the leaves and the slender shoots which bear them fall in the autumn. The cones, about the size of a small walnut, bear spirally arranged imbricated scales which subtend the three-angled winged seeds. The wood is light, soft, straight-grained and easily worked; it is very durable in contact with the soil, and is used for railway-ties, posts, fencing and for construction. The deciduous cypress was one of the first American trees introduced into England; it is described by John Parkinson in his *Herbal* of 1640. It thrives only near water or where the soil is permanently moist.

**CYPRIAN, SAINT** [*Caecilius Cyprianus*, called THASCUS] (c. 200–258), bishop of Carthage, one of the most illustrious in the early history of the church, and one of the most notable of its early martyrs, was born about the year 200, probably at Carthage. He was of patrician family, wealthy, highly educated, and for some time occupied as a teacher of rhetoric at Carthage. Of an enthusiastic temperament, accomplished in classical literature, he seems while a pagan to have courted discussion with the converts to Christianity. Confident in his own powers, he entered ardently into what was no doubt the great question of the time at Carthage as elsewhere. He sought to vanquish, but was himself vanquished by, the new religious force which was making such rapid inroads on the decaying paganism of the Roman empire. Caecilianus (or Caecilius), a presbyter of Carthage, is supposed to have been the instrument of his conversion, which seems to have taken place about 246.

Cyprian carried all his natural enthusiasm and brilliant powers into his new profession. He devoted his wealth to the relief of the poor and other pious uses; and so, according to his deacon Pontius, who wrote a diffuse and vague account of his "life and passion," "realized two benefits: the contempt of the world's ambition, and the observance of that mercy which God has preferred to sacrifice." The result of his charity and activity as a Christian convert was his unanimous call by the Christian people to the head of the church in Carthage, at the end of 248 or beginning of 249. The time was one of fierce persecution directed against the Christians, and the bishop of Carthage became a prominent object of attack. During the persecution of Decius (250–251) Cyprian was exposed to imminent danger, and was compelled for a time to seek safety in retreat. Under Gallus, the successor of Decius, the persecution was relaxed, and Cyprian returned to Carthage. Here he held several councils for the discussion of the affairs of the church, especially for grave questions as to the rebaptism of heretics, and the re-admission into the church of the *lapsi*, or those who had fallen

away through fear during the heat of the persecution. Cyprian, although inspired by lofty notions of the prerogatives of the church, and inclined to severity of opinion towards heretics, and especially heretical dissentients from the belief in the divine authorship of the episcopal order and the unity of Christendom, was leniently disposed towards those who had temporarily fallen from the faith. He set himself in opposition to Novatian, a presbyter of Rome, who advocated their permanent exclusion from the church; and it was his influence which guided the tolerant measures of the Carthaginian synods on the subject. While in this question he went hand in hand with Cornelius, bishop of Rome, his strict attitude in the matter of baptism by heretics brought him into serious conflict with the Roman bishop Stephen. It would almost have come to a rupture, since both parties held firmly to their standpoint, had not a new persecution arisen under the emperor Valerian, which threw all internal quarrels into the background in face of the common danger. Stephen became a martyr in August 257. Cyprian was at first banished to Curubis in Africa Proconsularis. But soon he was recalled, taken into custody, and finally condemned to death. He was beheaded on the 14th of September 258, the first African bishop to obtain the martyr's crown.

All Cyprian's literary works were written in connexion with his episcopal office; almost all his treatises and many of his letters have the character of pastoral epistles, and their form occasionally betrays the fact that they were intended as addresses. These writings bear the mark of a clear mind and a moderate and gentle spirit. Cyprian had none of that character which makes the reading of Tertullian, whom he himself called his *magister*, so interesting and piquant, but he possessed other qualities which Tertullian lacked, especially the art of presenting his thoughts in simple, smooth and clear language, yet in a style which is not wanting in warmth and persuasive power. Like Tertullian, and often in imitation of him, Cyprian took certain apologetic, dogmatic and pastoral themes as subjects of his treatises. By far the best known of these is the treatise *De catholicae ecclesiae unitate*, called forth in A.D. 251 by the schism at Carthage, but particularly by the Novatian schism at Rome. In this is proclaimed the doctrine of the one church founded upon the apostle Peter, whose "tangible bond is her one united episcopate, an apostleship universal yet only one—the authority of every bishop perfect in itself and independent, yet not forming with all the others a mere agglomeration of powers, but being a tenure upon a totality like that of a shareholder in some joint property."

Attention must also be called to the treatise *Ad Donatum* (*De gratia dei*), in which the new life after regeneration with its moral effects is set forth in a pure and clear light, as contrasted with the night of heathendom and its moral degradation, which were known to the author from personal experience. The numerous *Letters* of Cyprian are not only an important source for the history of church life and of ecclesiastical law, on account of their rich and manifold contents, but in large part they are important monuments of the literary activity of their author, since, not infrequently, they are in the form of treatises upon the topic in question. Of the eighty-two letters in the present collection, sixty-six were written by Cyprian. In the great majority of cases the chronology of their composition, as far as the year is concerned, presents no difficulties; more precise assignments are mainly conjectural. In the editions of the works of Cyprian a number of treatises are printed which, certainly or probably, were not written by him, and have therefore usually been described as pseudo-Cyprianic. Several of them, e.g. the treatise on dice (*De aleatoribus*), have attracted the attention of scholars, who are never weary of the attempt to determine the identity of the author, unfortunately hitherto without much success.

The best, though by no means faultless, edition of Cyprian's works is that of W. von Hartel in the *Corpus scriptorum ecclesiasticorum* (3 vols., Vienna, 1868-1871). There is an English translation in the *Library of the Ante-Nicene Fathers*. The most complete monograph is that by Archbishop E. W. Benson, *Cyprian, his Life, his Times, his Work* (London, 1897). See also J. A. Faulkner, *Cyprian the Churchman* (Cincinnati and New York, 1906).

**CYPRINODONTS.** In spite of their name, the small fishes called Cyprinodonts are in no way related to the Cyprinids, or carp family, but are near allies of the pike, characterized by a flat head with protractile mouth beset with cardiform, villiform, or compressed, bi- or tri-cuspid teeth, generally large scales, and the absence of a well-developed lateral line. About two hundred species are known, mostly inhabitants of the fresh and brackish waters of America; only about thirty are known from the old world (south Europe, south Asia, China and Japan, and Africa). Several forms occur in the Oligocene and Miocene beds of Europe. Many species are ovo-viviparous, and from their small size and lively behaviour they are much appreciated as aquarium fishes.

In many species the sexes are dissimilar, the female being larger and less brilliantly coloured, with smaller fins; the anal fin of the male may be modified into an intromittent organ by means of which internal fertilization takes place, the ova developing in a sort of uterus. In the remarkable genus *Anableps*, from Central and South America, the strongly projecting eyes are divided by a horizontal band of the conjunctiva into an upper part adapted for vision in the air, and a lower for vision in the water, and the pupil is also divided into two parts by a constriction.

The latest monograph of these fishes is by S. Garman in *Mem. Mus. Comp. Zool.* xix. (1895).

The *Amblyopsidae*, which include the remarkable blind cave fishes of North America (Mammoth cave and others), are nearly related to the *Cyprinodontidae*, and like many of them ovo-viviparous. *Chologaster*, from the lowland streams and swamps of the south Atlantic states, has the eyes well developed and the body is coloured. *Amblyopsis* and *Typhlichthys*, which are evidently derived from *Chologaster*, or from forms closely related to it, but living in complete darkness, have the eyes rudimentary and more or less concealed under the skin, and the body is colourless.

See F. W. Putnam, *Amer. Nat.* (1872), p. 6, and *P. Boston Soc.* xvii. (1875), p. 222; and C. H. Eigenmann, *Archiv. für Entwicklungsmechanik der Organismen*, viii. (1899), p. 545. (G. A. B.)

**CYPRUS**, one of the largest islands in the Mediterranean, nominally in the dominion of Turkey, but under British administration, situated in the easternmost basin of that sea, at roughly equal distance from the coasts of Asia Minor to the north and of Syria to the east. The headland of Cape Kormakiti in Cyprus is distant 44 m. from Cape Anamur in Asia Minor, and its north-east point, Cape St Andrea, is 69 m. from Latakieh in Syria. It lies between 34° 33' and 35° 41' N., and between 32° 20' and 34° 35' E., so that it is situated in almost exactly the same latitude as Crete. Its greatest length is about 141 m., from Cape Drepano in the west to Cape St Andrea in the north-east, and its greatest breadth, from Cape Gata in the south to Cape Kormakiti in the north, reaches 60 m.; while it retains an average width of from 35 to 50 m. through the greater part of its extent, but narrows suddenly to less than 10 m. about 34° E., and from thence sends out a long narrow tongue of land towards the E.N.E. for a distance of 46 m., terminating in Cape St Andrea. The coast-line measures 486 m. Cyprus is the largest island in the Mediterranean after Sicily and Sardinia. In 1885 a trigonometrical survey and a map on the scale of 1 in. to 1 m. were made by Captain (afterwards Lord) Kitchener, R.E., who worked out the area of the island at 3584 sq. m., or a little more than the area of Norfolk and Suffolk.

**Mountains.**—Great part of the island is occupied by two mountain ranges, both of which have a general direction from west to east. Of these the most extensive, as well as the most lofty, is that which fills up almost the whole southern portion of the island, and is generally designated by modern geographers as Mount Olympus, though that name appears to have been applied by the ancients only to one particular peak. The highest summit is known at the present day as Mount Troödos, and attains an elevation of 6406 ft. It sends down subordinate ranges or spurs, of considerable altitude, on all sides, one of which extends to Cape Arnauti (the ancient Acamas), which forms the



north-west extremity of the island, while others descend on both sides quite to the northern and southern coasts. On the south-eastern slope are governmental and military summer quarters. The main range is continued eastward by the lofty summits known as Mount Adelphi (5305 ft.), Papoutsia (5124) and Machaira

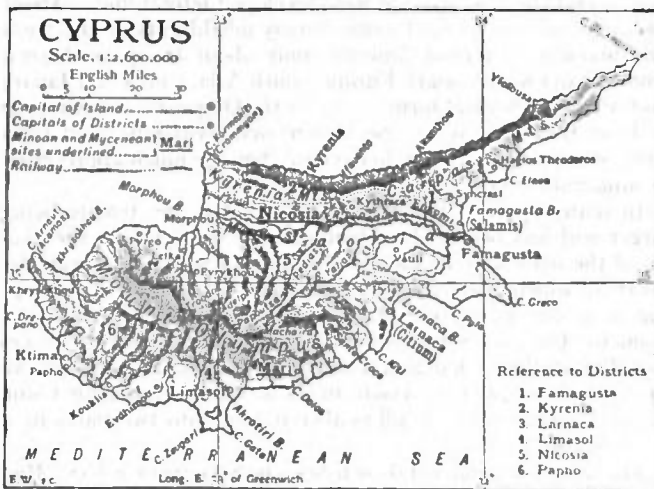

or Chionia (4674), until it ends in the somewhat isolated peak called Santa Croce (Stavrovouni or Oros Stavro), the Hill of the Holy Cross (2260 ft.). This mountain, designated by Strabo Mount Olympus, is a conspicuous object from Larnaca, from which it is only 12 m. distant, and is well known from being frequented as a place of pilgrimage. The northern range of mountains begins at Cape Kormakiti (the ancient Crommyon) and is continued from thence in an unbroken ridge to the eastern extremity of the island, Cape St Andrea, a distance of more than 100 m. It is not known by any collective name; its western part is called the Kyrenia mountains, while the remainder has the name of Carpas. It is inferior in elevation to the southern range, its highest summit (Buffavento) attaining only 3135 ft., while in the eastern portion the elevation rarely exceeds 2000 ft. But it is remarkable for its continuous and unbroken character—consisting throughout of a narrow but rugged and rocky ridge, descending abruptly to the south into the great plain of Lefkosia, and to the north to a narrow plain bordering the coast.

**The Mesaoria.**—Between the two mountain ranges lies a broad plain, extending across the island from the bay of Famagusta to that of Morphou on the west, a distance of nearly 60 m., with a breadth varying from 10 to 20 m. It is known by the name of the Mesaoria or Messaria, and is watered by a number of intermittent streams from the mountains on either hand. The chief streams are the Pediais and the Yalias, which follow roughly parallel courses eastward. The greater part of the plain is open and uncultivated, and presents nothing but barren downs; but corn is grown in considerable quantities in the northern portions of it, and there is no doubt that the whole is readily susceptible of cultivation. It is remarkable that Cyprus was celebrated in antiquity for its forests, which not only clothed the whole of its mountain ranges, but covered the entire central plain with a dense mass, so that it was with difficulty that the land could be cleared for cultivation. At the present day the whole plain of the Mesaoria is naturally bare and treeless, and it is only the loftiest and central summits of Mount Olympus that still retain their covering of pine woods. The disappearance of the forests (which has in a measure been artificially remedied) naturally affected the rivers, which are mostly mere torrents, dry in summer. Even the Pediais (ancient *Pediaeus*) does not reach the sea in summer, and its stagnant waters form unhealthy marshes. In the marshy localities malarial fever occurs but is rarely (in modern times) of a severe type. The mean annual temperature in Cyprus is about 69° F. (mean maximum 78°, and minimum 57°). The mean annual rainfall is about 19 ins. October to March is the cool, wet season. Earthquakes are not uncommon.

**Geology.**—Cyprus lies in the continuation of the folded belt of the Anti-taurus. The northern coast range is formed by the oldest rocks in the island, consisting chiefly of limestones and marbles with occasional masses of igneous rock. These are supposed to be of Cretaceous age, but no fossils have been found in them. On both sides the range is flanked by sandstones and shales (the Kythraean series), supposed to be of Upper Eocene age; and similar rocks occur around the southern mountain mass. The Oligocene consists of grey and white marls (known as the Idalian series), which are distributed all over the island and attain their greatest development on the south side of the Troödos. All these rocks have been folded, and take part in the formation of the mountains. The great igneous masses of Troödos, &c., consisting of diabase, basalt and serpentine, are of later date. Pliocene and later beds cover the central plain and occur at intervals along the coast. The Pliocene is of marine origin, and rests unconformably upon all the older beds, including the Post-oligocene igneous rocks, thus proving that the final folding and the last volcanic outbursts were approximately of Miocene age. The caves of the Kyrenian range contain a Pleistocene mammalian fauna.

**Population.**—The population of Cyprus in 1901 was 237,022, an increase of 27,736 since 1891 and of 51,392 since 1881. The people are mainly Greeks and Turks. About 22% of the population are Moslems; nearly all the remainder are Christians of the Orthodox Greek Church. The Moslem religious courts, presided over by cadis, are strictly confined to jurisdiction in religious cases affecting the Mahomedan population. The island is divided into the six districts of Famagusta, Kyrenia, Larnaca, Limasol, Nicosia and Papho. The chief towns are Nicosia (pop. 14,752), the capital, in the north central part of the island, Limasol (8208) and Larnaca (7964) on the south-eastern coast. The other capitals of districts are Famagusta on the east coast, Kyrenia on the north, and Ktima, capital of Papho, on the south-west. Kyrenia, a small port, has a castle built about the beginning of the 13th century, and notable, through the troubled history of the island, as never having been captured.

**Agriculture, &c.**—The most important species of the few trees that remain in the island are the Aleppo pine, the *Pinus laricio*, cypress, cedar, carob, olive and *Quercus alnifolia*. Recent additions are the eucalyptus, casuarina, *Pinus pinea* and ailanthus. Some protection has been afforded to existing plantations, and some attempt made to extend their area; but the progress in both directions is slow. Agriculture is the chief industry in the island, in spite of various disabilities. The soil is extremely fertile, and, with a fair rainfall, say 13 in., between November and April, yields magnificent crops, but the improvements in agriculture are scarcely satisfactory. The methods and appliances used are extremely primitive, and inveterate prejudice debars the average peasant from the use of new implements, fresh seed, or manure; he generally cares nothing for the rotation of crops, or for the cleanliness of his land. Modern improvements and the use of imported machinery have, however, been adopted by some. A director of agriculture was appointed in 1896, and leaflets are issued pointing out improvements within the means of the villager, and how to deal with plant diseases and insect pests. The products of the soil include grain, fruit, including carob, olive, mulberry, cotton, vegetables and oil seeds. Vineyards occupy a considerable area, and the native wines are pure and strong, but not always palatable. The native practice of conveying wine in tarred skins was deleterious to its flavour, and is now for the most part abolished. A company has exploited and improved the industry. Large sums have been expended on the destruction of locusts; they are now practically harmless, but live locusts are diligently collected every year, a reward being paid by the government for their destruction. Under the superintendence of an officer lent by the government of Madras, two great works of irrigation, from the lack of which agriculture had seriously suffered, were undertaken in 1898 and 1899. The smaller includes a reservoir at Syncrasi (Famagusta), with a catchment of 27 sq. m. and a capacity of 70,000,000 cub. ft. It reclaims 360 acres, and was estimated to irrigate 4320. The larger scheme includes three large reservoirs in the Mesaoria to hold up and temporarily store the flood waters of the Pediais and Yalias rivers. The estimate premised a cost of £50,000, the

irrigation of 42,000 acres, and the reclamation of 10,000. These works were completed respectively in 1899 and 1901.

The rearing of live stock is of no little importance. A committee exists "for the improvement of the breeds of Cyprus stock"; stallions of Arab blood have been imported, and prizes are offered for the best donkeys. Cattle, sheep, mules and donkeys are sent in large numbers to Egypt. Cyprus mules have found favour in war in the Crimea, India, Uganda, Eritrea and Egypt. The sea fisheries are not important, with the exception of the sponge fishery, which is under the protection of the administration. The manufactures of the island are insignificant.

**Minerals.**—Next to its forests, which long supplied the Greek monarchs of Egypt with timber for their fleets, Cyprus was celebrated among the ancients for its mineral wealth, especially for its mines of copper, which were worked from a very early period, and continued to enjoy such reputation among both Greeks and Romans that the modern name for the metal is derived from the term of Aes Cyprium or Cuprium by which it was known to the latter. According to Strabo the most valuable mines were worked at a place called Tamasus, in the centre of the island, on the northern slopes of Mount Olympus, but their exact site has not been identified. An attempt to work copper towards the close of the 19th century was a failure, but some prospecting was subsequently carried on. Besides copper, according to Strabo, the island produced considerable quantities of silver; and Pliny records it as producing various kinds of precious stones, among which he mentions diamonds and emeralds, but these were doubtless nothing more than rock crystal and beryl. Salt, which was in ancient times one of the productions for which the island was noted, is still made in large quantities, and there are extensive salt works in the neighbourhood of Larnaca and Limasol, where there are practically inexhaustible salt lakes. Rock crystal and asbestos are still found in the district of Paphos. Gypsum is exported unburnt from the Carpas, and as plaster of Paris from Limasol and Larnaca. Statuary marble has been found on the slopes of Buffavento in the northern range. Excellent building stone exists throughout the island.

**Commerce.**—A disability against the trade of Cyprus has been the want of natural harbours, the ports possessing only open roadsteads; though early in the 20th century the construction of a satisfactory commercial harbour was undertaken at Famagusta, and there is a small harbour at Kyrenia. Trade is carried on principally from the ports already indicated among the chief towns. The various agricultural products, cattle and mules, cheese, wines and spirits, silk cocoons and gypsum make up the bulk of the exports. Barley and wheat, carobs and raisins may be specially indicated among the agricultural exports. The annual value of exports and of imports (which are of a general character) may be set down as about £300,000 each. Good roads are maintained connecting the more important towns, and when the harbour at Famagusta was undertaken the construction of a railway from that port to Nicosia was also put in hand. The Eastern Telegraph Co. maintains a cable from Alexandria (Egypt) to Larnaca, and the greater part of the lines on the island. The Imperial Ottoman Telegraph Co. has also some lines. The British sovereign is the current gold coin, the unit of the bronze and silver coinage being the *piastre* (1½ penny). Turkish weights and measures are used. The *oke*, equalling 2·8 lb avoirdupois, and the *donum*, about ¼ of an acre, are the chief units.

**Constitution and Government.**—Under a convention signed at Constantinople on the 4th of June 1878, Great Britain engaged to join the sultan of Turkey in defending his Asiatic possessions (in certain contingencies) against Russia, and the sultan, "in order to enable England to make necessary provision for executing her engagement," consented to assign the island of Cyprus to be occupied and administered by England. The British flag was hoisted on the 12th of June, and the conditions of the occupation were explained in an annex to the convention, dated the 1st of July. An order in council of the 14th of September,

modified so far as related to legislation by another of the 30th of November, regulated the government of the island. The administration was placed in the hands of a high commissioner with the usual powers of a colonial governor. Executive and legislative councils were established; and in each of the six districts into which, for administrative and legal purposes, the island was divided, a commissioner was appointed to represent the government. The executive council consists of the high commissioner, the chief secretary, the king's advocate, the senior officer in charge of the troops, and the receiver-general, with, as "additional" members, two Christians and one Mussulman. The legislative council consists of six non-elected members, being office-holders, and twelve elected members, three being chosen by the Moslems and nine by the non-Moslem inhabitants. British subjects and foreigners, who have resided five years in Cyprus, can exercise the franchise as well as Ottoman subjects. The qualification otherwise is the payment of any of the taxes classed as Vergi Taxes (see below). The courts in existence at the time of the occupation were superseded by the following, constituted by an order in council dated the 30th of November 1882:—(1) a supreme court of criminal and civil appeal; (2) six assize courts; (3) six district courts; (4) six magistrates' courts; and (5) village courts. Actions are divided, according to the nationality of the defendant, into "Ottoman" and "Foreign"; in the latter, the president of the court alone exercises jurisdiction as a rule, so also in criminal cases against foreigners. The law administered is that contained in the Ottoman codes, modified by ordinances passed by the legislative council.

**Finance.**—The principal sources of revenue are:—

(1) Vergi taxes, or taxes on house and land property, and trade profits and incomes (not including salaries); (2) military exemption tax, payable by Moslems and Christians alike, but not by foreigners, of 2s. 6d. a head on males between 18 and 60 years of age; (3) tithes. All tithes have been abolished, except those on cereals, carobs, silk cocoons, and, in the form of 10% *ad valorem* export duties, those on cotton, linseed, aniseed and raisins (all other export duties and a fishing tax have been abolished); (4) sheep, goat, and pig tax; (5) an excise on wine, spirits and tobacco; (6) import duties; (7) stamps, court fees, royalties, licenses, &c.; (8) salt monopoly. Foreigners are liable to all the above taxes except the military exemption tax. The annual sum of £92,800, payable to Turkey as the average excess (according to the years 1873-1878) of revenue over expenditure, but really appropriated to the interest on the British guaranteed loan of 1855, is a heavy burden. But if not lightened, taxation is at least better apportioned than formerly.

**Instruction.**—A general system of grants in aid of elementary schools was established in 1882. There are some 300 connected with the Greek Orthodox Church, and 160 elementary Moslem schools. Aid is also given to a few Armenian and Maronite schools. Among other schools are a Moslem high school (maintained entirely by government), a training college at Nicosia for teachers in the Orthodox Church schools, Greek high schools at Larnaca and Limasol, an English school for boys and a girls' school at Nicosia. By a law of 1895 separate boards of education for Moslem and Greek Christian schools were established, and in each district there are separate committees, presided over by the commissioner. An institution worthy of special notice is the home and farm for lepers near Nicosia, accommodating over a hundred inmates.

#### HISTORY AND ARCHAEOLOGY DOWN TO THE ROMAN OCCUPATION

The Stone Age has left but few traces in Cyprus; no sites have been found and even single implements are very rare. The "megalithic" monuments of Agia Phaneromeni<sup>1</sup> and Halá Sultán Teké near Larnaca may perhaps be early, like the Palestinian cromlechs; but the vaulted chamber of Agia Katrína near Enkomi seems to be Mycenaean or later; and the perforated monoliths at Ktima seem to belong to oil presses of uncertain but probably not prehistoric date.

The Bronze Age, on the other hand, is of peculiar importance in an area which, like Cyprus, was one of the chief early sources of copper. Its remains have been carefully studied both on

<sup>1</sup> M. Ohnefalsch-Richter, *Arch. Zeitung* (1881), p. 311, pl. xviii. The principal publications respecting this and all sites and phases of culture mentioned in this section are collected in Myres and Ohnefalsch-Richter, *Cyprus Museum Catalogue* (Oxford, 1899), pp. 1-35.

settlement sites at Leondári Vounò and Kalopsída, and in tombs in more than thirty places, notably at Agia Paraskeví, Psematisméno, Alámbrá, Episkopí and Enkomi. Throughout this period, which began probably before 3000 B.C. and ended about 1000 B.C., Cyprus evidently maintained a large population, and an art and culture distinct from those of Egypt, Syria and Cilicia. The Cypriote temper, however, lacks originality; at all periods it has accepted foreign innovations slowly, and discarded them even more reluctantly. The island owes its importance, therefore, mainly to its copious supply of a few raw materials, notably copper and timber. Objects of Cypriote manufacture are found but rarely on sites abroad; in the later Bronze Age, however, they occur in Egypt and South Palestine, and as far afield as Thera (Santorin), Athens and Troy (Hissarlik).

The Bronze Age culture of Cyprus falls into three main stages. In the first, the implements are rather of copper than of bronze, tin being absent or in small quantities (2 to 3%); the types are common to Syria and Asia Minor as far as the Hellespont, and resemble also the earliest forms in the Aegean and in central Europe; the pottery is all hand-made, with a red burnished surface, gourd-like and often fantastic forms, and simple geometrical patterns incised; zoomorphic art is very rare, and imported objects are unknown. In the second stage, implements of true bronze (9 to 10% tin) become common; painted pottery of buff clay with dull black geometrical patterns appears alongside the red-ware; and foreign imports occur, such as Egyptian blue-glazed beads (XIIth-XIIIth Dynasty, 2500-2000 B.C.),<sup>1</sup> and cylindrical Asiatic seals (one of Sargon I., 2000 B.C.).<sup>2</sup>

In the third stage, Aegean colonists introduced the Mycenaean (late Minoan) culture and industries; with new types of weapons, wheel-made pottery, and a naturalistic art which rapidly becomes conventional; gold and ivory are abundant, and glass and enamels are known. Extended intercourse with Syria, Palestine and Egypt brought other types of pottery, jewelry, &c. (especially scarabs of XVIIIth and XIXth Dynasties, 1600-1200 B.C.), which were freely copied on the spot. There is, however, nothing in this period which can be ascribed to specifically "Phoenician" influence; the only traces of writing are in a variety of the Aegean script. The magnificent tombs from Enkomi and Episkopí illustrate the wealth and advancement of Cyprus at this time.<sup>3</sup>

It is in this third stage that Cyprus first appears in history, under the name *Asi*, as a conquest of Tethmosis (Thothmes) III. of Egypt (XVIIIth Dynasty, c. 1500 B.C.),<sup>4</sup> yielding tribute of chariots, horses, copper, blue-stone and other products. It was still in Egyptian hands under Seti I., and under Rameses III. a list of Cypriote towns seems to include among others the names of Salamis, Citium, Soli, Idalium, Cerynia (Kyrenia), and Curium. Another Egyptian dependency, Alašía, has by some been identified with Cyprus or a part of it (but may perhaps be in North Syria). It sent copper, oil, horses and cattle, ivory and timber; under Amenophis (Amenhotep) III. it exported timber and imported silver; it included a town Šikra, traded with Byblus in North Syria, and was exposed to piratical raids of *Lykki* (? Lycians).

The decline of Egypt under the XXth Dynasty, and the contemporary fall of the Aegean sea-power, left Cyprus isolated and defenceless, and the Early Iron Age which succeeds is a period of obscurity and relapse. Iron, which occurs rarely, and almost exclusively for ornaments, in a few tombs at Enkomi, suddenly superseded bronze for tools and weapons, and its introduction was accompanied, as in the Aegean, by economic, and probably by political changes, which broke up the high civilization of the Mycenaean colonies, and reduced them to poverty,

isolation and comparative barbarism. It is significant that the first iron swords in Cyprus are of a type characteristic of the lands bordering the Adriatic. Gold and even silver become rare;<sup>5</sup> foreign imports almost cease; engraved cylinders and scarabs are replaced by conical and pyramidal seals like those of Asia Minor, and dress-pins by brooches (*fibulae*) like those of south-eastern Europe. Representative art languishes, except a few childish terra-cottas; decorative art becomes once more purely geometrical, but shows only slight affinity with the contemporary geometrical art of the Aegean.

Lingering thus in Cyprus (as also in some islands of the Aegean) Mycenaean traditions came into contact with new oriental influences from the Syrian coast; and these were felt in Cyprus somewhat earlier than in the West. But there is at present no clear proof of Phoenician or other Semitic activity in Cyprus until the last years of the 8th century.

No reference to Cyprus has been found in Babylonian or Assyrian records before the reign of Sargon II. (end of 8th century B.C.), and the occasional discovery of Mesopotamian cylinders of early date in Cyprus is no proof of direct intercourse.<sup>6</sup> Isaiah (xxiii. 1, 12), writing about this time, describes Kittim (a name derived from Citium, *q.v.*) as a port of call for merchantmen homeward bound for Tyre, and as a shelter for Tyrian refugees; but the Hebrew geographers of this and the next century classify *Kittim*, together with other coast-lands and islands, under the heading *Javan*, "Ionian" (*q.v.*), and consequently reckoned it as predominantly Greek.

Sargon's campaigns in north Syria, Cilicia and south-east Asia Minor (721-711) provoked first attacks, then an embassy and submission in 709, from seven kings of *Yatnana* (the Assyrian name for Cyprus); and an inscription of Sargon himself, found at Citium, proves an Assyrian protectorate, and records tribute of gold, silver and various timbers. These kings probably represent that "sea-power of Cyprus" which precedes that of Phoenicia in the Greek "List of Thalassocracies" preserved by Eusebius. Under Sennacherib's rule, *Yatnana* figures (as in Isaiah) as the refuge of a disloyal Sidonian in 702; but in 668 ten kings of Cypriote cities joined Assur-bani-pal's expedition to Egypt; most of them bear recognizable Greek names, e.g. Pylagoras of Chytroi, Eteandros of Paphos, Onasagoras of Ledroi. They are gazetted with twelve other "kings of the Hatti" (S.E. Asia Minor). Citium, the principal Phoenician state, does not appear by name; but is usually recognized in the list under its Phoenician title *Karši-ḥadasti*, "new town."

Thus before the middle of the 7th century Cyprus reappears in history divided among at least ten cities, of which some are certainly Greek, and one at least certainly Phoenician: with this, Greek tradition agrees.<sup>7</sup> The Greek colonists traced their descent, at Curium, from Argos; at Lapathus, from Laconia; at Paphos, from Arcadia; at Salamis, from the Attic island of that name; and at Soli, also from Attica. The settlements at Paphos and Salamis, and probably at Curium, were believed to date from the period of the Trojan War, *i.e.* from the 13th century, and the latter part of the Mycenaean age; the name of Teucer, the legendary founder of Salamis, probably is a reminiscence of the piratical Tikkara who harried the Egyptian coast under Rameses III. (c. 1200 B.C.), and the discovery of late Mycenaean settlements on these sites, and also at Lapathus, suggests that these legends rest upon history. The Greek dialect of Cyprus points in the same direction; it shows marked resemblances with that of Arcadia, and forms with it a "South Achaean" or "South Aeolic" group, related to the "Northern Aeolic" of Thessaly and other parts of north Greece.<sup>8</sup> Further

<sup>1</sup> Myres, *Journ. Hellenic Studies*, xvii. p. 146.

<sup>2</sup> Sayce, *Trans. Soc. Bibl. Arch.* v. pp. 441-444. The exact provenance of these cylinders is not known, but there is every reason to believe that they were found in Cyprus.

<sup>3</sup> British Museum, *Excavations in Cyprus* (London, 1900). The official publication stands alone in referring these tombs to the Hellenic period (800-600 B.C.).

<sup>4</sup> E. Oberhammer, *Die Insel Cypern* (Munich, 1903), i. pp. 1-3 (all the Egyptian evidence).

<sup>5</sup> A. J. Evans, *Journ. Anthropol. Inst.* xxx. p. 199 ff.; J. Naue, *Die vorrömischen Schwerter* (Munich, 1903), p. 25.

<sup>6</sup> E. Oberhammer, *l.c.* p. 5 ff. (all the Assyrian and biblical evidence).

<sup>7</sup> W. H. Engel, *Kypros* (Berlin, 1841) (all the Greek traditions).

<sup>8</sup> Moriz Schmidt, *Z. f. vergl. Sprachw.* (1860), p. 290 ff., 361 ff.; H. W. Smith, *Trans. Amer. Philol. Assoc.* xviii. (1887); R. Meister, *Zum eleischen, arkadischen u. kyprischen Dialekte* (Leipzig, 1890); O. Hoffmann, *Die griechischen Dialekte*, i. (Göttingen, 1891); C. D. Cobham, *Bibliography of Cyprus*, pp. 40-45.

evidence of continuity comes from the peculiar Cypriote script, a syllabary related to the linear scripts of Crete and the south Aegean, and traceable in Cyprus to the Mycenaean age.<sup>1</sup> It remained in regular use until the 4th century; before that time the Greek alphabet occurs in Cyprus only in a few inscriptions erected for visitors.<sup>2</sup> In Citium and Idalium, on the other hand, a Phoenician dialect and alphabet were in use from the time of Sargon onward.<sup>3</sup> Sargon's inscription at Citium is cuneiform.<sup>4</sup>

The culture and art of Cyprus in this Graeco-Phoenician period are well represented by remains from Citium, Idalium, Tamassus, Amathus and Curium; the earlier phases are best represented round Lapathus, Soli, Paphos and Citium; the later Hellenization, at Amathus and Marion-Arsinoë. Three distinct foreign influences may be distinguished: they originate in Egypt, in Assyria, and in the Aegean. The first two predominate earlier, and gradually recede before the last-named. Their effects are best seen in sculpture and in metal work, though it remains doubtful whether the best examples of the latter were made in Cyprus or on the mainland. Among a great series of engraved silver bowls,<sup>5</sup> found mostly in Cyprus, but also as far off as Nineveh, Olympia, Caere and Praeneste, some examples show almost unmixed imitation of Egyptian scenes and devices; in others, Assyrian types are introduced among the Egyptian in senseless confusion; in others, both traditions are merged in a mixed art, which betrays a return to naturalism and a new sense of style, like that of the Idaean bronzes in Crete.<sup>6</sup> From its intermediate position between the art of Phoenicia and its western colonies (so far as this is known) and the earliest Hellenic art in the Aegean, this style has been called Graeco-Phoenician. The same sequence of phases is represented in sculpture by the votive statues from the sanctuaries of Aphrodite at Dali and of Apollo at Vóni and Frángissa; and by examples from other sites in the Ceanola collection; in painting by a rare class of naively polychromic vases; and in both by the elaborately coloured terra-cotta figures from the "Toumba" site at Salamis. Gem-engraving and jewelry follow similar lines; pottery-painting for the most part remains geometrical throughout, with crude survivals of Mycenaean curvilinear forms. Those Aegean influences, however, which had been predominant in the later Bronze Age, and had never wholly ceased, revived, as Hellenism matured and spread, and slowly repelled the mixed Phoenician orientalism. Imported vases from the Aegean, of the "Dipylon," "proto-Corinthian" and "Rhodian" fabrics, occur rarely, and were imitated by the native potters; and early in the 6th century appears the specific influence of Ionia, and still more of Naucratis in the Egyptian delta. For the failure of Assyria in Egypt in 668-664, and the revival of Egypt as a phil-Hellene state under the XXVIth Dynasty, admitted strong Graeco-Egyptian influences in industry and art, and led about 560 B.C. to the political conquest of Cyprus by Amasis (Ahmosi) II.;<sup>7</sup> once again Cypriote timber maintained a foreign sea-power in the Levant.

The annexation of Egypt by Cambyses of Persia in 525 B.C.

<sup>1</sup> G. Smith, *Tr. Soc. Bibl. Arch.* i. 129 ff.; Moritz Schmidt, *Monatsb. k. Ak. Wiss.* (Berlin, 1874), pp. 614-615; *Sammlung kypr. Inschriften* (Jena, 1876); W. Deecke, *Ursprung der kypr. Sylbenschriften* (Strassburg, 1877); cf. Deecke-Collitz, *Samml. d. gr. Dialektinschriften*, i. (Göttingen, 1884); cf. C. D. Cobham, *l.c.* On its Aegean origin, A. J. Evans, "Cretan Pictographs" (1895), *Journ. Hell. Studies*, xiv., cf. xvii.; British Museum, *Exc. in Cypr.* (London, 1900), p. 27.

<sup>2</sup> British Museum, *Exc. in Cypr.* (London, 1900), p. 95 (Ionic inscriptions of 5th century from Amathus).

<sup>3</sup> M. de Vogüé, *Mélanges d'archéologie orientale* (Paris, 1869); J. Euting, *Sitzb. k. preuss. Ak. Wiss.* (1887), pp. 115 ff.; Ph. Berger, *C. R. Acad. Inscr.* (1887), pp. 155 ff., 187 ff., 203 ff. Cf. *Corpus Inscr. Semit.* (Paris, 1881), ii. 35 ff.

<sup>4</sup> E. Schrader, *Abh. d. k. preuss. Ak. Wiss.* (1881).

<sup>5</sup> G. Perrot and C. Chipiez, *Histoire de l'art dans l'antiquité*, iii. (Paris, 1885), interpret these and most other Cypriote materials without reserve as "Phoenician."

<sup>6</sup> F. Halbherr and P. Orsi, *Antichità dell' antro di Zeus Ideo in Creta* (Rome, 1888). Cf. H. Brunn, *Griechische Kunstgeschichte* (Munich, 1893), i. 90 ff.

<sup>7</sup> Herod. ii. 182; see also EGYPT: *History* (Dyn. XXVI.).

was preceded by the voluntary surrender of Cyprus, which formed part of Darius's "fifth satrapy."<sup>8</sup> The Greek cities, faring ill under Persia, and organized by Onesilaus of Salamis, joined the Ionic revolt in 500 B.C.;<sup>9</sup> but the Phoenician states, Citium and Amathus, remained loyal to Persia; the rising was soon put down; in 480 Cyprus furnished no less than 150 ships to the fleet of Xerxes;<sup>10</sup> and in spite of the repeated attempts of the Delian League to "liberate" the island, it remained subject to Persia during the 5th century.<sup>11</sup> The occasion of the siege of Idalium by Persians (which is commemorated in an important Cypriote inscription) is unknown.<sup>12</sup> Throughout this period, however, Athens and other Greek states maintained a brisk trade in copper, sending vases and other manufactures in return, and bringing Cyprus at last into full contact with Hellenism. But the Greek cities retained monarchical government throughout, and both the domestic art and the principal religious cults remained almost unaltered. The coins of the Greek dynasts and autonomous towns are struck on a variable standard with a stater of 170 to 180 grs.<sup>13</sup> The principal Greek cities were now Salamis, Curium, Paphos, Marion, Soli, Kyrenia and Khytri. Phoenicians held Citium and Amathus on the south coast between Salamis and Curium, also Tamassus and Idalium in the interior; but the last named was little more than a sanctuary town, like Paphos. At the end of the 5th century a fresh Salaminian League was formed by Evagoras (*q.v.*), who became king in 410, aided the Athenian Conon after the fall of Athens in 404, and revolted openly from Persia in 386, after the peace of Antalcidas.<sup>14</sup> Athens again sent help, but as before the Phoenician states supported Persia; the Greeks were divided by feuds, and in 380 the attempt failed; Evagoras was assassinated in 374, and his son Nicocles died soon after. After the victory of Alexander the Great at Issus in 333 B.C. all the states of Cyprus welcomed him, and sent timber and ships for his siege of Tyre in 332.

After Alexander's death in 323 B.C. Cyprus, coveted still for its copper and timber, passed, after several rapid changes, to Ptolemy I., king of Egypt. Then in 306 B.C. Demetrius Poliorcetes of Macedon overran the whole island, besieged Salamis, and utterly defeated there the Egyptian fleet. Ptolemy, however, recovered it in 295 B.C. Under Ptolemaic rule Cyprus has little history. Usually it was governed by a viceroy of the royal line, but it gained a brief independence under Ptolemy Lathyrus (107-89 B.C.), and under a brother of Ptolemy Auletes in 58 B.C. The great sanctuaries of Paphos and Idalium, and the public buildings of Salamis, which were wholly remodelled in this period, have produced but few works of art; the sculpture from local shrines at Vóni and Vitsáda, and the frescoed tombstones from Amathus, only show how incapable the Cypriotes still were of utilizing Hellenistic models; a rare and beautiful class of terra-cottas like those of Myrina may be of Cypriote fabric, but their style is wholly of the Aegean. It is in this period that we first hear of Jewish settlements,<sup>15</sup> which later become very populous.

In 58 B.C. Rome, which had made large unsecured loans to Ptolemy Auletes, sent M. Porcius Cato to annex the island, nominally because its king had connived at piracy, really because its revenues and the treasures of Paphos were coveted to finance a corn law of P. Clodius.<sup>16</sup> Under Rome Cyprus was at first appended to the province of Cilicia; after Actium (31 B.C.) it became a separate province, which remained in the hands of Augustus and was governed by a *legatus Caesaris pro praetore* as long as danger was feared from the East.<sup>17</sup> No monuments

<sup>8</sup> Herod. iii. 19, 91; see also PERSIA: *History*.

<sup>9</sup> Herod. v. 108, 113, 115.

<sup>10</sup> Herod. vii. 90.

<sup>11</sup> Thuc. i. 94, 112.

<sup>12</sup> M. Schmidt, *Die Inschrift von Idalion* (Jena, 1874).

<sup>13</sup> G. F. Hill, *Brit. Mus. Cat. Coins of Cyprus* (London, 1904). Earlier literature in Cobham, *l.c.* p. 39.

<sup>14</sup> H. F. Talbot, *Tr. Soc. Bibl. Arch.* v. 447 ff. (translation). For Evagoras and the place of Cyprus in later Greek history, see G. Grote, *History of Greece* (Index, *s.v.*), and W. H. Engel, *Kypros* (Berlin, 1841).

<sup>15</sup> 1 Macc. xv. 23. <sup>16</sup> Livy, *Epit.* 104; Cic. *pro Sestio*, 26, 57.

<sup>17</sup> Dio Cass. liii. 12; Strabo 683, 840.

remain of this period. In 22 B.C., however, it was transferred to the senate,<sup>1</sup> so that Sergius Paulus, who was governor in A.D. 46, is rightly called ἀρχικρατος (proconsul).<sup>2</sup> Of Paulus no coins are known, but an inscription exists.<sup>3</sup> Other proconsuls are Julius Cordus and L. Annius Bassus who succeeded him in A.D. 52.<sup>4</sup> The copper mines, which were still of great importance, were farmed at one time by Herod the Great.<sup>5</sup> The persecution of Christians on the mainland after the death of Stephen drove converts as far as Cyprus; and soon after converted Cypriote Jews, such as Mnason (an "original convert") and Joses the Levite (better known as Barnabas), were preaching in Antioch. The latter revisited Cyprus twice, first with Paul on his "first journey" in A.D. 46, and later with Mark.<sup>6</sup> In 116-117, the Jews of Cyprus, with those of Egypt and Cyrene, revolted, massacred 240,000 persons, and destroyed a large part of Salamis. Hadrian, afterwards emperor, suppressed them, and expelled all Jews from Cyprus.

For the culture of the Roman period there is abundant evidence from Salamis and Paphos, and from tombs everywhere, for the glass vessels which almost wholly supersede pottery are much sought for their (quite accidental) iridescence; not much else is found that is either characteristic or noteworthy; and little attention has been paid to the sequence of style.

The Christian church of Cyprus was divided into thirteen bishoprics. It was made autonomous in the 5th century, in recognition of the supposed discovery of the original of St Matthew's Gospel in a "tomb of Barnabas" which is still shown at Salamis. The patriarch has therefore the title μακαριώτατος and the right to sign his name in red ink. A council of Cyprus, summoned by Theophilus of Alexandria in A.D. 401, prohibited the reading of the works of Origen (see CYPRUS, CHURCH OF).

Of the Byzantine period little remains but the ruins of the castles of St Hilarion, Buffavento and Kantára; and a magnificent series of gold ornaments and silver plate, found near Kyrenia in 1883 and 1897 respectively. Christian tombs usually contain nothing of value.

The Frank conquest is represented by the "Crusaders' Tower" at Kolossi, and the church of St Nicholas at Nicosia; and, later, by masterpieces of a French Gothic style, such as the church (mosque) of St Sophia, and other churches at Nicosia; the cathedral (mosque) and others at Famagusta (q.v.), and the monastery at Bella Pais; as well as by domestic architecture at Nicosia; and by forts at Kyrenia, Limasol and elsewhere.

The Turks and British have added little, and destroyed much, converting churches into mosques and grain-stores, and quarrying walls and buildings at Famagusta.

*History of Excavation.*—Practically all the archaeological discoveries above detailed have been made since 1877. A few chance finds of vases, inscriptions and coins; of a hoard of silver bowls at Dali (anc. *Idalium*)<sup>7</sup> in 1851; and of a bronze tablet with Phoenician and Cypriote bilingual inscriptions,<sup>8</sup> also at Dali, and about the same time, had raised questions of great interest as to the art and the language of the ancient inhabitants. T. B. Sandwith, British consul 1865-1869, had laid the foundations of a sound knowledge of Cypriote pottery;<sup>9</sup> his successor R. H. Lang (1870-1872) had excavated a sanctuary of Aphrodite at Dali;<sup>10</sup> and at the time of the publication of the 9th ed. of the *Ency. Brit.*,<sup>11</sup> General Louis P. di Cesnola (q.v.), American consul, was already exploring ancient sites, and opening tombs, in all parts of the island, though his results were not published till 1877.<sup>12</sup> But though his vast collection, now

<sup>1</sup> Dio Cass. liv. 4; Strabo 685.

<sup>2</sup> Acts xiii. 7.

<sup>3</sup> D. G. Hogarth, *Devia Cypria*, pp. 114 ff. and app.

<sup>4</sup> *Corp. Inscr. Lat.* 2631-2632.

<sup>5</sup> *Jos. Ant.* 16. 4, 5; 19. 26, 28.

<sup>6</sup> Acts iv. 36, xi. 19, 20, xiii. 4-13, xv. 39, xxi. 16.

<sup>7</sup> De Longpérier, *Athenæum français* (1853), pp. 413 ff.; *Musée Napoléon*, pls. x. xi.

<sup>8</sup> De Luynes, *Numismatique et inscriptions chypriotes* (1852).

<sup>9</sup> *Archæologia*, xlv. (1877), pp. 127-142.

<sup>10</sup> *Trans. Roy. Soc. Literature*, 2nd ser. xi. (1878), pp. 30 ff.

<sup>11</sup> Article "Cyprus" *ad. fin.*

<sup>12</sup> *Cyprus: its Cities, Tombs and Temples* (London, 1877).

in the Metropolitan Museum of New York, remains the largest series of Cypriote antiquities in the world, the accounts which have been given of its origin are so inadequate, and have provoked so much controversy,<sup>13</sup> that its scientific value is small, and a large part of subsequent excavation has necessarily been directed to solving the problems suggested by its practically isolated specimens. From 1876 to 1878 Major Alexander P. di Cesnola continued his brother's work, but the large collection which he exhibited in London in 1880 was dispersed soon afterwards.<sup>14</sup>

On the British occupation of Cyprus in 1878, the Ottoman law of 1874 in regard to antiquities was retained in force. Excavation is permitted under government supervision, and the finds are apportioned in thirds, between the excavator, the landowner (who is usually bought out by the former), and the government. The government thirds lie neglected in a "Cyprus Museum" maintained at Nicosia by voluntary subscription. There is no staff, and no effective supervision of ancient sites or monuments. A catalogue of the collections was published by the Oxford University Press in 1899.<sup>15</sup>

Since 1878 more than seventy distinct excavations have been made in Cyprus, of which the following are the most important. In 1879 the British government used the acropolis of *Citium* (Larnaca) to fill up the ancient harbour; and from the destruction a few Phoenician inscriptions and a proto-Ionic capital were saved. In 1882 tombs were opened by G. Hake at *Salamis* and *Curium* for the South Kensington Museum, but no scientific record was made. In 1883 the Cyprus Museum was founded by private enterprise, and on its behalf Max Ohnefalsch-Richter, who had already made trial diggings for Sir Charles Newton and the British Museum, excavated sanctuaries at *Vóni* and *Kythría* (*Chytri*), and opened tombs on some other sites.<sup>16</sup>

In 1885 Dr F. Dümmler opened tombs at Dali, Alámra and elsewhere, and laid the foundations of knowledge of the Bronze Age and Early Iron Age;<sup>17</sup> and Richter, on behalf of officials and private individuals, excavated parts of *Frángissa* (*Tamassus*), *Episkopí* and Dali.<sup>18</sup>

In the same year, 1885, and in 1886, a syndicate opened many tombs at *Póli-tis-Khrýsochou* (*Marium, Arsinoë*), and sold the contents by auction in Paris. From Richter's notes of this excavation, Dr P. Herrmann compiled the first scientific account of Græco-Phoenician and Hellenistic Cyprus.<sup>19</sup> In 1886 also M. le vicomte E. de Castillon de St Victor opened rich Græco-Phoenician tombs at *Episkopí*, the contents of which are in the Louvre.<sup>20</sup>

The successes of 1885-1886 led to the foundation of the Cyprus Exploration Fund, on behalf of which (1) in 1888 the sanctuary of Aphrodite at *Paphos* (Kouklia) was excavated by Messrs E. Gardner, M. R. James, D. G. Hogarth and R. Elsey Smith;<sup>21</sup> (2) in 1889-1890 more tombs were opened at *Póli* by Messrs J. A. R. Munro and H. A. Tubbs;<sup>22</sup> (3) in 1890-1891 extensive trials were made at *Salamis*, by the same;<sup>23</sup> (4) minor sites were examined at *Leondári Vounò* (1888),<sup>24</sup> *Amargetti* (1888),<sup>25</sup> and *Limniti* (1889);<sup>26</sup> (5) in 1888 Hogarth made a surface-survey of the *Karpas* promontory;<sup>27</sup> and finally, (6) in 1894 the balance was expended by J. L. Myres in a series of trials, to settle special

<sup>13</sup> See Cobham, *An Attempt at a Bibliography of Cyprus* (4th ed., Nicosia, 1900), Appendix, "Cesnola Controversy," p. 54.

<sup>14</sup> *The Lawrence-Cesnola Collection* (London, 1881); *Salamina*, *id.* 1882.

<sup>15</sup> Myres and Ohnefalsch-Richter, *A Catalogue of the Cyprus Museum, with a Chronicle of Excavations since the British Occupation, and Introductory Notes on Cypriote Archaeology* (Oxford, 1899).

<sup>16</sup> *Mitt. d. arch. Inst.* ii. (Athens, 1881).

<sup>17</sup> *Mitt. d. arch. Inst.* vi. (Athens, 1886); *Bemerkungen z. alt. Kunsthandwerk, &c.*, ii. "Der kypr. geometrische Stil" (Halle, 1888).

<sup>18</sup> Summarized in *Cyprus, the Bible and Homer* (London and Berlin, 1893).

<sup>19</sup> *Das Gräberfeld von Marion* (Berlin, 1888).

<sup>20</sup> *Archives des missions scientifiques*, xvii. (Paris, 1891).

<sup>21</sup> *Journal of Hellenic Studies*, ix. (London, 1888).

<sup>22</sup> *Id.* xi. (1890); xii. (1891).

<sup>23</sup> *Id.* xii. (1891).

<sup>24</sup> *Id.* ix. (1888).

<sup>25</sup> *Id.* ix. (1888).

<sup>26</sup> *Id.* xi. (1890).

<sup>27</sup> *Devia Cypria* (Oxford, 1889).



points, at Agia Paraskevi, Kalopsida and Larnaca.<sup>1</sup> In 1894 also Dr Richter excavated round *Idalium* and *Tamassus* for the Prussian government: the results, unpublished up to 1902, are in the Berlin Museum.<sup>2</sup> Finally, a legacy from Miss Emma T. Turner enabled the British Museum to open numerous tombs, by contract, of the Graeco-Phoenician age, in 1894, at Palaeo-Lemessò (*Amathus*); and of the Mycenaean age, in 1894-1895 at Episkopi, in 1895-1896 at Enkomi (near *Salamis*), and in 1897-1899 on small sites between Larnaca and Limasol.<sup>3</sup>

For ancient Oriental references to Cyprus see E. Oberhummer, *Die Insel Cypern*, i. (Munich, 1903); for classical references, W. H. Engel, *Kypros* (2 vols., Berlin, 1841); for culture and art, G. Perrot and C. Chipiez, *Histoire de l'art dans l'antiquité*, vol. iii. "Phénicie et Cypre" (Paris, 1885); L. P. di Cesnola, *A Descriptive Atlas of the Cesnola Collection of Cypr. Antiquities in the Metropolitan Museum of Art*, New York (3 vols., Boston, U.S.A., 1884-1886); M. Ohnefalsch-Richter, *Kypros, the Bible and Homer* (2 vols., London and Berlin, 1893); J. L. Myres and M. Ohnefalsch-Richter, *Cyprus Museum Catalogue* (Oxford, 1899). The principal publications on special topics are given in the footnotes. For Cypriote coins see also NUMISMATICS. See further the general bibliography below. (J. L. M.)

#### MODERN HISTORY

After the division of the Roman empire Cyprus naturally passed, with all the neighbouring countries, into the hands of the Eastern or Byzantine emperors, to whom it continued subject, with brief intervals, for more than seven centuries. Until 644 the island was exceedingly prosperous, but in that year began the period of Arab invasions, which continued intermittently until 975. At the outset the Arabs under the caliph Othman made themselves masters of the island, and destroyed the city of Salamis, which until that time had continued to be the capital. The island was recovered by the Greek emperors and, though again conquered by the Arabs in the reign of Harun al-Rashid (802), it was finally restored to the Byzantine empire under Nicephorus Phocas. Its princes became practically independent, and tyrannized the island, until in 1191 Isaac Comnenus provoked the wrath of Richard I., king of England, by wantonly ill-treating his crusaders. He thereupon wrested the island from Isaac, whom he took captive. He then sold Cyprus to the Knights Templars, who presently resold it to Guy de Lusignan, titular king of Jerusalem.

Guy ruled from 1192 till his death in 1194; his brother Amaury took the title of king, and from this time Cyprus was governed for nearly three centuries by a succession of kings of the same dynasty, who introduced into the island the feudal system and other institutions of western Europe. During the later part of this period, indeed, the Genoese made themselves masters of Famagusta—which had risen in place of Salamis to be the chief commercial city in the island—and retained possession of it for a considerable time (1376-1464); but it was recovered by King James II., and the whole island was reunited under his rule. His marriage with Caterina Cornaro, a Venetian lady of rank, was designed to secure the support of the powerful republic of Venice, but had the effect after a few years, in consequence of his own death and that of his son James III., of transferring the sovereignty of the island to his new allies. Caterina, feeling herself unable to contend alone with the increasing power of the Turks, was induced to abdicate the sovereign power in favour of the Venetian republic, which at once entered into full possession of the island (1489).

The Venetians retained their acquisition for eighty-two years, notwithstanding the neighbourhood of the Turks. Cyprus was now harshly governed by a lieutenant, and the condition of the natives, who had been much oppressed under the Lusignan dynasty, became worse. In 1570 the Turks, under Selim II., made a serious attempt to conquer the island, in which they landed an army of 60,000 men. The greater part of the island was reduced with little difficulty; Nicosia, the capital, was taken after a siege of 45 days, and 20,000 of its inhabitants put to the sword. Famagusta alone made a gallant and pro-

tracted resistance, and did not capitulate till after a siege of nearly a year's duration (August 1571). The terms of the capitulation were shamefully violated by the Turks, who put to death the governor Marcantonio Bragadino with cruel torments. From that time Cyprus was under Turkish administration until the agreement with Great Britain in 1878. Its history during that period is almost a blank. A serious insurrection broke out in 1764, but was speedily suppressed; and a few similar incidents are the only evidence of the Turkish oppression of the Christian population of the island, and the consequent stagnation of its trade.

**AUTHORITIES.**—*An Attempt at a Bibliography of Cyprus*, by C. D. Cobham (4th ed., Nicosia, 1900), registers over 700 works which deal with Cyprus. *A Handbook of Cyprus*, by Sir J. T. Hutchinson and C. D. Cobham (London), treats the island briefly from every standpoint. See also E. Oberhummer, *Die Insel Cypern* (Munich, 1903 et seq.), a comprehensive work. The most interesting travels may be found under the names of Felix Faber, *Evagatorium* (Stuttgart, 1843); de Villamont, *Voyages* (Arras, 1598); van Kootwijk, *Colovici itinerarium* (Antwerp, 1619); R. Pococke, *Description of the East* (London, 1743); A. Drummond, *Travels* (London, 1754); E. D. Clarke, *Travels* (London, 1812); Sir S. Baker, *Cyprus in 1870* (London, 1879); W. H. Mallock, *In an Enchanted Island* (London, 1879). The geology of the island has been handled by A. Gaudry, *Géologie de l'île de Chypre* (Paris, 1862); C. V. Bellamy, *Notes on the Geology of Cyprus, to accompany a Geological Map of Cyprus* (London, 1905); C. V. Bellamy and A. J. Jukes-Brown, *Geology of Cyprus* (Plymouth, 1905). Its natural history by F. Unger and T. Kotschy, *Die Insel Cypern* (Wien, 1865). Numismatics by the Duc de Luynes, *Numismatique et inscriptions cypriotes* (Paris, 1852); R. H. Lang, *Numism. Chronicle*, vol. xi. (1871); J. P. Six, *Rev. num.* pp. 249-374 (Paris, 1883); and E. Babelon, *Monnaies grecques* (Paris, 1893). The coins of medieval date have been described by P. Lambros, *Monnaies inédites* (Athens, 1876); and G. Schlumberger, *Num. de l'orient latin* (Paris, 1878). Inscriptions in the Cypriote character have been collected by M. Schmidt, *Sammlung* (Jena, 1876); and W. Deecke, *Die griechisch-kyprischen Inschriften* (Göttingen, 1883); in Phoenician in the *C. I. P.* (Paris, 1881). J. Meursius, *Cyprus* (Amsterdam, 1675), marshals the classical authorities; and W. Engel, *Kypros* (Berlin, 1841), gives a good summary of the ancient history of the island. For the Phoenician element, see F. Movers, *Die Phönizier* (Bonn and Berlin, 1841-1856). L. Comte de Mas Latrie published between 1852 and 1861 one volume of *History* (1191-1291), and two of most precious documents in illustration of the reigns of the Lusignan kings. Fra Stefano Lusignano, *Chorografia di Cipro* (Bologna, 1573), and Bp. Stubbs, *Two Lectures* (Oxford, 1878), are useful for the same period; and perhaps a score of contemporary pamphlets—the best of them by N. Martinengo, *Relatione di tutto il successo di Famagosta* (Venezia, 1572), and A. Calepio (in Lusignan's *Chorografia*)—preserve details of the famous sieges of Nicosia and Famagusta. G. Mariti, *Viaggi* (Lucca, 1769; Eng. trans. C. D. Cobham, 2nd ed., 1909), and Cyprianos, *History* (Venice, 1768), are the best authorities of Cyprus under Turkish rule. Medieval tombs and their inscriptions are recorded and illustrated in T. J. Chamberlayne, *Lacrimae nicossiensis* (Paris, 1894); and C. Enlart's volumes, *L'Art gothique et la Renaissance en Chypre* (Paris, 1899), deal with medieval architecture. For Cypriote pottery in Athens and Constantinople, see G. Nicole, *Bulletin de l'Institut Genevois*, xxxvii.

**CYPRUS, CHURCH OF.** The Church of Cyprus is in communion and in doctrinal agreement with the other Orthodox Churches of the East (see ORTHODOX EASTERN CHURCH), but is independent and subject to no patriarch. This position it has always claimed (see, however, W. Bright, *Notes on the Canons*, on Ephesus 8). At any rate, its independence "by ancient custom" was recognized, as against the claims of the patriarch of Antioch, by the council of Ephesus, A.D. 431, by an edict of the emperor Zeno (to whom the church had sent a cogent argument on its own behalf, the alleged body of its reputed founder St Barnabas, then just discovered at Salamis), and by the Trullan Council in 692. Attempts have been made subsequently by the patriarchs of Antioch to claim authority over it, the last as recently as 1600; but they came to nothing. And excepting for the period during which Cyprus was in the hands of the Lusignans and the Venetian Republic (1193-1571), the Church has never lost its independence. It receives the holy ointment (*μύρον*) from without, till 1860 from Antioch and subsequently from Constantinople, but this is a matter of courtesy and not of right. Of old there were some twenty sees in the island. The bishop of the capital, Salamis or Constantia, was constituted metropolitan by Zeno, with the title "archbishop

<sup>1</sup> J.H.S. xvii. (1897).

<sup>2</sup> Summarized in *Cyprus Museum Catalogue* (Oxford, 1899).

<sup>3</sup> *Excavations in Cyprus* (London, 1900).

of all Cyprus," enlarged subsequently into "archbishop of Justiniana Nova and of all Cyprus," after an enforced expatriation to Justinianopolis in 688. Zeno also gave him the unique privileges of wearing and signing his name in the imperial purple, &c., which are still preserved. A Latin hierarchy was set up in 1106 (an archbishop at Nicosia with suffragans at Limasol, Paphos and Famagusta), and the Greek bishops were made to minister to their flocks in subjection to it. The sees were forcibly reduced to four, the archbishopric was ostensibly abolished, and the bishops were compelled to do homage and swear fealty to the Latin Church. This bondage ceased at the conquest of the island by the Turks: the Latin hierarchy disappeared (the cathedral at Nicosia is now used as a mosque), and the native church emerged into comparative freedom. In 1821, it is true, all the bishops and many of their flock were put to death by way of discouraging sympathies with the Greeks; but successors were soon consecrated, by bishops sent from Antioch at the request of the patriarch of Constantinople, and on the whole the Church has prospered. The bishops-elect required the *berat* of the sultan; but having received this, they enjoyed no little civil importance. Since 1878 the *berat* has not been given, and the bishops are less influential. The suppressed sees have never been restored, but the four which survive (now known as Nicosia, Paphos, Kition and Kyrenia) are of metropolitan rank, so that the archbishop, whose headquarters, first at Salamis, then at Famagusta, are now at Nicosia, is a primate amongst metropolitans. There are several monasteries dating from the 11th century and onwards; also an archiepiscopal school at Nicosia, founded in 1812 and raised to the status of a "gymnasium" in 1893; and a high school for girls.

**AUTHORITIES.**—Ph. Georgiou, *Εἰδήσεις Ἱστορικαὶ περὶ τῆς Ἐκκλησίας τῆς Κύπρου* (Athens, 1875); K. Kouriokurineos (Archbishop of Cyprus), *Ἱστορία χρονολογικὴ τῆς ἡσού Κυπρου* (Venice, 1788); de Mas Latrie, *Histoire de l'île de Chypre sous les princes de la maison de Lusignan* (Paris, 1852 f.); H. T. F. Duckworth, *The Church of Cyprus* (London, 1900); J. Hackett, *History of the Orthodox Church of Cyprus* (1901). (W. E. Co.)

**CYPSELUS**, tyrant of Corinth (c. 657–627 B.C.), was the son of Aeëtion and Labda, daughter of Amphion, a member of the ruling family, the Bacchiadae. He is said to have derived his name from the fact that when the Bacchiadae, warned that he would prove their ruin, sent emissaries to kill him in his cradle, his mother saved him by concealing him in a chest (Gr. *κυψέλη*). The story was, of course, a subsequent invention. When he was grown up, Cypselus, encouraged by an oracle, drove out the Bacchiadae, and made himself master of Corinth. It is stated that he first ingratiated himself with the people by his liberal conduct when Polemarch, in which capacity he had to exact the fines imposed by the law. In the words of Aristotle he made his way through demagogy to tyranny. Herodotus, in the spirit of 5th-century Greeks, which conventionally regarded the tyrants as selfish despots, says he ruled harshly, but he is generally represented as mild, beneficent and so popular as to be able to dispense with a bodyguard, the usual attribute of a tyrannus. He pursued an energetic commercial and colonial policy (see CORINTH), and thus laid the foundations of Corinthian prosperity. He may well be compared with the Athenian Peisistratus in these respects. He laid out the large sums thus derived on the construction of buildings and works of art. At the same time he wisely strove to gain the goodwill of the powerful priest-hoods of the great sanctuaries of Delphi and Olympia. At Delphi he built a treasure-house for Corinthian votive offerings; at Olympia he dedicated a colossal statue of Zeus and the famous "chest of Cypselus," supposed to be identical with the chest of the legend, of which Pausanias (v. 17–19) has given an elaborate description. It was of cedar-wood, gold and ivory, and on it were represented the chief incidents in Greek (especially Corinthian) mythology and legend. Cypselus was succeeded by his son Periander.

See CORINTH: *History*; histories of Greece; Herodotus v. 92; Aristotle, *Politics*, 1310b, 1315b; P. Knapp, *Die Kypseliden und die Kypseloside* (Tübingen, 1888); L. Preller, *Ausgewählte Aufsätze* (1864); H. Stuart Jones, in *Journ. Hell. Stud.* (1894), 30 foll.

**CYRANO DE BERGERAC, SAVINIEN** (1620–1655), French romance-writer and dramatist, son of Abel de Cyrano, seigneur de Mauvières et de Bergerac, was born in Paris on the 6th of March 1619–1620. He received his first education from a country priest, and had for a fellow pupil his friend and future biographer, Henri Lebrét. He then proceeded to Paris to the collège de Beauvais, where he had for master Jean Grangier, whom he afterwards ridiculed in his comedy *Le Pédant joué* (1654). At the age of nineteen he entered a corps of the guards, serving in the campaigns of 1639 and 1640, and began the series of exploits that were to make of him a veritable hero of romance. The story of his adventure single-handed against a hundred enemies is vouched for by Lebrét as the simple truth. After two years of this life Cyrano left the service and returned to Paris to pursue literature, producing tragedies cast in the orthodox classical mode. He was, however, as a pupil of Gassendi, suspected of thinking too freely, and in the *Mort d'Agrippine* (1654) his enemies even found blasphemy. The most interesting section of his work is that which embraces the two romances *L'Histoire comique des états du soleil* (1662) and *L'Histoire comique des états de la lune* (1656?). Cyrano's ingenious mixture of science and romance has furnished a model for many subsequent writers, among them Swift and E. A. Poe. It is impossible to determine whether he adopted his fanciful style in the hope of safely conveying ideas that might be regarded as unorthodox, or whether he simply found in romance writing a relaxation from the serious study of physics. Cyrano spent a stormy existence in Paris and was involved in many duels, and in quarrels with the comedian Montfleury, with Scarron and others. He entered the household of the duc d'Arpajon as secretary in 1653. In the next year he was injured by the fall of a piece of timber, as he entered his patron's house. Arpajon, perhaps alarmed by his reputation as a free-thinker, desired him to leave, and he found refuge with friends in Paris. During the illness which followed his accident, he is said to have been reconciled with the Church, and he died in September 1655.

M. Edmond Rostand's romantic play of *Cyrano de Bergerac* (1897) revived interest in the author of the *Histoires comiques*. A modern edition of his *Œuvres* (2 vols.), by P. L. Jacob (Paul Lacroix), appeared in 1858, with the preface by H. Lebrét originally prefixed to the *Histoire comique des états de la lune* (1656?). For an interesting analysis of the romances see Garnet Smith in the *Cornhill* for July 1898. See also P. A. Brun, *Savinien de Cyrano Bergerac* (1894). Other studies of Cyrano are those of Charles Nodier (1841), F. Merilhon (Périgueux, 1856), Fourgeaud-Lagrèze (in *Le Périgord littéraire*, 1875) and of Théophile Gautier, in his *Grotesques*.

**CYRENAICA**, in ancient geography, a district of the N. African coast, lying between the Syrtis Major and Marmarica, the western limit being Arae Philaenorum, and the eastern a vague line drawn inland from the head of the gulf of Platea (Bomba). On the south the limit was undefined, but understood to be the margin of the desert, some distance north of the oasis of Augila (Aujila). The northern half of this district, which alone was fertile, was known as Pentapolis from its possession of five considerable cities (1) Hesperides-Berenice (Bengazi), (2) Barca (Merj), (3) Cyrene (Ain Shahat-Grenna), (4) Apollonia (Marsa Susa), (5) Teucheira-Arsinoë (Tocra). In later times two more towns rose to importance, Ptolemais (Tolmeita) and Darnis-Zarine (Derna). These all lay on the coast, with the exception of Barca and Cyrene, which were situated on the highland now called Jebel Akhdar, a few miles inland. Cyrene was the first city to arise, being founded among Libyan barbarians by Aristotle of Thera (later called Battus) in the middle of the 7th century B.C. (see CYRENE). For about 500 years this district enjoyed great prosperity, owing partly to its natural products, but more to its trade with interior Africa.

Under the Ptolemies, the inland cities declined in comparison with the maritime ones, and the Cyrenaica began to feel the commercial competition of Egypt and Carthage, whence easier roads lead into the continent. After all N. Africa had passed to Rome, and Cyrenaica itself, bequeathed by Apion, the last Ptolemaic sovereign, was become (in combination with Crete) a Roman province (after 96 B.C.), this competition told more severely than ever, and the Greek colonists, grown weaker, found

themselves less able to hold their own against the Libyan population. A great revolt of the Jewish settlers in the time of Trajan settled the fate of Cyrene and Barca; the former is mentioned by Ammianus Marcellinus in the 4th century A.D. as "urbs deserta," and Synesius, a native, describes it in the following century as a vast ruin at the mercy of the nomads. Long before this its most famous article of export, the *silphium* plant, a representation of which was the chief coin-type of Cyrene, had come to an end. This plant, credited with wonderful medicinal and aromatic properties, has not been certainly identified with any existing species. The similar *Thapsia garganica* (Arab. *drias*), which now grows freely in Cyrenaica, though it has medicinal properties, has not those ascribed to *silphium*. Henceforward till the Arab invasion (A.D. 641) Apollonia was the chief city, with Berenice and Ptolemais next in order. After the conquest by Amr ibn el-'Asi, inland Cyrenaica regained some importance, lying as it did on the direct route between Alexandria and Kairawan, and Barca became its chief place. But with the substitution of Ottoman for Arab empire, resulting in the virtual independence of both Egypt and Tripoli, the district lying between them relapsed to anarchy. This state of things continued even after Mahmud II. had resumed direct control over Tripoli (1835), and in the middle of the 19th century Cyrenaica was still so free of the Turks that Sheik Ali bin-Senussi chose it as the headquarters of his nascent dervish order. All over the district were built Senussi convents (*zawia*), which still exist and have much influence, although the headquarters of the order were withdrawn about the year 1855 to Jarabub, and in 1895 to Kufra, still farther into the heart of Africa. In 1875 the district, till then a sanjak of the vilayet of Tripoli, was made to depend directly on the Ministry of the Interior at Constantinople; and the Senussites soon ceased to be *de facto* rulers of Cyrenaica. Their preserves have now been still further encroached upon by a number of Cretan Moslem refugees (1901-1902). This is not the first effort made by Turkey to colonize Cyrenaica. In 1869 Ali Riza Pasha of Tripoli tried to induce settlers to go to Bomba and Tobruk; and in 1888 an abortive effort was made to introduce Kurds. To protect the Cretans the Ottoman government has extended the civil administration and created several small garrisoned posts. The district is accordingly safer for Europeans than it was; but these still find themselves ill received. The Ottoman officials discourage travel in the interior, partly from fear of the Senussites, partly from suspicions, excited by the lively interest manifested by Italy in Cyrenaica.

At the present day we understand by Cyrenaica a somewhat larger district than of old, and include ancient Marmarica up to the head of the gulf of Sollum (Catabathmus Magnus). The whole area is about 30,000 sq. m., and has some 250,000 inhabitants, inclusive of nomads. Projecting like a bastion into the Mediterranean at a very central point, Cyrenaica seems intended to play a commercial part; but it does not do so to any extent because of (1) lack of natural harbours, Bengazi and Derna having only open and dangerous roads (this is partly due to coastal subsidence; ancient ports have sunk); (2) the difficulty of the desert routes behind it, wells being singularly deficient in this part of the Sahara. The ivory and feather caravans from Wadai and Borku have latterly deserted it altogether. Consequently Cyrenaica is still in a very backward and barbarous state and largely given up to nomad Arabs. There are only two towns, Bengazi and Derna, and not half a dozen settlements beside, worthy to be called villages. In many districts the Senussi convents supply the only settled element, and the local Bedouins largely belong to the Order. There are no roads in the province, and very little internal communication and trade; but a wireless telegraphic system has been installed in communication with Rhodes: and there is a landline from Bengazi to Tripoli.

Geologically and structurally Cyrenaica is a mass of Miocene limestone tilted up steeply from the Mediterranean and falling inland by a gentle descent to sea-level again at the line of depression, which runs from the gulf of Sidra through Aujila to Siwa.

This mass is divided into two blocks, the higher being the western Jebel Akhdar, on which Cyrene was built (about 1800 ft.): the lower, the eastern Jebel el-Akabah, the ancient Marmaric highlands (700 ft.). There is no continuous littoral plain, the longest strip running from the recess of the Syrtis round past Bengazi to Tolmeita. Thereafter, except for deltaic patches at Marsa Susa and Derna, the shore is all precipitous. Jebel Akhdar, being without "faults," has no deep internal valleys, and presents the appearance of downs: but its seaward face is very deeply eroded, and deep circular sinkings (swallow-holes) are common. There is much forest on its northward slopes, and good red earth on the higher parts, which bears abundant crops of barley, much desired by European maltsters. Plenty of springs issue on the highlands, and wide expanses of grassy country dotted with trees like an English park are met with. Here the Bedouins (mostly Beni Hassa) pasture flocks and herds, amounting to several million head. The climate is temperate and the rainfall usually adequate, but one year in five is expected to be droughty. The southward slopes fall through ever-thinning pasture lands to sheer desert about 80 m. inland. Jebel el-Akabah is much more barren than Jebel Akhdar, and the desert comes right down to the sea in Marmarica, whose few inhabitants are more concerned with salt-collecting and sponge fishing than with agriculture. They have, however, the only good ports on the whole coast, Bomba and Tobruk. Much might be made of Cyrenaica by judicious colonization. All kinds of trees grow well, from the date palm to the oak; and there are over 200,000 wild olives in the country. The conditions in general are very like those of central Italy, and there is ample room for new settlers.

**BIBLIOGRAPHY.**—(1) **Ancient Cyrenaica:** J. P. Thrige, *Historia Cyrenes* (1819); C. Ritter, *Erkunde*, i. (1822); A. F. Gottschick, *Gesch. der Gründung und Blüte des hell. Staates in Kyrenaika* (1858).

(2) **Modern Cyrenaica:** Paul Lucas, *Voyage* (1712); T. Shaw, *Travels and Observations* (1738); J. Bruce, *Travels* (1790); P. della Cella, *Viaggio da Tripoli*, &c. (1819); G. F. Lyon, *Narrative of Travels* (1821); A. Cervelli, in *Recueil de voyages*, pub. by Soc. de Géog., ii. (1825); J. R. Pacho, *Relation d'un voyage* (1827); F. W. Beechey, *Proceedings of Expedition to explore N. Coast of Africa* (1828); H. Barth, *Wanderungen*, &c. (1849); V. de Bourville, *Rapport* (1850); J. Hamilton, *Wanderings in N. Africa* (1856); R. M. Smith and E. A. Porcher, *Hist. of Discoveries* (1864); G. Rohlf, *Von Tripoli nach Alexandrien* (1871); G. Haimann, *La Cirenaica* (1882); M. Camperio, *Una Gita in Cirenaica* (1881); H. Duveyrier, "La Confr. musulmane de Sidi Moh. Ben Ali es-Senousi" (*Bull. soc. géog.*, 1884); H. W. Blundell in *Geog. Journ.* v. (1895) and *Annual Brit. Sch. at Athens*, ii. (1895); D. G. Hogarth in *Monthly Review* (Jan. 1904); G. Hildebrand, *Cyrenaika*, &c. (1904); G. de Martino, *Cirene e Cartagine* (1908).

(3) **Maps:** The best are that by P. Carlo, to illustrate Camperio and Haimann's Report, in Petermann's *Mith.* (1881); and Sheet No. 2 of *Carte de l'Afrique* (Service géog. de l'armée, 1892).

(D. G. H.)

**CYRENAICS**, a Greek school of philosophy, so called from Cyrene, the birthplace of the founder, Aristippus (q.v.). It was one of the two earliest Socratic schools, and emphasized one side only of the Socratic teaching (cf. CYNICS). Socrates, although he held that virtue was the only human good, admitted to a certain extent the importance of its utilitarian side, making happiness at least a subsidiary end of moral action (see ETHICS). Aristippus and his followers seized upon this, and made it the prime factor in existence, denying to virtue any intrinsic value. Logic and physical science they held to be useless, for all knowledge is immediate sensation (see PROTAGORAS). These sensations are motions (*κινήσεις*) which (1) are purely subjective, and (2) are painful, indifferent or pleasant, according as they are violent, tranquil or gentle. Further they are entirely individual, and can in no way be described as constituting absolute objective knowledge. Feeling, therefore, is the only possible criterion alike of knowledge and of conduct. "Our modes of being affected (*πάθη*) alone are knowable." Thus Cyrenaicism goes beyond the critical scepticism of the Sophists and deduces a single, universal aim for all men, namely pleasure. Furthermore, all feeling is momentary and homogeneous. It follows (1) that past and future pleasure have no real existence for us, and (2) that among present pleasures there is no distinction of kind, but

only of intensity. Socrates had spoken of the higher pleasures of the intellect; the Cyrenaics denied the validity of this distinction and said that bodily pleasures as being more simple and more intense are to be preferred. Momentary pleasure (*μυόχρονος ήδώνη*), preferably of a carnal kind, is the only good for man. Yet Aristippus was compelled to admit that some actions which give immediate pleasure entail more than their equivalent of pain. This fact was to him the basis of the conventional distinction of right and wrong, and in this sense he held that regard should be paid to law and custom. It is of the utmost importance that this development of Cyrenaic hedonism should be fully realized. To overlook the Cyrenaic recognition of social obligation and the hedonistic value of altruistic emotion is a very common expedient of those who are opposed to all hedonistic theories of life. Like many of the leading modern utilitarians, they combined with their psychological distrust of popular judgments of right and wrong, and their firm conviction that all such distinctions are based solely on law and convention, the equally unwavering principle that the wise man who would pursue pleasure logically must abstain from that which is usually denominated "wrong" or "unjust." This idea, which occupies a prominent position in systems like those of Bentham, Volney, and even Paley, was evidently of prime importance at all events to the later Cyrenaics.

Developing from this is a new point of practical importance to the hedonism of the Cyrenaics. Aristippus, both in theory and in practice, insisted that true pleasure belongs only to him who is self-controlled and master of himself. The truly happy man must have *φρόνησις* (prudence), which alone can save him from falling a prey to mere passion. Thus, in the end, Aristippus, the founder of the purest hedonism in the history of thought, comes very near not only to the Cynics, but to the more cultured hedonism of Epicurus and modern thinkers. Theodorus, held even more strongly that passing pleasure may be a delusion, and that permanent tranquillity is a truer end of conduct. Hegesias denied the possibility of real pleasure and advocated suicide as ensuring at least the absence of pain. Anniceris, in whose thought the school reached its highest perfection, declared that true pleasure consists sometimes in self-sacrifice and that sympathy in enjoyment is a real source of happiness. Other members of the school were Arete, wife of Aristippus, Aristippus the younger (her son), Bio and Euhemerus.

The Cyrenaic ideal was, of course, utterly alien to Christianity, and, in general, subsequent thinkers found it an ideal of hopeless pessimism. Yet in modern times it has found expression in many ethical and literary works, and it is common also in other ancient non-Hellenic literature. There are quatrains in the *Rubāiyāt* of Omar Khayyām and pessimistic verses in Ecclesiastes which might have been uttered by Aristippus ("Then I commended mirth, because a man hath no better thing than to eat and to drink and to be merry; for that shall abide with him of his labour the days of his life which God giveth him under the sun"). So in Byron and Heine, and, in a sense, in Walter Pater (*Marius the Epicurean*), there is the same tendency to seek relief from the intellectual *cul-de-sac* in frankly aesthetic satisfaction. Thus Cyrenaicism did not entirely vanish with its absorption in Epicureanism.

See HEDONISM, EPICURUS; histories of philosophy by Zeller, Windelband, Ueberweg; H. Sidgwick, *Methods of Ethics* and *Outlines of the History of Ethics*; J. Watson, *Hedonistic Theories* (1895); James Seth, *Ethical Principles*, c. i. (A), (1898); A. Wendt, *De philosophia Cyrenaica* (1841); H. von Stein, *De philosophia Cyrenaica* (1855); T. Gomperz, *Greek Thinkers* (Eng. trans., vol. ii. bk. iv., *ad fin.*, 1905); Beare, *Greek Theories of Elementary Cognition*; G. van Lyng, *Om den Kyrenaiske skole* (Christiania, 1868); and general ethical text-books.

**CYRENE** [mod. *Ain Shahat-Grenna*], the original capital of ancient Cyrenaica (q.v.) and one of the greatest of Greek colonies. The Theraean story of its foundation, as told by Herodotus, runs thus. Battus (whose true Greek name seems to have been Aristoteles), a native of Thera (Santorin), itself a Laconian colony, was bidden by the Delphic oracle, if he wished to put

an end to domestic dissensions, to lead a portion of the citizens to Libya and build a city in a "place between waters." (For other stories see BATTUS.) By this he understood an island, and therefore established his followers on the barren islet of Platea in the gulf of Bomba. The colony being unsuccessful made further application to the oracle and was bidden to transfer itself to the mainland. The Libyan barbarians reported that a fertile and well-watered district lay to the west and were induced to act as guides. They brought the Greeks through forests to high ground from various points of which issued springs, and Battus, recognizing "a place between waters," began to build. This was in the middle of the 7th century B.C.

The result was Cyrene, so called (it was said) from a local nymph, who has been shown by Studniczka to have been a Nature goddess, like the Greek Artemis. The point first occupied was probably the hill above the "Apollo" fountain on the west; and there was erected the fortress-palace of the Battiadae, who continued to rule the colony for eight generations. The neighbouring Libyans were conciliated and given a position similar to that of Laconian *perioeci*, and intermarriage between them and Greeks became so frequent that the colony rapidly assumed a somewhat hybrid character, and while being one of the centres of Hellenic culture, showed barbarian characteristics of violence and luxury. Battus I. reigned c. 630 to 590 B.C. and was succeeded by his son Arcesilaus (c. 590-574) of whom nothing is known. The kings henceforth bore alternately the names Battus and Arcesilaus, of which the first is said to be simply the native Libyan word for "king": the latter is, of course, Greek. This fact suggests that some compromise with the natives had been come to, resulting, perhaps, in an alternation of the supreme office. Under Battus II. (570 B.C.?) a fresh band of settlers was invited from Greece, and the colony tended to become henceforth more maritime and democratic. Its port, Apollonia (Marsa Susa), now rose to importance: and a second (winter) port was created at Naustathmos (Marsa Hilal) about 15 m. E. behind a sheltering cape. Fine roads were cut through the rock connecting these harbours with the capital. Trouble followed, however, with the Libyans, who saw themselves robbed in favour of the new settlers, and they called in Egyptian help; but the force sent by Apries was defeated near the spring Theste, and presently Amasis of Egypt made peace and took a Battiad princess to wife. Under Arcesilaus II. (c. 560-550) domestic dissensions and Libyan revolt led to the founding of a rival inland city, Barca, and a severe defeat and massacre. These misfortunes, coupled with the fact that Battus III. was thought to have disgraced the house by his lameness, prompted the Cyrenaicans to send to Delphi for more advice, and as a result Demonax of Mantinea arrived as arbitrator and framed a constitution limiting the monarchy and dividing the citizens tribally according to the date of their settlement and their place of origin. Further attempts of the Battiadae (e.g. of Pheretima, wife of Battus III., and Arcesilaus his son) to annul this constitution, and bitter family dissensions, brought about a Persian invasion and finally the extinction of the dynasty about 450 B.C. A republic of more or less Spartan type succeeded, but it was often interrupted by tyrannies; and having made submission by embassy to Alexander in 331, Cyrene passed under Ptolemaic domination ten years later. From this epoch dates a decline which was due to economic causes (see CYRENAICA) and to the Ptolemaic policy of favouring easily controlled harbour-towns rather than an inland place like Cyrene, whose ancient factions still continued to give trouble under the earlier Ptolemies. Apollonia and Berenice gradually superseded Cyrene and Barca respectively, being more in touch with Greece and less exposed to the hostile nomad Libyans, who increased in boldness and power: but Cyrene continued to be a great city after it had passed to Rome (96 B.C.), and up to the reign of Trajan, when a Jewish revolt and the repressive measures taken by the imperial government dealt it an irreparable blow. Ere Christianity became the religion of the empire, it was largely a ruin, and henceforward to the epoch of Arab conquest (A.D. 641) its Greek life gradually deserted it for Apollonia. At its

acme Cyrene is said to have had over 100,000 inhabitants. It was noted among the ancients for its intellectual life. Its medical school was famous, and it numbered among its celebrities Callimachus the poet, Carneades, the founder of the New Academy at Athens, Aristippus, a pupil of Socrates and the founder of the so-called Cyrenaics (*q.v.*), Eratosthenes the polyhistor, and Synesius, one of the most elegant of the ancient Christian writers.

The first account of the site in modern times seems to be that of M. le Maire, who was French consul at Tripoli from 1703 to 1708, and twice visited Cyrene. Paul Lucas was there in 1710, and again in 1723, and Dr Thomas Shaw in 1738; an Italian, Dr A. Cervelli, who was there in 1812, furnished some information to the Société de Géographie de Paris; and P. Della Cella published an account of his visit, made in 1817. In 1821-1822 important explorations were made by Lieutenant F. W. Beechey, R.N.; and he was almost immediately followed by a French artist, M. J. R. Pacho, whose pencil preserved a number of interesting monuments that have since disappeared. L. Delaporte, French consul at Tangier, and Vattier de Bourville come next in order of time. H. Barth, the famous African traveller, published an account of his investigations in his *Wanderungen durch die Küstenländer des Mittelmeers*, 1849, and James Hamilton, who was there in 1851, described the place in his *Wanderings in N. Africa*. In 1861 excavations were made on behalf of the British Museum by Lieuts. R. Murdoch Smith, R.E., and E. A. Porcher, R.N., the results of which are detailed in their valuable *Discoveries in Cyrene* (London, 1864). Since that date, owing to the increase of Senussi influence, and the consequent fears of the Ottoman authorities, the site has been very seldom visited. The Italians, M. Camperio and G. Haimann, leading commercial missions, were there in the eighties, and Mr H. W. Blundell succeeded with a special *firman* and a strong escort in reaching the place in 1895, but had trouble with the local Senussi Arabs. The prohibition of travel became thereafter more stringent, and it has only been overcome by a party from Mr A. V. Armour's yacht "Utowana," which marched up from Marsa Susa in April 1904, and stayed one night. They found some fifty families of Cretan refugees established at Ain Shabat and a *mudir* with a small guard on the spot: but no inhabited houses, except the Senussi convent and the *mudiria*. Cretans and Arabs live in the ancient rock-tombs. An Italian senator, Chev. G. de Martino, with two Italian residents at Derna, passed through the place in 1907, and found it in Bedouin hands.

The site lies on the crest of the highland of Jebel Akhdar (about 1800 ft.) and 10 m. from the sea. The ground slopes very gradually south, and being entirely denuded of trees, makes good corn land. The northward slope falls more steeply in a succession of shelves, covered here and there with forest. Ravines surround the site on three sides, and there are at least four springs in its area, of which one, having great volume, has been at all times the attraction and focus of the place. This is the so-called "Fount of Apollo," which issues from a tunnel artificially enlarged, and once faced with a portico. The acropolis was immediately above this on the W., and the main entrance of the city, through which came the sacred processions, passed it. The remains of Cyrene itself are enclosed by a wall having a circuit of about 4 m., of which little remains but the foundations and fragments of two towers; but tombs and isolated structures extend far outside this area. The local Arabs say it takes them six camel-hours to go from one end to the other of the ruins, which they call generally "*Grenna*" (*i.e.* Kyrenna). Within the city itself not very much is now to be seen. Below the Apollo fountain on the N. lie a great theatre and the substructures of the main temple of Apollo, both included now in the Senussi convent garden. Above the fountain and by the main road is a smaller theatre. On the E., upon the crown of the plateau, are the sites on which Smith and Porcher placed temples of Bacchus, Venus and Augustus, but they are marked only by rubbish heaps. Remains of a large Byzantine church and a much ruined stadium lie to S.E. On the S. are immense covered tanks of Roman date, with remains of the aqueducts which supplied them. On the W. a fine

fragment of a tower, the fortifications of the acropolis, and a pedestal sculptured on four sides in good 3rd century style, are the only things worth seeing. The Cretan occupation is fast obliterating other traces. The great spectacle, however, which distinguishes the site of Cyrene, is provided by its cemeteries, which for extent, variety and preservation are unparalleled in the classic lands. There is one along each of the approaches to the main gates, but the largest and most splendid lies by the Apollonian road which winds by easy curves up the northern buttresses of the plateau. Here the sepulchres rise in tiers one above the other along fully a mile of the way. The most important have pillared façades, Doric, Ionic, and even a hybrid mixture of both orders. Within, they open out either into large halls, leading one out of another with graves in recesses and pits in the floor; or into rock corridors lined with *loculi*, disposed one above another like pigeon holes. Most of the wall paintings, seen by Beechey and Pacho, have perished or become black with the smoke of troglodytes' fires; but one tomb below the road at about the middle of the cemetery still retains its decoration comparatively fresh, and seems to be that specially described by Smith and Porcher. The scenes are agonistic, *i.e.* represent funeral games, in which both white and black persons take part, the latter doubtless Libyan *perioeci*: but all wear Greek garments. Several tombs are inscribed and on some external paintings are still faintly visible. The commonest type of grave is a simple pit covered by a gabled lid. These occur by hundreds. But not all the sepulchres are rock-cut: altar tombs and other forms of *heroa* are found built upon plinths of rock. All visible tombs have long ago been violated, but it is probable that there are others still virgin under the *talus* of the hill side. To discover these and determine the topography of the city, excavation is urgently needed.

Many historical and artistic questions concerning Cyrene remain unsettled, but since the discoveries made in Laconia in 1908, the much disputed "Cyrenaic ware" has been ascribed to Sparta. A good deal of Cyrenaic sculpture, all of comparatively late date, was sent to the British Museum by Smith and Porcher. Nothing has yet been found on the site belonging to the great age of the city's independence, the fine vases sent to the British Museum in 1864, by Mr G. Dennis, having been discovered not there, but near Berenice (Bengazi). The latter site, with Ptolemais and Apollonia, has supplied most of the antiquities found latterly in Cyrenaica.

See authorities for CYRENAICA, and F. Studniczka, *Kyrene, eine alt-griechische Göttin* (1890). (D. G. H.)

CYRIL (c. 315-386), bishop of Jerusalem, where he was probably born, was ordained a presbyter in 345, and had the instruction of the catechumens entrusted to him. In 350 he was elevated to the see of Jerusalem, and became deeply involved in the dogmatic controversies of his time. His metropolitan, Acacius of Caesarea, inclined to Arianism, while Cyril strongly espoused the Nicene creed and was, in consequence, deposed for a time. On the death of the emperor Constantine he was restored; but on the accession of Valens, and Arian emperor, he had once more to resign his post till the accession of Theodosius permitted him to return finally in peace in 379. He attended the second oecumenical council held at Constantinople in 381, where he was received with grateful acclamations for his sufferings in defence of orthodoxy. Cyril was even more conspicuous as a pastor than as a controversialist, and this is seen in his one important work—his twenty-three addresses to catechumens delivered in A.D. 348. The first eighteen of these were meant for candidates for baptism; they deal with general topics like repentance and faith, and then expound in detail the baptismal creed of the Jerusalem church. The remaining five addresses were spoken to the newly-baptized in Easter week and explain the mysteries and ritual of baptism, confirmation and the Eucharist. These lectures are said to be "the first example of a popular compend of religion," and are particularly interesting for the insight which they give us both into the creed-forms of the early church and the various ceremonies of initiation constituting baptism in the 4th century. The evidence which Cyril supplies as to the



Jerusalem use is supplemented by the *S. Silviæ peregrinatio*, dating from about a generation later. Other tracts and homilies have been ascribed to Cyril of Jerusalem, but they are of doubtful genuineness.

EDITIONS.—A. A. Touttée (Paris, 1720); W. C. Reischl and J. Rupp (Munich, 1848–1860); Migne, *Patrol. Graeca*, xxxiii. Translation: *Catecheses* ("Oxford Library of Fathers," vol. ii.). See Herzog-Hauck, *Realencyk.* (Förster); Delacroix, *St. C. de Jérus., sa vie et ses œuvres* (Paris, 1865).

CYRIL (376–444), bishop of Alexandria, a more distinguished father of the church than his namesake of Jerusalem, was born in 376, and died in 444. Becoming patriarch of Alexandria about 412, he soon made himself known by the violence of his zeal against Jews, pagans and heretics or supposed heretics alike. He had hardly entered upon his office when he closed all the churches of the Novatians and seized their ecclesiastical effects. He assailed the Jewish synagogues with an armed force, drove the Jews in thousands from the city, and exposed their houses and property to pillage. The prefect of Egypt, Orestes, who endeavoured to withstand his furious zeal, was in turn denounced himself, and had difficulty in maintaining his ground against the fury of the Christian multitude. It was during one of the violent commotions kindled by the strifes of these parties in Alexandria that the illustrious Hypatia, famed for her beauty and her eloquent advocacy of the Neo-Platonic philosophy in opposition to Christianity, was murdered. Her murder has been attributed to the direct instigation of the patriarch himself; but this charge is held to be baseless by others, although there can be no doubt that "the perpetrators were officers of his church," and undoubtedly drew encouragement from his own violent proceedings. Hypatia was a friend of Orestes, and the hostility that existed betwixt the prefect and the patriarch overflowed towards her, and undoubtedly led to her destruction.

But Cyril's violence was not merely confined to those who might be considered enemies of the church. He inherited from Theophilus, his uncle and predecessor in the see of Alexandria, a strong aversion to John Chrysostom, the noble bishop of Constantinople, and even after his death opposed for a time all attempts to remove the unjust sentence of condemnation which had been passed upon him. Afterwards he so far yielded to remonstrances as to allow the name of Chrysostom to appear in the list of distinguished martyrs and bishops mentioned in the prayers of his church. These names were inserted in what were called "diptychs" (*δίπτυχα νεκρῶν*), or two-leaved tablets preserved in the churches—a usage which the Greek Church has continued to this day.

Cyril thus represents—though he differs largely from his predecessors—the tendencies dominant at Alexandria in the 5th century, and their antagonism to the Antiochene school. The story of his opposition to Nestorius at the council of Ephesus in 431 is told elsewhere (see NESTORIUS). He himself incurred the charge of heresy from the oriental bishops. Satisfied, however, with the deprivation and exile of his opponent, he returned to Alexandria in triumph as the great champion of the faith, and thence continued, by the "unscrupulous use of all the means at his command," the theological strife for years. He was a bitter opponent of the great Antiochene expositor and apologist Theodoret.

Altogether Cyril presents a character not only unamiable, but singularly deficient in the graces of the Christian life. His style of writing is as objectionable as his character and spirit. Yet he takes high rank as a dogmatic theologian, and those who seek precise and rigid definitions of orthodox belief conjoined with tenacity of conviction find him indispensable. In addition to his *Twelve Anathematisms* and the defence of the same, he wrote five other books against Nestorius, *Thesaurus*—a treatise in dialogue form on the Trinity, a book *On the Right Way* and another *On the Incarnation*. In other fields—mystical, exegetical and apologetical—he was equally prolific and forceful. He wrote a tract "On worshipping in spirit and in truth" to defend a spiritual interpretation of the Mosaic law, several commentaries, festival-orations, and a reply to the emperor Julian's attack

on the church. His letters are valuable sources to the student of the Nestorian controversy.

LITERATURE.—The collected edition of J. Aubert (Paris, 1638) formed the basis of Migne's reprint in vols. 68–77 of the *Patr. Graec.* Many of the writings have been edited separately (see bibliography in Herzog-Hauck). For an account of his career and position in the history of dogma, see A. Harnack, vols. iii. and iv. *passim*; O. Bardenhewer's *Patrologie* (Freiburg, 1894), pp. 335–343; R. L. Ottley's *Doctrine of the Incarnation*, ii. 80 ff.; A. Largent's *Études d'hist. ecclés.; St. Cyrille d'Alexandrie et le concile d'Éphèse* (Paris, 1892). See also Charles Kingsley's romance *Hypatia*.

CYRIL (827–869), apostle of the Slavs, amongst whom he worked in conjunction with his elder brother Methodius (*q.v.*). Tradition says that while in the Khazar country (where he combated Jewish and Mahomedan influence) he found at Kherson the remains of Clement of Rome, which he bore with him wherever he went, finally depositing them at Rome in 867. His name is associated with the invention of the modified (Cyrillic) form of the Greek alphabet, which largely superseded the ancient Slavonic characters.

CYRILLIC, the alphabet used by the Orthodox Slavs. It is modelled on the Greek Liturgical Uncial of the 9th century; and its invention is traditionally, though in all probability wrongly, ascribed to the Greek missionary Cyril (d. 869). For an account of its origin and development, with a table of its letters, see SLAVS.

CYRILLUS, Greek jurist of the 5th century, was professor in the ancient law college of Berytus, and one of the founders of the oecumenical school of jurists (*τῆς οἰκουμένης διδασκαλαί*) which preceded the succession of Anastasius to the Eastern empire (A.D. 491), and paved the way for Justinian's legislation. His reputation as a teacher of law was very great; and from the fragments of his works which have been preserved it may be inferred that his merit as a teacher consisted in his going direct to the ancient sources of law, and in interpreting the best writers, such as the commentary of Ulpian on the edict and the *Responsa Papiniani*. He wrote a treatise on definitions (*ὑπομνήματα τῶν δεφινιτῶν*), in which, according to a statement of his contemporary Patricius, the subject of contracts was treated with superior precision and great method, and which has supplied the materials for many important scholia appended to the first and second titles of the eleventh book of the *Basilica*. He is generally styled "the great," to distinguish him from a more modern jurist of the same name, who lived after the reign of Justinian, and who compiled an epitome of the *Digest*.

CYRTO-STYLE (Gr. *κυρτός*, convex, and *στύλος*, column), in architecture, a circular projecting portico with columns; like those of the transept entrances of St Paul's cathedral and the western entrance of St Mary-le-Strand, London.

CYRUS (Gr. *Κύρος*; Pers. *Kuru-sh*; BabyI. *Kurash*; Hebr. *Kōresh*), the Latinized form of a Persian name borne by two prominent members of the Achaemenid house.

1. CYRUS THE GREAT, the founder of the Persian empire, was the son of Cambyses I. His family belonged to the clan of the Achaemenidae—in the inscription on the pillars and columns of the palace of Pasargadae (Murghab) he says: "I am Cyrus the king, the Achaemenid"—the principal clan (*φφήτην*) of the Persian tribe of the Pasargadae (*q.v.*). But in his proclamation to the Babylonians (V.R. 35; Sir H. Rawlinson, *Journal of the R. Asiat. Soc.*, n.s., xii., 1880; Schrader, *Keilinschriftliche Bibliothek*, iii. 2, 120 ff.; Hagen, in Delitzsch and Haupt, *Beiträge zur Assyriologie*, ii., 1894, where the chronicle of Nabonidus is also published anew with a much improved translation) he calls his ancestors, Teispes, Cyrus I. and Cambyses I., "kings of Anshan," and the same title is given to him in the inscriptions and in the chronicle of Nabonidus of Babylon before his victory over Astyages. Anshan is a district of Elam or Susiana, the exact position of which is still subject to much discussion. As we know from Jeremiah xlix. 34 ff. (cf. Ezekiel xxxii. 24 ff.) that the Elamites suffered a heavy defeat in 596 B.C., it is very probable that the Pasargadian dynast Teispes conquered Anshan in this year. Modern authors have often supposed that Cyrus and his ancestors were in reality Elamites; but this

is contrary to all tradition; and there can be no doubt that Cyrus was a genuine Persian and a true believer in the Zoroastrian religion. In Herodotus vii. 11 the genealogy of Cyrus is given in exactly the same way as in the proclamation of Cyrus himself; Teispes is called here the son of the eponym Achaemenes.

The Pasargadian kings of Anshan were vassals of the Median empire. Their kingdom cannot have been of large extent, as Nabonidus in a contemporary inscription (Cylinder from Abu Habba, VR. 64, Schrader, *Keilinschriftl. Bibliothek*, iii. 2, 96), where he mentions his rebellion against Astyages, calls Cyrus "king of Anshan, his (*i.e.* Astyages') small servant (vassal)." From this inscription we learn that the rebellion of Cyrus (who seems to have become king in 558 B.C., as Herod. i. 214 gives him a reign of 29 years) began in 553 B.C., and from the annals that in 550 Astyages marched against Cyrus, but was defeated; his troops revolted against him, he was taken prisoner, and Cyrus occupied and plundered Ecbatana. The relation of Ctesias (preserved by Nic. Dam. fr. 66; Anaximenes of Lampsacus in Steph. Byz. s.v. Πασαργάδαι, Strabo xv. p. 729; Polyæn. vii. 6. 1, 9, 45. 2) that Cyrus was three times beaten by Astyages and that the decisive battle took place in the mountains of Pasargadae, is certainly in the main historical although Herodotus (i. 127 ff.) only mentions the treason of the Median general Harpagus and the defeat and captivity of Astyages. In the rebellion the Persian tribes of the Maraphians and Maspian joined the Pasargadae (Herod. i. 125), while the other tribes appear not to have acknowledged Cyrus till after his victory (see PERSIS). From then he calls himself "king of the Persians."

The history of Cyrus very soon became involved and quite overgrown with legends. Herodotus (i. 95) tells us that he knew four different traditions about him. One makes him the son of Mandane, a daughter of Astyages (originally evidently by a god); who is exposed in the mountains by his grandfather on account of an oracle, but suckled by a dog (a sacred animal of the Iranians) and educated by a shepherd; *i.e.* the myth which we know from the stories of Oedipus, Perseus, Telephus, Pallas and Neleus, Romulus, Sargon of Agade, Moses, the Indian hero Krishna, and many others, has been transferred to the founder of the Persian empire. At the same time, the rule of Cyrus and the Persians is legitimated by his family connexion with Astyages. This account is partly preserved in Justin i. 4. 10 (probably from Charon of Lampsacus) and in Aelian, *Var. Hist.* xiv. 42, and alluded to by Herodotus i. 95 and 122. The second account, which Herodotus follows, is a rationalized version of the first, where the dog is changed into a woman (the wife of the shepherd) named Spako (bitch). In the later part of his story Herodotus is dependent on the family traditions of Harpagus, whose treason is justified by the cruelty with which Astyages had treated him (the story of Atreus and Thyestes is transferred to them). Harpagus afterwards stood in high favour with Cyrus, and commanded the army which subdued the coasts of Asia Minor; his family seems to have been settled in Lycia. In a third version, preserved from Ctesias in Nicolaus Damasc. p. 66 (cf. Dinon *ap.* Athen. xiv. 633 C), Cyrus is the son of a poor Mardian bandit Atradates (the Mardians are a nomadic Persian tribe, Herod. i. 125), who comes as a voluntary slave to the court of Astyages, and finds favour with the king. A Chaldaean sage prophesies to him his future greatness, and another Persian slave, Oebares, becomes his associate. He flies to Persia, evades the pursuers whom Astyages sends after him, and begins the rebellion. After the victory Oebares kills Astyages against the will of Cyrus, and afterwards kills himself to evade the wrath of Cyrus. Parts of this story are preserved also in Strabo xv. p. 729, and Justin i. 6. 1-3; 7. 1; cf. Ctesias *ap.* Photium 2-7; many traces of it were afterwards transferred to the story of Ardashir I. (*q.v.*), the founder of the Sassanid empire. With this version Ctesias and Nicolaus have connected another, in which Cyrus is the son of a Persian shepherd who lives at Pasargadae, and fights the decisive battle at this place. The didactic novel of Xenophon, the *Cyropaedia*, is a free invention adapted to the purposes of the author, based upon the account of Herodotus and occasionally influenced by Ctesias,

without any independent traditional element. The account of Aeschylus, *Pers.* 765 ff., is a mixture of Greek traditions with a few oriental elements; here the first king is Medos (the Median empire); his nameless son is succeeded by Cyrus, a blessed ruler, beloved by the gods, who gave peace to all his friends and conquered Lydia, Phrygia, Ionia. Then comes his nameless son, then Mardos (*i.e.* Smerdis, to whom the name of the Mardians is transferred) who is killed by Artaphrenes (*i.e.* Artaphernes, Herod. iii. 78, one of the associates of Darius), then Maraphis (eponym of the Maraphian tribe), then another Artaphrenes, then Darius.

The principal events of the later history of Cyrus are in the main correctly stated by Herodotus, although his account contains many legendary traditions. The short excerpt from Ctesias, which Photius has preserved, contains useful information, although we must always mistrust him. Of great value are a short notice in the fragments of Berossus and another in the Old Testament. The original sources are very scanty, besides the cylinder containing his proclamation to the Babylonians we possess only a great many dated private documents from Babylon. These serve to fix the chronology, which is here as everywhere quite in accordance with the dates of the canon of Ptolemy.

Soon after the conquest of the Median empire, Cyrus was attacked by a coalition of the other powers of the East, Babylon, Egypt and Lydia, joined by Sparta, the greatest military power of Greece. In the spring of 546 Croesus of Lydia began the attack and advanced into Cappadocia, while the other powers were still gathering their troops. But Cyrus anticipated them; he defeated Croesus and followed him to his capital. In the autumn of 546 Sardis was taken and the Lydian kingdom became a province of the Persians. The famous story of Herodotus, that the conqueror condemned Croesus to the stake, from which he was saved by the intervention of the gods, is quite inconsistent with the Persian religion (see CROESUS).

During the next years the Persian army under Harpagus suppressed a rebellion of the Lydians under Pactyas, and subjugated the Ionian cities, the Carians and the Lycians (when the town Xanthus resisted to the utmost). The king of Cilicia (Syennesis) voluntarily acknowledged the Persian supremacy. Why the war with Babylon, which had become inevitable, was delayed until 539, we do not know. Here too Cyrus in a single campaign destroyed a mighty state. The army of Nabonidus was defeated; Babylon itself attempted no resistance, but surrendered on the 16th Tishri (10th of October) 539, to the Persian general Gobryas (*Gaubarwa*, see the chronicle of the reign of Nabonidus; the name Gobryas is preserved also by Xenophon, *Cyrop.* vii. 4. 24); it is possible that the Chaldaean priests, who were hostile to Nabonidus, betrayed the town. In a proclamation issued after his victory Cyrus guarantees life and property to all the inhabitants and designates himself as the favourite of Marduk, the great local god (Bel, Bel-Merodak) of Babel. It is very odd that modern authors have considered this proclamation as inconsistent with the Zoroastrian creed.

From the beginning of 538 Cyrus dates his years as "king of Babylon and king of the countries" (*i.e.* of the world). With the capital, the Babylonian provinces in Syria fell to the Persians; in 538 Cyrus granted to the Jews, whom Nebuchadrezzar had transported to Babylonia, the return to Palestine and the rebuilding of Jerusalem and its temple (see JEWS, § 19). It is probable that Cyrus had fought more than one war against the peoples of eastern Iran; according to Ctesias he had, before the war with Croesus, defeated the Bactrians and the Sacae (in Ferghana; their king Amorges is the eponym of the Amyrgian Sacae, Herod. vii. 64, called by Darius *Haumavarkā*); and the historians of Alexander mention a march through Gedrosia, where he lost his whole army but seven men (Arrian vi. 24. 2; Strabo xv. 722), a tribe Ariaspae on the Etymandros (in Sijistan), who, on account of the support which they gave him against the Scythians, were called Euergetae (Arrian iii. 27. 4; Diod. xvii. 81; Curt. vii. 3. 1), and a town Cyropolis, founded by him

on the Jaxartes (Arrian iv. 2. 3; Curt. vii. 6. 16; Strabo xi. 517, called Cyreskhata by Ptolem. vi. 12. 5). In 530, having appointed his son Cambyses king of Babel, he set out for a new expedition against the East. In this war he was killed (Herod.) or mortally wounded (Ctesias). According to Herodotus he attacked the Massagetae beyond the Jaxartes; according to Ctesias, the Derbices, a very barbarous tribe (cf. Strabo xi. 520; Aelian, *Var. Hist.* iv. 1) on the border of the Caspian, near the Hyrcanians (Strabo xi. 514; Steph. Byz.; Curt. vii. 2. 7; Dion. Perieg. 734 ff.; Pomp. Mela iii. 5), or on the Oxus (Plin. vi. 48; Ptolem. vi. 10. 2; *Tab. Peut.*). Berossus (*ap. Euseb. Chron.* i. 29) simply says that he fell against the Dahae, *i.e.* the nomads of the Turanian desert. His death occurred in 528 B.C., as we have a Babylonian tablet from the Adar of the tenth year of Cyrus, *i.e.* February 528; for in Babylon the first year of Cyrus began in the spring of 538.

In his native district Cyrus had built a city with a palace, called after his tribe Pasargadae (now Murghab), and here he was buried (see PASARGADAE). In a short time he, the petty prince of an almost unknown tribe, had founded a mighty empire, which extended from the Indus and Jaxartes to the Aegean and the borders of Egypt. This result shows that Cyrus must have been a great warrior and statesman. Nor is his character without nobility. He excels in the humanity with which he treated the vanquished. He destroyed no town nor did he put the captive kings to death; in Babylonia he behaved like a constitutional monarch; by the Persians his memory was cherished as "the father of the people" (Herod. iii. 89), and the Greek tradition preserved by Aeschylus (cf. above) shows that his greatness was acknowledged also by his enemies. He therefore deserves the homage which Xenophon paid to him in choosing him as hero for his didactic novel.

2. CYRUS THE YOUNGER, son of Darius II. and Parysatis, was born after the accession of his father in 424. When, after the victories of Alcibiades, Darius II. decided to continue the war against Athens and give strong support to the Spartans, he sent in 408 the young prince into Asia Minor, as satrap of Lydia and Phrygia Major with Cappadocia, and commander of the Persian troops, "which gather into the field of Castolos" (Xen. *Hell.* i. 4. 3; *Anab.* i. 9. 7), *i.e.* of the army of the district of Asia Minor. He gave strenuous support to the Spartans; evidently he had already then formed the design, in which he was supported by his mother, of gaining the throne for himself after the death of his father; he pretended to have stronger claims to it than his elder brother Artaxerxes, who was not born in the purple. For this plan he hoped to gain the assistance of Sparta. In the Spartan general Lysander he found a man who was willing to help him, as Lysander himself hoped to become absolute ruler of Greece by the aid of the Persian prince. So Cyrus put all his means at the disposal of Lysander in the Peloponnesian War, but denied them to his successor Callicratidas; by exerting his influence in Sparta, he brought it about that after the battle of Arginusae Lysander was sent out a second time as the real commander (though under a nominal chief) of the Spartan fleet in 405 (Xen. *Hell.* ii. 1. 14). At the same time Darius fell ill and called his son to his deathbed; Cyrus handed over all his treasures to Lysander and went to Susa. After the accession of Artaxerxes II. in 404, Tissaphernes denounced the plans of Cyrus against his brother (cf. Plut. *Artax.* 3); but by the intercession of Parysatis he was pardoned and sent back to his satrapy. Meanwhile Lysander had gained the battle of Aegospotami and Sparta was supreme in the Greek world. Cyrus managed very cleverly to gather a large army by beginning a quarrel with Tissaphernes, satrap of Caria, about the Ionian towns; he also pretended to prepare an expedition against the Pisidians, a mountainous tribe in the Taurus, which was never obedient to the Empire. Although the dominant position of Lysander had been broken in 403 by King Pausanias, the Spartan government gave him all the support which was possible without going into open war against the king; it caused a partisan of Lysander, Clearchus, condemned to death on account of atrocious crimes which he had committed as governor of Byzantium,

to gather an army of mercenaries on the Thracian Chersonesus, and in Thessaly Menon of Pharsalus, head of a party which was connected with Sparta, collected another army.

In the spring of 401 Cyrus united all his forces and advanced from Sardis, without announcing the object of his expedition. By dexterous management and large promises he overcame the scruples of the Greek troops against the length and danger of the war; a Spartan fleet of thirty-five triremes sent to Cilicia opened the passes of the Amanus into Syria and conveyed to him a Spartan detachment of 700 men under Cheirisophus. The king had only been warned at the last moment by Tissaphernes and gathered an army in all haste; Cyrus advanced into Babylonia, before he met with an enemy. Here ensued, in October 401, the battle of Cunaxa. Cyrus had 10,400 Greek hoplites and 2500 peltasts, and besides an Asiatic army under the command of Ariaeus, for which Xenophon gives the absurd number of 100,000 men; the army of Artaxerxes he puts down at 900,000. These numbers only show that he, although an eyewitness, has no idea of large numbers; in reality the army of Cyrus may at the very utmost have consisted of 30,000, that of Artaxerxes of 40,000 men. Cyrus saw that the decision depended on the fate of the king; he therefore wanted Clearchus, the commander of the Greeks, to take the centre against Artaxerxes. But Clearchus, a tactician of the old school, disobeyed. The left wing of the Persians under Tissaphernes avoided a serious conflict with the Greeks; Cyrus in the centre threw himself upon Artaxerxes, but was slain in a desperate struggle. Afterwards Artaxerxes pretended to have killed the rebel himself, with the result that Parysatis took cruel vengeance upon the slayer of her favourite son. The Persian troops dared not attack the Greeks, but decoyed them into the interior, beyond the Tigris, and tried to annihilate them by treachery. But after their commanders had been taken prisoners the Greeks forced their way to the Black Sea. By this achievement they had demonstrated the internal weakness of the Persian empire and the absolute superiority of the Greek arms.

The history of Cyrus and of the retreat of the Greeks is told by Xenophon in his *Anabasis* (where he tries to veil the actual participation of the Spartans). Another account, probably from Sophocletus of Stymphalus, was used by Ephorus, and is preserved in Diodor. xiv. 19 ff. Further information is contained in the excerpts from Ctesias by Photius; cf. also Plutarch's life of Artaxerxes. The character of Cyrus is highly praised by the ancients, especially by Xenophon (cf. also his *Oeconomicus*, c. iv.); and certainly he was much superior to his weak brother in energy and as a general and statesman. If he had ascended the throne he might have regenerated the empire for a while, whereas it utterly decayed under the rule of Artaxerxes II. (See also PERSIA: *Ancient History*.) (E. M.)

**CYSTOFLAGELLATA** (so named by E. Haeckel), a group of Mastigophorous Protozoa, distinguished from Flagellata by their large size (0.15–1.5 mm.), and their branched endoplasm, recalling that of *Trachelius* among Infusoria, within a firm ectosarc bounded by a strong cuticle. Nutrition is holozoic, a deep groove leading down to a mouth and pharynx. A long fine flagellum arises from the pharynx in *Noctiluca* (E. Suriray) *Leptodiscus* and (R. Hertwig); and in the former genus, a second flagellum, thick, long and transversely striated, rises farther out, in the groove; this was likened by E. R. Lankester to a proboscis, whence his name of Rhynchoflagellata, which we discard as unnecessary and posterior to Haeckel's. *Noctiluca* has thus the form of an apple with a long stalk. *Leptodiscus* (R. Hertwig) has the form of a medusa without a proboscis—it is menisciform with the thin contractile margin produced inwards like a velum on the concave side, while the mouth is on the convex surface and the single flagellum springs from a blind tube on the same surface. *Craspedotella* (C. A. Kofoid), the third genus, is still more medusiform, with a broad velum, and the mouth in a convex central protrusion of the roof of the bell; and a thick flagellum springs from a blind tube on the convex surface. All three genera are pelagic and phosphorescent, this property being seated in the ectoplasm; *Noctiluca miliaris* is indeed the chief source of the phosphorescence of our summer seas. O. Bütschli, like other writers, regards the Cystoflagellates as closely allied to the Dinoflagellates, the small flagellum

corresponding to the longitudinal, the large flagellum to the transverse flagellum of that group.

The reproduction of *Noctiluca* has been fairly made out; in the adult state it divides by fission down the oral groove; as a preliminary the external differentiations disappear, and the nucleus divides by modified mitosis; then the external organs are regenerated. Under circumstances not well made out,

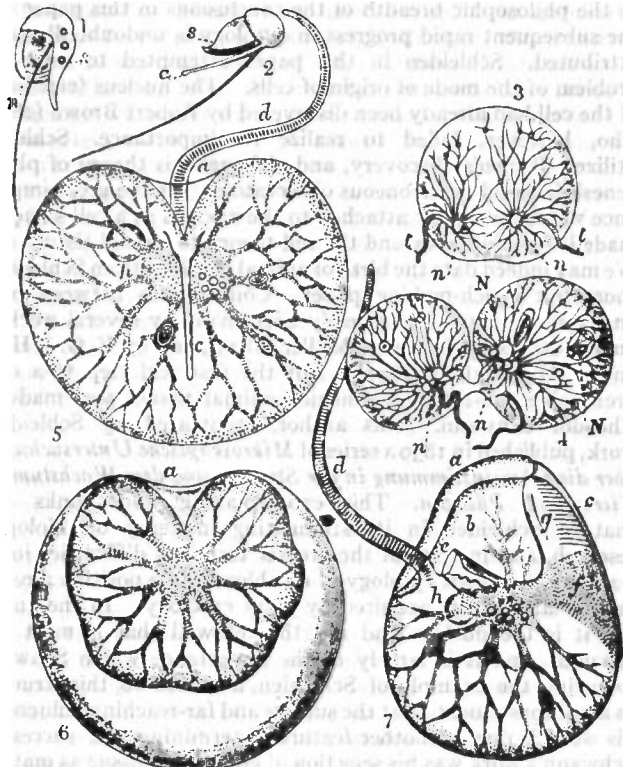

After E. Ray Lankester, *Ency. Brit.*, 9th ed.

#### Cystoflagellate Protozoa.

1 and 2. Young stages of *Noctiluca miliaris*.

a, the big flagellum; the unlettered filament becomes the oral flagellum of the adult.

n, nucleus.

s, the so-called spine (superficial ridge of the adult).

3 and 4. Two stages in the fission of *Noctiluca miliaris*, Suriray.

n, nucleus.

N, food-particles.

t, muscular flagellum.

5. *Noctiluca miliaris*, viewed from the aboral side (after Allman, *Quart. Jour. Mic. Sci.*, 1872).

a, entrance to atrium or flagellar fossa (=longitudinal groove of *Dinoflagellata*).

c, superficial ridge.

d, big flagellum (=flagellum of transverse groove of *Dinoflagellata*).

h, nucleus.

6. *Noctiluca miliaris*, acted upon by iodine solution, showing the protoplasm shrunk away from the structureless pellicle.

a=entrance to atrium.

7. Lateral view of *Noctiluca miliaris*.

a, entrance to atrium.

b, atrium.

c, superficial ridge.

d, big flagellum.

e=mouth and gullet, in which is seen Krohn's oral flagellum (=the chief flagellum, or flagellum of the longitudinal groove of *Dinoflagellata*).

f, broad process of protoplasm extending from the superficial ridge c to the central protoplasm.

g, duplicature of pellicle in connexion with superficial ridge.

h, nucleus.

conjugation between two adults takes place by their fusion commencing at the oral region; flagella and pharynx disappear and the nuclei fuse, while the cytoplasm condense into a sphere. The nucleus undergoes broad division, the young nuclei pass to the surface, which becomes imperfectly divided by grooves into as many rounded prominences as there are nuclei (up to 128 or 256); and these become constricted off from the residual useless cytoplasm as zoospores with two unequal flagella, which were at first regarded as *Dinoflagellates*, of which they have

the form (figs. 5, 6). The metamorphosis of these has not yet been observed.

LITERATURE.—E. Suriray, *Magasin de zoologie*, 1836; G. J. Allman, *Quarterly Journal of Microscopic Science*, n.s. xii., 1872; L. Cienkowski, "Zoospore formation in *Noctiluca*," *Archiv f. mikroskopische Anatomie*, vii., 1871; R. Hertwig, "Leptodiscus," *Jenaische Zeitschrift*, xi., 1877; C. Ischikawa, *Journal of the College of Science* (Tokyo, 1894), xii., 1899; F. Doflein, "Conjugation of *Noctiluca*," *Zoologische Jahrbücher, Anatomie*, xiv., 1900; C. A. Kofoid, "Craspedotella," in *Bull. Mus. Comp. Zool. Harvard*, xlvi., 1905; O. Bütschli, "Mastigophora," in *Protozoa (Braun's Tierreich, vol. i., Protozoa)* (1883-1887). (M. H.A.)

**CYSTOLITH** (Gr. *κβος*, cavity, and *λίθος*, stone), a botanical term for the inorganic concretions, usually of calcium carbonate, formed in a cellulose matrix in special cells, generally in the leaf of plants of certain families, e. g. *Ficus elastica*, the india-rubber plant.

**CYTHERA** (mod. *Cerigo*, but still officially known as *Cythera*), one of the Ionian islands, situated not less than 150 m. from Zante, but only about 8 m. from Cape Malea on the southern coast of Greece. Its length from N. to S. is nearly 20 m., and its greatest breadth about 12; its area is 114 sq. m. The surface is rocky and broken, but streams abound, and there are various parts of considerable fertility. Two caves of imposing dimensions, and adorned with stalactites of great beauty, are the most notable among its natural peculiarities; one is situated at the seaward end of the glen of the Mylopotamus, and the other, named Santa Sophia, about two hours' ride from Capsali (Kapsali). Less of the ground is cultivated and more of it is in pasture land than in any other of the seven islands. Some wine and corn are produced, and the quality of the olive oil is good. The honey is still highly prized, as it was in remote antiquity; and a considerable quantity of cheese is manufactured from the milk of the goat. Salt, flax, cotton and currants are also mentioned among the produce. The people are industrious, and many of them seek employment as labourers in the Morea and Asia Minor. Owing to emigration, the population appears to be steadily diminishing, and is now only about 6000, or less than half what it was in 1857. Unfortunately the island has hardly a regular harbour on any part of the coast; from its situation at the meeting, as it were, of seas, the currents in the neighbourhood are strong, and storms are very frequent. The best anchorage is at San Nicolo, at the middle of the eastern side of the island. The principal village is Capsali, a place of about 1500 inhabitants, at the southern extremity, with a bishop, and several convents and churches; the lesser hamlets are Modari, Potamo and San Nicolo.

There are comparatively few traces of antiquity, and the identification of the ancient cities has been disputed. The capital, which bore the same name as the island, was at Paleokastro, about 3 m. from the present port of Avlemona. In the church of St Kosmas are preserved some of the archaic Doric columns of the famous temple of Aphrodite of Cythera, whose worship had been introduced from Syria, and ultimately spread over Greece. According to the accepted story, it was here that the goddess first landed when she emerged from the sea. At a very early date *Cythera* was the seat of a Phoenician settlement, established in connexion with the purple fishery of the neighbouring coast; it is said that it was therefore called *Porphyris* (cf. Pliny iv. 18, 19). For a time dependent on Argos, it became afterwards an important possession of the Spartans, who annually despatched a governor named the *Cytherodices*. In the Peloponnesian war, Nicias occupied the island, but in 421 it was recovered by Sparta. Its modern history has been very much the same as that of the other Ionian islands; but it was subject to Venice for a much shorter period—from 1717 to 1797.

See the works referred to under *CEPHALONIA*, and also Weil, in *Mittheil. d. deutsch. Inst. zu Athen* (1880), pp. 224-243.

**CYTISINE** (*Ulexin*, *Sophorin*),  $C_{11}H_{14}N_2O$ , an alkaloid discovered in 1818 by J. B. Chevreul in the seeds of laburnum (*Cytisus Laburnum*) and isolated by A. Husemann and W. Marmé in 1865 (*Zeit. f. Chemie*, 1865, i. p. 161). It is also found in the seeds of furze (*Ulex europæus*), *Sophora tormentosa*, and *Euchresta horsfieldii*. It is extracted from the seeds by an

alcoholic solution of acetic acid, and forms large crystals which melt at 153° C., and are easily soluble in water, alcohol and chloroform. It is a secondary and tertiary di-acid base, and is strongly alkaline in its reaction. Hydrogen peroxide oxidizes it to oxycytisine,  $C_{11}H_{14}N_2O_2$ , chromic acid to an acid,  $C_{11}H_9NO_3$ , and potassium permanganate to oxalic acid and ammonia. It acts as a violent poison.

See further, P. C. Plugge, *Arch. der Pharm.* (1891), 229, p. 48 et seq.; A. Partheil, *Ber.* (1890), 23, p. 3201, *Arch. der Pharm.* (1892), 230, p. 448; M. Freund and A. Friedmann, *Ber.* (1901), 34, p. 615; and J. Herzig and H. Meyer, *Monats. f. Chem.* (1897), 18, p. 379.

**CYTOLOGY** (from *kytos*, a hollow vessel, and *logos*, science), the scientific study of the "cells" or living units of protoplasm (*q.v.*), of which plants and animals are composed. All the higher, and the great majority of the lower, plants and animals are composed of a vast number of these vital units or "cells." In the case of many microscopic forms, however, the entire organism, plant or animal, consists throughout life of a single cell. Familiar examples of these "unicellular" forms are Bacteria and Diatoms among the plants, and Foraminifera and Infusoria among the animals. In all cases, however, whether the cell-unit lives freely as a unicellular organism or forms an integral part of a multicellular individual, it exhibits in itself all the phenomena characteristic of living things. Each cell assimilates food material, whether this is obtained by its own activity, as in the majority of the protozoa, or is brought, as it were, to its own door by the blood stream, as in the higher Metazoa, and builds this food material into its own substance, a process accompanied by respiration and excretion and resulting in growth. Each cell exhibits in greater or less degree "irritability," or the power of responding to stimuli; and finally each cell, at some time in its life, is capable of reproduction. It is evident therefore that in the multicellular forms all the complex manifestations of life are but the outcome of the co-ordinated activities of the constituent cells. The latter are indeed, as Virchow has termed them, "vital units." It is therefore in these vital units that the explanation of vital phenomena must be sought (see **PHYSIOLOGY**). As Verworn<sup>1</sup> said, "It is to the cell that the study of every bodily function sooner or later drives us. In the muscle cell lies the problem of the heart beat and that of muscular contraction; in the gland cell reside the causes of secretion; in the epithelial cell, in the white blood corpuscle, lies the problem of the absorption of food, and the secrets of the mind are hidden in the ganglion cell." So also the problems of development and inheritance have shown themselves to be cell problems, while the study of disease has produced a "cellular pathology." The most important problems awaiting solution in biology are cell problems.

**Historical.**—The cell-theory ranks with the evolution theory in the far-reaching influence it has exerted on the growth of modern biology; and although almost entirely a product of the 19th century, the history of its development gives place, in point of interest, to that of no other general conception. The cell-theory—in a form, however, very different from that in which we now know it—was originally suggested by the study of plant structure; and the first steps to the formulation, many years later, of a definite cell-theory, were made as early as the later part of the 17th century by Robert Hooke, Marcello Malpighi and Nehemiah Grew. Hooke (1665) noted and described the vesicular nature of cork and similar vegetable substances, and designated the cavities by the term "cells." A few years later Malpighi (1674) and Grew (1682), still of course working with the low power lenses alone available at that time, gave a more detailed description of the finer structure of plant tissue. They showed that it consisted in part of little cell-like cavities, provided with firm cell-walls and filled with fluid, and in part of long tube-like vessels. A long time passed before the next important step forward was made by C. L. Treviranus,<sup>2</sup> who, working on the growing parts of young plants, showed that the tubes and vessels of Malpighi and Grew arose from cells by the

latter becoming elongated and attached end to end, the intervening walls breaking down; a conclusion afterwards confirmed by Hugo von Mohl (1830). It was not, however, until the appearance of Matthias Jakob Schleiden's paper *Beiträge zur Phyto-genesis* (1838) that we have a really comprehensive treatment of the cell, and the formulation of a definite cell-theory for plants. It is to the wealth of correlated observations and to the philosophic breadth of the conclusions in this paper that the subsequent rapid progress in cytology is undoubtedly to be attributed. Schleiden in this paper attempted to solve the problem of the mode of origin of cells. The nucleus (*vide infra*) of the cell had already been discovered by Robert Brown (1831), who, however, failed to realize its importance. Schleiden utilized Brown's discovery, and although his theory of phyto-genesis is based on erroneous observations, yet the great importance which he rightly attached to the nucleus as a cell-structure made it possible to extend the cell-theory to animal tissues also. We may indeed date the birth of animal cytology from Schleiden's short but epoch-making paper. Comparisons between plant and animal tissues had already been made by several workers, among others by Johannes Müller (1835), and by F. G. J. Henle and J. E. Purkinje (1837). But the first real step to a comprehensive cell-theory to include animal tissues was made by Theodor Schwann. This author, stimulated by Schleiden's work, published in 1839 a series of *Mikroskopische Untersuchungen über die Übereinstimmung in der Structur und dem Wachstum der Tiere und Pflanzen*. This epoch-making work ranks with that of Schleiden in its stimulating influence on biological research, and in spite of the greater technical difficulties in the way, raised animal cytology at one blow to the position already, and so laboriously, acquired by plant cytology. In the animal cell it is the nucleus and not the cell-wall that is most conspicuous, and it is largely to the importance which Schwann, following the example of Schleiden, attached to this structure as a cell constituent, that the success and far-reaching influence of his work is due. Another feature determining the success of Schwann's work was his selection of embryonic tissue as material for investigation. He showed that in the embryo the cells all closely resemble one another, only becoming later converted into the tissue elements—nerve cells, muscle cells and so forth—as development proceeded; just as a similar mode of investigation had enabled Treviranus to trace the origin from typical cells of the vascular tissue in plants more than 30 years previously. And just as Treviranus showed that there was a union of cells to form the vessels in plants, so Schwann now showed that a union of cells frequently occurred in the formation of animal tissues.

So great was the stimulus given to cytological research by the work of Schleiden and Schwann that these authors are often referred to as the founders of the cell-theory. Their theory, however, differed very greatly from that of the present time. Not only did they suppose new cells to arise by a sort of "crystallization" from a formative "mother liquor" or "cytoblastema" (*vide infra*), but they both defined the cell as a "vesicle" provided with a firm cell-wall and with fluid contents. The cell-wall was regarded as the essential cell-structure, which by its own peculiar properties controlled the cell-processes. The work of Schleiden and Schwann marks the close of the first period in the history of the cell-theory—the period dominated by the cell-wall. The subsequent history is marked by the gradual recognition of the importance of the cell-contents. Schleiden had noticed in the plant cell a finely granular substance which he termed "plant slime" (*Pflanzenschleim*). In 1846 Hugo von Mohl applied to this substance the term "protoplasm"; a term already used by Purkinje six years previously for the formative substance of young animal embryos. Mohl showed that the young plant cell was at first completely filled by the protoplasm, and that only later, by the gradual accumulation of vacuoles in the interior, did this substance come to form a thin layer on the inner surface of the cell-wall. Mohl also described the spontaneous movement of the protoplasm, a phenomenon already noted by Schleiden for his plant slime, and originally discovered by Bonaventura Corti in 1772 for the cells of *Chara*, and rediscovered in 1807

<sup>1</sup> *Allgemeine Physiologie*, p. 53 (1895).

<sup>2</sup> *Vom inwendigen Bau der Gewächse* (1806).



by Treviranus. Not only was attention thus gradually directed to the importance of the cell-contents, but observations were not lacking, even in the plant kingdom, tending to weaken the importance hitherto attached to the cell-wall. Among these may be mentioned Cohn's observation that in the reproduction of Algal forms the protoplasm contracts away from the cell-wall and escapes as a naked "swarm spore." Similarly in the animal kingdom instances began to be noted in which no membrane appeared to be present (Kolliker, 1845; Bischoff, 1842), and for some time it was hotly debated whether these structures could be regarded as true cells. As a result of the resemblance between the streaming movements in these apparently naked cells (e.g. lymphocytes) and those seen in plant cells, R. Remak was led (1852-1853) to apply Möhl's term "protoplasm" to the substance of these animal cells also. Similarly Max Schultze (1863) and H. A. de Bary (1859), as a result of the study of unicellular animals, came to the conclusion that the substance of these organisms, originally termed "Sarcode" by F. Dujardin, was identical with that of the plant and animal cell. Numerous workers now began to realize the subordinate position of the cell-wall (e.g. Nägeli, Alexander Braun, Leydig, Kolliker, Cohn, de Bary, &c.), but it is to Max Schultze above all that the credit is due for having laid the foundation of the modern conception of the cell—a conception often referred to as the *proto-plasmic*-theory in opposition to the cell-theory of Schleiden and Schwann. Max Schultze showed that one and the same substance, protoplasm, occurred in unicellular forms and in the higher plants and animals; that in plants this substance, though usually enclosed within a cell membrane, was sometimes naked (e.g. swarm spores), while in many animal tissues and in many of the unicellular forms the cell-membrane was always absent. He therefore concluded that in all cases the cell-membrane was unessential, and he redefined the "cell" of Schleiden and Schwann as "a small mass of protoplasm endowed with the attributes of life" (1861). In the same year the physiologist Brücke maintained that the complexity of vital phenomena necessitated the assumption for the cell-protoplasm itself of a complex structure, only invisible because of the limitations of our methods of observation. The cell in fact was to be regarded as being itself an "elementary organism." By this time too it was realized that the formation of cells *de novo*, postulated by Schleiden's theory of "phytogenesis," did not occur. Cells only arose by the division of pre-existing cells,—as Virchow neatly expressed it in his since famous aphorism, *omnis cellula e cellula*. It was, however, many years before the details of this "cell-division" were laid bare (see *Cell-Division* below).

*General Morphology of the Cell.*—In its simplest form the cell is a more or less spherical mass of viscid, translucent and granular protoplasm. In addition to the living protoplasm there is present in the cell food-material in various stages of assimilation, which usually presents the appearance of fine granules or spherules suspended in the more or less alveolar or reticular mesh-work of the living protoplasm. In addition there may be more or less obvious accumulations of waste material, pigment, oil drops, &c.—products of the cell's metabolic activity. All these relatively passive inclusions<sup>1</sup> are distinguished from the living protoplasm by the term "metaplasm" (Hanstein), or "paraplasm" (Kupffer), although in practice no very sharp distinction can be drawn between them. The cell is frequently, but by no means always, bounded by a cell-wall of greater or less thickness. In plants this cell-wall consists of cellulose, a substance closely allied to starch; in animals only very rarely is this the case. Usually the cell-wall, when this is present, is a product of the cell's secretive activity; sometimes, however, it appears to be formed by an actual conversion of the surface layer of the protoplasm, and retains the power of growth by "intussusception" like the rest of the protoplasm. Even when a limiting membrane is present, however, evidence is steadily accumulating to show that the cell is not an isolated physiological unit, but that, in the vast majority of cases, there is a proto-

<sup>1</sup> The Chromoplastids of the vegetable cell come under a different category of cell-inclusions; see PLANTS: *Cytology*.

plasmic continuity between the cells of the organism. This continuity, which is effected by fine protoplasmic threads ("cell-bridges") piercing the cell-wall and bridging the inter-cellular spaces when these are present, is to be regarded as the morphological expression of the physiological interdependence of the various—often widely separated—tissues of the body.<sup>2</sup> It is probable that it is the specialization of this primitive condition which has produced the cell-elements of the nervous system. In many cases the cell-connexions are so extensive as to obliterate cell-boundaries. A good example of such a "syncytial" tissue is provided by the heart muscle of Vertebrates and the intestinal musculature of Insects (Webber).<sup>3</sup>

In all multicellular, and in the great majority of unicellular, organisms the protoplasm of the cell-unit is differentiated into two very distinct regions,—a more or less central region, the *nucleus*, and a peripheral region (usually much more extensive), the cell-body or *cytoplasm*. This universal morphological differentiation of the cell-protoplasm is accompanied by corresponding chemical differences, and is the expression of a physiological division of labour of fundamental importance. In some of the simpler unicellular organisms, e.g. *Tetramitus*, the differentiated protoplasm is not segregated. Such forms are said to have a "distributed" nucleus, and among the Protozoa correspond to Haeckel's "Protista." It is probable that among plants the Bacteria and Cyanophyceae have a similar distributed nucleus. In all the higher forms, however, the segregation is well marked, and a "nuclear membrane" separates the substance of the nucleus, or "karyoplasm"<sup>4</sup> from the surrounding "cytoplasm." Within the nuclear membrane the karyoplasm is differentiated into two very distinct portions, a clear fluid portion, the "karyolymph," and a firmer portion in the form of a coarser or finer "nuclear reticulum." This latter is again composed of two parts, the "linin reticulum,"<sup>5</sup> and, embedded in the latter and often irregularly aggregated at its nodal points, a granular substance, the "chromatin,"<sup>6</sup> the latter being the essential constituent of the nucleus. In addition to the chromatin there may be present in the nucleus one or more, usually spherical, and as yet somewhat enigmatical bodies, the "nucleoli." In addition to the nucleus and cytoplasm, a third body, the "centrosome," has often been considered as a constant cell-structure. It is a minute granule, usually lying in the cytoplasm not far from the nucleus, and plays an important part in cell-division and fertilization (see below).

*Cell-differentiation.*—Both among unicellular and multicellular individuals the cell assumes the most varied forms and performs the most diverse functions. In all cases, however, whether we examine the free-living shapeless and slowly creeping *Amoeba*, or the striped muscle cell or spermatozoon of the Metazoa (fig. 1, *b* and *c*), the constant recurrence of cytoplasm and nucleus show that we have to deal in each case with a cell. The variation in the form and structure of the cell is an expression of that universal economic law of nature, "division of labour," with its almost invariable accompanying "morphological differentiation"; the earliest and most fundamental example being in the differentiation of the cell-protoplasm into cytoplasm and nucleus. In multicellular individuals the division of labour to which the structural complexity of the organism is due is between the individual cell-units, some cells developing one

<sup>2</sup> Cf. Pfeffer's classical experiments on the physiological significance of cell-continuity in plant tissues (*Über den Einfluss des Zellkerns auf die Bildung der Zellhaut*, 1896). The recent work in physiology on the influence substances secreted by certain tissues and circulating in the blood-stream exert upon other and widely different tissues, should not be lost sight of in this connexion.

<sup>3</sup> The influence this protoplasmic continuity may have upon our conception of the cell as a unit of organization is referred to below, (*Present Position of the Cell-theory*).

<sup>4</sup> A term (from *κάρων*, kernel) suggested by Flemming to replace Strasburger's hybrid term "nucleoplasm" (1882). The earlier workers, e.g. Leydig, Schultze, Brücke, de Bary, &c., restricted the term protoplasm to the cell-body—the "Cytoplasm" of Strasburger, an example still followed by O. Hertwig.

<sup>5</sup> From *linum*, a thread, Schwarz, 1887.

<sup>6</sup> From *χρῶμα*, colour, Flemming, 1879.

aspect, some another, of their vital attributes. Thus one cell specializes in, say, secretion, another in contractility, another in receiving and carrying stimuli, and so forth, so that we have the gland cell, the muscle cell, and the nerve cell, each appropriately grouped with its fellows to constitute the particular tissue or organ—gland, muscle or brain—which has for its function that of its constituent cells. In unicellular animals we also find division of labour and its accompanying morphological differentiation, but here there is no subdivision of the protoplasm of the organism into the semi-autonomous units which so greatly facilitate division of labour in the Metazoa; instead, division of labour must be between different regions of protoplasm in the single cell. The sharply defined character of this regional differentiation in the Protozoa, and the surprising structural complexity it may produce, sufficiently clearly show that although multicellular structure has greatly facilitated regional differentiation in the Metazoa, it is by no means essential to this process (see below, *Present Position of the Cell-theory*).

It is not within the scope of this article to attempt a comprehensive review of the variety in structural complexity to which this division of labour among the cells of the Metazoan and the regional differentiation of the cell-bodies of the Protozoa has given rise. Some indication of the wealth of variety may be best given by taking a general survey of cell-modifications, grouped according to the cell-attributes the expression of which they facilitate.

(a) *Structural Complexity facilitating Movement*.—One of the most striking, and hence earliest described, of the fundamental attributes of protoplasm is its power of spontaneous movement. This is seen in the walled cell of plant tissue and in

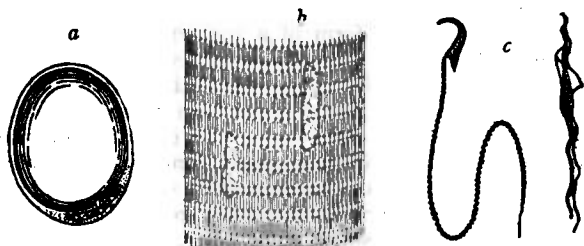

a and b from Schäfer's *Essentials of Histology*, by permission of Longmans, Green & Co. FIG. 1.—Types of Cells. a, Fat-cell enclosing a huge fat-globule. b, Part of a Mammalian "striated" muscle-cell (diagrammatic). c, Spermatozoa of mouse and bird.

the naked cell-body of *Amoeba*. In the latter case the streaming movements of the naked protoplasm are accompanied by the formation of "pseudopodia," and result in the highly characteristic "amoeboid" creeping movement of this and similar organisms (e.g. lymph corpuscles of the blood).<sup>1</sup> In these examples the whole protoplasm participates in the movement,—there has been no division of labour, and there is, therefore, no visible morphological differentiation. In many cells, movement (either of the entire body or of the surrounding medium) is by means of slender whip-like processes of the protoplasm flagella or cilia. These represent modified pseudopodia, and in the formation of the motile gametes of some of the lower forms, e.g. Myxomycetes (de Bary, 1859), Rhizopods (R. Hertwig, 1874), &c., the actual conversion of a pseudopodium into a flagellum can be witnessed. These vibratile processes may be either one or few in number, and are then large in size and move independently of one another; or they may be very numerous, covering the free surface of the cell (fig. 2, a); they are then very small and move strictly in unison. In the former case they are termed "flagella," in the latter "cilia." In some cases the flagellum is accompanied by an undulating membrane (e.g. Trypanosoma among the protozoa and in many spermatozoa), and it may be situated either at the front end (*Euglena*) or hind end (spermatozoa) of the body during motion. The cilia may form a

<sup>1</sup> The formation of pseudopodia and accompanying changes in form of *Amoeba* were observed as early as 1755 by Raesel von Rosenhof, who named it on this account the "little Proteus."

uniform coating to the free surface of the cell, as in ciliated epithelium (fig. 2, a) and many infusoria, or the cilia may be variously modified and restricted to special regions of the body, e.g. the "undulating membrane" of the peristomial region in many infusoria, the swimming combs of the Ctenophora (q.v.),

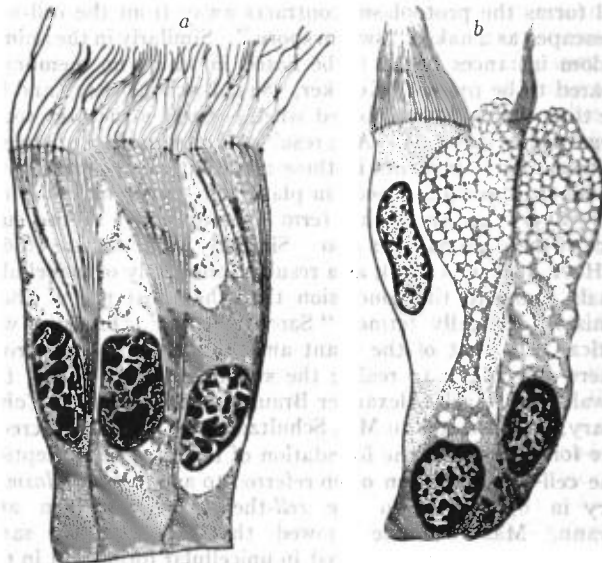

From A. Gurwitsch, *Morphologie und Biologie der Zelle*, by permission of Gustav Fischer.

FIG. 2.—Types of Cells. a, Ciliated epithelial cells. (After Heidenhain.) b, Mucus-secreting "goblet"-cells. (After Gurwitsch.)

and the flame cells of the Platyelmia (q.v.). In one group of infusoria (*Hypotricha*), the cilia, "cirri," have attained a high degree of differentiation, and reach a considerable size. Both cilia and flagella spring directly from the cell-protoplasm, piercing the cell-membrane, when this is present. At the point where they become continuous with the cell-body there is usually a deeply staining "basal granule." In some cases the flagella are in direct connexion with the centrosome (see below, *Cell-division*), e.g. Trypanosoma and spermatozoa, in some cases even while the centrosome is functioning in mitosis (e.g. insect spermatogenesis, Henneguy<sup>2</sup> and Meves<sup>3</sup> (fig. 3).

In the ability of *Amoeba* to contract into a spherical mass, and in the presence in its protoplasm of the contractile vacuole, we see another type of spontaneous movement—contractility—of the protoplasm. In the "musculo-epithelial" cells of *Hydra*,

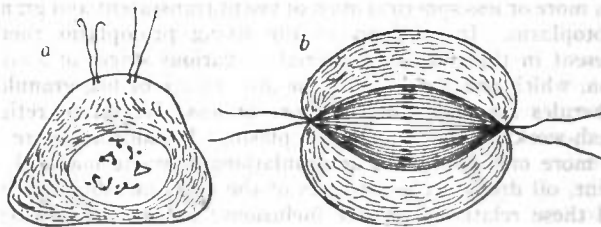

From O. Hertwig, *Allgemeine Biologie*, by permission of Gustav Fischer.

FIG. 3.—Spermatozoa of *Bombyx mori*, showing the precocious appearance of the spermatozoon flagellum and its relation to the centrosome. (After Henneguy.)

the elongated basal portion of the cell alone possesses this contractility. In the higher Metazoa the whole cell—muscle cell—is specialized for contractility, and shows, as a result of its specialization, a distinct fibrillation. This fibrillation is foreshadowed in the contractile regions of many Protozoa, e.g.

<sup>2</sup> "Sur les rapports des cils vibratiles avec les centrosomes," *Archives d'anatomie microscopique* (1898).

<sup>3</sup> "Über Zentralkörper in männlichen Geschlechtszellen von Schmetterlingen" (*Anat. Anz.* Bd. xiv., 1897). Cf. also the papers of Lenhossek (*Über Flimmerzellen*, 1898), Karl Peter (*Das Zentrum für die Flimm- und Giesselbewegung*, 1899) and Verworn (*Studien zur Physiologie der Flimmerbewegung*, 1899).

in the cirri of hypotrichous Infusoria, the tentacle of *Noctiluca*, and the myophane layer of Gregarines. In the quickly contracting muscle cell of Vertebrates and insects, further specialization has produced a structure of considerable complexity (fig. 1, b). Here also the cell is fibrillated, but the fibrillae (sarco-styles) are much more distinct, and are segmented in a manner which gives to the entire cell a "cross striated" appearance. Since quick movement is usually (but not always) associated with voluntary control, these striated muscle cells are often termed "voluntary" muscle fibres. The great increase in length of these cells is accompanied by the fragmentation of the originally single nucleus.

(b) *Cell-modification in Relation to Secretion.*—Just as the complex movements considered above were the result of a great development of the power of spontaneous movement possessed by all protoplasm, so cell-secretion is the result of a development of the metabolic processes underlying all vital phenomena. But whereas specialization of the protoplasm for movement resulted in a very obvious morphological complexity, specialization for secretion results in molecular complexity, and only rarely and indirectly results in morphological differentiation. Usually indeed the specialization is only rendered evident by the appearance of the formed secretion, e.g. mucus-secreting epithelial cells (fig. 2, b), the ovarian ovum and the fat cell (fig. 1, a). In some cases a distinct fibrillation of the cytoplasm accompanies or precedes the appearance of the cell-secretion (Mathews, pancreas cell of Amphibia). In many cases the internal secretion is no mere accumulation, e.g. the internal skeleton of the Radiolaria, and the nematocysts of the Coelentera. Frequently in animal tissues the cell-secretions are accumulated in the intercellular spaces, and result in the formation of the various "connective tissues," all of which are characterized by the immense amount of intercellular substance, e.g. fibrous tissue, cartilage and bone. Cell-modifications facilitating the general metabolism, but not necessarily indicating specialized secretion, also occur, e.g. the "gullet" of many Protozoa, the suctorial tubules of the Acinetaria, and the "nutritive processes" of the ovarian ova in many Lepidoptera. Mention may be made here of the network or canal system of the cytoplasm, described for many cells by Golgi, Holgren and others. An enigmatical structure, the "yolk-nucleus" of many ova, has been frequently regarded as a structure of considerable metabolic importance, e.g. Bambeck (1898) for *Pholcus*.<sup>1</sup>

Striking modifications resulting from specialization in secretion are frequently presented by the nucleus. In many secreting

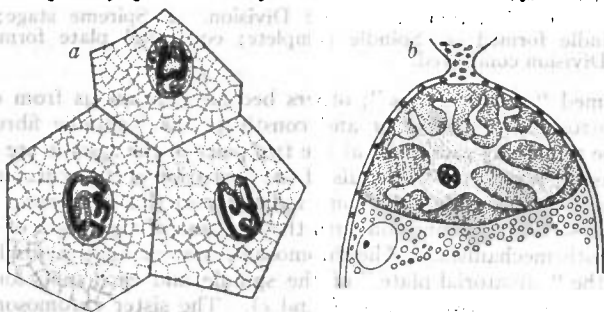

FIG. 4.—Types of Nuclei.

From Prof. E. B. Wilson's *The Cell in Development and Inheritance*, by permission of the author and of the Macmillan Co., New York.

a, Permanent spireme-nuclei in cells from the intestinal epithelium of a dipterous larva, *Ptychoptera*. (After van Gehuchten.)

From Korschelt and Heider, *Lehrbuch der verg. Entwicklungsgeschichte der wirbellosen Tiere*, by permission of Gustav Fischer.

b, Branched nucleus of the "nutritive" cell, from a portion of an ovarian tube of *Forficula auricularia*.

cells this structure is extensively branched, e.g. many gland cells and ovarian nutritive cells of insects (fig. 4, b). In some cases the nucleus of the gland cell contains a persistent spireme thread (fig. 4, a); while almost all actively secreting

<sup>1</sup> Cf., however, the present writer's interpretation of this structure in the oocyte of *Antedon*. *Phil. Trans. Royal Soc.* (1906), B. 249.

are characterized by the possession of large or numerous nucleoli.

(c) *Specialisation for the Reception and Conduction of Stimuli.*—One of the most striking of the fundamental attributes of living protoplasm is its "irritability," that is to say, its power of responding to external impressions, "stimuli," by movement, which, both in kind and intensity, is wholly independent of the amount of energy expended by the stimulus. The stimulus conveyed by the nerve fibre to the muscle is out of all proportion

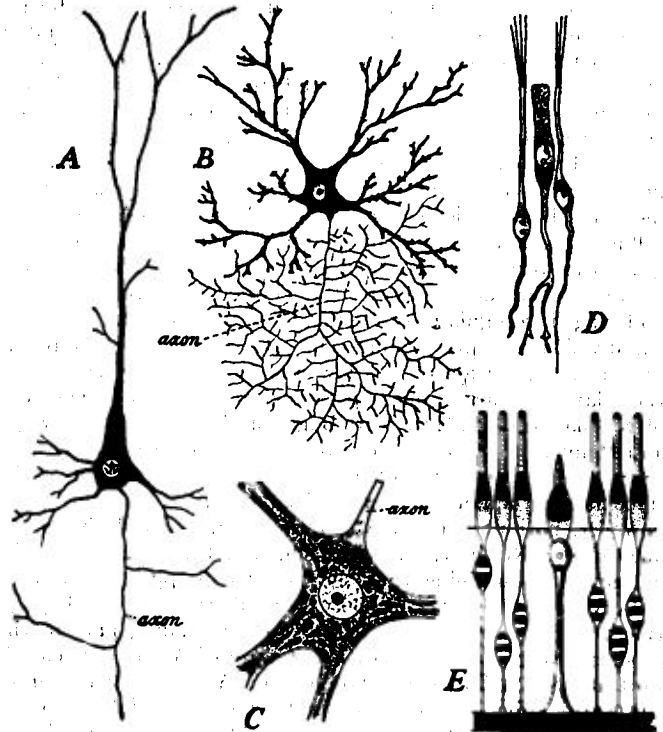

From Schäfer's *Essentials of Histology*, by permission of Longmans, Green & Co.

FIG. 5.—Nervous and Sensory Cells.

A and B, Ganglion cells from the cerebral cortex; in A the only slightly branched axon may extend the whole length of the spinal cord. (After Schäfer.)

C, Body of a ganglion-cell showing "Nissl's granules."

D, Sensory cells from olfactory epithelium. (After Schultze.)

E, Diagrammatic representation of the sensory epithelium of retina (rod and cone layer). (After Schwalbe.)

to the amount of work it may cause the muscle to do. Although protoplasmic irritability is thus incapable of a simple mechanical explanation, science has rejected the assumption of a special "vital force," and interprets protoplasmic response as being a long series of chemo-physical changes,<sup>2</sup> initiated, but only initiated, by the original stimulus; the latter thus standing in the same relation to the response it produces as the pull on the trigger to the propulsion of the rifle bullet. The function of receiving stimuli from the outer world, originally possessed to a greater or less extent by all cells, has, in the Metazoa, been relegated to one class of cells, the sensory cells<sup>3</sup> (fig. 5, D and E). Another class of cells—the "ganglion cells" or "neurones" (fig. 5, A and B), are concerned with the conduction of the stimuli so received. The contractile elements in the Metazoa are thus dependent for their stimuli on the nervous elements—the sensory cells and neurones.

*Origin of Cells.*—In the preceding sections we have considered the structure of the cell in relation to the fundamental attributes of cell-metabolism, irritability, and movement. We have now

<sup>2</sup> Claude Bernard expressed the same conclusion in 1885. Rejecting both the view that vital phenomena were identical with chemo-physical phenomena, and that which regarded them as totally distinct, he suggested a third point of view: "l'élément ultime du phénomène est physique; l'arrangement est vital."

<sup>3</sup> Many forms of response to stimulus involve no visible specialization, e.g. positive and negative heliotropism, chemiotropism, geotropism, &c., seen more especially in plants, but occurring also in the animal kingdom.

to consider the cell in relation to yet another vital attribute, that of reproduction. Just as we now know that the phenomena of assimilation, respiration, excretion, response, movement and so forth, characteristic of living things, are but the co-ordinated expressions of the corresponding activities of the constituent cells, so we now know that the reproduction of the organism is, in its ultimate analysis, a cell-process. Our knowledge of the essential fact that cells only arise by the division of pre-existing cells, now a fundamental axiom of biology, and of the details of this process, have been acquired during recent years by the strenuous efforts of numerous workers.<sup>1</sup> Matthias Jakob Schleiden (1838) supposed that in plants the new cell arose from the parent cell by a sort of "crystallizing" process from the cell fluid or "cytoblastema"; the nucleolus appearing first, then the nucleus, and finally the cell-body. Theodor Schwann (1839) extended Schleiden's theory to animal tissues, with this yet greater error, that new cells might arise, not only within the mother cell as Schleiden had supposed, but also in the inter-cellular substance so common in animal tissues (to which he also gave the term "cytoblastema"). By 1846, however, the botanists, thanks mainly to the efforts of Hugo von Mohl and Nägeli, recognized as a general law that cells only arise by the division of a pre-existing cell. But it was long before the universal application of this law was recognized by zoologists; the delay being largely due to pathological phenomena. The work of Kölliker (1844-1845), Karl Bogislaus Reichert (1841-1847), and Remak (1852-1855), however, finally enabled Virchow in 1858 to maintain the law of the genetic continuity of cells in the since famous aphorism *omnis cellula e cellula*. At this time, however, nothing was known of the details of cell-division,—one school (Reichert, L. Auerbach, and the majority of the botanists) maintaining that the nucleus disappeared prior to cell-division, the other school (von Baer, Remak, Leydig, Haeckel, &c.) maintaining that it took a leading part in the process. It is not until the appearance of Anton Schneider's work in 1873, followed by those of Fol, Auerbach, Strasburger and many others, that we begin to gain an insight into the process. In 1882 W. Flemming was able to extend Virchow's aphorism to the nucleus also: *omnis nucleus e nucleo*.

*Outline of Cell-division.*—There are two very distinct methods of cell-division. The more general and also more complicated method is accompanied by the formation of a complex fibrillar mechanism, and was on this account termed "mitosis" (*μῆτρος*, a thread) by W. Flemming (1882), and "karyokinesis" (*κάρυον*, nut, nucleus, and *κίνησις*, change, movement) by W. Schleicher (1878). The other method, "amitosis," or direct division, is unaccompanied by any visible mechanism and is of relatively exceptional occurrence. In the more usual method of cell-division, or "mitosis," we can distinguish two distinct but parallel processes, the one undergone by the chromatin and resulting in the "chromatic figure," the other usually only concerning the cytoplasm and resulting in the "achromatic figure."<sup>2</sup>

We will consider the chromatin changes first. The chromatin granules lose their scattered arrangement on the nuclear reticulum, and become instead arranged in a linear series to form a coiled and deeply staining "spireme thread"<sup>3</sup> (fig. 6, *a*). As the thread contracts, its granular origin becomes less evident, and at the same time the coils become fewer in number; the "close" spireme of earlier stages becomes the "loose" spireme of later stages. As the spireme thread contracts, it segments into a number of short, and usually U-shaped, segments—the "chromosomes" (Waldeyer, 1888). The number of these chromosomes is always constant for the cells of any given species of plant or animal, but varies greatly in number in different

<sup>1</sup> Prominent among these are: Schleiden (1873), Fol (1873-1877), Auerbach (1874), Bütschli (1876), Strasburger (1875-1888), O. Hertwig (1875-1890), R. Hertwig (1875-1877), Flemming (1879-1891), van Beneden (1883-1887), Rabl (1889), Boveri (1887-1903).

<sup>2</sup> This distinction between the chromatic and achromatic portions of the mitotic figure is due to Flemming.

<sup>3</sup> The genesis of the spireme thread was first described by E. G. Balbiani in 1876.

species. Thus in the parasitic worm *Ascaris megalocephala*, var. *univalens*, there are only two. In the crustacean *Artemia* Bauer found 168, while in the amphibian *Salamandra maculata*, as also in the lily, the number is 24. While these changes have been proceeding in the nucleus, changes in the cytoplasm have resulted in the formation of the achromatic figure. These cytoplasmic changes are initiated by the division into two of a minute body, the "centrosome," originally discovered by P. J. van Beneden in 1883,<sup>4</sup> and usually lying not far from the nucleus (fig. 6, *a*). The daughter centrosomes separate from one another, travelling to opposite poles of the nucleus. At the same time radiations extend out into the cytoplasm from the centrosomes, and, as the nuclear membrane disappears, invade the nuclear area (fig. 7, *a*). Some of the fibrillae in the latter region become attached to the chromosomes and are

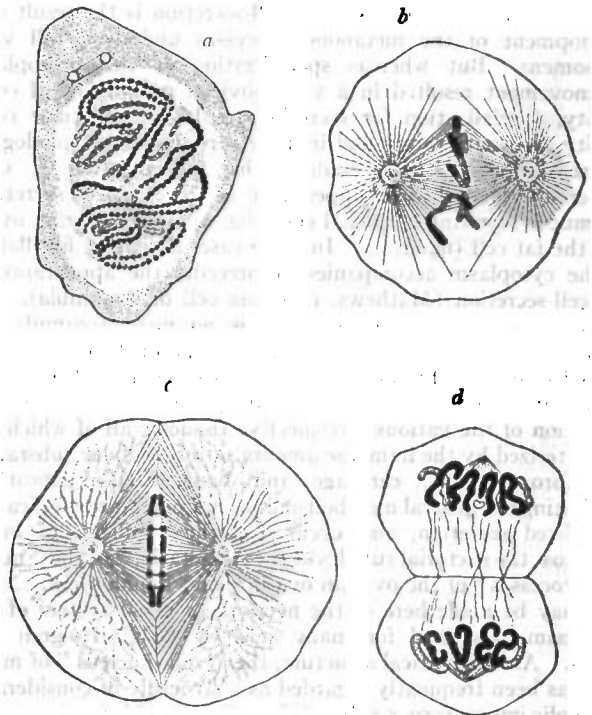

*a, b and c* from Prof. E. B. Wilson's *The Cell in Development and Inheritance*, by permission of the author and the Macmillan Co., New York; *d* from A. Gurwitsch, *Morphologie u. Biologie der Zelle*, by permission of Gustav Fischer.

FIG. 6.—Diagram of Nuclear Division. *a*, Spireme stage; *b*, Spindle formed; *c*, Spindle complete; equatorial plate formed; *d*, Division completed.

termed "mantle fibres"; others become continuous from one centrosome to the other and constitute the "spindle fibres." The remaining radiations at the two poles of the spindle are the "astral rays." (The details of the formation of the achromatic figure vary considerably, some indication of this is given in the next section in connexion with the question of the origin of the mitotic mechanism.) The chromosomes now arrange themselves in the "equatorial plate" of the spindle and each splits longitudinally into two<sup>5</sup> (fig. 6, *b* and *c*). The sister chromosomes now pass to opposite poles of the spindle (fig. 6, *d*), and there, returning to the "resting" condition, constitute the daughter nuclei. Division of the cell follows, usually, in animals, by simple constriction. Both Theodor Boveri and van Beneden, in their papers of 1887, regarded the centrosome as initiating, not only the division of the cell-body but that of the chromatin also; Beneden even suggested that the pull of the mantle fibres caused the division of the chromatin in the equatorial plate. W. Pfitzner in 1882 was the first to show that the splitting of the chromosomes in the equatorial plate was only the reappearance of a split in the spireme thread and was due to a corresponding

<sup>4</sup> "Recherches sur la maturation de l'œuf, la fécondation et la division cellulaire" (*Archives de biologie*, vol. iv.).

<sup>5</sup> First discovered by Flemming in 1879 and confirmed by Retzius in 1881.



division into two of each of the chromatin granules. In the spermatogenic cells of *Ascaris*, A. Brauer has shown that the chromatin granules divide while still scattered over the nuclear reticulum and before either the formation of a spireme thread or the division of the centrosome. In many other cases the reverse of this condition occurs, the centrosome dividing long before there is any indication of division in the nucleus (e.g. salamander spermatogenic cells, Meves, &c.). We must therefore, with Boveri and Brauer, regard the division of the chromatin in mitosis as a distinct reproductive act on the part of the chromatin granules, the chromosomes being merely aggregates (temporary or permanent, *vide infra*) of these self-propagating units.

For convenience of description it is usual to recognize four periods in mitosis: (i.) Prophase, (ii.) Metaphase, (iii.) Anaphase, and (iv.) Telophase (Strasburger, 1884). The prophase covers all changes up to the completion of the mitotic figure. The metaphase is the parting of the sister chromosomes in the equatorial plate; their passage to opposite poles of the spindle constitutes the anaphase; and their reconstruction to form the resting daughter nuclei, the telophase.

**The Achromatic Figure.**—The mode of origin of the achromatic figure varies greatly. In some cases a distinct and continuous spindle, the "central spindle" of F. Hermann, is visible from the very first separation of the daughter centrosomes (e.g. salamander spermatogenic cell)<sup>1</sup> (fig. 7, b). In other

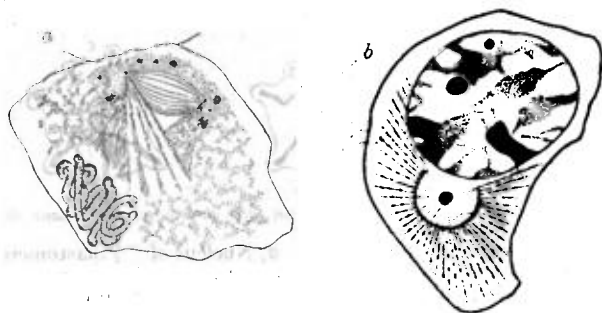

FIG. 7.—Centrosomes.

From Prof. E. B. Wilson's *The Cell in Development and Inheritance*, by permission of the author and of The Macmillan Co., New York.

a, Leucocyte from a Salamander, showing permanent aster and centrosome.

From A. Gurwitsch, *Morphologie u. Biologie der Zelle*, by permission of Gustav Fischer.

b, Sperm-mother cell of *Salamandra maculata*, showing Hermann's "central spindle."

cases the rays only invade the nuclear area and become continuous in the equatorial plane after the centrosomes have assumed their definitive positions at the two poles of the nucleus, and may even appear to indent the disappearing nuclear membrane as they invade the nuclear area.<sup>2</sup> In the salamander testis cell (fig. 7, b), and in many other cases, the whole of the achromatic figure is obviously of cytoplasmic origin. In many cases, however, it equally obviously arises within the nucleus,<sup>3</sup> while in yet other cases<sup>4</sup> the spindle fibres are of mixed origin. The question, therefore, of the cytoplasmic or nuclear origin of the achromatic figure, at one time regarded as of considerable importance, is wholly immaterial. Various elaborate theories have been propounded to explain the mechanism of the mitotic figure. H. Fol (1873) regarded the centrosomes as centres of attractive forces, and compared the mitotic figure to the lines of force in the magnetic field, a comparison made by numerous subsequent workers. E. Klein's hypotheses of two opposing

<sup>1</sup> The discovery by Hermann of the central spindle first clearly showed that two kinds of fibres must be recognized in the mitotic figure. Those of the central spindle correspond to the continuous spindle fibres of Flemming (1891) and Strasburger (1884), and the mantle fibres, i.e. half-spindle or *Polstrahlen*, of van Beneden (1887) and Boveri (1889-1890).

<sup>2</sup> Planter, Watasé, Griffen and others.

<sup>3</sup> e.g. *Euglypha* (Schewiakoff, 1888), Infusoria (R. Hertwig, 1898) So also Korschelt for *Ophryotrocha*, and many other cases.

<sup>4</sup> e.g. Bauer, spermatogenic cells of *Ascaris univalens*.

systems of contractile fibrillae, elaborated by van Beneden (1883, 1887) and accepted by Boveri (1888), was still further extended by R. Heidenhain in relation to the leucocytes of the salamander, in which there is a permanent centrosome and astral rays to which the contractile movements of the cell appear to be due<sup>5</sup> (fig. 7, a). Hermann on the other hand confined the contractility to the astral and mantle fibres; while L. Druner regarded the spindle as exerting a pushing force, for not only do the interzonal spindle fibres elongate during the anaphase, but they were often at this period contorted, while on the other hand astral rays may be entirely absent (e.g. Infusoria), and in some cases the spindle pole may be caused to project at the surface of the cell. The futility of these attempted mechanical explanations of mitosis is sufficiently clearly shown, not only by the contradictory nature of the explanations themselves, but by the fact that, in amitosis, nuclear and cytoplasmic division occur without any fibrillar mechanism whatever.

**Centrosome.**<sup>6</sup>—This minute body was first detected at the spindle poles by Flemming in 1875, and independently by P. J. van Beneden in 1876. The important part played by the centrosome in fertilization,<sup>7</sup> first described by van Beneden and Theodor Boveri in their papers of 1887-1888, together with the behaviour of this structure in mitosis, led these authors to regard the centrosome not only as the dynamic centre of the cell but as a permanent cell-organ, which, like the nucleus, passed by division from one cell-generation to the next. This conclusion appeared to receive considerable support from the recognition of the centrosome in various kinds of resting cells,<sup>8</sup> and especially from the relation this structure frequently shows to the locomotor apparatus of the cell (e.g. its position in the centre of the radiating fibrillae in the contractile lymph and pigment cells, and its relation to the vibratile flagellum in spermatozoa and some protozoa, e.g. Trypanosoma).<sup>9</sup> In almost all cases the centrosome of the resting cell, when this can be detected, lies in the cytoplasm, and is often already divided in preparation for the next mitotic division (e.g. spermatogenic cells of the salamander; Meves). In some cases, however, it resides in, or arises from, the nucleus (Brauer; spermatogenesis of *Ascaris*, var. *univalens*). This indifferent nuclear or cytoplasmic position for the centrosome is paralleled by the attraction sphere or homologue of the centrosome in many Protozoa. Thus in many forms, e.g. *Euglena* (Keuten), it lies within the nucleus, while in other forms, e.g. *Noctiluca* (Ishikawa, 1894, 1898; Calkins, 1898) and *Paramecium* (F. Schaudinn, 1896), it lies in the cytoplasm, while in *Tetramitus* it coexists with a "distributed" nucleus. In the Heliozoa conditions are exceptionally interesting; not only is the centrosome—here resembling in appearance that of the higher forms—permanently visible and extranuclear, lying at the centre of the radiations characteristic of these forms, but there is the strongest possible evidence for its formation *de novo*. For Schaudinn has shown in *Acanthocystis* that, in the formation of the swarm spores, the nucleus divides amitotically, the centrosome remaining visible and unchanged at the centre of the radiating processes. Yet a centrosome appears later in the nucleus of the swarm spores and migrates into the cytoplasm. The experiments of T. H. Morgan and E. B. Wilson, in which numerous centrosomes and asters ("cytasters") are caused to appear in unfertilized sea-urchin eggs by a brief immersion in a 13% solution of magnesium

<sup>5</sup> Cf. also Watasé, Solger and Zimmermann.

<sup>6</sup> This term is due to Boveri (*Zellenstudien*, ii., 1888, p. 68; *Jen. Zeit.* xxii.), but it was intended by him to include the region of modified cytoplasm or "centrosphere" often enclosing the centrosome proper, i.e. "centriole" of Boveri.

<sup>7</sup> For outline of fertilization see article REPRODUCTION.

<sup>8</sup> e.g. lymph and various epithelial and connective tissue cells of salamander larva (Flemming, 1891; Heidenhain, 1892); pigment cells of fishes (Solger, 1891); red blood corpuscles (Heidenhain, Eisen, 1897); and numerous other cases.

<sup>9</sup> For an interesting development of this subject see Watasé (1894). This author not only identifies the centrosome with the structures seen in lymph cells, &c., but compares it to the basal granules of ciliated cells and to the varicose swellings on the sarcostyles of striped muscle cells!



chloride in sea-water,<sup>1</sup> as also the possibility in many cases that even in normal fertilization the cleavage centrosomes may arise *de novo*,<sup>2</sup> make it no longer possible to regard the centrosome as a permanent cell-structure.

**Significance of Mitosis.**—Whatever may be the nature of the chemico-physical changes occurring during cell-division, of which the achromatic spindle and astral rays are the visible expression, it is certain that the whole of this complicated process has for its function, not the division of the chromatin, for that has already occurred on the spireme thread or even earlier, but the distribution of the divided chromatin granules to the two daughter nuclei. It is indeed usually assumed that the mitotic mechanism is not merely for the distribution, but for the *equal* distribution, of the sister granules to the two daughter nuclei. The conspicuous part the chromatin is seen to play in the whole mechanism of heredity—in maturation, fertilization and development—indicating as it does that the chromatin is the chief, if not the only, bearer of the specific qualities of the organism, sufficiently clearly emphasizes the importance of the equal distribution of this substance between the daughter cells at successive cell-divisions. There are, however, serious objections to the interpretation of mitosis as an adaptation to ensure this equal distribution of the chromatin. Not only does the occurrence of amitosis show that the mitotic mechanism is not essential for either nuclear or cytoplasmic division, but direct division may occur<sup>3</sup> in the life-history of the germ cells, the very point at which it should not occur had mitosis the significance usually attached to it. On the other hand, the most elaborate mitosis occurs in cell-tissues (*e.g.* skin of salamander larva) which can take no possible share in the reproduction of the species. Moreover, we have no reason for supposing that the division of the chromatin in amitosis is not as meristic, and its subsequent distribution as equal, as is so visibly the case in mitosis.<sup>4</sup> It is necessary, therefore, to seek for some other explanation of the elaborate mechanism of mitosis than that which assumes it necessary for the equal distribution of the divided chromatin granules. The present writer believes the true explanation to be found in that great economic law of nature, "division of labour." The same economy which, working under the control of natural selection, has produced the complexly differentiated tissues of the higher metazoa, which has led to the sexual differentiation between the conjugating gametes and thus to the sexual differentiation of the parents, has resulted in the production of mitosis. Only here the economy finds expression in division of labour, not in space, but in time. The work of the self-propagating chromatin granules is so ordered that periods of undisturbed metabolic activity alternate with periods of reproductive activity. The brief space of time occupied by the latter process has necessitated a more elaborate specialization of the forces—whatever their nature—controlling cell-division; a specialization which has resulted, just as a similar specialization in so many other cases has resulted, in a visible differentiation of the cell-protoplasm. This explanation is in harmony with the occurrence of typical mitosis in active tissue cells on the one hand, and of amitosis in the relatively quiescent primary germ cells on the other.

**Individuality of the Chromosomes.**—The most striking feature in the behaviour of the chromatin in mitosis is its resolution, at each division, into *a*—for any particular species—constant number of chromosomes. This constant recurrence of the specific number of chromosomes at every cell-division is capable

<sup>1</sup> The force of this evidence is admitted by Boveri himself. Meves, however, maintains the possibility that the numerous centrosomes appearing in the egg arise by the rapid fragmentation of a centrosome already present.

<sup>2</sup> Cf. especially the behaviour of the centrosomes in the fertilization of the egg of *Pleurophyllidia* (MacFarland, 1897) and that of *Cerebratulus* (Coe, 1901). Not only may the sperm centrosomes totally disappear before reaching the egg-nucleus, but in the latter type the definitive centrosomes appear while the last traces of the sperm asters are still visible.

<sup>3</sup> *e.g.* Meves; Spermatogonia of Salamandra.

<sup>4</sup> Cf. especially the artificial production of amitosis in *Spirogyra*; W. Pfeffer, 1899.

of explanation in two radically different ways. One explanation assumes for the organism a specific peculiarity determining the segmentation of the spireme thread into a definite number of segments (Delage, 1899 and 1901).<sup>5</sup> The other regards chromosomes as independent units of the cell, retaining their identity through successive cell-divisions. The latter "Individualitäts Hypothese" was originally put forward by Theodor Boveri in 1887 as a result of C. Rabl's observation (1885) that in epidermal cells of the salamander larva the chromosomes reappear in the mitosis of the daughter cells with the same arrangement as they possessed in the prophase of the mother cell—the angles of the U-shaped chromosomes being all directed towards one pole (Rabl's "Polseite") of the nucleus. In the formation of the "resting" nucleus, the chromatin, becoming metabolically active, flows out on to the linin reticulum, all trace of the chromosomes being for the time lost. In *Ascaris*, Boveri (1888) obtained similar but still more striking results. The thickened ends of the four elongated chromosomes cause projections on the nuclear surface throughout the resting period, and the ends of the reappearing chromosomes always coincided with these protuberances; cf. also Sutton (1902) on locust spermatogonia. Moreover, the arrangement of the chromosomes must follow one of three well-marked groupings, and this is determined for each individual in the cleavage spindle of the egg and maintained throughout later development (fig. 8).

In the same worm (var. *univalens*) Boveri (1888 and 1899) found that occasional abnormalities in maturation resulted in



From Boveri's *Ergebnisse u. d. Konstitution der chromatischen Substanz des Zellkerns*, by permission of Gustav Fischer.

FIG. 8.—Preparation for Mitosis. *a*, Nucleus of "½ blastomere" of *Ascaris megalocephala bivalens* in resting condition; *b* and *c*, nuclei from sister ½ blastomeres in preparation for mitosis.

the suppression of the first polar body and the inclusion of its chromosomes in the second maturation spindle; the egg-nucleus at the time of fertilization thus having two chromosomes instead of one, while the spermatozoon nucleus has only one. Three chromosomes instead of two reappear in subsequent divisions. Boveri's "Individualitäts Hypothese" received striking support from the work of Herla (1893), L. R. Zoja (1895) and O. zur Strassen (1898). Herla and Zoja showed that if the egg of *Ascaris megalocephala* (var. *bivalens*), which possesses two chromosomes, be fertilized with the spermatozoon of var. *univalens*, in which the germ cell has only one chromosome and that smaller than either of the two in the other variety, three chromosomes reappear, two large and one small, in the cleavage divisions of the resulting hybrid embryo. Zur Strassen's observations on the giant embryos of *Ascaris* also support Boveri's theory. These embryos arise by the fusion of eggs, either before or after fertilization. The number of chromosomes in the subsequent cleavage-figures is proportional to the number of nuclei that have fused together. Similar results are given by Boveri's (1893-1895) and T. H. Morgan's (1895) experiments on the fertilization of enucleated sea-urchin egg-fragments; all the nuclei of the resulting embryo having only half the number of chromosomes characteristic of the species (*e.g.* in *Echinus* 9 instead of 18). All the above facts point to the conclusion that, as Boveri expressed it in his *Grundgesetz der Zahlenkonstanz* (1888), "the number of chromosomes arising from a resting nucleus is solely dependent on the number which originally entered into its composition."<sup>6</sup>

<sup>5</sup> Cf. Boveri, 1904, p. 13. (For Boveri's criticism of Delage's views, cf. Boveri, 1901 and 1902.)

<sup>6</sup> It should, however, be noted that the assumption that a particular group of characters remains always associated in a particular chromosome is one that is very difficult to reconcile with the mode of inheritance of Mendelian pairs of characters in the case of organisms with a relatively small chromosome number.

**Boveri's Law of Proportional Nuclear Growth.**—The chromatin in the nucleus is exactly halved at every cell-division. As the bulk of the chromatin remains constant from one cell-generation to another, it must double its bulk between successive divisions. That this proportional growth of the chromatin is dependent solely on the chromatin mass, and not on that of the cell, is very clearly indicated by cases where the normal chromatin mass has been artificially increased or reduced,<sup>1</sup> the chromatin in either case doubling its bulk between successive cell-divisions, and neither the mass of the chromatin nor the number of the chromosomes undergoing any readjustment. By double or partial fertilization, different regions in the same embryo may show nuclei of different sizes (Boveri). We must therefore distinguish in the cell between "young" and "adult" chromatin. In other words the chromatin must be regarded as being composed of individual units, each with a definite constant structure and maximum growth (Boveri, 1904). This conclusion is strongly suggested, not only by the evidence in favour of the individuality of the chromosomes considered above, but also by the independent reproductive activity of the chromatin granules in the prophase of mitosis.

**Differentiation among the Chromosomes.**—If we grant the assumption of a persistent individuality for the chromosomes, then it becomes possible to consider whether in one and the same nucleus these structures may not take varying parts in controlling the cell's activity in development and in inheritance. Such a differentiation among the chromosomes would be due to independent ancestry rather than to the economy resulting from a division of labour; nevertheless a division of labour of a sort would be the result of this gradual divergence of the chromosomes from one another, and we might therefore expect that, in some cases at least, a *morphological* would accompany the *physiological* differentiation. Examples of such a morphological differentiation do indeed occur in the "accessory" chromosomes first described by H. Henking (1891) for the spermatogonia of *Pyrrhocoris*, and since described for numerous other insects,

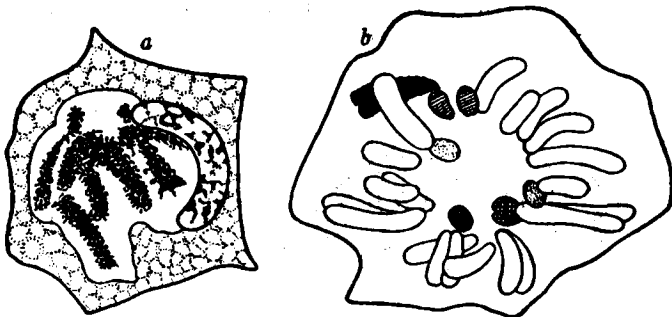

From Boveri's *Ergebnisse u. d. Konstitution der chromatischen Substanz des Zellkerns*, by permission of Gustav Fischer.

FIG. 9.—Preparation for Mitosis. *a*, Spermatogonium of *Brachystola magna* with resting nucleus; *b*, Same with prophase for mitosis. (After Sutton.)

Arachnids and Myriapods. W. Sutton's work on the spermatogenesis of *Brachystola magna* is of especial interest in this connexion. Not only does the "accessory chromosome" in this insect form a resting nucleus independent, and obviously physiologically differentiated from that formed from the remaining chromosomes (fig. 9, *a*), but the latter are themselves differentiated by size, there being one pair of chromosomes of each size (fig. 9, *b*), a point of considerable interest when we remember that half the chromosomes in each cell are necessarily derived from each parent.<sup>2</sup>

Although this morphological differentiation among the chromosomes is undoubtedly to be regarded as indicating a corresponding physiological differentiation, it by no means

<sup>1</sup> Boveri (1902), "Fertilization of enucleated *Echinus*-egg fragments," and M. Boveri (1903); by shaking the egg shortly after fertilization the sperm centrosome is prevented from dividing, and a monaster instead of a diaster results, the divided chromosomes remaining in the one nucleus.

<sup>2</sup> Cf. especially in this connexion Häcker's paper *Über die Schicksale der elterlichen und grosselterlichen Kernanteile* (1902).

follows that the latter need always, or even generally, be accompanied by the former. Since, however, the specific characters of the organism must be due to the combined activity of *all* the chromosomes, any physiological differentiation among the latter should result in abnormal development if the full complement of chromosomes be not present.<sup>3</sup> Boveri,<sup>4</sup> utilizing Herbst's method<sup>5</sup> for separating echinoderm blastomeres, has interpreted in this manner the abnormal development which H. Driesch<sup>6</sup> found almost invariably to follow the double fertilization of the sea-urchin egg. In such eggs the first cleavage spindle is four-poled. The chromosomes are half again as numerous as in normally fertilized eggs (54 instead of 36), but each is only divided once, so that in the distribution of the resulting 108 chromosomes the four daughter nuclei receive each only 27 instead of 36 (assuming the distribution to be fairly equal, which is by no means usually the case in four-poled mitosis). Driesch had already (1900) shown that any one of the first four blastomeres of a normally fertilized egg will, if isolated, develop normally. Boveri found that in the case of the doubly fertilized egg the isolated " $\frac{1}{4}$ " blastomeres develop very variously, a variability only to be accounted for by their varying chromosome equipment. Occasionally a three-poled instead of a four-poled figure resulted from double fertilization. In such cases Driesch found, as we should expect from Boveri's interpretation, that the percentage of approximately normal larvae was considerably greater; for not only would the chances of an equal distribution of the chromosomes be much greater, but the number received by each of the three daughter cells would approximate to, or even equal, the normal.

**Reduction.**—In all the Metazoa the prevailing, and in the higher forms the only, method of reproduction is by the union (conjugation) of two "sexually" differentiated germ-cells or "gametes"; a small motile "microgamete" or spermatozoon and a large yolk-laden "macrogamete" or ovum (see REPRODUCTION). This differentiation between the germ-cells is another example of the advantages of division of labour; for while the onus of bringing about the union of the germ-cells is thrown entirely on the spermatozoon, the egg devotes itself to the accumulation of food-material (yolk) for the subsequent use of the developing embryo. Far more yolk is thus secreted than would be possible by the combined efforts of both the germ-cells had each of these at the same time to preserve its motility. The fundamental physiological difference which this division of labour has produced in the germ-cells is reflected on to the general metabolism of the parents and underlies the sexual differentiation of the latter.<sup>7</sup> Beyond this, however, sexual differentiation does not go. The two germ nuclei which enter into the formation of the first mitotic figure of the developing egg are not only physiologically equivalent, but, at the time of their union in the egg, are usually morphologically identical.<sup>8</sup> The essence of fertilization is, therefore, the union of two germ nuclei only differing from one another in that they are derived from separate individuals.<sup>9</sup> Since the number of chromosomes appearing in mitosis is solely dependent on the number which

<sup>3</sup> Each nucleus contains a duplicate set of chromosomes, the one of maternal, the other of paternal origin, and either of these sets alone suffices for development. This is clearly shown by the experiments of Loeb (1899) and Wilson (1901) on the artificial parthenogenesis of the sea-urchin egg; and those of O. Hertwig (1889 and 1895), Delage (1899) and Winkler (1901), on the fertilization of enucleated Echinoderm eggs (*Merogony*, Delage). The fact that in some forms, e.g. *Ascaris megaloccephala* var. *univalens*, only one chromosome is derived from each parent, originally led Boveri to conclude that *all* chromosomes must necessarily be physiologically equivalent.

<sup>4</sup> *Über mehrpolige Mitosen als Mittel zur Analyse des Zellkerns* (1902).

<sup>5</sup> *Über das Auseinandergehen von Furchungs- und Gewebezellen in kalkfreien Medium* (1900).

<sup>6</sup> "Entwicklungsmechanische Studien V." (*Zeit. für wiss. Zool.*, Bd. lv., 1892).

<sup>7</sup> See Geddes and Thomson, *Sex*, esp. pp. 127, 137 and 139.

<sup>8</sup> The equivalence of the germ nuclei in development is shown by the experiments on the fertilization of enucleated eggs and artificial parthenogenesis already referred to.

<sup>9</sup> O. Hertwig, 1873; but esp. van Beneden, 1883.

originally entered into the composition of the nucleus (Boveri's Law of Chromosome-Constancy), it follows that, in the mitotic figures of the developing embryo, the chromosomes will be half maternal, half paternal in origin;<sup>1</sup> the germ nuclei thus necessarily possessing only half the number of chromosomes characteristic of the ordinary tissue cells of species, *i.e.* the somatic number.<sup>2</sup> The manner in which this "reduction" in the number of chromosomes in the germ-cells is brought about, and the significance to be attached to the process, constitute the most hotly debated questions in cytology. In all the metazoa the phenomenon of reduction is associated with the two last and, usually, rapidly succeeding "maturation" divisions by which the definitive germ-cells—ova or spermatozoa—are produced.<sup>3</sup>

Assuming the persistent individuality of the chromosomes, then there are only three conceivable methods by which this numerical reduction can be brought about (Boveri, 1904, p. 60). (1) One-half the chromosomes degenerate. (2) The chromosomes are distributed entire, half to one daughter cell, half to the other (reducing division of Weismann, 1887). (3) The chromosomes fuse in pairs (*Conjugation of the Chromosomes*, Boveri, 1892). The first possibility—that of an actual degeneration of a part of the chromatin originally suggested by van Beneden and adopted by August Weismann, Boveri and others, has been long abandoned, and a steadily increasing bulk of evidence is tending to prove the general, if not universal, occurrence of the second method—the distribution between the daughter cells of undivided chromosomes. The occurrence of such a "reducing division" was postulated on theoretical grounds by Weismann (1887)<sup>4</sup> and by Boveri (1888); by the former as a result of his adoption of de Vries's hypothesis of self-propagating and qualitatively varying units for the chromatin; by the latter in relation to his theory of chromosome individuality. The actual occurrence of this reducing division was first demonstrated by Henking (1891) for *Pyrrhocoris*, and afterwards by Häcker, vom Rath and many others, but especially by Rückert (1894) for *Cyclops* (fig. 10). In this latter type the chromatin of the oocyte, as this prepares for the first maturation division, resolves itself into 12 (instead of 24) longitudinally split chromosomes (fig. 10, a). As these continue to thicken and contract a transverse fission appears (fig. 10, c). This is to be regarded as a belated segmentation of the spireme thread, and shows that the reduction so far is only a "pseudo-reduction" (Rückert), the chromosomes being really all present but temporally united in pairs, *i.e.* "bivalent" (Häcker). A striking confirmation of this interpretation is provided by Korschelt's description of reduction in the annelid *Ophryotrocha*. In this type the full somatic number of split chromosomes (here only four) appears, and these secondarily associate end to end in pairs, thus forming split "diads" (*i.e.* tetrads), in every way similar to those described by Rückert for *Cyclops*. In the latter type, at the first maturation division, the sister diads are separated from one another, an "equating" division thus taking place. At the second division the diads are resolved into their constituent parts, and the "univalent" chromosomes are distributed to the daughter

<sup>1</sup> Häcker, "Über die Selbstständigkeit der väterlichen und mütterlichen Kernbestandteile," *Arch. f. mikr. Anat.* Bd. xlv. (1896).

<sup>2</sup> First discovered by van Beneden (1883, 1887) for the egg of *Ascaris*.

<sup>3</sup> In the case of the egg the whole of the yolk stored by the "oocyte" (cell-generation immediately preceding the maturation divisions) is handed on to only one of the four resulting cells—an obvious economy. The three yolkless cells are necessarily functionless—abortive ova—and are known as the "polar bodies" (Hertwig). In spermatogenesis the maturation divisions, though bearing the same relation to reduction as in oogenesis (Platner, 1889; O. Hertwig, 1890), give rise to four functional germ-cells. The explanation of sexual differentiation given above, and that of polar body formation given here, render it needless to do more than mention the theories of Mimot (1877), van Beneden (1883) and others, by which "maturation" was regarded as removing the "male" element from the otherwise "hermaphrodite" egg.

<sup>4</sup> Weismann postulated a transverse division of the chromosomes, not a distribution of entire chromosomes; but the result as far as the reduction in the number of hereditary qualities goes is the same. The inability of the mitotic mechanism to effect the transverse division of unsplit chromosomes is pointed out by Boveri (1904).

cells (reducing division). A similar process has since been described for numerous other types (*e.g.* various arthropods, Häcker, 1895-1898; vom Rath, 1895; and by Sutton for *Brachystola*, 1902-1903). In *Ophryotrocha*, as in *Pyrrhocoris* (Henking), *Anasa* (Paulmeir), *Peripatus* (Montgomery), &c.,

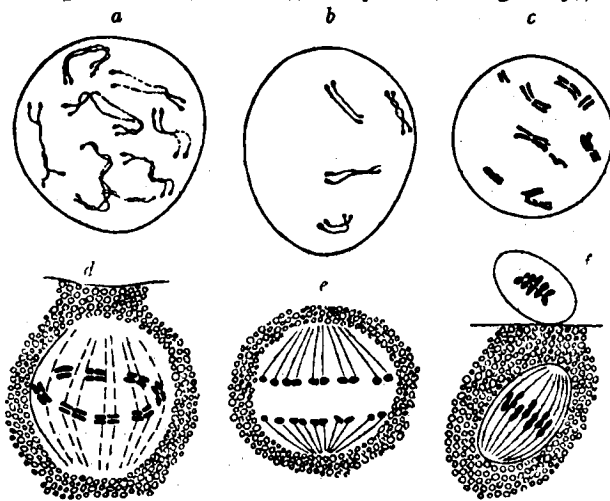

From Korschelt and Heider's *Lehrbuch d. vergl. Entwicklungsgeschichte d. wirbellosen Tiere*, by permission of Gustav Fischer.

FIG. 10.—Maturation Divisions. a-d, Formation of the tetrads in *Cyclops*. (After Rückert.) e, 1st maturation division; separation of the bivalent sister chromosomes. f, 2nd maturation division; distribution of the univalent chromosomes.

reduction occurs at the first maturation division ("pre-reduction" of Korschelt and Heider, 1900), instead of at the second division (post-reduction) as in most Copepods and Orthoptera. In many cases the tetrads (*i.e.* split chromosomes associated in pairs) have the form of rings, the genesis of which was first clearly determined by vom Rath (1892) in the mole cricket *Gryllotalpa* (fig. 11). In this form the sister diads remain united

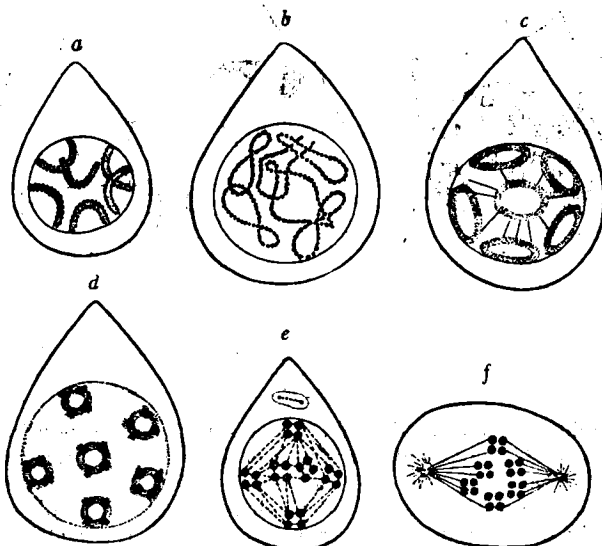

From Prof. E. B. Wilson's *The Cell in Development and Inheritance*, by permission of the author and of the Macmillan Co., N. Y.

FIG. 11.—Maturation Divisions. Origin of the tetrads by ring formation in the spermatogenesis of the mole-cricket (*Gryllotalpa*) (vom Rath). a, Primary spermatocyte with six split, bivalent chromosomes. b and c, Split has opened out. d, Concentration of the chromatin has made visible the belated transverse division. e and f, Grouping of the completed tetrads in the equatorial plate of the first maturation division.

by their ends but widely separate in the middle (fig. 11, b). As in *Cyclops*, the belated transverse segmentation appears as the condensation of the chromatin proceeds (fig. 11, d), but the symmetrical tetrads which this process here produces make it impossible to determine at which of the two divisions reduction is effected. An essentially similar ring formation occurs in

*Enchaeta* and *Calanus* (vom Rath), and in the Copepods *Heterocope* and *Diaptomus* (Rückert), and in other types.<sup>1</sup>

All the above cases, in which the reduction is effected by the distribution of entire chromosomes at one or other of the maturation divisions, may be grouped together as "pseudomitotic" (Häcker, and Korschelt & Heider). In sharp contrast to the pseudomitotic method is the "Eumitotic" method, in which the chromosomes are longitudinally divided at both divisions. Such a method not only robs the process of any "reducing" value in Weismann's sense, but is in serious conflict with the chromosome-individuality hypothesis. Nevertheless it is in this sense that Boveri (1881) and van Beneden (1883-1887) described the maturation of the egg, and at a later period Brauer (1893) that of the spermatozoon, in *Ascaris*. In each case the tetrads are formed by the double longitudinal splitting of the chromosomes, the latter appearing in the prophase in the reduced number. Not only was the eumitotic method of *Ascaris* the first method to be described, but the descriptions are fully equal in point of clearness to that of Hertwig for the pseudomitotic maturation of *Cyclops*.<sup>2</sup> A similar eumitotic maturation has been described for other types also, e.g. *Sagitta* and the Heteropods, but nowhere more frequently than in the Vertebrates among animals and the Phanerogams among plants. In these two latter groups the chromosomes of the reducing division only rarely have a ring form comparable to that seen in *Gryllotalpa*, &c. When such rings do occur their genesis is very obscure, and at no time do they present the appearance of "tetrads." It is the characteristic appearance these looped chromosomes give to the first maturation division in many Vertebrates, and especially in the Amphibia (fig. 12), that originally led Flemming (1887) to term this type of mitosis

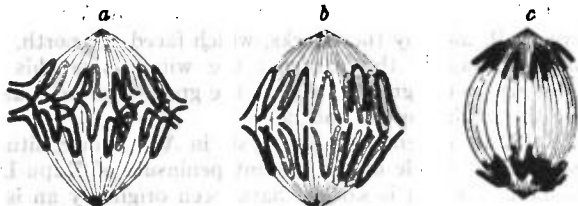

From O. Hertwig, *Allgemeine Biologie*, by permission of Gustav Fischer.

FIG. 12.—Heterotypical Mitosis. (Schematic, after Flemming.)

"heterotypical"; the second division, lacking this peculiar appearance, being distinguished as "homotypical." Until quite recently these looped chromosomes of the heterotypical mitosis of Vertebrates (and plants) were described as arising by the opening out of longitudinally split chromosomes, exactly as this occurs in the early prophase of the maturation divisions in such types as *Gryllotalpa*, *Diaptomus*, &c. In the heterotype mitosis, however, no transverse segmentation appears, and the halves of the rings, as they separate in the first division, show an obvious longitudinal split in preparation for the second division.<sup>3</sup> Both divisions were thus interpreted as equating divisions.<sup>4</sup> The more recent works of Farmer and Moore (1903-1905), Montgomery (1903, Amphibia), and (for plants) Strasburger (1903-1904) have shown, however, that even for the higher plants and animals, a reducing division in Weismann's sense occurs in an essentially similar manner to that so convincingly described by Rückert, vom Rath and others, for

<sup>1</sup> For an exhaustive account of reduction in Invertebrates see Korschelt and Heider, *Entwicklungsgeschichte*, Allgem. Teil ii. (Jena, 1903).

<sup>2</sup> Nevertheless the possibility of a pseudomitotic interpretation of maturation in *Ascaris* also has been maintained by O. Hertwig (1890), p. 277, Carnoy and Boveri (1904).

<sup>3</sup> The partial or even complete reconstruction of the nucleus during the heterotype and homotype division in Vertebrates makes it difficult to determine the identity of the split seen in the anaphase of the heterotype with that reappearing in the prophase of the homotype.

<sup>4</sup> e.g. Moore, 1895 (*Scyllium*); Flemming, 1897; Carnoy and Lebrun, 1899 (*Amphibia*); McGregor, 1899; Lenhossek, 1898 (mammals), and many others. So also for plants: Strasburger and Mottier, 1897; Dixon, 1896; Sargant, 1896-1897; Farmer and Moore, 1895; Gregoire, 1899; Guignard, 1899, &c.

Invertebrate types. For the chromosomes of the heterotype mitosis arise by the looping round, not opening out, of the bivalent chromosomes. The first division is thus a reducing division, while the split appearing in the anaphase of the heterotype and presumably reappearing in the prophase of the homotype is the original split of the spireme thread.

The widespread, if not universal, formation of tetrads, i.e. the temporary union in pairs of split chromosomes, in reduction, and the relation this latter process always bears to two rapidly succeeding maturation divisions—those completing the gametogenic cycle in animals and terminating the sporophytic generation in plants,—has received a suggestive explanation at the hands of Boveri (1904). The growth of the chromatin is an indispensable prelude to its reproduction (Boveri's Law of Proportional Growth). The chromatin is therefore incapable of undergoing reproductive fission in two successive mitotic divisions when these are not separated by a resting (i.e. growth) period. In addition to this, the "bipolar" condition of the adult chromosomes, which determines its mode of attachment to mantle fibres from both poles of the spindle, is not possessed by the unripe chromatin. The undivided, i.e. unripe, chromosomes are therefore incapable of utilizing the mitotic mechanism for such a transverse fission as Weismann originally postulated. The difficulty is, however, at once overcome if the unripe chromosomes are associated in pairs in the equatorial plate, for the bivalent chromosomes so produced are bipolar just as are the adult (i.e. split) chromosomes in the ordinary and homotype mitosis.<sup>5</sup>

*Synapsis* (συνάπτειν, to fuse together).—During the prophase of the reducing or heterotype divisions the whole of the chromatin becomes temporarily massed together at one pole of the nucleus. (Moore, 1896, for Elasmobranchs). Montgomery (1901) has suggested that this is to facilitate the temporary union in pairs, or "conjugation" of homologous paternal and maternal chromosomes. In *Ascaris megaloccephala* var. *univalens*, where the somatic number is only two, the association must necessarily be between homologous chromosomes. The assumption that this "selective pairing" of equivalent chromosomes is universal is supported by the behaviour of the "Heterochromosomes" (Montgomery) of the Hemiptera. These chromosomes, distinguished by their size, are paired before, and single after, the "pseudoreduction" has taken place. Even more convincing is Sutton's account of reduction in *Brachystola* already referred to.<sup>6</sup> Boveri (1904) has suggested that this temporary association of the chromosomes—presumably facilitated by the *synapsis*—has a much deeper meaning than to ensure their correct distribution between the daughter nuclei in the heterotype mitosis; the associated chromosomes exchanging material in a manner analogous to conjugation in *Paramoecium*.<sup>7</sup>

*Present Position of the Cell-theory*.—Since the time of Schleiden and Schwann a wealth of evidence has accumulated in support of the "cell-theory"—the theory which regards the cell as the unit of organic structure. "The organism consists

<sup>5</sup> H. Henking (1899), T. Montgomery (1898) and F. C. Paulmeir (1899) describe the diverging bivalent halves of the tetrad as being united each by two fibres with the corresponding spindle pole. At the next division, at which the diad is resolved into its constituent univalent chromosomes, the daughter chromosomes are attached to the spindle pole each by only one fibre; the two fibres now passing to opposite poles of the spindle being the same fibres which, in the preceding mitosis, were attached to one and the same pole.

<sup>6</sup> Reference may be here made to Rosenberg's description (1904) of the heterotype mitosis in *Drosera* hybrids. In the one parent (*D. rotundifolia*) the somatic number is 20, in the other (*D. longifolia*) 10; while the hybrid itself has a somatic number of 30. The reduced number in the hybrid, however, is not 15 but 20. Of these 10 are large and 10 small, the latter presumably representing the supernumerary, and hence unpaired, chromosomes of the *D. rotundifolia* parent.

<sup>7</sup> In their 1905 paper J. B. Farmer and J. E. S. Moore describe two successive synaptic stages (e.g. Elasmobranchs), the first during the contraction of the spireme thread, the second during the looping up of the bivalent segments. (In this paper the authors suggest the term "Meiosis" or "Meiotic phase" for the nuclear changes accompanying the two maturation divisions in plants and animals (meiosis, reduction).)

morphologically, of cells, and subsists, physiologically, by means of the 'reciprocal action' of the cells,"—this was the cell standpoint of Schleiden and Schwann, and it is no exaggeration to say that this same conception has dominated the cell-theory almost to the present day.<sup>1</sup> The frequently striking correlation between cell-division and cell-differentiation in development has caused this process to be regarded as dependent on cell-division, while a wholly exaggerated importance has been attached to the distinction between "unicellular" and "multicellular" organisms—between "intercellular" and "intracellular" organs. The influence of the "cells" upon one another, the subordination of the cell's growth, division and differentiation, to the requirements of the whole organism—seen in normal growth, but nowhere more strikingly than in development and regeneration,—is, however, very difficult of explanation in terms of the cell-theory as this was, until quite recently, generally understood. The very elaborate regional differentiation of the protoplasm often seen in the Protozoa sufficiently indicate that multicellular structure is no essential condition for complex regional differentiation. That the regional differentiation of the protoplasm in the Metazoa should usually correspond with cell-limits is scarcely surprising. Nor is it to be wondered at that, with so convenient a mechanism for segregation to hand as cell-division, the progressive differentiation seen during development should often appear to go hand in hand with this process. In recent years, however, evidence has been steadily accumulating to show that this association between cell-division and regional differentiation of the protoplasm in development is a casual one—as casual, and as natural, as the correspondence between cell limits and regional differentiation in the formed tissues. The fact that the regional differentiation may be foreshadowed in the egg before cleavage begins,<sup>2</sup>—that as Driesch has shown, the mode of cleavage may be artificially altered without affecting the ultimate organization of the embryo,—and many other similar observations, tend to emphasize the importance of the "organism" standpoint (C. O. Whitman, 1903, p. 642) in contradistinction to the widely prevalent "cell" standpoint. The occurrence of syncytial organs and organisms, and the increasing frequency with which protoplasmic continuity is being demonstrated between all kinds of cells, are facts tending in the same direction. In the plant kingdom the growth of the mass has been recognized as the primary factor in development;<sup>3</sup> *die Pflanze bildet Zellen, nicht die Zelle bildet Pflanzen* (de Bary). For the animal kingdom this "Inadequacy of the Cell-Theory of Development" has been maintained amongst others by Whitman,<sup>4</sup> and by Adam Sedgwick.<sup>5</sup> The latter author, mainly as the result of work on the development of *Peripatus* and of Elasmobranch embryos, regards the developing embryo as a continuous protoplasmic reticulum, for the nuclei of which the limiting epithelial layers constitute as it were a breeding ground. Differentiation is a regional specialization of this nucleated meshwork, and is not to be regarded as the result of the proliferation and subsequent specialization of cells predestined by cleavage for this end.

It is possible to suggest a mechanico-physical explanation of multicellular structure which will deprive the cell of much of its assumed significance as a unit of organization. The fact that surface area becomes relatively less extensive as bulk increases would alone set a limit to the size of "unicellular" organisms; for not only is there a constant reaction between nucleus and cytoplasm through the nuclear membrane, but the surface of the cell serves both for the intake of food and the elimination of waste material. In addition to the limit thus imposed upon the cytoplasmic area which can be effectually controlled by the nucleus, and the necessity for a minimum surface area to the protoplasmic mass, the advantages of the more or less complete

<sup>1</sup> Whitman, *Jour. Morph.*, 1903.

<sup>2</sup> This "Precocious segregation" (Lankester, 1877) is well seen in the eggs of many Ctenophorae, Annelids, Gastropods and Nematodes. See the papers by Lillie (1901), Conklin (1902), &c., and especially Wilson on "Dentalium," *Journ. of Exp. Zool.*, No. 1, 1904.

<sup>3</sup> Hofmeister, de Bary, Sachs, &c.

<sup>4</sup> *Loc. cit.*

<sup>5</sup> *Quart. Journ. Micro. Science*, 1894, vol. xxxvii.

subdivision of the living substance into—as far as their metabolism is concerned—semi-autonomous units, is indicated by the mechanical support derived from the specialized cell walls and turgescence of the plant, and the intercellular secretions of the animal tissues. It is more than possible that these two conditions—i.e. surface area for diffusion, and mechanical support—are alone responsible for the origin of multicellular structure, and that the sharply defined character this now so generally possesses has been secondarily acquired as a result of the facilities it undoubtedly offers for regional specialization in the protoplasmic mass.

**BIBLIOGRAPHY.**—The special literature of cytology has grown to large dimensions. The following are the more important textbooks and papers of general interest: E. B. Wilson, *The Cell in Development and Inheritance* (2nd ed., 1900); A. Gurwitsch, *Morphologie und Biologie der Zelle* (Jena, 1904); O. Hertwig, *Allgemeine Biologie* (Jena, 1906); Korschelt and Heider, *Lehrbuch der vergl. Entwicklungsgeschichte der wirbellosen Tiere*, Allgem. Teil, "The Germ Cells and Experimental Embryology" (Jena, 1903); Whitman, "The Inadequacy of the Cell Theory of Development," *Journ. Morph.* viii., 1893; Adam Sedgwick, "On the Inadequacy of the Cellular Theory of Development," *Quart. Journ. Micro. Science*, xxxvii.; G. C. Bourne, "A Criticism of the Cell Theory" (an answer to Sedgwick's paper), *Quart. Journ. Micro. Science*, xxxviii.; Th. Boveri, "Befruchtung," *Merkel-Bonnets Ergebnisse der Anat. u. Entwicklungsgesch.* Bd. i. (1892), *Das Problem der Befruchtung* (Jena, 1902), *Ergebnisse über die Konstitution der chromatischen Substanz des Zellkerns* (Jena, 1904); J. Rückert, "Die Chromatinreduktion bei der Reifung der Sexualzellen," *Merkel-Bonnets Ergebnisse*, Bd. iii. (1894); V. Häcker, "Die Reifungserscheinungen," *Ergebn. Anat. u. Entwicklungsgesch.* Bd. viii. (1898); F. Meves, "Zellteilung," *Merkel-Bonnets Ergebnisse*, Bd. viii. (1898, 1899); W. Waldeyer, "Die Geschlechtszellen," in O. Hertwig's *Handbuch der vergleich. u. experiment. Entwicklungslehre d. Wirbeltiere* (1901, 1903). (G. C. C.)

**CYZICENUS**, the architectural term given by Vitruvius to the large hall, used by the Greeks, which faced the north, with a prospect towards the gardens; the windows of this hall opened down to the ground, so that the green verdure could be seen by those lying on the couches.

**CYZICUS**, an ancient town of Mysia in Asia Minor, situated on the shoreward side of the present peninsula of Kapu-Dagh (Arctonnesus), which is said to have been originally an island in the Sea of Marmora, and to have been artificially connected with the mainland in historic times. It was, according to tradition, occupied by Thessalian settlers at the coming of the Argonauts, and in 756 B.C. the town was founded by Greeks from Miletus. Owing to its advantageous position it speedily acquired commercial importance, and the gold *staters* of Cyzicus were a staple currency in the ancient world till they were superseded by those of Philip of Macedon. During the Peloponnesian War (431–404 B.C.) Cyzicus was subject to the Athenians and Lacedaemonians alternately, and at the peace of Antalcidas (387 B.C.), like the other Greek cities in Asia, it was made over to Persia. The history of the town in Hellenistic times is closely connected with that of the dynasts of Pergamum, with whose extinction it came into direct relations with Rome. Cyzicus was held for the Romans against Mithradates in 74 B.C. till the siege was raised by Lucullus: the loyalty of the city was rewarded by an extension of territory and other privileges. Still a flourishing centre in Imperial times, the place appears to have been ruined by a series of earthquakes—the last in A.D. 1063—and the population was transferred to Artaki at least as early as the 13th century, when the peninsula was occupied by the Crusaders. The site is now known as Bal-Kiz (Παλαία Κύζικος?) and entirely uninhabited, though under cultivation. The principal extant ruins are:—the walls, which are traceable for nearly their whole extent, a picturesque amphitheatre intersected by a stream, and the substructures of the temple of Hadrian. Of this magnificent building, sometimes ranked among the seven wonders of the ancient world, thirty-one immense columns still stood erect in 1444. These have since been carried away piecemeal for building purposes by the Turks.

See J. Marquardt, *Cyzicus* (Berlin, 1830); G. Perrot, *Exploration de la Galatie* (Paris, 1862); F. W. Hasluck and A. E. Henderson in *Journal of Hellenic Studies* (1904), 135–143. (F. W. HA.)



**CZARNIECKI, STEPHEN** (1599-1665), Polish general, learnt the science of war under Stanislaw Koniecpolski in the Prussian campaigns against Gustavus Adolphus (1626-1629), and under Wladislaus IV. in the Muscovite campaign of 1633. On the 15th of April 1648 he was one of the many noble Polish prisoners who fell into the hands of Chmielnicki at the battle of "Yellow Waters," and was sent in chains to the Crimea, whence he was ransomed in 1649. He took an active part in all the subsequent wars with the Cossacks and received more disfiguring wounds than any other commander. When Charles X. of Sweden invaded Poland in 1655, Czarniecki distinguished himself by his heroic defence of Cracow, which he only surrendered under the most honourable conditions. His energy and ability as a leader of guerillas hampered Charles X. at every step, and though frequently worsted he from time to time inflicted serious defeats upon the Swedes, notably at Jaroslaw and at Kozenice in 1656. Under his direction the popular rising against the invader ultimately proved triumphant. It was he who brought King John Casimir back from exile and enabled him to regain his lost kingdom. It was against his advice that the great battle of Warsaw was fought, and his subsequent strategy neutralized the ill effects of that national disaster. On the retirement of the Swedes from Cracow and Warsaw, and the conclusion of the treaty of Copenhagen with the Danes, he commanded the army corps sent to drive the troops of Charles X. out of Jutland and greatly contributed to the ultimate success of the Allies. On the conclusion of the Peace of Oliva, which adjusted the long outstanding differences between Poland and Sweden, Czarniecki was transferred to the eastern frontier where the war with Muscovy was still raging. In the campaign of 1660 he won the victories of Polonka and Lachowicz and penetrated to the heart of the enemy's country. The diet of 1661 publicly thanked him for his services; the king heaped honours and riches upon him, and in 1665 he was appointed acting commander-in-chief of Poland, but died a few days after receiving this supreme distinction. By his wife Sophia Kobierzycka he left two daughters. Czarniecki is rightly regarded as one of the most famous of heroic Poland's great captains, and to him belongs the chief merit of extricating her from the difficulties which threatened to overwhelm her during the disastrous reign of John Casimir. Czarniecki raised partisan-warfare to the dignity of a science, and by his ubiquity and tenacity demoralized and exhausted the regular armies to which he was generally opposed.

See Ludwik Jenike, *Stephen Czarniecki* (Pol.) (Warsaw, 1891); Michal Dymitr Krajewski, *History of Stephen Czarniecki* (Pol.), (Cracow, 1859).

**CZARTORYSKI, ADAM GEORGE, PRINCE** (1770-1861), Polish statesman, was the son of Prince Adam Casimir Czartoryski and Isabella Fleming. After a careful education at home by eminent specialists, mostly Frenchmen,<sup>1</sup> he first went abroad in 1786. At Gotha he heard Goethe read his *Iphigenie auf Tauris*, and made the acquaintance of the dignified Herder and "fat little Wieland." In 1789 he visited England with his mother, and was present at the trial of Warren Hastings. On a second visit in 1793 he made many acquaintances among the English aristocracy and studied the English constitution. In the interval between these visits he fought for his country during the war of the second partition, and would subsequently have served under Kosciuszko also had he not been arrested on his way to Poland at Brussels by the Austrian government. After the third partition the estates of the Czartoryskis were confiscated, and in May 1795 Adam and his younger brother Constantine were summoned to St Petersburg; later in the year they were commanded to enter the Russian service, Adam becoming an officer in the horse, and Constantine in the foot guards. Catherine was so favourably impressed by the youths that she restored them part of their estates, and in the beginning of 1796 made them gentlemen in waiting. Adam had already met the grand duke Alexander at a ball at the princess Golitsuin's, and the youths at once conceived a strong "intellectual friendship" for each other. On the accession of the emperor Paul,

<sup>1</sup> Among them was the famous democrat Dupont de Nemours.

Czartoryski was appointed adjutant to Alexander, now Cesarevich, and was permitted to revisit his Polish estates for three months. At this time the tone of the Russian court was extremely liberal, humanitarian enthusiasts like Peter Volkonsky and Nikolai Novosiltsov possessing great influence.

Throughout the reign of Paul, Czartoryski was in high favour and on terms of the closest intimacy with the emperor, who in December 1798 appointed him ambassador to the court of Sardinia. On reaching Italy Czartoryski found that the monarch to whom he was accredited was a king without a kingdom, so that the outcome of his first diplomatic mission was a pleasant tour through Italy to Naples, the acquisition of the Italian language, and a careful exploration of the antiquities of Rome. In the spring of 1801 the new emperor Alexander summoned his friend back to St Petersburg. Czartoryski found the tsar still suffering from remorse at his father's assassination, and incapable of doing anything but talk religion and politics to a small circle of private friends. To all remonstrances he only replied "There's plenty of time." The senate did most of the current business; Peter Vasilevich Zavadovsky, a pupil of the Jesuits, was minister of education. Alexander appointed Czartoryski curator of the academy of Vilna (April 3, 1803) that he might give full play to his advanced ideas. He was unable, however, to give much attention to education, for from the beginning of 1804, as adjunct of foreign affairs, he had the practical control of Russian diplomacy. His first act was to protest energetically against the murder of the duc d'Enghien (March 20, 1804); and insist on an immediate rupture with France. On the 7th of June the French minister Hédouville quitted St Petersburg; and on the 11th of August a note dictated by Czartoryski to Alexander was sent to the Russian minister in London, urging the formation of an anti-French coalition. It was Czartoryski also who framed the Convention of the 6th of November 1804, whereby Russia agreed to put 125,000 and Austria 235,000 men in the field against Napoleon. Finally, on the 11th of April 1805 he signed an offensive-defensive alliance with England. But his most striking ministerial act was a memorial written in 1805; but otherwise undated, which aimed at transforming the whole map of Europe. In brief it amounted to this. Austria and Prussia were to divide Germany between them. Russia was to acquire the Dardanelles, the Sea of Marmora, the Bosphorus with Constantinople, and Corfu. Austria was to have Bosnia, Wallachia and Ragusa. Montenegro, enlarged by Mostar and the Ionian Islands, was to form a separate state. England and Russia together were to maintain the equilibrium of the world. In return for their acquisitions in Germany, Austria and Prussia were to consent to the erection of an autonomous Polish state extending from Danzig to the sources of the Vistula, under the protection of Russia. Fantastic as it was in some particulars, this project was partly realized<sup>2</sup> in more recent times, and it presented the best guarantee for the independent existence of Poland which had never been able to govern itself. But in the meantime Austria had come to an understanding with England as to subsidies, and war had begun.

In 1805 Czartoryski accompanied Alexander both to Berlin and Olmütz as chief minister. He regarded the Berlin visit as a blunder, chiefly owing to his profound distrust of Prussia; but Alexander ignored his representations, and in February 1807 he lost favour and was superseded by Andrei Eberhard Budberg. But though no longer a minister Czartoryski continued to enjoy Alexander's confidence in private, and in 1810 the emperor candidly admitted to Czartoryski that his policy in 1805 had been erroneous and he had not made a proper use of his opportunities. The same year Czartoryski quitted St Petersburg for ever; but the personal relations between him and Alexander were never better. The friends met again at Kalisch shortly before the signature of the Russo-Prussian alliance of the 20th of February 1813, and Czartoryski was in the emperor's suite at Paris in 1814, and rendered his sovereign material services at the congress of Vienna.

On the erection of the congressional kingdom of Poland <sup>2</sup> e.g. Austria obtained Bosnia, and Montenegro has been enlarged.

every one thought that Czartoryski, who more than any other man had prepared the way for it, would be its first governor-general, but he was content with the title of senator-palatine and a share in the administration. In 1817 the prince married Anna Sapiezanko, the wedding leading to a duel with his rival Pac. On the death of his father in 1823 he retired to his ancestral castle at Pulawy; but the Revolution of 1830 brought him back to public life. As president of the provisional government he summoned (Dec. 18th, 1830) the Diet of 1831, and after the termination of Chlopicki's dictatorship was elected chief of the supreme council by 121 out of 138 votes (January 30th). On the 16th of September his disapproval of the popular excesses at Warsaw caused him to quit the government after sacrificing half his fortune to the national cause; but it must be admitted that throughout the insurrection he did not act up to his great reputation. Yet the energy of the sexagenarian statesman was wonderful. On the 23rd of August he joined Girolano Ramorino's army-corps as a volunteer, and subsequently formed a confederation of the three southern provinces of Kalisch, Sandomir and Cracow. At the end of the war he emigrated to France, where he resided during the last thirty years of his life. He died at his country residence at Montfermeil, near Meaux, on the 15th of July 1861. He left two sons, Witold (1824-1865), and Wladyslaw (1828-1894), and a daughter Isabella, who married Jan Dzialynski in 1857. The principal works of Czartoryski are *Essai sur la diplomatie* (Marseilles, 1830); *Life of J. U. Niemcewicz* (Pol.) (Paris, 1860); *Alexander I. et Czartoryski: correspondance . . . et conversations (1801-1823)* (Paris, 1865); *Mémoires et correspondance avec Alex. I.*, with preface by C. de Mazade, 2 vols. (Paris, 1887); an English translation *Memoirs of Czartoryski, &c.*, edited by A. Gielguch, with documents relating to his negotiations with Pitt, and conversations with Palmerston in 1832 (2 vols., London, 1888).

See Bronislaw Zaleski, *Life of Adam Czartoryski* (Pol.) (Paris, 1881); Lubomir Gadon, *Prince Adam Czartoryski* (Pol.) (Cracow, 1892); Ludovik Debicki, *Pulawy*, vol. iv.; Lubomir Gadon, *Prince Adam Czartoryski during the Insurrection of November* (Pol.) (Cracow, 1900). (R. N. B.)

**CZARTORYSKI, FRYDERYK MICHAL, PRINCE** (1696-1775), Polish statesman, was born in 1696. Of small means and no position, he owed his elevation in the world to extraordinary ability, directed by an energetic but patriotic ambition. After a careful education on the best French models, which he completed at Paris, Florence and Rome, he attached himself to the court of Dresden, and through the influence of Count Fleming, the leading minister there, obtained the vice-chancellorship of Lithuania and many other dignities. Czartoryski was one of the many Polish nobles who, when Augustus II. was seriously ill at Bialyostok in 1727, signed the secret declaration guaranteeing the Polish succession to his son; but this did not prevent him from repudiating his obligations when Stanislaus Leszczyński was placed upon the throne by the influence of France in 1733. When Stanislaus abdicated in 1735 Czartoryski voted for Augustus III. (of Saxony), who gladly employed him and his family to counteract the influence of the irreconcilable Potokis. For the next forty years Czartoryski was certainly the leading Polish statesman. In foreign affairs he was the first to favour an alliance with Russia, Austria and England, as opposed to France and Prussia—a system difficult to sustain and not always beneficial to Poland or Saxony. In Poland Czartoryski was at the head of the party of reform. His palace was the place where the most promising young gentlemen of the day were educated and sent abroad that they might return as his coadjutors in the great work. His plan aimed at the restoration of the royal prerogative and the abolition of the *liberum veto*, an abuse that made any durable improvement impossible. These patriotic endeavours made the Czartoryskis very unpopular with the ignorant *szlachta*, but for many years they had the firm and constant support of the Saxon court, especially after Brühl succeeded Fleming.

Czartoryski reached the height of his power in 1752 when he was entrusted with the great seal of Lithuania; but after that

date the influence of his rival Maiszek began to prevail at Dresden, whereupon Czartoryski sought a reconciliation with his political opponents at home and foreign support both in England and Russia. In 1755 he sent his nephew Stanislaus Poniatowski to St Petersburg as Saxon minister, a mission which failed completely. Czartoryski's philo-Russian policy had by this time estranged Brühl, but he frustrated all the plans of the Saxon court by dissolving the diets of 1760, 1761 and 1762. In 1763 he went a step farther and proposed the dethronement of Augustus III., who died the same year. During the ensuing interregnum the prince chancellor laboured night and day at the convocation diet of 1764 to reform the constitution, and it was with displeasure that he saw his incompetent nephew Stanislaus finally elected king in 1765. But though disgusted with the weakness of the king and obliged to abandon at last all hope of the amelioration of his country, Czartoryski continued to hold office till the last; and as chancellor of Lithuania he sealed all the partition treaties. He died in the full possession of his faculties and was considered by the Russian minister Repnin "the soundest head in the kingdom." It is a mistake, however, to regard Czartoryski as the sole reforming statesman of his day, and despite his great services there were occasions when the partisan in him got the better of the statesman. His foreign policy, moreover, was very vacillating, and he changed his "system" more frequently perhaps than any contemporary diplomatist. But when all is said he must remain one of the noblest names in Polish history.

See the *Correspondence* of Czartoryski in the Collections of the Russian Historical Society, vols. 7, 10, 13, 48, 51, 67 (St Petersburg, 1890, &c.); Wladyslaw Tadeusz Kisielewski, *Reforms of the Czartoryscy* (Pol.) (Sambor, 1880); Adalbert Roepell, *Polen um die Mitte des XVIII. Jahrhunderts* (Gotha, 1876); Jacques Victor Albert de Broglie, *Le Secret du roi* (Paris, 1878); Antoni Waliszewski, *The Poloccy and the Czartoryscy* (Pol.); Carl Heinrich Heyking, *Aus Polens und Kurlands letzten Tagen* (Berlin, 1897); Ludwik Denbicki, *Pulawy* (Pol.) (Lemberg, 1887-1888). (R. N. B.)

**CZECH** (in Bohemian, *Čech*), a name which signifies an inhabitant of Čechy, the native designation of Bohemia. The Czechs belong to the Slavic race, and according to the usually accepted division they form, together with the Poles and the almost extinct Lusatians, the group of the Western Slavs. Speaking generally, it can be said that the Czechs inhabit a large part of Bohemia, a yet larger part of Moravia, parts of Silesia—both Austrian and Prussian—and extensive districts in northern Hungary. In the 19th century the Czechs of Hungary—much to their own detriment—developed a written language that differs slightly from that used in Bohemia, but as regards their race they are identical with the Bohemians and Moravians. Beyond the borders of this continuous territory there are many Czechs in Lower Austria. Vienna in particular has a large and increasing Czech population. There are also numerous Czechs in Russia, particularly Volhynia, in the United States—where a large number of newspapers and periodicals are published in the Czech language—and in London. Though the statistics are very uncertain and untrustworthy, it can be stated that the Czechs number about eight millions.

The period at which the Czechs settled in Bohemia is very uncertain; all theories, indeed, with regard to the advent of the Slavs in northern and eastern Europe are merely conjectural. It was formerly generally accepted as a fact that all Bohemia was originally inhabited by Celtic tribes, who were succeeded by the Germanic Marcomanni, and later by the Slavic Czechs. According to a very ancient tradition reproduced in the book of Cosmas, the earliest Bohemian chronicler, the Czechs arrived in Bohemia led by their eponymous chief Čechus, and first settled on the Rip Hill (Georgberg) near Roudnice. It is a strange proof of the intense obscurity of the earliest Bohemian history that Cosmas, writing at the beginning of the 12th century, is already unaware of the existence of pre-Slavic inhabitants of Bohemia. It is historically certain that the Czechs inhabited parts of Bohemia as early as the 6th century. In the absence of all historical evidence, modern Czech scholars have endeavoured by other means to throw some light on the earliest period of the

Czechs. By craniological studies and a thorough examination of the fields where the dead were burnt (in Czech *žárové pole*), still found in some parts of Bohemia, they have arrived at the conclusion that parts of the country were inhabited by Czechs, or at least by Slavs, long before the Christian era, perhaps about the year 500 B.C.

It is certain that the Slavs at the time when they first appeared in history had a common language, known as the ancient Slavic (*praslovanský*) language. When in the course of time the Slavs occupied various countries, which were often widely apart, different dialects arose among them, many of which were influenced by the language of the neighbouring non-Slavic populations. Thus the Czech language from an early period absorbed many German words. It is probable that the development of the Czech language as an independent one, was very gradual. Existing documents, such as the hymn to St Wenceslas, which belongs to the second half of the 10th century, are written partly in old-Slavic, partly in Czech. When the Slavs first occupied Bohemia, they were probably divided into several tribes, of which the Czechs, who inhabited Prague and the country surrounding it, were the most powerful. It is probable that these smaller tribes were only gradually subdued by the Czechs and that some of them had previously to their absorption adopted special dialects. The Netolice, Lučane, Pšovane, Sedlčane appear to have been among the more important tribes who were forced to acknowledge the supremacy of the Czechs, and it may be conjectured that their language for a time differed slightly from that of their conquerors. The Czech language has, like all Slavic ones, a strong tendency to develop dialects; this was the case at the time of its first appearance as an independent language, and has to a certain extent continued up to the present day. The dialects of Moravia and the northern districts of Hungary still show variations from the generally accepted forms of the Czech language, though since the foundation of the Czech university of Prague this—at least among the educated classes—is no longer true to the same extent as it formerly was. The Czech language at the time of its formation naturally remained closest to those other Slav-speaking countries which were geographically its neighbours, the Poles and the Lusatians, and it may be said that this is still the case. The Czech language at the time when in the 12th and 13th centuries it first appears as a separate and distinct one, differed considerably from that of the present day. Ancient Czech had several diphthongs, such as *ia, ie, iu, uo* and *au*, that are unknown to the present language. The letter "l" had a threefold sound, and besides the letters *b, p, m, v*, the softer forms *b', p', m', v'*, were also in existence. The letter *g* (as in other Slavic languages) was often used where modern Czechs employ the letter *h*. Ancient Bohemian had three numbers, the singular, plural and dual; of the dual only scant vestiges remain in modern Czech.

Once it had obtained its independence, the Czech language developed rapidly, and the philosophical and theological writings of Thomas of Štítavý (1331-1401) proved that it could already be used even for dealing with the most abstract subjects, though Štítavý was blamed by the monks for not writing in Latin, as was then customary. The Czech language is greatly indebted also to John Hus, whose best and most original works were written in the language of his country. Hus showed great interest in the orthography and grammar of his language, and has devoted an interesting treatise entitled "*Orthographia bohémica*" to it. As already mentioned, the Czech language had sprung from diverse dialects, and Hus endeavoured to establish uniformity. To the Bohemian reformer is also due the system of so-called diacritic marks—such as *ě, ž, ý*—which with some modifications are still in use.<sup>1</sup> The Latin characters which were in the earliest times, as again at the present day, used when writing Czech, are quite unable to reproduce some sounds peculiar to Slavic languages. This was remedied by the introduction of these marks, and Hus's system of orthography became known as the diacritic one. The Bohemian reformer,

<sup>1</sup>For the pronunciation of these see the footnote at the beginning of the article BOHEMIA.

zealous for the purity of the language of his country, often in his sermons inveighed quaintly and vehemently against those who defiled the Czech language by introducing numerous "Germanisms." A century later the Czech language was largely indebted to the then recently founded community of the Bohemian (or as they were also often called, Moravian) brethren. A member of the community, Brother John Blakoslav, wrote in 1571 a *Grammatika Česká*, that still has considerable philological interest. It contains a full account of the construction of the Czech language, based on Latin grammar, with which the writer was thoroughly acquainted. Divines belonging to the same community also at the end of the 16th century published at Kralice in Moravia a complete Czech version of the Old and New Testaments. Together with the *Labyrint Světa* (Labyrinth of the World) of Komenský (Comenius), who was also a member of the brotherhood, it can be considered a model of the Czech language in the period immediately preceding its downfall.

The Czechs have always enthusiastically upheld the language of their country. In ancient Czech, indeed, the same word *jasyk* denotes both "nation" and "language." As late as in 1608 a decree of the estates of Bohemia declared that Czech was the only official and recognized state-language, and that all who wished to acquire citizenship in the country should be obliged to acquire the knowledge of it. While all patriots thus supported the national language, it was greatly disliked by the absolutists who were opposed to the ancient free constitution of Bohemia, as well as by all who favoured the Church of Rome. The overthrow of Bohemian independence at the battle of the White Mountain (1620) was therefore shortly followed by the decline of the Czech language. All Czech writings which could be found were destroyed by the Austrian authorities as being tainted with heresy, while no new books written in Czech appeared, except occasional prayer-books and almanacs. For these scanty writings the German so-called "Schwabach" characters were used, and this custom only ceased in the middle of the 19th century. The Czech language, for some time entirely excluded from the schools, all but ceased to be written, and its revival at the beginning of the 19th century was almost a resurrection.

The first originator of the movement, Joseph Dobrovský or Doubravský (1753-1829) seems himself, at least at the beginning of his life, to have considered it impossible that Czech should again become a widely-spoken language, and one whose literature could successfully compete with that of larger countries. Yet it was the works of this "patriarch of Slavic philology" which first drew the public attention to the half-forgotten Czech language. Dobrovský's work was afterwards continued by Kolar, Jungmann, Palacký, Šafařek, and many others, and Czech literature has, both as regards its value and its extension, reached a height that in the middle of the 19th century would have appeared incredible.

Though met by constant opposition on the part of the Austrian authorities, the Czechs have succeeded in re-establishing the use of their language in many of the lower and middle schools of Bohemia and Moravia, and the foundation of a Czech university at Prague (1882-1884) has of course contributed very largely to the ever-increasing expansion of the Czech language. The national language has at all times appeared to the Bohemians as the palladium of their nationality and independence, and the movement in favour of the revival of the Czech language necessarily became a political one, as soon as circumstances permitted. The friends of the national language at the beginning of the 19th century were generally known as the *vlastenci* (patriots), but when in 1848 representatives of many parts of Austria met at Vienna, the deputies of Bohemia—with the exception of the Germans—formed what was called the national or Czech party. Parliamentary government did not at that period long survive, and at the end of the year 1851 absolutism had been re-established. In 1860 a new attempt to establish constitutional government in Austria was made, and representatives of the Czech party appeared at the provincial diet of Prague and the central parliament at Vienna. The Czech party endeavoured to obtain the re-establishment of the ancient

Bohemian constitution, but, allied as they were with a large part of the Bohemian nobility, it was their policy to maintain a somewhat conservative attitude. After having absented themselves for a considerable time from the parliament of Vienna, the legality of which they denied, the Czech deputies reappeared in Vienna in 1879, and, together with the representatives of the Bohemian nobility, formed there what was known as the *Česky Klub*.

While the Czechs for a time continued united at Vienna, a schism among them had some time previously occurred at Prague. Dissatisfied with the policy of the Czechs, a new party had been formed in Bohemia which affected more advanced views and became known as the "Young Czech" party. The more conservative Czechs were henceforth known as the "Old Czechs." The "Young Czechs," when the party first became independent in 1872, had thirty-five representatives in the diet of Prague, but at the elections of 1874 their number was reduced to seven. They continued, however, to gain in strength, and obtained for a long time a large majority in the diet, while the Old Czech party for a considerable period almost disappeared. In Vienna also the Old Czech party gradually lost ground. Its leader Dr Rieger, indeed, obtained for the Czechs certain concessions which, underrated at the time, have since proved by no means valueless. The decision of the Old Czech party to take part at a conference in Vienna under the presidency of Count Taaffe—then Austrian prime-minister—which was to settle the national differences in Bohemia, caused its complete downfall. The proposals of the Vienna conference were rejected with indignation, and the Old Czechs, having become very unpopular, for a time ceased to contest the elections for the legislative assemblies of Prague and Vienna. The victorious Young Czechs, however, soon proved themselves very unskilful politicians. After very unsuccessfully assuming for a short time an attitude of intransigent opposition, they soon became subservient to the government of Vienna to an extent which the Old Czechs had never ventured. Dr Kramář, in particular, as leader of the Young Czech party, supported the foreign policy of Austria even when its tendency was most hostile to the interests of Bohemia. The Vienna government has, in recent years, as regards internal affairs, also adopted a policy very unfavourable to the Czech race. Even the continuance of some of the concessions formerly obtained by the Old Czechs has become doubtful. At the elections to the diet of Prague which took place in March 1908, the Young Czechs lost many seats to the Old Czechs, while the Agrarians, Clericals and Radicals were also successful.

See J. Dobrovský, *Geschichte der böhmischen Sprache* (1818), and *Lehrgebäude der böhmischen Sprache* (1819); J. Błahoslav, *Grammatika Česká*, printed from MS. (1867); Lippert, *Social Geschichte Böhmens* (1896); Gebauer, *Slovník Staročeský* (Dictionary of the ancient Czech language, 1903); I. Herzer, *Böhmisch-deutsches Wörterbuch* (Prague, 1901, &c.); Coufal and Zába, *Slovník Česko-latinský a Latinsko-český* (Prague, 1904, &c.), and *Historická Uluonice Jazyka českého* (Historical grammar of the Czech language, 1904); Morfill, *Grammar of the Bohemian or Cech Language* (1899); Bourlier, *Les Tchèques* (1897).  
(L.)

**CZENSTOCHOWA**, or **CHENSTOKHOV**, a town of Russian Poland, in the government of Piotrkow, on the left bank of the Warta (Warthe), 143 m. S.W. of Warsaw, on the railway between that city and Cracow. Pop. (1900) 53,650. Here is a celebrated monastery crowning the steep eminence called Yaznagora or Klarenberg. It was founded by King Vladislaus of the house of Jagiello and was at one time fabulously wealthy. In 1430 it was attacked and plundered by the Hussites; in 1655, and again in 1705, it bravely resisted the Swedes; but in 1772 it was forced to capitulate to the Russians, and in 1793 to the Prussians. The fortifications, which had been built from 1500 onwards, were razed in 1813. This monastery, which is occupied by monks of the order of Paul the Hermit, contains over the altar in its church a painted image of the Virgin, traditionally believed to have been painted by St Luke, and visited annually by throngs (400,000) of pilgrims from all over Russia, eastern Prussia and other neighbouring regions. The inhabitants of

the town manufacture cotton, cloth and paper, and do a lively business in rosaries, images, scapularies and so forth.

**CZERNOWITZ** (Rum. *Cernautsi*), the capital of the Austrian duchy of Bukovina, 420 m. E. of Vienna and 164 m. S.E. of Lemberg by rail. Pop. (1900) 69,619. It is picturesquely situated on a height above the right bank of the river Pruth, which is crossed here by two bridges, of which one is a railway bridge. Czernowitz is a clean, pleasant town of recent date, and is the seat of the Greek Orthodox archbishop or metropolitan of Bukovina. The principal buildings include the Greek Orthodox cathedral, finished in 1864 after the model of the church of St Isaac at St Petersburg; the Armenian church, in a mixed Gothic and Renaissance style, consecrated in 1875; a handsome new Jesuit church, and a new synagogue in Moorish style, built in 1877. The most conspicuous building of the town is the Episcopal palace, in Byzantine style, built in 1864-1875, which is adorned with a high tower and possesses a magnificent reception hall. In one of the public squares stands the Austrian monument, executed by Pekary and erected in 1875 to commemorate the centenary of Austria's possession of Bukovina. It consists of a marble statue of Austria erected on a pedestal of green Carpathian sandstone. The Francis Joseph University, also opened in 1875, had 50 lecturers and over 500 students in 1901. The language of instruction is German, and it possesses three faculties: theology, law and philosophy. The industry is not very developed and consists chiefly in corn-milling and brewing. An active trade is carried on in agricultural produce, wood, wool, cattle and spirits. Czernowitz has a mixed population, which consists of Germans, Ruthenians, Rumanians, Poles, Jews, Armenians and Gypsies. The town presents, therefore, a cosmopolitan and on market days a very varied appearance, when side by side with people turned out in the latest fashions from Paris or Vienna, we meet peasants of various nationalities, attired in their national costume, intermingled with very scantily-clad Gypsies.

On the opposite bank of the Pruth, at a very little distance to the N., is situated the town of Sadagora (pop. 4512, mostly Jews), where a famous cattle fair takes place every year.

Czernowitz was at the time of the Austrian occupation (1775) an unimportant village. It was created a town in 1786, and at the beginning of the 19th century it numbered only 5000 inhabitants.

**CZERNY, KARL** (1791-1857), Austrian pianist and composer, was born at Vienna on the 21st of February 1791. His father, who was a teacher of the piano, trained him for that instrument from an early age with such success that he performed in public at the age of nine, and commenced his own career as a teacher at fourteen. He was brought under the notice of Beethoven, and was his pupil in the sense in which the great master had pupils. It is perhaps his greatest claim to distinction as a performer that he was selected to be the first to play Beethoven's celebrated Emperor concerto in public. He soon became the most popular teacher of his instrument in a capital which abounded in pianists of the first rank. Among his pupils he numbered Liszt, Theodor Döhler (1814-1843) and many others who afterwards became famous. As a composer he was prolific to an astonishing degree, considering the other demands on his time. His works, which included every class of composition, numbered 849 at the time of his death. Comparatively few of them possess high merit, and none is the production of genius. He had considerable skill in devising variations for the piano of the display type, and in this and other ways helped to develop the executive power which in the modern school of pianoforte playing seems to have reached the limits of the possible. His various books of exercises, elementary and advanced, of which the best known are the *Études de la vélocité*, have probably had a wider circulation than any other works of their class. To the theory of music he contributed a translation of Reicha's *Traité de composition*, and a work entitled *Umriss der ganzen Musikgeschichte*. Czerny died on the 15th of July 1857 at Vienna. Having no family, he left his fortune, which was considerable, to the Vienna Conservatorium and various benevolent institutions.

**D** The fourth letter in the English alphabet occupies the same position in the Latin, Greek and Phoenician alphabets, which represent the preceding stages in its history. The Phoenician name *Daleth* is represented by the Greek *Delta*. In form D has varied throughout its career comparatively little. In the earliest Phoenician it is  $\triangleleft$  with slight variations; in most Greek dialects  $\Delta$  which has been adopted as the Greek literary form, but in others as e.g. the earliest Attic  $\triangle$  or  $\triangleleft$ . The form with the rounded back, which has passed from Latin into the languages of western Europe, was borrowed from the Greeks of S.W. Italy, but is widely spread also amongst the peoples of the Peloponnese and of northern Greece. It arises from a form like  $\triangleright$  when the sides which meet to the right are written or engraved at one stroke. From a very early period one side of the triangle was often prolonged, thus producing a form  $\lrcorner$  which is characteristic of Aramaic from 800 B.C. In Greek this was avoided because of the likelihood of its confusion with  $\Theta$ , the oldest form of the symbol for *r*, but in the alphabets of Italy—which were borrowed from Etruscan—this confusion actually takes place. Etruscan had no sound corresponding to the symbol D (in inscriptions written from right to left,  $\Gamma$ ), and hence used it as a by-form for  $\Theta$ , the symbol for *r*. The Oscans and Umbrians took it over in this value, but having the sound *d* they used for it the symbol for *r* ( $\Theta$  in Umbrian,  $\Gamma$  in Oscan).

The sound which D represents is the voiced dental corresponding to the unvoiced *t*. The English *d*, however, is not a true dental, but is really pronounced by placing the tongue against the sockets of the teeth, not the teeth themselves. It thus differs from the *d* of French and German, and in phonetic terminology is called an alveolar. In the languages of India where both true dentals and alveolars are found, the English *d* is represented by the alveolar symbol (transliterated *ḍ*). Etymologically in genuine English words *d* represents in most cases *dh* of the original Indo-European language, but in some cases an original *t*. In many languages *d* develops an aspirate after it, and this *dh* becomes then a voiced spirant ( $\delta$ ), the initial sound of *there* and *that*. This has occurred widely in Semitic, and is found also in languages like modern Greek, where  $\delta$ , except after *v*, is always spirant, *δέρ* (= *not*) being pronounced like English *then*. As the mouth position for *l* differs from that for *d* only by the breath being allowed to escape past one or both sides of the tongue, confusion has arisen in many languages between *d* and *l*, the best-known being cases like the Latin *lacrima* as compared with the Greek *δάκρυον*. The English *tear* and the forms of other languages show that *d* and not *l* is the more original sound. Between vowels in the ancient Umbrian *d* passed into a sound which was transliterated in the Latin alphabet by *rs*; this was probably a sibilant *r*, like the Bohemian *ř*. In many languages it is unvoiced at the end of words, thus becoming almost or altogether identical with *t*. As an abbreviation it is used in Latin for the *praenomen* Decimus, and under the empire for the title *Divus* of certain deceased emperors. As a Roman numeral (= 500) it is only the half of the old symbol  $\text{D}$  (= 1000); this was itself the old form of the Greek  $\phi$ , which was useless in Latin as that language had no sound identical with the Greek  $\phi$ . (P. Gr.)

**DACCA**, a city of British India, giving its name to a district and division of Eastern Bengal and Assam. It was made the capital of that province on its creation in October 1905. The city is 254 m. N.E. by E. of Calcutta, on an old channel of the Ganges. Railway station, 10 m. from the terminus of the river steamers at Narayanganj. The area is about 8 sq. m. The population in 1901 was 90,542. The ruins of the English factory, St Thomas's church, and the houses of the European residents lie along the river banks. Of the old fort erected by Islam Khan, who in 1608 was appointed nawab of Bengal, and removed

his capital from Rajmahal to Dacca, no vestige remains; but the jail is built on a portion of its site. The principal Mahomedan public buildings, erected by subsequent governors and now in ruins, are the Katra and the Lal-bagh palace—the former built by Sultan Mahommed Shuja in 1645, in front of the *chawk* or market place. Its extensive front faced the river, and had a lofty central gateway, flanked by smaller entrances, and by two octagonal towers rising to some height above the body of the building. The Lal-bagh palace was commenced by Azam Shah, the third son of the emperor Aurangzeb. It originally stood close to the Buriganga river; but the channel has shifted its course, and there is now an intervening space covered with trees between it and the river. The walls on the western side, and the terrace and battlement towards the river, are of a considerable height, and present a commanding aspect from the water. These outworks, with a few gateways, the audience hall and the baths, were the only parts of the building that survived in 1840. Since then their dilapidation has rapidly advanced; but even in ruin they show the extensive and magnificent scale on which this princely residence was originally designed. It appears never to have been completed; and when Jean Baptiste Tavernier visited Dacca (c. 1666), the nawab was residing in a temporary wooden building in its court. The English factory was built about that year. The central part of the old factory continued to be used as a court-house till the 19th century, but owing to its ruinous state it was pulled down in 1829 or 1830; in 1840 the only portion that remained was the outward wall. The French and Dutch factories were taken possession of by the English in the years 1778 and 1781 respectively. In the mutiny of 1857 two companies of the 73rd Native Infantry which were stationed in the town joined in the revolt, but were overpowered by a small European force and dispersed. The city still shows some signs of its former magnificence. The famous manufacture of fine muslins is almost extinct, but the carving of shells, carried on from ancient times, is an important industry in the city. There are a Government college, a collegiate school and an unaided Hindu college. There is a large settlement of mixed Portuguese descent, known as Feringhis. Many of the public buildings, including the college, suffered severely from the earthquake of the 12th of June 1897; and great damage was done by tornadoes in April of 1888 and 1902.

The district of Dacca comprises an area of 2782 sq. m. In 1901 the population was 2,649,522, showing an increase of 11% in the decade. The district consists of a vast level plain, divided into two sections by the Dhaleswari river. The northern part, again intersected by the Lakshmia river, contains the city of Dacca, and as a rule lies well above flood-level.

Dacca is watered by a network of rivers and streams, ten of which are navigable throughout the year by native cargo boats of four tons burthen. Among them are the Meghna, the Ganges or Padma, the Lakshmia, a branch of the Brahmaputra, the Jamuna, or main stream of the Brahmaputra, the Mendi-Khali, a large branch of the Meghna, the Dhaleswari, an offshoot of the Jamuna, the Ghazi-khali and the Buriganga. The soil is composed of red ferruginous *kankar*, with a stratum of clay in the more elevated parts, covered by a thin layer of vegetable mould, or by recent alluvial deposits. The scenery along the Lakshmia is very beautiful, the banks being high and wooded. About 20 m. north of Dacca city, small ridges are met with in the Madhupur jungle, stretching into Mymensingh district. These hills, however, are mere mounds of from 20 to 40 ft. high, composed of red soil containing a considerable quantity of iron ore; and the whole tract is for the most part unproductive. Towards the city the red soil is intersected by creeks and morasses, whose margins yield crops of rice, mustard and *til* seed; while to the east of the town, a broad, alluvial, well-cultivated plain reaches as far as the junction of the Dhaleswari and Lakshmia rivers. The country lying to the south of the Dhaleswari is the most



fertile part of the district. It consists entirely of rich alluvial soil, annually inundated to a depth varying from 2 to 14 ft. of water. The villages are built on artificial mounds of earth, so as to raise them above the flood-level.

The wild animals found in the district comprise a few tigers, leopards and wild elephants, deer, wild pig, porcupines, jackals, foxes, hares, otters, &c. The green monkey is very common; porpoises abound in the large rivers. The manufactures consist of weaving, embroidery, gold and silver work, shell-carving and pottery. The weaving industry and the manufacture of fine Dacca muslins have greatly fallen off, owing to the competition of European piece goods. Forty different kinds of cloth were formerly manufactured in this district, the bulk of which during many years was made from English twist, country thread being used only for the finest muslins. It is said that, in the time of the emperor Jahangir, a piece of muslin, 15 ft. by 3, could be manufactured, weighing only 900 grains, its value being £40. In 1840 the finest cloth that could be made of the above dimensions weighed about 1600 grains, and was worth £10. Since then the manufacture has still further decayed, and the finer kinds are not now made at all except to order. The district is traversed by a line of the Eastern Bengal railway, but most of the traffic is still conducted by water. It is a centre of the jute trade.

The division of Dacca occupies the delta of the Brahmaputra, where it joins the main stream of the Ganges. It consists of the four districts of Dacca, Mymensingh, Faridpur and Backergunge. Its area is 15,837 sq. m. Its population in 1901 was 10,793,988.

**DACE, DARE, or DART** (*Leuciscus vulgaris*, or *L. dobula*), a freshwater fish belonging to the family *Cyprinidae*. It is an inhabitant of the rivers and streams of Europe north of the Alps, but it is most abundant in those of France and Germany. It prefers clear streams flowing over a gravelly bottom, and deep, still water, keeping close to the bottom in winter but disporting itself near the surface in the sunshine of summer. It is preyed upon by the larger predaceous fishes of fresh waters, and owing to its silvery appearance is a favourite bait in pike-fishing. The dace is a lively, active fish, of gregarious habits, and exceedingly prolific, depositing its eggs in May and June at the roots of aquatic plants or in the gravelly beds of the streams it frequents. Its flesh is wholesome, but is not held in much estimation. In appearance it closely resembles the roach, usually attaining a length of 8 or 9 in., with the head and back of a dusky blue colour and the sides of a shining silvery aspect, with numerous dark lines running along the course of the scales. The ventral and anal fins are white, tinged with pale red; the dorsal, pectoral and caudal tipped with black. The dace feeds on worms, insects, insect-larvae, and also on vegetable matter. It is abundant in many of the streams of the south of England, but is unknown in Scotland and Ireland. In America the name of dace is also applied to members of other genera of the family; the "horned dace" (*Semnotilus atromaculatus*) is a well-known variety.

**DACH, SIMON** (1605–1659), German lyrical poet, was born at Memel in East Prussia on the 29th of July 1605. Although brought up in humble circumstances, he received a careful education in the classical schools of Königsberg, Wittenberg and Magdeburg, and entered the university of Königsberg in 1626 as a student of theology and philosophy. After taking his degree, he was appointed in 1633 *Kollaborator* (teacher) and in 1636 co-rector of the Domschule (cathedral school) in that city. In 1639 he received the chair of poetry at the university of Königsberg, which he occupied until his death on the 15th of April 1659. In Königsberg he entered into close relations with Heinrich Albert (1604–1651), Robert Roberthin (1600–1648) and Sibylla Schwarz (1621–1638), and with them formed the so-called *Königsberger Dichtergruppe*. He sang the praises of the house of the electors of Brandenburg in a collection of poems entitled *Kurbrandenburgische Rose, Adler, Löwe und Scepter* (1661), and also produced many occasional poems, several of which became popular; the most famous of them is *Anke von Tharaw äss, de my geföllt* (rendered by Herder into modern German as *Annchen von Tharaw*), composed in 1637 in honour

of the marriage of a friend. Among his hymns, many of which are of great beauty, are the following: *Ich bin ja, Herr, in deiner Macht, Ich bin bei Gott in Gnaden durch Christi Blut und Tod*, and *O, wie selig seid ihr boch, ihr Frommen*.

Editions of Dach's poems have been published by W. Müller (1823), by H. Österley (for the Stuttgart *Literarischer Verein*, 1876); also selections by the same editor (1876), and in Kürschner's *Deutsche Nationalliteratur* (1883). See especially the introductions to Österley's editions; also H. Stiehler, *Simon Dach, sein Leben und seine ausgewählte Dichtungen* (1896).

**DACIA**, in ancient geography, the land of the Daci, a large district of central Europe, bounded on the N. by the Carpathians, on the S. by the Danube, on the W. by the Pathissus (Theiss), on the E. by the Tyras (Dniester), thus corresponding in the main to the modern Rumania and Transylvania. Towards the west it may originally have extended as far as the Danube where it runs from north to south at Waitzen (Vacz), while on the other hand Ptolemy puts its eastern boundary as far back as the Hierasus (Sereth). The inhabitants of this district were a Thracian stock, originally called *Δάοι*, a name which after the 4th century B.C. gave place to *Δακοί*. Of the other Thracian tribes the Getae (*g.v.*) were most akin to them in language and manners; by the Greeks the Dacians were usually called Getae, by the Romans Daci. *Δάος* and *Γέρα* (Dacus, Geta) were common as names of slaves in Attic comedy and in the adaptations of Plautus and Terence.

The Dacians had attained a considerable degree of civilization when they first became known to the Romans. They believed in the immortality of the soul, and regarded death as merely a change of country (*μεταμίσθησις*). Their chief priest held a prominent position as the representative of the deity upon earth; he was the king's chief adviser and his decisions were accepted as final. They were divided into two classes—an aristocracy and a proletariat. The first alone had the right to cover their heads and wore a felt hat (hence *tarabostesei* = *πλοφόροι, pileati*); they formed a privileged class, and were the predecessors of the Rumanian boyars. The second class, who comprised the rank and file of the army, the peasants and artisans, wore their hair long (*κομηται, capillati*). They dwelt in wooden huts surrounded by palisades, but in later times, aided by Roman architects, built walled strongholds and conical stone towers. Their chief occupations were agriculture and cattle breeding; horses were mainly used as draught animals. They also worked the gold and silver mines of Transylvania, and carried on a considerable outside trade, as is shown by the number of foreign coins found in the country.

A kingdom of Dacia was in existence at least as early as the beginning of the 2nd century B.C. under a king Oroles. Conflicts with the Bastarnae and the Romans (112–109, 74), against whom they had assisted the Scordisci and Dardani, had greatly weakened the resources of the Dacians. Under Burbista (Boerebista), a contemporary of Caesar, who thoroughly reorganized the army and raised the moral standard of the people, the limits of the kingdom were extended; the Bastarnae and Boii were conquered, and even Greek towns (Olbia, Apollonia) on the Euxine fell into his hands. Indeed the Dacians appeared so formidable that Caesar contemplated an expedition against them, which was prevented by his death. About the same time Burbista was murdered, and the kingdom was divided into four (or five) parts under separate rulers. One of these was Cotiso, whose daughter Augustus is said to have desired to marry and to whom he betrothed his own five-year-old daughter Julia. He is well known from the line in Horace ("Occidit Daci Cotisonis agmen," *Odes*, iii. 8. 18), which, as the ode was written on the 1st of March 29, probably refers to the campaign of Marcus Crassus (30–28), not to that of Cornelius Lentulus, who was not consul till 18. The Dacians are often mentioned under Augustus, according to whom they were compelled to recognize the Roman supremacy. But they were by no means subdued, and in later times seized every opportunity of crossing the frozen Danube and ravaging the province of Moesia. From A.D. 85 to 89 the Dacians were engaged in two wars with the Romans, under Duras or Diurpaneus, and the great Decebalus, who ruled from 86–87;

to 107. After two severe reverses, the Romans, under Tettius Julianus, gained a signal advantage, but were obliged to make peace owing to the defeat of Domitian by the Marcomanni. Decebalus restored the arms he had taken and some of the prisoners and received the crown from Domitian's hands, an apparent acknowledgment of Roman suzerainty. But the Dacians were really left independent, as is shown by the fact that Domitian agreed to purchase immunity from further Dacian inroads by the payment of an annual tribute.

To put an end to this disgraceful arrangement, Trajan resolved to crush the Dacians once and for all. The result of his first campaign (101-102) was the occupation of the Dacian capital Sarmizegethusa (Várhely) and the surrounding country; of the second (105-107), the suicide of Decebalus, the conquest of the whole kingdom and its conversion into a Roman province. The history of the war is given in Dio Cassius, but the best commentary upon it is the famous column of Trajan. According to Marquardt, the boundaries of the province were the Tibiscus (Temes) on the W., the Carpathians on the N., the Tyras on the E., and the Danube on the S., but Brandis (in Pauly-Wissowa's *Realencyclopädie*) maintains that it did not extend farther eastwards than the river Olt (Aluta)—the country beyond belonging to lower Moesia—and not so far as the Theiss westwards, being thus limited to Transylvania and Little Walachia. It was under a governor of praetorian rank, and the legio xiii. *gemina* with numerous auxiliaries had their fixed quarters in the province. To make up for the ravages caused by the recent wars colonists were imported to cultivate the land and work the mines, and the old inhabitants gradually returned. Forts were built as a protection against the incursions of the surrounding barbarians, and three great military roads were constructed to unite the chief towns, while a fourth, named after Trajan, traversed the Carpathians and entered Transylvania by the Roteturm pass. The two chief towns were Sarmizegethusa (afterwards Ulpia Trajana) and Apulum (Karlsburg). With the religion the Dacians also adopted the language of the conquerors, and modern Rumanian is full of Latin words easily recognizable.

In 129, under Hadrian, Dacia was divided into Dacia *Superior* and *Inferior*, the former comprising Transylvania, the latter Little Walachia, with procurators, probably both under the same praetorian legate (according to Brandis, the procurator of Dacia *inferior* was independent, but see A. Domaszewski in *Rheinisches Museum*, xlviii, 1893). Marcus Aurelius redivided it into three (*tres Daciae*): Porolissensis, from the chief town Porolissum (near Mojrád), Apulensis from Apulum and Maluensis (site unknown). The *tres Daciae* formed a commune in so far that they had a common capital, Sarmizegethusa, and a common diet, which discussed provincial affairs, formulated complaints and adjusted the incidence of taxation; but in other respects they were practically independent provinces, each under an ordinary procurator, subordinate to a governor of consular rank.

The Roman hold on the country was, however, still precarious. Indeed it is said that Hadrian, conscious of the difficulty of retaining it, had contemplated its abandonment and was only deterred by consideration for the safety of the numerous Roman settlers. Under Gallienus (256), the Goths crossed the Carpathians and drove the Romans from Dacia, with the exception of a few fortified places between the Temes and the Danube. No details of the event are recorded, and the chief argument in support of the statement in Ruf(i)us Festus that "under the Emperor Gallienus Dacia was lost" is the sudden cessation of Roman inscriptions and coins in the country after 256. Aurelian (270-275) withdrew the troops altogether and settled the Roman colonists on the south of the Danube, in Moesia, where he created the province Dacia Aureliani. This was subsequently divided into Dacia Ripensis on the Danube, with capital Ratiaria (Arcar in Bosnia), and Dacia Mediterranea, with capital Sardica (Sofia, the capital of Bulgaria), the latter again being subdivided into Dardania and Dacia Mediterranea.

See J. D. F. Neigebaur, *Dacien aus den Überresten des klassischen Alterthums* (Kronstadt, 1851); C. Gooss, *Studien zur Geographie und Geschichte des trajanischen Daciens* (Hermannstadt, 1874); E. R.

Rösler, *Dacien und Romanen* (Vienna, 1866), and *Römische Studien* (Leipzig, 1871); J. Jung, *Römer und Romanen in den Donauländern* (Innsbruck, 1877), *Die römischen Landschaften des römischen Reiches* (1881), and *Fasten der Provinz Dacien* (1894); W. Tomaszek, "Die alten Thraker," in *Sitzungsberichte der k. Akad. der Wissenschaften*, cxxviii (Vienna, 1893); J. Marquardt, *Römische Staatsverwaltung*, i. (1881), p. 308; T. Mommsen in *Corpus Inscriptionum Latinarum*, iii. 160, and *Provinces of Roman Empire* (Eng. trans., 1886); C. G. Brandis in Pauly-Wissowa's *Realencyclopädie*, iv. pt. 2 (1901); W. Miller, *The Balkans in "The Story of the Nations,"* vol. 44; on the boundaries of the Roman province of Dacia, see T. Hodgkin and F. Haverfield in *English Historical Review*, ii. 100, 734. (See also VLACHS.)

**DACIER, ANDRÉ** (1651-1722), French classical scholar, was born at Castres in upper Languedoc, on the 6th of April 1651. His father, a Protestant advocate, sent him first to the academy of Puy Laurens, and afterwards to Saumur to study under Tanneguy Lefèvre. On the death of Lefèvre in 1672, Dacier removed to Paris, and was appointed one of the editors of the Delphin series of the classics. In 1683 he married Anne Lefèvre, the daughter of his old tutor (see below). In 1695 he was elected member of the Academy of Inscriptions, and also of the French Academy; not long after, as payment for his share in the "medallic" history of the king's reign, he was appointed keeper of the library of the Louvre. He died two years after his wife, on the 18th of September 1722. The most important of his works were his editions of Pompeius Festus and Verrius Flaccus, and his translations of Horace (with notes), Aristotle's *Poetics*, the *Electra* and *Oedipus Coloneus* of Sophocles, Epictetus, Hippocrates and Plutarch's *Lives*.

His wife, ANNE LEFÈVRE (1654-1720), French scholar and translator from the classics, was born at Saumur, probably in March 1654. On her father's death in 1672 she removed to Paris, carrying with her part of an edition of Callimachus, which she afterwards published. This was so well received that she was engaged as one of the editors of the Delphin series of classical authors, in which she edited Florus, Dictys Crætenis, Aurelius Victor and Eutropius. In 1681 appeared her prose version of Anacreon and Sappho, and in the next few years she published prose versions of Terence and some of the plays of Plautus and Aristophanes. In 1684 she and her husband retired to Castres, with the object of devoting themselves to theological studies. In 1685 the result was announced in the conversion to Roman Catholicism of both M. and Mme Dacier, who were rewarded with a pension by the king. In 1699 appeared the prose translation of the *Iliad* (followed nine years later by a similar translation of the *Odyssey*), which gained for her the position she occupies in French literature. The appearance of this version, which made Homer known for the first time to many French men of letters, and among others to A. Houdart de la Motte, gave rise to a famous literary controversy. In 1714 la Motte published a poetical version of the *Iliad*, abridged and altered to suit his own taste, together with a *Discours sur Homère*, stating the reasons why Homer failed to satisfy his critical taste. Mme Dacier replied in the same year in her work, *Des causes de la corruption du goût*. La Motte carried on the discussion with light gaiety and badinage, and had the happiness of seeing his views supported by the abbé Jean Terrasson, who in 1715 produced two volumes entitled *Dissertation critique sur l'Iliade*, in which he maintained that science and philosophy, and especially the science and philosophy of Descartes, had so developed the human mind that the poets of the 18th century were immeasurably superior to those of ancient Greece. In the same year Père C. Buffier published *Homère en arbitrage*, in which he concluded that both parties were really agreed on the essential point—that Homer was one of the greatest geniuses the world had seen, and that, as a whole, no other poem could be preferred to his; and, soon after (on the 5th of April 1716), in the house of M. de Valincourt, Mme Dacier and la Motte met at supper, and drank together to the health of Homer. Nothing of importance marks the rest of Mme Dacier's life. She died at the Louvre, on the 17th of August 1720.

See C. A. Sainte-Beuve, *Causeries du lundi*, vol. ix.; J. F. Bodin, *Recherches historiques sur la ville de Saumur* (1812-1814); P. J. Burette, *Éloge de Mme Dacier* (1721); *Mémoires de Mme de Staël*

(1755); E. Egger, *L'Hellenisme en France*, ii. (1869); *Mémoires de Saint-Simon*, iii.; R. Rigault, *Histoire de la querelle des anciens et des modernes* (1856).

**DACITE** (from Dacia, mod. Transylvania), in petrology, volcanic rocks which may be considered a quartz-bearing variety of andesite. Like the latter they consist for the most part of plagioclase felspar with biotite, hornblende, augite or enstatite, and have generally a porphyritic structure, but they contain also quartz as rounded, corroded phenocrysts, or as an element of the ground-mass. Their felspar ranges from oligoclase to andesite and labradorite, and is often very zonal; sanidine occurs also in some dacites, and when abundant gives rise to rocks which form transitions to the rhyolites. The biotite is brown; the hornblende brown or greenish brown; the augite usually green. The ground-mass of these rocks is often microcrystalline, with a web of minute felspars mixed with interstitial grains of quartz; but in many dacites it is largely vitreous, while in others it is felsitic or cryptocrystalline. In the hand specimen many of the hornblende and biotite dacites are grey or pale brown and yellow rocks with white felspars, and black crystals of biotite and hornblende. Other dacites, especially augite- and enstatite-dacites, are darker coloured. The rocks of this group occur in Hungary, Almeria (Spain), Argyllshire and other parts of Scotland, New Zealand, the Andes, Martinique, Nevada and other districts of western North America, Greece, &c. They are mostly associated with andesites and trachytes, and form lava flows, dikes, and in some cases massive intrusions in the centres of old volcanoes. Among continental petrographers the older dacites (Carboniferous, &c.) are often known as "porphyrites." (J. S. F.)

**DACOIT**, a term used in India for a robber belonging to an armed gang. The word is derived from the Hindustani *dakait*, and being current in Bengal got into the Indian penal code. By law, to constitute *dacoity*, there must be five or more in the gang committing the crime. In the time of the Thugs (*q.v.*) a special police department was created in India to deal with thuggy and dacoity (*thagi* and *dakaiti*), which exists down to the present day. In Burma also the word dacoit came to be applied in a special sense to the armed gangs, which maintained a state of guerilla warfare for several years after the defeat of the king and his army. (See BURMESE WARS.)

**DA COSTA, ISAAK** (1798–1860), Dutch poet and theologian, was born at Amsterdam on the 14th of January 1798. His father was a Jew of Portuguese descent, and claimed kindred with the celebrated Uriel D'Acosta. An early acquaintance with Bilderdijk had a strong influence over the boy both in poetry and in theology. He studied at Amsterdam, and afterwards at Leiden, where he took his doctor's degree in law in 1818, and in literature in 1821. In 1814 he wrote *De Verlossing van Nederland*, a patriotic poem, which placed him in line with the contemporary national romantic poets in Germany and in France. His *Poëzy* (2 vols., 1821–1822) revealed his emancipation from the Bilderdijk tradition, and the oriental colouring of his poems, his hymn to Lamartine, and his translation of part of Byron's *Cain*, establish his claim to be considered as the earliest of the Dutch romantic poets. In 1822 he became a convert to Christianity, and immediately afterwards asserted himself as a champion of orthodoxy and an assailant of latitudinarianism in his *Bezwaren tegen den Geest der Eeuw* (1823). He took a lively interest in missions to the Jews, and towards the close of his life was a director of the seminary established in Amsterdam in connexion with the mission of the Free Church of Scotland. He died at Amsterdam on the 28th of April 1860. Da Costa ranked first among the poets of Holland after the death of Bilderdijk. His principal poetical works were: *Alphonsus I.* (1818), a tragedy; *Poëzy* (Leiden, 1821); *God melons* (1826); *Festliedern* (1828); *Vijf-en-twintig jaren* (1840); *Hagar* (1852); *De Slag bij Nicupoort* (1857). He also translated *The Persians* (1816) and the *Prometheus* (1818) of Aeschylus, and edited the poetical works of Bilderdijk in sixteen volumes, the last volume being an account of the poet. He was the author of a number of theological works, chiefly in connexion with the criticism of the gospels.

His complete poetical works were edited by J. P. Hasebroek (3 vols., Haarlem, 1861–1862). See G. Groen van Prinsterer, *Brieven van Mr I. da Costa, 1830–1849* (1872), and J. ten Brink, *Geschiedenis der Noord-Nederlandsche Letteren in de XIX<sup>e</sup> Eeuw* (vol. i., 1888), which contains a complete bibliography of his works.

**DACTYL** (from Gr. *δάκτυλος*, a finger), in prosody, a long syllable followed by two short (see VERSE).

**DAEDALUS**, a mythical Greek architect and sculptor, who figures largely in the early legends of Crete and of Athens. He was said to have built the labyrinth for Minos, to have made a wooden cow for Pasiphaë and to have fashioned a bronze man who repelled the Argonauts. Falling under the displeasure of Minos, he fashioned wings for himself and his son Icarus, and escaped to Sicily. These legends seem primarily to belong to Crete; and the Athenian element in them which connected Daedalus with the royal house of Erechtheus is a later fabrication. To Daedalus the Greeks of the historic age were in the habit of attributing buildings, and statues the origin of which was lost in the past, and which had no inscription belonging to them. In a later verse in the *Iliad* (date, 7th or 6th century), Daedalus is mentioned as the maker of a dancing-place for Ariadne in Crete; and such a dancing-place has been discovered by A. J. Evans, in the Minoan palace of Cnossus. Diodorus Siculus says that he executed various works in Sicily for King Cocalus. In many cities of Greece there were rude wooden statues, said to be by him. Later critics, judging from their own notions of the natural course of development in art, ascribed to Daedalus such improvements as separating the legs of statues and opening their eyes. In fact the name Daedalus is a mere symbol, standing for a particular phase of early Greek art, when wood was the chief material, and other substances were let into it for variety.

This Daedalus must not be confused with Daedalus of Sicily, a great sculptor of the early part of the 4th century B.C., none of whose works is extant. (P. G.)

**DAFFODIL**, the common name of a group of plants of the genus *Narcissus*, and natural order Amaryllidaceae. (See generally under NARCISSUS.) The common daffodil, *N. pseudo-narcissus*, is common in woods and thickets in most parts of the N. of Europe, but is rare in Scotland. Its leaves are five or six in number, are about a foot in length and an inch in breadth, and have a blunt keel and flat edges. The stem is about 18 in. long, and the spathe single-flowered. The flowers are large, yellow, scented and a little drooping, with a corolla deeply cleft into six lobes, and a central bell-shaped nectary, which is crisped at the margin. They appear early in the year, or, as Shakespeare says, "come before the swallow dares, and take the winds of March with beauty." The stamens are shorter than the cup, the anthers oblong and converging; the ovary is globose, and has three furrows; the seeds are roundish and black. Many new varieties of the flower have recently been cultivated in gardens. The bulbs are large and orbicular, and have a blackish coat; they, as well as the flowers, are reputed to be emetic in properties. The Peruvian daffodil and the sea daffodil are species of the genus *Ismene*. (For derivation see ASPHODEL.)

**DAFYDD AB GWILYM** (c. 1340–c. 1400), son of Gwilym Gam and Ardudful Fychan, greatest of the mediæval Welsh poets, was born at Bro Gynin, Cardiganshire, about the year 1340. Educated by a scholarly uncle, Llewelyn ab Gwilym Fychan of Emlyn, he became steward to his kinsman, Ivor Hael of Maesaleg, Monmouthshire, who also appointed him instructor to his daughter. The latter arrangement leading to an attachment between tutor and pupil, the girl was banished to a convent in Anglesey, whither the poet followed her, taking service in an adjacent monastery, but on returning to Maesaleg he was permitted to retain his stewardship. He was elected chief bard of Glamorgan and became household bard to Ivor Hael. At Rhosyr in North Wales he met Morfudd Lawgam, to whom he addressed 147 amatory odes. In consequence of attempting to elope with this lady, Dafydd ab Gwilym, being unable to pay the fine demanded by her husband, was imprisoned. Liberated by the goodwill of his friends, he went back to Maesaleg, and after the death of his patron, retired to his birthplace, Bro Gynin.

Tradition states that he was a man of noble appearance, and his poems bear evidence of high mental culture. He was acquainted with the works of Homer, Virgil, Ovid and Horace, and was also a student of Italian literature. Especially remarkable as a poet of nature in an age when more warlike themes were chosen by his contemporaries, his poems entitled "The Lark," "The Wind" and "The Mist" are amongst his finest efforts. He has been called the Petrarch, the Ovid, and (by George Borrow) the Horace of Wales. His poems were almost all written in the *cywydd* form: a short ode not divided into stanzas, each line having the same number of syllables. The poet died about the year 1400, and according to tradition was buried in the graveyard of the monastery of Strata Florida, in Cardiganshire.

See also under CELT; *Celtic Literature*, iv. Welsh.

**DAGGER**, a hand weapon with a short blade. The derivation is obscure (cf. Fr. *dague* and Ger. *Degen*), but the word is related to *dag*, a long pointed jag such as would be made in deeply nicking the edge of a garment. The war knife in various forms and under many names has of course been in use in all ages and amongst all races. But the dagger as generally understood was not a short sword, but a special stabbing weapon which could be used along with the sword. The distinction is often difficult to establish in a given case owing to the variations in the length of the weapon. The principal medieval dagger was the *miséricorde*, which from the end of the 12th century was used, in all countries in which chivalry flourished, to penetrate the joints of the armour of an unhorsed adversary (hence Ger. *Panzerbrecher*, armour-breaker). It was so called either because the threat of it caused the vanquished to surrender "at mercy," or from its use in giving what was called the *coup de grâce*. From about 1330 till the end of the succeeding century, in many knightly effigies it is often represented as attached on the right side by a cord or a chain to the sword-belt. This weapon and its sheath were often elaborately adorned. It was customary to secure it from accidental loss by a guard-chain fastened to the breast-armour. Occasionally the *miséricorde* was fixed to the body-armour by a staple; or, more rarely, it was connected with a *gypcière* or pouch. The *miséricorde* may be called a poniard. The distinction between the dagger and the poniard is arbitrary, and in ordinary language the latter is taken as being the shorter and as having less resemblance to a short sword or cutlass. A weapon, with a longer blade than the *miséricorde*, was habitually worn by civilians, including judges, during the middle-ages; such weapons bore the name of *antice* (from *annulus*, as it was fastened by a ring), *basilarde* or *langue de bœuf*, the last from the broad ox-tongue shape of the blade. This had often a small knife fixed on the scabbard, like a Highland officer's dirk of the present day. By nobles and knights the dagger or poniard was worn when they had exchanged their armour for the costume of peace. It is recorded besides that when they appeared at a tournament and on some other occasions, ladies at that time wore daggers depending, with their *gypcières*, from their girdles. Thus, writing of the year 1348, Knighton speaks of certain ladies who were present at jousts as "habentes cultellos, quos *daggerios* vulgariter dicunt, in powchiis desuper impositis." A longer and heavier dagger with a broad blade (Italian) is called *cinquedece*. The Scottish "dirk" was a long dagger, and survives in name in the dirk worn by midshipmen of the royal navy, and in fact in that worn by officers of Highland regiments. In the 15th and 16th centuries the infantry soldiers (Swiss or *landsknecht*) carried a heavy poniard or dagger. This and the earlier Spanish dagger with a thumb-ring were distinctively the weapons of professional soldiers. The rise of duelling produced another type, called the *main gauche*, which was a parrying weapon and often had a toothed edge on which the adversary's sword was caught and broken. One form of this dagger had a blade which expanded into a triple fork on pressing a spring; this served the same purpose. The satellites of the *Vehmgericht* had a similar weapon, in order, it is suggested, that their acts should be done in the name of the Trinity. The smaller poniards are generally called "stilettoes." Much ingenuity and skill have been

lavished on the adornment of daggers, and in rendering the blades more capable of inflicting severe wounds. Daggers also were sometimes made to poison as well as to wound. Of oriental daggers may be mentioned the Malay "crease" or "kris," which has a long waxed blade; the Gurkha "kukri," a short curved knife, broadest and heaviest towards the point; and the Hindu "khuttar," which has a flat triangular-shaped blade, and a hilt of H-shape, the cross-bar forming the grip and the sides the guard.

**DAGHESTAN**, a province of Russia, Transcaucasia, occupying the triangular space between the Andi ridge, the south-east division of the main Caucasus range, and the Caspian Sea. It has the province of Terek on the N.W., the government of Tiflis on the S.W., and that of Baku on the S.E. With the exception of a narrow strip along the sea-coast and a small district in the N., it is entirely mountainous. Area, 11,332 sq. m. The snow-clad Andi ridge, belonging to the system of transverse upheavals which cross the Caucasus, branches off the latter at Borbalo Peak (10,175 ft.), and reaches its highest altitudes in Tebulos-mta (14,775 ft.) and Diklos-mta (13,740 ft.). It is encircled on the N. by a lower outer ridge, the Karadagh, through which the rivers cut their way. This ridge is thickly clothed with forests, chiefly beech. The Boz-dagh and another ridge run between the four Koisu rivers, the head-streams of the Sulak, which flows into the Caspian. The next most important stream, out of the great number which course down the flanks of the Caucasus and terminate in the Caspian, is the Samur. The most notable feature of the province is, however, according to O. W. H. Abich (*Sur la structure et la géologie du Daghestan*, 1862), the successive folds of Jurassic limestones and slates, all nearly parallel to the Caucasus, which form lofty, narrow plateaus. Many of the peaks upon them rise higher than 12,000 ft., and the passes lie at altitudes of 11,000 ft. in the interior and 9000 ft. towards the Caspian. Towards the Caspian, especially between Petrovsk and the river Sulak, the Cretaceous system is well represented, and upon its rocks rest marls, shales, and sandstones of the Eocene period. The country is altogether difficult of access, and only one military route leads up from the river Terek, while every one of the eleven passes known across the Caucasus is a mere bridle-path. The climate is severe on the plateaus, hot towards the Caspian, and dry everywhere. The average temperatures are—year 51°, January 26°, July 73° at Temir-khan-shura (42° 49' N.; alt. 1510 ft.). The annual rainfall varies from 17 to 21 in. The population, estimated at 605,100 in 1906, numbered 587,326 in 1897, of whom only 5000 were Russians. They consist chiefly of mountaineers known as Lesghians (i.e. 158,550 Avars, 121,375 Darghis, 94,506 Kurins), a race closely akin to the Circassians, intermingled towards the Caspian Sea with Tatars and Georgians. There are also sprinklings of Jews and Persians. The highlands of Daghestan were for many years the stronghold of the Circassians in their struggle against Russia, especially under the leadership of Shamyl, whose last stand was made on the steep mountain fastness of Gunib, 74 m. S. of Temir-khan-shura, in 1859. The difficulty of communication between the valleys has resulted in the growth of a great number of dialects. Avarian is a sort of inter-tribal tongue, while Lakh or Kazi-kumukh, Kurin, Darghi-kaitakh, Andi, and Tabasaran are some of the more important dialects, each subdivided into sub-dialects. The mountaineers breed some cattle and sheep, and cultivate small fields on the mountain-sides. In the littoral districts excellent crops of cereals, cotton, fruit, wine and tobacco are obtained with the aid of irrigation. Silkworms are bred. The mountaineers excel also in a variety of petty trades. Sulphur, salt and copper are the most important of the minerals. A railway line to connect the North Caucasian line (Rostov to Petrovsk) with the Transcaucasian line (Batumi to Baku) has been built along the Caspian shore from Petrovsk, through the "gate" or pass of Derbent, to Baku. The province is divided into nine districts—Temir-khan-shura, Avar, Andi, Gunib, Dargo, Kazi-kumukh, Kaitago-Tabasaran, Kurin, and Samur. The only towns are Temir-khan-shura (pop. 9208 in 1897), the capital of the government, Derbent (14,821) and Petrovsk (9806), the last two both on the Caspian.

See G. Radde, "Aus den Daghestanischen Hochalpen," in *Petermanns Mitteilungen*, Ergänzungsheft, No. 85, 1887, and, with E. König, "Der Nordfuss des Daghestan," in *Petermanns Mitteilungen*, Ergänzungsheft, No. 117, 1895. (P. A. K.; J. T. Be.)

**DAGO**, a name given somewhat contemptuously to Spanish, Portuguese and Italian sailors, as "Dutchman" is similarly applied to Germans and Scandinavians as well as to natives of Holland. In America the word is generally confined to the poorer class of Italian immigrants. In the South Wales mining districts the casual labourers, who are only engaged when work is plentiful, are so called. The word is apparently a corruption of the common Spanish and Portuguese Christian name "Diego."

**DAGOBERT I.** (d. 639), king of the Franks, was the son of Clotaire II. In 623 his father established him as king of the region east of the Ardennes, and in 626 revived for him the ancient kingdom of Austrasia, minus Aquitaine and Provence. As Dagobert was yet but a child, he was placed under the authority of the mayor of the palace, Pippin, and Arnulf, bishop of Metz. At the death of Clotaire II. in 629, Dagobert wished to re-establish unity in the Frankish realm, and in 629 and 630 made expeditions into Neustria and Burgundy, where he succeeded in securing the recognition of his authority. In Aquitaine he gave his brother Charibert the administration of the counties of Toulouse, Cahors, Agen, Périgieux, and Saintes; but at Charibert's death in 632 Dagobert became sole ruler of the whole of the Frankish territories south of the Loire. Under him the Merovingian monarchy attained its culminating point. He restored to the royal domain the lands that had been usurped by the great nobles and by the church; he maintained at Paris a luxurious, though, from the example he himself set, a disorderly court; he was a patron of the arts, and delighted in the exquisite craftsmanship of his treasurer, the goldsmith St Eloi. His authority was recognized through the length and breadth of the realm. The duke of the Basques came to his court to swear fidelity, and at his *villa* at Clichy the chief of the Bretons of Domnoné promised obedience. He intervened in the affairs of the Visigoths of Spain and the Lombards of Italy, and was heard with deference. Indeed, as a sovereign, Dagobert was reckoned superior to the other barbarian kings. He entered into relations with the eastern empire, and swore a "perpetual peace" with the emperor Heraclius; and it is probable that the two sovereigns took common measures against the Slav and Bulgarian tribes, which ravaged in turn the Byzantine state and the German territories subject to the Franks. Dagobert protected the church and placed illustrious prelates at the head of the bishoprics—Eloi (Eligius) at Noyon, Ouen (Audoenus) at Rouen, and Didier (Desiderius) at Cahors. His reign is also marked by the creation of numerous monasteries and by renewed missionary activity in Flanders and among the Basques. He died on the 19th of January 639, and was buried at St Denis. After his death the Frankish monarchy was again divided. In 634 he had been obliged to give the Austrasians a special king in the person of his eldest son Sigebert, and at the birth of a second son, Clovis, in 635, the Neustrians had immediately claimed him as king. Thus the unification of the realm, which Dagobert had re-established with so much pains, was annulled.

See the *Chronicon* of Fredegarius; "*Gesta Dagoberti I. regis Francorum*" in *Mon. Germ. hist. Script. rer. Meroving.* vol. ii. edited by B. Krusch; J. H. Albers, *König Dagobert in Gesch., Legende, und Sage* (2nd ed., Kaiserslautern, 1884); E. Vacandard, *Vie de Saint Ouen, évêque de Rouen* (Paris, 1901); and H. E. Bonnell, *Die Anfänge des karoling. Hauses* (Berlin, 1866). (C. Pf.)

**DAGON**, a god of the Philistines who had temples at Ashdod (1 Sam. v. 1), and Gaza (Judg. xvi. 21, 23); the former was destroyed by Jonathan, the brother of Judas the Maccabæe (1 Macc. x. 84; 148 B.C.). But Dagon was more than a mere local deity; there was a place called Beth-Dagon in Judah (Josh. xv. 41), another on the borders of Asher (*ib.* xix. 27), and a third underlies the modern Bêt Dejân, south-east of Nablus. Dagon was in all probability an old Canaanite deity; it appears in the name of the Canaanite Dagantakala as early as the 15th century, and is possibly to be identified with the Babylonian god Dagan. Little is known of his cult (Judg. xvi. 23 seq.), although as the male counterpart of Ashtoreth (see **ASTARTE**) his worship

would scarcely differ from that of the Baalim (see **BAAL**). The name Dagon seems to come from *däg* "fish," and that his idol was half-man half-fish is possible from the ichthyomorphic representations found upon coins of Ascalon and Arvad, and from the fact that Berossus speaks of an Assyrian merman-god.

The true meaning of the name is doubtful. In 1 Sam. v. 4, Thenius and Wellhausen, followed by Robertson Smith and others, read "only his fish-part (*dägō*) was left to him"; against this, see the comm. of H. P. Smith and Budde. The identification of Dagon with the Babylonian Dagan is doubted by G. F. Moore (*Encyc. Bib.*, col. 985), and that of the latter with Odacon and Ea-Oannes is questionable. Philo Byblius (Müller, *Fr. Hist. Graec.* iii. 567 seq.) makes Dagon the inventor of corn and the plough, whence he was called Ζεὺς Ἀρότρου. This points to a natural though possibly late etymology from the Hebrew and Phœnician *dagan* "corn." It is not improbable that, at least in later times, Dagon had in place of, or in addition to, his old character, that of the god who presided over agriculture; for in the last days of paganism, as we learn from Marcus Diaconus in the *Life of Porphyry of Gaza* (§ 10), the great god of Gaza, now known as Marna (our Lord), was regarded as the god of rains and invoked against famine. That Marna was lineally descended from Dagon is probable in every way, and it is therefore interesting to note that he gave oracles, that he had a circular temple, where he was sometimes worshipped by human sacrifices, that there were wells in the sacred circuit, and that there was also a place of adoration to him situated, as was usual, outside the town. Certain "marmora" in the temple, which might not be approached, especially by women, may perhaps be connected with the threshold which the priests of Dagon would not touch with their feet (1 Sam. v. 5, Zeph. i. 9). See further, the comm. on the Old Testament passages, Moore (*loc. cit.*), and Lagrange, *Relig. sémit.* p. 131 seq.

**DAGUERRE, LOUIS JACQUES MANDÉ** (1789–1851), French painter and physicist, inventor of the daguerreotype, was born at Cormeilles, in the department of Seine-et-Oise, and died on the 12th of July 1851 at Petit-Brie-sur-Marne, near Paris. He was at first occupied as an inland revenue officer, but soon took to scene-painting for the opera. He assisted Pierre Prévost (1764–1823) in the execution of panoramic views of Rome, Naples, London, Jerusalem, and Athens, and subsequently (July 11, 1822), in conjunction with Bouton, he opened at Paris the Diorama (δῖς, double; δρᾶμα, view), an exhibition of pictorial views, the effect of which was heightened by changes in the light thrown upon them. An establishment similar to that at Paris was opened by Daguerre in Regent's Park, London. On the 3rd of March 1839 the Diorama, together with the work on which Daguerre was then engaged, was destroyed by fire. This reverse of fortune was soon, however, more than compensated for by the distinction he achieved as the inventor of the daguerreotype photographic process. J. Nicéphore Niepce, who since 1814 had been seeking a means of obtaining permanent pictures by the action of sunlight, learned in 1826 that Daguerre was similarly occupied. In 1829 he communicated to Daguerre particulars of his method of fixing the images produced in the camera lucida by making use of metallic plates coated with a composition of asphalt and oil of lavender; this, where acted on by the light, remained undissolved when the plate was plunged into a mixture of petroleum and oil of lavender, and the development of the image was effected by the action of acids and other chemical reagents on the exposed surface of the plate. The two investigators laboured together in the production of their "heliographic pictures" from 1829 until the death of Niepce in 1833. Daguerre, continuing his experiments, discovered eventually the process connected with his name. This, as he described it, consists of five operations:—the polishing of the silver plate; the coating of the plate with iodide of silver by submitting it for about 20 minutes to the action of iodine vapour; the projection of the image of the object upon the golden-coloured iodized surface; the development of the latent image by means of the vapour of mercury; and, lastly, the fixing of the picture by immersing the plate in a solution of sodium "hyposulphite" (sodium thiosulphate). On the 9th of January 1839, at a meeting of the Academy of Sciences, Arago dwelt on the importance of the discovery of the daguerreotype; and, in consequence of the representations made by him and Gay Lussac to the French government, Daguerre was on the 15th of June appointed an officer of the Legion of Honour. On the same day a bill was presented to the chambers, according to the provisions of which



Daguerre and the heir of Niepce were to receive annuities of 6000 and 4000 francs respectively, on the condition that their process should be made known to the Academy. The bill having been approved at the meetings of the two chambers on the 9th of July and on the 2nd of August, Daguerre's process, together with his system of transparent and opaque painting, was published by the government, and soon became generally known (see PHOTOGRAPHY).

Daguerre's *Historique et description des procédés du daguerréotype et du diorama* (Paris, 1839) passed through several editions, and was translated into English. Besides this he wrote an octavo work, entitled *Nouveau moyen de préparer la couche sensible des plaques destinées à recevoir les images photographiques* (Paris, 1844).

**DAGUPAN**, a town and the most important commercial centre of the province of Pangasinán, Luzon, Philippine Islands, on a branch of the Agno river near its entrance into the Gulf of Lingayen, 120 m. by rail N.N.W. of Manila. Pop. (1903), 20,357. It is served by the Manila & Dagupan railway. Dagupan has a healthy climate. It is the chief point of exportation for a very rich province, which produces sugar, indigo, Indian corn, copra, and especially rice. There are several rice mills here. Salt is an important export, being manufactured in salt water swamps and marshes throughout the province of Pangasinán (whose name, from *asin*, "salt," means "the place where salt is produced"). In these marshes grows the nipa palm, from which a liquor is distilled—there are a number of small distilleries here. Dagupan has a small shipyard in which sailing vessels and steam launches are constructed. The principal language is Pangasinán.

**DAHABEAH** (also spelt dahablya, dahabiyeh, dahabeeyah, &c.), an Arabic word (variously derived from *dahab*, gold, and *dahab*, one of the forms of the verb to go) for a native passenger boat used on the Nile. The typical form is that of a barge-like house-boat provided with sails, resembling the painted galleys represented on the tombs of the Pharaohs. Similar state barges were used by the Mahommedan rulers of Egypt, and from the circumstance that these vessels were ornamented with gilding is attributed the usual derivation of the name from gold. Before the introduction of steamers dahabeahs were generally used by travellers ascending the Nile, and they are still the favourite means of travelling for the leisured and wealthy classes. The modern dahabeah is often made of iron, draws about 2 ft. of water, and is provided with one very large and one small sail. According to size it provides accommodation for from two to a dozen passengers. Steam dahabeahs are also built to meet the requirements of tourists.

**DAHL, HANS** (1849- ), Norwegian painter, was born at Hardanger. After being in the Swedish army he studied art at Karlsruhe and at Düsseldorf, being a notable painter of landscape and *genre*. His work has considerable humour, but his colouring is hard and rather crude. In 1889 he settled in Berlin. His pictures are very popular in Norway.

**DAHL, JOHANN CHRISTIAN** (1778-1857), Norwegian landscape painter, was born in Bergen. He formed his style without much tuition, remaining at Bergen till he was twenty-four, when he left for the better field of Copenhagen, and ultimately settled in Dresden in 1818. He is usually included in the German school, although he was thus close on forty years of age when he finally took up his abode in Dresden, where he was quickly received into the Academy and became professor. German landscape-painting was not greatly advanced at that time, and Dahl contributed to improve it. He continued to reside in Dresden, though he travelled into Tirol and in Italy, painting many pictures, one of his best being that of the "Outbreak of Vesuvius, 1820." He was fond of extraordinary effects, as seen in his "Winter at Munich," and his "Dresden by Moonlight;" also the "Haven of Copenhagen," and the "Schloss of Friedrichsburg," under the same condition. At Dresden may be seen many of his works, notably a large picture called "Norway," and a "Storm at Sea." He was received into several academic bodies, and had the orders of Wasa and St Olaf sent him by the king of Norway and Sweden.

**DAHL, MICHAEL** (1656-1743), Swedish portrait painter, was born at Stockholm. He received his first professional education

from Ernst Klocke, who had a respectable position in that northern town, which, however, Dahl left in his twenty-second year. His first destination was England, where he did not long remain, but crossed over to Paris, and made his way at last to Rome, there taking up his abode for a considerable time, painting the portraits of Queen Christina and other celebrities. In 1688 he returned to England, and became for some years a dangerous rival to Kneller. He died in London. His portraits still exist in many houses, but his name is not always preserved with them. Nagler (*Kunstler-Lexicon*) says those at Hampton Court and at Petworth contest the palm with those of the better known and vastly more employed painter.

**DAHL** (or **DALE**), **VLADIMIR IVANOVICH** (1802-1872), Russian author and philologist, was born of Scandinavian parentage in 1802, and received his education at the naval cadets' institution at St Petersburg. He joined the Black Sea fleet in 1819; but at a later date he entered the military service, and was thus engaged in the Polish campaign of 1831, and in the expedition against Khiva. He was afterwards appointed to a medical post in one of the government hospitals at St Petersburg, and was ultimately transferred to a situation in the civil service. The latter years of his life were spent at Moscow, and he died there on November 3 (October 22), 1872. Under the name of Kossack Lugansky he obtained considerable fame by his stories of Russian life:—*The Dream and the Waking, A Story of Misery, Happiness, and Truth, The Door-Keeper* (Dvernik), *The Officer's Valet* (Denshchik). His greatest work, however, was a *Dictionary of the Living Russian Tongue* (Folkovyi Slovar Zhivago Velikorusskago Yasika), which appeared in four volumes between 1861 and 1866, and is of the most essential service to the student of the popular literature and folk-lore of Russia. It was based on the results of his own investigations throughout the various provinces of Russia,—investigations which had furnished him with no fewer than 4000 popular tales and upwards of 30,000 proverbs. Among his other publications may be mentioned *Bemerkungen zu Zimmermann's Entwurf des Kriegstheater's Russlands gegen Khiwa*, published in German at Oreaburg, and a *Handbook of Botany* (Moscow, 1849).

A collected edition of his works appeared at St Petersburg in 8 volumes, 1860-1861.

**DAHLBERG** (**DAHLBERGH**), **ERIK JOHANSEN, COUNT** (1625-1703), Swedish soldier and engineer, was born at Stockholm. His early studies took the direction of the science of fortification, and as an engineer officer he saw service in the latter years of the Thirty Years' War, and in Poland. As adjutant-general and engineer adviser to Charles X. (Gustavus), he had a great share in the famous crossing of the frozen Belts, and at the sieges of Copenhagen and Kronborg he directed the engineers. In spite of these distinguished services, Dahlberg remained an obscure lieutenant-colonel for many years. His patriotism, however, proved superior to the tempting offers Charles II. of England made to induce him to enter the British service, though, in that age of professional soldiering, there was nothing in the offer that a man of honour could not accept. At last his talents were recognized, and in 1676 he became director-general of fortifications. In the wars of the next twenty-five years Dahlberg again rendered distinguished service, alike in attack (as at Helsingborg in 1677, and Dünamünde in 1700) and defence (as in the two sieges of Riga in 1700): and his work in repairing the fortresses of his own country, not less important, earned for him the title of the "Vauban of Sweden." He was also the founder of the Swedish engineer corps. He retired as field-marshal in 1702, and died the following year.

Erik Dahlberg was responsible for the fine collection of drawings called *Suecia antiqua et hodierna* (Stockholm, 1660-1716; 2nd edition, 1856; 3rd edition, 1864-1865), and assisted Pufendorf in his *Histoire de Charles X Gustave*. He wrote a memoir of his life (to be found in *Svenska Bibliotek*, 1757) and an account of the campaigns of Charles X. (ed. Lundblad, Stockholm, 1823).

**DAHLGREN, JOHN ADOLF** (1809-1870), admiral in the U.S. navy, was the son of the Swedish consul at Philadelphia, Pennsyl-

vania, and was born in that city on the 13th of November 1809. He entered the United States navy in 1826, and saw some service in the Civil War in command of the South Atlantic blockading squadron. But he was chiefly notable as a scientific officer. His knowledge of mathematics caused him to be employed on the coast survey in 1834. In 1847 his eyesight threatened to fail, he retired in 1838-1842, and 1847 he was transferred to the ordnance department. In this post he applied himself to the improvement of the guns of the U.S. navy. He was the inventor of the smooth bore gun which bore his name, but was from its shape familiarly known as "the soda water bottle." It was used in the Civil War, and for several years afterwards in the United States navy. Dahlgren's guns were first mounted in a vessel named the "Experiment," which cruised under his command from 1857 till 1859. They were "the first practical application of results obtained by experimental determinations of pressure at different points along the bore, by Colonel Bomford's tests—that is by boring holes in the walls of the gun, through which the pressure acts upon other bodies, such as pistol balls, pistons, &c." (Cf. article by J. M. Brooke in Hamersley's *Naval Encyclopaedia*.) When the Civil War broke out, he was on ordnance duty in the Washington navy yard, and he was one of the three officers who did not resign from confederate sympathies. His rank at the time was commander, and the command could only be held by a captain. President Lincoln insisted on retaining Commander Dahlgren, and he was qualified to keep the post by special act of Congress. He became post-captain in 1862 and rear-admiral in 1863. He commanded the Washington navy yard when he died on the 12th of July 1870.

A memoir of Admiral Dahlgren by his widow was published at Boston in 1882. (D. H.)

**DAHLGREN, KARL FREDRIK** (1791-1844), Swedish poet, was born at Stensbruk in Östergötland on the 20th of June 1791. At a time when literary partisanship ran high in Sweden, and the writers divided themselves into "Goths" and "Phosphorists," Dahlgren made himself indispensable to the Phosphorists by his polemical activity. In the mock-heroic poem of *Markalls sömnlösa nätter* (Markall's Sleepless Nights), in which the Phosphorists ridiculed the academician Per Adam Wallmark and others, Dahlgren, who was a genuine humorist, took a prominent part. In 1825 he published *Babels Torn* (The Tower of Babel), a satire, and a comedy, *Argus in Olympien*; and in 1828 two volumes of poems. In 1829 he was appointed to an ecclesiastical post in Stockholm, which he held until his death. In a series of odes and dithyrambic pieces, entitled *Mollbergs Epistlar* (1819, 1820), he strove to emulate the wonderful lyric genius of K. M. Bellman, of whom he was a student and follower. From 1825 to 1827 he edited a critical journal entitled *Kometen* (The Comet), and in company with Almqvist he founded the *Manhemsförbund*, a short-lived society of agricultural socialists. In 1834 he collected his poems in one volume; and in 1837 appeared his last book, *Ångbåts-Sånger* (Steamboat Songs). On the 1st of May 1844 he died at Stockholm. Dahlgren is one of the best humorous writers that Sweden has produced; but he was perhaps at his best in realistic and idyllic description. His little poem of *Zephyr and the Girl*, which is to be found in every selection from Swedish poetry, is a good example of his sensuous and ornamented style.

His works were collected and published after his death by A. J. Arwidsson (3 vols., Stockholm, 1847-1852).

**DAHLIA**, a genus of herbaceous plants of the natural order Compositae, so called after Dr Dahl, a pupil of Linnaeus. The genus contains about nine species indigenous in the high sandy plains of Mexico. The dahlia was first introduced into Britain from Spain in 1789 by the marchioness of Bute. The species was probably *D. variabilis*, whence by far the majority of the forms now common have originated. The flowers, at the time of the first introduction of the plant, were single, with a yellow disk and dull scarlet rays; under cultivation since the beginning of the 19th century in France and England, flowers of numerous brilliant hues have been produced. The flower has been modified also from a flat to a globular shape, and the arrangement of the

florets has been rendered quite distinct in the ranunculus and anemone-like kinds. The ordinary natural height of the dahlia is about 7 or 8 ft., but one of the dwarf races grows to only 18 in. With changes in the flower, changes in the shape of the seed have been brought about by cultivation; varieties of the plant have been produced which require more moisture than others; and the period of flowering has been made considerably earlier. In 1808 dahlias were described as flowering from September to November, but some of the dwarf varieties at present grown are in full blossom in the middle of June.

The large number of varieties may be classed as under the following heads: (1) *Single dahlias*. These have been derived from *D. coccinea*; they have a disk of tubular florets surrounded by the large showy ray florets. (2) *Show dahlias*, large and double with flowers self-coloured or pale-coloured and edged or tipped with a darker colour. (3) *Fancy dahlias*, resembling the show but having the florets striped or tipped with a second tint. (4) *Bouquet or Pompon dahlias*, with much smaller double flowers of various colours. (5) *Cactus dahlias*, derived from *D. Juarezi*, a form which has given rise to a beautiful race with pointed starry flowers. (6) *Paecony-flowered dahlias*, a new but not pretty race, with large floppy heads, broad florets and several disk florets in centre.

New varieties are procured from seed, which should be sown in pots or pans towards the end of March, and placed in a hotbed or propagating pit, the young plants being pricked off into pots or boxes, and gradually hardened off for planting out in June; they will flower the same season if the summer is a genial one. The older varieties are propagated by dividing the large tuberous roots, in doing which care must be taken to leave an eye to each portion of tuber, otherwise it will not grow. Rare varieties are sometimes grafted on the roots of others. The best and most general mode of propagation is by cuttings, to obtain which, the old tubers are placed in heat in February, and as the young shoots, which rise freely from them, attain the height of 3 in., they are taken off with a heel, and planted singly in small pots filled with fine sandy soil, and plunged in a moderate heat. They root speedily, and are then transferred to larger pots in light rich soil, and their growth encouraged until the planting-out season arrives, about the middle of June north of the Thames.

Dahlias succeed best in an open situation, and in rich deep loam, but there is scarcely any garden soil in which they will not thrive, if it is manured. For the production of fine show flowers the ground must be deeply trenched, and well manured annually. The branches as well as the blossoms require a considerable but judicious amount of thinning; they also need shading in some cases. The plants should be protected from cold winds, and when watered the whole of the foliage should be wetted. They may stand singly like common border flowers, but have the most imposing appearance when seen in masses arranged according to their height. Florists usually devote a plot of ground to them, and plant them in lines 5 to 10 ft. apart. This is done about the beginning of June, sheltering them if necessary from late frosts by inverted pots or in some other convenient way. Old roots often throw up a multitude of stems, which render thinning necessary. As the plants increase in height, they are furnished with strong stakes, to secure them from high winds. Dahlias flower on till they are interrupted by frost in autumn. The roots are then taken up, dried, and stored in a cellar, or some other place where they may be secure from frost and moisture. Earwigs are very destructive, eating out the young buds and florets. Small flower-pots half filled with dry moss and inverted on stakes placed among the branches, form a useful trap.

**DAHLMANN, FRIEDRICH CHRISTOPH** (1785-1860), German historian and politician, was born on the 13th of May 1785; he came of an old Hanseatic family of Wismar, which then belonged to Sweden. His father, who was the burgomaster of the town, intended him to study theology, but his bent was towards classical philology, and this he studied from 1802 to 1806 at the universities of Copenhagen and Halle, and again at Copenhagen. After finishing his studies, he translated some of the Greek tragic poets, and the *Clouds* of Aristophanes. But he

was also interested in modern literature and philosophy; and the troubles of the times, of which he had personal experience, aroused in him, as in so many of his contemporaries, a strong feeling of German patriotism, though throughout his life he was always proud of his connexion with Scandinavia, and Gustavus Adolphus was his particular hero. In 1809, on the news of the outbreak of war in Austria, Dahlmann, together with the poet Heinrich von Kleist, whom he had met in Dresden, went to Bohemia, and was afterwards with the Imperial army, up till the battle of Aspern, with the somewhat vague object of trying to convert the Austrian war into a German one. This hope was shattered by the defeat of Wagram. He now decided to try his fortunes in Denmark, where he had influential relations. After taking his doctor's degree at Wittenberg (1810) he qualified at Copenhagen in 1811, with an essay on the origins of the ancient theatre, as a lecturer on ancient literature and history, on which he delivered lectures in Latin. His influential friends soon brought him further advancement. As early as 1812 he was summoned to Kiel, as successor to the historian Dietrich Hermann Hegewisch (1746-1812). This appointment was in two respects a decisive moment in his career; on the one hand it made him give his whole attention to a subject for which he was admirably suited, but to which he had so far given only a secondary interest; and on the other hand, it threw him into politics.

In 1815 he obtained, in addition to his professorate, the position of secretary to the perpetual deputation of the estates of Schleswig-Holstein. In this capacity he began, by means of memoirs or of articles in the *Kieler Blätter*, which he founded himself, to appear as an able and zealous champion of the half-forgotten rights of the Elbe duchies, as against Denmark, and of their close connexion with Germany. It was he upon whom the Danes afterwards threw the blame of having invented the Schleswig-Holstein question; certainly his activities form an important link in the chain of events which eventually led to the solution of 1864. So far as this interest affected himself, the chief profit lay in the fact that it deepened his conception of the state, and directed it to more practical ends. Whereas at that time mere speculation dominated both the French Liberalism of the school of Rotteck, and Karl Ludwig von Haller's Romanticist doctrine of the Christian state, Dahlmann took as his premisses the circumstances as he found them, and evolved the new out of the old by a quiet process of development. Moreover, in the inevitable conflict with the Danish crown his upright point of view and his German patriotism were further confirmed. After his transference to Göttingen in 1829 he had the opportunity of working in the same spirit. As confidant of the duke of Cambridge, he was allowed to take a share in framing the Hanoverian constitution of 1833, which remodelled the old aristocratic government in a direction which had become inevitable since the July revolution in Paris; and when in 1837 the new king Ernest Augustus declared the constitution invalid, it was Dahlmann who inspired the famous protest of the seven professors of Göttingen. He was deprived of his position and banished, but he had the satisfaction of knowing that German national feeling received a mighty impulse from his courageous action, while public subscriptions prevented him from material cares.

After he had lived for several years in Leipzig and Jena, King Frederick William IV. appointed him in October 1842 to a professorship at Bonn. The years that followed were those of his highest celebrity. His *Politik* (1835) had already made him a great name as a writer; he now published his *Dänische Geschichte* (1840-1843), a historical work of the first rank; and this was soon followed by histories of the English and French revolutions, which, though of less scientific value, exercised a decisive influence upon public opinion by their open advocacy of the system of constitutional monarchy. As a teacher too he was much beloved. Though no orator, and in spite of a personality not particularly amiable or winning, he produced a profound impression upon young men by the pregnancy of his expression, a consistent logical method of thought based on Kant and by

the manliness of his character. When the revolution of 1848 broke out, the "father of German nationality," as the provisional government at Milan called him, found himself the centre of universal interest. Both Mecklenburg and Prussia offered him in vain the post of envoy to the diet of the confederation. Naturally, too, he was elected to the national assembly at Frankfort, and took a leading part in the constitutional committees appointed first by the diet, then by the parliament. His object was to make Germany as far as possible a united constitutional monarchy, with the exclusion of the whole of Austria, or at least, of its non-German parts. Prussia was to provide the emperor, but at the same time—and in this lay the doctrinaire weakness of the system—was to give up its separate existence, consecrated by history, in the same way as the other states. When, therefore, Frederick William IV., without showing any anxiety to bind himself by the conditions laid down at Frankfort, concluded with Denmark the seven months' truce of Malmö (26th August 1848), Dahlmann proposed that the national parliament should refuse to recognize the truce, with the express intention of clearing up once for all the relations of the parliament with the court of Berlin. The motion was passed by a small majority (September 5th); but the members of Dahlmann's party were just those who voted against it, and it was they who on the 17th of September reversed the previous vote and passed a resolution accepting the truce, after Dahlmann had failed to form a ministry on the basis of the resolution of the 5th, owing to his objection to the Radicals. Dahlmann afterwards described this as the decisive turning-point in the fate of the parliament. He did not, however, at once give up all hope. Though he took but little active part in parliamentary debates, he was very active on commissions and in party conferences, and it was largely owing to him that a German constitution was at last evolved, and that Frederick William IV. was elected hereditary emperor (28th of March 1849). He was accordingly one of the deputation which offered the crown to the king in Berlin. The king's refusal was less of a surprise to him than to most of his colleagues. He counted on being able to compel recognition of the constitution by the moral pressure of the consent of the people. It was only when the attitude of the Radicals made it clear to him that this course would lead to a revolution, that he decided, after a long struggle, to retire from the national parliament (21st May). He was still, however, one of the chief promoters of the well-known conference of the imperial party at Gotha, the proceedings of which were not, however, satisfactory to him; and he took part in the sessions of the first Prussian chamber (1849-1850) and of the parliament of Erfurt (1850). But finally, convinced that for the moment all efforts towards the unity of Germany were unavailing, he retired from political life, though often pressed to stand for election, and again took up his work of teaching at Bonn. His last years were, however, saddened by illness, bereavement and continual friction with his colleagues. His death took place on the 5th of December 1860, following on an apoplectic fit. He was a man whose personality had contributed to the progress of the world, and whose teaching was to continue to exercise a far-reaching influence on the development of German affairs.

His chief works were:—*Quellenkunde der deutschen Geschichte nach der Folge der Begebenheiten geordnet* (1830, 7th edition of Dahlmann-Waitz, *Quellenkunde*, Leipzig, 1906); *Politik, auf den Grund und das Mass der gegebenen Zustände zurückgeführt* (1 vol., 1835); *Geschichte Dänemarks* (3 vols., 1840-1843); *Geschichte der englischen Revolution* (1844); *Geschichte der französischen Revolution* (1845).

See A. Springer, *Friedrich Christoph Dahlmann* (2 vols., 1870-1872); and H. v. Treitschke, *Histor. und polit. Aufsätze*, i. 365 et seq. (F. Lu.)

**DAHLSTJERNA, GUNNO** (1661-1709), Swedish poet, whose original surname was Eurelius, was born on the 7th of September 1661 in the parish of Öhr in Dalsland, where his father was rector. He entered the university of Upsala in 1677, and after gaining his degree entered the government office of land-surveying. He was sent in 1681 on professional business to Livonia,

then under Swedish rule. A dissertation read at Leipzig in 1687 brought him the offer of a professorial chair in the university, which he refused. Returning to Sweden he executed commissions in land-surveying directed by King Charles XI., and in 1699 he became head of the whole department. In 1702 he was ennobled under the name of Dahlstjerna. He wandered over the whole of the coast of the Baltic, Livonia, Rügen and Pomerania, preparing maps which still exist in the office of public land-surveying in Stockholm. His death, which took place in Pomerania on his forty-eighth birthday, 7th of September 1709, is said to have been hastened by the disastrous news of the battle of Poltava. Dahlstjerna's patriotism was touching in its pathos and intensity, and during his long periods of professional exile he comforted himself by the composition of songs to his beloved Sweden. His genius was most irregular, but at his best he easily surpasses all the Swedish poets of his time. His best-known original work is *Kungaskald* (Stettin, 1697), an elegy on the death of Charles XI. It is written in alexandrines, arranged in *ottava rima*. The poem is pompous and allegorical, but there are passages full of melody and high thoughts. Dahlstjerna was a reformer in language, and it has been well said by Atterbom that in this poem "he treats the Swedish speech just as dictatorially as Charles XI. and Charles XII. treated the Swedish nation." In 1690 was printed at Stettin his paraphrase of the *Pastor Fido* of Guarini. His most popular work is his *Götha kämpvisa om Konungen och Herr Peder* (The Goth's Battle Song, concerning the King and Master Peter; Stockholm, 1701). The King is Charles XII. and Master Peter is the tsar of Russia. This spirited ballad lived almost until our own days on the lips of the people as a folk-song.

The works of Dahlstjerna have been collected by P. Hanselli, in the *Samlade Vitterhetsarbeten af svenska Författare från Stjernhjelms till Dalin* (Upsala, 1856, &c.).

**DAHN, JULIUS SOPHUS FELIX** (1834— ), German historian, jurist and poet, was born on the 9th of February 1834 in Hamburg, where his father, Friedrich Dahn (1811—1889), was a leading actor at the city theatre. His mother, Constance Dahn, *née* Le Gay, was a noted actress. In 1834 the family moved to Munich, where the parents took leading rôles in the classical German drama, until they retired from the stage: the mother in 1865 and the father in 1878. Felix Dahn studied law and philosophy in Munich and Berlin from 1849 to 1853. His first works were in jurisprudence, *Über die Wirkung der Klagverjähung bei Obligationen* (Munich, 1855), and *Studien zur Geschichte der germanischen Gottesurteile* (Munich, 1857). In 1857 he became *docent* in German law at Munich university, and in 1862 professor-extraordinary, but in 1863 was called to Würzburg to a full professorship. In 1872 he removed to the university of Königsberg, and in 1888 settled at Breslau, becoming rector of the university in 1895. Meanwhile in addition to many legal works of high standing, he had begun the publication of that long series of histories and historical romances which has made his name a household word in Germany. The great history of the German migrations, *Die Könige der Germanen*, Bände i.-vi. (Munich and Würzburg, 1861—1870), Bände vii.-xi. (Leipzig, 1894—1908), was a masterly study in constitutional history as well as a literary work of high merit, which carries the narrative down to the dissolution of the Carolingian empire. In his *Urgeschichte der germanischen und romanischen Völker* (Berlin, 1881—1890), Dahn went a step farther back still, but here as in his *Geschichte der deutschen Urzeit* (Gotha, 1883—1888), a wealth of picturesque detail has been worked over and resolved into history with such imaginative insight and critical skill as to make real and present the indistinct beginnings of German society. Together with these larger works Dahn wrote many monographs and studies upon primitive German society. Many of his essays were collected in a series of six volumes entitled *Bausteine* (Berlin, 1879—1884). Not less important than his histories are the historical romances, the best-known of which, *Ein Kampf um Rom*, in four volumes (Leipzig, 1876), which has gone through many later editions, was also the first of the series. Others are *Odhins Trost* (Leipzig, 1880); *Die Kreuzfahrer* (Leipzig, 1884);

*Odhins Rache* (Leipzig, 1891); *Julian der Abtrünnige* (Leipzig, 1894), and one of the most popular, *Bis zum Tode getreu* (Leipzig, 1887). The list is too long to be given in full, yet almost all are well-known. Parallel with this great production of learned and imaginative works, Dahn published some twenty small volumes of poetry. The most notable of these are the epics of the early German period. His wife Therese, *née* Frelin von Droste-Hülshoff, was joint-author with him of *Walhall, Germanische Götter und Heldensagen* (Leipzig, 1898).

A collected edition of his works of fiction, both in prose and verse, has reached twenty-one volumes (Leipzig, 1898), and a new edition was published in 1901. Dahn also published four volumes of memoirs, *Erinnerungen* (Leipzig, 1890—1895).

**DAHOMÉY** (Fr. *Dahomé*), a country of West Africa, formerly an independent kingdom, now a French colony. Dahomey is bounded S. by the Gulf of Guinea, E. by Nigeria (British), N. and N.W. by the French possessions on the middle Niger, and W. by the German colony of Togoland. The French colony extends far north of the limits of the ancient kingdom of the same name. With a coast-line of only 75 m. (1° 38' E. to 2° 46' 55" E.), the area of the colony is about 40,000 sq. m., and the population over 1,000,000. As far as 9° N. the width of the colony is no greater than the coast-line. From this point, the colony broadens out both eastward and westward, attaining a maximum width of 200 m. It includes the western part of Borgu (*q.v.*), and reaches the Niger at a spot a little above Illo. Its greatest length N. to S. is 430 m.

*Physical Features.*—The littoral part of the old Slave Coast (see GUINEA), is very low, sandy and obstructed by a bar. Behind the seashore is a line of lagoons, where small steamers can ply; east to west they are those of Porto Novo (or Lake Nokue), Whydah and Grand Popo. The Weme (300 m. long), known in its upper course as the Ofe, the most important river running south, drains the colony from the Bariba country to Porto Novo, entering the lagoon so named. The Zu is a western affluent of the Weme. Farther west is the Kuffu (150 m. long), which, before entering the Whydah lagoon, broadens out into a lake or lagoon called Ahémé, 20 m. long by 5 m. broad. The Makru and Kergigoto, each of which has various affluents, flow north-east to the Niger, which in the part of its course forming the north-east frontier of the colony is only navigable for small vessels and that with great difficulty (see NIGER).

For some 50 m. inland the country is flat, and, after the first mile or two of sandy waste is passed, covered with dense vegetation. At this distance (50 m.) from the coast is a great swamp known as the Lama Marsh. It extends east to west some 25 m. and north to south 6 to 9 m. North of the swamp the land rises by regular stages to about 1650 ft., the high plateau falling again to the basin of the Niger. In the north-west a range of hills known as the Atacora forms a watershed between the basins of the Weme, the Niger and the Volta. A large part of the interior consists of undulating country, rather barren, with occasional patches of forest. The forests contain the baobab, the coco-nut palm and the oil palm. The fauna resembles that of other parts of the West Coast, but the larger wild animals, such as the elephant and hippopotamus, are rare. The lion is found in the regions bordering the Niger. Some kinds of antelopes are common; the buffalo has disappeared.

*Climate.*—The climate of the coast regions is very hot and moist. Four seasons are well marked: the harmattan or long dry season, from the 1st December to the 15th March; the season of the great rains, from the 15th March to the 15th July; the short dry season, from the 15th July to the 15th September; and the "little rains," from the 15th September to the 1st December. Near the sea the average temperature is about 80° F. The harmattan prevails for several days in succession, and alternates with winds from the south and south-west. During its continuance the thermometer falls about 10°, there is not the slightest moisture in the atmosphere, vegetation dries up or droops, the skin parches and peels, and all woodwork is liable to warp and crack with a loud report. Tornadoes occur occasionally. During nine months of the year the climate is tempered by a sea-breeze, which is felt as far inland as Abomey

(60 m.). It generally begins in the morning, and in the summer it often increases to a stiff gale at sundown. In the interior there are but two seasons: the dry season (November to May) and the rainy season (June to October). The rains are more scanty and diminish considerably in the northern regions.

**Inhabitants.**—The inhabitants of the coast region are of pure negro stock. The Dahomeyans (Dahomi), who inhabit the central part of the colony, form one of eighteen closely-allied clans occupying the country between the Volta and Porto Novo, and from their common tongue known as the Ewe-speaking tribes. In their own tongue Dahomeyans are called Fon or Fawin. They are tall and well-formed, proud, reserved in demeanour, polite in their intercourse with strangers, warlike and keen traders. The Mina, who occupy the district of the Popos, are noted for their skill as surf-men, which has gained for them the title of the Krumen of Dahomey. Porto Novo is inhabited by a tribe called Nago, which has an admixture of Yoruba blood and speaks a Yoruba dialect. The Nago are a peaceful tribe and even keener traders than the Dahomi. In Whydah and other coast towns are many mulattos, speaking Portuguese and bearing high-sounding Portuguese names. In the north the inhabitants—Mahi, Bariba, Gurmai,—are also of Negro stock, but scarcely so civilized as the coast tribes. Settled among them are communities of Fula and Hausas. There are many converts to Islam in the northern districts, but the Mahi and Dahomeyans proper are nearly all fetish worshippers.

**Chief Towns.**—The chief port and the seat of government is Kotonu, the starting-point of a railway to the Niger. An iron pier, which extends well beyond the surf, affords facilities for shipping. Kotonu was originally a small village which served as the seaport of Porto Novo and was burnt to the ground in 1890. It has consequently the advantage of being a town laid out by Europeans on a definite plan. Situated on the beach between the sea and the lagoon of Porto Novo, the soil consists of heavy sand. Good hard roads have been made. Owing to an almost continuous, cool, westerly sea-breeze, Kotonu is, in comparison with the other coast towns, decidedly healthy for white men. Porto Novo (pop. about 50,000), the former French headquarters and chief business centre, is on the northern side of the lagoon of the same name and 20 m. north-east of Kotonu by water. The town has had many names, and that by which it is known to Europeans was given by the Portuguese in the 17th century. It contains numerous churches and mosques, public buildings and merchants' residences. Whydah, 23 m. west of Kotonu, is an old and formerly thickly-populated town. Its population is now about 15,000. It is built on the north bank of the coast lagoon about 2 m. from the sea. There is no harbour at the beach, and landing is effected in boats made expressly to pass through the surf, here particularly heavy. Whydah, during the period of the slave-trade, was divided into five quarters: the English, French, Portuguese, Brazilian and native. The three first quarters once had formidable forts, of which the French fort alone survives. In consequence of the thousands of orange and citron trees which adorn it, Whydah is called "the garden of Dahomey." West of Whydah, on the coast and near the frontier of Togoland, is the trading town of Grand Popo. Inland in Dahomey proper are Abomey (*q.v.*), the ancient capital, Allada, Kana (formerly the country residence and burial-place of the kings of Dahomey) and Dogba. In the hinterland are Carnotville (a town of French creation), Nikki and Paraku, Borgu towns, and Garu, on the right bank of the Niger near the British frontier, the terminus of the railway from the coast.

**Agriculture and Trade.**—The agriculture, trade and commerce of Dahomey proper are essentially different from that of the hinterland (*Haut Dahomé*). The soil of Dahomey proper is naturally fertile and is capable of being highly cultivated. It consists of a rich clay of a deep red colour. Finely-powdered quartz and yellow mica are met with, denoting the deposit of disintegrated granite from the interior. The principal product is palm-oil, which is made in large quantities throughout the country. The district of Toffo is particularly noted for its oil-palm orchards. Palm-wine is also made, but the manufacture

is discouraged as the process destroys the tree. Next to palm-oil the principal vegetable products are maize, guinea-corn, cassava, yams, sweet potatoes, plantains, coco-nuts, oranges, limes and the African apple, which grows almost wild. The country also produces ground-nuts, kola-nuts, pine-apples, guavas, spices of all kinds, ginger, okros (*Hibiscus*), sugar-cane, onions, tomatoes and papaws. Plantations of rubber trees and vines have been made. Cattle, sheep, goats and fowls are scarce. There is a large fishing industry in the lagoons. Round the villages, and here and there in the forest, clearings are met with, cultivated in places, but agriculture is in a backward condition. In the grassy uplands of the interior cattle and horses thrive, and cotton of a fairly good quality is grown by the inhabitants for their own use. The prosperity of the country depends chiefly on the export of palm-oil and palm-kernels. Copra, kola-nuts, rubber and dried fish are also exported, the fish going to Lagos. The adulteration of the palm-kernels by the natives, which became a serious menace to trade, was partially checked (1900-1903) by measures taken to ensure the inspection of the kernels before shipment. Trade is mainly with Germany and Great Britain, a large proportion of the cargo passing through the British port of Lagos. Only some 25% of the commerce is with France. Cotton goods (chiefly from Great Britain), machinery and metals, alcohol (from Germany) and tobacco are the chief imports. The volume of trade, which had increased from £701,000 in 1898 to £1,230,000 in 1902, declined in 1903 to £826,000 in consequence of the failure of rain, this causing a decrease in the production of palm-oil and kernels. In 1904 the total rose to £873,399. In 1905 the figure was £734,667, and in 1907 £853,051. By the Anglo-French Convention of 1898 the imposition of differential duties on goods of British origin was forbidden for a period of thirty years from that date.

**Communications.**—The Dahomey railway from Kotonu to the Niger is of metre gauge (3·28 ft.). Work was begun in 1900, and in 1902 the main line was completed to Toffo, a distance of 55 m. Some difficulty was then encountered in crossing the Lama Marsh, but by the end of 1905 the railway had been carried through Abomey to Pauignan, 120 m. from Kotonu. In 1907 the rails had reached Paraku, 150 m. farther north. A branch railway from the main line serves the western part of the colony. It goes via Whydah to Segborué on Lake Ahémé. Besides the railways, tramway lines exist in various parts of Dahomey. One, 28 m. long, runs from Porto Novo through the market-town of Adjara to Sakete, close to the British frontier in the direction of Lagos. This line serves a belt of country rich in oil-palms. Kotonu is a regular port of call for steamers from Europe to the West Coast, and there is also regular steamship communication along the lagoons between Porto Novo and Lagos. There is a steambot service between Porto Novo and Kotonu. A telegraph line connects Kotonu with Abomey, the Niger and Senegal.

**Administration.**—The colony is administered by a lieutenant-governor, assisted by a council composed of official and unofficial members. The colony is divided into territories annexed, territories protected, and "territories of political action," but for administrative purposes the division is into "circles" or provinces. Over each circle is an administrator with extensive powers. Except in the annexed territories the native states are maintained under French supervision, and native laws and customs, as far as possible, retained. Natives, however, may place themselves under the jurisdiction of the French law. Such natives are known as "Assimilés." In general the administrative system is the same as that for all the colonies of French West Africa (*q.v.*). The chief source of revenue is the customs, while the capitation tax contributes most to the local budget.

**History.**—The kingdom of Dahomey, like those of Benin and Ashanti, is an instance of a purely negro and pagan state, endowed with a highly organized government, and possessing a certain amount of indigenous civilization and culture. Its history begins about the commencement of the 17th century. At that period the country now known as Dahomey was included in the extensive kingdom of Allada or Ardrah, of which the capital was the present town of Allada, on the road from Whydah



to Abomey. Allada became dismembered on the death of a reigning sovereign, and three separate kingdoms were constituted under his three sons. One state was formed by one brother round the old capital of Allada, and retained the name of Allada or Ardrah; another brother migrated to the east and formed a state known under the name of Porto Novo; while the third brother, Takudonu, travelled northwards, and after some vicissitudes established the kingdom of Dahomey. The word Dahomey means "in Danh's belly," and is explained by the following legend which, says Sir Richard Burton, "is known (1864) to everybody in the kingdom." Takudonu having settled in a town called Uhwawe encroached on the land of a neighbouring chief named Danh (the snake). Takudonu wearied Danh by perpetual demands for land, and the chief one day exclaimed in anger "soon thou wilt build in my belly." So it came to pass. Takudonu slew Danh and over his grave built himself a palace which was called Dahomey, a name thenceforth adopted by the new king's followers. About 1724-1728 Dahomey, having become a powerful state, invaded and conquered successively Allada and Whydah. The Whydahs made several attempts to recover their freedom, but without success; while on the other hand the Dahomeyans failed in all their expeditions against Grand Popo, a town founded by refugee Whydahs on a lagoon to the west. It is related that the repulses they met with in that quarter led to the order that no Dahomeyan warrior was to enter a canoe. Porto Novo at the beginning of the 19th century became tributary to Dahomey.

Such was the state of affairs at the accession of King Gezo about the year 1818. This monarch, who reigned forty years, raised the power of Dahomey to its highest pitch, extending greatly the border of his kingdom to the north. He boasted of having first organized the Amazons, a force of women to whom he attributed his successes. The Amazons, however, were state soldiery long before Gezo's reign, and what that monarch really did was to reorganize and strengthen the force.

In 1851 Gezo attacked Abeokuta in the Yoruba country and the centre of the Egba power, but was beaten back. In the same year the king signed a commercial treaty with France, in which Gezo also undertook to preserve "the integrity of the territory belonging to the French fort" at Whydah. The fort referred to was one built in the 17th century, and in 1842 made over to a French mercantile house. England, Portugal and Brazil also had "forts" at Whydah—all in a ruinous condition and ungarrisoned. But when in 1852 England, to prevent the slave-trade, blockaded the Dahomeyan coast, energetic protests were made by Portugal and France, based on the existence of these "forts." In 1858 Gezo died. He had greatly reduced the custom of human sacrifice, and left instructions that after his death there was to be no general sacrifice of the palace women.

Gezo was succeeded by his son Gléglé (or Gélélé), whose attacks on neighbouring states, persecution of native Christians, and encouragement of the slave-trade involved him in difficulties with Great Britain and with France. It was, said Earl Russell, foreign secretary, to check "the aggressive spirit of the king of Dahomey" that England in 1861 annexed the island of Lagos. Nevertheless in the following year Gléglé captured Ishagga and in 1864 unsuccessfully attacked Abeokuta, both towns in the Lagos hinterland. In 1863 Commander Wilmot, R.N., and in 1864 Sir Richard Burton (the explorer and orientalist) were sent on missions to the king, but their efforts to induce the Dahomeyans to give up human sacrifices, slave-trading, &c. met with no success. In 1863, however, a step was taken by France which was the counterpart of the British annexation of Lagos. In that year the kingdom of Porto Novo accepted a French protectorate, and an Anglo-French agreement of 1864 fixed its boundaries. This protectorate was soon afterwards abandoned by Napoleon III., but was re-established in 1882. At this period the rivalry of European powers for possessions in Africa was becoming acute, and German agents appeared on the Dahomeyan coast. However, by an arrangement concluded in 1885, the German protectorate in Guinea was confined to

Togo, save for the town of Little Popo at the western end of the lagoon of Grand Popo. In January 1886 Portugal—in virtue of her ancient rights at Whydah—announced that she had assumed a protectorate over the Dahomeyan coast, but she was induced by France to withdraw her protectorate in December 1887. Finally, the last international difficulty in the way of France was removed by the Anglo-French agreement of 1889, whereby Kotonu was surrendered by Great Britain. France claimed rights at Kotonu in virtue of treaties concluded with Gléglé in 1868 and 1878, but the chiefs of the town had placed themselves under the protection of the British at Lagos.

With the arrangements between the European powers the Dahomeyans had little to do, and in 1889, the year in which the Anglo-French agreement was signed, trouble arose between Gléglé and the French. The Dahomeyans were the more confident, as through German and other merchants at Whydah they were well supplied with modern arms and ammunition. Gléglé claimed the right to collect the customs at Kotonu, and to depose the king of Porto Novo, and proceeded to raid the territory of that potentate (his brother). A French mission sent to Abomey failed to come to an agreement with the Dahomeyans, who attributed the misunderstandings to the fact that there was no longer a king in France! Gléglé died on the 28th of December 1889, two days after the French mission had left his capital. He was succeeded by his son Behanzin. A French force was landed at Kotonu, and severe fighting followed in which the Amazons played a conspicuous part. In October 1890 a treaty was signed which secured to France Porto Novo and Kotonu, and to the king of Dahomey an annual pension of £800. It was unlikely that peace on such terms would prove lasting, and Behanzin's slave-raiding expeditions led in 1892 to a new war with France. General A. A. Dodds was placed in command of a strong force of Europeans and Senegalese; and after a sharp campaign during September and October completely defeated the Dahomeyan troops. Behanzin set fire to Abomey (entered by the French troops on the 17th of November) and fled north. Pursued by the enemy, abandoned by his people, he surrendered unconditionally on the 25th of January 1894, and was deported to Martinique, being transferred in 1906 to Algeria, where he died on the 10th of December of the same year.

Thus ended the independent existence of Dahomey. The French divided the kingdom in two—Abomey and Allada—placing on the throne of Abomey a brother of the exiled monarch. Chief among the causes which led to the collapse of the Dahomeyan kingdom was the system which devoted the flower of its womanhood to the profession of arms.

Whydah and the adjacent territory was annexed to France by General Dodds on the 3rd of December 1892, and the rest of Dahomey placed under a French protectorate at the same time. The prince who had been made king of Abomey was found intriguing against the French, and in 1900 was exiled by them to the Congo, and with him disappeared the last vestige of Dahomeyan sovereignty.

Dahomey conquered, the French at once set to work to secure as much of the hinterland as possible. On the north they penetrated to the Niger, on the east they entered Borgu (a country claimed by the Royal Niger Company for Great Britain), on the west they overlapped the territory claimed by Germany as the hinterland of Togo. The struggle with Great Britain and Germany for supremacy in this region forms one of the most interesting chapters in the story of the partition of Africa. In the result France succeeded in securing a junction between Dahomey and her other possessions in West Africa, but failed to secure any part of the Niger navigable from the sea (see *AFRICA: History, and NIGERIA*). A Franco-German convention of 1897 settled the boundary on the west, and the Anglo-French convention of the 14th of June 1898 defined the frontier on the east. In 1899, on the disintegration of the French Sudan, the districts of Fada N'Gurma and Say, lying north of Borgu, were added to Dahomey, but in 1907 they were transferred to Upper Senegal-Niger, with which colony they are closely connected both geographically and ethnographically. From 1894 onward the French devoted great

attention to the development of the material resources of the country.

The "Customs."—Reference has already been made to the Dahomey "Customs," which gave the country an infamous notoriety. The "Customs" appear to date from the middle of the 17th century, and were of two kinds: the grand Customs performed on the death of a king; and the minor Customs, held twice a year. The horrors of these saturnalia of bloodshed were attributable not to a love of cruelty but to filial piety. Upon the death of a king human victims were sacrificed at his grave to supply him with wives, attendants, &c. in the spirit world. The grand Customs surpassed the annual rites in splendour and bloodshed. At those held in 1791 during January, February and March, it is stated that no fewer than 500 men, women and children were put to death. The minor Customs were first heard of in Europe in the early years of the 18th century. They formed continuations of the grand Customs, and "periodically supplied the departed monarch with fresh attendants in the shadowy world." The actual slaughter was preluded by dancing, feasting, speechmaking and elaborate ceremonial. The victims, chiefly prisoners of war, were dressed in calico shirts decorated round the neck and down the sleeves with red hindings, and with a crimson patch on the left breast, and wore long white night-caps with spirals of blue ribbon sewn on. Some of them, tied in haskets, were at one stage of the proceedings taken to the top of a high platform, together with an alligator, a cat and a hawk in similar haskets, and paraded on the heads of the Amazons. The king then made a speech explaining that the victims were sent to testify to his greatness in spirit-land, the men and the animals each to their kind. They were then hurled down into the middle of a surging crowd of natives, and huttered. At another stage of the festival human sacrifices were offered at the shrine of the king's ancestors, and the blood was sprinkled on their graves. This was known as *Zan Nyanyana* or "evil night," the king going in procession with his wives and officials and himself executing the doomed. These semi-public massacres formed only a part of the slaughter, for many women, eunuchs and others within the palace were done to death privately. The skulls were used to adorn the palace walls, and the king's sleeping-chamber was paved with the heads of his enemies. The skulls of the conquered kings were turned into royal drinking cups, their conversion to this use being esteemed an honour. Sir Richard Burton insists (*A Mission to Gelele, King of Dahome*) that the horrors of these rites were greatly exaggerated. For instance, the story that the king floated a canoe in a tank of human blood was, he writes, quite untrue. He denies, too, that the victims were tortured, and affirms that on the contrary they were treated humanely, and, in many cases, even acquiesced in their fate. It seems that cannibalism was a sequel of the Customs, the bodies of the slaughtered being roasted and devoured smoking hot. On the death of the king the wives, after the most extravagant demonstrations of grief, broke and destroyed everything within their reach, and attacked and murdered each other, the uproar continuing until order was restored by the new sovereign.

*Amazonian Army.*—The training of women as soldiers was the most singular Dahomeyan institution. About one-fourth of the whole female population were said to be "married to the fetich," many even before their birth, and the remainder were entirely at the disposal of the king. The most favoured were selected as his own wives or enlisted into the regiments of Amazons, and then the chief men were liberally supplied. Of the female captives the most promising were drafted into the ranks as soldiers, and the rest became Amazonian camp followers and slaves in the royal households. These female levies formed the flower of the Dahomeyan army. They were marshalled in regiments, each with its distinctive uniform and badges, and they took the post of honour in all battles. Their number has been variously stated. Sir R. F. Burton, in 1862, who saw the army marching out of Kana on an expedition, computed the whole force of female troops at 2500, of whom one-third were unarmed or only half-armed. Their weapons were blunderbusses, flint

muskets, and bows and arrows. A later writer estimated the number of Amazons at 1000, and the male soldiers at 10,000. The system of warfare was one of surprise. The army marched out, and, when within a few days' journey of the town to be attacked, silence was enjoined and no fires permitted. The regular highways were avoided, and the advance was by a road specially cut through the hush. The town was surrounded at night, and just before daybreak a rush was made and every soul captured if possible; none were killed except in self-defence, as the first object was to capture, not to kill. The season usually selected for expeditions was from January to March, or immediately after the annual "Customs." The Amazons were carefully trained, and the king was in the habit of holding "autumn manœuvres" for the benefit of foreigners. Many Europeans have witnessed a mimic assault, and agree in ascribing a marvellous power of endurance to the women. Lines of thorny acacia were piled up one behind the other to represent defences, and at a given signal the Amazons, harefooted and without any special protection, charged and disappeared from sight. Presently they emerged within the lines torn and bleeding, but apparently insensible to pain, and the parade closed with a march past, each warrior leading a pretended captive bound with a rope.

**BIBLIOGRAPHY.**—*Notre Colonie de Dahomey*, by G. François (Paris, 1906), and *Le Dahomey* (1909), an official publication, deal with topography, ethnography and economics; L. Brunet and L. Giethlen, *Dahomey et dépendances* (Paris, 1900); Édouard Foà, *Le Dahomey* (Paris, 1895). Religion, laws and language are specially dealt with in *Ewe-Speaking Peoples of the Slave Coast*, by A. B. Ellis (London, 1890), and in *La Côte des Esclaves et le Dahomey*, by P. Bouche (Paris, 1885). Much historical matter, with particular notices of the Amazons and the "Customs," is contained in *A Mission to Gelele*, by Sir R. Burton (London, 1864). The story of the French conquest is told in *Campagne du Dahomey*, by Jules Poirier (Paris, 1895). The standard authority on the early history is *The History of Dahomey*, by Archibald Dalzel (sometime governor of the English fort at Whydah) (London, 1793). The annual Reports issued by the British, Foreign, and French Colonial Offices may be consulted, and the *Bibliographie raisonnée des ouvrages concernant le Dahomey*, by A. Pawlowski (Paris, 1895), is a useful guide to the literature of the country to that date. A *Carte du Dahomey*, by A. Meunier, (3 sheets, scale 1 : 500,000), was published in Paris, 1907.

**DAILLÉ (DALLÆUS), JEAN** (1594–1670), French Protestant divine, was born at Châtelleraut and educated at Poitiers and Saumur. From 1612 to 1621 he was tutor to two of the grandsons of Philippe de Mornay, seigneur du Plessis Marly. Ordained to the ministry in 1623, he was for some time private chaplain to Du Plessis Mornay, whose memoirs he subsequently wrote. In 1625 Daillé was appointed minister of the church of Saumur, and in 1626 was chosen by the Paris consistory to be minister of the church of Charenton. Of his works, which are principally controversial, the best known is the treatise *Du vrai emploi des Pères* (1631), translated into English by Thomas Smith under the title *A Treatise concerning the right use of the Fathers* (1651). The work attacks those who made the authority of the Fathers conclusive on matters of faith and practice. Daillé contends that the text of the Fathers is often corrupt, and that even when it is correct their reasoning is often illogical. In his *Sermons on the Philippians and Colossians*, Daillé vindicated his claim to rank as a great preacher as well as an able controversialist. He was president of the last national synod held in France, which met at Loudun in 1659 (H. M. Baird, *The Huguenots and the Revocation of the Edict of Nantes*, 1895, i. pp. 412 ff.), when, as in the *Apologie des Synodes d'Alençon et de Charenton* (1655), he defended the universalism of Moses Amyraut. He wrote also *Apologie pour les Églises Réformées* and *La Foy fondée sur les Saintes Écritures*. His life was written by his son Adrien, who retired to Zürich at the revocation of the edict of Nantes.

**DAIRY and DAIRY-FARMING** (from the Mid. Eng. *deieris*, from *dey*, a maid-servant, particularly one about a farm; cf. Norw. *deia*, as in *bu-deia*, a maid in charge of live-stock, and in other compounds; thus "dairy" means that part of the farm buildings where the "dey" works). Milk, either in its natural state, or in the form of butter and cheese, is an article of diet so useful, wholesome and palatable, that dairy management, which

includes all that concerns its production and treatment, constitutes a most important branch of husbandry. The physical conditions of the different countries of the world have determined in each case the most suitable animal for dairy purposes. The Laplander obtains his supplies of milk from his rein-deer, the roving Tatar from his mares, and the Bedouin of the desert from his camels. In the temperate regions of the earth many pastoral tribes subsist mainly upon the milk of the sheep. In some rocky regions the goat is invaluable as a milk-yielder; and the buffalo is equally so amid the swamps and jungles of tropical climates. The milking of ewes was once a common practice in Great Britain; but it has fallen into disuse because of its hurtful effects upon the flock. A few milch asses and goats are here and there kept for the benefit of infants or invalids; but with these exceptions the cow is the only animal now used for dairy purposes.

No branch of agriculture underwent greater changes during the closing quarter of the 19th century than dairy-farming; within the period named, indeed, the dairying industry may be said to have been revolutionized. The two great factors in this modification were the introduction about the year 1880 of the centrifugal cream-separator, whereby the old slow system of raising cream in pans was dispensed with, and the invention some ten years later of a quick and easy method of ascertaining the fat content of samples of milk without having to resort to the tedious processes of chemical analysis. About the year 1875 the agriculturists of the United Kingdom, influenced by various economic causes, began to turn their thoughts more intently in the direction of dairy-farming, and to the increased production of milk and cream, butter and cheese. On the 24th of October 1876 was held the first London dairy show, under the auspices of a committee of agriculturists, and it has been followed by a similar show in every subsequent year. The official report of the pioneer show stated that "there was a much larger attendance and a greater amount of enthusiasm in the movement than even the most sanguine of its promoters anticipated." On the day named Professor J. Prince Sheldon read at the show a paper on the dairying industry, and proposed the formation of a society to be called the British Dairy Farmers' Association. This was unanimously agreed to, and thus was founded an organization which has since been closely identified with the development of the dairying industry of the United Kingdom. In its earlier publications the Association was wont to reproduce from *Household Words* the following tribute to the cow:—

"If civilized people were ever to lapse into the worship of animals, the Cow would certainly be their chief goddess. What a fountain of blessings is the Cow! She is the mother of beef, the source of butter, the original cause of cheese, to say nothing of shoe-horns, hair-combs and upper leather. A gentle, amiable, ever-yielding creature, who has no joy in her family affairs which she does not share with man. We rob her of her children that we may rob her of her milk, and we only care for her when the robbing may be perpetrated."

The association has, directly or indirectly, brought about many valuable reforms and improvements in dairying. Its London shows have provided, year after year, a variety of object-lessons in cheese, in butter and in dairy equipment. In order to demonstrate to producers what is the ideal to aim at, there is nothing more effective than a competitive exhibition of products, and the approach to uniform excellence of character in cheese and butter of whatever kinds is most obvious to those who remember what these products were like at the first two or three dairy shows. Simultaneously there has been a no less marked advance in the mechanical aids to dairying, including, in particular, the centrifugal cream-separator, the crude germ of which was first brought before the public at the international dairy show held at Hamburg in the spring of 1877. The association in good time set the example, now beneficially followed in many parts of Great Britain, of providing means for technical instruction in the making of cheese and butter, by the establishment of a dairy school in the Vale of Aylesbury, subsequently removing it to new and excellent premises at Reading, where it is known as the British Dairy Institute. The initiation of

butter-making contests at the annual dairy shows stimulated the competitive instinct of dairy workers, and afforded the public useful object-lessons; in more recent years milking competitions have been added. Milking trials and butter tests of cows conducted at the dairy shows have afforded results of much practical value. Many of the larger agricultural societies have found it expedient to include in their annual shows a working dairy, wherein butter-making contests are held and public demonstrations are given.

What are regarded as the dairy breeds of cattle is illustrated by the prize schedule of the annual London dairy show, in which sections are provided for cows and heifers of the Shorthorn, Jersey, Guernsey, Red Polled, Ayrshire, Kerry and Dexter breeds (see CATTLE). A miscellaneous class is also provided, the entries in which are mostly cross-breds. There are likewise classes for Shorthorn bulls, Jersey bulls, and bulls of any other pure breed, but it is stipulated that all bulls must be of proved descent from dams that have won prizes in the milking trials or butter tests of the British Dairy Farmers' Association or other high-class agricultural society. The importance of securing dairy characters in the sire is thus recognized, and it is notified that, as the object of the bull classes is to encourage the breeding of bulls for dairy purposes, the prizes are to be given solely to animals exhibited in good stock-getting condition.

#### MILK AND BUTTER TESTS

The award of prizes in connexion with milking trials cannot be determined simply by the quantity of milk yielded in a given period, say twenty-four hours. Other matters must obviously be taken into consideration, such as the quality of the milk and the time that has elapsed since the birth of the last calf. With regard to the former point, for example, it is quite possible for one cow to give more milk than another, but for the milk of the second cow to include the larger quantity of butter-fat. The awards are therefore determined by the total number of points obtained according to the following scheme:—

One point for every ten days since calving (deducting the first forty days), with a maximum of fourteen points.

One point for every pound of milk, taking the average of two days' yield.

Twenty points for every pound of butter-fat produced.

Four points for every pound of "solids other than fat."

Deductions.—Ten points each time the fat is below 3%.

Ten points each time the solids other than fat fall below 8.5%.

This method of award is at present the best that can be devised, but it is possible that, as experience accumulates, some rearrangement of the points may be found to be desirable. Omitting many of the details, Table I. shows some of the results in the case of Shorthorn and Jersey prize cows. The days "in milk" denote in each case the number of days that have elapsed since

TABLE I.—Prize Shorthorn and Jersey Cows in the Milking Trials, London Dairy Show, 1900.

Cow.	Age.	In Milk.	Milk per Day.	Fat.	Other Solids.	Total Points.
	Years.	Days.	lb	%	%	No.
<i>Shorthorns eligible for Herd-Book—</i>						
Heroine III.	6	61	52.4	3.7	8.3	91.5
Musical	7	16	45.2	3.2	9.3	90.8
Lady Rosedale	8	48	47.8	3.5	9.0	88.7
<i>Shorthorns not eligible for Herd-Book—</i>						
Granny	9	33	70.2	3.5	8.9	144.1
Cherry	9	103	55.5	4.0	8.9	127.1
Chance	6	23	60.0	3.6	8.9	124.6
<i>Jerseys—</i>						
Sultane 14th	12	256	41.7	4.9	9.4	112
Queen Bess	7½	136	39.4	4.8	9.0	101
Gloaming IV.	7	156	30.5	6.7	9.5	94.9

calving; and if the one day's yield of milk is desired in gallons, it can be obtained approximately<sup>1</sup> by dividing the weight in

<sup>1</sup> A gallon of milk weighs 10.3 lb, so that very little error is involved in converting pounds to gallons by dividing the number of pounds by 10.

pounds by 10: thus, the Shorthorn cow Heroine III. gave 52.4 lb, or 5.24 gallons, of milk per day. The table is incidentally of interest as showing how superior as milch kine are the unregistered or non-pedigree Shorthorns—which are typical of the great majority of dairy cows in the United Kingdom—as compared with the pedigree animals entered, or eligible for entry, in Coates's Herd-Book. The evening's milk, it should be added, is nearly always richer in fat than the morning's, but the percentages in the table relate to the entire day's milk.

The milking trials are based upon a chemical test, as it is necessary to determine the percentage of fat and of solids other than fat in each sample of milk. The butter test, on the other hand, is a churn test, as the cream has to be separated from the milk and churned. The following is the scale of points used at the London dairy show in making awards in butter tests:—

One point for every ounce of butter; one point for every completed ten days since calving, deducting the first forty days. Maximum allowance for period of lactation, 12 points.

Fractions of ounces of butter, and incomplete periods of less than ten days, to be worked out in decimals and added to the total points.

In the case of cows obtaining the same number of points, the prize to be awarded to the cow that has been the longest time in milk.

- No prize or certificate to be given in the case of:—
- (a) Cows under five years old failing to obtain 28 points.
- (b) Cows five years old and over failing to obtain 32 points.

The manner in which butter tests are decided will be rendered clear by a study of Table II. It is seen that whilst the much larger Shorthorn cows—having a bigger frame to maintain and consuming more food—gave both more milk and more

tests conducted by the English Jersey Cattle Society over the period of fourteen years 1886 to 1899 inclusive. These tests were carried out year after year at half a dozen different shows, and the results are classified in Table III. according to the age of the animals. The average time in milk is measured by the number of days since calving, and the milk and butter yields are those for the day of twenty-four hours. The last column shows the "butter ratio." This number is lower in the case of the Jerseys than in that of the general run of dairy cows. The average results from the total of 1023 cows of the various ages are:—One day's milk, 32 lb 2½ oz., equal to about 3 gallons or 12 quarts; one day's butter, 1 lb 10½ oz.; butter ratio, 19.13 or about 16 pints of milk to 1 lb of butter. Individual yields are sometimes extraordinarily high. Thus at the Tring show in 1899 the three leading Jersey cows gave the following results:—

Cow.	Age.	Live-Weight.	In Milk.	Butter.	Butter Ratio.
	Years.	lb	Days.	lb oz.	lb
Sundew 4th	8	929	77	3 6½	15.10
Madeira 5th	7	1060	107	2 15½	16.14
Em	7	864	44	3 4½	13.32

The eight prize-winning Jerseys on this occasion, with an average weight of 916 lb and an average of 117 days in milk, yielded an average of 2 lb 9 oz. of butter per cow in the twenty-four hours, the butter ratio working out at 16.69. At the Tring show of 1900 a Shorthorn cow Cherry gave as much as 4 lb 4½ oz. of butter in twenty-four hours; she had been in milk 41 days, and her butter ratio worked out at 15.79, which is unusually good for a big cow.

In the six years 1895 to 1900 inclusive 285 cows of the Shorthorn, Jersey, Guernsey and Red Polled breeds were subjected to butter tests at the London dairy show, and the general results are summarized in Table IV.

Although cows in the showyard may perhaps be somewhat upset by their unusual surroundings, and thus not yield so well as at home, yet the average results of these butter-test trials over a number of years are borne out by the private trials that

TABLE II.—Prize Shorthorn and Jersey Cows in the Butter Tests, London Dairy Show, 1900.

Cows.	Age.	In Milk.	Milk per Day.	Butter.	Milk to 1 lb Butter.	Points for Butter.	Points for Lactation.	Total Points.
	Years.	Days.	lb oz.	lb oz.	lb	No.	No.	No.
<b>Shorthorns—</b>								
1st	9	104	55 2	2 5½	23.67	37.25	6.40	43.65
2nd	9	34	72 7	2 10½	27.11	42.75	..	42.75
3rd	7	33	58 5	2 7½	23.47	39.75	..	39.75
<b>Jerseys—</b>								
1st	7	157	29 10	2 2½	13.83	34.25	11.70	45.95
2nd	4	103	33 10	2 3	15.37	35.00	6.30	41.30
3rd	12	257	40 13	1 12	23.32	28.00	12.00	40.00

butter in the day of twenty-four hours, the Jersey milk was much the richer in fat. In the case of the first-prize Jersey the "butter ratio," as it is termed, was excellent, as only 13.83 lb of milk were required to yield 1 lb of butter; in the case of the second-prize Shorthorn, practically twice this quantity (or 27.11 lb) was needed. Moreover, if the days in milk are taken into account, the difference in favour of the Jersey is seen to be 123 days.

The butter-yielding capacity of the choicest class of butter cows, the Jerseys, is amply illustrated in the results of the butter

TABLE III.—Summary of the English Jersey Cattle Society's Butter Tests, Fourteen Years, 1886-1899.

Cows' Ages.	Cows Tested.	Average Time in Milk.	Average Milk Yield.	Average Butter Yield.	Quantity Milk to 1 lb Butter.
Years.	No.	Days.	lb oz.	lb oz.	lb
1 to 2	2	34	15 2	0 13	18.43
2 " 3	57	73	24 15½	1 5½	18.74
3 " 4	108	77	29 14½	1 10	18.42
4 " 5	165	72	32 5½	1 11½	19.01
5 " 6	188	80	32 15½	1 12	18.76
6 " 7	189	89	34 7½	1 13	18.92
7 " 8	139	84	33 11½	1 13½	18.40
8 " 9	71	82	33 6½	1 12	19.03
9 " 10	42	92	32 6½	1 11½	18.95
10 " 11	31	88	35 4	1 14½	18.60
11 " 12	15	89	37 1	1 13½	19.96
12 " 13	13	95	34 1½	1 10½	20.56
13 " 14	3	54	42 1½	2 1½	19.85

have taken place in various herds. The trials have, moreover, brought into prominence the peculiarities of different breeds, such as: (a) that the Shorthorns, Red Polls and Kerries, being cattle whose milk contains small fat globules, are better for milk than the Jerseys and Guernseys, whose milk is richer,

TABLE IV.—Average Butter Yields and Butter Ratios at the London Dairy Show, Six Years, 1895-1900.

Breed.	No. of Cows.	In Milk.	Butter.	Milk to 1 lb Butter.
		Days.	lb oz.	lb
Shorthorn	106	50	1 11	28.81
Jersey	126	99	1 10½	19.15
Guernsey	23	72	1 9½	21.86
Red Polled	30	60	1 4½	30.29

containing larger-sized fat globules, and is therefore more profitable for converting into butter; (b) that the weights of the animals, and consequently the proportionate food, must be taken into account in estimating the cost of the dairy produce; (c) that the influence of the stage reached in the period of lactation is much more marked in some breeds than in others.

An instructive example of the milk-yielding capacity of Jersey cows is afforded in the carefully kept records of Lord Rothschild's herd at Tring Park, Herts. Overleaf are given the figures for four years, the gallons being calculated at the rate of 10 lb of milk to the gallon.

In 1897, 30 cows averaged	6396 lb, or	640 gallons per cow.
In 1898, 29 " "	6209 " 621 " "	" "
In 1899, 37 " "	6430 " 643 " "	" "
In 1900, 39 " "	6136 " 614 " "	" "

The average over the four years works out at about 630 gallons per cow per annum.

Cows of larger type will give more milk than the Jerseys, but it is less rich in fat. The milk record for the year 1900 of the herd of Red Polled cattle belonging to Mr Garrett Taylor, Whitlingham, Norfolk, affords a good example. The cows in the herd, which had before 1900 produced one or more calves, and in 1900 added another to the list, being in full profit the greater part of the year, numbered 82. Their total yield was 521,950 lb of milk, or an average of 6365 lb—equivalent to about 636 gallons—per cow. In 1899 the average yield of 96 cows was 6283 lb or 628 gallons; in 1898 the average yield of 75 cows was 6473 lb or 647 gallons. Of cows which dropped a first calf in the autumn of 1899, one of them—Lemon—milked continuously for 462 days, yielding a total of 7166 lb of milk, being still in milk when the herd year closed on the 27th of December. Similar cases were those of Nora, which gave 9066 lb of milk in 455 days; Doris, 8138 lb in 462 days; Brisk, 9248 lb in 469 days; Della, 8806 lb in 434 days, drying 28 days before the year ended; and Lottie, 6327 lb in 394 days, also drying 28 days before the year ended; these were all cows with their first calf. Eight cows in the herd gave milk on every day of the 52 weeks, and 30 others had their milk recorded on 300 days or more. Three heifers which produced a first calf before the 11th of April 1900, averaged in the year 4569 lb of milk, or about 456 gallons. In 1900 three cows, Eyke Jessie, Kathleen and Doss, each gave over 10,000 lb, or 1000 gallons of milk; four cows gave from 9000 lb to 10,000 lb, two from 8000 lb to 9000 lb, 17 from 7000 lb to 8000 lb, 19 from 6000 lb to 7000 lb, 30 from 5000 lb to 6000 lb, and 16 from 4000 lb to 5000 lb. The practice, long followed at Whitlingham, of developing the milk-yielding habit by milking a young cow so long as she gives even a small quantity of milk daily, is well supported by the figures denoting the results.

Though milking trials and butter tests are not usually available to the ordinary dairy farmer in the management of his herd, it is, on the other hand, a simple matter for him to keep what is known as a milk register. By a milk register is meant a record of the quantity of milk yielded by a cow. In other words, it is a quantitative estimation of the milk the cow gives. It affords no information as to the quality of the milk or as to its butter-yielding or cheese-yielding capacity. Nevertheless, by its aid the milk-producing capacity of a cow can be ascertained exactly, and her character in this respect can be expressed by means of figures about which there need be no equivocation. A greater or less degree of exactness can be secured, according to the greater or less frequency with which the register is taken. Even a weekly register would give a fair idea as to the milk yields of a cow, and would be extremely valuable as compared with no register at all.

The practice of taking the milk register, as followed in a well-known dairy, may be briefly described. The cows are always milked in the stalls, and during summer they are brought in twice a day for this purpose. After each cow is milked, the pail containing the whole of her milk is hung on a spring balance suspended in a convenient position, and from the gross weight indicated there is deducted the already known weight of the pail.<sup>1</sup> The difference, which represents the weight of milk, is recorded in a book suitably ruled. This book when open presents a view of one week's records. In the left-hand column are the names of the cows; on the right of this are fourteen columns, two of which receive the morning and evening record of each cow. In a final column on the right appears the week's total yield for each cow; and space is also allowed for any remarks.

<sup>1</sup> A portable milk-weighing appliance is made in which the weight of the pail is included, and an indicator shows on a dial the exact weight in pounds and ounces, and likewise the volume in gallons and pints, of the milk in the pail. When the pail is empty the indicator of course points to zero.

Fractions of a pound are not entered, but 18 lb 12 oz. would be recorded as 19 lb, whereas 21 lb 5 oz. would appear as 21 lb, so that a fraction of over half a pound is considered as a whole pound, and a fraction of under half a pound is ignored. By dividing the pounds by 10 the yield in gallons is readily ascertained.

Every dairy farmer has some idea, as to each of his cows, whether she is a good, a bad or an indifferent milker, but such knowledge is at best only vague. By the simple means indicated the character of each cow as a milk-producer is slowly but surely recorded in a manner which is at once exact and definite. Such a record is particularly valuable to the farmer, in that it shows to him the relative milk-yielding capacities of his cows, and thus enables him gradually to weed out the naturally poor milkers and replace them by better ones. It also guides him in regulating the supply of food according to the yield of milk. The register will, in fact, indicate unerringly which are the best milk-yielding cows in the dairy, and which therefore are, with the milking capacity in view, the best to breed from.

The simplicity and inexpensiveness of the milk register must not be overlooked. These are features which should commend it especially to the notice of small dairy farmers, for with a moderate number of cows it is particularly easy to introduce the register. But even with a large dairy it will be found that, as soon as the system has got fairly established, the additional time and trouble involved will sink into insignificance when compared with the benefits which accrue.

The importance of ascertaining not only the quantity but also, the quality of milk is aptly illustrated in the case of two cows at the Tring show, 1900. The one cow gave in 24 hours 4½ gallons of milk, which at 7d. per gallon would work out at about 2s. 7d.; she made 2 lb 12 oz. of butter, which at 1s. 4d. per lb would bring in 3s. 8d.; consequently by selling the milk the owner lost about 1s. 1d. per day. The second cow gave 5½ gallons of milk, which would work out at 3s. 1d.; she made 1 lb 12 oz. of butter, which would only be worth 2s. 4d., so that by converting the milk into butter the owner lost 9d. per day.

The colour of milk is to some extent an indication of its quality—the deeper the colour the better the quality. The colour depends upon the size of the fat globules, a deep yellowish colour indicating large globules of fat. When the globules are of large size the milk will churn more readily, and the butter is better both in quality and in colour.

The following fifty dairy rules relating to the milking and general management of cows, and to the care of milk and dairy utensils, were drawn up on behalf of, and published by, the United States department of agriculture at Washington. They are given here with a few merely verbal alterations:—

#### THE OWNER AND HIS HELPERS

1. Read current dairy literature and keep posted on new ideas.
2. Observe and enforce the utmost cleanliness about the cattle, their attendants, the cow-house, the dairy and all utensils.
3. A person suffering from any disease, or who has been exposed to a contagious disease, must remain away from the cows and the milk.

#### THE COW-HOUSE

4. Keep dairy cattle in a shed or building by themselves. It is preferable to have no cellar below and no storage loft above.
5. Cow-houses should be well ventilated, lighted and drained; should have tight floors and walls, and be plainly constructed.
6. Never use musty or dirty litter.
7. Allow no strong-smelling material in the cow-house for any length of time. Store the manure under cover outside the cow-house, and remove it to a distance as often as practicable.
8. Whitewash the cow-house once or twice a year; use gypsum in the manure gutters daily.
9. Use no dry, dusty feed just previous to milking; if fodder is dusty, sprinkle it before it is fed.
10. Clean and thoroughly air the cow-house before milking; in hot weather sprinkle the floor.
11. Keep the cow-house and dairy room in good condition, and then insist that the dairy, factory or place where the milk goes be kept equally well.



THE COWS

12. Have the herd examined at least twice a year by a skilled veterinarian.
13. Promptly remove from the herd any animal suspected of being in bad health, and reject her milk. Never add an animal to the herd until it is ascertained to be free from disease, especially tuberculosis.
14. Do not move cows faster than a comfortable walk while on the way to the place of milking or feeding.
15. Never allow the cows to be excited by hard driving, abuse, loud talking or unnecessary disturbance; do not expose them to cold or storms.
16. Do not change the feed suddenly.
17. Feed liberally, and use only fresh, palatable feed-stuffs; in no case should decomposed or mouldy material be used.
18. Provide water in abundance, easy of access, and always pure; fresh, but not too cold.
19. Salt should always be accessible to the cows.
20. Do not allow any strong-flavoured food, like garlic, cabbages and turnips, to be eaten, except immediately after milking.
21. Clean the entire skin of the cow daily. If hair in the region of the udder is not easily kept clean, it should be clipped.
22. Do not use the milk within twenty days before calving, nor for three to five days afterwards.

MILKING

23. The milker should be clean in all respects; he should not use tobacco while milking; he should wash and dry his hands just before milking.
24. The milker should wear a clean outer garment, used only when milking and kept in a clean place at other times.
25. Brush the udder and surrounding parts just before milking and wipe them with a clean damp cloth or sponge.
26. Milk quietly, quickly, cleanly and thoroughly. Cows do not like unnecessary noise or delay. Commence milking at exactly the same hour every morning and evening, and milk the cows in the same order.
27. Throw away (but not on the floor—better in the gutter) the first two or three streams from each teat; this milk is very watery and of little value, but it may injure the rest.
28. If in any milking a part of the milk is bloody or stringy or unnatural in appearance, the whole should be rejected.
29. Milk with dry hands; never let the hands come in contact with the milk.
30. Do not allow dogs, cats or loafers to be around at milking time.
31. If any accident occurs by which a pail, full or partly full, of milk becomes dirty, do not try to remedy this by straining, but reject all this milk and rinse the pail.
32. Weigh and record the milk given by each cow, and take a sample morning and night, at least once a week, for testing by the fat test.

CARE OF MILK

33. Remove the milk of every cow at once from the cow-house to a clean dry room, where the air is pure and sweet. Do not allow cans to remain in the cow-house while they are being filled with milk.
34. Strain the milk through a metal gauze and a flannel cloth or layer of cotton as soon as it is drawn.
35. Cool the milk as soon as strained—to 45° F. if the milk is for shipment, or to 60° if for home use or delivery to a factory.
36. Never close a can containing warm milk.
37. If the cover is left off the can, a piece of cloth or mosquito netting should be used to keep out insects.
38. If milk is stored, it should be kept in tanks of fresh cold water (renewed as often as the temperature increases to any material extent), in a clean, dry, cold room. Unless it is desired to remove cream, it should be stirred with a tin stirrer often enough to prevent the forming of a thick cream layer.
39. Keep the night milk under shelter so that rain cannot get into the cans. In warm weather keep it in a tank of fresh cold water.
40. Never mix fresh warm milk with that which has been cooled.
41. Do not allow the milk to freeze.
42. In no circumstances should anything be added to milk to prevent its souring. Cleanliness and cold are the only preventives needed.
43. All milk should be in good condition when delivered at a creamery or a cheesery. This may make it necessary to deliver twice a day during the hottest weather.
44. When cans are hauled far they should be full, and carried in a spring waggon.
45. In hot weather cover the cans, when moved in a waggon, with a clean wet blanket or canvas.

THE UTENSILS

46. Milk utensils for farm use should be made of metal and have all joints smoothly soldered. Never allow them to become rusty or rough inside.

47. Do not haul waste products back to the farm in the cans used for delivering milk. When this is unavoidable, insist that the skim milk or whey tank be kept clean.
48. Cans used for the return of skim milk or whey should be emptied, scalded and cleaned as soon as they arrive at the farm.
49. Clean all dairy utensils by first thoroughly rinsing them in warm water; next clean inside and out with a brush and hot water in which a cleaning material is dissolved; then rinse and, lastly, sterilize by boiling water or steam. Use pure water only.
50. After cleaning, keep utensils inverted in pure air, and sun if possible, until wanted for use.

FOOD AND MILK PRODUCTION

In their comprehensive paper relating to the feeding of animals published in 1895, Lawes and Gilbert discussed amongst other questions that of milk production, and directed attention to the great difference in the demands made on the food—on the one hand for the production of meat (that is, of animal increase), and on the other for the production of milk. Not only, however, do cows of different breeds yield different quantities of milk, and milk of characteristically different composition, but individual animals of the same breed have very different milk-yielding capacity; and whatever the capacity of a cow may be, she has a maximum yield at one period of her lactation, which is followed by a gradual decline. Hence, in comparing the amounts of constituents stored up in the fattening increase of an ox with the amounts of the same constituents removed in the milk of a cow, it is necessary to assume a wide range of difference in the yield of milk. Accordingly, Table V. shows the

TABLE V.—Comparison of the Constituents of Food carried off in Milk, and in the Fattening Increase of Oxen.

[1 Gallon = 10.33 lb]	Nitrogenous Substance.	Fat.	Non-Nitrogenous Substance not Fat (Sugar).	Mineral Matter.	Total Solid Matter.
<i>In Milk per Week.</i>					
If:—	lb	lb	lb	lb	lb
4 quarts per head per day	2.64	2.53	3.33	0.54	9.04
6 " " " "	3.96	3.80	4.99	0.81	13.56
8 " " " "	5.28	5.06	6.66	1.08	18.08
10 " " " "	6.60	6.33	8.32	1.35	22.60
12 " " " "	7.92	7.59	9.99	1.62	27.12
14 " " " "	9.24	8.86	11.65	1.89	31.64
16 " " " "	10.56	10.12	13.32	2.16	36.16
18 " " " "	11.88	11.39	14.98	2.43	40.68
20 " " " "	13.20	12.65	16.65	2.70	45.20
<i>In Increase in Live-Weight per Week.—Oxen.</i>					
If 10 lb increase . . . . .	0.75	6.35	..	0.15	7.25
If 15 lb increase . . . . .	1.13	9.53	..	0.22	10.88

amounts of nitrogenous substance, of fat, of non-nitrogenous substance not fat, of mineral matter, and of total solid matter, carried off in the weekly yield of milk of a cow, on the alternative assumptions of a production of 4, 6, 8, 10, 12, 14, 16, 18 or 20 quarts per head per day. For comparison, there are given at the foot of the table the amounts of nitrogenous substance, of fat, of mineral matter, and of total solid matter, in the weekly increase in live-weight of a fattening ox of an average weight of 1000 lb—on the assumption of a weekly increase, first, of 10 lb, and, secondly, of 15 lb. The estimates of the amounts of constituents in the milk are based on the assumption that it will contain 12.5% of total solids—consisting of 3.65 albuminoids, 3.50 butter-fat, 4.60 sugar and 0.75 of mineral matter. The estimates of the constituents in the fattening increase of oxen are founded on determinations made at Rothamsted.

With regard to the very wide range of yield of milk per head per day which the figures in the following table assume, it may be remarked that it is by no means impossible that the same animal might yield the largest amount, namely, 20 quarts, or 5 gallons, per day near the beginning, and only 4 quarts, or

1 gallon, or even less, towards the end of her period of lactation. At the same time, an entire herd of, for example, Shorthorns or Ayrshires, of fairly average quality, well fed, and including animals at various periods of lactation, should not yield an average of less than 8 quarts, or 2 gallons, and would seldom exceed 10 quarts, or 2½ gallons, per head per day the year round.

For the sake of illustration, an average yield of milk of 10 quarts, equal 2½ gallons, or between 25 and 26 lb per head per day, may be assumed, and the amount of constituents in the weekly yield at this rate may be compared with that in the weekly increase of the fattening ox at the higher rate assumed in the table, namely, 15 lb per 1000 lb live-weight, or 1.5% per week. It is seen that whilst of the nitrogenous substance of the food the amount stored up in the fattening increase of an ox would be only 1.13 lb, the amount carried off as such in the milk would be 6.6 lb, or nearly six times as much. Of mineral matter, again, whilst the fattening increase would only require about 0.22 lb, the milk would carry off 1.35 lb, or again about six times as much. Of fat, however, whilst the fattening increase would contain 9.53 lb, the milk would contain only 6.33 lb, or only about two-thirds as much. On the other hand, whilst the fattening increase contains no other non-nitrogenous substance than fat, the milk would carry off 8.32 lb in the form of milk-sugar. This amount of milk-sugar, reckoned as fat, would correspond approximately to the difference between the fat in the milk and that in the fattening increase.

It is evident, then, that the drain upon the food is very much greater for the production of milk than for that of meat. This is especially the case in the important item of nitrogenous substance; and if, as is frequently assumed, the butter-fat of the milk is at any rate largely derived from the nitrogenous substance of the food, so far as it is so at least about two parts of such substance would be required to produce one of fat. On such an assumption, therefore, the drain upon the nitrogenous substance of the food would be very much greater than that indicated in the table as existing as nitrogenous substance in the milk. To this point further reference will be made presently.

Attention may next be directed to the amounts of food, and of certain of its constituents, consumed for the production of a given amount of milk. This point is illustrated in Table VI., which shows the constituents consumed per 1000 lb live-weight

TABLE VI.—*Constituents consumed per 1000 lb Live-Weight per Day, for Sustenance and for Milk-Production. The Rothamsted Herd of 30 Cows, Spring 1884.*

	Total Dry Substance.	Digestible.		
		Nitrogenous Substance.	Non-Nitrogenous Substance (as Starch).	Total Nitrogenous and Non-Nitrogenous Substance.
3.1 lb Cotton cake	2.76	1.07	1.50	2.57
2.7 lb Bran . . .	2.33	0.33	1.09	1.42
2.8 lb Hay-chaff .	2.34	0.15	1.18	1.33
5.6 lb Oat-straw-chaff . . .	4.64	0.08	2.21	2.29
62.8 lb Mangel . .	7.85	1.01	5.73	6.74
Total . . . . .	19.92	2.64*	11.71*	14.35
Required for sustenance . . . . .	..	0.57	7.40	7.97
Available for milk. In 23.3 lb milk . . . . .	..	2.07	4.31	6.38
Excess in food . . . . .	..	0.85	3.02	3.87
		1.22	1.29	2.51
<i>Per 1000 lb Live-Weight.</i>				
Wolf . . . . .	lb 24	lb 2.5	lb 12.5†	lb 15.4

\* Albuminoid ratio, 1.4.4.

† Exclusive of 0.4 fat; albuminoid ratio, 1.5.4.

per day in the case of the Rothamsted herd of 30 cows in the spring of 1884. On the left hand are shown the actual amounts of the different foods consumed per 1000 lb live-weight per day; and in the respective columns are recorded—first the amounts of total dry substance which the foods contained, and then the amounts of digestible nitrogenous, digestible non-nitrogenous (reckoned as starch), and digestible total organic substance which the different foods would supply; these being calculated according to Lawes and Gilbert's own estimates of the percentage composition of the foods, and to Wolff's estimates of the proportion of the several constituents which would be digestible.

The first column shows that the amount of total dry substance of food actually consumed by the herd, per 1000 lb live-weight per day, was scarcely 20 lb, whilst Wolff's<sup>1</sup> estimated requirement, as stated at the foot of the table, is 24 lb. But his ration would doubtless consist to a greater extent of hay and straw-chaff, containing a larger proportion of indigestible and effete woody fibre. The figures show, indeed that the Rothamsted ration supplied, though nearly the same, even a somewhat less amount of total digestible constituents than Wolff's.

Of digestible nitrogen substance the food supplied 2.64 lb per day, whilst the amount estimated to be required for sustenance merely is 0.57 lb; leaving, therefore, 2.07 lb available for milk production. The 23.3 lb of milk yielded per 1000 lb live-weight per day would, however, contain only 0.85 lb; and there would thus remain an apparent excess of 1.22 lb of digestible nitrogenous substance in the food supplied. But against the amount of 2.64 lb actually consumed, Wolff's estimate of the amount required for sustenance and for milk-production is 2.5 lb, or but little less than the amount actually consumed at Rothamsted. On the assumption that the expenditure of nitrogenous substance in the production of milk is only in the formation of the nitrogenous substances of the milk, there would appear to have been a considerable excess given in the food. But Wolff's estimate assumes no excess of supply, and that the whole is utilized; the fact being that he supposes the butter-fat of the milk to have been derived largely, if not wholly, from the albuminoids of the food.

It has been shown that although it is possible that some of the fat of a fattening animal may be produced from the albuminoids of the food, certainly the greater part of it, if not the whole, is derived from the carbohydrates. But the physiological conditions of the production of milk are so different from those for the production of fattening increase, that it is not admissible to judge of the sources of the fat of the one from what may be established in regard to the other. It has been assumed, however, by those who maintain that the fat of the fattening animal is formed from albuminoids, that the fat of milk must be formed in the same way. Disallowing the legitimacy of such a deduction, there do, nevertheless, seem to be reasons for supposing that the fat of milk may, at any rate in large proportion, be derived from albuminoids.

Thus, as compared with fattening increase, which may in a sense be said to be little more than an accumulation of reserve material from excess of food, milk is a special product, of a special gland, for a special normal exigency of the animal. Further, whilst common experience shows that the herbivorous animal becomes the more fat the more, within certain limits, its food is rich in carbohydrates, it points to the conclusion that both the yield of milk and its richness in butter are more connected with a liberal supply of the nitrogenous constituents in the food. Obviously, so far as this is the case, it may be only that thereby more active change in the system, and therefore greater activity of the special function, is maintained. The evidence at command is, at any rate, not inconsistent with the supposition that a good deal of the fat of milk may have its source in the breaking up of albuminoids, but direct evidence on the point is still wanting; and supposing such breaking up to take place in the gland, the question arises—What becomes of the by-products? Assuming, however, that such change does take place, the amount of nitrogenous substance supplied to the Rothamsted cows would be less

<sup>1</sup> *Landw. Fütterungslehre*, 5te Aufl., 1888, p. 249.

in excess of the direct requirement for milk-production than the figures in the table would indicate, if, indeed, in excess at all.

The figures in the column of Table VI. relating to the estimated amount of digestible non-nitrogenous substance reckoned as starch show that the quantity actually consumed was 11.71 lb, whilst the amount estimated by Wolff to be required was 12.5 lb, besides 0.4 lb of fat. The figures further show that, deducting 7.4 lb for sustenance from the quantity actually consumed, there would remain 4.31 lb available for milk-production, whilst only about 3.02 lb would be required supposing that both the fat of the milk and the sugar had been derived from the carbohydrates of the food; and, according to this calculation, there would still be an excess in the daily food of 1.29 lb. It is to be borne in mind, however, that estimates of the requirement for mere sustenance are mainly founded on the results of experiments in which the animals are allowed only such a limited amount of food as will maintain them without either loss or gain when at rest. But physiological considerations point to the conclusion that the expenditure, independently of loss or gain, will be the greater the more liberal the ration, and hence it is probable that the real excess, if any, over that required for sustenance and milk-production would be less than that indicated in the table, which is calculated on the assumption of a fixed requirement for sustenance for a given live-weight of the animal. Supposing that there really was any material excess of either the nitrogenous or the non-nitrogenous constituents supplied over the requirement for sustenance and milk-production, the question arises—Whether, or to what extent, it conduced to increase in live-weight of the animals, or whether it was in part, or wholly, voided, and so wasted.

As regards the influence of the period of the year, with its characteristic changes of food, on the quantity and composition of the milk, the first column of the second division of Table VII. shows the average yield of milk per head per day of the Rothamsted herd, averaging about 42 cows, almost exclusively Short-horns, in each month of the year, over six years, 1884 to 1889

It should be stated that the Rothamsted cows had cake throughout the year; at first 4 lb per head per day, but afterwards graduated according to the yield of milk, on the basis of 4 lb for a yield of 28 lb of milk, the result being that then the amount given averaged more per head per day during the grazing period, but less earlier and later in the year. Bran, hay and straw-chaff, and roots (generally mangel), were also given when the animals were not turned out to grass. The general plan was, therefore, to give cake alone in addition when the cows were turned out to grass, but some other dry food, and roots, when entirely in the shed during the winter and early spring months.

Referring to the column showing the average yield of milk per head per day each month over the six years, it will be seen that during the six months January, February, September, October, November and December the average yield was sometimes below 20 lb, and on the average only about 21 lb of milk per head per day; whilst over the other six months it averaged 27.63 lb, and over May and June more than 31 lb, per head per day. That is to say, the quantity of milk yielded was considerably greater during the grazing period than when the animals had more dry food, and roots instead of grass.

Next, referring to the particulars of composition, according to Dr Vieth's results, which may well be considered as typical for the different periods of the year, it is seen that the specific gravity of the milk was only average, or lower than average, during the grazing period, but rather higher in the earlier and later months of the year. The percentage of total solids was rather lower than the average at the beginning of the year, lowest during the chief grazing months, but considerably higher in the later months of the year, when the animals were kept in the shed and received more dry food. The percentage of butter-fat follows very closely that of the total solids, being the lowest during the best grazing months, but considerably higher than the average during the last four or five months of the year, when more dry food was given. The percentage of solids not fat was considerably the lowest during the later months of the grazing period, but average, or higher than average, during the earlier and later months of the year. It may be observed that, according to the average percentages given in the table, a gallon of milk will contain more of both total solids and of butter-fat in the later months of the year; that is, when there is less grass and more dry food given.

TABLE VII.—Percentage Composition of Milk each Month of the Year; also Average Yield of Milk, and of Constituents, per Head per Day each Month, according to Rothamsted Dairy Records.

	Average Composition of Milk each Month, 1884. (Dr Vieth—14,235 analyses.)				Rothamsted Dairy.			
	Specific Gravity.	Butter-Fat.	Solids not Fat.	Total Solids.	Average Yield of Milk per Head per Day, 6 Years.	Estimated Quantity of Constituents in Milk per Head per Day each Month.		
						Butter-Fat.	Solids not Fat.	Total Solids.
		%	%	%	lb	lb	lb	lb
January	1.0325	3.55	9.34	12.89	20.31*	0.72	1.90	2.62
February	1.0325	3.53	9.24	12.77	22.81	0.80	2.11	2.91
March	1.0323	3.50	9.22	12.72	24.19	0.85	2.23	3.08
April	1.0323	3.43	9.22	12.65	26.50	0.91	2.44	3.35
May	1.0324	3.34	9.30	12.64	31.31	1.05	2.91	3.96
June	1.0323	3.31	9.19	12.50	30.81	1.02	2.83	3.85
July	1.0319	3.47	9.13	12.60	28.00	0.97	2.56	3.53
August	1.0318	3.87	9.08	12.95	25.00	0.97	2.27	3.24
September	1.0321	4.11	9.17	13.28	22.94	0.94	2.11	3.05
October	1.0324	4.26	9.27	13.53	21.00	0.89	1.95	2.84
November	1.0324	4.36	9.29	13.65	19.19	0.84	1.78	2.62
December	1.0326	4.10	9.29	13.39	19.31	0.79	1.79	2.58
Mean	1.0323	3.74	9.22	12.96	24.28	0.90	2.24	3.14

\* Average over five years only, as the records did not commence until February 1884.

inclusive; and the succeeding columns show that amounts of butter-fat, of solids not fat, and of total solids in the average yield per head per day in each month of the year, calculated, not according to direct analytical determinations made at Rothamsted, but according to the results of more than 14,000 analyses made, under the superintendence of Dr Vieth, in the laboratory of the Aylesbury Dairy Company in 1884;<sup>1</sup> the samples analysed representing the milk from a great many different farms in each month.

<sup>1</sup> *The Analyst*, April 1885, vol. x. p. 67.

Turning to the last three columns of the table, it is seen that although, as has been shown, the percentage of the several constituents in the milk is lower during the grazing months, the actual amounts contained in the quantity of milk yielded per head are distinctly greater during those months. Thus, the amount of butter-fat yielded *per head per day* is above the average of the year from April to September inclusive; the amounts of solids not fat are over average from April to August inclusive; and the amounts of total solids yielded are average, or over average, from April to August inclusive.

From the foregoing results it is evident that the quantity of milk yielded per head is very much the greater during the grazing months of the year, but that the percentage composition of the milk is lower during that period of higher yield, and considerably higher during the months of more exclusively dry-food feeding. Nevertheless, owing to the much greater quantity of milk yielded during the grazing months, the actual quantity of constituents yielded per cow is greater during those months than during the months of higher percentage composition but lower yield of milk per head. It may be added that a careful consideration of the number of

newly-calved cows brought into the herd each month shows that the results as above stated were perfectly distinct, independently of any influence of the period of lactation of the different individuals of the herd.

The few results which have been brought forward in relation to *milk-production* are admittedly quite insufficient adequately to illustrate the influence of variation in the quantity and composition of the food on the quantity and composition of the milk yielded. Indeed, owing to the intrinsic difficulties of experimenting on such a subject, involving so many elements of variation, any results obtained have to be interpreted with much care and reservation. Nevertheless, it may be taken as clearly indicated that, within certain limits, high feeding, and especially high nitrogenous feeding, does increase both the yield and the richness of the milk.<sup>1</sup> But it is evident that when high feeding is pushed beyond a comparatively limited range, the tendency is to increase the weight of the animal—that is, to favour the development of the individual, rather than to enhance the activity of the functions connected with the reproductive system. This is, of course, a disadvantage when the object is to maintain the milk-yielding condition of the animal; but when a cow is to be fattened off it will be otherwise.

It has been stated that, early in the period of six years in which the Rothamsted results that have been quoted were obtained, the amount of oil-cake given was graduated according to the yield of milk of each individual cow; as it seemed unreasonable that an animal yielding, say, only 4 quarts per day, should receive, beside the home foods, as much cake as one yielding several times the quantity. The obvious inference is, that any excess of food beyond that required for sustenance and milk-production would tend to increase the weight of the animal, which, according to the circumstances, may or may not be desirable.

It may be observed that direct experiments at Rothamsted confirm the view, arrived at by common experience, that roots, and especially mangel, have a favourable effect on the flow of milk. Further, the Rothamsted experiments have shown that a higher percentage of butter-fat, of other solids, and of total solids, was obtained with mangel than with silage as the succulent food. The yield of milk was, however, in a much greater degree increased by grazing than by any other change in the food; and at Rothamsted the influence of roots comes next in order to that of grass, though far behind it, in this respect. But with grazing, as has been shown, the percentage composition of the milk is considerably reduced; though, owing to the greatly increased quantity yielded, the amount of soil-constituents removed in the milk when cows are grazing may nevertheless be greater per head per day than under any other conditions. Lastly, it has been clearly illustrated how very much greater is the demand upon the food, especially for nitrogenous and for mineral constituents, in the production of milk than in that of fattening increase.

<sup>1</sup> The evidence on this point taken by the Committee on Milk and Cream Regulations in 1900 is somewhat conflicting. The report states that an impression commonly prevails that the quality of milk is more or less determined by the nature and composition of the food which the cow receives. One witness said that farmers who produce milk for sale feed differently from what they do if they are producing for butter. Another stated that most of the statistics which go to show that food has no effect on milk fail, because the experiments are not carried far enough to counterbalance that peculiarity of the animal first to utilize the food for itself before utilizing it for the milk. A witness who kept a herd of 100 milking cows expressed the opinion that improvement in the quality of milk can be effected by feeding, though not to any large extent. On the other hand, it was maintained that the fat percentage in the milk of a cow cannot be raised by any manner or method of feeding. It is possible that in the case of cows very poorly fed the addition of rich food would alter the composition of their milk, but if the cows are well-fed to begin with, this would not be so. The proprietor of a herd of 500 milking cows did not think that feeding affected the quality of milk from ordinarily well-kept animals. An experimenter found that the result of resorting to rather poor feeding was that the first effect was produced upon the weight of the cow and not upon the milk; the animal began to get thin, losing its weight, though there was not very much effect upon the quality of the milk.

#### MANURIAL VALUE OF FOOD CONSUMED IN THE PRODUCTION OF MILK

In any attempt to estimate the average value of the manure derived from the consumption of food for the production of milk, the difficulty arising from the very wide variation in the amount of milk yielded by different cows, or by the same cow at different periods of her lactation, is increased by the inadequate character of information concerning the difference in the amount of the food actually consumed by the animal coincidentally with the production of such different amounts of milk. But although information is lacking for correlating, with numerical accuracy, the great difference in milk-yield of individual cows with the coincident differences in consumption to produce it, it may be considered as satisfactorily established that more food is consumed by a herd of cows to produce a fair yield of milk, of say 10 or 12 quarts per head per day, than by an equal live-weight of oxen fed to produce fattening increase. In the cases supposed it may, for practical purposes, be assumed that the cows would consume about one-fourth more food than the oxen. Accordingly, in the Rothamsted estimates of the value of the manure obtained on the consumption of food for the production of milk, it is assumed that one-fourth more will be consumed by 1000 lb live-weight of cows than by the same weight of oxen; but the estimates of the amounts of the constituents of the food removed in the milk, or remaining for manure, are nevertheless reckoned per ton of each kind of food consumed, as in the case of those relating to feeding for the production of fattening increase. It may be added that the calculations of the amounts of the constituents in the milk are based on the same average composition of milk as is adopted in the construction of Table V. Thus the nitrogen is taken at 0.579 (= 3.65 nitrogenous substance) %, the phosphoric acid at 0.2175%, and the potash at 0.1875% in the milk.

Table VIII. shows in detail the estimate of the amount of nitrogen in one ton of each food, and in the milk produced from its consumption, on the assumption of an average yield of 10 quarts per head per day; also the amount remaining for manure, the amount of ammonia corresponding to the nitrogen, and the value of the ammonia at 4d. per lb. Similar particulars are also given in relation to the phosphoric acid and the potash consumed in the food, removed in the milk, and remaining for manure, &c. This table will serve as a sufficient illustration of the mode of estimating the *total or original* value of the manure, derived from the consumption of the different foods for the production of milk in the case supposed; that is, assuming an average yield of a herd of 10 quarts per head per day.

In Table IX. are given the results of similar detailed calculations of the *total or original* manure-value (as in Table VIII. for 10 quarts), on the alternative assumptions of a yield of 6, 8, 12 or 14 quarts per head per day. For comparison there is also given, in the first column, the estimate of the *total or original* manure-value when the foods are consumed for the production of fattening increase.

So much for the plan and results of the estimations of *total or original* manure-value of the different foods, that is, deducting only the constituents removed in the milk, and reckoning the remainder at the prices at which they can be purchased in artificial manures. With a view to direct application to practice, however, it is necessary to estimate the *unexhausted manure-value* of the different foods, or what may be called their *compensation-value*, after they have been used for a series of years by the outgoing tenant and he has realized a certain portion of the manure-value in his increased crops. In the calculations for this purpose the rule is to deduct one-half of the *original manure-value* of the food used the last year, and one-third of the remainder each year to the eighth, in the case of all the more concentrated foods and of the roots—in fact, of all the foods in the list excepting the hays and the straws. For these, which contain larger amounts of indigestible matter, and the constituents of which will be more slowly available to crops, two-thirds of the *original manure-value* is deducted for the last year, and only

TABLE VIII.—Estimates of the Total or Original Manure-Value of Cattle Foods after Consumption by Cows for the Production of Milk. Valuation on the assumption of an average production by a herd of 10 quarts of milk per head per day.

Nos.	Description of Food.	Nitrogen.					Phosphoric Acid.				Potash.				Total or Original Manure-Value per Ton of Food consumed.
		In 1 Ton of Food.	In Milk from 1 Ton of Food.	In Manure.			In 1 Ton of Food.	In Milk from 1 Ton of Food.	In Manure.		In 1 Ton of Food.	In Milk from 1 Ton of Food.	In Manure.		
				Total remaining for Manure.	Nitrogen equal Ammonia.	Value of Ammonia at 4d. per lb.			Total remaining for Manure.	Value at 2d. per lb.			Total remaining for Manure.	Value at 1½d. per lb.	
1	Linseed	80.64	25.04	55.60	67.52	1 2 6	34.50	9.34	25.16	4 2	30.69	8.02	22.67	2 10	1 9 6
2	Linseed cake	106.40	20.86	85.54	103.87	1 14 7	44.80	7.79	37.01	6 2	31.36	6.71	24.65	3 1	2 3 10
3	Decorticated cotton cake	147.84	19.27	128.57	156.13	2 12 1	69.44	7.18	62.26	10 5	44.80	6.22	38.58	4 10	3 7 4
4	Palm-nut cake	56.00	17.86	38.14	46.31	0 15 5	26.88	6.68	20.20	3 4	11.20	5.73	5.47	0 8	0 19 5
5	Undecorticated cotton cake	84.00	15.66	68.34	82.99	1 7 8	44.80	5.85	38.95	6 6	44.80	5.07	39.73	5 0	1 19 2
6	Cocoa-nut cake	76.16	15.66	60.50	73.47	1 4 6	31.36	5.85	25.51	4 3	44.80	5.07	39.73	5 0	1 13 9
7	Rape cake	109.76	12.50	97.26	118.11	1 19 4	56.00	4.69	51.31	8 7	33.60	4.09	29.51	3 8	2 11 7
8	Peas	80.64	17.86	62.78	76.24	1 5 5	19.04	6.68	12.36	2 1	21.50	5.73	15.77	2 0	1 9 6
9	Beans	89.60	17.86	71.74	87.12	1 9 0	24.64	6.68	17.96	3 0	29.12	5.73	23.39	2 11	1 14 11
10	Lentils	94.08	17.86	76.22	92.56	1 10 10	16.80	6.68	10.12	1 8	15.68	5.73	9.95	1 3	1 13 9
11	Tares (seed)	94.08	17.86	76.22	92.56	1 10 10	17.92	6.68	11.24	1 10	17.92	5.73	12.19	1 6	1 14 2
12	Maize	38.08	17.38	20.70	25.14	0 8 5	13.44	6.50	6.94	1 2	8.29	5.56	2.73	0 4	0 9 11
13	Wheat	40.32	17.38	22.94	27.86	0 9 3	19.04	6.50	12.54	2 1	11.87	5.56	6.31	0 9	0 12 1
14	Malt	38.08	17.86	20.22	24.55	0 8 2	17.92	6.68	11.24	1 10	11.20	5.73	5.47	0 8	0 10 8
15	Barley	36.96	17.38	19.58	23.78	0 7 11	16.80	6.50	10.30	1 9	12.32	5.56	6.76	0 10	0 10 6
16	Oats	44.80	16.68	28.12	34.15	0 11 5	13.44	6.24	7.20	1 2	11.20	5.40	5.80	0 9	0 13 4
17	Rice meal	42.56	16.68	25.88	31.43	0 10 6	(13.44)	6.24	7.20	1 2	(8.29)	5.40	2.89	0 4	0 12 0
18	Locust beans	26.88	13.90	12.98	15.76	0 5 3	..	5.19	..	..	..	4.42	..	..	..
19	Malt coombs	87.36	15.66	71.70	87.07	1 9 0	44.80	5.85	38.95	6 6	44.80	5.07	39.73	5 0	2 0 6
20	Fine pollard	54.88	16.68	38.20	46.39	0 15 6	44.96	6.24	58.72	9 9	32.70	5.40	27.30	3 5	1 8 8
21	Coarse pollard	56.00	15.66	40.34	48.99	0 16 4	78.40	5.85	72.55	12 1	33.60	5.07	28.53	3 7	1 12 0
22	Bran	56.00	13.90	42.10	51.12	0 17 0	80.64	5.19	75.45	12 7	32.48	4.42	28.06	3 6	1 13 1
23	Clover hay	53.76	8.94	44.82	54.43	0 18 2	12.77	3.35	9.42	1 7	33.60	2.94	30.66	3 10	1 3 7
24	Meadow hay	33.60	8.36	25.24	30.65	0 10 3	8.96	3.10	5.86	1 0	35.84	2.62	33.22	4 2	0 15 5
25	Pea straw	22.40	7.83	14.57	17.69	0 5 11	7.84	2.91	4.93	0 10	22.40	2.46	19.94	2 6	0 9 3
26	Oat straw	11.20	6.95	4.25	5.16	0 1 9	5.38	2.60	2.78	0 6	22.40	2.29	20.11	2 6	0 4 9
27	Wheat straw	10.08	5.98	4.10	4.98	0 1 8	5.38	2.23	3.15	0 6	17.92	1.96	15.96	2 0	0 4 2
28	Barley straw	8.96	5.46	3.50	4.25	0 1 5	4.03	2.04	1.99	0 4	22.40	1.80	20.60	2 7	0 4 4
29	Bean straw	20.16	5.68	14.48	17.58	0 5 10	6.72	2.14	4.58	0 9	22.40	1.80	20.60	2 7	0 9 2
30	Potatoes	5.60	2.07	3.53	4.29	0 1 5	3.36	0.78	2.58	0 5	12.32	0.66	11.66	1 5	0 3 3
31	Carrots	4.48	1.46	3.02	3.67	0 1 3	2.02	0.54	1.48	0 3	6.27	0.49	5.78	0 9	0 2 3
32	Parsnips	4.93	1.67	3.26	3.96	0 1 4	4.26	0.63	3.63	0 7	8.06	0.49	7.57	0 11	0 2 10
33	Mangel wurzels	4.93	1.32	3.61	4.38	0 1 6	1.57	0.49	1.08	0 2	8.96	0.49	8.47	1 1	0 2 9
34	Swedish turnips	5.60	1.14	4.46	5.42	0 1 10	1.34	0.44	0.90	0 2	4.93	0.33	4.60	0 7	0 2 7
35	Yellow turnips	4.48	0.93	3.55	4.31	0 1 5	(1.34)	0.34	1.00	0 2	(4.93)	0.33	(4.60)	0 7	0 2 2
36	White turnips	4.03	0.84	3.19	3.87	0 1 3	1.12	0.31	0.81	0 2	6.72	0.33	6.39	0 10	0 2 3

one-fifth from year to year to the eighth year back. The results of the estimates of *compensation-value* so made are given for the five yields of 6, 8, 10, 12 and 14 quarts of milk per head per day respectively in Lawes and Gilbert's paper<sup>1</sup> on the valuation of the manures obtained by the consumption of foods for the production of milk, which may be consulted for fuller details. It must, however, be borne in mind that when cows are fed in sheds or yards the manure is generally liable to greater losses than is the case with fattening oxen. The manure of the cow contains much more water in proportion to solid matter than that of the ox. Water will, besides, frequently be used for washing, and it may be that a good deal of the manure is washed into drains and lost. In the event, therefore, of a claim for compensation, the management and disposal of the manure requires the attention of the valuer. Indeed, the varying circumstances that will arise in practice must be carefully considered. Bearing these in mind, the estimates may be accepted as at any rate the best approximation to the truth

<sup>1</sup> Journ. Roy. Agric. Soc., 1898.

that existing knowledge provides; and they should be found sufficient for the requirements of practical use. Obviously they will be more directly applicable in the case of cows feeding entirely on the foods enumerated in the list, and not depending largely on grass; but, even when the animals are partially grass-fed, the value of the manure derived from the additional dry food or roots may be estimated according to the scale given.

CHEESE AND CHEESE-MAKING

For generations, perhaps for centuries, the question has been discussed as to why there should be so large a proportion of bad and inferior cheese and so small a proportion of really good cheese made in farmhouses throughout the land. That the result is not wholly due to skill and care or to the absence of these qualities on the part of the dairymaid may now be taken for granted. Instances might be quoted in which the most painstaking of dairymaids, in the cleanest of dairies, have failed to produce cheese of even second-rate quality and character, and yet others in which excellent cheese has been made under commonplace



conditions as to skill and equipment, and with not much regard to cleanliness in the dairy. The explanation of what was so long a mystery has been found in the domain of ferments. It is now known that whilst various micro-organisms, which in many dairies have free access to the milk, have ruined an incalculable quantity of cheese—and of butter also—neither cheese nor butter of first-rate quality can be made without the aid of lactic acid bacilli. As an illustrative case, mention may be made of that of two most painstaking dairymaids who had tried in vain to make good cheese from the freshest of milk in the

organism; (2) this organism abounds in all samples of sour milk and sour whey; (3) the use of a whey starter is attended with results equal in every respect to those obtained from a milk-starter. It is well within the power of any dairyman to prepare what is practically a pure culture of the same bacterium as is supplied from the laboratory. Moreover, the sour-whey starter used by some of the successful cheese-makers before the introduction of the American system is in effect a pure culture, from which it follows that these men had, by empirical methods, attained the same end as that to which bacteriological research

subsequently led. Wherever a starter is necessary, the use of a culture practically pure is imperative, whether such culture be obtained from the laboratory or prepared by what may be called the "home-made starter." Pure cultures may be bought for a few shillings in the open market.

The factory-made cheese of Canada, the United States and Australasia, which is so largely imported into the United Kingdom, is all of the Cheddar type. The factory system has made no headway in the original home of the Cheddar cheese in the west of England. The system was thus described in the *Journal* of the British Dairy Farmers' Association in 1889 by Mr R. J. Drummond:—

"In the year 1885 I was engaged as cheese instructor by the Ayrshire Dairy Association, to teach the Canadian system of Cheddar cheese-making. I commenced operations under many difficulties, being a total stranger to both the people and the country, and with this, the quantities of milk were very much less than I had been in the habit of handling. Instead of having the milk from 500 to 1000 cows, we had to operate with the milk from 25 to not over 60 cows.

"The system of cheese-making commonly practised in the county of Ayr at that time was what is commonly known as the Joseph Harding or English Cheddar system, which differs from the Canadian system in many details, and in one particular is essentially different, namely, the manner in which the necessary acidity in the milk is produced. In the old method a certain quantity of sour whey was added to the milk each day before adding the rennet, and I have no doubt in my own mind that this whey was often added when the milk was already acid enough, and the consequence was a spoiled cheese.

"Another objection to this system of adding sour whey was, should the stuff be out of condition one day, the same trouble was inoculated with the milk from day to day, and the result was sure to be great unevenness in the quality of the cheese. The utensils commonly in use were very different to anything I had ever seen before; instead of the oblong cheese vat with double casings, as is used by the best makers at the present time, a tub, sometimes of tin and sometimes of wood, from 4 to 7 ft. in diameter by about 30 in. deep, was universally in use. Instead of being able to heat the milk with warm water or steam, as is commonly done now, a large can of a capacity of from 20 to 30 gallons was filled with cold milk and placed in a common hot-water boiler, and heated sufficiently to bring the whole body of the milk in the tub to the desired temperature for adding the rennet. I found that many mistakes were made in the quantity of rennet used, as scarcely any two makers used the same quantity to a given quantity of milk. Instead of having a graduated measure for measuring the rennet, a common tea-cup was used for this purpose, and I have found in some dairies as low as 3 oz. of rennet was used to 100 gallons of milk, where in others as high as 6½ oz. was used to the same quantity. This of itself would cause a difference in the quality of the cheese.

"Coagulation and breaking completed, the second heating was effected by dipping the whey from the curd into the can already

TABLE IX.—Comparison of the Estimates of Total or Original Manure-Value when Foods are consumed for the Production of Fattening Increase, with those when the Food is consumed by Cows giving different Yields of Milk.

Nos.	Description of Food.	Total or Original Manure-Value per Ton of Food consumed—that is, only deducting the Constituents in Fattening Increase or in Milk.						
		For the Production of Fattening Increase	For the Production of Milk, supposing the Yield per Head per Day to be as under—					
			6 qts.	8 qts.	10 qts.	12 qts.	14 qts.	
		£ s. d.	£ s. d.	£ s. d.	£ s. d.	£ s. d.	£ s. d.	£ s. d.
1	Linseed	1 19 2	1 14 7	1 12 0	1 9 6	1 7 1	1 4 5	
2	Linseed cake	2 11 11	2 8 1	2 6 0	2 3 10	2 1 9	1 19 8	
3	Decorticated cotton cake	3 14 9	3 11 2	3 9 2	3 7 4	3 5 4	3 3 4	
4	Palm-nut cake	1 6 4	1 3 2	1 1 4	0 19 5	0 17 9	0 15 11	
5	Undecorticated cotton cake	2 5 3	2 2 4	2 0 8	1 19 2	1 17 6	1 15 11	
6	Cocoa-nut cake	1 19 10	1 16 11	1 15 3	1 13 9	1 12 3	1 10 6	
7	Rape cake	2 16 5	1 14 2	2 12 11	2 11 7	2 10 4	2 9 1	
8	Peas	1 16 5	1 13 1	1 11 2	1 9 6	1 7 8	1 5 9	
9	Beans	2 1 11	1 18 7	1 16 10	1 14 11	1 13 1	1 11 4	
10	Lentils	2 0 8	1 17 5	1 15 7	1 13 9	1 12 2	1 10 1	
11	Tares (seed)	2 1 1	1 17 11	1 16 0	1 14 2	1 12 6	1 10 7	
12	Maize	0 16 7	0 13 4	0 11 7	0 9 11	0 8 1	0 6 5	
13	Wheat	0 18 11	0 15 8	0 13 11	0 12 1	0 10 5	0 8 8	
14	Malt	0 17 7	0 14 5	0 12 7	0 10 8	0 9 0	0 7 1	
15	Barley	0 17 2	0 14 0	0 12 3	0 10 6	0 8 8	0 6 11	
16	Oats	0 19 9	0 16 8	0 15 0	0 13 4	0 11 7	0 9 10	
17	Rice meal	(0 18 6)	0 15 5	0 13 9	0 12 0	0 10 5	0 8 7	
18	Locust beans	..	..	..	..	..	..	
19	Malt coombs	2 6 7	2 3 9	2 2 0	2 0 6	1 18 11	1 17 4	
20	Fine pollard	1 15 2	1 12 0	1 10 5	1 8 8	1 6 11	1 5 3	
21	Coarse pollard	1 18 1	1 15 2	1 13 6	1 12 0	1 10 5	1 8 9	
22	Bran	1 18 6	1 15 11	1 14 6	1 13 1	1 11 8	1 10 3	
23	Clover hay	1 7 0	1 5 5	1 4 5	1 3 7	1 2 8	1 1 8	
24	Meadow hay	0 18 7	0 17 0	0 16 3	0 15 5	0 14 5	0 13 7	
25	Pea straw	0 12 2	0 10 9	0 10 0	0 9 3	0 8 5	0 7 8	
26	Oat straw	0 7 5	0 6 2	0 5 5	0 4 9	0 4 0	0 3 3	
27	Wheat straw	0 6 6	0 5 5	0 4 10	0 4 2	0 3 6	0 3 0	
28	Barley straw	0 6 5	0 5 6	0 4 10	0 4 4	0 3 9	0 3 2	
29	Bean straw	0 11 5	0 10 4	0 9 9	0 9 2	0 8 7	0 8 0	
30	Potatoes	0 4 1	0 3 9	0 3 6	0 3 3	0 3 1	0 2 11	
31	Carrots	0 2 9	0 2 6	0 2 4	0 2 3	0 2 1	0 1 11	
32	Parsnips	0 3 6	0 3 3	0 3 1	0 2 10	0 2 8	0 2 7	
33	Mangel wurzels	0 3 2	0 3 0	0 2 10	0 2 9	0 2 7	0 2 5	
34	Swedish turnips	0 2 11	0 2 9	0 2 8	0 2 7	0 2 5	0 2 3	
35	Yellow turnips	(0 2 6)	0 2 4	0 2 3	0 2 2	0 2 1	0 2 0	
36	White turnips	0 2 7	0 2 5	0 2 4	0 2 3	0 2 2	0 2 0	

cleanest of dairies in North Lancashire. Advice to resort to the use of the ferment was acted upon, and the result was a revelation and a transformation, excellent prize-winning cheese being made from that time forward. By the addition of a "starter," in the form of a small quantity of sour milk, whey or buttermilk, in an advanced stage of fermentation, the development of acidity in the main body of milk is accelerated. It has been ascertained that the starter is practically a culture of bacteria, which, if desired, may be obtained as a pure culture. Professor J. R. Campbell, as the result of experiments on pure cultures for Cheddar cheese-making, states<sup>1</sup> that (1) first-class Cheddar cheese can be made by using pure cultures of a lactic

<sup>1</sup> *Trans. Highl. and Agric. Soc. Scot., 1899.*

mentioned, and heated to a temperature of 140° F., and returned to the curd, and thus the process was carried on till the desired temperature was reached. This mode of heating I considered very laborious and at the same time very unsatisfactory, as it is impossible to distribute the heat as evenly through the curd in this way as by heating either with hot water or steam. The other general features of the method do not differ from our own very materially, with the exception that in the old method the curd was allowed to mature in the bottom of the tub, where at the same stage we remove the curd from the vat to what we call a curd-cooler, made with a sparred bottom, so as to allow the whey to separate from the curd during the maturing or ripening process. In regard to the quality of cheese on the one method compared with the other, I think that there was some cheese just as fine made in the old way as anything we can possibly make in the new, with one exception, and that is, that the cheese made according to the old method will not toast—instead of the casein melting down with the butter-fat, the two become separated, which is very much objected to by the consumer—and, with this, want of uniformity through the whole dairy. This is a very short and imperfect description of how the cheese was made at the time I came into Ayrshire; and I will now give a short description of the system that has been taught by myself for the past four years, and has been the means of bringing this county so prominently to the front as one of the best cheese-making counties in Britain.

"Our duty in this system of cheese-making begins the night before, in having the milk properly set and cooled according to the temperature of the atmosphere, so as to arrive at a given heat the next morning. Our object in this is to secure, at the time we wish to begin work in the morning, that degree of acidity or ripeness essential to the success of the whole operation. We cannot give any definite guide to makers how, or in what quantities, to set their milk, as the whole thing depends on the good judgment of the operator. If he finds that his milk works best at a temperature of 68° F. in the morning, his study the night before should tend toward such a result, and he will soon learn by experience how best to manage the milk in his own individual dairy. I have found in some dairies that the milk worked quite fast enough at a temperature of 64° in the morning, where in others the milk set in the same way would be very much out of condition by being too sweet, causing hours of delay before matured enough to add the rennet. Great care should be taken at this point, making sure that the milk is properly matured before the rennet is added, as impatience at this stage often causes hours of delay in the making of a cheese. I advise taking about six hours from the time the rennet is added till the curd is ready for salting, which means a six-hours' process; if much longer than this, I have found by experience that it is impossible to obtain the best results. The cream should always be removed from the night's milk in the morning and heated to a temperature of about 84° before returning it to the vat. To do this properly and with safety, the cream should be heated by adding about two-thirds of warm milk as it comes from the cow to one-third of cream, and passed through the ordinary milk-strainers. If colouring matter is used, it should be added fifteen to twenty minutes before the rennet, so as to become thoroughly mingled with the milk before coagulation takes place.

"We use from 4 to 4½ oz. of Hansen's rennet extract to each 100 gallons of milk, at a temperature of 86° in spring and 84° in summer, or sufficient to coagulate milk firm enough to cut in about forty minutes when in a proper condition. In cutting, great care should be taken not to bruise the curd. I cut lengthwise, then across with perpendicular knife, then with horizontal knife the same way of the perpendicular, leaving the curd in small cubes about the size of ordinary peas. Stirring with the hands should begin immediately after cutting, and continue for ten to fifteen minutes prior to the application of heat. At this stage we use a rake instead of the hands for stirring the curd during the heating process, which lasts about one hour from the time of beginning until the desired temperature of 100° or 102° is reached. After heating, the curd should be stirred another twenty minutes, so as to become properly firm before allowing it to settle. We like the curd to lie in the whey fully one hour after allowing it to settle before it is ready for drawing the whey, which is regulated altogether by the condition of the milk at the time the rennet is added. At the first indication of acid, the whey should be removed as quickly as possible. I think at this point lies the greatest secret of cheese-making—to know when to draw the whey.

"I depend entirely on the hot-iron test at this stage, as I consider it the most accurate and reliable guide known to determine when the proper acidity has been developed. To apply this test, take a piece of steel bar about 18 in. long by 1 in. wide and ½ in. thick, and heat to a black heat; if the iron is too hot, it will burn the curd; if too cold, it will not stick; consequently it is a very simple matter to determine the proper heat. Take a small quantity of the curd from the vat and compress it tightly in the hand, so as to expel all the whey; press the curd against the iron, and when acid enough it will draw fine silky threads ½ in. long. At this stage the curd should be removed to the curd-cooler as quickly as possible, and stirred till dry enough to allow it to mat, which generally takes from five to eight minutes. The curd is now allowed to stand in one end of the cooler for thirty minutes, when it is cut into pieces from 6 to

8 in. square and turned, and so on every half-hour until it is fit for milling. After removing the whey, a new acid makes its appearance in the body of the curd, which seems to depend for its development upon the action of the air, and the presence of which experience has shown to be an essential element in the making of a cheese. This acid should be allowed to develop properly before the addition of salt. To determine when the curd is ready for salting, the hot-iron test is again resorted to; and when the curd will draw fine silky threads 1½ in. long, and at the same time have a soft velvety feel when pressed in the hand, the butter-fat will not separate with the whey from the curd. I generally advise using 1 lb of salt to 50 lb of curd, more or less, according to the condition of the curd. After salting, we let the curd lie fifteen minutes, so as to allow the salt to be thoroughly dissolved before pressing.

"In the pressing, care should be taken not to press the curd too severely at first, as you are apt to lose some of the butter-fat, and with this I do not think that the whey will come away so freely by heavy pressing at first. We advise three days' pressing before cheese is taken to the curing-room. All cheese should have a bath in water at a temperature of 120° next morning after being made, so as to form a good skin to prevent cracking or chipping. The temperature of the curing-room should be kept as near 60° as possible at all seasons of the year, and I think it a good plan to ventilate while heating."

With regard to the hot-iron test for acidity, Mr F. J. Lloyd, in describing his investigations on behalf of the Bath and West of England Society, states that cheese-makers have long known that in both the manufacture and the ripening of cheese the acidity produced—known to the chemist as "lactic acid"—materially influences the results obtained, and that amongst other drawbacks to the test referred to is the uncertainty of the temperature of the iron itself. He gives an account,<sup>1</sup> however, of a chemical method involving the use of a standard solution of an alkali (soda), and of a substance termed an "indicator" (phenolphthalein), which changes colour according to whether a solution is acid or alkaline. The apparatus used with these reagents is called the acidimeter. The two stages in the manufacture of a Cheddar cheese most difficult to determine empirically are—(1) when to stop stirring and to draw the whey, and (2) when to grind the curd. The introduction of the acidimeter has done away with these difficulties; and though the use of this apparatus is not actually a condition essential to the manufacture of a good cheese, it is to many makers a necessity and to all an advantage. By its use the cheese-maker can determine the acidity of the whey, and so decide when to draw the latter off, and will thus secure not only the proper development of acidity in the subsequent changes of cheese-making, but also materially diminish the time which the cheese takes to make. Furthermore, it has been proved that the acidity of the whey which drains from the curd when in the cooler is a sufficiently accurate guide to the condition of the curd before grinding; and by securing uniformity in this acidity the maker will also ensure uniformity in the quality and ripening properties of the cheese. Speaking generally, the acidity of the liquid from the press should never fall below 0.80% nor rise above 1.20%, and the nearer it can be kept to 1.00% the better. Simultaneously, of course, strict attention must be paid to temperature, time and every other factor which can be accurately determined. Analyses of large numbers of Cheddar cheeses manufactured in every month of the cheese-making season show the average composition of ripe specimens to be—water, 35.58%; fat, 31.33; casein, 29.12; mineral matter or ash, 3.97. It has been maintained that in the ripening of Cheddar cheese fat is formed out of the curd, but a comparison of analyses of ripe cheeses with analyses of the curd from which the cheeses were made affords no evidence that this is the case.

The quantity of milk required to make 1 lb of Cheddar cheese may be learnt from Table X., which shows the results obtained at the cheese school of the Bath and West of England Society in the two seasons of 1899 and 1900. The cheese was sold at an average age of ten to twelve weeks. In 1899 a total of 21,220 gallons of milk yielded 20,537 lb of saleable cheese, and in 1900, 31,808 gallons yielded 29,631 lb. In the two years together 53,028 gallons yielded 50,168 lb, which is equivalent to 1.05 gallon of milk to 1 lb of cheese. For practical purposes it may

<sup>1</sup> Report on Cheddar Cheese-Making, London, 1899.

be taken that one gallon, or slightly over 10 lb. of milk, yields 1 lb of pressed cheese. The prices obtained are added as a matter of interest.

Cheshire cheese is largely made in the county from which it takes its name, and in adjoining districts. It is extensively consumed in Manchester and Liverpool, and other parts of the densely populated county of Lancaster.

TABLE X.—Quantities of Milk employed and of Cheese produced in the Manufacture of Cheddar Cheese.

When Made.	Milk.	Green Cheese.	Saleable Cheese.	Shrinkage.	Price.
	galls.	lb	lb		per cwt.
April 1899 . . . . .	3077	3100	2924	6 per cent.	60s.
May . . . . .	4462	4502	4257	6½ lb per cwt.	63s.
June . . . . .	4316	4434	4141	7 lb 6 oz. per cwt.	70s.
July . . . . .	3699	3785	3545	7 lb 2 oz. per cwt.	74s.
August . . . . .	2495	2539	2353	8 lb 3 oz. per cwt.	74s.
Sept. and Oct. . . . .	3171	3583	3317	8 lb 5 oz. per cwt.	74s.
April 1900 . . . . .	3651	3505	3292	6 per cent.	63s.
May . . . . .	6027	6048	5577	7½ per cent.	64s.
June . . . . .	5960	5889	5466	7½ per cent.	68s.
July and Aug. . . . .	7227	7177	6630	7½ per cent.	66s.
Sept. and Oct. . . . .	8943	9635	8666	10 per cent.	66s.

The following is a description of the making of Cheshire cheese:—

The evening's milk is set apart until the following morning, when the cream is skimmed off. The latter is poured into a pan which has been heated by being placed in the boiling water of a boiler. The new milk obtained early in the morning is poured into the vessel containing the previous evening's milk with the warmed cream, and the temperature of the mixture is brought to about 75° F. Into the vessel is introduced a piece of rennet, which has been kept in warm water since the preceding evening, and in which a little Spanish annatto (¼ oz. is enough for a cheese of 60 lb) is dissolved. (Marigolds, boiled in milk, are occasionally used for colouring cheese, to which they likewise impart a pleasant flavour. In winter, carrots scraped and boiled in milk, and afterwards strained, will produce a richer colour; but they should be used with moderation, on account of their taste.) The whole is now stirred together, and covered up warm for about an hour, or until it becomes curdled; it is then turned over with a bowl and broken very small. After standing a little time, the whey is drawn from it, and as soon as the curd becomes somewhat more solid it is cut into slices and turned over repeatedly, the better to press out the whey.

The curd is then removed from the tub, broken by hand or cut by a curd-breaker into small pieces, and put into a cheese vat, where it is strongly pressed both by hand and with weights, in order to extract the remaining whey. After this it is transferred to another vat, or into the same if it has in the meantime been well scalded, where a similar process of breaking and expressing is repeated, until all the whey is forced from it. The cheese is now turned into a third vat, previously warmed, with a cloth beneath it, and a thin loop of binder put round the upper edge of the cheese and within the sides of the vat, the cheese itself being previously enclosed in a clean cloth, and its edges placed within the vat, before transfer to the cheese-oven. These various processes occupy about six hours, and eight more are requisite for pressing the cheese, under a weight of 14 or 15 cwt. The cheese during that time should be twice turned in the vat. Holes are bored in the vat which contains the cheese, and also in the cover of it, to facilitate the extraction of every drop of whey. The pressure being continued, the cheese is at length taken from the vat as a firm and solid mass.

On the following morning and evening it must be again turned and pressed; and also on the third day, about the middle of which it should be removed to the salting-chamber, where the outside is well rubbed with salt, and a cloth binder passed round it which is not turned over the upper surface. The cheese is then placed in brine extending half-way up in a salting-tub, and the upper surface is thickly covered with salt. Here it remains for nearly a week, being turned twice in the day. It is then left to dry for two or three days, during which period it is turned once—being well salted at each turning—and cleaned every day. When taken from the brine it is put on the salting benches, with a wooden girth round it of nearly the thickness of the cheese, where it stands a few days, during which time it is again salted and turned every day. It is next washed and dried; and after remaining on the drying benches about seven days, it is once more washed in warm water with a brush, and wiped dry. In a couple of hours after this it is rubbed all over with sweet whey butter, which operation is afterwards frequently repeated; and, lastly, it is deposited in the cheese- or store-room—which should be moderately warm and sheltered from the access of air, lest the cheese should crack—and turned every day, until it has become sufficiently hard and firm. These cheeses require to be kept a considerable time.

As a matter of fact, there are three different modes of cheese-making followed in Cheshire, known as the *early* ripening, the *medium* ripening and the *late* ripening processes. There is also a method which produces a cheese that is permeated with "green mould" when ripe, called "Stilton Cheshire"; this, however, is confined to limited districts in the county. The early ripening method is generally followed in the spring of the year, until the middle or end of April; the medium process, from that time till late autumn, or until early in June, when the late ripening process is adopted and followed until the end of September, changing again to the medium process as the season advances. The late ripening process is not found to be suitable for spring or late autumn make. There is a decided difference between these several methods of making. In the early ripening system a larger quantity of rennet is used, more acidity is developed, and less pressure employed than in the other processes. In the medium ripening process a moderate amount of acidity is developed, to cause the natural drainage of the whey from the curd when under press. In the late ripening system, on the other hand, the development of acidity is prevented as far as possible, and the whey is got out of the curd by breaking down finer, using more heat, and skewering when under press. In the Stilton Cheshire process a larger quantity of rennet is used, and less pressure is employed, than in the medium or late ripening systems.

It is hardly possible to enunciate any general rules for the making of Stilton cheese, which differs from Cheddar and Cheshire in that it is not subjected to pressure. Mr J. Marshall Dugdale, in 1899, made a visit of inspection to the chief Leicestershire dairies where this cheese is produced, but in his report<sup>1</sup> he stated that every Stilton cheese-maker worked on his own lines, and that at no two dairies did he find the details all carried out in the same manner. There is a fair degree of uniformity up to the point when the curd is ladled into the straining-cloths, but at this stage, and in the treatment of the curd before salting, diversity sets in, several different methods being in successful use. Most of the cheese is made from two curds, the highly acid curd from the morning's milk being mixed with the comparatively sweet curd from the evening's milk. Opinion varies widely as to the degree of tightening of the straining-cloths. No test for acidity appears to be used, the amount of acidity being judged by the taste, feel and smell of the curd. When the desired degree of acidity has developed, the curd is broken by hand to pieces the size of small walnuts, and salt is added at the rate of about 1 oz. to 4 lb of dry curd, or 1 oz. to 3½ lb of wet curd, care being taken not to get the curd pasty. If a maker has learnt how to rennet the milk properly, and how to secure the right amount of acidity at the time of hooping—that is, when the broken and salted curd is put into the wooden hoops which give the cheese its shape—he has acquired probably two of the most important details necessary to success. It was formerly the custom to add cream to the milk used for making Stilton cheese, but the more general practice now is to employ new milk alone, which yields a product apparently as excellent and mellow as that from enriched milk.

As a cheese matures or becomes fit for consumption, not only is there produced the characteristic flavour peculiar to the type of cheese concerned, but with all varieties, independently of the quality of flavours developed, a profound physical transformation of the casein occurs. In the course of this change the firm elastic curd "breaks down"—that is, becomes plastic, whilst chemically the insoluble casein is converted into various soluble decomposition products. These ripening phenomena—the production of flavour and the breaking down of the casein (that is, the formation of proper texture)—used to be regarded as different phases of the same process. As subsequently shown, however, these changes are not necessarily so closely correlated. The theories formerly advanced as explanatory of the ripening changes in cheese were suggestive rather than based upon experimental data, and it is only since 1896 that careful scientific studies of the problem have been made. Of the two existing theories, the one, which is essentially European, ascribes the ripening changes wholly to the action of living organisms—the bacteria present in the cheese. The other, which had its origin

<sup>1</sup> "The Practice of Stilton Cheese-Making," *Journ. Roy. Agric. Soc.*, 1899.

in the United States, asserts that there are digestive enzymes—that is, unorganized or soluble ferments—inherent in the milk itself that render the casein soluble. The supporters of the bacterial theory are ranged in two classes. The one, led by Duclaux, regards the breaking down of the casein as due to the action of liquefying bacteria (*Tyrothrix* forms). On the other hand, von Freudenreich has ascribed these changes to the lactic-acid type of bacteria, which develop so luxuriantly in hard cheese like Cheddar.

With regard to the American theory, and in view of the important practical results obtained by Babcock and Russell at the Wisconsin experiment station, the following account<sup>1</sup> of their work is of interest, especially as the subject is of high practical importance. In 1897 they announced the discovery of an inherent enzyme in milk, which they named *galactase*, and which has the power of digesting the casein of milk, and producing chemical decomposition products similar to those that normally occur in ripened cheese. The theory has been advanced by them that this enzyme is an important factor in the ripening changes; and as in their experiments bacterial action was excluded by the use of anaesthetic agents, they conclude that, so far as the breaking down of the casein is concerned, bacteria are not essential to this process. In formulating a theory of cheese-ripening, they have further pointed out the necessity of considering the action of rennet extract as a factor concerned in the curing changes. They have shown that the addition of increased quantities of rennet extract materially hastens the rate of ripening, and that this is due to the pepsin which is present in all commercial rennet extracts. They find it easily possible to differentiate between the proteolytic action—that is, the decomposing of proteids—of pepsin and galactase, in that the first-named enzyme is incapable of producing decomposition products lower than the peptones precipitated by tannin. They have shown that the increased solubility—the ripening changes—of the casein in cheese made with rennet is attributable solely to the products peculiar to peptic digestion. The addition of rennet extract or pepsin to fresh milk does not produce this change, unless the acidity of the milk is allowed to develop to a point which experience has shown to be the best adapted to the making of Cheddar cheese. The *rationale* of the empirical process of ripening the milk before the addition of the rennet is thus explained. In studying the properties of galactase it was further found that this enzyme, as well as those present in rennet extract, is operative at very low temperatures, even below freezing-point. When cheese made in the normal manner was kept at temperatures ranging from 25° to 45° F. for periods averaging from eight to eighteen months, it was found that the texture of the product simulated that of a perfectly ripened cheese, but that such cheese developed a very mild flavour in comparison with the normally-cured product. Subsequent storage at somewhat higher temperatures gives to such cheese a flavour the intensity of which is determined by the duration of storage. This indicates that the breaking down of the casein and the production of the flavour peculiar to cheese are in a way independent of each other, and may be independently controlled—a point of great economic importance in commercial practice. Although it is generally believed that cheese ripened at low temperatures is apt to develop a more or less bitter flavour, the flavours in the cases described were found to be practically perfect. Under these conditions of curing, bacterial activity is inoperative, and these experiments are held to furnish an independent proof of the enzyme theory.

Not only are these investigations of interest from the scientific standpoint, as throwing light on the obscure processes of cheese-curing, but from a practical point of view they open up a new field for commercial exploitation. The inability to control the temperature in the ordinary factory curing-room results in serious losses, on account of the poor and uneven quality of the product, and the consumption of cheese has been greatly lessened thereby. These conditions may all be avoided by this low-temperature curing process, and it is not improbable that the cheese industry may undergo important changes in methods of treatment. With

<sup>1</sup> *Experiment Station Record*, xii. 9 (Washington, 1901).

the introduction of cold-storage curing, and the necessity of constructing centralized plant for this purpose, the cheese industry may perhaps come to be differentiated into the manufacture of the product in factories of relatively cheap construction, and the curing or ripening of the cheese in central curing stations. In this way not only would the losses which occur under present practices be obviated, but the improvement in the quality of the cured product would be more than sufficient to cover the cost of cold-storage curing.

The characteristics of typical specimens of the different kinds of English cheese may be briefly described. Cheddar cheese possesses the aroma and flavour of a nut—the so-called “nutty” flavour. It should melt in the mouth, and taste neither sweet nor acid. It is of flaky texture, neither hard nor crumbly, and is firm to the touch. It is early-ripening and, if not too much acid is developed in the making, long-keeping. Before all others it is a cosmopolitan cheese. Some cheeses are “plain,” that is, they possess the natural paleness of the curd, but many are coloured with annatto—a practice that might be dispensed with. The average weight of a Cheddar cheese is about 70 lb. Stilton cheese is popularly but erroneously supposed to be commonly made from morning’s whole milk with evening’s cream added, and to be a “double-cream” cheese. The texture is waxy, and a blue-green mould permeates the mass if well ripened; the flavour is suggestive of decay. The average weight of a Stilton is 15 lb. Cheshire cheese has a fairly firm and uniform texture, neither flaky on the one hand nor waxy on the other; is of somewhat sharp and piquant flavour when fully ripe; and is often—at eighteen months old, when a well-made Cheshire cheese is at its best—permeated with a blue-green mould, which, as in the case of Stilton cheese, contributes a characteristic flavour which is much appreciated. Cheshire cheese is, like Cheddar, sometimes highly-coloured, but the practice is quite unnecessary; the weight is about 55 lb. Gloucester cheese has a firm, somewhat soapy, texture and sweet flavour. Double Gloucester differs from single Gloucester only in size, the former usually weighing 26 to 30 lb, and the latter 13 to 15 lb. Leicester cheese is somewhat loose in texture, and mellow and moist when nicely ripened. Its flavour is “clean,” sweet and mild, and its aroma pleasant. To those who prefer a mild flavour in cheese, a perfect Leicester is perhaps the most attractive of all the so-called “hard” cheese; the average weight of such a cheese is about 35 lb. Derby cheese in its best forms is much like Leicester, being “clean” in flavour and mellow. It is sometimes rather flaky in texture, and is slow-ripening and long-keeping if made on the old lines; the average weight is 25 lb. Lancashire cheese, when well made and ripe, is loose in texture and is mellow; it has a piquant flavour. As a rule it ripens early and does not keep long. Dorset cheese—sometimes called “blue vinny” (or veiny)—is of firm texture, blue-moulded, and rather sharp-flavoured when fully ripe; it has local popularity and the best makes are rather like Stilton. Wensleydale cheese, a local product in North Yorkshire, is of fairly firm texture and mild flavour, and may almost be spread with a knife when ripe; the finest makes are equal to the best Stilton. Cotherstone cheese, also a Yorkshire product, is very much like Stilton and commonly preferable to it. The blue-green mould develops, and the cheese is fairly mellow and moist, whereas many Stiltons are hard and dry. Wiltshire cheese, in the form of “Wilts truckles,” may be described as small Cheddars, the weight being usually about 16 lb. Caerphilly cheese is a thin, flat product, having the appearance of an undersized single Gloucester and weighing about 8 lb; it has no very marked characteristics, but enters largely into local consumption amongst the mining population of Glamorganshire and Monmouthshire. Soft cheese of various kinds is made in many localities, beyond which its reputation scarcely extends. One of the oldest and best, somewhat resembling Camembert when well ripened, is the little “Slipcote,” made on a small scale in the county of Rutland; it is a soft, mellow, moist cheese, its coat slipping off readily when the cheese is at its best for eating—hence the name. Cream cheese is likewise made in many districts, but nowhere to a great extent. A

good cream cheese is fairly firm but mellow, with a slightly acid yet very attractive flavour. It is the simplest of all cheese to make—cream poured into a perforated box lined with loose muslin practically makes itself into cheese in a few days' time, and is usually ripe in a week.

In France the pressed varieties of cheese with hard rinds include Gruyère, Cantal, Roquefort and Port Salut. The first-named, a pale-yellow cheese full of holes of varying size, is made in Switzerland and in the Jura Mountains district in the east of France; whilst Cantal cheese, which is of lower quality, is a product of the midland districts and is made barrel-shape. Roquefort cheese is made from the milk of ewes, which are kept chiefly as dairy animals in the department of Aveyron, and the cheese is cured in the natural mountain caves at the village of Roquefort. It is a small, rather soft, white cheese, abundantly veined with a greenish-blue mould and weighs between 4 and 5 lb. The Port Salut is quite a modern cheese, which originated in the abbey of that name in Mayenne; it is a thin, flat cheese of characteristic, and not unattractive odour and flavour. The best known of the soft unpressed cheeses are Brie, Camembert and Coulommiers, whilst Pont l'Évêque, Livarot and other varieties are also made. After being shaped in moulds of various forms, these cheeses are laid on straw mats to cure, and when fit to eat they possess about the same consistency as butter. The Neufchâtel, Gervais and Bondon cheeses are soft varieties intended to be eaten quite fresh, like cream cheese.

Of the varieties of cheese made in Switzerland, the best known is the Emmentaler, which is about the size of a cart-wheel, and has a weight varying from 150 to 300 lb. It is full of small holes of almost uniform size and very regularly distributed. In colour and flavour it is the same as Gruyère. The Edam and Gouda are the common cheeses of Holland. The Edam is spherical in shape, weighs from 3 to 4 lb, and is usually dyed crimson on the outside. The Gouda is a flat cheese with convex edges and is of any weight up to 20 lb. Of the two, the Edam has the finer flavour. Limburger is the leading German cheese, whilst other varieties are the Backstein and Munster; all are strong-smelling. Parmesan cheese is an Italian product, round and flat, about 5 in. thick, weighing from 60 to 80 lb and possessed of fine flavour. Gorgonzola cheese, so called from the Italian town of that name near Milan, is made in the Cheddar shape and weighs from 20 to 40 lb. When ripe it is permeated by a blue mould, and resembles in flavour, appearance and consistency a rich old Stilton.

For descriptions of all the named varieties of cheese, see *Bulletin 105 of the Bureau of Animal Industry* (U.S. Department of Agriculture, Washington), issued 27th of June 1908, compiled by C. F. Doane and H. W. Lawson.

#### BUTTER AND BUTTER-MAKING

As with cheese, so with butter, large quantities of the latter have been inferior not because the cream was poor in quality, but because the wrong kinds of bacteria had taken possession of the atmosphere in hundreds of dairies. The greatest if not the latest novelty in dairying in the last decade of the 19th century was the isolation of lactic acid bacilli, their cultivation in a suitable medium, and their employment in cream preparatory to churning. Used thus in butter-making, an excellent product results, provided cleanliness be scrupulously maintained. The culture repeats itself in the buttermilk, which in turn may be used again with marked success. Much fine butter, indeed, was made long before the bearing of bacteriological science upon the practice of dairying was recognized—made by using acid buttermilk from a previous churning.

In Denmark, which is, for its size, the greatest butter-producing country in the world, most of the butter is made with the aid of "starters," or artificial cultures which are employed in ripening the cream. Though the butter made by such cultures shows little if any superiority over a good sample made from cream ripened in the ordinary way—that is, by keeping the cream at a fairly high temperature until it is ready for churning, when it must be cooled—it is claimed that the use of these cultures enables the butter-makers of Denmark to secure a much

greater uniformity in the quality of their produce than would be possible if they depended upon the ripening of the cream through the influence of bacteria taken up in the usual way from the air.

Butter-making is an altogether simpler process than cheese-making, but success demands strict attention to sound principles, the observance of thorough cleanliness in every stage of the work, and the intelligent use of the thermometer. The following rules for butter-making, issued by the Royal Agricultural Society sufficiently indicate the nature of the operation:—

Prepare churn, butter-worker, wooden-hands and sieve as follows:—(1) Rinse with cold water. (2) Scald with boiling water. (3) Rub thoroughly with salt. (4) Rinse with cold water.

*Always use a correct thermometer.*

The cream, when in the churn, to be at a temperature of 56° to 58° F. in summer and 60° to 62° F. in winter. The churn should never be more than half full. Churn at number of revolutions suggested by maker of churn. If none are given, *churn at 40 to 45 revolutions per minute*. Always churn slowly at first.

*Ventilate* the churn *freely* and frequently during churning, until no air rushes out when the vent is opened.

*Stop churning immediately* the butter comes. This can be ascertained by the sound; if in doubt, *look*.

The butter should now be like grains of mustard seed. Pour in a small quantity of cold water (1 pint of water to 2 quarts of cream) to harden the grains, and give a few more turns to the churn gently.

Draw off the buttermilk, giving plenty of time for draining. Use a straining-cloth placed over the hair-sieve, so as to prevent any loss, and wash the butter in the churn with plenty of cold water: then draw off the water, and repeat the process until the water comes off quite clear.

*To brine butter*, make a strong brine, 2 to 3 lb of salt to 1 gallon of water. Place straining-cloth over mouth of churn, pour in brine, put lid on churn, turn sharply half a dozen times, and leave for 10 to 15 minutes. Then lift the butter out of the churn into sieve, turn butter out on worker, leave it a few minutes to drain, and work gently till all superfluous moisture is pressed out.

*To drysalt butter*, place butter on worker, let it drain 10 to 15 minutes, then work gently till all the butter comes together. Place it on the scales and weigh; then weight salt, for slight salting,  $\frac{1}{4}$  oz.; medium,  $\frac{1}{2}$  oz.; heavy salting,  $\frac{3}{4}$  oz. to the lb of butter. Roll butter out on worker and carefully sprinkle salt over the surface, a little at a time; roll up and repeat till all the salt is used.

*Never touch the butter with your hands.*

Well-made butter is firm and not greasy. It possesses a characteristic texture or "grain," in virtue of which it cuts clean with a knife and breaks with a granular fracture, like that of cast-iron. Theoretically, butter should consist of little else than fat, but in practice this degree of perfection is never attained. Usually the fat ranges from 83 to 88%, whilst water is present to the extent of from 10 to 15%.<sup>1</sup> There will also be from 0.2 to 0.8% of milk-sugar, and from 0.5 to 0.8% of casein. It is the casein which is the objectionable ingredient, and the presence of which is usually the cause of rancidity. In badly-washed or badly-worked butter, from which the buttermilk has not been properly removed, the proportion of casein or curd left in the product may be considerable, and such butter has only inferior keeping qualities. At the same time, the mistake may be made of overworking or of overwashing the butter, thereby depriving it of the delicacy of flavour which is one of its chief attractions as an article of consumption if eaten fresh. The object of washing with brine is that the small quantity of salt thus introduced shall act as a preservative and develop the flavour. Streaky butter may be due either to curd left in by imperfect washing, or to an uneven distribution of the salt.

#### EQUIPMENT OF THE DAIRY

The improved form of milking-pail shown in fig. 1 has rests or brackets, which the milker when seated on his stool places on his knees; he thus bears the weight on his thighs, and is entirely relieved of the strain involved in gripping the can between the knees. The milk sieve or strainer (fig. 2) is used to remove cow-hairs and any other mechanical impurity that may have fallen into the milk. A double straining surface is provided, the second being of very fine gauze placed vertically, so that the pressure of the milk does not force the dirt through; the strainer is easily washed. The cheese tub or vat receives

<sup>1</sup> Market butter is sometimes deliberately over-weighted with water, and a fraudulent profit is obtained by selling this extra moisture at the price of butter.



the milk for cheese-making. The rectangular form shown in fig. 3 is a Cheshire cheese-vat, for steam. The inner vat is of tinned steel, and the outer is of iron and is fitted with pipes

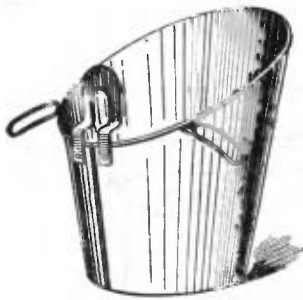

FIG. 1.—Milking-Pail.



FIG. 2.—Milk Sieve.

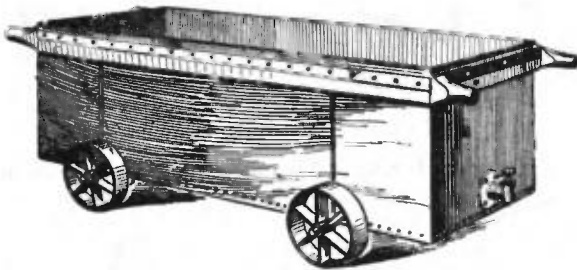

FIG. 3.—Rectangular Cheese-Vat.

for steam supply. Round cheese-tubs (fig. 4) are made of strong sheets of steel, double tinned to render them lasting. They are fitted with a strong bottom hoop and bands round the sides,

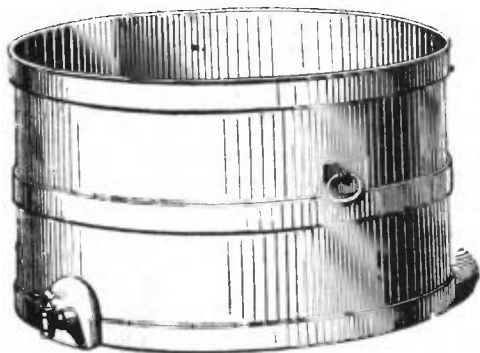

FIG. 4.—Cheese-Tub.

and can be double-jacketed for steam-heating if required. Curd-knives (fig. 5) are used for cutting the coagulated mass into

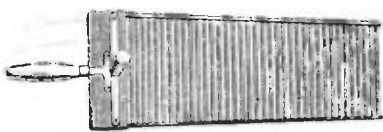

FIG. 5.—Curd-Knives.

cubes in order to liberate the whey. They are made of fine steel, with sharp edges; there are also wire curd-breakers. The object of the curd-mill (fig. 6) is to grind consolidated curd into small pieces, preparatory to salting and vating; two spiked rollers work up to spiked breasts. Hoops, into which the curd is placed in order to acquire the shape of the cheese, are of wood or steel, the former being made of well-seasoned oak with iron bands (fig. 7), the latter of tinned steel. The cheese is more easily removed from the steel hoops and they are readily cleaned. The cheese-press (fig. 8) is used only for hard or "pressed" cheese, such as Cheddar. The arrangement is such

that the pressure is continuous; in the case of soft cheese the curd is merely placed in moulds (figs. 9 and 10) of the required shape, and then taken out to ripen, no pressure being applied.

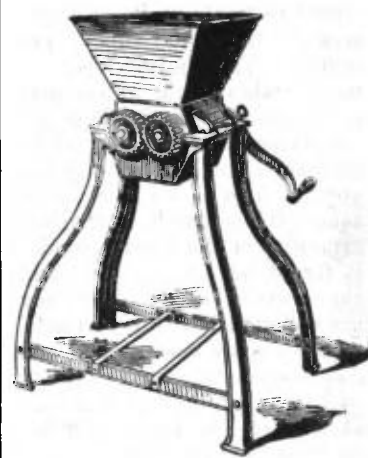

FIG. 6.—Curd-Mill.

The cheese-room is fitted with easily-turned shelves, on which newly-made "pressed" cheeses are laid to ripen.

In the butter dairy, when the centrifugal separator is not used, milk is "set" for cream-raising in the milk-pan (fig. 11), a shallow vessel of white porcelain,



FIG. 7.—Hoop for Flat Cheese.

tinned steel or enamelled iron. The skimming-dish or skimmer (fig. 12), made of tin, is for collecting the cream from the surface of

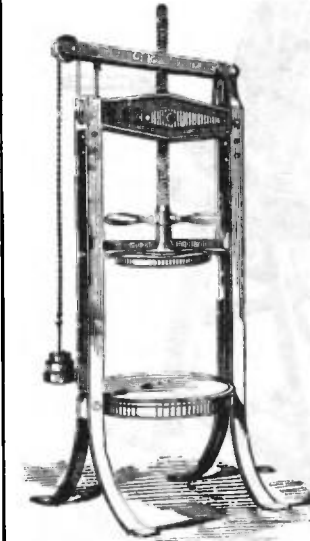

FIG. 8.—Cheese-Press.



FIG. 9.—Cheese-Mould (Gervais).



FIG. 10.—Cheese-Mould (Pont l'Évêque).

the milk, whence it is transferred to the cream-crock (fig. 13), in which vessel the cream remains from one to three days, till it is required for churning.

Many different kinds of churns are in use, and vary much in size, shape and fittings; the one illustrated in fig. 14 is a very good type of diaphragm churn. The butter-scoop (fig. 15) is of wood and is sometimes perforated; it is used for taking the butter out of the churn. The butter-worker (fig. 16) is employed for consolidating newly-churned butter, pressing out superfluous water and mixing in salt. More extended use, however, is now being made of the "Délaiteuse" butter dryer, a centrifugal machine that rapidly extracts the moisture from the butter, and renders the



FIG. 11.—Milk-Pan.

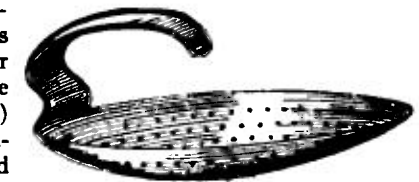

FIG. 12.—Skimmer.

butter-worker unnecessary, whilst the butter produced has a better grain. Scotch hands (fig. 17), made of boxwood, are used for the lifting, moulding and pressing of butter.

In the centrifugal cream-separator the new milk is allowed to flow into a bowl, which is caused to rotate on its own axis several thousand times per minute. The heavier portion which makes up the watery part of the milk flies to the outer circumference of the bowl, whilst the lighter particles of butter-fat are forced to travel in an inner zone. By a simple mechanical arrangement the separated milk is forced out at one tube and the cream at another, and they are collected in distinct vessels. Separators are made of all sizes, from small machines dealing with 10 or 20 up to 100 gallons

an hour, and worked by hand (fig. 18), to large machines separating 150 to 440 gallons an hour, and worked by horse, steam or other power (fig. 19). Separation is found to be most effective at temperatures ranging in different machines



FIG. 13.—Cream-Crock.



FIG. 14.—Churn.

from 80° to 98° F., though as high a temperature as 150° is sometimes employed. The most efficient separators remove nearly the whole of the butter-fat, the quantity of fat left in the separated milk falling in some cases to as low as 0.1. When cream is raised by the deep-setting method, from 0.2 to 0.4% of fat is left in the skim-milk; by the shallow-setting method from 0.3 to 0.5% of the fat is left behind. As a rule, therefore, "separated" milk is much poorer in fat than ordinary "skim" milk left by the cream-raising method in deep or shallow vessels.



FIG. 15.—Butter-Scoop.

The first continuous working separator was the invention of Dr de Laval. The more recent invention by Baron von Bechtolsheim of what are known as the Alfa discs, which are placed along the centre of the bowl of the separator, has much increased the separating capacity of the machines without adding to the power required. This has been of great assistance to dairy farmers by lessening the cost of the manufacture of butter, and

thus enabling a large additional number of factories to be established in different parts of the world, particularly in Ireland, where these disc machines are very extensively used.

The pasteurizer—so named after the French chemist Pasteur

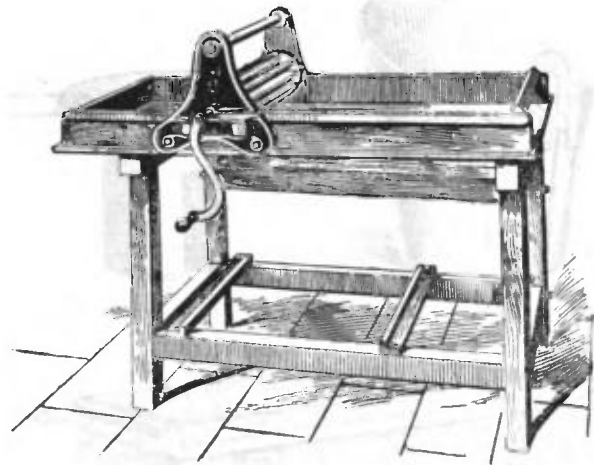

FIG. 16.—Butter-Worker.

—affords a means whereby at the outset the milk is maintained at a temperature of 170° to 180° F. for a period of eight or ten minutes. The object of this is to destroy the tubercle bacillus, if it should happen to exist in the milk, whilst incidentally the bacilli associated with several other diseases communicable through the medium of milk would also be killed if they were present. Discordant results have been recorded by experimenters who have attempted to kill tubercle bacilli in milk by heating the latter in open vessels, thereby permitting the formation of a scum or "scalded layer" capable of protecting the tubercle bacilli, and enabling them to resist a higher temperature than otherwise would be fatal to them. At a temperature not much above 150° F. milk begins to acquire the cooked flavour which is objectionable to many palates, whilst its "body" is so modified as to lessen its suitability for creaming purposes. Three factors really enter into effective pasteurization of milk, namely (1) the temperature to which the milk is raised, (2) the length of time it is kept at that temperature, (3) the maintenance of a condition of mechanical agitation to prevent the formation of "scalded layer." Within limits, what a higher temperature will accomplish if maintained for a very short time may be effected by a lower temperature continued over a longer period. The investigation of the problem forms the subject of a paper<sup>1</sup> in the 17th *Annual Report of the Wisconsin Agricultural Experiment Station, 1900*. The following are the results of the experiments:—

1. An exposure of tuberculous milk in a tightly closed commercial pasteurizer for a period of ten minutes destroyed in every case the tubercle bacillus, as determined by the inoculation of such heated milk into susceptible animals like guinea-pigs.

<sup>1</sup> "Thermal Death-Point of Tubercle Bacilli, and Relation of same to Commercial Pasteurization of Milk," by H. L. Russell and E. G. Hastings.

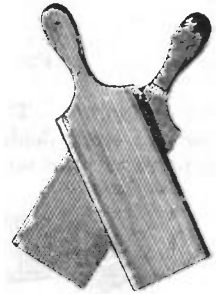

FIG. 17.—Scotch Hands.

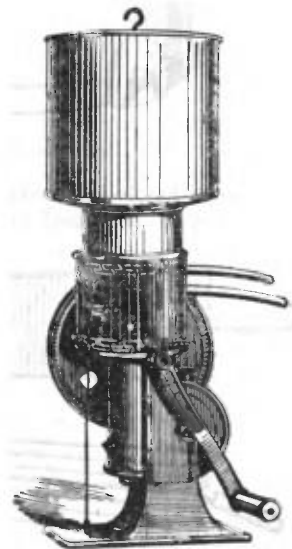

FIG. 18.—Hand-Separator.

2. Where milk is exposed under conditions that would enable a pellicle or membrane to form on the surface, the tubercle organism is able to resist the action of heat at 140° F. (60° C.) for considerably longer periods of time.

3. Efficient pasteurization can be more readily accomplished in a



FIG. 19.—Power Separator.

closed receptacle such as is most frequently used in the commercial treatment of milk, than where the milk is heated in open bottles or open vats.

4. It is recommended, in order thoroughly to pasteurize milk so as to destroy any tubercle bacilli which it may contain, without in any

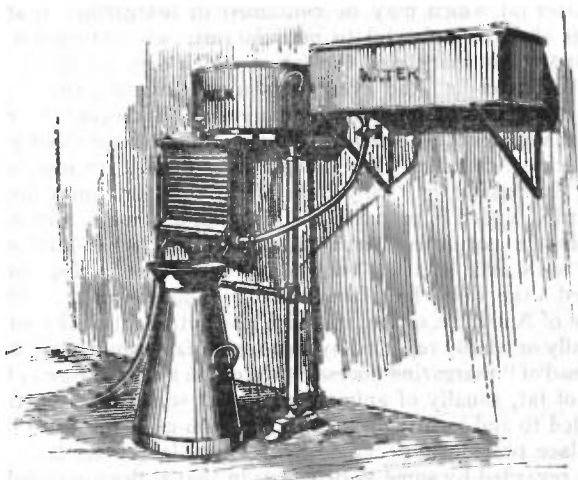

FIG. 20.—Refrigerator and Can.

way injuring its creaming properties or consistency, to heat the same in closed pasteurizers for a period of not less than twenty minutes at 140° F.

Under these conditions one may be certain that disease bacteria

such as the tubercle bacillus will be destroyed without the milk or cream being injured in any way. For over a year this new standard has been in constant use in the Wisconsin University Creamery, and the results, from a purely practical point of view, reported a year earlier by Farrington and Russell,<sup>1</sup> have been abundantly confirmed.

Dairy engineers have solved the problem as to how large bodies of milk may be pasteurized, the difficulty of raising many hundreds or thousands of gallons of milk up to the required temperature, and maintaining it at that heat for a period of twenty minutes, having been successfully dealt with. The plant usually employed provides for the thorough filtration of the milk as it comes in from the farms, its rapid heating in a closed receiver and under mechanical agitation up to the desired temperature, its maintenance thereat for the requisite time, and finally its sudden reduction to the temperature of cold water through the agency of a refrigerator, to be next noticed.

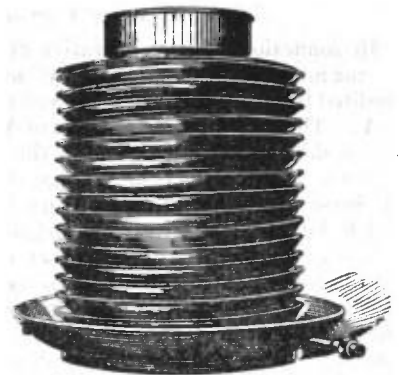

FIG. 21.—Cylindrical Cooler or Refrigerator.

Refrigerators are used for reducing the temperature of milk to that of cold water, whereby its keeping properties are enhanced. The milk flows down the outside of the metal refrigerator (fig. 20), which is corrugated in order to provide a larger cooling surface, whilst cold water circulates through the interior of the refrigerator. The conical vessel into which the milk is represented as flowing from the refrigerator in fig. 20 is absurdly called a "milk-churn," whereas milk-can is a much more appropriate name. For very large quantities of milk, such as flow from a pasteurizing plant, cylindrical refrigerators (fig. 21), made of tinned copper, are available; the cold water circulates inside, and the milk, flowing down the outside in a very thin sheet, is rapidly cooled from a temperature of 140° F. or higher to 1° above the temperature of the water.

The fat test for milk was originally devised by Dr S. M. Babcock, of the Wisconsin, U.S.A., experiment station. It combines the principle of centrifugal force with simple chemical action. Besides the machine itself and its graduated glass vessels, the only requirements are sulphuric acid of standard strength and warm water. The machines—often termed butyrometers—are commonly made to hold from two up to two dozen testers. After the tubes or testers have been charged, they are put in the apparatus, which is rapidly rotated as shown (fig. 22); in a few minutes the test is complete, and with properly graduated vessels the percentage of fat can be read off at a glance. The butyrometer is extremely useful, alike for measuring periodically the fat-producing capacity of individual cows in a herd, for rapidly ascertaining the percentage of fat in milk delivered to factories and paying for such milk on the basis of quality, and for determining the richness in fat of milk supplied for the urban milk trade. Any intelligent person can soon learn to

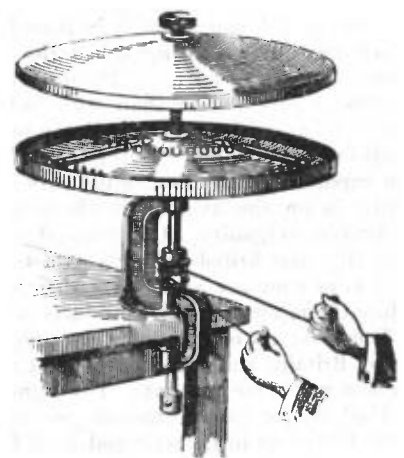

FIG. 22.—Butyrometer.

<sup>1</sup> 16th Rept. Wis. Agric. Expt. Station, 1899, p. 129.

work the apparatus, but its efficiency is of course dependent upon the accuracy of the measuring vessels. To ensure this the board of agriculture have made arrangements with the National Physical Laboratory, Old Deer Park, Richmond, Surrey, to verify at a small fee the pipettes, measuring-glasses, and test-bottles used in connexion with the centrifugal butyrometer, which in recent years has been improved by Dr N. Gerber of Zürich.

#### DAIRY FACTORIES

In connexion with co-operative cheese-making the merit of having founded the first "cheesery" or cheese factory is generally credited to Jesse Williams, who lived near Rome, Oneida county, N.Y. The system, therefore, was of American origin. Williams was a skilled cheese-maker, and the produce of his dairy sold so freely, at prices over the average, that he increased his output of cheese by adding to his own supply of milk other quantities which he obtained from his neighbours. His example was so widely followed that by the year 1866 there had been established close upon 500 cheese factories in New York state alone. In 1870 two co-operative cheeseries were at work in England, one in the town of Derby and one at Longford in the same county. There are now thousands of cheeseries in the United States and Canada, and also many "creameries," or butter factories, for the making of high-class butter.

The first creamery was that of Alanson Slaughter, and it was built near Wallkill, Orange county, N.Y., in 1861, or ten years later than the first cheese factory; it dealt daily with the milk of 375 cows. Cheeseries and creameries would almost certainly have become more numerous than they are in England but for the rapidly expanding urban trade in country milk. The development of each, indeed, has been contemporaneous since 1871, and they are found to work well in conjunction one with the other—that is to say, a factory is useful for converting surplus milk into cheese or butter when the milk trade is overstocked, whilst the trade affords a convenient avenue for the sale of milk whenever this may happen to be preferable to the making of cheese or butter. Extensive dealers in milk arrange for its conversion into cheese or butter, as the case may be, at such times as the milk market needs relief, and in this way a cheesery serves as a sort of economic safety-valve to the milk trade. The same cannot always be said of creameries, because the machine-skimmed milk of some of these establishments has been far too much used to the prejudice of the legitimate milk trade in urban districts. Be this as it may, the operations of cheeseries and creameries in conjunction with the milk trade have led to the diminution of home dairying. A rapidly increasing population has maintained, and probably increased, its consumption of milk, which has obviously diminished the farmhouse production of cheese, and also of butter. The foreign competitor has been less successful with cheese than with butter, for he is unable to produce an article qualified to compete with the best that is made in Great Britain. In the case of butter, on the other hand, the imported article, though not ever surpassing the best home-made, is on the average much better, especially as regards uniformity of quality. Colonial and foreign producers, however, send into the British markets as a rule only the best of their butter, as they are aware that their inferior grades would but injure the reputation their products have acquired.

There are no official statistics concerning dairy factories in Great Britain, and such figures relating to Ireland were issued for the first time in 1901. The number of dairy factories in Ireland in 1900 was returned at 506, comprising 333 in Munster, 92 in Ulster, 52 in Leinster and 29 in Connaught. Of the total number of factories, 495 received milk only, 9 milk and cream and 2 cream only. As to ownership, 219 were joint-stock concerns, 190 were maintained by co-operative farmers and 97 were proprietary. In the year ended 30th September 1900 these factories used up nearly 121 million gallons of milk, namely, 94 in Munster, 14 in Ulster, 7 in Leinster and 6 in Connaught. The number of centrifugal cream-separators in the factories was 985, of which 889 were worked by steam, 79 by water, 9 by horse-power and 8 by hand-power. The number of hands

permanently employed was 3653, made up of 976 in Munster, 279 in Leinster, 278 in Ulster and 120 in Connaught. The year's output was returned at 401,490 cwt. of butter, 439 cwt. of cheese (made from whole milk) and 46,253 gallons of cream. In most cases the skim-milk is returned to the farmers. A return of the number of separators used in private establishments gave a total of 899, comprising 693 in Munster, 157 in Leinster, 39 in Ulster and 10 in Connaught. In factories and private establishments together as many as 1884 separators were thus accounted for. Much of the factory butter would be sent into the markets of Great Britain, though some would no doubt be retained for local consumption. A great improvement in the quality of Irish butter has recently been noticeable in the exhibits entered at the London dairy show.

#### ADULTERATION OF DAIRY PRODUCE<sup>1</sup>

The Sale of Food and Drugs Act 1899, which came into operation on the 1st of January 1900, contains several sections relating to the trade in dairy produce in the United Kingdom. Section 1 imposes penalties in the case of the importation of produce insufficiently marked, such as (a) margarine or margarine-cheese, except in passages conspicuously marked "Margarine" or "Margarine-cheese"; (b) adulterated or impoverished butter (other than margarine) or adulterated or impoverished milk or cream, except in packages or cans conspicuously marked with a name or description indicating that the butter or milk or cream has been so treated; (c) condensed separated or skimmed milk, except in tins or other receptacles which bear a label whereon the words "machine-skimmed milk" or "skimmed milk" are printed in large and legible type. For the purposes of this section an article of food is deemed to be adulterated or impoverished if it has been mixed with any other substance, or if any part of it has been abstracted, so as in either case to affect injuriously its quality, substance, or nature; provided that an article of food shall not be deemed to be adulterated by reason only of the addition of any preservative or colouring matter of such a nature and in such quantity as not to render the article injurious to health. Section 7 provides that every occupier of a manufactory of margarine or margarine-cheese, and every wholesale dealer in such substances, shall keep a register showing the quantity and destination of each consignment of such substances sent out from his manufactory or place of business, and this register shall be open to the inspection of any officer of the board of agriculture. Any such officer shall have power to enter at all reasonable times any such manufactory, and to inspect any process of manufacture therein, and to take samples for analysis. Section 8 is of much practical importance, as it limits the quantity of butter-fat which may be contained in margarine; it states that it shall be unlawful to manufacture, sell, expose for sale or import any margarine the fat of which contains more than 10% of butter-fat, and every person who manufactures, sells, exposes for sale or imports any margarine which contains more than that percentage shall be guilty of an offence under the Margarine Act 1887. For the purposes of the act *margarine-cheese* is defined as "any substance, whether compound or otherwise, which is prepared in imitation of cheese, and which contains fat not derived from milk"; whilst *cheese* is defined as "the substance usually known as cheese, containing no fat derived otherwise than from milk." The so-called "filled" cheese of American origin, in which the butter-fat of the milk is partially or wholly replaced by some other fat, would come under the head of "margarine-cheese." In making such cheese a cheap form of fat, usually of animal origin, but sometimes vegetable, is added to and incorporated with the skim-milk, and thus takes the place previously occupied by the genuine butter-fat. The act is regarded by some as defective in that it does not prohibit the artificial colouring of margarine to imitate butter.

In connexion with this act a departmental committee was appointed in 1900 "to inquire and report as to what regulations, if any, may with advantage be made by the board of agriculture under section 4 of the Sale of Food and Drugs Act 1899, for

<sup>1</sup> See also the article ADULTERATION.

determining what deficiency in any of the normal constituents of genuine milk or cream, or what addition of extraneous matter or proportion of water, in any sample of milk (including condensed milk) or cream, shall for the purposes of the Sale of Food and Drugs Acts 1875 to 1899, raise a presumption, until the contrary is proved, that the milk or cream is not genuine." Much evidence of the highest interest to dairy-farmers was taken, and subsequently published as a Blue-Book (Cd. 484). The report of the committee (Cd. 491) included the following "recommendations," which were signed by all the members excepting one:—

- I. That regulations under section 4 of the Food and Drugs Act 1899 be made by the board of agriculture with respect to milk (including condensed milk) and cream.
- II. (a) That in the case of any milk (other than skimmed, separated or condensed milk) the total milk-solids in which on being dried at 100° C. do not amount to 12% a presumption shall be raised, until the contrary is proved, that the milk is deficient in the normal constituents of genuine milk.
  - (b) That any milk (other than skimmed, separated or condensed milk) the total milk-solids in which are less than 12%, and in which the amount of milk-fat is less than 3.25%, shall be deemed to be deficient in milk-fat as to raise a presumption, until the contrary is proved, that it has been mixed with separated milk or water, or that some portion of its normal content of milk-fat has been removed. In calculating the percentage amount of deficiency of fat the analyst shall have regard to the above-named limit of 3.25% of milk-fat.
  - (c) That any milk (other than skimmed, separated or condensed milk) the total milk-solids in which are less than 12%, and in which the amount of non-fatty milk-solids is less than 8.5%, shall be deemed to be so deficient in normal constituents as to raise a presumption, until the contrary is proved, that it has been mixed with water. In calculating the percentage amount of admixed water the analyst shall have regard to the above-named limit of 8.5% of non-fatty milk-solids, and shall further take into account the extent to which the milk-fat may exceed 3.25%.
- III. That the artificial thickening of cream by any addition of gelatin or other substance shall raise a presumption that the cream is not genuine.
- IV. That any skimmed or separated milk in which the total milk-solids are less than 9% shall be deemed to be so deficient in normal constituents as to raise a presumption, until the contrary is proved, that it has been mixed with water.
- V. That any condensed milk (other than that labelled "machine-skimmed milk" or "skimmed milk," in conformity with section 11 of the Food and Drugs Act 1899) in which either the amount of milk-fat is less than 10%, or the amount of non-fatty milk-solids is less than 25%, shall be deemed to be so deficient in some of the normal constituents of milk as to raise a presumption, until the contrary is proved, that it is not genuine.

The committee further submitted the following expressions of opinion on points raised before them in evidence:—

- (a) That it is desirable to call the attention of those engaged in the administration of the Food and Drugs Acts to the necessity of adopting effective measures to prevent any addition of water, separated or condensed milk, or other extraneous matter, for the purpose of reducing the quality of genuine milk to any limits fixed by regulation of the board of agriculture.
- (b) That it is desirable that steps should be taken with the view of identifying or "ear-marking" separated milk by the addition of some suitable and innocuous substance, and by the adoption of procedure similar to that provided by section 7 of the Food and Drugs Act 1899, in regard to margarine.
- (c) That it is desirable that, so far as may be found practicable, the procedure adopted in collecting, forwarding, and retaining pending examination, samples of milk (including condensed milk) and cream under the Food and Drugs Acts should be uniform.
- (d) That it is desirable that, so far as may be found practicable, the methods of analysis used in the examination of samples of milk (including condensed milk) or cream taken under the Food and Drugs Acts should be uniform.
- (e) That it is desirable in the case of condensed milk (other than that labelled "machine-skimmed milk" or "skimmed milk," in conformity with section 11 of the Food and Drugs Act 1899) that the label should state the amount of dilution required to make the proportion of milk-fat equal to that found in uncondensed milk containing not less than 3.25% of milk-fat.

- (f) That it is desirable in the case of condensed whole milk to limit, and in the case of condensed machine-skimmed milk to exclude, the addition of sugar.
- (g) That the official standardizing of the measuring vessels commercially used in the testing of milk is desirable.

In the minority report, signed by Mr Geo. Barham, the most important clauses are the following:—

(a) That in the case of any milk (other than skimmed, separated or condensed milk) the total milk-solids in which are less than 11.75%, and in which, during the months of July to February inclusive, the amount of milk-fat is less than 3%, and in the case of any milk which during the months of March to June inclusive shall fall below the above-named limit for total solids, and at the same time shall contain less than 2.75% of fat, it shall be deemed that such milk is so deficient in its normal constituent of fat as to raise a presumption, for the purposes of the Sale of Food and Drugs Acts 1875 to 1899, until the contrary is proved, that the milk is not genuine.

(b) That any milk (other than skimmed, separated or condensed milk) the total milk-solids in which are less than 11.75%, and in which the amount of non-fatty solids is less than 8.5%, shall be deemed to be so deficient in its normal constituents as to raise a presumption, for the purposes of the Sale of Food and Drugs Acts 1875 to 1899, until the contrary is proved, that the milk is not genuine. In calculating the amount of the deficiency the analyst shall take into account the extent to which the milk-fat exceeds the limits above named.

(c) That any skimmed or separated milk in which the total milk-solids are less than 8.75% shall be deemed to be so deficient in its normal constituents as to raise a presumption, for the purpose of the Sale of Food and Drugs Acts 1875 to 1899, until the contrary is proved, that the milk is not genuine.

Much controversy arose out of the publication of these reports, the opinion most freely expressed being that the standard recommended in the majority report was too high. The difficulty of the problem is illustrated by, for example, the diverse legal standards for milk that prevail in the United States, where the prescribed percentage of fat in fresh cows' milk ranges from 2.5 in Rhode Island to 3.5 in Georgia and Minnesota, and 3.7 (in the winter months) in Massachusetts, and the prescribed total solids range from 12 in several states (11.5 in Ohio during May and June) up to 13 in others. Standards are recognized in twenty-one of the states, but the remaining states have no laws prescribing standards for dairy products. That the public discussion of the reports of the committee was effective is shown by the following regulations which appeared in the *London Gazette* on the 6th of August 1901, and fixed the limit of fat at 3%:—

The board of agriculture, in exercise of the powers conferred on them by section 4 of the Sale of Food and Drugs Act 1899, do hereby make the following regulations:—

1. Where a sample of milk (not being milk sold as skimmed, or separated or condensed milk) contains less than 3% of milk-fat, it shall be presumed for the purposes of the Sale of Food and Drugs Acts 1875 to 1899, until the contrary is proved, that the milk is not genuine, by reason of the abstraction therefrom of milk-fat, or the addition thereto of water.

2. Where a sample of milk (not being milk sold as skimmed, or separated or condensed milk) contains less than 8.5% of milk-solids other than milk-fat, it shall be presumed for the purposes of the Sale of Food and Drugs Acts 1875 to 1899, until the contrary is proved, that the milk is not genuine, by reason of the abstraction therefrom of milk-solids other than milk-fat, or the addition thereto of water.

3. Where a sample of skimmed or separated milk (not being condensed milk) contains less than 9% of milk-solids, it shall be presumed for the purposes of the Sale of Food and Drugs Acts 1875 to 1899, until the contrary is proved, that the milk is not genuine, by reason of the abstraction therefrom of milk-solids other than milk-fat, or the addition thereto of water.

4. These regulations shall extend to Great Britain.

5. These regulations shall come into operation on the 1st of September 1901.

6. These regulations may be cited as the Sale of Milk Regulations 1901.

In July 1901 another departmental committee was appointed by the board of agriculture to inquire and report as to what regulations, if any, might with advantage be made under section 4 of the Sale of Food and Drugs Act 1899, for determining what deficiency in any of the normal constituents of butter, or what addition of extraneous matter, or proportion of water in any sample of butter should, for the purpose of the Sale of Food and Drugs Acts, raise a presumption, until the contrary is proved.



that the butter is not genuine. As bearing upon this point reference may be made to a report of the dairy division of the United States department of agriculture on experimental exports of butter, in the appendix to which are recorded the results of the analyses of many samples of butter of varied origin. First, as to American butters, 19 samples were analysed in Wisconsin, 17 in Iowa, 5 in Minnesota and 2 in Vermont, at the respective experiment stations of the states named. The amount of moisture throughout was low, and the quantity of fat correspondingly high. In no case was there more than 15% of water, and only 4 samples contained more than 14%. On the other hand, 11 samples had less than 10%, the lowest being a pasteurized butter from Ames, Iowa, with only 6.72% of water. The average amount of water in the total 43 samples was 11.24%. The fat varies almost inversely as the water, small quantities of curd and ash having to be allowed for. The largest quantity of fat was 91.23% in the sample containing only 6.72% of water. The lowest proportion of fat was 80.18%, whilst the average of all the samples shows 85.9%, which is regarded as a good market standard. The curd varied from 0.55 to 1.7%, with an average of 0.98. This small amount indicates superior keeping qualities. Theoretically there should be no curd present, but this degree of perfection is never attained in practice. It was desired to have the butter contain about 2½% of salt, but the quantity of ash in the 43 samples ranged from 0.83 to 4.79%, the average being 1.88. Analyses made at Washington of butters other than American showed a general average of 13.22% of water over 28 samples representing 14 countries. The lowest were 10.25% in a Canadian butter and 10.38 in an Australian sample. The highest was 19.1% in an Irish butter, which also contained the remarkably large quantity of 8.28% of salt. Three samples of Danish butter contained 12.65, 14.27 and 15.14% respectively of water. French and Italian unsalted butter included, the former 15.46 and the latter 14.41% of water, and yet appeared to be unusually dry. In 7 samples of Irish butters the percentages of water ranged from 11.48 to 19.1. Of the 28 foreign butters 15 were found to contain preservatives. All 5 samples from Australia, the 2 from France, the single ones from Italy, New Zealand, Argentina, and England, and 4 out of the 7 from Ireland, contained boric acid.

#### THE MILK TRADE

The term "milk trade" has come to signify the great traffic in country milk for the supply of dwellers in urban districts. Prior to 1860 this traffic was comparatively small or in its infancy. Thirty years earlier it could not have been brought into existence, for it is an outcome of the great network of railways which was spread over the face of the country in the latter half of the 19th century. It affords an instructive illustration of the process of commercial evolution which has been fostered by the vast increase of urban population within the period indicated. It is a tribute to the spirit of sanitary reform which—as an example in one special direction—has brought about the disestablishment of urban cow-sheds and the consequent demand for milk produced in the shires. London, in fact, is now being regularly supplied with fresh milk from places anywhere within 150 m., and the milk traffic on the railways, not only to London but to other great centres, is an important item. A factor in the development of the milk trade must no doubt be sought in the outbreak of cattle plague in 1865, for it was then that the dairymen of the metropolis were compelled to seek milk all over England, and the capillary refrigerator being invented soon after, the production of milk has remained ever since in the hands of dairymen living mainly at a distance from the towns supplied.

This great change in country dairying, involving the continuous export of enormous quantities of milk from the farms, has been accompanied by subsidiary changes in the management of dairy-farms, and has necessitated the extensive purchase of feeding-stuffs for the production of milk, especially in winter-time. It is probable that, in this way, a gradual improvement of the soil on such farms has been effected, and the corn-growing soils of distant countries are adding to the store of fertility of soils in the

British Isles. Country roads, exposed to the wear and tear of a comparatively new traffic, are lively at morn and eve with the rattle of vehicles conveying fresh milk from the farms to the railway stations. Most of these changes were brought about within the limits of the last third of the 19th century.

In the case of London the daily supply of a perishable article such as milk, which must be delivered to the consumer within a few hours of its production, to a population of five millions, is an undertaking of very great magnitude, especially when it is considered that only a comparatively minute proportion of the supply is produced in the metropolitan area itself. To meet the demand of the London consumer some 5000 dairies proper exist, as well as a large number of businesses where milk is sold in conjunction with other commodities. It has been computed that some 12,000 traders are engaged in the business of milk-selling in the metropolis, and the number of persons employed in its distribution, &c., cannot be fewer than 25,000. The amount of capital involved is very great, and it may be mentioned that the paid-up capital of six of the principal distributing and retail dairy companies amounts to upwards of one million sterling. The most significant feature in connexion with the milk-supply of the metropolis at the beginning of the 20th century is the gradual extinction of the town "cowkeeper"—the retailer who produces the milk he sells. The facilities afforded by the railway companies, the favourable rates which have been secured for the transport of milk, and the more enlightened methods of its treatment after production, have made it possible for milk produced under more favourable conditions to be brought from considerable distances and delivered to the retailer at a price lower than that at which it has been possible to produce it in the metropolis itself. As a result, the number of milk cows in the county of London diminished from 10,000 in 1889 to 5144 in 1900, the latter, on an estimated production of 700 gallons per cow—the average production of stall-fed town cows—representing a yearly milk yield of 3,600,000 gallons. How small a proportion this is of the total supply will be gathered from the fact that the annual quantity of milk delivered in London on the Great Western line amounts to some 11,000,000 gallons, whilst the London & North-Western railway delivers 9,000,000, and the Midland railway at St Pancras 5,000,000, and at others of its London stations about 1,000,000, making 6,000,000 in all. The London & South-Western railway brings upwards of 8,000,000 gallons to London, a quantity of 7,500,000 gallons is carried by the Great Northern railway, and the Great Eastern railway is responsible for 7,000,000. The London, Brighton & South Coast railway delivers 1,000,000 gallons, and the South-Eastern & Chatham and the London & Tilbury railways carry approximately 1,000,000 gallons between them. A large quantity of milk is also carried in by local lines from farms in the vicinity of London and delivered at the local stations, and a quantity is also brought by the Great Central railway. In addition to this, milk is taken into London by carts from farms in the neighbourhood of the metropolis. A computation of the total milk-supply of the metropolis reveals a quantity approximating to 60,000,000 gallons per annum, or rather more than a million gallons per week, which, taking 500 gallons as the average yearly production of the cows contributing to this supply, represents the yield of at least 120,000 cows. The growth of the supply of country milk to London may be judged from the figures given by Mr George Barham, chairman of the Express Dairy Co. Ltd., in an article on "The Milk Trade" contributed to Professor Sheldon's work on *The Farm and Dairy*. The quantities carried by the respective railways in 1889 are therein stated in gallons as:—Great Western, 9,000,000; London & North-Western, 7,000,000; Midland, 7,000,000; London & South-Western, 6,000,000; Great Northern, 3,000,000; Great Eastern, 3,000,000; the southern lines, 2,000,000. The increase, therefore, on these lines amounted to no less than 13,500,000 gallons per annum, or 36%. The diminished production in the metropolis itself amounted approximately only to 3,000,000 gallons, and it follows, therefore, that the consumption largely increased.

Previously to 1864 it was only possible to bring milk into London from short distances, but the introduction of the refrigerator has enabled milk to be brought from places as far removed from the metropolis as North Staffordshire, and it has even been received from Scotland. Practically the whole of the milk supplied to the metropolis is produced in England. Attempts have been made to introduce foreign milk, and in 1898 a company was formed to promote the sale of fresh milk from Normandy, but the enterprise did not succeed. The trade subsequently showed signs of reviving, owing probably to the increased cost of the home produced article, and during the winter season of 1900-1901 the largest quantity received into the kingdom in one week amounted to 10,000 gallons. Of recent years a large demand has sprung up for sterilized milk in bottles, and a considerable trade is also done in humanized milk, which is a milk preparation approximating in its chemical composition to human milk.

Estimating the average yield of milk of each country cow at 500 gallons per annum, and assuming an average of 28 cows to each farm, as many as 4300 farmers are engaged in supplying London with milk; allotting ten cows to each milker, it needs 12 battalions of 1000 men each for this work alone. Some 3500 horses are required to convey the milk from the farms to the country railway stations. The chief sources of supply are in the counties of Derby, Stafford, Leicester, Northampton, Notts, Warwick, Bucks, Oxford, Gloucester, Berks, Wilts, Hants, Dorset, Essex, and Cambridge. It is not entirely owing to the railways that London's enormous supply of milk has been rendered possible, for the milk must still have been produced in the immediate neighbourhood of the metropolis had not the method of reducing the temperature of the product by means of the refrigerator been devised. There are probably 5700 horses engaged in the delivery of milk in London, and more people are employed in this work than in milking the cows. One of the great difficulties the London dairyman has to contend with, and a cause of frequent anxiety to him, is associated with the rise and fall of the thermometer, for a movement to the extent of ten degrees one way or the other may diminish or increase the supply in an inverse ratio to the demand. Thus, at periods of extreme cold, the cows shrink in their yield of milk, while from the same cause the Londoner is demanding more, in an extra cup of coffee, &c. Again, at periods of extreme heat, which has the same effect on the cow's production as extreme cold, the customer also demands an increased quantity of milk. Ten degrees fall of temperature in the summer will result in a lessened demand and an enlarged supply—to such an extent, indeed, that a single firm has been known to have had returned by its carriers some 600 gallons in one day. In such cases the cream separator is capable of rendering invaluable assistance. To make cheese in

London in large quantities and at uncertain intervals has been found to be impracticable, while to set for cream a great bulk of milk is almost equally so. But now a considerable portion of what would otherwise be lost is saved by passing the milk through separators, and churning the cream into butter.

Previously to the enormous development of the urban trade in country milk, dairy farms were in the main self-sustaining in the matter of manures and feeding-stuffs, and the cropping of arable land was governed by routine. To-day, on the contrary, many dairy farms are run at high pressure by the help of purchased materials,—corn, cake, and manure,—and the land is cropped regardless of routine and independent of courses. Such crops, moreover, are grown—white straw crops, green crops, root crops—as are deemed likely to be most needed at the time when they are ready. Green crops,—“soiling” crops, as they are termed in North America,—consisting largely of vetches or tares (held up by stalks of oat plants grown amongst them), cabbages, and in some districts green maize, are used to supplement the failing grass-lands at the fall of the year, and root crops, especially mangel, are advantageously grown for the same purpose. For winter feeding the farm is made to yield what it will in the shape of meadow and clover hay, and of course root crops of the several kinds. This provision is supplemented by the purchase of, for example, brewers' grains as a bulky food, and of oilcake and corn of many sorts as concentrated food.

BRITISH OUTPUT, IMPORTS AND EXPORTS OF DAIRY PRODUCE

Whilst the quantity of imported butter and cheese consumed in the United Kingdom from year to year can be arrived at with a tolerable degree of accuracy, it is more difficult to form an estimate of the amounts of these articles annually produced at home. Various attempts have, however, from time to time been made by competent authorities to arrive approximately at the annual output of milk, butter and cheese in the United Kingdom, and the results are given by Messrs W. Weddel & Co. in their annual *Dairy Produce Review*. Table XI. shows the estimates for each of the ten years 1890 to 1899, the numbers in the second column of “cows and heifers in milk or in calf” being identical with those officially recorded in the agricultural returns. In thus estimating the quantity of milk, butter and cheese produced within the United Kingdom, the “average milking life” of a cow is taken to be four years, from which it follows that on the average one-fourth of the total herd has to be renewed every year by heifers with their first calf. This leaves 75% of the total herd giving milk throughout the year. Each cow of this 75% is estimated as yielding 49 cwt., or 531 gallons of milk annually. It is assumed that 15% of the total milk yield is used for the calf, 32% utilized for butter-

TABLE XI.—Estimated Annual Production of Milk, Butter and Cheese in the United Kingdom for the Ten Years ended 31st December 1899.

Year ended December 31	Cows and Heifers in Milk or in Calf on 4th June.	Cows per 1000 of Population.	Cows and Heifers giving Milk all the year round; say 75% of Total.	Influence of Season. Percentage above or below the Average of previous 10 Years.	Estimated Total Quantity of Milk produced in the 52 Weeks, by 75% of the Total Herd, at 49 cwt. or 531 gallons per Cow.	Estimated Total Quantity of Butter produced in the 52 Weeks, taking 32% of the Total Milk to yield 80 lb of Butter per Ton of Milk.	Estimated Total Quantity of Cheese produced in the 52 Weeks, taking 20% of the Total Milk to yield 220 lb of Cheese per Ton of Milk.
	No.	No.	No.	%	Tons.	Tons.	Tons.
1890	3,956,220	105.5	2,967,165	+3.0	7,487,640	85,572	147,078
1891	4,117,707	108.9	3,088,281	Average.	7,566,288	86,472	148,624
1892	4,120,451	108.1	3,090,339	-5.6	7,147,337	81,684	140,394
1893	4,014,055	104.4	3,010,542	-9.0	6,712,004	76,709	131,843
1894	3,925,486	101.2	2,944,115	+6.3	7,667,505	87,628	150,611
1895	3,937,590	100.5	2,953,193	-3.5	6,982,087	79,652	137,148
1896	3,958,762	100.0	2,969,387	-4.0	6,983,999	79,817	130,000
1897	3,984,167	99.7	2,988,126	+3.1	7,547,856	86,261	148,260
1898	4,035,501	100.0	3,025,526	+3.2	7,645,105	87,372	150,171
1899	4,133,249	101.9	3,099,937	-3.5	7,329,027	83,760	130,020
10 Years' Average	4,018,318	103.0	3,013,660	-0.7	7,906,874	83,992	141,412

making, 20% for cheese-making, and the remaining 33% consumed in the household as fresh milk. A ton of milk is estimated to produce 80 lb of butter or 220 lb of cheese. A gallon of milk weighs 10.33 lb (10½ lb). The probable effects of each season upon the production have been taken into consideration in making these estimates, and it will be noticed that owing to the terrible drought of 1893 a reduction of 9% is made from the average. Accepting these estimates with due reservation,<sup>1</sup> it is seen that the annual production of milk varied in the decade to the extent of nearly a million tons, the exact difference between the maximum of 7,667,505 tons in 1894 and the minimum of 6,712,004 tons in 1893 being 955,501 tons. The decennial averages are 7,906,874 tons of milk, 83,992 tons of butter, and 141,412 tons of cheese.

Table XII. furnishes an estimate of the total consumption of butter in the United Kingdom in each of the years 1891 to 1900. Whilst the estimated home production did not vary greatly from year to year, the imports from colonial and foreign sources underwent almost continuous increase. The ten years' average indicates 37.6% home-made, 7.3% imported colonial, and 55.1% imported foreign butter. But whereas at the beginning of the decade the proportions were 45.4% home-made, 1.5% colonial, and 53.2% foreign, at the end of the percentages were 32.8, 14.7 and 52.5 respectively. It thus appears that whilst the United Kingdom was able in 1891 to furnish nearly half of its requirements (45.4%), by 1900 it was unable to supply more than one-third (32.8%).

The rapid headway which colonial butter has made in British markets is shown by the fact that for the five years ended 30th of

TABLE XII.—Estimated Home Production and Imports of Butter into the United Kingdom for the Ten Years ended 30th June 1900.

Year ended 30th June.	Home Production, estimated.	Imported Colonial.	Imported Foreign.	Total.
	Tons.	Tons.	Tons.	Tons.
1891 . . . . .	84,961	2,883	99,598	187,442
1892 . . . . .	86,022	6,323	101,796	194,141
1893 . . . . .	84,078	9,408	105,712	199,198
1894 . . . . .	79,196	15,550	107,534	202,280
1895 . . . . .	82,168	17,807	116,730	216,705
1896 . . . . .	83,640	12,949	133,249	229,838
1897 . . . . .	79,734	18,111	138,800	236,645
1898 . . . . .	83,039	17,732	141,426	242,197
1899 . . . . .	87,326	22,443	142,193	251,962
1900 . . . . .	83,760	37,534	133,957	255,251
10 Years' Average	83,392	16,074	122,099	221,565

June 1900 the import had grown from 12,949 tons to 37,534 tons per annum, or an increase of 24,585 tons. It is during the mid-winter months that the colonial butter from Australasia arrives on the British markets, while that from Canada begins to arrive in July, and virtually ceases in the following January. The bulk of the Canadian butter reaches British markets during August, September and October; the bulk of the Australasian in December, January and February.

It appears to be demonstrated by the experience of the last decade of the 19th century that the United Kingdom is quite unable to turn out sufficient dairy produce to supply its own population. In the year ended 30th of June 1891 the total import of butter was 102,500 tons, and for the year ended 30th of June 1900 it was 170,700 tons, which shows an annual average increase in the decade of 6800 tons. This growth was on the whole very uniform, any disturbance in its regularity being attributable more to the deficient seasons in the colonies and foreign countries than to the bountiful seasons at home. Twice in the decade the import of butter from colonial sources fell off slightly from the previous year, namely, in 1896 and 1898, while only once was there any decrease in the foreign supply, and this occurred in 1900. In 1896 the colonial supply fell off by 5000 tons, principally owing to drought in Australia, but from foreign countries this deficiency was more than made good, as the increased import from these sources exceeded 16,500 tons. In 1900 the position was reversed, for while the foreign import fell away to the extent of over 8000 tons, the supply from the colonies exceeded that of 1899 by 15,000 tons, thus leaving a gain in the quantity of imported butter of nearly 7000 tons on the year. Table XII. shows that over the ten years, 1891-1900, the import of colonial butter was augmented by 34,600 tons, and that of foreign by 33,600 tons, so that the in-

<sup>1</sup> A special committee appointed by the council of the Royal Statistical Society commenced in 1901 an inquiry into the home production of milk and meat in the United Kingdom.

creased import is fairly divided between colonial and foreign sources. If, however, the last five years of the period be taken, it will be seen that the increases in the arrivals of colonial butter have far exceeded those from foreign countries. Between 1891 and 1900 the Australasian colonies increased their quota by 13,400 tons, and Canada by 11,100 tons. Of foreign countries, Denmark showed the greatest development in the supply of imported butter, which increased in the ten years by 28,678 tons. Next came Russia and Holland, with increases respectively of 7207 tons and 6589 tons. Sweden, which made steady progress from 1891 to 1896, subsequently declined, and in 1900 sent 1400 tons less than in 1891. France and Germany are rapidly falling away, and the latter country will soon cease its supply altogether. Up to 1896 it was 6000 tons annually; by 1900 it had fallen to 1850 tons. France, which in 1892 sent to the United Kingdom 29,000 tons, regularly declined, and in 1900 sent only 16,800. Among the countries sending the smaller quantities, Argentina, Belgium and Norway are all gradually increasing their supplies; but their totals are comparatively insignificant, as they together contributed in 1900 only 6400 tons out of a total foreign supply of 134,000 tons. The United States was erratic in its supplies during the decade, and up to 1900 had not made butter specially for export to the United Kingdom, as all the other foreign countries had done. Consequently it is only when supplies from elsewhere fail that American butter is sought for by British buyers. The large amount of salt in this butter, although suitable for the American palate, prevents its becoming popular in the United Kingdom.

The sources whence the United Kingdom receives butter from abroad are sufficiently indicated in Table XIII., which shows the absolute quantities and the relative proportions sent by the chief contributory countries in each of the four years 1897 to 1900, the

TABLE XIII.—Annual Imports of Butter into the United Kingdom, 1897-1900.

From	1897.	1898.	1899.	1900.
	Cwt.	Cwt.	Cwt.	Cwt.
Denmark . . . . .	1,334,726	1,465,030	1,430,052	1,486,342
Australasia . . . . .	269,432	228,563	366,944	509,910
France . . . . .	448,128	416,821	353,942	322,048
Holland . . . . .	278,631	269,631	284,810	282,805
Russia* . . . . .	..	..	..	209,738
Sweden . . . . .	299,214	294,962	245,599	196,041
Canada . . . . .	109,402	156,865	250,083	138,313
United States . . . . .	154,196	66,712	159,137	56,046
Germany . . . . .	51,761	41,231	36,953	36,042
Other countries . . . . .	272,312	269,645	262,331	141,231
Total . . . . .	3,217,802	3,209,153	3,389,851	3,378,516
	%	%	%	%
Denmark . . . . .	41.5	45.6	42.2	44.0
Australasia . . . . .	8.4	7.1	10.8	15.1
France . . . . .	13.9	13.0	10.5	9.5
Holland . . . . .	8.7	8.4	8.4	8.4
Russia* . . . . .	..	..	..	6.2
Sweden . . . . .	9.3	9.2	7.2	5.8
Canada . . . . .	3.4	4.9	7.4	4.1
United States . . . . .	4.8	2.1	4.7	1.6
Germany . . . . .	1.6	1.3	1.1	1.1
Other countries . . . . .	8.4	8.4	7.7	4.2
Total . . . . .	100.0	100.0	100.0	100.0

\* Not shown separately in the Trade and Navigation Returns prior to 1900.

order of precedence of the several countries being in accord with the figures for 1900. Denmark, as a result of the efforts made by that little kingdom to supply a sound product of uniform quality, possesses over 40% of the trade, and in the year 1900 received from the United Kingdom upwards of £8,000,000 for butter and over £3,000,000 for bacon, the raising of pigs for the consumption of separated milk being an important adjunct of the dairying industry in Denmark, where butter factories are extensively maintained on the co-operative principle. It is worthy of note that some at least of the butter received in the United Kingdom from Russia is made in Siberia, whence it is sent at the outset on a long land journey in refrigerated railway cars for shipment at a Baltic port, usually Riga. The countries not specially enumerated in Table XIII. from which butter is sent to the United Kingdom are Argentina, Belgium, Norway and Spain—these are included in "other countries."

In Table XIV., relating to the estimated home production of cheese and the imports of that article, the ten years' average indicates a home-made supply of 55.3%, imports of colonial cheese 24.2%, and imports of foreign cheese 20.5%. Comparing, however, the first with the last year of the period 1891-1900, it appears that in 1891 the proportions were 58.6% home-made, 17.2% colonial and 24.2% foreign, whereas in 1900 the percentages were 50.3, 28.9 and 20.8 respectively. Hence the colonial contribution (chiefly

Canadian) has gained ground at the expense both of the home-made and of the foreign. Again, comparing 1891 with 1900, the import of cheese into the United Kingdom increased to the extent of only 24,500 tons, so that it shows no expansion comparable with that of butter, which increased by about 70,000 tons. Simultaneously the estimated home production diminished by 17,000 tons.

TABLE XIV.—Estimated Home Production and Imports of Cheese into the United Kingdom for the Ten Years ended 30th June 1900.

Year ended 30th June	Home Production, estimated.	Imported Colonial	Imported, Foreign.	Total.
	Tons.	Tons.	Tons.	Tons.
1891 . . . . .	147,078	43,228	60,816	251,122
1892 . . . . .	148,624	45,781	59,452	253,857
1893 . . . . .	140,394	55,549	56,767	252,710
1894 . . . . .	131,843	57,322	52,498	241,663
1895 . . . . .	150,611	61,622	52,570	264,803
1896 . . . . .	137,148	62,478	44,569	244,195
1897 . . . . .	130,000	67,028	46,317	243,345
1898 . . . . .	148,260	77,620	49,114	274,994
1899 . . . . .	150,000	73,752	46,985	270,737
1900 . . . . .	130,000	74,702	53,903	258,605
10 Years' Average	141,396	61,908	52,299	255,603

In imported colonial cheese Canada virtually has the field to itself, for the only other colonial cheese which finds its way into the United Kingdom is from New Zealand, but the amount of this kind is comparatively insignificant, having been in 1900 only 4000 tons out of a total import of 128,600 tons. Australia, in several seasons since 1891, sent small quantities, but they are not worth quoting.

From foreign countries the decline in the export of cheese is mainly in the case of the United States, which shipped to British ports 10,000 tons less in 1900 than in 1891. France also is losing its cheese trade in British markets, and is being supplanted by Belgium. In 1891 France supplied over 3000 tons, in 1900 the import was below 2000 tons. Belgium in 1891 supplied less than 1000 tons, but in 1900 contributed 2600 tons. The import trade in Dutch cheese remains almost stationary. In 1891 it amounted to 15,300 tons, in 1899 it was 15,600 tons, whilst in 1900, owing to exceptionally high prices, which stimulated the manufacture, it reached 17,000 tons.

Over 80% of the cheese imported into the United Kingdom is derived from North America, but the bulk of the trade belongs to Canada, which supplies nearly 60% of the entire import. The value of the cheese exported from Canada to the United Kingdom in the calendar year 1900 was close upon £3,800,000. As is shown in Table XV. below, Holland, Australasia and France participate in this trade, whilst amongst the "other countries" are Germany, Italy and Russia. The cheese sent from North America and Aus-

TABLE XV.—Annual Imports of Cheese into the United Kingdom, 1897-1900.

From	1897.	1898.	1899.	1900.
	Cwt.	Cwt.	Cwt.	Cwt.
Canada . . . . .	1,526,664	1,432,181	1,337,198	1,511,872
United States . . . . .	631,616	485,995	590,737	680,583
Holland . . . . .	297,604	292,925	328,541	327,817
Australasia . . . . .	68,615	44,608	32,294	86,513
France . . . . .	36,358	33,086	34,307	35,110
Other countries . . . . .	42,321	50,657	60,992	69,910
Total . . . . .	2,603,178	2,339,452	2,384,069	2,711,805
	%	%	%	%
Canada . . . . .	58.6	61.2	56.1	55.8
United States . . . . .	24.3	20.8	24.8	25.1
Holland . . . . .	11.4	12.5	13.8	12.0
Australasia . . . . .	2.7	1.9	1.3	3.2
France . . . . .	1.4	1.4	1.4	1.3
Other countries . . . . .	1.6	2.2	2.6	2.6
Total . . . . .	100.0	100.0	100.0	100.0

tralasia is mostly of the substantial Cheddar type, whereas soft or "fancy" cheese is the dominant feature of the French shipments. Thus, in the calendar year 1900 the average price of the cheese imported into the United Kingdom from France was 61s. per cwt., whilst the average value of the cheese from all other sources was 50s. per cwt., there being a difference of 11s. in favour of the "soft" cheese of France.

The imports of butter and margarine into the United Kingdom were not separately distinguished before the year 1886. Previous to

that date they amounted, at five-year intervals, to the following aggregate quantities:—

	1870.	1875.	1880.	1885.
Cwt. . . . .	1,159,210	1,467,870	2,326,305	2,401,373
For the same years the imports of cheese registered the subjoined totals:—				
	1870.	1875.	1880.	1885.
Cwt. . . . .	1,041,281	1,627,748	1,775,997	1,833,832

The imports of butter and margarine, both separately and together, and also the imports of cheese in each year from 1886 to 1900 inclusive, are set out in Table XVI., the most significant feature of which is the rapid expansion it shows in the imports of butter. In the space of nine years, between 1887 and 1896, the quantity was doubled. On the other hand, the general tendency of the imports of margarine, which have been much more uniform than those of butter, has been in the direction of decline since 1892. It is necessary, however, to point out that there has been an increase in the number of margarine factories in the United Kingdom, and in the quantity of margarine manufactured in them, during the last few years. Taking the imports of butter and margarine together, the aggregate in 1889 and also in 1900 was practically three times as large as a quarter of a century earlier, in 1875. The imports of cheese have increased at a less rapid rate than those of butter, and the quantity imported in 1900, which was a maximum, fell considerably short of twice the quantity in 1875. In 1886, 1887, 1888, 1890 and 1892 the imports of cheese exceeded those of butter, but since

TABLE XVI.—Imports of Butter, Margarine and Cheese into the United Kingdom, 1886-1900.

Year.	Butter.	Margarine.	Total Butter and Margarine.	Cheese.
	Cwt.	Cwt.	Cwt.	Cwt.
1886 . . . . .	1,543,566	887,974	2,431,540	1,734,890
1887 . . . . .	1,513,134	1,276,140	2,789,274	1,836,789
1888 . . . . .	1,671,433	1,139,743	2,811,176	1,917,616
1889 . . . . .	1,927,842	1,241,690	3,169,532	1,907,999
1890 . . . . .	2,027,717	1,079,856	3,107,573	2,144,074
1891 . . . . .	2,135,607	1,235,430	3,371,037	2,041,325
1892 . . . . .	2,183,009	1,305,350	3,488,359	2,232,817
1893 . . . . .	2,327,474	1,299,970	3,627,444	2,077,462
1894 . . . . .	2,574,835	1,109,325	3,684,160	2,266,145
1895 . . . . .	2,825,662	940,168	3,765,830	2,133,819
1896 . . . . .	3,037,718	925,934	3,963,652	2,244,525
1897 . . . . .	3,217,802	936,543	4,154,345	2,603,178
1898 . . . . .	3,209,153	900,615	4,109,768	2,339,452
1899 . . . . .	3,389,851	953,175	4,343,026	2,384,069
1900 . . . . .	3,378,516	920,416	4,298,932	2,711,805

the last-named year those of butter have always been the larger, and 1899 were fully a million cwt. more than the cheese imports. The cheapness of imported fresh meat has probably had the effect of checking the growth of the demand for cheese amongst the industrial classes.

The imports of condensed milk into the United Kingdom were not separately distinguished before 1888. In that year they amounted to 352,332 cwt. The quantities imported in subsequent years were the following:—

Year.	Cwt.	Year.	Cwt.	Year.	Cwt.
1889 . . . . .	339,892	1893 . . . . .	501,005	1897 . . . . .	756,243
1890 . . . . .	407,426	1894 . . . . .	529,465	1898 . . . . .	817,274
1891 . . . . .	444,666	1895 . . . . .	545,394	1899 . . . . .	824,599
1892 . . . . .	481,374	1896 . . . . .	611,335	1900 . . . . .	986,741

The quantity thus increased continuously in each year after 1889, with the result that in 1900 the imports had grown to nearly three times the amount of those in 1889. Simultaneously, over the period 1889-1900 the annual value of the imports steadily advanced from £704,849 to £1,405,033. Thus, while the imports of condensed milk trebled in quantity, they doubled in value. A fair proportion is, however, exported, as is shown in the following statement of exports of imported condensed milk for the four years 1897 to 1900:—

	1897.	1898.	1899.	1900.
Quantity, . . . cwt.	143,932	133,596	118,394	164,602
Value . . . . .	£274,578	£256,525	£228,446	£309,460

There is also an export trade in condensed milk made in the United Kingdom. Thus, in 1892 the exports of home-made condensed milk amounted to 61,442 cwt., valued at £133,556. By 1896 the quantity had almost doubled, and reached 111,959 cwt., of the value of £224,831. In subsequent years the exports were:—

	1897.	1898.	1899.	1900.
Quantity, . . . cwt.	154,901	178,055	185,749	209,447
Value . . . . .	£302,748	£343,070	£353,819	£390,559

Milk and cream (fresh or preserved other than condensed) received no separate classification in the imports until 1894, in which year the quantity imported was 161,633 gallons, followed by 126,995 gallons in 1895, and 22,776 gallons in 1896. The quantities have since been returned by weight—10,006 cwt. in 1897, 10,691 cwt. in 1898, 7859 cwt. in 1899, and 15,638 cwt. in 1900. The values of these imports in the successive years 1894 to 1900 were £21,371, £19,991, £5489, £9848, £11,293, £16,068 and £26,837.

The total values of the imports of dairy produce of all kinds—butter, margarine, cheese, &c.—into the United Kingdom were, at five-year intervals between 1875 and 1890, the following:—

	1875.	1880.	1885.	1890.
Value	£13,211,592	£17,232,548	£15,632,852	£19,505,798

The values in each year of the closing decade of the 19th century are set forth in Table XVII., where the totals in the last column include small sums for margarine-cheese and, since 1893, for fresh milk and cream. The aggregate value more than doubled during the last quarter of the century. The earliest year for which the value

TABLE XVII.—Values of Dairy Products imported into the United Kingdom from 1891 to 1900, in Thousands of Pounds Sterling.

Year.	Butter.	Margarine.	Cheese.	Condensed Milk.	Total.
	£1000.	£1000.	£1000.	£1000.	£1000.
1891	11,591	3558	4813	900	20,863
1892	11,965	3713	5417	930	22,025
1893	12,754	3655	5161	1010	22,580
1894	13,457	3045	5475	1079	23,077
1895	14,245	2557	4675	1084	22,581
1896	15,344	2498	4900	1170	23,920
1897	15,917	2485	5886	1398	25,715
1898	15,962	2384	4970	1436	24,779
1899	17,214	2549	5503	1455	26,747
1900	17,450	2465	6838	1743	28,544

of imported butter is separately available is 1886, when it amounted to £8,141,438. Thirteen years later this sum had more than doubled, and it is an impressive fact that in the closing year of the century the United Kingdom should have expended on imported butter alone a sum closely approximating to 17½ million pounds sterling, equivalent to about three-fourths of the total amount disbursed on imported wheat grain.<sup>1</sup>

The imports of margarine—that is, of margarine specifically declared to be such—into the United Kingdom are derived almost entirely from Holland. Out of a total of 920,416 cwt. imported in 1900 Holland supplied 862,154 cwt., and out of £2,464,839 expended on imported margarine in the same year Holland received £2,295,174. To the imports in the year named Holland contributed 93·7%; France, 2·9; Norway, 0·9; all other countries, 2·5; so that Holland possesses almost a monopoly of this trade. The quantities of imported butter, margarine and cheese that are again exported from the United Kingdom are trivial when compared with the imports, as will be seen from the following quantities and values in the three years 1898 to 1900:—

	1898.	1899.	1900.	1898.	1899.	1900.
	Cwt.	Cwt.	Cwt.	£	£	£
Butter	63,491	50,453	51,583	319,806	257,999	258,931
Margarine	10,023	13,139	11,326	24,721	33,319	27,882
Cheese	56,694	56,390	55,982	159,210	163,991	168,369

There is also a very small export trade in butter and cheese made in the United Kingdom, but its insignificant character is evident from the subjoined details as to quantities and values for the years named:—

	1898.	1899.	1900.	1898.	1899.	1900.
	Cwt.	Cwt.	Cwt.	£	£	£
Butter	11,359	9,936	10,127	59,731	53,195	53,701
Cheese	10,126	9,758	9,356	36,803	35,890	36,691

#### AMERICAN DAIRYING

The development of the dairying industry in the vast region of the United States of America has been described in the official *Year-Book* by Major Henry E. Alvord, chief of the dairy division of the bureau of animal industry in the department of agriculture at Washington. The beginning of the 20th century found the industry upon an altogether higher level than seemed possible a few decades earlier. The milch cow herself, upon which

<sup>1</sup> In 1901 the United Kingdom imported 3,702,810 cwt. of butter, valued at £19,297,005, both totals being the largest on record.

the whole business rests, has become almost as much a machine as a natural product, and a very different creature from the average animal of bygone days. The few homely and inconvenient implements for use in the laborious duties of the dairy have been replaced by perfected appliances, skilfully devised to accomplish their object and to lighten labour. Long rows of shining metal pans no longer adorn rural dooryards. The factory system of co-operative or concentrated manufacture has so far taken the place of home dairying that in entire states the cheese vat or press is as rare as the handloom, and in many counties it is as difficult to find a farm churn as a spinning-wheel. An illustration of the nature of the changes is afforded in the butter-making district of northern Vermont, at St Albans, the business centre of Franklin county. In 1880 the first creamery was built in this county; ten years later there were 15. Now a creamery company at St Albans has upwards of 50 skimming or separating stations distributed through Franklin and adjoining counties. To these is carried the milk from more than 30,000 cows. Farmers who possess separators at home may deliver cream which, after being inspected and tested, is accepted and credited at its actual butter value, just as other raw material is sold to mills and factories. The separated cream is conveyed by rail and waggon to the central factory, where in one room from 10 to 12 tons of butter are made every working day—a single churning place for a whole county! The butter is all of standard quality, "extra creamery," and is sold on its reputation upon orders received in advance of its manufacture. The price is relatively higher than the average for the product of the same farms fifty years earlier. This is mainly due to better average quality and greater uniformity—two important advantages of the creamery system.

In one important detail dairy labour is the same as a century ago. Cows still have to be milked by hand. Although many attempts have been made, and patent after patent has been issued, no mechanical contrivance has yet proved a practical success as a substitute for the human hand in milking. Consequently, twice (or thrice) daily every day in the year, the dairy cows must be milked by manual labour. This is one of the main items of labour in dairying, and is a delicate and important duty. Assuming 10 cows per hour to a milker, which implies quick work, it requires the continuous service of an army of 300,000 men, working 10 or 12 hours a day throughout the year, to milk the cows kept in the United States.

The business of producing milk for urban consumption, with the accompanying agencies for transportation and distribution, has grown to immense proportions. In many places the milk trade is regulated and supervised by excellent municipal ordinances, which have done much to prevent adulteration and to improve the average quality of the supply. Quite as much is, however, being done by private enterprise through large milk companies, well organized and equipped, and establishments which make a speciality of serving milk and cream of fixed quality and exceptional purity. Such efforts to furnish "certified" and "guaranteed" milk, together with general competition for the best class of trade, are doing more to raise the standard of quality and improve the service than all the legal measures. The buildings and equipment of some of these modern dairies are beyond precedent. This branch of dairying is advancing fast, upon the safe basis of care, cleanliness and better sanitary conditions.

Cheese-making has been transferred bodily from the domain of domestic arts to that of manufactures. In the middle of the 19th century about 100,000,000 lb of cheese was made yearly in the United States, and all of it in farm dairies. At the beginning of the 20th century the annual production was about 300,000,000 lb, and 96 or 97% of this was made in factories. Of these there are nearly 3000, but they vary greatly in capacity, and some are very small. New York and Wisconsin possess a thousand each, but the former state makes nearly twice as much cheese as the latter, whilst the two together produce three-fourths of the entire output of the country. A change is taking place in the direction of bringing a number of factories previously independent into a



“ combination ” or under the same management. This tends to improve the quality and secure greater uniformity in the product, and often reduces cost of manufacture. More than nine-tenths of all the cheese made is of the familiar standard type, copied after the English Cheddar, but new kinds and imitations of foreign varieties are increasing. The annual export of cheese from the United States ranges between 30,000,000 and 50,000,000 lb. The consumption *per capita* does not exceed 3½ lb per annum, which is much less than in most European countries.

Butter differs from cheese in that it is still made much more largely on farms in the United States than in creameries. Creamery butter controls all the large markets, but this represents little more than one-third of the entire business.

Estimating the annual butter product of the entire country at 1,400,000,000 lb not much over 500,000,000 lb of this is made at the 7500 or 8000 creameries in operation. Iowa is the greatest butter-producing state, and the one in which the greater proportion is made on the factory plan. The total output of butter in this state is one-tenth of all made in the Union. The average quality of butter has materially improved since the introduction of the creamery system and the use of modern appliances. Nevertheless, a vast quantity of poor butter is made—enough to afford a large and profitable business in collecting it at country stores at grease prices or a little more, and then rendering or renovating it by patent processes. This renovated butter has been fraudulently sold to a considerable extent as the true creamery article, of which it is a fair imitation while fresh, and several states have made laws for the identification of the product and to prevent buyers from being imposed upon. No butter is imported, and the quantity exported is insignificant, although there is beginning to be a foreign demand for American butter. The home consumption is estimated at the yearly rate of 20 lb per person, which, if correct, would indicate Americans to be the greatest butter-eating people in the world. The people of the United States also consume millions of pounds every year of butter substitutes and imitations, such as oleomargarine and butterine. Most of this is believed to be butter by those who use it, and the state dairy commissioners are busily employed in carrying out the laws intended to protect purchasers from these butter frauds.

The by-products of dairying have, within recent years, been put to economical uses, in an increasing degree. For every pound of butter made there are 15 to 20 lb of skim-milk and about 3 lb of butter-milk, and for every pound of cheese nearly 9 lb of whey. Up to 1889 or 1890 enormous quantities of skim-milk and butter-milk from the creameries and of whey from the cheese factories were entirely wasted. At farm dairies these by-products are generally used to advantage in feeding animals, but at the factories—especially at the seasons of greatest milk supply—this most desirable method of utilization is to a great extent impracticable. In many places new branches have been instituted for the making of sugar-of-milk and other commercial products from whey, and for the utilization of skim-milk in various ways. The albumin of the latter is extracted for use with food products and in the arts. The casein is desiccated and prepared as a substitute for eggs in baking, as the basis of an enamel paint, and as a substitute for glue in paper-sizing. It has also been proposed to solidify it to make buttons, combs, brush-backs, electrical insulators and similar articles.

No census of cows in the United States was taken until the year 1840, but they have been enumerated in each subsequent decennial census. From 23 to 27 cows to every 100 of the population were required to keep the country supplied with milk, butter and cheese, and provide for the export of dairy products. The export trade, though it has fluctuated considerably, has never exceeded the produce of 500,000 cows. At the close of the 19th century it was estimated that there was one milch cow in the United States for every four persons, making the number of cows about 17,500,000. They are, however, very unevenly distributed, being largely concentrated in the great dairy states, Iowa leading with 1,500,000 cows, and being followed closely by New York. In the middle and eastern states the milk product goes very largely to the supply of the numer-

ous large towns and cities. In the central, west and north-west butter is the leading dairy product.

Table XVIII. shows approximately the quantity and value of the dairy products of the United States for a typical year, the grand total representing a value of \$451,600,000. Adding to this the skim-milk, butter-milk and whey, at their proper feeding value, and the calves

TABLE XVIII.—Estimated Number of Cows and Quantity and Value of Dairy Products in the United States in 1899.

Cows.	Product.	Rate of Product per Cow.	Total Product.	Rate of Value.	Total Value.
11,000,000	Butter	130 lb	1,430,000,000 lb	Cents. 18	Dollars. 257,400,000
1,000,000	Cheese	300 lb	300,000,000 lb	9	27,000,000
5,500,000	Milk	380 gals.	2,090,000,000 gals.	8	167,200,000

dropped yearly, the annual aggregate value of the produce of the dairy cows exceeds \$500,000,000, or is more than one hundred million pounds sterling. Accepting these estimates as conservative, they show that the commercial importance of the dairy industry of the United States is such as to justify all reasonable provisions for guarding its interests. (W. FR.)

**DAIS** (Fr. *dais*, *estrade*, Ital. *predella*), originally a part of the floor at the end of a medieval hall, raised a step above the rest of the building. On this the lord of the mansion dined with his friends at the high table, apart from the retainers and servants. In medieval halls there was generally a deep recessed bay window at one or at each end of the dais, supposed to be for retirement, or greater privacy than the open hall could afford. In France the word is understood as a canopy or hanging over a seat; probably the name was given from the fact that the seats of great men were then surmounted by such a feature. In ordinary use, the term means any raised platform in a room, for dignified occupancy.

**DAISY** (A.S. *daeges eage*, day's eye), the name applied to the plants constituting the genus *Bellis*, of the natural order Compositae. The genus contains ten species found in Europe and the Mediterranean region. The common daisy, *B. perennis*, is the only representative of the genus in the British Isles. It is a perennial, abundant everywhere in pastures and on banks in Europe, except in the most northerly regions, and in Asia Minor, and occurs as an introduced plant in North America. The stem of the daisy is short; the leaves, which are numerous and form a rosette, are slightly hairy, obovate-spathulate in shape, with rounded teeth on the margin in the upper part; and the root-stock is creeping, and of a brownish colour. The flowers are to be found from March to November, and occasionally in the winter months. The heads of flowers are solitary, the outer or ray-florets pink or white, the disk-florets bright yellow. The size and luxuriance of the plant are much affected by the nature of the soil in which it grows. The cultivated varieties, which are numerous, bear finely-coloured flowers, and make very effective borders for walks. What is known as the “hen-and-chicken” daisy has the main head surrounded by a brood of sometimes as many as ten or twelve small heads, formed in the axils of the scales of the involucre. The ray-florets curve inwards and “close” the flower-head in dull weather and towards evening.

Chaucer writes—

“ The daisie, or els the eye of the daie,  
The emprise, and the floure of flouris alle ”;

and again—

“ To seen this floure agenst the sunne sprede  
Whan it riseth early by the morrow,  
That blissful sight softeneth all my sorrow ”;

and the flower is often alluded to with admiration by the other poets of nature. To the farmer, however, the daisy is a weed, and a most wasteful one, as it exhausts the soil and is not eaten by any kind of stock.

In French the daisy is termed *la marguerite* (*μαργαριτης*, a pearl), and “herb margaret” is stated to be an old English appellation for it. In Scotland it is popularly called the gowan, and in Yorkshire it is the bairnwort, or flower beloved by children. The Christmas and Michaelmas daisies are species of *Aster*; the ox-eye daisy is *Chrysanthemum Leucanthemum*, a common weed in meadows and waste places. *B. perennis flore-pleno*, the

double daisy, consists of dwarf, showy, 3 to 4 in. plants, flowering freely in spring if grown in rich light soil, and frequently divided and transplanted. The white and pink forms, with the white and red quilled, and the variegated-leaved *aucubaefolia*, are some of the best.

**DAKAR**, a seaport of Senegal, and capital of French West Africa, in 14° 40' N., 17° 24' W. The town, which is strongly fortified, holds a commanding strategic position on the route between western Europe and Brazil and South Africa, being situated in the Gulf of Goree on the eastern side of the peninsula of Cape Verde, the most westerly point of Africa. It is the only port of Senegal affording safe anchorage for the largest ships. Pop. (1904), within the municipal limits, 18,447; including suburbs, 23,452.

The town consists for the most part of broad and regular streets and possesses several fine public buildings, notably the palace of the governor-general. It is plentifully supplied with good water and is fairly healthy. It is the starting point of the railway to St Louis, and is within five days steam of Lisbon. The harbour, built in 1904-1908, is formed by two jetties, one of 6840 ft., the other of 1968 ft., the entrance being 720 ft. wide. There are three commercial docks, with over 7000 ft. of quays, ships drawing 26 ft. being able to moor alongside. Cargo is transferred directly to the railway trucks. There is also a naval dock and arsenal with a torpedo-boat basin 755 ft. by 410 ft. and a dry dock 656 ft. long and 92 ft. broad. The Messageries Maritimes Company use the port as a coaling station and provisioning depot for their South American trade. Dakar is a regular port of call for other French lines and for the Elder Dempster boats sailing between Liverpool and the West Coast of Africa. It shares with Rufisque and St Louis the external trade of Senegal and the adjacent regions. For trade statistics see SENEGAL.

Dakar was originally a dependency of Goree and was founded in 1862, a year after the declaration of a French protectorate over the mainland. The port was opened for commerce in 1867, and in 1885 its importance was greatly increased by the completion of the railway (163 m. long) to St Louis. Dakar thus came into direct communication with the countries of Upper Senegal and the middle Niger. In 1887 the town was made a commune on the French model, all citizens irrespective of colour being granted the franchise. In 1903 the offices of the governor-general and of the court of appeal of French West Africa were transferred from St Louis to Dakar, which is also the seat of a bishop. In February 1905 a submarine cable was laid between Brest and Dakar, affording direct telegraphic communication between France and her West African colonies by an all French route.

**DALAGUETE**, a town of the province of Cebú, island of Cebú, Philippine Islands, at the mouth of the Tapón river on the E. coast, 50 m. S.S.W. of Cebú, the capital. The town has a healthy climate, cool during November, December, January and February, and hot during the rest of the year. The inhabitants grow hemp, Indian corn, coffee, sibucao, cacao, coconuts (for copra) and sugar, weave rough fabrics and manufacture tuba (a kind of wine used as a stimulant), clay pots and jars, salt and soap. There is some fishing here. The language is Cebú-Visayan.

**DALBEATTIE**, a police burgh of Kirkcudbrightshire, Scotland. Pop. (1901) 3469. It lies on Dalbeattie Burn, 14½ m. S.W. of Dumfries by the Glasgow & South-Western railway. The town dates from 1780 and owes its rise to the granite quarries at Craignair and elsewhere in the vicinity, from which were derived the supplies used in the construction of the Thames Embankment, the docks at Odessa and Liverpool and other works. Besides quarrying, the industries include granite-polishing, concrete (crushed granite) works, dye-works, paper-mills and artificial manures. The estuary of the Urr, known as Rough Firth, is navigable by ships of from 80 to 100 tons, and small vessels can ascend as far as the mouth of Dalbeattie Burn, within a mile of the town. A mile to the north-west stand the ruins of the castle of Buittle or Botel, where lived John de

Baliol, founder of Baliol college, who had married Dervorguila, daughter of Alan (d. 1234), the last "king" of Galloway.

**DALBERG**, the name of an ancient and distinguished German noble family, derived from the hamlet and castle (now in ruins) of Dalberg or Dalburg near Kreuznach in the Rhine Province. In the 14th century the original house of Dalberg became extinct in the male line, the fiefs passing to Johann Gerhard, chamberlain of the see of Worms, who married the heiress of his cousin, Anton of Dalberg, about 1330. His own family was of great antiquity, his ancestors having been hereditary ministerials of the bishop of Worms since the time of Ekbert the chamberlain, who founded in 1119 the Augustinian monastery of Frankenthal and died in 1132. By the close of the 15th century the Dalberg family had grown to be of such importance that, in 1494, the German King Maximilian I. granted them the honour of being the first to receive knighthood at the coronation; this part of the ceremonies being opened by the herald asking in a loud voice "Is no Dalberg present?" (*Ist kein Dalberg da?*). This picturesque privilege the family enjoyed till the end of the Holy Roman Empire. The elder line of the family of Dalberg-Dalberg became extinct in 1848, the younger, that of Dalberg-Herrnsheim, in 1833. The male line of the Dalbergs is now represented only by the family of Hessloch, descended from Gerhard of Dalberg (c. 1239), which in 1809 succeeded to the title and estates in Moravia and Bohemia of the extinct counts of Ostein.

The following are the most noteworthy members of the family:

1. **JOHANN VON DALBERG** (1445-1503), chamberlain and afterwards bishop of Worms, son of Wolfgang von Dalberg. He studied at Erfurt and in Italy, where he took his degree of doctor *utriusque juris* at Ferrara and devoted himself more especially to the study of Greek. Returning to Germany, he became privy councillor to the elector palatine Philip, whom he assisted in bringing the university of Heidelberg to the height of its fame. He was instrumental in founding the first chair of Greek, which was filled by his friend Rudolph Agricola, and he also established the university library and a college for students of civil law. He was an ardent humanist, was president of the *Sodalitas Celtica* founded by the poet Konrad Celtes (q.v.), and corresponded with many of the leading scholars of his day, to whom he showed himself a veritable Maecenas. He was employed also on various diplomatic missions by the emperor and the elector.

See K. Morneweg, *Johann von Dalberg, ein deutscher Humanist und Bischof* (Heidelberg, 1887).

2. **KARL THEODOR ANTON MARIA VON DALBERG** (1744-1817), archbishop-elect of Mainz, arch-chancellor of the Holy Roman Empire, and afterwards primate of the Confederation of the Rhine and grand-duke of Frankfort. He was the son of Franz Heinrich, administrator of Worms, one of the chief counsellors of the elector of Mainz. Karl had devoted himself to the study of canon law, and entered the church; and, having been appointed in 1772 governor of Erfurt, he won further advancement by his successful administration; in 1787 he was elected coadjutor of Mainz and of Worms, and in 1788 of Constance; in 1802 he became archbishop-elect of Mainz and arch-chancellor of the Empire. As statesman Dalberg was distinguished by his "patriotic" attitude, whether in ecclesiastical matters, in which he leaned to the Febronian view of a German national church, or in his efforts to galvanize the atrophied machinery of the Empire into some sort of effective central government of Germany. Failing in this, he turned to the rising star of Napoleon, believing that he had found in "the truly great man, the mighty genius which governs the fate of the world," the only force strong enough to save Germany from dissolution. By the peace of Lunéville, accordingly, though he had to surrender Worms and Constance, he received Regensburg, Aschaffenburg and Wetzlar. On the dissolution of the Empire in 1806 he formally resigned the office of arch-chancellor in a letter to the emperor Francis, and was appointed by Napoleon prince primate of the Confederation of the Rhine. In 1810, after the peace of Vienna (Schönbrunn), the grand-duchy of Frankfort was created for his benefit out of his

territories, which, in spite of the cession of Regensburg to Bavaria, were greatly augmented. Dalberg's subservience, as a prince of the Confederation, to Napoleon was specially resented since, as a priest, he had no excuse of necessity on the ground of saving family or dynastic interests; his fortunes therefore fell with those of Napoleon, and, when he died on the 10th of February 1817, of all his dignities he was in possession only of the archbishopric of Regensburg. Weak and shortsighted as a statesman, as a man and prelate Dalberg was amiable, conscientious and large-hearted. Himself a scholar and author, he was a notable patron of letters, and was the friend of Goethe, Schiller and Wieland.

See Karl v. Beaulieu-Marconnay, *Karl von Dalberg und seine Zeit* (Weimar, 1879).

3. WOLFGANG HERIBERT VON DALBERG (1750-1806), brother of the above. He was intendant of the theatre at Mannheim, which he brought to a high state of excellence. His chief claim to remembrance is that it was he who first put Schiller's earlier dramas on the stage, and it is to him that the poet's *Briefe an den Freiherrn von Dalberg* (Karlsruhe, 1819) are addressed. He himself wrote several plays, including adaptations of Shakespeare. His brother, Johann Friedrich Hugo von Dalberg (1752-1812), canon of Trier, Worms and Spire, had some vogue as a composer and writer on musical subjects.

4. EMMERICH JOSEPH, DUC DE DALBERG (1773-1833), son of Baron Wolfgang Heribert. He was born at Mainz on the 30th of May 1773. In 1803 he entered the service of Baden, which he represented as envoy in Paris. After the peace of Schönbrunn (1809) he entered the service of Napoleon, who, in 1810, created him a duke and councillor of state. He had from the first been on intimate terms with Talleyrand, and retired from the public service when the latter fell out of the emperor's favour. In 1814 he was a member of the provisional government by whom the Bourbons were recalled, and he attended the congress of Vienna, with Talleyrand, as minister plenipotentiary. He appended his signature to the decree of outlawry launched in 1815 by the European powers against Napoleon. For this his property in France was confiscated, but was given back after the second Restoration, when he became a minister of state and a peer of France. In 1816 he was sent as ambassador to Turin. The latter years of his life he spent on his estates at Herrnsheim, where he died on the 27th of April 1833.

The duc de Dalberg had inherited the family property of Herrnsheim from his uncle the arch-chancellor Karl von Dalberg, and this estate passed, through his daughter and heiress, Marie Louise Peline de Dalberg, by her marriage with Sir (Ferdinand) Richard Edward Acton, 7th baronet (who assumed the additional name of Dalberg), to her son the historian, John Emerich Edward Dalberg-Acton, 1st Baron Acton (q.v.).

DALE, ROBERT WILLIAM (1829-1895), English Nonconformist divine, was born in London on the 1st of December 1829, and was educated at Spring Hill College, Birmingham, for the Congregational ministry. In 1853 he was invited to Carr's Lane Chapel, Birmingham, as co-pastor with John Angell James (q.v.), on whose death in 1859 he became sole pastor for the rest of his life. In the London University M.A. examination (1853) Dale stood first in philosophy and won the gold medal. The degree of LL.D. was conferred upon him by the university of Glasgow during the lord rectorship of John Bright. Yale University gave him its D.D. degree, but he never used it, "not because it came from America, but because I have a sentimental objection—perhaps it is something more—to divinity degrees." Dale displayed a keen interest in Liberal politics and in the municipal affairs of Birmingham; and his high moral ideal made him a great force on the progressive side. In 1886 he adhered to Mr Chamberlain in opposition to Irish Home Rule, but this difference did not diminish his influence even among those Liberals and Nonconformists who adopted the Gladstonian standpoint. In the education controversy of 1870 he took an important part, ably championing the Nonconformist position. When Mr Foster's bill appeared, Dale attacked it on the grounds that the schools would in many cases be purely

denominational institutions, that the conscience clause gave inadequate protection, and that school boards were empowered by it to make grants out of the rates to maintain sectarian schools. He was himself in favour of secular education, claiming that it was the only logical solution and the only legitimate outcome of Nonconformist principles. In Birmingham the controversy was terminated in 1879 by a compromise, from which, however, Dale stood aloof. His interest in educational affairs had led him to accept a seat on the Birmingham school board. He was appointed a governor of the grammar school, served on the royal commission of education, and was also chairman of the council of Mansfield College, Oxford, with the foundation of which he had much to do. He was a strong advocate of disestablishment, holding that the church was essentially a spiritual brotherhood, and that any vestige of political authority impaired its spiritual work. In church polity he held that congregationalism constituted the most fitting environment in which religion could achieve her work. Perhaps the most effective contributions he made to ecclesiastical literature were those dealing with the history and principles of the congregational system. At his death on the 13th of March 1895 he left an unfinished MS. of the history of congregationalism, since edited and completed (1907) by his son, A. W. W. Dale, principal of Liverpool University.

Dale's powers were fully appreciated by his colleagues in the congregational ministry, and at the early age of thirty-nine he was elected chairman of the Congregational union of England and Wales. His addresses from the chair on "Christ and the Controversies of Christendom," and the "Holy Spirit and the Christian Ministry" were remarkable for a keen insight into the conditions and demands of the age. For some years he edited the *Congregationalist*, a monthly magazine connected with the denomination. In 1877 he was appointed Lyman Beecher lecturer at Yale University, and visited America to deliver his "Lectures on Preaching." At the International Council of Congregationalists, meeting in London in 1891, the first gathering of the kind, Dale was nominated for the presidency. He accepted the honour and delivered an address on "The Divine Life in Man."

As a theologian Dale occupied an influential position amongst the religious thinkers of the 19th century. He ably interpreted the Evangelical thought of his age, but his Evangelicalism was of a broad and progressive type. His chief contribution to constructive theological thought is his work *On The Atonement*, in which he contends that the death of Christ is the objective ground on which the sins of man were remitted. Among his other theological books are: *The Epistle to the Ephesians* (a series of expositions), *Christian Doctrine*, *The Living Christ and the Four Gospels*, *Fellowship with Christ*, *The Epistle to James*, and *The Ten Commandments*.

DALE, SIR THOMAS (d. 1619), British naval commander and colonial deputy-governor of Virginia. From about 1588 to 1609 he was in the service of the Low Countries with the English army originally under Robert Dudley, earl of Leicester; in 1606, while visiting in England, he was knighted by King James; from 1611 to 1616 he was actually though not always nominally in chief control of the province of Virginia either as deputy-governor or as "high marshal," and he is best remembered for the energy and the extreme rigour of his administration there, which established order and in various ways seems to have benefited the colony; he himself declared that he left it "in great prosperity and peace." Under him began the first real expansion of the colony with the establishment of the settlement of Henrico on and about what was later known as Farrar's Island; it was he who, about 1614, took the first step toward abolishing the communal system by the introduction of private holdings, and it was during his administration that the first code of laws of Virginia, nominally in force from 1610 to 1619, was effectively tested. This code, entitled "Articles, Lawes, and Orders—Divine, Politique, and Martiall," but popularly known as Dale's Code, was notable for its pitiless severity, and seems to have been prepared in large part by Dale himself. He left Virginia in 1616

with the intention probably of returning to the service of the Low Countries, but instead was given command of an English fleet sent against the Dutch, defeated the enemy near Batavia in the East Indies late in the year 1618, arrived at Masulipatam in July 1619, and died there on the 9th of the following month.

An account of Dale's career in Virginia is given in Alexander Brown's *The First Republic in America* (Boston, 1898); a scholarly discussion of "Dale's Code" by Walter F. Prince may be found in vol. i. of the *Annual Report of the American Historical Association* for 1899 (Washington, D.C., 1900), and the code itself is reprinted in Peter Force's *Historical Tracts*, vol. iii., No. 11.

**DALECARLIA** (*Dalarne*, "the Dales"), a west midland region of Sweden, virtually coincident with the district (*län*) of Kopparberg, which extends from the mountains of the Norwegian frontier to within 25 m. of Gefle on the Baltic coast. It is a region full of historical associations, and possesses strong local characteristics in respect of its products, and especially of its people. The Dalecarlians or Dalesmen speak their own peculiar dialect, wear their own peculiar costumes, and are famed for their brave spirit and sturdy love of independence. In 1434, led by Engelbrecht, the miner, they rose against the oppressive tyranny of the officers of Eric XIV. of Denmark, and in 1519-1523 it was among them that Gustavus Vasa found his staunchest supporters in his patriotic task of freeing Sweden from the yoke of the Danes. The districts around Lakes Runn and Siljan ("the Eye of the Dales"), the principal sheets of water in the valleys of the Dal rivers, are consequently classic ground. By the banks of Lake Runn, for example, is seen the barn in which Vasa threshed corn in disguise, when still a fugitive from the Danes. The people are for the most part small peasant proprietors. They eke out their scanty returns from tilling the soil by a variety of home industries, such as making scythes, saws, bells, wooden wares, hair goods, and so forth. About three quarters of the whole district is covered with forest. Besides the wealth of the forests, the Dales contain some of the largest and most prolific iron mines in Sweden, notably those of Grängesberg. Copper is mined at Falun (*q.v.*), the chief town of Kopparberg, and some silver and lead, zinc and sulphur is found. In consequence of this the district has numerous smelting furnaces, blasting and rolling mills, iron and metallurgical works, as well as saw-mills, wood-pulp factories, and chemical works.

See G. H. Mellin, *Skildringar af den Skandinaviska Nordens Folklif og Natur*, vol. iii. (1865); and Frederika Bremer, *I Dalarne* (1845), of which there is an English translation by William and Mary Howitt (1852). For the dialect, see a paper by A. Noreen, in *De Svenska Landsmålen*, vol. iv. (1881).

**DALGAIKNS, JOHN DOBREE** (1818-1876), English Roman Catholic priest, was born in Guernsey on the 21st of October 1818. About the age of seventeen he entered Exeter College, Oxford, and soon after taking his degree he contributed a letter to Louis Veillot's ultramontane organ *L'Univers*, on "Anglican Church Parties," which gave him considerable repute. Together with Mark Pattison and others, he translated the *Catena aurea* of St Thomas Aquinas, a commentary on the Gospels, taken from the works of the Fathers. He was a contributor to Newman's *Lives of the English Saints*, for which he wrote the beautiful studies on the Cistercian Saints. *The Life of St Stephen Harding* has been translated into several languages. Dalgairns became a Roman Catholic in 1845, and was ordained priest in the following year. He joined his friend John Henry Newman in Rome, and, together with him, entered the Congregation of the Oratory. On his return to England in 1848, he was attached to the London Oratory, where he laboured successfully as a priest, with the exception of three years spent in Birmingham. Dalgairns was a prominent member of the well-known "Metaphysical Society." He died at Burgess Hill, near Brighton, on the 6th of April 1876. During the Catholic period of his life, Dalgairns wrote *The Devotion to the Sacred Heart of Jesus, with an Introduction on the History of Jansenism* (London 1853); *The German Mystics of the Fourteenth Century* (London, 1858); *The Holy Communion, its Philosophy, Theology and Practice* (Dublin, 1861).

A list of his contributions on religious and philosophical subjects, to the reviews and periodicals, is given in J. Gillow's *Bibliographical Dictionary of English Catholics*, vol. ii.

**DALGARNO, GEORGE** (c. 1626-1687), English writer, was born at Old Aberdeen about 1626. He appears to have studied at Marischal College; but he finally settled in Oxford, where, according to Wood, "he taught a private grammar-school with good success for about thirty years," and where he died on the 28th of August 1687. He was master of Elizabeth school, Guernsey, for some ten years, but resigned in 1672. In his work entitled *Didascalocophus, or the Deaf and Dumb Man's Tutor* (Oxford, 1680), he explained, for the first time, the hand alphabet for the deaf and dumb, though he does not claim to have invented this method of communication. Twenty years before the publication of his *Didascalocophus*, Dalgarno had given to the world a very ingenious piece entitled *Ars Signorum* (1661), dividing ideas into seventeen classes, to be represented by the letters of the Latin alphabet with the addition of two Greek characters. Among the Sloane manuscripts are several tracts by Dalgarno, further elucidating his system of universal shorthand. Leibnitz on various occasions alluded to the *Ars signorum* in commendatory terms.

The chief works of Dalgarno were reprinted (1834) for the Maitland Club.

**DALHOUSIE, JAMES ANDREW BROWN RAMSAY, 1ST MARQUESS AND 10TH EARL OF** (1812-1860), British statesman and Indian administrator, was born at Dalhousie Castle, Scotland, on the 22nd of April 1812. He crowded into his short life conspicuous public services in England, and established an unrivalled position among the master-builders of the Indian empire. Denounced on the eve of his death as the chief offender who failed to notice the signs of the mutiny of 1857, and even aggravated the crisis by his overbearing self-consciousness, centralizing activity and reckless annexations, he stands out in the clear light of history as the far-sighted governor-general who consolidated British rule in India, laid truly the foundations of its later administration, and by his sound policy enabled his successors to stem the tide of rebellion.

He was the third son of George Ramsay, 9th earl of Dalhousie (1770-1838), one of Wellington's generals, who, after holding the highest offices in Canada, became commander-in-chief in India, and of his wife Christina Broun of Coalstoun, a lady of noble lineage and distinguished gifts. From his father he inherited a vigorous self-reliance and a family pride which urged him to prove worthy of the Ramsays who had "not crawled through seven centuries of their country's history," while to his mother he owed his high-bred courtesy and his deeply seated reverence for religion. The Ramsays of Dalhousie (or Dalwolsie) in Midlothian were a branch of the main line of Scottish Ramsays, of whom the earliest known is Simon de Ramsay, of Huntingdon, England, mentioned in 1140 as the grantee of lands in West Lothian at the hands of David I. A Sir William de Ramsay of Dalhousie swore fealty to Edward I. in 1296, but is famous for having in 1320 signed the letter to the pope asserting the independence of Scotland; and his supposed son, Sir Alexander Ramsay (d. 1342), was the Scottish patriot and capturer of Roxburgh Castle (1342), who, having been made warder of the castle and sheriff of Teviotdale by David II., was soon afterwards carried off and starved to death by his predecessor, the Douglas, in revenge. Sir John Ramsay of Dalhousie (1580-1626), James VI.'s favourite, is famous for rescuing the king in the Gowrie conspiracy, and was created (1606) Viscount Haddington and Lord Ramsay of Barns (subsequently baron of Kingston and earl of Holderness in England). The barony of Ramsay of Melrose was granted in 1618 to his brother George Ramsay of Dalhousie (d. 1629), whose son William Ramsay (d. 1674) was made 1st earl of Dalhousie in 1633.

The 9th earl was in 1815 created Baron Dalhousie in the peerage of the United Kingdom, and had three sons, the two elder of whom died early. His youngest son, the subject of this article, was small in stature, but his firm chiselled mouth, high forehead and masterful manner intimated a dignity that none could overlook. Yet his early life gave little promise of the dominating force of his character or of his ability to rise to the full height of his splendid opportunities. Nor did those brought

into closest intimacy with him, whether at school or at Oxford, suspect the higher qualities of statesmanship which afterwards established his fame on so firm a foundation.

Several years of his early boyhood were spent with his father and mother in Canada, reminiscences of which were still vivid with him when governor-general of India. Returning to Scotland he was prepared for Harrow, where he entered in 1825. Two years later he was removed from school, his entire education being entrusted to the Rev. Mr Temple, incumbent of a quiet parish in Staffordshire. To this gentleman he referred in later days as having taught him all he knew, and to his training he must have owed those habits of regularity and that indomitable industry which marked his adult life. In October 1829 he passed on to Christ Church, Oxford, where he worked fairly hard, won some distinction, and made many lifelong friends. His studies, however, were so greatly interrupted by the protracted illness and death in 1832 of his only surviving brother, that Lord Ramsay, as he then became, had to content himself with entering for a "pass" degree, though the examiners marked their appreciation of his work by placing him in the fourth class of honours for Michaelmas 1833. He then travelled in Italy and Switzerland, enriching with copious entries the diary which he religiously kept up through life, and storing his mind with valuable observations.

An unsuccessful but courageous contest at the general election in 1835 for one of the seats in parliament for Edinburgh, fought against such veterans as the future speaker, James Abercrombie, afterwards Lord Dunfermline, and John Campbell, future lord chancellor, was followed in 1837 by Ramsay's return to the House of Commons as member for East Lothian. In the previous year he had married Lady Susan Hay, daughter of the marquess of Tweeddale, whose companionship was his chief support in India, and whose death in 1853 left him a heartbroken man. In 1838 his father had died after a long illness, while less than a year later he lost his mother.

Succeeding to the peerage, the new earl soon made his mark in a speech delivered on the 16th of June 1840 in support of Lord Aberdeen's Church of Scotland Benefices Bill, a controversy arising out of the Auchterarder case, in which he had already taken part in the "general assembly" in opposition to Dr Chalmers. In May 1843 he became vice-president of the board of trade, Gladstone being president, and was sworn in as a member of the privy council. Succeeding Gladstone as president in 1845, he threw himself into the work during the crisis of the railway mania with such energy that his health partially broke down under the strain. In the struggle over the corn laws he ranged himself on the side of Sir Robert Peel, and after the failure of Lord John Russell to form a ministry he resumed his post at the board of trade, entering the cabinet on the retirement of Lord Stanley. When Peel resigned office in June 1846, Lord John offered Dalhousie a seat in the cabinet, an offer which he declined from a fear that acceptance might "involve the loss of public character." Another attempt to secure his services in the appointment of president of the railway board was equally unsuccessful; but in 1847 he accepted the post of governor-general of India in succession to Lord Hardinge, on the understanding that he was to be left in "entire and unquestioned possession" of his own "personal independence with reference to party politics."

Dalhousie assumed charge of his dual duties as governor-general of India and governor of Bengal on the 12th of January 1848, and shortly afterwards he was honoured with the green ribbon of the Order of the Thistle. In writing to the president of the board of control, Sir John Hobhouse, he was able to assure him that everything was quiet. This statement, however, was to be falsified by events almost before it could reach England. For on the 19th of April Vans Agnew of the civil service and Lieutenant Anderson of the Bombay European regiment, having been sent to take charge of Multan from Diwan Mulraj, were murdered there, and within a short time the Sikh troops and sardars joined in open rebellion. Dalhousie agreed with Sir Hugh Gough, the commander-in-chief, that the Company's

military forces were neither adequately equipped with transport and supplies, nor otherwise prepared to take the field immediately. He also foresaw the spread of the rebellion, and the necessity that must arise, not merely for the capture of Multan, but also for the entire subjugation of the Punjab. He therefore resolutely delayed to strike, organized a strong army for operations in November, and himself proceeded to the Punjab. Despite the brilliant successes gained by Herbert Edwardes in conflict with Mulraj, and Gough's indecisive victories at Ramnagar in November, at Sadulapur in December, and at Chillianwalla in the following month, the stubborn resistance at Multan showed that the task required the utmost resources of the government. At length, on the 22nd of January 1849, the Multan fortress was taken by General Whish, who was thus set at liberty to join Gough at Gujrat. Here a complete victory was won on the 21st of February, the Sikh army surrendered at Rawal Pindi, and their Afghan allies were chased out of India. For his services the earl of Dalhousie received the thanks of parliament and a step in the peerage, as marquess.

The war being now over, Dalhousie, without waiting for instructions from home, annexed the Punjab, and made provision for the custody and education of the infant maharaja. For the present the province was administered by a triumvirate under the personal supervision of the governor-general, and later, a place having been found for Henry Lawrence in Rajputana, by John Lawrence as sole commissioner. Twice did Dalhousie tour through its length and breadth, settling on the spot all matters of importance, and when he left India no province could show a better record of progress.

One further addition to the empire was made by conquest. The arrogant Burmese court at Ava was bound by the treaty of Yandabo, 1826, to protect British ships in Burmese waters, but the outrageous conduct of the governor of Rangoon towards the masters of the "Monarch" and "Champion" met with no redress from the king. Dalhousie adopted the maxim of Lord Wellesley "that an insult offered to the British flag at the mouth of the Ganges should be resented as promptly and fully as an insult offered at the mouth of the Thames"; but, anxious to save the cost of war, he tried to settle the dispute by diplomacy. When that failed he made vigorous preparation for the campaign to be undertaken in the autumn, giving his attention to the adequate provision of rations, boat transport, and medical supplies, composing differences between the military contingents from Bengal and Madras, and between the military and naval forces employed, and conferring with General Godwin whom he had chosen to command the expedition. Martaban was taken on the 5th of April 1852, and Rangoon and Bassein shortly afterwards. Since, however, the court of Ava showed no sign of submission, the second campaign opened in October, and after the capture of Prome and Pegu the annexation of the province of Pegu was declared by a proclamation dated the 20th of December 1853. To any further invasion of the Burmese empire Dalhousie was firmly opposed, being content to "consolidate" the Company's possessions by uniting Arakan to Tenasserim. By his wise policy he pacified the new province, placing Colonel Arthur Phayre in sole charge of it, personally visiting it, and establishing a complete system of telegraphs and communications.

These military operations added force to the conviction which Dalhousie had formed of the need of consolidating the Company's ill-knit possessions, and as a step in that direction he decided to apply the doctrine of "lapse," and annex any Hindu native states, created or revived by the grants of the British government, in which there was a failure of male lineal descendants, reserving for consideration the policy of permitting adoptions in other Hindu chiefships tributary and subordinate to the British government as paramount. Under the first head he recommended the annexation of Satara in January 1849, of Jaitpur and Sambalpur in the same year, and of Jhansi and Nagpur in 1853. In these cases his action was approved by the home authorities, but his proposal to annex Karauli in 1849 was disallowed, while Baghat and the petty estate of Udaipur, which he had annexed in 1851 and 1852 respectively, were afterwards restored to native rule.



Other measures with the same object were carried out in the Company's own territories. Bengal, too long ruled by the governor-general or his delegate, was placed under a separate lieutenant-governor in May 1854; a department of public works was established in each presidency, and engineering colleges were provided. An imperial system of telegraphs followed; the first link of railway communication was completed in 1855; well-considered plans mapped out the course of other lines and their method of administration; the Ganges canal, which then exceeded "all the irrigation lines of Lombardy and Egypt together," was completed; and despite the cost of wars in the Punjab and Burma, liberal provision was made for metalled roads and bridges. The useless military boards were swept away; selection took the place of seniority in the higher commands; an army clothing and a stud department were created, and the medical service underwent complete reorganization.

"Unity of authority coupled with direct responsibility" was the keynote of his policy. In nine masterly minutes he suggested means for strengthening the Company's European forces, calling attention to the dangers that threatened the English community, "a handful of scattered strangers"; but beyond the additional powers of recruitment which at his entreaty were granted in the last charter act of 1853, his proposals were shelved by the home authorities, who scented no danger and wished to avoid expense. In his administration Dalhousie vigorously asserted the control of the civil government over military affairs, and when Sir Charles Napier ordered certain allowances, given as compensation for the dearth of provisions, to be granted to the sepoys on a system which had not been sanctioned from headquarters, and threatened to repeat the offence, the governor-general found it necessary to administer such a rebuke that the hot-headed soldier resigned his command.

Dalhousie's reforms were not confined to the departments of public works and military affairs. He created an imperial system of post-offices, reducing the rates of carrying letters and introducing postage stamps. To him India owes the first department of public instruction; it was he who placed the gaols under proper inspection, abolishing the practice of branding convicts; put down the crime of *meriahs* or human sacrifices; freed converts to other religions from the loss of their civil rights; inaugurated the system of administrative reports; and enlarged and dignified the legislative council of India. His wide interest in everything that concerned the welfare of the country was shown in the encouragement he gave to the culture of tea, in his protection of forests, in the preservation of ancient and historic monuments. With the object of improving civil administration, he closed the useless college in Calcutta for the education of young civilians, establishing in its place a proper system of training them in *mufasal* stations, and subjecting them to departmental examinations. He was equally careful of the well-being of the European soldier, providing him with healthy recreations and public gardens. To the civil service he gave improved leave and pension rules, while he purified its *moral* by forbidding all share in trading concerns, by vigorously punishing insolvents, and by his personal example of careful selection in the matter of patronage. As a comprehensive view of the constitution of the Indian government, dealing with the functions of its various members and the different parts of the official machinery, nothing could be more masterly than his minute of the 13th of October 1852. Indeed no governor-general ever penned a larger number of weighty papers dealing with public affairs in India. Even after laying down office and while on his way home, he forced himself, ill as he was, to review his own administration in a document of such importance that the House of Commons gave orders for its being printed (Blue Book 245 of 1856).

His foreign policy was guided by a desire to recognize the "independence" of the larger native states, and to avoid extending the political relations of his government with foreign powers outside India. Pressed to intervene in Hyderabad, he refused to do so, laying down the doctrine that interference was

only justified "if the administration of native princes tends unquestionably to the injury of the subjects or of the allies of the British government." Protection in his view carried no right of interference in the affairs of what he called "independent" states. In this spirit he negotiated in 1853 a treaty with the nizam, which provided funds for the maintenance of the contingent kept up by the British in support of that prince's authority, by the assignment of the Berars in lieu of annual payments of the cost and large outstanding arrears. "The Berar treaty," he told Sir Charles Wood, "is more likely to keep the nizam on his throne than anything that has happened for fifty years to him," while at the same time the control thus acquired over a strip of territory intervening between Bombay and Nagpur promoted his policy of consolidation and his schemes of railway extension. The same spirit induced him to tolerate a war of succession in Bahawalpur, so long as the contending candidates did not violate British territory. This reluctance to increase his responsibilities further caused him to refrain from punishing Dost Mahomed for the part he had taken in the Sikh War, and resolutely to refuse to enter upon any negotiations until the amir himself came forward. Then he steered a middle course between the proposals of his own agent, Herbert Edwardes, who advocated an offensive alliance, and those of John Lawrence, who would have avoided any sort of engagement. He himself drafted the short treaty of peace and friendship which Lawrence signed in 1855, that officer receiving in 1856 the order of K.C.B. in acknowledgment of his services in the matter. While, however, Dalhousie was content with a mutual engagement with the Afghan chief, binding each party to respect the territories of the other, he saw that a larger measure of interference was needed in Baluchistan, and with the khan of Kalat he authorized Major Jacob to negotiate a treaty of subordinate co-operation on the 14th of May 1854. The khan was guaranteed an annual subsidy of Rs. 50,000, in return for the treaty which "bound him to us wholly and exclusively." To this the home authorities demurred, but the engagement was duly ratified, and the subsidy was largely increased by Dalhousie's successors. On the other hand, he insisted on leaving all matters concerning Persia and Central Asia to the decision of the queen's advisers. The frontier tribesmen it was obviously necessary to coerce into good behaviour after the annexation of the Punjab. "The hillmen," he wrote, "regard the plains as their food and prey," and the Afridis, Mohmands, Black Mountain tribes, Waziris and others had to be taught that their new neighbours would not tolerate outrages. But he proclaimed to one and all his desire for peace, and urged upon them the duty of tribal responsibility.

The settlement of the Oudh question was reserved to the last. The home authorities had begged Dalhousie to prolong his tenure of office during the Crimean War, but the difficulties of the problem no less than complications elsewhere had induced him to delay operations. In 1854 he appointed Outram as resident at the court of Lucknow, directing him to submit a report on the condition of the province. This was furnished in March 1855. But though the state of disorder and misrule revealed by it called for prompt remedy, Dalhousie, looking at the treaty of 1801, considered that he was bound to proceed in the matter of reform with the king's consent. He proposed, therefore, to demand a transfer to the Company of the entire administration, the king merely retaining his royal rank, certain privileges in the courts, and a liberal allowance. If he should refuse this arrangement, a general rising was almost certain to follow, and then the British government would of necessity intervene on its own terms. On the 21st of November 1855 the court of directors instructed Dalhousie to assume the powers essential to the permanence of good government in Oudh, and to give the king no option unless he was sure that his majesty would surrender the administration rather than risk a revolution. Dalhousie was in wretched health and on the eve of retirement when the belated orders reached him; but he at once laid down instructions for Outram in every detail, moved up troops, and elaborated a scheme of government with particular orders as to conciliating local opinion. The king refused to sign the treaty put before

him, and a proclamation annexing the province was therefore issued on the 13th of February 1856.

Only one important matter now remained to him before quitting office. The insurrection of the half-civilized Kolarian Santals of Bengal against the extortions of landlords and money-lenders had been severely repressed, but the causes of the insurrection had still to be reviewed and a remedy provided. By removing the tract of country from the ordinary regulations, enforcing the residence of British officers there, and employing the Santal headmen in a local police, he ensured a system of administration which afterwards proved eminently successful.

At length, after seven years of strenuous labour, Dalhousie, on the 6th of March 1856, set sail for England on board the Company's "Firoze," an object of general sympathy and not less general respect. At Alexandria he was carried by H.M.S. "Caradoc" to Malta, and thence by the "Tribune" to Spithead, which he reached on the 13th of May. His return had been eagerly looked for by statesmen who hoped that he would resume his public career, by the Company which voted him an annual pension of £5000, by public bodies which showered upon him every mark of respect, and by the queen who earnestly prayed for the "blessing of restored health and strength." That blessing was not to be his. He lingered on, seeking sunshine in Malta and medical treatment at Malvern, Edinburgh and other places in vain obedience to his doctors. The outbreak of the mutiny led to bitter attacks at home upon his policy, and to strange misrepresentation of his public acts, while on the other hand John Lawrence invoked his counsel and influence, and those who really knew his work in India cried out, "Oh, for a dictator," and his return "for one hour!" To all these cries he turned a deaf ear, refusing to embarrass those who were responsible by any expressions of opinion, declining to undertake his own defence or to assist in his vindication through the public press, and by his last directions sealing up his private journal and papers of personal interest against publication until fifty years after his death. On the 9th of August 1859 his youngest daughter, Edith, was married at Dalhousie Castle to Sir James Fergusson, Bart. In the same castle Dalhousie died on the 10th of December 1860; he was buried in the old churchyard of Cockpen.

Dalhousie's family consisted of two daughters, and the marquessate became extinct at his death.

The detailed events of the period will be found in Sir William Lee-Warner's *Life of the Marquis of Dalhousie, K.T.*; Sir E. Arnold's *Dalhousie's Administration of British India*; Sir C. Jackson's *Vindication of Dalhousie's Indian Administration*; Sir W. W. Hunter's *Dalhousie*; Capt. L. J. Trotter's *Life of the Marquis of Dalhousie*; the duke of Argyll's *India under Dalhousie and Canning*; Broughton MSS. (British Museum); and parliamentary papers.

(W. L.-W.)

**DALHOUSIE, FOX MAULE RAMSAY**, 11th EARL OF (1801-1874), was the eldest son of William Ramsay Maule, 1st Baron Panmure (1771-1852), and a grandson of George, 8th earl of Dalhousie. Born on the 22nd of April 1801 and christened Fox as a compliment to the great Whig, he served for a term in the army, and then in 1835 entered the House of Commons as member for Perthshire. In Lord Melbourne's ministry (1835-1841) Maule was under-secretary for home affairs, and under Lord John Russell he was secretary-at-war from July 1846 to January 1852, when for two or three weeks he was president of the board of control. In April 1852 he became the 2nd Baron Panmure, and early in 1855 he joined Lord Palmerston's cabinet, filling the new office of secretary of state for war. Panmure held this office until February 1858, being at the war office during the concluding period of the Crimean War and having to meet a good deal of criticism, some of which was justified and some of which was not. In December 1860 he succeeded his kinsman, the marquis of Dalhousie, as 11th earl of Dalhousie, and he died childless on the 6th of July 1874. Always interested in church matters, Dalhousie was a prominent supporter of the Free Church of Scotland after the disruption of 1843. On his death the barony became extinct, but his earldom passed to his cousin, George Ramsay (1806-1880), an admiral who, in 1875, was created a

peer of the United Kingdom as Baron Ramsay. George's grandson, Arthur George Maule Ramsay (b. 1878), became the 14th earl in 1887.

\* See the *Panmure Papers*, a selection from Panmure's correspondence, edited in two volumes (1908), by Sir G. Douglas, Bart., and Sir G. D. Ramsay. These numerous letters throw much light on the concluding stage of the Crimean War.

**DALIN, OLOF VON** (1708-1763), Swedish poet, was born on the 29th of August 1708 in the parish of Vinberg in Halland, where his father was the minister. He was nearly related to Rydelius, the philosophical bishop of Lund, and he was sent at a very early age to be instructed by him, Linnaeus being one of his fellow-pupils. While studying at Lund, Dalin had visited Stockholm in the year 1723, and in 1726 entered one of the public offices there. Under the patronage of Baron Rålamb he rapidly rose to preferment, and his skill and intelligence won him golden opinions. In 1733 he started the weekly *Svenska Argus*, on the model of Addison's *Spectator*, writing anonymously till 1736. His next work was *Tankar öfver Critiquer* (Thoughts about Critics, 1736). With the avowed purpose of enlarging the horizon of his cultivation and tastes, Dalin set off, in company with his pupil, Baron Rålamb's son, on a tour through Germany and France, in 1739-1740. On his return the shifting of political life at home caused him to write his famous satiric allegories of *The Story of the Horse* and *Aprilverk* (1738), which were very popular and provoked countless imitations. His didactic epos of *Svenska Friheten* (Swedish Liberty) appeared in 1742. Hitherto Addison and Pope had been his models; in this work he draws his inspiration from Thomson, whose poem of *Liberty* it emulated. On the accession of Adolphus Freduck in 1751 Dalin received the post of tutor to the crown prince, afterwards Gustavus III. He had enjoyed the confidence of Queen Louisa Ulrika, sister of Frederick the Great of Germany, while she was crown princess, and she now made him secretary of the Swedish academy of literature, founded by her in 1753. His position at court involved him in the queen's political intrigues, and separated him to a vexatious degree from the studies in which he had hitherto been absorbed. He held the post of tutor to the crown prince until 1756, when he was arrested on suspicion of having taken part in the attempted *coup d'état* of that year, and was tried for his life before the diet. He was acquitted, but was forbidden on any pretence to show himself at court. This period of exile, which lasted until 1761, Dalin spent in the preparation of the third volume of his great historical work, the *Svea Rikes historia* (History of the Swedish Kingdom), which came down to the death of Charles IX. in 1611. The first two volumes appeared in 1746-1750; the third, in two parts, in 1760-1762. Dalin had been ennobled in 1751, and made privy councillor in 1753; and now, in 1761, he once more took his place at court. During his exile, however, his spirit and his health had been broken; in a fit of panic he had destroyed some packets of his best unpublished works and this he constantly brooded over. On the 12th of August 1763 he died at his house in Drottningholm. In the year 1767 his writings in *belles lettres* were issued in six volumes, edited by J. C. Bökman, his half-brother. Amid an enormous mass of occasional verses, anagrams, epigrams, impromptus and the like, his satires and serious poems were almost buried. But some of these former, even, are found to be songs of remarkable grace and delicacy, and many display a love of natural scenery and a knowledge of its forms truly remarkable in that artificial age. His dramas also are of interest, particularly his admirable comedy of *Den afundsjuke* (The Envious Man, 1738); he also wrote a tragedy, *Brynilda* (1739), and a pastoral in three scenes on King Adolphus Frederick's return from Finland. During the early part of his life he was universally admitted to be *facile princeps* among the Swedish poets of his time.

See also K. Warburg, "Olof von Dalin," in the *Handlingar* (vol. lix., 1884) of the Swedish Academy. A selection of his works was edited by E. V. Lindblad (Örebro, 1872).

**DALKEITH**, a municipal and police burgh of Edinburghshire, Scotland, lying between the North and South Esk, 7½ m. S.E.

of Edinburgh, by the North British railway. Pop. (1891) 7035; (1901) 6812. It is an important agricultural centre, and has every week one of the largest grain-markets in Scotland. Besides milling, brewing and tanning, the chief industries are the making of carpets, brushes and bricks, and iron and brass founding. Near Eskbank, a handsome residential quarter with a railway station, coal-mining is carried on. Market-gardening, owing to the proximity of the capital, flourishes. The parish church—an old Gothic edifice, which was originally the Castle chapel, and was restored in 1852—the municipal buildings, corn exchange, Foresters' hall and Newmills hospital are among the principal public buildings. Dalkeith was the birthplace of Professor Peter Guthrie Tait, the mathematician (1831-1901). Dalkeith Palace, a seat of the duke of Buccleuch, was designed by Sir John Vanbrugh in 1700 for the widow of the duke of Monmouth, countess of Buccleuch in her own right. It occupies the site of a castle which belonged first to the Grahams and afterwards to the Douglasses, and was sold in 1642 by William, seventh or eighth earl of Morton, to Francis, second earl of Buccleuch, for the purpose of raising money to assist Charles I. in the Civil War. The palace has been the residence of several sovereigns during their visits to Edinburgh, among them George IV. in 1822, Queen Victoria in 1842, and Edward VII. in 1903. The picture gallery possesses important examples of the Old Masters; the gardens are renowned for their fruit and flowers; and the beautiful park of over 1000 acres—containing a remnant of the Caledonian Forest, with oaks, beeches and ashes of great girth and height—is watered by the North and South Esk, which unite before they leave the policy. About 1 m. south is Newbattle Abbey, the seat of the marquess of Lothian, delightfully situated on the South Esk. It is built on the site of an abbey founded by David I., the ancient crypt being incorporated in the mansion. The library contains many valuable books and illuminated MSS., and excellent pictures and carvings. In the park are several remarkable trees, among them one of the largest beeches in the United Kingdom. Two miles still farther south lies Cockpen, immortalized by the Baroness Nairne's humorous song "The Laird of Cockpen," and Dalhousie Castle, partly ancient and partly modern, which gives a title to the earls of Dalhousie. About 6 m. south-east of Dalkeith are Borthwick and Crichton castles, 1 m. apart, both now in ruins. Queen Mary spent three weeks in Borthwick Castle, as in durance vile, after her marriage with Bothwell, and fled from it to Dunbar in the guise of a page. The castle, which is a double tower, was besieged by Cromwell, and the marks of his cannon-balls are still visible. In the manse of the parish of Borthwick, William Robertson, the historian, was born in 1721. About 4 m. west of Dalkeith is the village of Burdiehouse, the limestone quarries of which are famous for fossils. The name is said to be a corruption of Bordeaux House, which was bestowed on it by Queen Mary's French servants, who lived here when their mistress resided at Craigmillar.

**DALKEY**, a small port and watering-place of Co. Dublin, Ireland, in the south parliamentary division, 9 m. S.E. of Dublin by the Dublin & South-Eastern railway. Pop. of urban district (1901), 3398. It is pleasantly situated on and about Sorrento Point, the southern horn of Dublin Bay. Dalkey Island, lying off the town, has an ancient ruined chapel, of the history of which nothing is certainly known, and a disused battery, which protected the harbour, a landing-place of some former importance. A castle in the town, of the 15th century, is restored to use as offices for the urban district council. There are also ruins of an old church, the dedication of which, like the island chapel, is ascribed to one St Begnet, perhaps a diminutive form of Bega, but the identity is not clear. Until the close of the 18th century Dalkey was notorious for the burlesque election of a "king," a mock ceremony which became invested with a certain political importance.

**DALLAS, ALEXANDER JAMES** (1759-1817), American statesman and financier, was born on the island of Jamaica, West Indies, on the 21st of June 1759, the son of Dr Robert C. Dallas (d. 1774), a Scottish physician then practising there.

Dr Dallas soon returned to England with his family, and Alexander was educated at Edinburgh and Westminster. He studied law for a time in the Inner Temple, and in 1780 returned to Jamaica. There he met the younger Lewis Hallam (1738-1808), a pioneer American theatrical manager and actor, who induced him to remove to the United States, and in 1783 he settled in Philadelphia, where he at once took the oath of allegiance to the United States, was admitted to practise law in 1785, and rapidly attained a prominent position at the bar. He was interested in the theatrical projects of Hallam, for whom he wrote several dramatic compositions, and from 1787 to 1789 he edited *The Columbian Magazine*. From 1791 to 1801 he was secretary of the commonwealth of Pennsylvania. Partly owing to his publication of an able pamphlet against the Jay treaty in 1795, he soon acquired a position of much influence in the Democratic-Republican party in the state. During the Whisky Insurrection he was paymaster-general of the state militia. His official position as secretary did not entirely prevent him from continuing his private law practice, and, with Jared Ingersoll, he was the counsel of Senator William Blount in his impeachment trial. Dallas was United States attorney for the eastern district of Pennsylvania from 1801 until 1814, a period marked by bitter struggles between the Democratic-Republican factions in the state, in which he took a leading part in alliance with Governor Thomas M'Kean and Albert Gallatin, and in opposition to the radical factions led by Michael Leib (1759-1822) and William Duane (1760-1835), of the *Aurora*. The quarrel led in 1805 to the M'Kean party seeking Federalist support. By such an alliance, largely due to the political ingenuity of Dallas, M'Kean was re-elected. In October 1814 President Madison appointed Dallas secretary of the treasury, to succeed George W. Campbell (1768-1848), whose brief and disastrous term had been marked by wholesale bank suspensions, and an enormous depreciation of state and national bank notes. The appointment itself inspired confidence, and Dallas's prompt measures still further relieved the situation. He first issued new interest-bearing treasury notes of small denominations, and in addition proposed the re-establishment of a national bank, by which means he expected to increase the stability and uniformity of the circulating medium, and furnish the government with a powerful engine in the upholding of its credit. In spite of his already onerous duties, Dallas, with characteristic energy, served also as secretary of war *ad interim* from March to August 1815, and in this capacity successfully reorganized the army on a peace footing. Although peace brought a more favourable condition of the money market, Dallas's attempt to fund the treasury notes on a satisfactory basis was unsuccessful, but a bill, reported by Calhoun, as chairman of the committee on national currency, for the establishment of a national bank, became law on the 10th of April 1816. Meanwhile (12th of February 1816) Dallas, in a notable report, recommended a protective tariff, which was enacted late in April, largely in accordance with his recommendation. Although Dallas left the cabinet in October 1816, it was through his efforts that the new bank began its operations in the following January, and specie payments were resumed in February. Dallas, who belonged to the financial school of Albert Gallatin, deserves to rank among America's greatest financiers. He found the government bankrupt, and after two years at the head of the treasury he left it with a surplus of \$20,000,000; moreover, as Henry Adams points out, his measures had "fixed the financial system in a firm groove for twenty years." He retired from office to resume his practice of the law, but the burden of his official duties had undermined his health, and he died suddenly at Philadelphia on the 16th of June 1817. He was the author of several notable political pamphlets and state papers, and in addition edited *The Laws of Pennsylvania, 1700-1801* (1801), and *Reports of Cases ruled and adjudged by the Courts of the United States and of Pennsylvania before and since the Revolution* (4 vols., 1790-1807; new edition with notes by Thomas J. Wharton, 1830). He wrote *An Exposition of the Causes and Character of the War of 1812-15* (1815), which was republished

by government authority in New York and London and widely circulated. He left in MS. an unfinished *History of Pennsylvania*.

His brother, ROBERT CHARLES DALLAS (1754–1824), was born in Jamaica, and lived at various times in the West Indies, the United States, England and France. He was an intimate friend of Lord Byron. He wrote *Recollections of Lord Byron* (1824), and several novels, plays and miscellaneous works.

See G. M. Dallas, *Life and Writings of Alexander James Dallas* (Philadelphia, 1871).

**DALLAS, GEORGE MIFFLIN** (1792–1864), American statesman and diplomat, was born in Philadelphia, Pennsylvania, on the 10th of July 1792. He graduated at Princeton in 1810 at the head of his class; then studied law in the office of his father, Alexander J. Dallas, the financier, and was admitted to the bar in 1813. In the same year he accompanied Albert Gallatin, as his secretary, to Russia, and in 1814 returned to the United States as the bearer of important dispatches from the American peace commissioners at Ghent. He practised law in New York and Philadelphia, was chosen mayor of Philadelphia in 1828, and in 1829 was appointed by President Jackson, whom he had twice warmly supported for the presidency, United States attorney for the eastern district of Pennsylvania, a position long held by his father. From 1831 to 1833 he was a Democratic member of the United States Senate, in which he advocated a compromise tariff and strongly supported Jackson's position in regard to nullification. On the bank question he was at first at variance with the president; in January 1832 he presented in the Senate a memorial from the bank's president, Nicholas Biddle, and its managers, praying for a recharter, and subsequently he was chairman of a committee which reported a bill re-chartering the institution for a fifteen-year period. Afterwards, however, his views changed and he opposed the bank. From 1833 to 1835 Dallas was attorney-general of Pennsylvania, and from 1835 to 1839 was minister to Russia. During the following years he was engaged in a long struggle with James Buchanan for party leadership in Pennsylvania. He was vice-president of the United States from 1845 to 1849, but the appointment of Buchanan as secretary of state at once shut him off from all hope of party patronage or influence in the Polk administration, and he came to be looked upon as the leader of that body of conservative Democrats of the North, who, while they themselves chafed at the domination of Southern leaders, were disposed to disparage all anti-slavery agitation. By his casting vote at a critical period during the debate in the Senate on the tariff bill of 1846, he irrevocably lost his influence with the protectionist element of his native state, to whom he had given assurances of his support of the Tyler tariff of 1842. For several years after his retirement from office, he devoted himself to his law practice, and in 1856 succeeded James Buchanan as United States minister to England, where he remained until relieved by Charles Francis Adams in May 1861. During this trying period he represented his country with ability and tact, making every endeavour to strengthen the Union cause in Great Britain. He died at Philadelphia on the 1st of December 1864. He wrote a biographical memoir for an edition of his father's writings, which was published in 1871.

His *Diary* of his residence in St Petersburg and London was published in Philadelphia in 1892.

**DALLAS**, a city and the county-seat of Dallas county, Texas, U.S.A., about 220 m. N.W. of Houston, on the E. bank of the Trinity river. Pop. (1880) 10,358; (1890) 38,067; (1900) 42,638, of whom 9035 were negroes and 3381 were foreign-born; (1910) 92,104. Area, about 15 sq. m. Dallas is served by the Chicago, Rock Island & Pacific, the Gulf, Colorado & Santa Fé, the Houston & Texas Central, the Missouri, Kansas & Texas, the St Louis South-western, the Texas & New Orleans, the Trinity & Brazos Valley, and the Texas & Pacific railways, and by interurban electric railways to Fort Worth and Sherman. The lower channel of the Trinity river has been greatly improved by the Federal government; but in 1908 the river was not navigable as far as Dallas. Among public buildings are the Carnegie library (1901), Dallas county court house, the

city hall, the U.S. government building, St Matthew's cathedral (Prot. Episc.), the cathedral of the Sacred Heart (Rom. Cath.), the city hospital, St Paul's sanitarium (Rom. Cath.), and the Baptist Memorial sanitarium. Educational institutions include Dallas medical college (1901), the colleges of medicine and pharmacy of Baylor University, the medical college of South-western University (at Georgetown, Texas), Oak Cliff female academy, Patton seminary, St Mary's female college (Prot. Episc.), and Holy Trinity college (Rom. Cath.). The city had in 1908 three parks—Bachman's Reservoir (500 acres); Fair (525 acres)—the Texas state fair grounds, in which an annual exhibition is held—and City park (17 acres). Lake Cliff, Cycle and Oak Lawn parks are amusement grounds. A Confederate Soldiers' monument, a granite shaft 50 ft. high, was erected in 1897, with statues of R. E. Lee, Jefferson Davis, "Stonewall" Jackson and A. S. Johnston. Dallas was in 1900 the third city in population and the most important railway centre in Texas. It is a shipping centre for a large wheat, fruit and cotton-raising region, and the principal jobbing market for northern Texas, Oklahoma and part of Louisiana, and the biggest distributing point for agricultural machinery in the South-west. It is a livestock market, and one of the chief centres in the United States for the manufacture of saddlery and leather goods, and of cotton-gin machinery. It has flour and grist mills (the products of which ranked first in value among the city's manufactures in 1905), wholesale slaughtering and meat-packing establishments, cooperage works, railway repair shops, cotton compresses, lumber yards, salt works, and manufactories of cotton-seed oil and cake, boots and shoes and cotton and agricultural machinery. In 1900 and 1905 it was the principal manufacturing centre in the state, the value of its factory product in 1905 being \$15,627,668, an increase of 64.7 % over that in 1900. The water-works are owned and operated by the city, and the water is taken from the Elm fork of Trinity river. There are several artesian wells. Dallas, named in honour of G. M. Dallas, was settled in 1841, and first chartered as a city in 1856. The city is governed, under a charter of 1907, by a mayor and four commissioners, who together pass ordinances, appoint nearly all city officers, and generally are responsible for administering the government. In addition a school board is elected by the people. The charter contains initiative and referendum provisions, provides for the recall of any elective city official, and prohibits the granting of any franchise for a longer term than twenty years.

**DALLE** (pronounced "dal," Fr. for a flag-stone or flat tile), a rapid falling over flat smooth rock surfaces in a river bed, especially in rivers flowing between basaltic rocks. The name is common in America, and came into use through the French employés of the Hudson's Bay Company. Well-known "dalles" are on the St Louis, St Croix and Wisconsin rivers. The "dalles" of the Columbia river are very beautiful, and have given its name to Dalles (1910 pop. 4880), county-seat of Wasco county, Oregon.

**DALLIN, CYRUS EDWIN** (1861– ), American sculptor, was born at Springville, Utah, on the 22nd of November 1861. He was a pupil of Truman H. Bartlett in Boston, of the École des Beaux Arts, the Académie Julien and the sculptors Henri M. Chapu and Jean Dampt (born 1858), in Paris, and on his return to America became instructor in modelling in the state normal art school in Boston. He is best known for his plastic representations of the North American Indian—especially for "The Signal of Peace" in Lincoln Park, Chicago, and "The Medicine Man," in Fairmount Park, Philadelphia. As a boy he had lived among the Indians in the Far West, and had learned their language. His later works include "Pioneer Monument," Salt Lake City; "Sir Isaac Newton," Congressional Library, Washington; and "Don Quixote." He won a silver medal at the Paris Exposition, 1900, and a gold medal at the St Louis Exposition, 1904.

**DALLING AND BULWER, WILLIAM HENRY LYTTON EARLE BULWER, BARON** (1801–1872), better known as Sir HENRY BULWER, English diplomatist and author, was born in London on the 13th of February 1801. His father, General William Earle Bulwer, when colonel of the 106th regiment, had married Elizabeth Barbara Lytton, who—as the only child

of Richard Warburton Lytton, of Knebworth Park, in Hertfordshire—was sole heiress of the family of Norreys-Robinson-Lytton of Monacdhú in the island of Anglesea and of Guersylt in Denbighshire. Three sons were the fruit of this marriage. The second, afterwards Lord Dalling, was amply provided for by his selection as heir to his maternal grandmother; the paternal estates in Norfolk went to his elder brother William, and the maternal property in Herts to the youngest, Edward, known first as Bulwer the novelist and dramatist, and afterwards as the first Baron Lytton (*q.v.*) of Knebworth.

General Bulwer, as brigadier-general of volunteers, was one of the four commanding officers to whom was entrusted the defence of England in 1804, when threatened with invasion by Napoleon. Three years afterwards, on the 7th of July 1807, he died prematurely at fifty-two at Heyden Hall. His young widow had then devolved upon her not only the double charge of caring for the estates in Herts and Norfolk, but the far weightier responsibility of superintending the education of her three sons, then in their earliest boyhood. Henry Bulwer was educated at Harrow, under Dr George Butler, and at Trinity College and Downing College, Cambridge. In 1822 he published a small volume of verse, beginning with an ode on the death of Napoleon. It is chiefly interesting now for its fraternal dedication to Edward Lytton Bulwer, then a youth of nineteen.

On leaving Cambridge in the autumn of 1824, Henry Bulwer went, as emissary of the Greek committee then sitting in London, to the Morea, carrying with him £80,000 sterling, which he handed over to Prince Mavrocordato and his colleagues, as the responsible leaders of the War of Independence. He was accompanied on this expedition by Hamilton Browne, who, a year before, had been despatched by Lord Byron to Cephalonia to treat with the insurgent government. Shortly after his return to England in 1826, Bulwer published a record of this excursion, under the title of *An Autumn in Greece*. Meanwhile, bent for the moment upon following in his father's footsteps, he had, on the 19th of October 1825, been gazetted as a cornet in the 2nd Life Guards. Within less than eight months, however, he had exchanged from cavalry to infantry, being enrolled on the 2nd of June 1826 as an ensign in the 58th regiment. That ensigny he retained for little more than a month, obtaining another unattached, which he held until the 1st of January 1829, when he finally abandoned the army. The court, not the camp, was to be the scene of his successes; and for thirty-eight years altogether—from August 1827 to August 1865—he contrived, while maturing from a young attaché to an astute and veteran ambassador, to hold his own with ease, and in the end was ranked amongst the subtlest intellects of his time as a master of diplomacy. His first appointment in his new profession was as an attaché at Berlin. In April 1830 he obtained his next step through his nomination as an attaché at Vienna. Thence, exactly a year afterwards, he was employed nearer home in the same capacity at the Hague.

As yet ostensibly no more than a careless loungeur in the salons of the continent, the young ex-cavalry officer veiled the keenest observation under an air of indifference. His constitutional energy, which throughout life was exceptionally intense and tenacious, wore from the first a mask of languor. When in reality most cautious he was seemingly most negligent. No matter what he happened at the moment to take in hand, the art he applied to it was always that highest art of all, the *ars celare artem*. His mastery of the lightest but most essential weapon in the armoury of the diplomatist, tact, came to him as it seemed intuitively, and from the outset was consummate. Talleyrand himself would have had no reason, even in Henry Bulwer's earliest years as an attaché, to write entreatingly, "*pas de zèle*," to one who concealed so felicitously, even at starting, a lynx-like vigilance under an aspect the most phlegmatic. He had hardly reached his new post at the Hague when he found and seized his opportunity. The revolutionary explosion of July at Paris had been echoed on the 25th of August 1830 by an outburst of insurrection at Brussels. During the whole of September a succession of stormy events swept over Belgium,

until the popular rising reached its climax on the 4th of October in the declaration of Belgian independence by the provisional government. At the beginning of the revolution, the young attaché was despatched by the then foreign secretary at Whitehall, Lord Aberdeen, to watch events as they arose and report their character. In the execution of his special mission he traversed the country in all directions amidst civil war, the issue of which was to the last degree problematic. Under those apparently bewildering circumstances, he was enabled by his sagacity and penetration to win his spurs as a diplomatist. Writing almost haphazard in the midst of the conflict, he sent home from day to day a series of despatches which threw a flood of light upon incidents that would otherwise have appeared almost inexplicable. Scarcely a week had elapsed, during which his predictions had been wonderfully verified, when he was summoned to London to receive the congratulations of the cabinet. He returned to Brussels no longer in a merely temporary or informal capacity. As secretary of legation, and afterwards as chargé d'affaires, he assisted in furthering the negotiations out of which Belgium rose into a kingdom. Scarcely had this been accomplished when he wrote what may be called the first chapter of the history of the newly created Belgian kingdom. It appeared in 1831 as a brief but luminous paper in the January number of the *Westminster Review*. And as the events it recorded had helped to inaugurate its writer's career as a diplomatist, so did his narrative of those occurrences in the pages of the Radical quarterly signalize in a remarkable way the commencement of his long and consistent career as a Liberal politician. Shortly before his appearance as a reviewer, and immediately prior to the carrying of the first Reform Bill, Bulwer had won a seat in the House of Commons as member for Wilton, afterwards in 1831 and 1832 sitting there as M.P. for Coventry. Nearly two years having elapsed, during which he was absent from parliament, he was in 1834 returned to Westminster as member for Marylebone. That position he retained during four sessions, winning considerable distinction as a debater. Within the very year in which he was chosen by the Marylebone electors, he brought out in two volumes, entitled *France—Literary, Social and Political*, the first half of a work which was only completed upon the publication, two years afterwards, of a second series, also in two volumes, under the title of *The Monarchy of the Middle Classes*. Through its pages he made good his claim to be regarded not merely as a keen-witted observer, but as one of the most sagacious and genial delineators of the generic Frenchman, above all of that supreme type of the race, with whom all through his life he especially delighted to hold familiar intercourse, the true Parisian. Between the issuing from the press of these two series, Henry Bulwer had prefixed an intensely sympathetic *Life of Lord Byron* to the Paris edition of the poet's works published by Galignani,—a memoir republished sixteen years afterwards. A political argument of a curiously daring and outspoken character, entitled *The Lords, the Government, and the Country*, was given to the public in 1836 by Bulwer, in the form of an elaborate letter to a constituent. At this point his literary labours, which throughout life were with him purely labours by-the-way, ceased for a time, and he disappeared during three decades from authorship and from the legislature.

During the period of his holding the position of chargé d'affaires at Brussels, Bulwer had seized every opportunity of making lengthened sojourns at Paris, always for him the choicest place of residence. It was in the midst of one of these *dolce far niente* loiterings on the boulevards that, on the 14th of August 1837, he received his nomination as secretary of embassy at Constantinople. Recognizing his exceptional ability Lord Ponsonby, the British ambassador at Constantinople, at once entrusted to him the difficult task of negotiating a commercial treaty, which had the double object of removing the intolerable conditions which hampered British trade with Turkey and of dealing a blow at the threatening power of Mehemet Ali, pasha of Egypt, by shattering the system of monopolies on which it was largely based. In this difficult task Bulwer was helped by the hatred of Sultan Mahmed II. for Mehemet Ali, but the treaty was none the less a remarkable



proof of his diplomatic skill, and the compliment was well deserved when Palmerston, in writing his congratulations to him from Windsor Castle, on the 13th of September 1838, pronounced the treaty a *capo d'opera*, adding that without reserve it would be at once ratified. Shortly after this achievement Bulwer was nominated secretary of embassy at St Petersburg. Illness, however, compelled him to delay his northern journey—almost opportunely, as it happened, for in June 1839 he was despatched, in the same capacity, to the more congenial atmosphere of Paris. At that juncture the developments of the feud between Mehemet Ali and the Porte were threatening to bring England and France into armed collision (see MEHEMET ALI). In 1839 and 1840, during the temporary absence of his chief, Lord Granville, the secretary of embassy was gazetted *ad interim* chargé d'affaires at the court of France, and thus during this critical time he had fresh opportunities of winning distinction as a diplomatist.

On the 14th of November 1843 he was appointed ambassador at the court of the young Spanish queen Isabella II. Upon his arrival at Madrid signal evidence was afforded of the estimation in which he was then held as a diplomatist. He was chosen arbitrator between Spain and Morocco, then confronting each other in deadly hostility, and, as the result of his mediation, a treaty of peace was signed between the two powers in 1844. In 1846 a much more formidable difficulty arose,—one which, after threatening war between France and England, led at last to a diplomatic rupture between the British and Spanish governments. The dynastic intrigues of Louis Philippe were the immediate cause of this estrangement, and those intrigues found their climax in what has ever since been known in European annals as the Spanish Marriages. The storm sown in the Spanish marriages was reaped in the whirlwind of the February revolution. And the explosion which took place at Paris was answered a month afterwards at Madrid by a similar outbreak. Marshal Narvaez thereupon assumed the dictatorship, and wreaked upon the insurgents a series of reprisals of the most pitiless character. These excessive severities of the marshal-dictator the British ambassador did his utmost to mitigate. When at last, however, Narvaez carried his rigour to the length of summarily suppressing the constitutional guarantees, Bulwer sent in a formal protest in the name of England against an act so entirely ruthless and unjustifiable. This courageous proceeding at once drew down upon the British envoy a counter-stroke as ill-judged as it was unprecedented. Narvaez, with matchless effrontery, denounced the ambassador from England as an accomplice in the conspiracies of the Progressistas; and despite his position as an envoy, and in insolent defiance of the Palmerstonian boast, *Civis Britannicus*, Bulwer, on the 12th of June, was summarily required to quit Madrid within twenty-four hours. Two days afterwards M. Isturitz, the Spanish ambassador at the court of St James's, took his departure from London. Diplomatic relations were not restored between the two countries until years had elapsed, nor even then until after a formal apology, dictated by Lord Palmerston, had been signed by the prime minister of Queen Isabella. Before his return the ambassador was gazetted a K.C.B., being promoted to the grand cross some three years afterwards. In addition to this mark of honour he received the formal approbation of the ministry, and with it the thanks of both Houses of Parliament.

Before the year of his return from the peninsula had run out Sir Henry Bulwer was married to the Hon. Georgiana Charlotte Mary Wellesley, youngest daughter of the 1st Baron Cowley, and niece to the duke of Wellington. Early in the following year, on the 27th of April 1849, he was nominated ambassador at Washington. There he acquired immense popularity. His principal success was the compact known as the Clayton-Bulwer Treaty (*q.v.*), ratified in May 1850, pledging the contracting governments to respect the neutrality of the meditated ship canal through Central America, bringing the waters of the Atlantic and Pacific into direct communication. After having been accredited as ambassador to the United States for three years, Sir Henry Bulwer, early in 1852, was despatched as minister plenipotentiary at the court of the grand duke of Tuscany at

Florence. Shortly after his retirement from that post in the January of 1855, he was entrusted with various diplomatic missions, in one of which he was empowered as commissioner under the 23rd article of the treaty of Paris, 1856, to investigate the state of things in the Danubian principalities, with a view to their definite reorganization. Finally he was installed, from May 1858 to August 1865, as the immediate successor, after the close of the Crimean war, of the "Great Elchi," Viscount Stratford de Redcliffe, as ambassador extraordinary to the Ottoman Porte at Constantinople.

In the winter of 1865 Bulwer returned home from the Bosphorus, and retired with a pension. He was elected member for Tamworth on the 17th of November 1868, and retained his seat until gazetted as a peer of the realm on the 21st of March 1871, under the title of Baron Dalling and Bulwer of Wood Dalling in the county of Norfolk. Upon the eve of his return to his old haunts as a debater and a politician he had asserted his claim to literary distinction by giving to the world in two volumes his four masterly sketches of typical men, entitled *Historical Characters*. This work, dedicated to his brother Edward, in testimony of the writer's fraternal affection and friendship, portrayed in luminous outline Talleyrand the Politic Man, Cobbett the Contentious Man, Canning the Brilliant Man, and Mackintosh the Man of Promise. Two other kindred sketches, those of Sir Robert Peel and Viscount Melbourne, having been selected from among their author's papers, were afterwards published posthumously. Another work of ampler outline and larger pretension was begun and partially issued from the press during Lord Dalling's lifetime, but not completed. This was the *Life of Viscount Palmerston*, the first two volumes of which were published in 1870. A third volume appeared four years afterwards. Even then it left the story of the English statesman broken off so abruptly that the work remained at the last the merest fragment. It was completed by Evelyn Ashley.

Lord Dalling died unexpectedly on the 23rd of May 1872 at Naples. He had no issue, and the title became extinct. In his public career he enjoyed a three-fold success—as ambassador, as politician and as man of letters. His popularity in society was at all times remarkable, mainly no doubt from his mastery of all the subtler arts of a skilled conversationalist. The apparent languor with which he related an anecdote, flung off a *bon mot*, or indulged in a momentary stroke of irony imparted interest to the narrative, wings to the wit and point to the sarcasm in a manner peculiarly his own.

(C. K.)

**DALLMEYER, JOHN HENRY** (1830–1883), Anglo-German optician, was born on the 6th of September 1830 at Loxten, Westphalia, the son of a landowner. On leaving school at the age of sixteen he was apprenticed to an Osnabrück optician, and in 1851 he came to London, where he obtained work with an optician, W. Hewitt, who shortly afterwards, with his workmen, entered the employment of Andrew Ross, a lens and telescope manufacturer. Dallmeyer's position in this workshop appears to have been an unpleasant one, and led him to take, for a time, employment as French and German correspondent for a commercial firm. After a year he was, however, re-engaged by Ross as scientific adviser, and was entrusted with the testing and finishing of the highest class of optical apparatus. This appointment led to his marriage with Ross's second daughter, Hannah, and to the inheritance, at Ross's death (1859), of a third of his employer's large fortune and the telescope manufacturing portion of the business. Turning from astronomical work to the making of photographic lenses (see PHOTOGRAPHY), he introduced improvements in both portrait and landscape lenses, in object-glasses for the microscope and in condensers for the optical lantern. In connexion with celestial photography he constructed photo-heliographs for the Wilna observatory in 1863, for the Harvard College observatory in 1864, and, in 1873, several for the British government. Dallmeyer's instruments achieved a wide success in Europe and America, taking the highest awards at various international exhibitions. The Russian government gave him the order of St Stanislaus, and the French government made him chevalier of the Legion of Honour. He was for many

years upon the councils of both the Royal Astronomical and Royal Photographic societies. About 1880 he was advised to give up the personal supervision of his workshops, and to travel for his health, but he died on board ship, off the coast of New Zealand, on the 30th of December 1883.

His second son, THOMAS RUDOLPHUS DALLMEYER (1850-1906), who assumed control of the business on the failure of his father's health, was principally known as the first to introduce telephotographic lenses into ordinary practice (patented 1891), and he was the author of a standard book on the subject (*Telephotography*, 1899). He served as president of the Royal Photographic Society in 1900-1903.

**DALL' ONGARO, FRANCESCO** (1808-1873), Italian writer, born in Friuli, was educated for the priesthood, but abandoned his orders, and taking to political journalism founded the *Favilla* at Trieste in the Liberal interest. In 1848 he enlisted under Garibaldi, and next year was a member of the assembly which proclaimed the republic in Rome, being given by Mazzini the direction of the *Monitor ufficiale*. On the downfall of the republic he fled to Switzerland, then to Belgium and later to France, taking a prominent part in revolutionary journalism; it was not till 1860 that he returned to Italy, where he was appointed professor of dramatic literature at Florence. Subsequently he was transferred to Naples, where he died on the 10th of January 1873. His patriotic poems, *Stornelli*, composed in early life, had a great popular success; and he produced a number of plays, notably *Fornaretto*, *Bianca Capello*, *Fasma* and *Il Tesoro*. His collected *Fantasie drammatiche e liriche* were published in his lifetime.

**DALMATIA** (Ger. *Dalmatien*; Ital. *Dalmazia*; Serbo-Croatian, *Dalmacija*), a kingdom and crownland of the Austro-Hungarian empire, in the north-west of the Balkan Peninsula, and on the Adriatic Sea. Dalmatia is bounded, on the landward side, by Croatia and Bosnia, in the N. and N.E.; and by Herzegovina and Montenegro, in the S.E. and S. Its area amounts to 4923 sq. m.; its greatest length, from north-west to south-east, is 210 m.; its breadth reaches 35 m. between Point Planca and the Bosnian frontier, diminishing to less than 1 m. at Cattaro. Near the ports of Klek and Castelnuovo the Herzegovinian frontier comes down to the sea,<sup>1</sup> but only for a total distance of 14½ m.

*Physical Features.*—No part of the Mediterranean shore, except the coast of Greece, is so deeply indented as the Dalmatian littoral, with its multitude of rock-bound bays and inlets. It is sheltered from the open sea by a rampart of islands which vary greatly in size; a few being large enough to support several thousand inhabitants, while others are mere reefs, swept bare by the sea, or tenanted only by rabbits and seabirds. This Dalmatian archipelago, separated from the Istrian by the Gulf of Quarnero, forms two island groups, the northern or Liburnian, and the southern; with open water intervening, off Point Planca. In calm weather the channels between the islands and the mainland resemble a chain of landlocked lakes, brilliantly clear to a depth of several fathoms. As a rule, the surrounding hills are rugged, bleached almost white or pale russet, and destitute of verdure; but their monotony is relieved by the half-ruined castles and monasteries clinging to the rocks, or by the beauty of such cities as Ragusa, or Arbe, with its fantastic row of steeples overlooking the beach. The principal islands, Arbe, Brazza, Curzola, Lacrova, Lesina, Lissa and Meleda, are described under separate headings. The promontory of Sabbioncello, or Punta di Stagno, which juts out for 41 m. into the sea, between Curzola and Lesina, is almost another island; for its breadth, which nowhere exceeds 5 m., dwindles to about 1 m. at the narrow isthmus which unites it with the shore. There are two small ports on this isthmus—on the south, Stagno Grande

<sup>1</sup> This arrangement is based on the terms of the peace of Carlowitz 1699 (articles IX. and XI. of the Turco-Venetian Treaty). It is due to the commercial and maritime rivalry between Venice and Ragusa. The Ragusans bribed the Turkish envoys at Carlowitz to stipulate for a double extension of the Ottoman dominions down to the Adriatic; and thus the Ragusan lands, which otherwise would have bordered upon the Dalmatian possessions of Venice, were surrounded by neutral territory.

(Serbo-Croatian, *Ston Veliki*), once celebrated for its salt and shipbuilding industries, and, on the north, Stagno Piccolo (*Ston Mali*). Dalmatia possesses a magnificent anchorage in the Bocche di Cattaro, and there are numerous lesser havens, at Sebenico, Traù, Zara and elsewhere along the coast and among the islands.

The country is almost everywhere hilly or mountainous. On the Croatian border rises the lofty barrier of the Velebit, which culminates in Sveto Brdo (5751 ft.), and Vakanski Vrh (5768 ft.). The Dinaric Alps form the frontier between Dalmatia and Bosnia; Dinara (6007 ft.), which gives its name to the whole chain, and Troglav (6276 ft.), being the highest Dalmatian summits. North-west of Sinj rise the Svilaja and Moseč Planinas; the ridges of Mosor and Biokovo, with Sveto Juraj (5781 ft.), follow the windings of the coast from Spalato to Macarsca; Orjen marks the meeting-place of the Herzegovinian, Montenegrin and Dalmatian frontiers, and the Sutorman range appears in the extreme south. The barren dry limestone of the Dalmatian highlands has been aptly compared with a petrified sponge; for it is honeycombed with underground caverns and water-courses, into which the rainfall is at once filtered. Thus arises a complete system of subterranean rivers, with waterfalls, lakes and regular seasons of flood. Even the few surface rivers vanish and emerge again at intervals. The Trebinjčica, for instance, disappearing in Herzegovina, supplies both the broad and swift estuary of Ombla, near Ragusa, and the fresh-water spring of Doli, which issues from the bottom of the sea. Apart from the Ombla, and the Narenta (Serbo-Croatian, *Neretva*; Roman, *Naro*), which creates a broad marshy delta between Metković and the sea, Dalmatia has only three rivers more than 25 m. long; the Zermagna (*Zrmanja*, *Tedanium*), Kerka, (*Krka*, *Titius*), and Cetina (*Celina*; *Narona* or *Tilurus*). The Zermagna skirts the southern foothills of the Velebit and falls into the harbour of Novigrad. Better known is the Kerka, which rises in the Dinaric Alps and flows south-westward to the Adriatic. Near Scardona (*Skradin*) it spreads into a broad lake, and forms several fine waterfalls, after receiving its tributary the Cikola (*Čikola*), from the east. South of Spalato, the Cetina, which also springs from the Dinaric Alps, descends to the sea at Almissa (*Omiš*), after passing between the Mosor and Biokovo ranges. There are a few small lakes near Zara, Zaravecchia and the Narenta estuary; while the fertile, but unhealthy, hollows among the mountains fill with water after heavy rain, and sometimes cause disastrous floods. But most parts of the country suffer from drought.

For an account of the chief geological formations see BALKAN PENINSULA. Small quantities of iron, lignite, asphalt and bay salt are the only minerals of commercial importance.

The climate is warm and healthy, the mean temperature at Zara being 57° F., at Lesina 62°, and at Ragusa 63°. The prevailing wind is the sirocco, or S.E.; but the terrible Bora, or N.N.E., may blow at any season of the year. The average annual rainfall is about 28 in., but a dry and a wet year usually alternate.

*Fauna.*—Bears, badgers and wild cats, with a larger number of wolves and foxes, find shelter in the Dinaric Alps and on the heights of Svilaja, Mosor and Biokovo; while jackals exist on Curzola and Sabbioncello, almost their last refuges in Europe. Roe deer are uncommon, and the wild boar, chamois, red-deer and beaver are extinct; but hares and rabbits abound. The game-laws are not strict, and are often evaded by the Morlachs; but moderate sport may be obtained in the fens formed by the Cetina about Sinj, and the lagoons of the Narenta estuary; both regions being frequented by wild swans, geese, duck, snipe and other aquatic birds. Among land-birds, the commonest are quails, woodcock, partridges, and especially the so-called "stone-fowl" (*Steinhuhn*, *Perdix Graeca*). Tortoises are numerous; snakes, lizards, scorpions and innumerable sand-flies infest the dry hillsides; and the limestone caverns are peopled by sightless bats, reptiles, fish, flies, beetles, spiders, crustacea and molluscs.

*Fisheries.*—No region of Europe is richer in its marine fauna and flora. Sponge and coral fisheries afford a valuable source of

income to the peasantry, many of whom also go northward for the sardine and tunny fisheries of the Istrian coast, while salmon, trout and eels are caught in the Dalmatian rivers.

*Flora.*—The olive, almond, fig, orange, palm, aloe, myrtle, locust-tree and other characteristic members of the Mediterranean flora thrive in the sheltered valleys of the Dalmatian littoral, where almond-blossoms appear in mid-winter, and the palm occasionally bears ripe fruit. The *marasca*, or wild cherry, is abundant, and yields the celebrated liqueur called *maraschino*. But at a little distance from the rivers and on the more exposed parts of the coast the aspect of the country changes entirely. Patches of thin grass, heather, juniper, thyme, tamarisks and mountain roses hardly relieve the bareness and aridity of the seaward slopes.

*Forests.*—Oaks, pines and beeches still, in a few parts, clothe the landward slopes, but, as a rule, the forests for which Dalmatia was once famous were cut down for the Venetian shipyards or burned by pirates; while every attempt at replanting is frustrated by the shallowness of the soil, the drought and the multitude of goats that browse on the young trees.

*Agriculture.*—Little more than one-tenth of the whole surface is under the plough; the rest, where it is not altogether sterile, being chiefly mountain pasture, vineyards and garden land. Asses are the favourite beasts of burden; goats are strikingly numerous; and sheep are kept for the sake of their mutton, which is almost the only animal food freely consumed by the peasantry. Cattle-breeding, bee-keeping, and the cultivation of fruit and vegetables, especially potatoes and beetroot, are among the principal resources of the people, while wheat, rye, barley, oats, Indian corn, hemp and millet are also grown. Viticulture is carried on with great and increasing success (see WINE).

*Land-tenure.*—Individual proprietorship of the soil is rare, for, despite the decadence of the *zadruga* or household community, the tenure of land and the privilege of using the communal domain still appertain to the family as a whole. There are a few large estates, but most of the land is parcelled out in small holdings.

*Industries.*—Besides fishing, farming and such allied trades as ship-building, wine and oil pressing, and the distillation of spirits, notably *maraschino*, a few other industries are practised, such as tile-burning and the manufacture of soap; but these are of minor importance. Certain crafts are also carried on by the country-folk, in their own homes; thus the peasant is sometimes his own mason, carpenter, weaver and miller. Manufactured goods and foodstuffs are imported, in return for asphalt, lignite, bay salt, wine, spirits, oil, honey, wax and hides; and there is a lucrative transit trade with Bosnia and Herzegovina, Montenegro, Turkey and various Adriatic and Mediterranean ports.

*Communications.*—Communications are defective, some parts of the interior being only accessible by the roughest of mountain roads. The principal railway, in point of size, traverses the central districts, linking together Knin, Spalato, Sebenico and Sinj; but the southern lines, which unite Dalmatia with Herzegovina and terminate at Ragusa, Metković and Castlenuovo on the Bocche di Cattaro, are almost of equal importance, Cattaro being one of the chief outlets for Montenegrin commerce, while the vessels which steam up the Narenta to Metković carry the bulk of the sea-borne trade of Herzegovina. In 1897 Dalmatia possessed 151 post and 98 telegraph offices.

*Chief Towns.*—The chief towns are Zara, the capital, with 32,506<sup>1</sup> inhabitants in 1900, Spalato (27,198), Sebenico (24,751), Traù (17,064), Ragusa (13,174), Macarsca (11,016), and Cattaro (5418). All these are described under separate headings.

*Population and National Characteristics.*—With a constant excess of male over female children, the population increased steadily from 1869 to 1900, when it reached 591,597. Of this total 1% are foreigners and about 3% Italians, whose numbers

<sup>1</sup> These figures, taken from the Austrian official returns, include the population of the entire commune, not merely the urban residents. Only in Zara, Spalato, Sebenico and Ragusa, do the actual townfolk number more than 1000.

tend slowly to diminish. The Morlachs, who constitute the remaining 96%, belong to the Serbo-Croatian branch of the Slavonic race, having absorbed the Latinized Illyrians, Albanians and other alien elements with which they have been associated. The name of *Morlachs*, *Morlaks* or *Morlacks* commonly bestowed by English writers on the Dalmatian Slavs, though sometimes restricted to the peasantry of the hills, is an abbreviated form of *Mavrovlachi*, meaning either "Black Vlachs," or, less probably, "Sea Vlachs." It was originally applied to the scattered remnants of the Latin or Latinized inhabitants of central Illyria, who were driven from their homes by the barbarian invaders during the 7th century, and took refuge among the mountains. Throughout the middle ages the Mavrovlachi were usually nomadic shepherds, cattle-drovers or muleteers. In the 14th century they emigrated from central Illyria into northern Dalmatia and maritime Croatia; and these regions were thenceforward known as *Morlacchia*, until the 18th century. Gradually, however, the Mavrovlachi became identified with the Slavs, whose language and manners they adopted, and to whom they gave their own name. In northern Dalmatia the Slavs of the interior are still called *Morlacchi*; in the south this name expresses contempt. Of the Vlachs, properly so called, very few are left in the country; although the name *Vlachs* (*q.v.*) is frequently used by the Slavs to designate the Italians and the town-dwellers generally. The literary languages of Dalmatia are Italian and Serbo-Croatian; the spoken language is, in each case, modified by the introduction of various dialect forms.

The Morlachs wear a picturesque and brightly-coloured costume, resembling that of the Serbs (see SERBIA). In appearance they are sometimes blond, with blue or grey eyes, like the Shumadian peasantry of Servia; more often, olive-skinned, with dark hair and eyes, like the Montenegrins, whom they rival in stature, strength and courage; while their conservative spirit, their devotion to national traditions, poetry and music, their pride, indolence and superstition, are typically Servian. Dalmatian public life is deeply affected by the jealousies which subsist between the Slavs and the Italians, whose influence, though everywhere waning, remains predominant in some of the towns; and between Orthodox "Serbs," who use the Cyrillic alphabet, and Roman Catholic "Croats," who prefer the Latin.

*Government.*—Dalmatia occupies a somewhat anomalous position in the Austro-Hungarian state system. Itself a crown-land of Austria, returning eleven members to the Austrian parliament, it is severed geographically from the other Austrian lands by the Hungarian kingdom of Croatia. Ethnologically it is one with Croatia, and it is included in the official title of the Croatian king, *i.e.* the emperor. The political system is based on a law of the 26th of February 1861. The provincial diet is composed of 43 members, comprising the Roman Catholic archbishop, the Orthodox bishop of Zara and representatives of the chief taxpayers, the towns and the communes. Benkovac, on the main road from Zara to Spalato, Cattaro, Curzola, Imotski, 21 m. N. by E. of Macarsca, Knin, Lesina, Macarsca, Ragusa, Sebenico, Sinj, Spalato and Zara, give names to the twelve administrative districts, of which they are the capitals.

*Defence.*—Conscription is in force, as elsewhere in Austria, and the Dalmatian coast furnishes the Austrian—as formerly the Venetian—navy with many of its best recruits.

*Religion.*—Roman Catholicism is the religion of more than 80% of the population, the remainder belonging chiefly to the Orthodox Church. The Roman Catholic archbishop has his seat in Zara, while Cattaro, Lesina, Ragusa, Sebenico and Spalato are bishoprics. At the head of the Orthodox community stands the bishop of Zara.

The use of Slavonic liturgies written in the Glagolitic alphabet, a very ancient privilege of the Roman Catholics in Dalmatia and Croatia, caused much controversy during the first years of the 20th century. There was considerable danger that the Latin liturgies would be altogether superseded by the Glagolitic, especially among the northern islands and in rural communes, where the Slavonic element is all-powerful. In 1904 the Vatican forbade the use of Glagolitic at the festival of SS. Cyril and

Methodius, as likely to impair the unity of Catholicism. A few years previously the Slavonic archbishop Rajčević of Zara, in discussing the "Glagolitic controversy," had denounced the movement as "an innovation introduced by Panslavism to make it easy for the Catholic clergy, after any great revolution in the Balkan States, to break with Latin Rome." This view is shared by very many, perhaps by the majority, of the Roman Catholics in Dalmatia.

*Education.*—Education progressed slowly between 1860 and 1900, attendance at school being often a hardship in the poor and widely scattered hamlets of the interior. In 1890 more than 80% of the population could neither read nor write, although schools are maintained by every commune. In 1893 the country possessed 5 intermediate and 337 elementary schools, 6 theological seminaries, 6 gymnasia, and about 40 continuation and technical schools.

*Antiquities.*—To the foreign visitor Dalmatia is chiefly interesting as a treasury of art and antiquities. The grave-mounds of Curzola, Lesina and Sabbioncello have yielded a few relics of prehistoric man, and the memory of the early Celtic conquerors and Greek settlers is preserved only in a few place-names; but the monuments left by the Romans are numerous and precious. They are chiefly confined to the cities; for the civilization of the country was always urban, just as its history is a record of isolated city-states rather than of a united nation. Beyond the walls of its larger towns, little was spared by the barbarian Goths, Avars and Slavs; and the battered fragments of Roman work which mark the sites of Salona, near Spalato, and of many other ancient cities, are of slight antiquarian interest and slighter artistic value. Among the monuments of the Roman period, by far the most noteworthy in Dalmatia, and, indeed, in the whole Balkan Peninsula, is the Palace of Diocletian at Spalato (*q.v.*). Dalmatian architecture was Byzantine in its general character from the 6th century until the close of the 10th. The oldest memorials of this period are the vestiges of three basilicas, excavated in Salona, and dating from the first half of the 7th century at latest. Byzantine art, in the latter half of this period and the two succeeding centuries, continued to flourish in those cities which, like Zara, gave their allegiance to Venice; just as, in the architecture of Traù and other cities dominated by Hungary, there are distinct traces of German influence. The belfry of S. Maria, at Zara, erected in 1105, is first in a long list of Romanesque buildings. At Arbe there is a beautiful Romanesque campanile which also belongs to the 12th century; but the finest example in this style is the cathedral of Traù. The 14th century Dominican and Franciscan convents in Ragusa are also noteworthy. Romanesque lingered on in Dalmatia until it was displaced by Venetian Gothic in the early years of the 15th century. The influence of Venice was then at its height. Even in the hostile republic of Ragusa the Romanesque of the custom-house and Rectors' palace is combined with Venetian Gothic, while the graceful balconies and ogee windows of the Prijeki closely follow their Venetian models. Gothic, however, which had been adopted very late, was abandoned very early; for in 1441 Giorgio Orsini of Zara, summoned from Venice to design the cathedral of Sebenico, brought with him the influence of the Italian Renaissance. The new forms which he introduced were eagerly imitated and developed by other architects, until the period of decadence—which virtually concludes the history of Dalmatian art—set in during the latter half of the 17th century. Special mention must be made of the carved woodwork, embroideries and plate preserved in many churches. The silver statuette and the reliquary of St Biagio at Ragusa, and the silver ark of St Simeon at Zara, are fine specimens of Byzantine and Italian jewellers' work, ranging in date from the 11th or 12th to the 17th century.

#### HISTORY

*Dalmatia under Roman Rule, A.D. 9–1102.*—The history of Dalmatia may be said to begin with the year 180 B.C., when the tribe from which the country derives its name declared itself independent of Gentius, the Illyrian king, and established a

republic. Its capital was Delminium<sup>1</sup>; its territory stretched northwards from the Narenta to the Cetina, and later to the Kerka, where it met the confines of Liburnia. In 156 B.C. the Dalmatians were for the first time attacked by a Roman army and compelled to pay tribute; but only in the time of Augustus (31 B.C.–A.D. 14) was their land finally annexed, after the last of many formidable revolts had been crushed by Tiberius in A.D. 9. This event was followed by total submission and a ready acceptance of the Latin civilization which overspread Illyria (*q.v.*). The downfall of the Western Empire left this region subject to Gothic rulers, Odoacer and Theodoric, from 476 to 535, when it was added by Justinian to the Eastern Empire. The great Slavonic migration into Illyria, which wrought a complete change in the fortunes of Dalmatia, took place in the first half of the 7th century. In other parts of the Balkan Peninsula these invaders—Serbs, Croats or Bulgars—found little difficulty in expelling or absorbing the native population. But here they were baffled when confronted by the powerful maritime city-states, highly civilized, and able to rely on the moral if not the material support of their kinsfolk in Italy. Consequently, while the country districts were settled by the Slavs, the Latin or Italian population flocked for safety to Ragusa, Zara and other large towns, and the whole country was thus divided between two frequently hostile communities. This opposition was intensified by the schism between Eastern and Western Christianity (1054), the Slavs as a rule preferring the Orthodox or sometimes the Bogomil creed, while the Italians were firmly attached to the Papacy. Not until the 15th century did the rival races contribute to a common civilization in the literature of Ragusa. To such a division of population may be attributed the two dominant characteristics of local history—the total absence of national as distinguished from civic life, and the remarkable development of art, science and literature. Bosnia, Servia and Bulgaria had each its period of national greatness, but remained intellectually backward; Dalmatia failed ever to attain political or racial unity, but the Dalmatian city-states, isolated and compelled to look to Italy for support, shared perforce in the march of Italian civilization. Their geographical position suffices to explain the relatively small influence exercised by Byzantine culture throughout the six centuries (535–1102) during which Dalmatia was part of the Eastern empire. Towards the close of this period Byzantine rule tended more and more to become merely nominal. In 806 Dalmatia was added to the Holy Roman empire, but was soon restored; in 829 the coast was ravaged by Saracens. A strange republic of Servian pirates arose at the mouth of the Narenta. In the 10th century description of Dalmatia by Constantine Porphyrogenitus (*De Administrando Imperio*, 29–37), this region is called *Paganía*, from the fact that its inhabitants had only accepted Christianity about 890, or 250 years later than the other Slavs. These *Pagani*, or *Arentani* (Narentines), utterly defeated a Venetian fleet despatched against them in 887, and for more than a century exacted tribute from Venice itself. In 908 they were finally crushed by the doge Pietro Orseolo II., who assumed the title duke of Dalmatia, though without prejudice to Byzantine suzerainty. Meanwhile the Croatian kings had extended their rule over northern and central Dalmatia, exacting tribute from the Italian cities, Traù, Zara and others, and consolidating their own power in the purely Slavonic towns, such as Nona or Belgrad (Zaravecchia). The Church was involved in the general confusion; for the synod of Spalato, in 1059, had forbidden the use of any but Greek or Latin liturgies, and so had accentuated the differences between Latin and Slav. A raid of Norman corsairs in 1073 was hardly defeated with the help of a Venetian fleet.

<sup>1</sup> Also written *Dalminium*, *Deminium*, and *Delmis*. Thomas of Spalato (c. 1200–1250) mentions that the site of Delminium had been forgotten in his time, although certain ancient walls among the mountains were believed to be its ruins. It has been variously identified, by modern archaeologists, with Almissa, on the coast, Dalen, in the Herzegovina, Duvno, near Sinj, and Gardun, in the same locality. It was evidently a stronghold of considerable size and importance, and Appian (*De bellis Illyricis*) alludes to its almost impregnable fortifications.

*Rivalry of Venice and Hungary in Dalmatia, 1102-1420.*—Unable amid such dissensions to stand alone, unprotected by the Eastern empire and hindered by their internal dissensions from uniting in a defensive league, the city-states turned to Venice and Hungary for support. The Venetians, to whom they were already bound by race, language and culture, could afford to concede liberal terms because their own principal aim was not the territorial aggrandizement sought by Hungary, but only such a supremacy as might prevent the development of any dangerous political or commercial competitor on the eastern Adriatic. Hungary had also its partisans; for in the Dalmatian city-states, like those of Greece and Italy, there were almost invariably two jealous political factions, each ready to oppose any measure advocated by its antagonist. The origin of this division seems here to have been economic. The farmers and the merchants who traded in the interior naturally favoured Hungary, their most powerful neighbour on land; while the seafaring community looked to Venice as mistress of the Adriatic. In return for protection, the cities often furnished a contingent to the army or navy of their suzerain, and sometimes paid tribute either in money or in kind. Arbe, for example, annually paid ten pounds of silk or five pounds of gold to Venice. The citizens clung to their municipal privileges, which were reaffirmed after the conquest of Dalmatia in 1102-1105 by Coloman of Hungary. Subject to the royal assent they might elect their own chief magistrate, bishop and judges. Their Roman law remained valid. They were even permitted to conclude separate alliances. No alien, not even a Hungarian, could reside in a city where he was unwelcome; and the man who disliked Hungarian dominion could emigrate with all his household and property. In lieu of tribute, the revenue from customs was in some cases shared equally by the king, chief magistrate, bishop and municipality. These rights and the analogous privileges granted by Venice were, however, too frequently infringed, Hungarian garrisons being quartered on unwilling towns, while Venice interfered with trade, with the appointment of bishops, or with the tenure of communal domains. Consequently the Dalmatians remained loyal only while it suited their interests, and insurrections frequently occurred. Even in Zara four outbreaks are recorded between 1180 and 1345, although Zara was treated with special consideration by its Venetian masters, who regarded its possession as essential to their maritime ascendancy. The doubtful allegiance of the Dalmatians tended to protract the struggle between Venice and Hungary, which was further complicated by internal discord due largely to the spread of the Bogomil heresy; and by many outside influences, such as the vague suzerainty still enjoyed by the Eastern emperors during the 12th century; the assistance rendered to Venice by the armies of the Fourth Crusade in 1202; and the Tartar invasion of Dalmatia forty years later (see TRAU). The Slavs were no longer regarded as a hostile race, but the power of certain Croatian magnates, notably the counts of Bribir, was from time to time supreme in the northern districts (see CROATIA-SLAVONIA); and Stephen Tvrtko, the founder of the Bosnian kingdom, was able in 1389 to annex the whole Adriatic littoral between Cattaro and Fiume, except Venetian Zara and his own independent ally, Ragusa (see BOSNIA AND HERZEGOVINA). Finally, the rapid decline of Bosnia, and of Hungary itself when assailed by the Turks, rendered easy the success of Venice; and in 1420 the whole of Dalmatia, except Almissa, which yielded in 1444, and Ragusa, which preserved its freedom, either submitted or was conquered. Many cities welcomed the change with its promise of tranquillity.

*Venetian and Turkish Rule, 1420-1797.*—An interval of peace ensued, but meanwhile the Turkish advance continued. Constantinople fell in 1453, Serbia in 1459, Bosnia in 1463 and Herzegovina in 1483. Thus the Venetian and Ottoman frontiers met; border wars were incessant; Ragusa sought safety in friendship with the invaders. In 1508 the hostile league of Cambrai compelled Venice to withdraw its garrison for home service, and after the overthrow of Hungary at Mohács in 1526 the Turks were able easily to conquer the greater part of Dalmatia. The peace of 1540 left only the maritime cities to

Venice, the interior forming a Turkish province, governed from the fortress of Clissa by a *Sanjakbeg*, or administrator with military powers. Christian Slavs from the neighbouring lands now thronged to the towns, outnumbering the Italian population and introducing their own language, but falling under the influence of the Roman Catholic Church. The pirate community of the Uskoks (*q.v.*) had originally been a band of these fugitives; its exploits contributed to a renewal of war between Venice and Turkey (1571-1573). An extremely curious picture of contemporary manners is presented by the Venetian agents,<sup>1</sup> whose reports on this war resemble some knightly chronicle of the middle ages, full of single combats, tournaments and other chivalrous adventures. They also show clearly that the Dalmatian levies far surpassed the Italian mercenaries in skill and courage. Many of these troops served abroad; at Lepanto, for example, in 1571, a Dalmatian squadron assisted the allied fleets of Spain, Venice, Austria and the Papal States to crush the Turkish navy. A fresh war broke out in 1645, lasting intermittently until 1699, when the peace of Carlowitz gave the whole of Dalmatia to Venice, including the coast of Herzegovina, but excluding the domains of Ragusa and the protecting band of Ottoman territory which surrounded them. After further fighting this delimitation was confirmed in 1718 by the treaty of Passarowitz; and it remains valid, though modified by the destruction of Ragusan liberty and the substitution of Austria-Hungary for Venice and Turkey.

The intellectual life of Dalmatia during the 15th, 16th and 17th centuries reached a higher level than any attained by the purely Slavonic peoples of the Balkan Peninsula. Its chief monuments are described elsewhere,—the work of the Ragusan poets and historians as a part of Servian literature, the scientific achievements of R. G. Boscovich and Marcantonio de Dominis in separate biographies. Architecture and art generally have been discussed above. But this intellectual development was the work of a small and opulent minority in all the cities except Ragusa. Popular education was neglected; Zara had no printing-press until 1796; Venetian Dalmatia possessed only one public school, and that an ecclesiastical seminary; and even the sons of the rich, though free to visit the universities of Italy, France, Holland and England, ran the risk of exile or worse punishment if they brought home too liberal a culture. Poorer students learned what they could from the clergy, and the peasantry were wholly illiterate. Although the secular power of the Church was strictly limited, the country was overrun by ecclesiastics. When Fortis visited the island of Arbe in the 18th century, he found a population of 3000, mostly fishermen, contributing to the stipends of sixty priests. There were also three monasteries and three nunneries. Heavy taxes, the salt monopoly, reckless destruction of timber, and a deliberate attempt to ruin the oil and silk industries, were among the means by which Venice prevented competition with its own trade. Although justice was fairly well administered and some show of municipal autonomy conceded, the right of electing a chief magistrate had been withheld after 1420; and the Grand Council or Senate of each city, losing its original democratic character, had degenerated into a mere tool of the resident Venetian agents (*provveditori*), officials who held their post for thirty-two months and were subject to little effective control. Nevertheless, 150 years of war against the common Turkish enemy had drawn the Venetians and their subjects closely together, and the loyalty of the Dalmatian soldiers and sailors abroad, if not of their fellow-citizens at home, rests beyond doubt.

*Dalmatia after 1797.*—After the fall of the Venetian republic in 1797, the treaty of Campo Formio gave Dalmatia to Austria. The republics of Ragusa and Poglizza retained their independence, and Ragusa grew rich by its neutrality during the earlier Napoleonic wars. By the peace of Pressburg in 1805 the country was handed over to France, but its occupation was ineffectually contested by a Russian force which seized the Bocche di Cattaro and induced the Montenegrins to render aid. Poglizza was

<sup>1</sup> Long extracts from these reports or diaries are published by Wilkinson, *Dalmatia and Montenegro* (London, 1840), ii. 297-350.



deprived of its independence by Napoleon in 1807, Ragusa in 1808. In 1809 the French troops were withdrawn, but in the same year Dalmatia was restored to France and united to the Illyrian kingdom by the treaty of Vienna. A British naval force under Captain Hoste, after a successful engagement with a small French squadron off Lissa, occupied the islands of Curzola, Lesina and Lagosta from 1812 to 1815, and established a considerable overland trade through Dalmatia, Austria and Germany. The allied British and Austrian forces drove out the last French garrison in 1814, and in 1815 Dalmatia was finally incorporated in the Austro-Hungarian empire, with which its history has since been identified. Its subsequent tranquillity has only been disturbed by the ineffectual risings of 1869 and 1881-1882, which took place near Cattaro (*q.v.*). For an account of the development of Croatian nationalism among the Dalmatians, during the 19th and 20th centuries, see CROATIA-SLAVONIA.

**BIBLIOGRAPHY.**—A minute and accurate account of Dalmatian history, art (especially architecture), antiquities and topography, is given by T. G. Jackson, in *Dalmatia, the Quarnero and Istria* (Oxford, 1887), (3 vols. illustrated). E. A. Freeman, *Subject and Neighbour Lands of Venice* (London, 1881), and G. Modrich, *La Dalmazia* (Turin, 1892), describe the chief towns, their history and antiquities. Much miscellaneous information is contained in the following mainly topographical works:—P. Bauron, *Les Rives illyriennes* (Paris, 1888); Sir A. A. Paton, *Highlands and Islands of the Adriatic* (London, 1849); Sir J. G. Wilkinson, *Dalmatia and Montenegro* (London, 1840); A. Fortis, *Travels into Dalmatia* (London, 1778); and the periodicals, *Rivista Dalmatica* (Zara, 1899, &c.), and *Annuario Dalmatico* (Zara, 1884, &c.). The best maps are those of the Austrian General Staff and Vincenzo de Haardt's *Zemljovid Kraljevine Dalmacije* (Zara, 1892). See also for trade, the Annual British Consular Reports; for sport, "Snaffle," *In the Land of the Bora* (London, 1897); for Roman and pre-Roman antiquities, R. Munro, *Bosnia-Herzegovina and Dalmatia* (Edinburgh, 1904). Besides the works mentioned above, and those by Farlati, Makushev, Miklosich, Theiner, Shafarik, Orbin and du Cange, which are quoted under BOSNIA AND HERZEGOVINA, the chief authority for Dalmatian history is G. Lucio (Lucius of Traù), *De regno Dalmatiae et Croatiae, a gentis origine ad annum 1480* (Amsterdam, 1666). To this edition are appended the works of the Presbyter Diocleas, Thomas of Spalato and other native chroniclers from the 12th century onwards. An Italian translation, omitting the appendix, was published at Trieste in 1892, entitled *Storia del Regno di Dalmatia e di Croazia*, and edited by Luigi Cesare. Lucio's work is singularly trustworthy and scientific. See also P. Pisani, *La Dalmatie de 1797 à 1815* (Paris, 1893). (K. G. J.)

**DALMATIC** (Lat. *dalmatica, tunica dalmatica*), a liturgical vestment of the Western Church, proper to deacons, as the tunicle (*tunicella*) is to subdeacons. Dalmatic and tunicle are now, however, practically identical in shape and size; though, strictly, the latter should be somewhat smaller and with narrower arms. In most countries, *e.g.* England, France, Spain and Germany, dalmatic and tunicle are now no longer tunics, but scapular-like cloaks, with an opening for the head to pass through and square lappets falling from the shoulder over the upper part of the arm; in Italy, on the other hand, though open up the side, they still have regular sleeves and are essentially tunics. The most characteristic ornament of the dalmatic and tunicle is the vertical stripes running from the shoulder to the lower hem, these being connected by a cross-band, the position of which differs in various countries (see figs. 3, 4). Less essential are the orphreys on the hem of the arms and the fringes along the slits at the sides and the lower hem. The tassels hanging from either shoulder at the back (see fig. 6), formerly very much favoured, have now largely gone out of use.

The *dalmatica*, which originated—as its name implies—in Dalmatia, came into fashion in the Roman world in the 2nd century A.D. It was a loose tunic with very wide sleeves, and was worn over the *tunica alba* by the better class of citizens (see fig. 2). According to the *Liber pontificalis* (ed. Duchesne, l. 171) the dalmatic was first introduced as a vestment in public worship by Pope Silvester I. (314-335), who ordered it to be worn by the deacons; but Braun (*Liturg. Gewandung*, p. 250) thinks that it was probably in use by the popes themselves so early as the 3rd century, since St Cyprian (d. 258) is mentioned as wearing it when he went to his death. If this be so, it was probably given to the Roman deacons to distinguish them

from the other clergy and to mark their special relations to the pope. However this may be, the dalmatic remained for centuries the vestment distinctive of the pope and his deacons, and—according at least to the view held at Rome—could be worn by other clergy only by special concession of the pope. Thus Pope Symmachus (498-514) granted the right to wear it to the deacons of Bishop Caesarius of Arles; and so late as 757 Pope Stephen II. gave permission to Fulrad, abbot of St Denis, to be assisted by six deacons at mass, and these are empowered to wear "the robe of honour of the dalmatic." How far, however, this rule was strictly observed, and what was the relation of the Roman dalmatic to the diaconal alba and subdiaconal tunica, which were in liturgical use in Gaul and Spain so early as the 6th century, are moot points (see Braun, p. 252). The dalmatic was in general use at the beginning of the 9th century, partly as a result of the Carolingian reforms, which established the Roman model in western Europe; but it continued to be granted by the popes to distinguished ecclesiastics not otherwise entitled to wear it, *e.g.* to abbots or to the cardinal priests of important cathedrals. So far as the records show, Pope John XIII. (965-972) was the first to bestow the right to wear the dalmatic on an abbot, and Pope Benedict VII. the first to grant it to a cardinal priest of a foreign cathedral (975). The present rule was firmly established by the 11th century. According to the actual use of the Roman Catholic Church dalmatic and tunicle are worn by deacon and subdeacon when assisting at High Mass, and at solemn processions and benedictions. They are, however, traditionally vestments symbolical of joy (the bishop in placing the dalmatic on the newly ordained deacon says:—"May the Lord clothe thee in the tunic of joy and the garment of rejoicing"), and they are therefore not worn during seasons of fasting and penitence or functions connected with these, the folded chasuble (*paenula plicata*) being substituted (see CHASUBLE). Dalmatic and tunicle are never worn by priests, as priests, but both are worn by bishops under the chasuble (never under the cope) and also by those prelates, not being bishops, to whom the pope has conceded the right to wear the episcopal vestments.

In England at the Reformation the dalmatic ultimately shared the fate of the chasuble and other mass vestments. It was, however, certainly one of the "ornaments of the minister" in the second year of Edward VI., the rubric in the office for Holy Communion directing the priest's "helpers" to wear "albes with tunacles." In many Anglican churches it has therefore been restored, as a result of the ritual revival of the 19th century, it being claimed that its use is obligatory under the "ornaments rubric" of the Book of Common Prayer (see VESTMENTS).

In the Eastern churches the only vestment that has any true analogy with the dalmatic or liturgical upper tunic is the *sakkos*, the tunic worn by deacons and subdeacons over their everyday clothes being the equivalent of the Western alb (*q.v.*). The *sakkos*, which, as a liturgical vestment, first appears in the 12th century as peculiar to patriarchs, is now a scapular-like robe very similar to the modern dalmatic (see fig. 5). Its origin is almost certainly the richly embroidered dalmatic that formed part of the consular insignia, which under the name of *sakkos* became a robe of state special to the emperors. It is clear, then, that this vestment can only have been assumed with the emperor's permission; and Braun suggests (p. 305) that its use was granted to the patriarchs, after the completion of the schism of East and West, in order "in some sort to give them the character, in outward appearance as well, of popes of the East." Its use is confined to the Greek rite. In the Greek and Greek-Melchite



FIG. 1.—Deacon in dalmatic, apparelled amice and alb.

# DALMATIC

PLATE I.

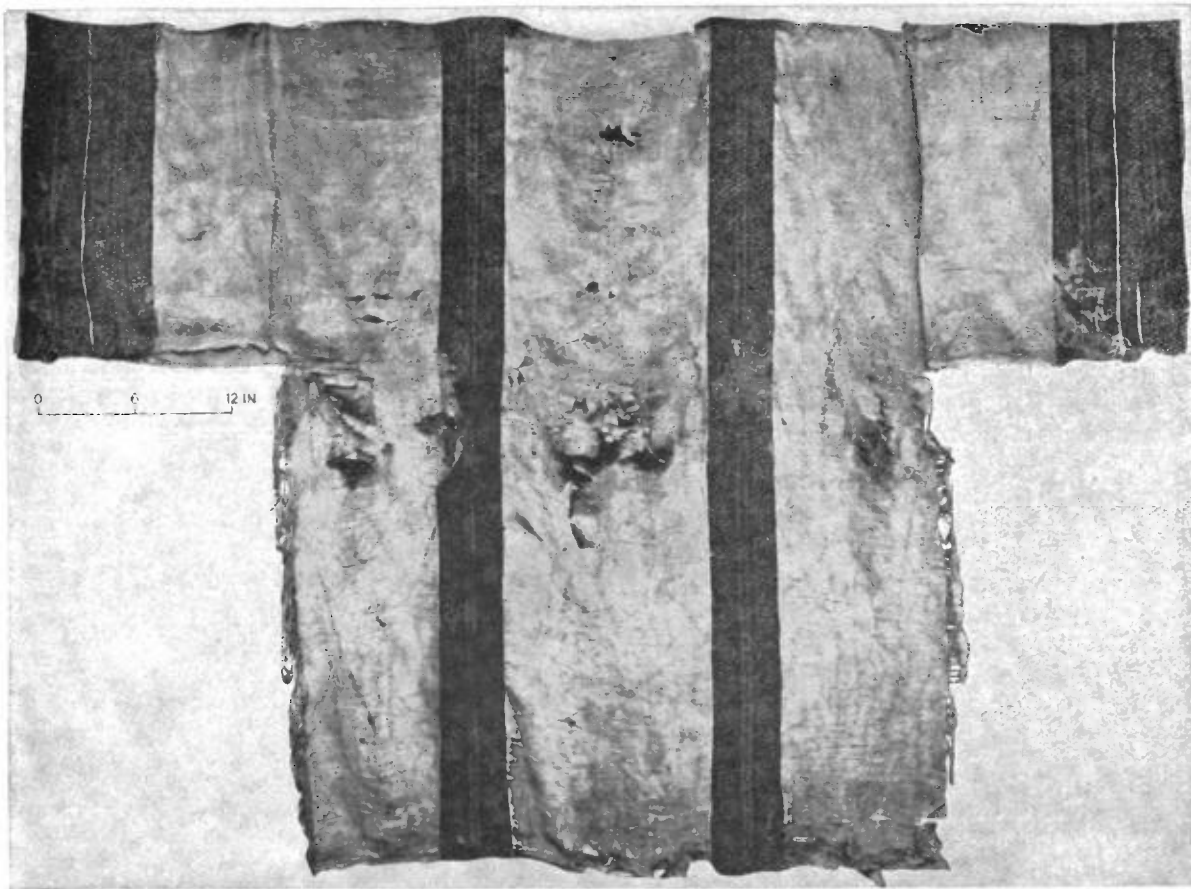

FIG. 2.—TUNIC OF LINEN, WOVEN WITH BANDS OF PURPLE WOOL EMBROIDERED WITH WHITE FLAX. From the tombs at Akhmim. Egypto-Roman; 1st to 4th century. (In the Victoria and Albert Museum.)



FIG. 3.—BACK OF A DALMATIC OF STAMPED GREEN WOOLLEN VELVET: THE ORPHREYS AND APPARELS ARE OF EMBROIDERED SILK VELVET.

The two figures on the cross-band or apparel represent St. Gregory the Great and St. Augustine. The shields of arms are for the dukes of Jülich and Berg, counts of Ravensberg, and for the electors of Bavaria. Said to have come from the church of St. Severin, Cologne. German (Cologne); second half of 15th century. (In the Victoria and Albert Museum)

DALMATIC



FIG. 4.—DALMATIC OF WHITE SATIN EMBROIDERED WITH COLOURED SILKS AND SILVER-GILT AND SILVER THREAD. Spanish; early 17th century. (In the Victoria and Albert Museum.)



FIG. 5.—GREEK SAKKOS, OF RED SATIN EMBROIDERED WITH SILVER-GILT AND SILVER THREAD WITH SILK.

It has the names and arms of two archbishops. 18th century. (In the Victoria and Albert Museum.)



FIG. 6.—DALMATIC OF POPE PIUS V.

An early example of the modern Roman type. Roman; 16th century. Preserved at Santa Maria Maggiore, Rome. From a photograph taken by Father J. Braun (in *Die liturgische Gewandung*), by permission of B. Herder.

churches it is confined to the patriarchs and metropolitans; in the Russian, Ruthenian and Bulgarian churches it is worn by all bishops. Unlike the practice of the Latin church, it is not worn under, but has replaced the phelonion (chasuble).

A silk dalmatic forms one (the undermost) of the English coronation robes. Its use would seem to have been borrowed, not from the robes of the Eastern emperors, but from the church, and to symbolize with the other robes the quasi-sacerdotal character of the kingship (see CORONATION). The magnificent so-called dalmatic of Charlemagne, preserved at Rome (see EMBROIDERY), is really a Greek sakkos.

See Joseph Braun, S.J., *Die liturgische Gewandung* (Freiburg im Breisgau, 1907), pp. 247-305. For further references and illustrations see the article VESTMENTS.

(W. A. P.)

**DALMELLINGTON**, a village of Ayrshire, Scotland, 15 m. S.E. of Ayr by a branch line, of which it is the terminus, of the Glasgow & South-Western railway. Pop. (1901) 1448. The district is rich in minerals—coal, ironstone, sandstone and limestone. Though the place is of great antiquity, the Roman road running near it, few remains of any interest exist. It was, however, a centre of activity in the Covenanted times.

**DALOU, JULES** (1838-1902), French sculptor, was the pupil of Carpeaux and Duret, and combined the vivacity and richness of the one with the academic purity and scholarship of the other. He is one of the most brilliant virtuosos of the French school, admirable alike in taste, execution and arrangement. He first exhibited at the Salon in 1867, but when in 1871 the troubles of the Commune broke out in Paris, he took refuge in England, where he rapidly made a name through his appointment at South Kensington. Here he laid the foundation of that great improvement which resulted in the development of the modern British school of sculpture, and at the same time executed a remarkable series of terra-cotta statuettes and groups, such as "A French Peasant Woman" (of which a bronze version under the title of "Maternity" is erected outside the Royal Exchange), the group of two Boulogne women called "The Reader" and "A Woman of Boulogne telling her Beads." He returned to France in 1879 and produced a number of masterpieces. His great relief of "Mirabeau replying to M. de Dreux-Brézé," exhibited in 1883 and now at the Palais Bourbon, and the highly decorative panel, "Triumph of the Republic," were followed in 1885 by "The Procession of Silenus." For the city of Paris he executed his most elaborate and splendid achievement, the vast monument, "The Triumph of the Republic," erected, after twenty years' work, in the Place de la Nation, showing a symbolical figure of the Republic, aloft on her car, drawn by lions led by Liberty, attended by Labour and Justice, and followed by Peace. It is somewhat in the taste of the Louis XIV. period, ornate, but exquisite in every detail. Within a few days there was also inaugurated his great "Monument to Alphan" (1899), which almost equalled in the success achieved the monument to Delacroix in the Luxembourg Gardens. Dalou, who gained the *Grand Prix* of the International exhibition of 1889, and was an officer of the Legion of Honour, was one of the founders of the New Salon (*Société Nationale des Beaux-Arts*), and was the first president of the sculpture section. In portraiture, whether statues or busts, his work is not less remarkable.

**DALRADIAN**, in geology, a series of metamorphic rocks, typically developed in the high ground which lies E. and S. of the Great Glen of Scotland. This was the old Celtic region of Dalradia, and in 1891 Sir A. Geikie proposed the name Dalradian as a convenient provisional designation for the complicated set of rocks to which it is difficult to assign a definite position in the stratigraphical sequence (*Q.J.G.S.* 47, p. 75). In Sir A. Geikie's words, "they consist in large proportion of altered sedimentary strata, now found in the form of mica-schist, graphite-schist, andalusite-schist, phyllite, schistose grit, grey-wacke and conglomerate, quartzite, limestone and other rocks, together with epidiorites, chlorite-schists, hornblende schists and other allied varieties, which probably mark sills, lava-sheets or beds of tuff, intercalated among the sediments. The total thickness of this assemblage of rocks must be many

thousand feet." The Dalradian series includes the "Eastern or Younger schists" of eastern Sutherland, Ross-shire and Inverness-shire—the Moine gneiss, &c.—as well as the metamorphosed sedimentary and eruptive rocks of the central, eastern and south-western Highlands. The series has been traced into the north-western counties of Ireland. The whole of the Dalradian complex has suffered intense crushing and thrusting.

See PRE-CAMBRIAN; also J. B. Hill, *Q.J.G.S.*, 1899, 55, and G. Barrow, *loc. cit.*, 1901, 57, and the *Annual Reports and Summaries of Progress of the Geological Survey of the United Kingdom* from 1893 onwards.

**DALRIADA**, the name of two ancient Gaelic kingdoms, one in Ireland and the other in Scotland. The name means the home of the descendants of Riada. Irish Dalriada was the district which now forms the northern part of county Antrim, and from which about A.D. 500 some emigrants crossed over to Scotland, and founded in Argyllshire the Scottish kingdom of Dalriada. For a time Scottish Dalriada appears to have been dependent upon Irish Dalriada, but about 575 King Aidan secured its independence. One of Aidan's successors, Kenneth, became king of the Picts about 843, and gradually the name Dalriada both in Ireland and Scotland fell into disuse.

See W. F. Skene, *Celtic Scotland* (Edinburgh, 1876-1880).

**DALRY** (Gaelic, "the field of the king"), a mining and manufacturing town of Ayrshire, Scotland, on the Garnock, 23½ m. S.W. of Glasgow, by the Glasgow & South-Western railway. Pop. (1901) 5316. The public buildings include the library and reading-room, the assembly rooms, Davidshill hospital, Temperance hall and night asylum. There is a public park. The industries consist of woollen factories, worsted spinning, box-, cabinet-, coke- and brick-making, machine-knitting, currying and the manufacture of aerated waters. Coal and iron are found, but mining is not extensively pursued. In the vicinity are the iron works of Blair and Glengarnock, and a curious stalactite cave, known as Elf House, 30 ft. high and about 200 ft. long, offering some resemblance to a pointed aisle. Rye Water flows into the Garnock close to the town. Captain Thomas Crawford of Jordanhill (1530-1603), the captor of Dumbarton Castle, spent the closing years of his life at Dalry, where a considerable estate had been granted to him.

**DALTON, JOHN** (1766-1844), English chemist and physicist, was born about the 6th of September 1766 at Eaglesfield, near Cockermonth in Cumberland. His father, Joseph Dalton, was a weaver in poor circumstances, who, with his wife (Deborah Greenup), belonged to the Society of Friends; they had three children—Jonathan, John and Mary. John received his early education from his father and from John Fletcher, teacher of the Quakers' school at Eaglesfield, on whose retirement in 1778 he himself started teaching. This youthful venture was not successful, the amount he received in fees being only about five shillings a week, and after two years he took to farm work. But he had received some instruction in mathematics from a distant relative, Elihu Robinson, and in 1781 he left his native village to become assistant to his cousin George Bewley who kept a school at Kendal. There he passed the next twelve years, becoming in 1785, through the retirement of his cousin, joint manager of the school with his elder brother Jonathan. About 1790 he seems to have thought of taking up law or medicine, but his projects met with no encouragement from his relatives and he remained at Kendal till, in the spring of 1793, he moved to Manchester, where he spent the rest of his life. Mainly through John Gough (1757-1825), a blind philosopher to whose aid he owed much of his scientific knowledge, he was appointed teacher of mathematics and natural philosophy at the New College in Moseley Street (in 1889 transferred to Manchester College, Oxford), and that position he retained until the removal of the college to York in 1799, when he became a "public and private teacher of mathematics and chemistry."

During his residence in Kendal, Dalton had contributed solutions of problems and questions on various subjects to the *Gentlemen's* and *Ladies' Diaries*, and in 1787 he began to keep a meteorological diary in which during the succeeding fifty-seven



years he entered more than 200,000 observations. His first separate publication was *Meteorological Observations and Essays* (1793), which contained the germs of several of his later discoveries; but in spite of the originality of its matter, the book met with only a limited sale. Another work by him, *Elements of English Grammar*, was published in 1801. In 1794 he was elected a member of the Manchester Literary and Philosophical Society, and a few weeks after election he communicated his first paper on "Extraordinary facts relating to the vision of colours," in which he gave the earliest account of the optical peculiarity known as Daltonism or colour-blindness, and summed up its characteristics as observed in himself and others. Besides the blue and purple of the spectrum he was able to recognize only one colour, yellow, or, as he says in his paper, "that part of the image which others call red appears to me little more than a shade or defect of light; after that the orange, yellow and green seem one colour which descends pretty uniformly from an intense to a rare yellow, making what I should call different shades of yellow." This paper was followed by many others on diverse topics—on rain and dew and the origin of springs, on heat, the colour of the sky, steam, the auxiliary verbs and participles of the English language and the reflection and refraction of light. In 1800 he became a secretary of the society, and in the following year he presented the important paper or series of papers, entitled "Experimental Essays on the constitution of mixed gases; on the force of steam or vapour of water and other liquids in different temperatures, both in Torricellian vacuum and in air; on evaporation; and on the expansion of gases by heat." The second of these essays opens with the striking remark, "There can scarcely be a doubt entertained respecting the reducibility of all elastic fluids of whatever kind, into liquids; and we ought not to despair of effecting it in low temperatures and by strong pressures exerted upon the unmixed gases"; further, after describing experiments to ascertain the tension of aqueous vapour at different points between 32° and 212° F., he concludes, from observations on the vapour of six different liquids, "that the variation of the force of vapour from all liquids is the same for the same variation of temperature, reckoning from vapour of any given force." In the fourth essay he remarks, "I see no sufficient reason why we may not conclude that all elastic fluids under the same pressure expand equally by heat and that for any given expansion of mercury, the corresponding expansion of air is proportionally something less, the higher the temperature. . . . It seems, therefore, that general laws respecting the absolute quantity and the nature of heat are more likely to be derived from elastic fluids than from other substances." He thus enunciated the law of the expansion of gases, stated some months later by Gay-Lussac. In the two or three years following the reading of these essays, he published several papers on similar topics, that on the "Absorption of gases by water and other liquids" (1803), containing his "Law of partial pressures."

But the most important of all Dalton's investigations are those concerned with the Atomic Theory in chemistry, with which his name is inseparably associated. It has been supposed that this theory was suggested to him either by researches on olefiant gas and carburetted hydrogen or by analysis of "protoxide and deutoxide of azote," both views resting on the authority of Dr Thomas Thomson (1773-1852), professor of chemistry in Glasgow university. But from a study of Dalton's own MS. laboratory notebooks, discovered in the rooms of the Manchester society, Roscoe and Harden (*A New View of the Origin of Dalton's Atomic Theory*, 1896) conclude that so far from Dalton being led to the idea that chemical combination consists in the approximation of atoms of definite and characteristic weight by his search for an explanation of the law of combination in multiple proportions, the idea of atomic structure arose in his mind as a purely physical conception, forced upon him by study of the physical properties of the atmosphere and other gases. The first published indications of this idea are to be found at the end of his paper on the "Absorption of gases" already mentioned, which was read on the 21st of October 1803

though not published till 1805. Here he says: "Why does not water admit its bulk of every kind of gas alike? This question I have duly considered, and though I am not able to satisfy myself completely I am nearly persuaded that the circumstance depends on the weight and number of the ultimate particles of the several gases." He proceeds to give what has been quoted as his first table of atomic weights, but on p. 248 of his laboratory notebooks for 1802-1804, under the date 6th of September 1803, there is an earlier one in which he sets forth the relative weights of the ultimate atoms of a number of substances, derived from analysis of water, ammonia, carbon-dioxide, &c. by chemists of the time. It appears, then, that, confronted with the "problem of ascertaining the relative diameter of the particles of which, he was convinced, all gases were made up, he had recourse to the results of chemical analysis. Assisted by the assumption that combination always takes place in the simplest possible way, he thus arrived at the idea that chemical combination takes place between particles of different weights, and this it was which differentiated his theory from the historic speculations of the Greeks. The extension of this idea to substances in general necessarily led him to the law of combination in multiple proportions, and the comparison with experiment brilliantly confirmed the truth of his deduction" (*A New View, &c.*, pp. 50, 51). It may be noted that in a paper on the "Proportion of the gases or elastic fluids constituting the atmosphere," read by him in November 1802, the law of multiple proportions appears to be anticipated in the words—"The elements of oxygen may combine with a certain portion of nitrous gas or with twice that portion, but with no intermediate quantity," but there is reason to suspect that this sentence was added some time after the reading of the paper, which was not published till 1805.

Dalton communicated his atomic theory to Dr Thomson, who by consent included an outline of it in the third edition of his *System of Chemistry* (1807), and Dalton gave a further account of it in the first part of the first volume of his *New System of Chemical Philosophy* (1808). The second part of this volume appeared in 1810, but the first part of the second volume was not issued till 1827, though the printing of it began in 1817. This delay is not explained by any excess of care in preparation, for much of the matter was out of date and the appendix giving the author's latest views is the only portion of special interest. The second part of vol. ii. never appeared.

Altogether Dalton contributed 116 memoirs to the Manchester Literary and Philosophical Society, of which from 1817 till his death he was the president. Of these the earlier are the most important. In one of them, read in 1814, he explains the principles of volumetric analysis, in which he was one of the earliest workers. In 1840 a paper on the phosphates and arsenates, which was clearly unworthy of him, was refused by the Royal Society, and he was so incensed that he published it himself. He took the same course soon afterwards with four other papers, two of which—"On the quantity of acids, bases and salts in different varieties of salts" and "On a new and easy method of analysing sugar," contain his discovery, regarded by him as second in importance only to the atomic theory, that certain anhydrous salts when dissolved in water cause no increase in its volume, his inference being that the "salt enters into the pores of the water."

As an investigator, Dalton was content with rough and inaccurate instruments, though better ones were readily attainable. Sir Humphry Davy described him as a "very coarse experimenter," who "almost always found the results he required, trusting to his head rather than his hands." In the preface to the second part of vol. i. of his *New System* he says he had so often been misled by taking for granted the results of others that he "determined to write as little as possible but what I can attest by my own experience," but this independence he carried so far that it sometimes resembled lack of receptivity. Thus he distrusted, and probably never fully accepted, Gay-Lussac's conclusions as to the combining volumes of gases; he held peculiar and quite unfounded views about chlorine, even after



its elementary character had been settled by Davy; he persisted in using the atomic weights he himself had adopted, even when they had been superseded by the more accurate determinations of other chemists; and he always objected to the chemical notation devised by J. J. Berzelius, although by common consent it was much simpler and more convenient than his cumbersome system of circular symbols. His library, he was once heard to declare, he could carry on his back, yet he had not read half the books it contained.

Before he had propounded the atomic theory he had already attained a considerable scientific reputation. In 1804 he was chosen to give a course of lectures on natural philosophy at the Royal Institution in London, where he delivered another course in 1809-1810. But he was deficient, it would seem, in the qualities that make an attractive lecturer, being harsh and indistinct in voice, ineffective in the treatment of his subject, and "singularly wanting in the language and power of illustration." In 1810 he was asked by Davy to offer himself as a candidate for the fellowship of the Royal Society, but declined, possibly for pecuniary reasons; but in 1822 he was proposed without his knowledge, and on election paid the usual fee. Six years previously he had been made a corresponding member of the French Academy of Sciences, and in 1830 he was elected as one of its eight foreign associates in place of Davy. In 1833 Lord Grey's government conferred on him a pension of £150, raised in 1836 to £300. Never married, though there is evidence that he delighted in the society of women of education and refinement, he lived for more than a quarter of a century with his friend the Rev. W. Johns (1771-1845), in George Street, Manchester, where his daily round of laboratory work and tuition was broken only by annual excursions to the Lake district and occasional visits to London, "a surprising place and well worth one's while to see once, but the most disagreeable place on earth for one of a contemplative turn to reside in constantly." In 1822 he paid a short visit to Paris, where he met many of the distinguished men of science then living in the French capital, and he attended several of the earlier meetings of the British Association at York, Oxford, Dublin and Bristol. Into society he rarely went, and his only amusement was a game of bowls on Thursday afternoons. He died in Manchester in 1844 of paralysis. The first attack he suffered in 1837, and a second in 1838 left him much enfeebled, both physically and mentally, though he remained able to make experiments. In May 1844 he had another stroke; on the 26th of July he recorded with trembling hand his last meteorological observation, and on the 27th he fell from his bed and was found lifeless by his attendant. A bust of him, by Chantrey, was publicly subscribed for in 1833 and placed in the entrance hall of the Manchester Royal Institution.

See Henry, *Life of Dalton*, Cavendish Society (1854); Angus Smith, *Memoir of John Dalton and History of the Atomic Theory* (1856), which on pp. 253-263 gives a list of Dalton's publications; and Roscoe and Harden, *A New View of the Origin of Dalton's Atomic Theory* (1896); also ATOM.

**DALTON**, a city and the county-seat of Whitfield county, Georgia, U.S.A., in the N.W. part of the state, 100 m. N.N.W. of Atlanta. Pop. (1890) 3046; (1900) 4315 (957 negroes); (1910) 5324. Dalton is served by the Southern, the Nashville, Chattanooga & St Louis, and the Western & Atlanta (operated by the Nashville, Chattanooga & St Louis) railways. The city is in a rich agricultural region; ships cotton, grain, fruit and ore; and has various manufactures, including canned fruit and vegetables, flour and foundry and machine shop products. It is the seat of Dalton Female College. Dalton was founded by Duff Green and others in 1848, and was incorporated in 1874. Hither General Braxton Bragg retreated after his defeat at Chattanooga in the last week of November 1863. Three weeks afterwards Bragg, in command of the army in northern Georgia in winter quarters here, was replaced by General Joseph E. Johnston, who, with his force of 54,400, adopted defensive tactics to meet Sherman's invasion of Georgia, with his 99,000 or 100,000 men in the Army of the Cumberland (60,000) under General G. H. Thomas, the Army of the Tennessee (25,000) under General J. B. M'Pherson, and the Army of the Ohio (14,000) under General J. M. Schofield. The

Federal forces stretched for 20 m. in a position south of Ringgold and between Ringgold and Dalton. Johnston's line of defences included Rocky Face Ridge, a wall of rock through which the railway passes about 5 m. north-west of the city, Mill Creek (1 m. north-north-west of Dalton), which he dammed so that it could not be forded, and earthworks north and east of the city. On the 7th of May General M'Pherson started for Resaca, 18 m. south of Dalton, to occupy the railway there in Johnston's rear, but he did not attack Resaca, thinking it too strongly protected; Thomas, with Schofield on his left, on the 7th forced the Confederates through Buzzard's Roost Gap (the pass at Mill Creek) north-west of Dalton; at Dug Gap, 4 m. south-west of Dalton, on the 8th a fierce Federal assault under Brigadier-General John W. Geary failed to dislodge the Confederates from a quite impregnable position. On the 11th the main body of Sherman's army followed M'Pherson toward Resaca, and Johnston, having evacuated Dalton on the night of the 12th, was thus forced, after five days' manoeuvring and skirmishing, to march to Resaca and to meet Sherman there.

See J. D. Cox, *The Atlanta Campaign* (New York, 1882); Johnson and Buel, *Battles and Leaders of the Civil War* (4 vols., New York, 1887); and *Official Records of the War of the Rebellion*, series 1, vols. 32, 38, 39, 45, 49; series ii., vol. 8.

**DALTON-IN-FURNESS**, a market town in the North Lonsdale parliamentary division of Lancashire, England, 4 m. N.E. by N. of Barrow-in-Furness by the Furness railway. Pop. of urban district (1901) 13,020. The church of St Mary is in the main a modern reconstruction, but retains ancient fragments and a font believed to have belonged to Furness Abbey. This fine ruin lies 3 m. south of Dalton (see FURNESS). St Mary's churchyard contains the tomb of the painter George Romney, a native of the town. Of Dalton Castle there remains a square tower, showing decorated windows. Here was held the manorial court of Furness Abbey. There are numerous iron-ore mines in the parish, and ironworks at Askam-in-Furness, in the northern part of the district.

**DALY, AUGUSTIN** (1838-1899), American theatrical manager and playwright, was born in Plymouth, North Carolina, on the 20th of July 1838. He was dramatic critic for several New York papers from 1859, and he adapted or wrote a number of plays, *Under the Gaslight* (1867) being his first success. In 1869 he was the manager of the Fifth Avenue theatre, and in 1879 he built and opened Daly's theatre in New York, and, in 1893, Daly's theatre in London. At the former he gathered a company of players, headed by Miss Ada Rehan, which made for it a high reputation, and for them he adapted plays from foreign sources, and revived Shakespearean comedies in a manner before unknown in America. He took his entire company on tour, visiting England, Germany and France, and some of the best actors on the American stage have owed their training and first successes to him. Among these were Clara Morris, Sara Jewett, John Drew, Fanny Davenport, Maude Adams, Mrs Gilbert and many others. Daly was a great book-lover, and his valuable library was dispersed by auction after his death, which occurred in Paris on the 7th of June 1899. Besides plays, original and adapted, he wrote *Woffington: a Tribute to the Actress and the Woman* (1888).

**DALYELL** (or DALZIELL or DALZELL), **THOMAS** (d. 1685), British soldier, was the son of Thomas Dalyell of Binns, Linlithgowshire, a cadet of the family of the earls of Carnwath, and of Janet, daughter of the 1st Lord Bruce of Kinloss, master of the rolls in England. He appears to have accompanied the Rochelle expedition in 1628, and afterwards, becoming colonel, served under Robert Munro, the general in Ireland. He was taken prisoner at the capitulation of Carrickfergus in August 1650, but was given a free pass, and having been banished from Scotland remained in Ireland. He was present at the battle of Worcester (3rd of September 1651), where his men surrendered, and he himself was captured and imprisoned in the Tower. In May he escaped abroad, and in 1654 took part in the Highland rebellion and was excepted from Cromwell's act of grace, a reward of £200 being offered for his capture, dead or alive. The king's cause being now for the time hopeless, Dalyell entered the

service of the tsar of Russia, and distinguished himself as general in the wars against the Turks and Tatars. He returned to Charles in 1665, and on the 19th of July 1666 he was appointed commander-in-chief in Scotland to subdue the Covenanters. He defeated them at Rullion Green and exercised his powers with great cruelty, his name becoming a terror to the peasants. He obtained several of the forfeited estates. On the 3rd of January 1667 he was made a privy councillor, and from 1678 till his death represented Linlithgow in the Scottish parliament. He was incensed by the choice of the duke of Monmouth as commander-in-chief in June 1679, and was confirmed in his original appointment by Charles, but in consequence did not appear at Bothwell Bridge till after the close of the engagement. On the 25th of November 1681, a commission was issued authorizing him to enrol the regiment afterwards known as the Scots Greys. He was continued in his appointment by James II., but died soon after the latter's accession in August 1685. He married Agnes, daughter of John Ker of Cavers, by whom he had a son, Thomas, created a baronet in 1685, whose only son and heir, Thomas, died unmarried. The baronetage apparently became extinct, but it was assumed about 1726 by James Menteith, a son of the sister of the last baronet, who took the name of Dalryell; his last male descendant, Sir Robert Dalryell, died unmarried in 1886.

**DAM.** (1) (A common Teutonic word, cf. Swed. and Ger. *dam*, and the Gothic verb *faurdammjan*, to block up), a barrier of earth or masonry erected to restrain, divert or contain a body of water, particularly in order to form a reservoir. (2) (Fr. *dame*, dame; Lat. *domina*, feminine of *dominus*, lord, master), the mother of an animal, now chiefly used of the larger quadrupeds, and particularly of a mare, the mother of a foal.

**DAMAGES** (through O. Fr. *damage*, mod. Fr. *dommage*, from Lat. *damnum*, loss), the compensation which a person who has suffered a legal wrong is by law entitled to recover from the person responsible for the wrong. Loss caused by an act which is not a legal wrong (*damnum sine injuria*) is not recoverable, e.g. where a father loses a young child by the negligence of a third party.

The principle of compensation in law makes its first appearance as a substitute for personal retaliation. In primitive law something of the nature of the Anglo-Saxon *wer-gild*, or the *rowi* of the *Iliad*, appears to be universal. It marks out with great minuteness the measure of the compensation appropriate to each particular case of personal injury. And there is a resemblance between the legal compensation, as it may be called, and the compensation which an injured person, seeking his own remedy, would be likely to exact for himself. In such a system the two entirely different objects of personal satisfaction and criminal punishment are not clearly separated, and in fact, criminal and civil remedies were administered in the same proceeding.

Under modern systems of law, the object of legal compensation is to place the injured person as nearly as possible in the situation in which he would have been but for the injury; and the controlling principle is that compensation should be determined so far as possible by the actual amount of the loss sustained. In England, civil proceedings for reparation and criminal proceedings for punishment are with few exceptions carefully kept separate. In Scotland, pursuit of the two kinds of remedies in the same proceeding is possible but very rare; but in France and other European states it is lawful and usual in the case of those delicts which are also punishable criminally.

In the law of England the two historical systems of common law and equity viewed compensation or reparation from two different points of view. The principle of the common law was that the amount of every injury might be estimated by pecuniary valuation. The idea was no doubt derived from the old tariffs of *were*, *bot* and *wite*, in which the valuations were elaborate. Until 1858 (Cairns' Act) courts of equity had no direct jurisdiction to award damages, and their business was to place the injured party in the actual position to which he was entitled (*restitutio ad integrum*). This difference comes out most clearly

in cases of breach of contract. The common law, with a few partial exceptions, could do no more than compel the defaulter to make good the loss of the other party, by paying him an ascertained sum of money as damages. Equity, recognizing the fact that complete satisfaction was not in all cases to be obtained by mere money payment, compelled those who broke certain classes of contracts specifically to perform them, and in the case of acts or defaults not amounting to breach of contract, on satisfactory proof that a wrong was contemplated, would interfere to prevent it by injunction; while at common law no action could be brought until the injury was accomplished, and then only pecuniary damages could be obtained. Since the Judicature Acts this distinction has ceased and the appropriate remedy may be awarded in any division of the High Court of Justice.

Under the common law damages were always assessed by a jury. Under the existing procedure in England they may be assessed (1) by a jury under the directions of a judge; (2) by a judge alone or sitting with assessors; (3) by a referee, official or special, or officer of the courts with or without the assistance of mercantile or other assessors; (4) by a consensual tribunal such as an arbitrator or valuer selected by the parties. Whatever the mode of assessment, it is subject to review if the assessors have clearly mistaken the proper measure of damage.

In the case of assessment by a jury, the verdict may be set aside because the damages are clearly excessive or palpably insufficient, or arrived at by some irregular conduct, e.g. by setting down the sum which each jurymen would give and dividing the result by twelve. The appellate court, however, cannot, without the consent of the parties, itself fix the amount of damages in a case which has been submitted to a jury (*Watt v. Watt*, 1905, Appeal Cases 115).

The courts have gradually evolved certain rules or principles for the proper assessment of damages, although extreme difficulty is found in their application to concrete cases. A distinction is drawn between *general* and *special* damages. (1) General damage is that *implied by law* as necessarily flowing from the breach of right, and requiring no proof. (2) Special damage is that *in fact* caused by the wrong. Under existing practice this form of damage cannot be recovered unless it has been specifically claimed and proved, or unless the best available particulars or details have been before trial communicated to the party against whom it is claimed.

*Contracts.*—"The law imposes or implies a term that upon breach of contract damages must be paid." The general tendency of legal decisions in cases of contract is (i.) to make the amount of damages which may be awarded a matter of legal certainty, (ii.) to leave to a jury or like tribunal little more to do than find the facts, (iii.) and to revise the assessment if it is clear that it has been made in disregard of the terms of the contract or of the natural and direct consequences of the breach. The measure of damage, general speaking, is the sum necessary to place the aggrieved party in the same position so far as money will do it as if the contract had been performed. If the breach is proved, but the person complaining has suffered no real damage, he is entitled to have his legal right recognized by an award of what are called *nominal damages*, i.e. a sum just sufficient to carry a judgment in his favour on the infraction of his rights. Nominal damages, it will therefore be seen, are not the same as "small damages." He is, however, also entitled to prove and recover the special or particular damage lawfully attributable to the breach. Where the contract is to pay a fixed sum of money or liquidated amount, the measure of damages for non-payment is the sum agreed to be paid and interest thereon at the rate stipulated in the contract or recognized by law.

The law is the same in Scotland and in France (Civil Code, art. 1153). In some contracts the parties themselves fix the sum to be paid as damages if the contract is not fulfilled. These damages are described as *liquidated*, in Scots law *stipulated* or *estimated*. It would be supposed that the sum thus fixed would be the proper damages to be awarded. And under the French

Civil Code (arts. 1152, 1153, 1780) the stipulation of the parties as to the damages to be paid for breach of a stipulation other than for paying a sum of money is binding on the courts. But in England, Scotland and the United States, courts disregard the words used, and inquire into the real nature of the transaction in order to see whether the sum fixed is to be treated as ascertained damage or as a penalty to be held *in terrorem* over the defaulter, and in the latter case, notwithstanding the stipulation, will require proof of the actual loss. In *Kemble v. Farren* (1829, 6 Bingham, 141), a contract between a manager and an actor provided that for a breach of any of the stipulations therein, the sum of £1000 should be payable by the defaulter, not as a penalty, but as liquidated and ascertained damages. Yet, the court, observing that under the stipulations of the contract the sum of £1000, if it were taken to be liquidated damages, might become payable for mere non-payment of a trifling sum, held that it was not fixed as damages, but as a penalty only. The case in which an agreed sum is most usually treated as a penalty is a bond to pay a fixed sum containing a condition that it shall be void if certain acts are done or a certain smaller sum paid. Another case is where a single lump sum is fixed as the liquidated amount of damage to be paid for doing or failing to do a number of different things of very varying degrees of importance (*Elphinstone v. Monkland Iron Co.*, 1887, 11 A.C. 333). But the courts have accepted as creating a contractual measure of damage a stipulation to finish sewerage works by a given day (*Law v. Redditch Local Board*, 1892, 1 Q.B. 127); or to complete torpedo boats within a limited time for a foreign government (*Clydebank Engineering Co. v. Yzquierda*, 1905, A.C. 6). In this last case the law lords indicated that the provision of an agreed sum was peculiarly appropriate in view of the difficulty of showing the exact damage which a state sustains by non-delivery of a warship. Where the damage is not liquidated or agreed it is assessed to upon evidence as to the actual loss naturally and directly flowing from the breach of contract.

In contracts for the sale of goods the measure of damages is fixed by statute. Where the buyer wrongfully refuses or neglects to accept and pay for, or the seller wrongfully neglects or refuses to deliver the goods, the measure is the estimated loss directly and naturally resulting in the ordinary course of events from the buyer's or seller's breach of contract. Where there is an available market for the goods in question, the measure of damages is prima facie to be ascertained by the difference between the contract price and the market or current price at the time or times when the goods ought to have been accepted or delivered, or if no such time was fixed for acceptance or delivery, then at the time of refusal to accept or deliver (Sale of Goods Act 1893, §§ 50, 51).

Where there is no market, the value is fixed by the price of the nearest available substitute. Where the sufferer, at the request of the person in default, postpones purchase or sale, any increased loss thereby caused falls on the defaulter. If the buyer, before the time fixed for delivery, has resold the goods to a sub-vendor, he cannot claim against his own vendor any damages which the sub-vendor may recover against him for breach of contract, because he ought to have gone into the market and purchased other goods. But this is subject to modification in cases falling within the rule in *Hadley v. Baxendale* (1854, 9 Exchequer, 341). But trouble and expense incurred by the seller of finding a new purchaser or other goods may be taken account of in assessing the damages.

Where the goods delivered are not as contracted the buyer may as a rule sue the seller for a breach of warranty, or set it up as reduction of price. Where the warranty is of quality the loss is prima facie the difference between the value of the goods delivered when delivered and the value which they would have then had if they had answered to the warranty (Sale of Goods Act 1893, § 53). In an American case, where a person had agreed with a boarding-house keeper for a year, and quitted the house within the time, it was held that the measure of damages was not the price stipulated to be paid, but only the loss caused by the breach of contract. In contracts to marry, a special class of

considerations is recognized, and the jury in assessing damages will take notice of the conduct of the parties. The social position and means of the defendant may be given in evidence to show what the plaintiff has lost by the breach of contract.

On a breach of contract to replace stock lent, the measure of damages is the price of the stock on the day when it ought to have been delivered, or on the day of trial, at the plaintiff's option.

In contracts for the sale of realty, the measure of damage for breach by the vendor is the amount of any deposit paid by the would-be purchaser and of the expenses thrown away. But the purchaser may, in a proper case, obtain specific performance, and if he has been cheated may obtain damages in an action for deceit.

Breaches of trust are in a sense distinct from breaches of contract, as they fell under the jurisdiction of courts of equity and not of the common law courts. The rule applied was to require a defaulting trustee to make good to the beneficiaries any loss flowing from a breach of trust and not to allow him to set off against this liability any gain to the trust fund resulting from a different breach of trust or from good management (*Lewin on Trusts*, ed. 1904. 1146).

In estimating the proper amount to be assessed as damages for a breach of contract, it is not permissible to include every loss caused by the act or default upon which the claim for damages is based. The damage to be awarded must be that fairly and naturally arising from the breach under ordinary circumstances or the special circumstances of the particular contract, or in other words, which may reasonably be supposed to have been in the contemplation of the parties at the time of making the contract. The chief authority for this rule is the case of *Hadley v. Baxendale* (1854, 9 Exch. 341), which has been accepted in Scotland and the United States and throughout the British empire, and often differs little, if at all, from the rule adopted in the French civil code (art. 1150). In that case damages were sought for the loss of profits caused by a steam mill being kept idle, on account of the delay of the defendants in sending a new shaft which they had contracted to make. The court held the damage to be too remote, and stated the proper rule as follows:—

“Where two parties have made a contract which one of them has broken, the damages which the other party ought to receive in respect of such breach of contract should be such as may fairly and reasonably be considered either arising naturally, *i.e.* according to the usual course of things, from such breach of contract itself, or such as may reasonably be supposed to have been in the contemplation of both parties at the time they made the contract as the probable result of the breach of it. Now if the special circumstances under which the contract was actually made were communicated by the plaintiffs to the defendants, and thus known to both parties, the damages resulting from such contract which they would reasonably contemplate would be the amount of injury which would ordinarily flow from a breach of contract under these special circumstances so known and communicated. But on the other hand, if those special circumstances were wholly unknown to the party breaking the contract, he at the most could only be supposed to have had in his mind the amount of injury which would arise generally, and in the great multitude of cases not affected by any special circumstances, from such breach of contract.”<sup>1</sup>

The rule is, however, only a general guide, and does not obviate the necessity of inquiring in each case what are the natural or contemplated damages. In an action by the proprietor of a theatre, it was alleged that the defendant had written a libel on one of the plaintiff's singers, whereby she was

<sup>1</sup> In the Indian Contracts Code (Act xii. of 1872), the rule is thus summarized:—

“When a contract has been broken, the party who suffers by such breach is entitled to receive from the party who has broken the contract, compensation for any loss or damage caused to him thereby, which naturally arose in the usual course of things from such breach, or which the parties knew when they made the contract to be likely to result from the breach of it. Such compensation is not to be given for any remote or indirect loss or damage sustained by reason of the breach. . . . In estimating the loss or damage arising from a breach of contract, the means of remedying the inconvenience caused by the non-performance must be taken into account” (§ 73).

deterred from appearing on the stage, and the plaintiff lost his profits; such loss was held to be too remote to be the ground of an action for damages. In *Smeed v. Foord* (1 Ellis and Ellis, 602), the defendant contracted to deliver a threshing-machine to the plaintiff, a farmer, knowing that it was needed to thresh the wheat in the field. Damages were sought for injury done to the wheat by rain in consequence of the machine not having been delivered in time, and also for a fall in the market before the grain could be got ready. It was held that the first claim was good, as the injury might have been anticipated, but that the second was bad. When, through the negligence of a railway company in delivering bales of cotton, the plaintiffs, having no cotton to work with, were obliged to keep their workmen unemployed, it was held that the wages paid and the profits lost were too remote for damages. On the other hand, where the defendant failed to keep funds on hand to meet the drafts of the plaintiff, so that a draft was returned dishonoured, and his business in consequence was for a time suspended and injured, the plaintiff was held entitled to recover damage for such loss.

The rule that the contract furnishes the measure of the damages does not prevail in the case of unconscionable, *i.e.* unreasonable, absurd or impossible contracts. The old school-book juggle in geometrical progression has more than once been before the courts as the ground of an action. Thus, when a man agreed to pay for a horse a barley-corn per nail, doubling it every nail, and the amount calculated as 32 nails was 500 quarters of barley, the judge directed the jury to disregard the contract, and give as damages the value of the horse. And when a defendant had agreed for £5 to give the plaintiff two grains of rye on Monday, four on the next Monday,<sup>1</sup> and so on doubling it every Monday, it was contended that the contract was impossible, as all the rye in the world would not suffice for it; but one of the judges said that, though foolish, it would hold in law, and the defendant ought to pay something for his folly. And when a man had promised £1000 to the plaintiff if he should find his owl, the jury were directed to mitigate the damages.

Interest is recoverable as damages at common law only upon mercantile securities, such as bills of exchange and promissory notes or where a promise to pay interest has been made in express terms or may be implied from the usage of trade or other circumstances [Mayne, *Damages* (7th ed.) 166]. Under the Civil Procedure Act 1833, the jury is allowed to give interest by way of damages on debts or sums payable at a certain time, or if not so payable, from the date of demand in writing, and in actions on policies of insurance, and in actions of tort arising out of conversion or seizure of goods.

In the United States, interest is in the discretion of the court, and is made to depend on the equity of the case. In both England and America compound interest, or interest on interest, appears to have been regarded with the horror that formerly attached to usury. Lord Eldon would not recognize as valid an agreement to pay compound interest. And Chancellor Kent held that compound interest could not be taken except upon a special agreement made after the simple interest became due.

In Scotland compound interest is not allowed by way of damages.

*Torts.*—In actions arising otherwise than from breach of contract (*i.e.* of tort, delict or quasi-delict), the principles applied to the assessment of damage in cases arising *ex contractu* are generally applicable (*The Notting Hill*, 1884, 9 P.D. 105); but from the nature of the case less precision in assessment is attainable. The remoteness of the damage claimed is a ground for excluding it from the assessment. In some actions of tort the damages can be calculated with exactness just as in cases of contract, *e.g.* in most cases of interference with rights of property or injury to property. Thus, for wrongful dispossession from a plantation (in Samoa) it was held that the measure of damage was the annual value of the produce of the lands when wrongfully

<sup>1</sup> *Quolibet alio die lunae*, which was translated by some *every Monday*, and by others *every other Monday*. The amount in the latter case would have been 125 quarters, in the former 524,288,000 quarters.

seized, less the cost of management, and that the wilful character of the seizure did not justify the infliction of a penalty over and above the loss to the plaintiff (*McArthur v. Cornwall*, 1892, A.C. 75). Where minerals are wrongfully severed and carried away, the damage is assessed by calculating the value of the mineral as a chattel and deducting the reasonable expense of getting it. But where the interference with property, whether real or personal, is attended by circumstances of aggravation such as crime or fraud or wanton insult, it is well established that additional damages may be awarded which in effect are penal or vindictive. In actions for injuries to the person or to reputation, it is difficult to make the damages a matter for exact calculation, and it has been found impossible or inexpedient by the courts to prevent juries from awarding amounts which operate as a punishment of the delinquent rather than as a true assessment of the reparation due to the sufferer. And while a bad motive (malice) is seldom enough to give a cause of action, proof of its existence is a potent inducement to a jury to swell the assessment of damages, as evidence of bad character may induce them to reduce the damages to a derisory amount. In the case of injuries to the person caused by negligence, the tribunal considers, as part of the general damage, the actual pain and suffering, including nervous shock (but not wounded feelings) and the permanent or temporary character of the injury, and as special damage the loss of time and employment during recovery and the cost of cure. It is difficult by any arithmetical calculation to value pain and suffering; nor is it easy to value the effect of a permanent injury; and in the Workmen's Compensation Act and Employers' Liability Act, an attempt has been made in the case of workmen to assess by reference to the earnings of the injured person.

In the case of such wrongs as assault, arrest or prosecution, the motives of the defendant naturally affect the amount of general damage awarded, even when not essential elements in the case, and the damages are "at large." Any other rule would enable a man to distribute blows as he can utter curses at a statutory tariff of so much a curse, according to his rank. This position was strongly asserted in the cases arising out of the celebrated "General Warrants" (1763) in the time of Lord Camden, who is reported in one case to have said, "damages are designed not only as a satisfaction to the injured person, but as a punishment to the guilty, and as a proof of the detestation in which the wrongful act is held by the jury." In another case he mentioned the importance of the question at issue, the attempt to exercise arbitrary power, as a reason why the jury might give exemplary damages. Another judge, in another case, said "I remember a case when the jury gave £500 damages for knocking a man's hat off; and the court refused a new trial." And he urged that exemplary damages for personal insult would tend to prevent the practice of duelling.

The right to give exemplary or punitive or (as they are sometimes called) vindictive damages is fully recognized both in England and in the United States, and especially in the following cases. (1) Against the co-respondent in a divorce suit. This right is the same as that recognized at common law in the abolished action of criminal conversation, but the damages awarded may by the court be applied for the maintenance and education of the children of the marriage or the maintenance of the offending wife. (2) In actions of trespass to land where the conduct of the defendant has been outrageous. (3) In actions of defamation spoken or written, attended by circumstances of aggravation, and the analogous action of malicious prosecution. (4) In the anomalous actions of seduction and breach of promise of marriage.

In actions for wrongs, as in those *ex contractu*, the damages may be general or special. In a few cases of tort, the action fails wholly if special damage is not proved, *e.g.* slander by imputing to a man vicious, unchaste or immoral conduct, slander of title to land or goods or nuisance.

In theory, English law does not recognize "moral or intellectual" damage, such as was claimed by the South African Republic after the Jameson Raid. The law of Scotland allows

a solatium for wounded feelings, as does French law under the name of *dommage moral, éprouvé par la partie lésée dans sa liberté, sa sûreté, son honneur, sa considération, ses affections légitimes ou dans la jouissance de son patrimoine*. Under this head compensation is awarded to widow, child or sister, for the loss of husband, parent or brother, in addition to the actual pecuniary loss (Daloz, *Nouveau Code civil*, art. 1382). Claims of damage for negligence are defeated by proof of what is known as contributory negligence (*faute commune*). In other claims of tort, as already stated, the conduct of the claimant may materially reduce the amount of his damages.

In cases of damages to ships or cargo by collision at sea, the rule of the old court of admiralty (derived from the civil law and preserved by the Judicature Acts) is that when both or all vessels are to blame, the whole amount of the loss is divided between them. The rule appears not to apply to cases where death or personal injury results from the collision ("Vera Cruz," 1884, 14 A.C. 59. "Bernina," 1888, 13 A.C. 1).

**Costs.**—The costs of a legal proceeding are no longer treated as damages to be assessed by the jury, nor do they depend on any act of the jury. The right to receive them depends on the court, and they are taxed or assessed by its officers (see COSTS). In a few cases where costs cannot be given, e.g. on compulsory acquisition of land in London, the assessing tribunal is invited to add to the compensation price the owner's expense in the compensation proceedings.

**Death.**—In English law a right to recover damages for a tort as a general rule was lost on the death of the sufferer or of the delinquent. The cause of action was considered not to survive. This rule differs from that of Scots law (under which the claim for damages arises at the moment of injury and is not affected by the death of either party). The English rule has been criticized as barbarous, and has been considerably broken in upon by legislation, in cases of taking the goods of another (4 Edw. III., c. 7, 1330), and injuries to real or personal property (3 & 4 Will. IV., c. 42, 1833), but continues in force as to such matters as defamation, malicious prosecution and trespass to the person. By the Fatal Accidents Act 1846 (commonly called Lord Campbell's Act), it is enacted that wherever a wrongful act would have entitled the injured person to recover damages (if death had not ensued), the person who in such case would have been liable "shall be liable to an action for damages for the pecuniary loss which the death has caused to certain persons, and although the death shall have been caused under such circumstances as amount in law to felony." The only persons by whom or for whose benefit such an action may be brought are the husband, wife, parent and child (including grandchild and stepchild, but not illegitimate child) of the deceased. The right of action and the measure of damages are statutory and distinct from the right which the deceased had till he died. It was held in *Osborne v. Gillett*, 1873, L.R. 8 Ex. 88, and has since been approved (*Clark v. London General Omnibus Co.*, 1906, 2 K.B. 648), that no person can recover damages for the death of another wrongfully killed by the act of a third person, unless he claims through or represents the person killed, and unless that person in case of an injury short of death would have had a good claim to recover damages.

In Scotland the law of compensation for breach of contract is substantially the same as in England. In cases of delict or quasi-delict, the measure of reparation is a fair and reasonable compensation for the advantage which the sufferer would, but for the wrong, have enjoyed and has lost as a natural and proximate result of the wrong, coupled with a solatium for wounded feelings. The claim for reparation vests as a debt when it arises and survives to the representatives of the sufferer, and against the representatives of the delinquent. In other words, the maxim *actio personalis moritur cum persona* does not apply in Scots law; and even in cases of murder there has always been recognized a right to "assythement."

See also Mayne on *Damages*, 7th ed.; Sedgwick on *Damage*; Bell, *Principles of Law of Scotland*. (W. F. C.)

**DAMANHÜR**, a town of Lower Egypt, 38 m. E.S.E. of Alexandria by rail, capital of the richly-cultivated province of Behera. It is the ancient Timenhör, "town of Horus," which in Ptolemaic

times was capital of a nome and lay on the Canopic branch of the Nile. Its name and other circumstances imply that Horus (= Apollo) was worshipped there in the same form as at Edfu (Brugsch, *Dictionnaire géographique*, p. 521), but its Greek name, Hermopolis Parva, should indicate Thoth as the local god. This apparent contradiction is perhaps due to some early misunderstanding that held its ground after the Greeks knew Egypt better. A much frequented fair is held at Damanhür three times a year, and there are several cotton manufactories. Population (1907) 38,752.

**DAMARALAND**, a region of south-western Africa, bounded W. by the Atlantic, E. by the Kalahari, N. by Ovampoland, and S. by Great Namaqualand. It forms the central portion of German South-West Africa. Damaraland is alternatively known as Hereroland, both names being derived from the tribes inhabiting the region. The so-called Damara consist of two probably distinct peoples. They are known respectively as "the Hill Damara" and "the Cattle Damara," i.e. those who breed cattle in the plains. The Hill Damara are Negroes with much Hottentot blood, and have adopted the Hottentot tongue, while the Cattle Damara are of distinct Bantu-Negro descent and speak a Bantu language. The term Damara ("Two Dama Women") is of Hottentot origin, and is not used by the people, who call themselves Ova-herero, "the Merry People" (see HOTTENTOTS and HERERO).

**DAMASCENING**, or **DAMASKEENING**, a term sometimes applied to the production of damask steel, but properly the art of incrusting wire of gold (and sometimes of silver or copper) on the surface of iron, steel or bronze. The surface upon which the pattern is to be traced is finely undercut with a sharp instrument, and the gold thread by hammering is forced into and securely held by the minute furrows of the cut surface. This system of ornamentation is peculiarly Oriental, having been much practised by the early goldsmiths of Damascus, and it is still eminently characteristic of Persian metal work.

**DAMASCIUS**, the last of the Neoplatonists, was born in Damascus about A.D. 480. In his early youth he went to Alexandria, where he spent twelve years partly as a pupil of Theon, a rhetorician, and partly as a professor of rhetoric. He then turned to philosophy and science, and studied under Hermeias and his sons, Ammonius and Heliodorus. Later on in life he migrated to Athens and continued his studies under Marinus, the mathematician, Zenodotus, and Isidore, the dialectician. He became a close friend of Isidore, succeeded him as head of the school in Athens, and wrote his biography, part of which is preserved in the *Bibliotheca* of Photius (see appendix to the Didot edition of Diogenes Laërtius). In 529 Justinian closed the school, and Damascius with six of his colleagues sought an asylum, probably in 532, at the court of Chosroes I., king of Persia. They found the conditions intolerable, and in 533, in a treaty between Justinian and Chosroes, it was provided that they should be allowed to return. It is believed that Damascius settled in Alexandria and there devoted himself to the writing of his works. The date of his death is not known.

His chief treatise is entitled *Difficulties and Solutions of First Principles* (*Ἀπορίαι καὶ λύσεις περὶ τῶν πρώτων ἀρχῶν*). It examines into the nature and attributes of God and the human soul. This examination is, in two respects, in striking contrast to that of certain other Neoplatonist writers. It is conspicuously free from that Oriental mysticism which stultifies so much of the later pagan philosophy of Europe. Secondly, it contains no polemic against Christianity, to the doctrines of which, in fact, there is no allusion. Hence the charge of impiety which Photius brings against him. His main result is that God is infinite, and as such, incomprehensible; that his attributes of goodness, knowledge and power are credited to him only by inference from their effects; that this inference is logically valid and sufficient for human thought. He insists throughout on the unity and the indivisibility of God, whereas Plotinus and Porphyry had admitted not only a Trinity, but even an Ennead (nine-fold personality).

Interesting as Damascius is in himself, he is still more interesting



as the last in the long succession of Greek philosophers. (See NEOPLATONISM.)

**BIBLIOGRAPHY.**—The *'Aroplai* was partly edited by J. Kopp (1826), and in full by C. E. Ruelle (Paris, 1889). French trans. by Chaignet (1898). See T. Whittaker, *The Neo-platonists* (Cambridge, 1901); E. Zeller, *History of Greek Philosophy*; C. E. Ruelle, *Le Philosophe Damascius* (1861); Ch. Levêque, "Damascius" (*Journal des savants*, February 1891). See also works quoted under NEOPLATONISM and ALEXANDRIAN SCHOOL.

**DAMASCUS**, the chief town of Syria, and the capital of a government province of the same name, 57 m. from Beirut, situated in 33° 30' N., and 36° 18' E.

**History.**—The origin of the city is unknown, and the popular belief that it is the oldest city in the world still inhabited has much to recommend it. It has been suggested that the ideogram by which it is indicated in Babylonian monuments literally means "fortress of the Amorites"; could this be proved it would be valuable testimony to its antiquity if not its origin. The city is mentioned in the document that describes the battle of the four kings against five, inserted in the book of Genesis (ch. xiv.): Abram (Abraham) is reported to have pursued the routed kings to Hobah north of Damascus (v. 15). The name of the steward of Abram's establishment is given in Genesis xv. 2, as *Dammesek Eliezer*, which is explained in the Aramaic and Syriac versions as "Eliezer of Damascus." This reading is adopted by the authorized version, but the Hebrew, as it stands, will not support it. There is probably here some textual corruption.

In the period of the Egyptian suzerainty over Palestine in the eighteenth dynasty Damascus (whose name frequently appears in the Tell el-Amarna tablets) was capital of the small province of Ubi. The name of the city in the Tell el-Amarna correspondence is Dimashka. Towards the end of that period the overrunning of Palestine and Syria by the Khabiri and Suti, the forerunners of the Aramaean immigration, changed the conditions, language and government of the country. One of the first indications of this change that has been traced is the appearance of the Aramaean Darmesek for Damascus in an inscription of Rameses III.

The growth of an independent kingdom with Damascus as centre must date from very early in the Aramaean occupation. It had reached such strength that though Tiglath-Pileser I. reduced the whole of northern Syria, and by the fame of his victories induced the king of Egypt to send him presents, yet he did not venture to attack Kadesh and Damascus, so that this kingdom acted as a "buffer" between the king of Assyria and the rising kingdom of Saul.

David, however, after his accession made an expedition against Damascus as a reprisal for the assistance the city had given his enemy Hadadezer, king of Zobah. The expedition was successful; David smote of the Syrians 22,000 men, and took and garrisoned the city; "and the Syrians became servants to David, and brought gifts" (2 Sam. viii. 5, 6; 1 Chron. xviii. 5). This statement, it should be noticed, has been questioned by some modern historical and textual critics, who believe that "Syria" (Hebrew *Aram*) is here a corruption for "Edom." There is no other evidence—save the corrupt passage, 2 Sam. xxiv. 6, where "Tahtim-hodshi" is explained as meaning "the land of the Hittites to Kadesh"—that David's kingdom was so far extended northward. However this may be, it is evident that the Israelite possession of Syria did not last long. A subordinate of Hadadezer named Rezon (Raşun) succeeded in establishing himself in Damascus and in founding there a royal dynasty. Throughout the reign of Solomon (1 Kings xi. 23, 24) this Rezon seems to have been a constant enemy to the kingdom of Israel.

It is inferred from 1 Kings xv. 19 that Abijah, son of Rehoboam, king of Judah, made a league with Tab-Rimmon of Damascus to assist him in his wars against Israel, and that afterwards Tab-Rimmon's son Ben-Hadad came to terms with the second successor of Jeroboam, Baasha. Asa, son of Abijah, followed his father's policy, and bought the aid of Syria, whereby he was enabled to destroy the border fort that Baasha had erected (1 Kings xv. 22).

Hostilities between Israel and Syria lasted to the days of Ahab. From Omri the king of Syria took cities and the right to establish

a quarter for his merchants in Samaria (1 Kings xx. 34). His son Ben-Hadad made an unsuccessful attack on Israel at Aphek, and was allowed by Ahab to depart on a reversal of these terms (*loc. cit.*). This was the cause of a prophetic denunciation (1 Kings xx. 42). According to the Assyrian records Ahab fought as Ben-Hadad's ally at the battle of Karkar against Shalmaneser in 854. This seems to indicate an intermediate defeat and vassalage of Ahab, of which no direct record remains; and it was probably in the attempt to throw off this vassalage in 853, the year after the battle of Karkar, that Ahab met his death in battle with the Syrians (1 Kings xxii. 34-40). In the reign of Jehoram, Naaman, the Syrian general, came and was cleansed by the prophet Elisha of leprosy (2 Kings v.).

In 843 Hazael assassinated Ben-Hadad and made himself king of Damascus. The states which Ben-Hadad had brought together into a coalition against the advancing power of Assyria all revolted; and Shalmaneser, king of Assyria, took advantage of this in 842 and attacked Syria. He wasted the country, but could not take the capital. Jehu, king of Israel, paid tribute to Assyria, for which Hazael afterwards revenged himself, during the time when Shalmaneser was distracted by his Armenian wars, by attacking the borders of Israel (2 Kings x. 32).

Adad-nirari IV. invaded Syria and besieged Damascus in 806. Taking advantage of this and similar succeeding events, Jehoash, king of Israel, recovered the cities that his father had lost to Hazael.

In 734 Ahaz became king of Judah, and Rezon (Raşun, Rezin), the king of Damascus at the time, came up against him; at the same time the Edomites and the Philistines revolted. Ahaz appealed to Tiglath-Pileser III., king of Assyria, sent him gifts, and besought his protection. Tiglath-Pileser invaded Syria, and in 732 succeeded in reducing Damascus (see also BABYLONIA AND ASSYRIA, *Chronology*, § 5, and JEWS, §§ 10 sqq.).

Except for the abortive rising under Sargon in 720, we hear nothing more of Damascus for a long period. In 333 B.C., after the battle of Issus, it was delivered over by treachery to Parmenio, the general of Alexander the Great; the harem and treasures of Darius had here been lodged. It had a chequered history during the wars of the successors of Alexander, being occasionally in Egyptian hands. In 112 B.C. the empire of Syria was divided by Antiochus Grypus and Antiochus Cyzicenus; the city of Damascus fell to the share of the latter. Hyrcanus took advantage of the disputes of these rulers to advance his own kingdom. Demetrius Eucaerus, successor of Cyzicenus, invaded Palestine in 88 B.C., and defeated Alexander Jannaeus at Shechem. On his dethronement and captivity by the Parthians, Antiochus Dionysus, his brother, succeeded him, but was slain in battle by Hāritha (Aretas) the Arab—the first instance of Arab interference with Damascene politics. Hāritha yielded to Tigranes, king of Armenia, who in his turn was driven out by Q. Caecilius Metellus (son of Scipio Nasica), the Roman general. In 63 Syria was made a Roman province.

In the New Testament Damascus appears only in connexion with the miraculous conversion of St Paul (Acts ix., xxii., xxvi.), his escape from Aretas the governor by being lowered in a basket over the wall (Acts ix. 25; 2 Cor. xi. 32, 33), and his return thither after his retirement in Arabia (Gal. i. 17).

In 150, under Trajan, Damascus became a Roman provincial city.

On the establishment of Christianity Damascus became the seat of a bishop who ranked next to the patriarch of Antioch. The great temple of Damascus was turned by Arcadius into a Christian church.

In 635 Damascus was captured for Islam by Khālid ibn Walid, the great general of the new religion, being the first city to yield after the battle of the Yarmuk (Hieromax). After the murder of Ali, the fourth caliph, his successor Moawiya transferred the seat of the Caliphate (*q.v.*) from Mecca to Damascus and thus commenced the great dynasty of the Omayyads, whose rule extended from the Atlantic to India. This dynasty lasted about ninety years; it was supplanted by that of the Abbasids, who removed the seat of empire to Mesopotamia; and Damascus

passed through a period of unrest in which it was captured and ravaged by Egyptians, Carmathians and Seljuks in turn. The crusaders attacked Damascus in 1126, but never succeeded in keeping a firm hold of it, even during their brief domination of the country. It was the headquarters of Saladin in the wars with the Franks. Of its later history we need only mention the Mongolian capture in 1260; its Egyptian recapture by the Mameluke Kotuz; the ferocious raid of Timur (Tamerlane) in 1399; and the conquest by the Turkish sultan Selim, whereby it became a city of the Ottoman empire (1516). In its more recent history the only incidents that need be mentioned are its capture by Ibrahim Pasha, the Egyptian general, in 1832, when the city was first opened to the representatives of foreign powers; its revolt against Ibrahim's tyranny in 1834, which he crushed with the aid of the Druses; the return of the city to Turkish domination, when the Egyptians were driven out of Syria in 1840 by the allied powers; and the massacre of July 1860, when the Moslem population rose against the Christians, burnt their quarter, and slaughtered about 3000 adult males.

**Modern City.**—Damascus is a city with a population estimated at from 154,000 (35,000 Christians and Jews) to 225,000 (55,000 Christians and Jews), situated near the northern edge of a plain called the Ghutah, at the foot of Anti-Lebanon, 2250 ft. above the sea. The river Barada (the *Abanah* of 2 Kings v. 12) rises in the Anti-Lebanon, runs for about 10 m. in a narrow channel, and then spreads itself fan-wise over the plain. About 18 m. east of the city it loses itself in the marshlands known as the Meadow Lakes. A second river, the 'Awaj (possibly the *Pharpar* of 2 Kings), pursues a similar course. The plain is thus exceptionally well irrigated, and its consequent fertility is proverbial over the East. Damascus is situated on both banks of the Barada, about 2 m. from the exit of the river from the gorge. On the right bank is all the older part of the city, and a long suburb called El-Meidān extending about a mile along the Hajj Road. On the left bank are the suburbs El 'Amāra and El-Salihia. The waters of the river are carried by channels and conduits to all the houses of the city. The orchards, gardens, vineyards and fields of Damascus are said to extend over a circuit of at least 60 m. In the surrounding plain are one hundred and forty villages, occupied in all by about 50,000 persons (1000 Christians, 2000 Druses).

The rough mud walls in the private houses give poor promise of splendour within. The entrance is usually by a low door, and through a narrow winding passage which leads to the outer court, where the master has his reception room. From this another winding passage leads to the harem, which is the principal part of the house. The plan of all is the same—an open court, with a tessellated pavement, and one or two marble fountains; orange and lemon trees, flowering shrubs, and climbing plants give freshness and fragrance. All the apartments open into the court; and on the south side is an open alcove, with a marble floor, and raised dais round three sides, covered with cushions; the front wall is supported by an ornamented Saracenic arch. The decoration of some of the rooms is gorgeous, the walls being covered in part with mosaics and in part with carved work, while the ceilings are rich in arabesque ornaments, elaborately gilt. A few of the modern Jewish houses have been embellished at an enormous cost, but they are wanting in taste.

**Antiquities.**—Considering the great age of Damascus, its comparative poverty in antiquities is remarkable. The walls of the city seem to be Seleucid in origin; some of the Roman gateways being still in good order. The *Derb el-Mistakim*, or "Straight Street," still runs through the city from the eastern to the western gate. At the north-west corner is a large castle built in A.D. 1219, by El-Malik el-Ashraf, on the site of an earlier palace. It is quadrangular, surrounded by a moat filled by the Barada. The outer walls are in good preservation; but the interior is ruined.

The church of St John the Baptist constructed by Arcadius on the site of the temple was turned by Caliph Walid I. (705-717) to a mosque which was the most important building of Damascus. It was a structure 431 ft. by 125 ft. interior dimensions, extending

along the south side of a quadrangle 163 yds. by 108 yds. Except the famous inscription over the door—"Thy kingdom, O Christ, is an everlasting kingdom, and thy dominion endureth throughout all generations"—every trace of Christianity was effaced from the church at its conversion. It was destroyed by fire on the 14th of October 1893, and though it was subsequently rebuilt, much that was of archaeological and historical interest perished. It is estimated that there are over two hundred mosques in Damascus.

**Products, Manufactures, &c.**—Damascus occupies an important commercial position, being the market for the whole of the desert; it also is of great importance religiously, as being the starting-point for the Hajj pilgrimage from Syria to Mecca, which leaves on the 15th of the lunar month of Shawwal each year. This of course brings much trade to the city. Its chief manufactures are silk work, cloths and cloaks, gold and silver ornaments, &c., brass and copper work, furniture and ornamental woodwork. The bazaars of Damascus are among the most famous of their kind. It is connected with Beirut and Mezerib by railway, and at the end of the past century the great undertaking of running a line to Mecca was commenced. In the surrounding gardens and fields walnuts, apricots, wheat, barley, maize, &c. are grown. Its commercial importance is referred to by Ezekiel (xxvii. 18), who mentions its trade in wines and wool. The climate is good; in winter there is often hard frost and much snow, and even in summer, with a day temperature of 100° F., the nights are always cool. Fever, dysentery and ophthalmia, chiefly due to exposure to heavy dews and cold nights, are prevalent. Though still the market of the nomads, the surer and cheaper sea route has almost destroyed the transit trade to which it once owed its wealth, and has even diminished the importance of the annual pilgrim caravan to Mecca. The Damascene, however, still retains his skill as a craftsman and tiller of the soil. The chief imports are cloths, prints, muslins, raw silk, sugar, rice, &c.

The value of exports and imports in certain specified years is shown in the following table:—

	1890.	1894.	1898.	1905.
Exports . . . . .	£325,660	£400,830	£302,050	£386,000
Imports . . . . .	525,710	614,490	675,080	872,400

Most of the Christians belong to the Orthodox and Roman Catholic (United) Greek Churches; and there are also communities of Melchites, Jacobites, Maronites, Nestorians, Armenians and Protestants. There are Protestant missions, founded 1843, and a British hospital.

**AUTHORITIES.**—Lortet, *La Syrie d'aujourd'hui*, p. 567 f. (Paris, 1884); Von Oppenheim, *Vom Mittelmeer zum Persischen Golf*, i. 49 f. (Berlin, 1899); G. A. Smith, *Historical Geography of the Holy Land*; *Encyclopaedia Biblica*, art. "Damascus"; Consular Reports; Baedeker-Socin, *Handbook to Syria and Palestine*. For the Great Mosque see Dickie, Phené Spiers, and Sir C. W. Wilson in *Palestine Exploration Fund Quarterly Statement*, Oct. 1897. (R. A. S. M.)

**DAMASK**, the technical term applied to certain distinct types of fabric. The term owes its origin to the ornamental silk fabrics of Damascus, fabrics which were elaborately woven in colours, sometimes with the addition of gold and other metallic threads. At the present day it denotes a linen texture richly figured in the weaving with flowers, fruit, forms of animal life, and other types of ornament. "China, no doubt," says Dr Rock (*Catalogue of Textile Fabrics*, Victoria and Albert Museum), "was the first country to ornament its silken webs with a pattern. India, Persia, and Syria, then Byzantine Greece followed, but at long intervals between, in China's footsteps. Stuffs so figured brought with them to the West the name 'diaspron' or diaper, bestowed upon them at Constantinople. But about the 12th century the city of Damascus, even then long celebrated for its looms, so far outstripped all other places for beauty of design, that her silken textiles were in demand everywhere; and thus, as often happens, traders fastened the name of damascen or damask upon every silken fabric richly wrought and curiously designed, no matter whether it came or not from Damascus." The term is perhaps now best known in reference to damask table-cloths, a

species of figured cloth usually of flax or tow yarns, but sometimes made partly of cotton. The finer qualities are made of the best linen yarn, and, although the latter is of a brownish colour during the weaving processes, the ultimate fabric is pure white. The high lights in these cloths are obtained by long floats of warp and weft, and, as these are set at right angles, they reflect the light differently according to the angle of the rays of light; the effect changes also with the position of the observer. Subdued effects are produced by shorter floats of yarn, and sometimes by special weaves. Any subject, however intricate, can be copied by this method of weaving, provided that expense is no object. The finest results are obtained when the so-called double damask weaves are used. These weaves are shown under *DIE*, and it will be seen that each weave gives a maximum float of seven threads. (In some special cases a weave is used which gives a float of nine.) The small figure here shown to illustrate a small section of a damask design is composed of the two single damask weaves; these give a maximum float of four threads or picks. No shading is shown in the design, and this for two reasons—(1) the single damask weaves do not permit of elaborate shading, although some very good effects are obtainable; (2) the available space is not sufficiently large to show the method to advantage. The different single damask weaves used

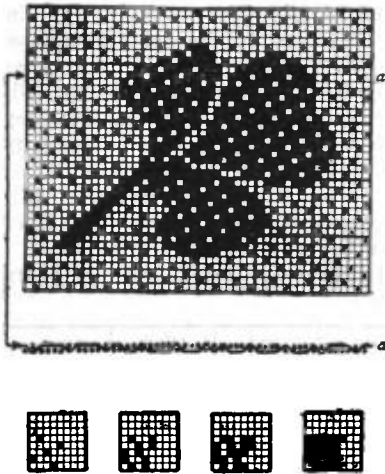

in Paisley, Glasgow, and several places in Lancashire, are used for toilet covers, table-cloths, and similar purposes. They are often ornamented with colours and sent to the Indian and West Indian markets. Silk damasks for curtains and upholstery decoration are made in the silk-weaving centres.

**DAMASK STEEL**, or **DAMASCUS STEEL**, a steel with a peculiar watered or streaked appearance, as seen in the blades of fine swords and other weapons of Oriental manufacture. One way of producing this appearance is to twist together strips of iron and steel of different quality and then weld them into a solid mass. A similar but inferior result may be obtained by etching with acid the surface of a metal, parts of which are protected by some greasy substance in such a way as to give the watered pattern desired. The art of producing damask steel has been generally practised in Oriental countries from a remote period, the most famous blades having come from Isfahan, Khorasan, and Shiraz in Persia.

**DAMASUS**, the name of two popes.

**DAMASUS I.** was pope from 366 to 384. At the time of the banishment of Pope Liberius (355), the deacon Damasus, like all the Roman clergy, made energetic protest. When, however, the emperor Constantius sent to Rome an anti-pope in the person of Felix II., Damasus, with the other clergy, rallied to his cause. When Liberius returned from exile and Felix was expelled from Rome, Damasus again took his place among the adherents of Liberius. On the death of Liberius (366) a considerable party nominated Damasus successor; but the irreconcilables of the party of Liberius refused to pardon his trimming, and set up against him another deacon, Ursinus. A serious

conflict ensued between the rival factions, which quickly led to rioting and hand-to-hand fighting. In one of these encounters the then new basilica, called the **Liberian Basilica** (S. Maria Maggiore), was partially destroyed, and 137 dead bodies were left in the building. On several occasions the secular arm had to intervene, although the government of the emperor Valentinian was averse from involving itself in ecclesiastical affairs. From the outset the prefect of Rome recognized the claims of Damasus, and exerted himself to support him. Ursinus and the leading men of his faction were expelled from Rome, and afterwards from central Italy, or even interned in Gaul. They, however, persisted obstinately in their opposition to Damasus, combating him at first by riots, and then by calumnious law-suits, such as that instituted by one Isaac, a converted and relapsed Jew.

To the official support, which never failed him, Damasus endeavoured to join the popular sympathy. From before his election he had been in high favour with the Roman aristocracy, and especially with the great ladies. At that period the urban masses, but recently converted to Christianity, sought in the worship of the martyrs a sort of substitute for polytheism. Damasus showed great zeal in discovering the tombs of martyrs, adorning them with precious marbles and monumental inscriptions. The inscriptions he composed himself, in mediocre verse, full of Virgilian reminiscences. Several have come down to us on the original marbles, entire or in fragments; others are known from old copies. In the interior of Rome he erected or embellished the church which still bears his name (S. Lorenzo in Damaso), near which his father's house appears to have stood.

The West was recovering gradually from the troubles caused by the Arian crisis. Damasus took part, more or less effectually, in the efforts to eliminate from Italy and Illyria the last champions of the council of Rimini. In spite of his declaration at the council convened by him in 372, he did not succeed in evicting Auxentius from Milan. But Auxentius died soon afterwards, and his successor, Ambrose, undertook to bring these hitherto abortive efforts to a successful conclusion, and to complete the return of Illyria to the confessions of Nicaea. The bishops of the East, however, under the direction of St Basil, were involved in a struggle with the emperor Valens, whose policy was favourable to the council of Rimini. Damasus, to whom they appealed for help, was unable to be of much service to them, the more so because that episcopal group, viewed askance by St Athanasius and his successor Peter, was incessantly combated at the papal court by the inveterate hatred of Alexandria. The Eastern bishops triumphed in the end under Theodosius, at the council of Constantinople (381), in which the pope and the Western church took no part. They were invited to a council of wider convocation, held at Rome in 382, but very few attended.

This council had brought to Rome the learned monk Jerome, for whom Damasus showed great esteem. To him Damasus entrusted the revision of the Latin text of the Bible and other works of religious erudition. A short time before, the pope had received a visit from the Priscillianists after their condemnation in Spain, and had dismissed them. Damasus died in 384, on the 11th of December, the day on which his memory is still celebrated.

**DAMASUS II.**, pope from the 17th of July to the 9th of August 1048, was the ephemeral successor of Clement II. His original name was Poppo, and he was bishop of Brixen when the emperor Henry III. raised him to the papacy. (L. D.\*)

**DAMAUN** or **DAMAN**, a town of Portuguese India, capital of the settlement of Damaun, situated on the east side of the entrance of the Gulf of Cambay within the Bombay Presidency. The area of the settlement is 82 sq. m. Pop. (1900) 41,671. The settlement is divided into two parts, Damaun proper, and the larger *pargana* of Nagar Havili, the two being separated by a narrow strip of British territory. The soil is fertile, and rice, wheat and tobacco are the chief crops. The teak forests are valuable. Weaving is an industry less important than formerly; mats and baskets are manufactured, and deep-sea fishing is an

important industry. The shipbuilding business at the town of Damaun is important. Early in the 19th century a large transit trade in opium between Karachi and China was carried on at Damaun, but it ceased in 1837, when the British prohibited it after their conquest of Sind. The settlement is administered as a unit, and has a municipal chamber.

Damaun town was sacked and burnt by the Portuguese in 1531. It was subsequently rebuilt, and in 1558 was again taken by the Portuguese, who made a permanent settlement and converted the mosque into a Christian church. From that time it has remained in their hands. The territory of Damaun proper was conquered by the Portuguese in 1559; that of Nagar Havili was ceded to them by the Mahrattas in 1780 in indemnification for piracy.

**DAME** (through the Fr. from Lat. *domina*, mistress, lady, the feminine of *dominus*, master, lord), properly a name of respect or a title equivalent to "lady," now surviving in English as the legal designation of the wife or widow of a baronet or knight and prefixed to the Christian name and surname. It has also been used in modern times by certain societies or orders, e.g. the Primrose League, as the name of a certain rank among the lady members, answering to the male rank of knight. The ordinary use of the word by itself is for an old woman. As meaning "mistress," i.e. teacher, "dame" was used of the female keepers of schools for young children, which have become obsolete since the advance of public elementary education. At Eton College boarding-houses kept by persons other than members of the teaching staff of the school were known as "Dames' Houses," though the head might not necessarily be a lady. As a term of address to ladies of all ranks, from the sovereign down, "madam," shortened to "ma'am," represents the French *madame*, my lady.

"Damsel," a young girl or maiden, now only used as a literary word, is taken from the Old French *dameisele*, formed from *dame*, and parallel with the popular *dansle* or *doncele* from the medieval Latin *domicella* or *dominicella*, diminutive of *domina*. The French *damoiselle* and *demoiselle* are later formations. The English literary form "damosel" was another importation from France in the 15th century. In the early middle ages *damoiseau*, medieval Latin *domicellus*, *dameicele*, *damoiselle*, *domicella*, were used as titles of honour for the unmarried sons and daughters of royal persons and lords (*seigneurs*). Later the *damoiseau* (in the south *donzel*, in Béarn *domengar*) was specifically a young man of gentle birth who aspired to knighthood, equivalent to *écuyer*, esquire, or *valet* (q.v.). The *damoiseau* performed certain functions and received training in knightly accomplishments in the domestic service of his lord. Later again the name was also used of nobles who had not been knighted. In certain *seigneuries* in France, notably in that of Commercy, in Lorraine, *damoiseau* became the permanent title of the holder. In England the title, when used by the French-speaking nobility and members of the court, was only applied to the son or grandson of the king; thus in the *Laws of Edward the Confessor*, quoted in Du Cange (*Glossarium*, s.v. *Domicellus*), we find "Rex vero Edgarum . . . pro filio nutritiv et quia cogitavit ipsum heredem facere, nominavit *Ethelinge*, quod nos *Domicellum*, id, *Damisell*; sed nos indiscrete de pluribus dicimus, quia Baronum filios vocamus *domicellos*, Angli vero nullos nisi natos regum." Froissart calls Richard II. during the lifetime of his father the Black Prince, *le jeune Demoisel*. The use of *damoiselle* followed much the same development; it was first applied to the unmarried daughters of royal persons and *seigneurs*, then to the wife of a *damoiseau*, and also to the young ladies of gentle birth who performed for the wives of the *seigneurs* the same domestic services as the *damoiseaus* for their husbands. Hence the later form *demoiselle* became merely the title of address of a young unmarried lady, the *mademoiselle* of modern usage, the English "miss." At the court of France, after the 17th century, *Mademoiselle*, without the name of the lady, was a courtesy title given to the eldest daughter of the eldest brother of the king, who was known as *Monsieur*. To distinguish the daughter of Gaston d'Orléans, brother of Louis XIII., from the daughter of

Philippe d'Orléans, brother of Louis XIV., the former, Anne Marie Louise, duchesse de Montpensier, was called *La Grande Mademoiselle*, by which title she is known to history (see MONT-PENSIER, A. M. L., DUCHESSE DE).

**DAME'S VIOLET**, the English name for *Hesperis matronalis*, a herbaceous plant belonging to the natural order Cruciferae, and closely allied to the wallflower and stock. It has an erect stout leafy stem 2 to 3 ft. high, with irregularly toothed short-stalked leaves and white or lilac flowers,  $\frac{1}{2}$  in. across, which are scented in the evening (hence the name of the genus, from the Gr. *ἑσπερος*, evening). The slender pods are constricted between the seeds. The plant is a native of Europe and temperate Asia, and is found in Britain as an escape from gardens, in meadows and plantations.

**DAMGHAN**, a town of Persia in the province of Semnan va Damghan, 216 m. from Teheran on the high-road thence to Khorasan, at an elevation of 3770 ft. and in 36° 10' N., 54° 20' E. Pop. about 10,000. There are post and telegraph offices, and a great export trade is done in pistachios and almonds, the latter being of the kind called *Kaghazi* ("of paper") with very thin shells, famous throughout the country. Damghan was an important city in the middle ages, but only a ruined mosque with a number of massive columns and some fine wood carvings and two minarets of the 11th century remain of that period. Near the city, a few miles south and south-west, are the remains of Hecatompylos, extending from Frat, 16 m. south of Damghan, to near Gúsheh, 20 m. west. Damghan was destroyed by the Afghans in 1723. On an eminence in the western part of the city are the ruins of a large square citadel with a small white-washed building, called *Molüd Khaneh* (the house of birth), in which Fath Ali Shah was born (1772).

**DAMIANI, PIETRO** (c. 1007–1072), one of the most celebrated ecclesiastics of the 11th century, was born at Ravenna, and after a youth spent in hardship and privation, gained some renown as a teacher. About 1035, however, he deserted his secular calling and entered the hermitage of Fonte Avellana, near Gubbio; and winning sound reputation through his piety and his preaching, he became the head of this establishment about 1043. A zealot for monastic and clerical reform, he introduced a more severe discipline, including the practice of flagellation, into the house, which, under his rule, quickly attained celebrity, and became a model for other foundations. Extending the area of his activities, he entered into communication with the emperor Henry III., addressed to Pope Leo IX. in 1049 a writing denouncing the vices of the clergy and entitled *Liber Gomorrhianus*; and soon became associated with Hildebrand in the work of reform. As a trusted counsellor of a succession of popes he was made cardinal bishop of Ostia, a position which he accepted with some reluctance; and presiding over a council at Milan in 1059, he courageously asserted the authority of Rome over this province, and won a signal victory for the principles which he advocated. He rendered valuable assistance to Pope Alexander II. in his struggle with the anti-pope, Honorius II.; and having served the papacy as legate to France and to Florence, he was allowed to resign his bishopric in 1067. After a period of retirement at Fonte Avellana, he proceeded in 1069 as papal legate to Germany, and persuaded the emperor Henry IV. to give up his intention of divorcing his wife Bertha. During his concluding years he was not altogether in accord with the political ideas of Hildebrand. He died at Faenza on the 22nd of February 1072. Damiani was a determined foe of simony, but his fiercest wrath was directed against the married clergy. He was an extremely vigorous controversialist, and his Latin abounds in denunciatory epithets. He was specially devoted to the Virgin Mary, and wrote an *Officium Beatae Virginis*, in addition to many letters, sermons, and other writings.

His works were collected by Cardinal Cajetan, and were published in four volumes at Rome (1606–1615), and then at Paris in 1642, at Venice in 1743, and there are other editions. See A. Vogel, *Peter Damiani* (Jena, 1856); A. Capecelatro, *Storia di S. Pier Damiani e del suo tempo* (Florence, 1862); F. Neukirch, *Das Leben des Peter Damiani* (Göttingen, 1875); L. Guerrier, *De Petro Damiano* (Orléans, 1881); W. von Giesebrecht, *Geschichte der deutschen Kaiserzeit*

(Leipzig, 1885-1890); and Herzog-Hauck, *Realencyklopädie*, Band iv. (Leipzig, 1898).

**DAMIEN, FATHER**, the name in religion of JOSEPH DE VEUSTER (1840-1889), Belgian missionary, was born at Tremeloo, near Louvain, on the 3rd of January 1840. He was educated for a business career, but in his eighteenth year entered the Church, joining the Society of the Sacred Heart of Jesus and Mary (also known as the Picpus Congregation), and taking Damien as his name in religion. In October 1863, while he was still in minor orders, he went out as a missionary to the Pacific Islands, taking the place of his brother, who had been prevented by an illness. He reached Honolulu in March 1864, and was ordained priest in Whitsuntide of that year. Struck with the sad condition of the lepers, whom it was the practice of the Hawaiian government to deport to the island of Molokai, he conceived an earnest desire to mitigate their lot, and in 1873 volunteered to take spiritual charge of the settlement at Molokai. Here he remained for the rest of his life, with occasional visits to Honolulu, until he became stricken with leprosy in 1885. Besides attending to the spiritual needs of the lepers, he managed, by the labour of his own hands and by appeals to the Hawaiian government, to improve materially the water-supply, the dwellings, and the victualling of the settlement. For five years he worked alone; subsequently other resident priests from time to time assisted him. He succumbed to leprosy on the 15th of April 1889. Some ill-considered imputations upon Father Damien by a Presbyterian minister produced a memorable tract by Robert Louis Stevenson (*An Open Letter to the Rev. Dr Hyde*, 1890).

See also lives by E. Clifford (1889) and Fr. Pamphile (1889).

(J. M'F.)

**DAMIENS, ROBERT FRANÇOIS** (1715-1757), a Frenchman who attained notoriety by his attack on Louis XV. of France in 1757, was born in a village near Arras in 1715, and early enlisted in the army. After his discharge, he became a menial in the college of the Jesuits in Paris, and was dismissed from this as well as from other employments for misconduct, his conduct earning for him the name of Robert le Diable. During the disputes of Clement XI. with the parlement of Paris the mind of Damiens seems to have been excited by the ecclesiastical disorganization which followed the refusal of the clergy to grant the sacraments to the Jansenists and Convulsionnaires; and he appears to have thought that peace would be restored by the death of the king. He, however, asserted, perhaps with truth, that he only intended to frighten the king without wounding him severely. On the 5th of January 1757, as the king was entering his carriage, he rushed forward and stabbed him with a knife, inflicting only a slight wound. He made no attempt to escape, and was at once seized. He was condemned as a regicide, and sentenced to be torn in pieces by horses in the Place de Grève. Before being put to death he was barbarously tortured with red-hot pincers, and molten wax, lead, and boiling oil were poured into his wounds. After his death his house was razed to the ground, his brothers and sisters were ordered to change their names, and his father, wife, and daughter were banished from France.

See *Pièces originales et procédures du procès fait à Robert François Damiens* (Paris, 1757).

**DAMIETTA**, a town of Lower Egypt, on the eastern (Damietta or Phatnitic) branch of the Nile, about 12 m. above its mouth, and 125 m. N.N.E. of Cairo by rail. Pop. (1907) 29,354. The town is built on the east bank of the river between it and Lake Menzala. Though in general ill-built and partly ruinous, the town possesses some fine mosques, with lofty minarets, public baths and busy bazaars. Along the river-front are many substantial houses furnished with terraces, and with steps leading to the water. Their wooden lattices of saw-work are very graceful. After Cairo and Alexandria, Damietta was for centuries the largest town in Egypt, but the silting up of the entrance to the harbour, the rise of Port Said, and the remarkable development of Alexandria have robbed Damietta of its value as a port. It has still, however, a coasting trade with Syria and the Levant. Ships over 6 ft. draught cannot enter the river, but must anchor

in the offing. Lake Menzala yields large supplies of fish, which are dried and salted, and these, with rice, furnish the chief articles of trade.

Damietta is a Levantine corruption of the Coptic name *Tamiati*, Arabic *Dimyāt*. The original town was 4 m. nearer the sea than the modern city, and first rose into importance on the decay of Pelusium. When it passed into the hands of the Saracens it became a place of great wealth and commerce, and, as the eastern bulwark of Egypt, was frequently attacked by the crusaders. The most remarkable of these sieges lasted eighteen months, from June 1218 to November 1219, and ended in the capture of the town, which was, however, held but for a brief period. In June 1249 Louis IX. of France occupied Damietta without opposition, but being defeated near Mansura in the February following, and compelled (6th April) to surrender himself prisoner, Damietta was restored to the Moslems as part of the ransom exacted. To prevent further attacks from the sea the Mameluke sultan Bibars blocked up the Phatnitic mouth of the Nile (about 1260), razed old Damietta to the ground, and transferred the inhabitants to the site of the modern town. It continued to be a place of commercial importance for a considerable period, until in fact Port Said gave the eastern part of the Delta a better port. Damietta gives its name to dimity, a kind of striped cloth, for which the place was at one time famous. Cotton and silk goods are still manufactured here.

**DAMIRI**, the common name of KAMĀL UD-DĪN MUHAMMAD IBN MŪSĀ UD-DAMĪRĪ (1344-1405), Arabian writer on canon law and natural history, belonged to one of the two towns called Damīra near Damietta and spent his life in Egypt. Of the Shafī'ite school of law, he became professor of tradition in the *Rukniyya* at Cairo, and also at the mosque el-Azhar; in connexion with this work he wrote a commentary on the *Minhāj ut-Tālibīn* of Nawāwī (*q.v.*). He is, however, better known in the history of literature for his *Life of Animals* (*Hayāt ul-Hayawān*), which treats in alphabetic order of 931 animals mentioned in the Koran, the traditions and the poetical and proverbial literature of the Arabs. The work is a compilation from over 500 prose writers and nearly 200 poets. The correct spelling of the names of the animals is given with an explanation of their meanings. The use of the animals in medicine, their lawfulness or unlawfulness as food, their position in folk-lore are the main subjects treated, while occasionally long irrelevant sections on political history are introduced.

The work exists in three forms. The fullest has been published several times in Egypt; a mediate and a short recension exist in manuscript. Several editions have been made at various times of extracts, among them the poetical one by Suyūti (*q.v.*), which was translated into Latin by A. Ecchelenensis (Paris, 1667). Bochartus in his *Hieroicoicon* (1663) used Damiri's work. There is a translation of the whole into English by Lieutenant-Colonel Jayakar (Bombay, 1906-1908). (G. W. T.)

**DAMIRON, JEAN PHILIBERT** (1794-1862), French philosopher, was born at Belleville. At nineteen he entered the normal school, where he studied under Burnouf, Villemain, and Cousin. After teaching for several years in provincial towns, he came to Paris, where he lectured on philosophy in various institutions, and finally became professor in the normal school, and titular professor at the Sorbonne. In 1824 he took part with P. F. Dubois and Th. S. Jouffroy in the establishment of the *Globe*; and he was also a member of the committee of the society which took for its motto *Aide-toi, le ciel t'aidera*. In 1833 he was appointed chevalier of the Legion of Honour, and in 1836 member of the Academy of Moral Sciences. Damiron died at Paris on the 11th of January 1862.

The chief works of Damiron, of which the best are his accounts of French philosophers, are the following:—An edition of the *Nouveaux mélanges philosophiques de Jouffroy* (1842), with a notice of the author, in which Damiron softened and omitted several expressions used by Jouffroy, which were opposed to the system of education adopted by the Sorbonne, an article which gave rise to a bitter controversy, and to a book by Pierre Leroux, *De la mutilation des manuscrits de M. Jouffroy* (1843); *Essai sur l'histoire de la philosophie en France au XIX<sup>e</sup> siècle* (1828, 3rd ed.



1834); *Essai sur l'histoire de la philosophie en France au XVII. siècle* (1846); *Mémoires à servir pour l'histoire de la philosophie en France au XVIII. siècle* (1858-1864); *Cours de la philosophie; De la Providence* (1849, 1850).

See A. Franck, *Moralistes et philosophes* (1872).

**DAMJANICH, JÁNOS** (1804-1849), Hungarian soldier, was born at Stása in the Banat. He entered the army as an officer in the 61st regiment of foot, and on the outbreak of the Hungarian war of independence was promoted to be a major in the third Honvéd regiment at Szeged. Although an orthodox Serb, he was from the first a devoted adherent of the Magyar liberals. He won his colonelcy by his ability and valour at the battles of Alibunár and Lagerdorf in 1848. At the beginning of 1849 he was appointed commander of the 3rd army corps in the middle Theiss, and quickly gained the reputation of being the bravest man in the Magyar army, winning engagement after engagement by sheer dash and daring. At the beginning of March 1849 he annihilated a brigade at Szolnók, perhaps his greatest exploit. He was elected deputy for Szolnók to the Hungarian diet, but declined the honour. Damjanich played a leading part in the general advance upon the Hungarian capital under Görgei. He was present at the engagements of Hort and Hatvan, converted the doubtful fight of Tápió-Bicsk into a victory, and fought with irresistible élan at the bloody battle of Isaszeg. At the ensuing review at Gödöllő, Kossuth expressed the sentiments of the whole nation when he doffed his hat as Damjanich's battalions passed by. Always a fiery democrat, Damjanich uncompromisingly supported the extremist views of Kossuth, and was appointed commander of one of the three divisions which, under Görgei, entered Vác in April 1849. His fame reached its culmination when, on the 19th of April, he won the battle of Nagysarló, which led to the relief of the hardly-pressed fortress of Komárom. At this juncture Damjanich broke his leg, an accident which prevented him from taking part in field operations at the most critical period of the war, when the Magyars had to abandon the capital for the second time. He recovered sufficiently, however, to accept the post of commandant of the fortress of Arad. After the Világos catastrophe, Damjanich, on being summoned to surrender, declared he would give up the fortress to a single company of Cossacks, but would defend it to the last drop of his blood against the whole Austrian army. He accordingly surrendered to the Russian general Demitrius Buturlin (1790-1849), by whom he was handed over to the Austrians, who shot him in the market-place of Arad a few days later.

See Ödön Hamvay, *Life of János Damjanich* (Hung.), (Budapest, 1904). (R. N. B.)

**DAMMAR**, or **DAMMER** (Hind. *damar*=resin, pitch), a resin, or rather series of resins, obtained from various coniferous trees of the genus *Dammara* (*Agathis*). East Indian dammar or cat's eye resin is the produce of *Dammara orientalis*, which grows in Java, Sumatra, Borneo and other eastern islands and sometimes attains a height of 80-100 ft. It oozes in large quantities from the tree in a soft viscous state, with a highly aromatic odour, which, however, it loses as it hardens by exposure. The resin is much esteemed in oriental communities for incense-burning. Dammar is imported into England by way of Singapore; and as found in British markets it is a hard, transparent, brittle, straw-coloured resin, destitute of odour. It is readily soluble in ether, benzol and chloroform, and with oil of turpentine it forms a fine transparent varnish which dries clear, smooth and hard. The allied kauri gum, or dammar of New Zealand (Australian dammar), is produced by *Dammara australis*, or kauri-pine, the wood of which is used for wood paving. Much of the New Zealand resin is found fossil in circumstances analogous to the conditions under which the fossil copal of Zanzibar is obtained. Dammar is besides a generic Indian name for various other resins, which, however, are little known in western commerce. Of these the principal are black dammar (the Hindustani *kala-damar*), yielded by *Canarium strictum*, and white dammar, Indian copal, or piney varnish (*sufed-damar*), the produce of *Vateria indica*. Sal dammar (*damar*) is obtained from *Shorea*

*robusta*; *Hopea micrantha* is the source of rock dammar (the Malay *dammer-batu*); and other species yield resins which are similarly named and differ little in physical properties.

**DAMMARTIN**, a small town of France, in the department of Seine et Marne, 22 m. N.E. of Paris. It is well situated on a hill forming part of the plateau of la Goële, and is known as Dammartin-en-Goële to distinguish it from Dammartin-sous-Tigeaux, a small commune in the same department. Dammartin is historically important as the seat of a countship of which the holders played a considerable part in French history. The earliest recorded count of Dammartin was a certain Hugh, who made himself master of the town in the 10th century; but his dynasty was replaced by another family in the 11th century. Reynald I. (Renaud), count of Dammartin (d. 1227), who was one of the coalition crushed by King Philip Augustus at the battle of Bouvines (1214), left two co-heiresses, of whom the elder, Maud (Matilda or Mahaut), married Philip Hurepel, son of Philip Augustus, and the second, Alix, married Jean de Trie, in whose line the countship was reunited after the death of Philip Hurepel's son Alberic. The countship passed, through heiresses, to the houses of Fayel and Nanteuil, and in the 15th century was acquired by Antoine de Chabannes (d. 1488), one of the favourites of King Charles VII., by his marriage with Marguerite, heiress of Reynald V. of Nanteuil-Aci and Marie of Dammartin. This Antoine de Chabannes, count of Dammartin in right of his wife, fought under the standard of Joan of Arc, became a leader of the *Écorcheurs*, took part in the war of the public weal against Louis XI., and then fought for him against the Burgundians. The collegiate church at Dammartin was founded by him in 1480, and his tomb and effigy are in the chancel. His son, Jean de Chabannes, left three heiresses, of whom the second left a daughter who brought the countship to Philippe de Boulainvilliers, by whose heirs it was sold in 1554 to the dukes of Montmorency. In 1632 the countship was confiscated by Louis XIII. and bestowed on the princes of Condé.

**DAMME**, a decayed city of Belgium, 5 m. N.E. of Bruges, once among the most important commercial ports of Europe. It is situated on the canal from Bruges to Sluys (Ecluse), but in the middle ages a navigable channel or river called the Zwyn gave ships access to it from the North Sea. The great naval battle of Sluys, in which Edward III. destroyed the French fleet and secured the command of the channel, was fought in the year 1340 at the mouth of the Zwyn. About 1395 this channel began to show signs of silting up, and during the next hundred years the process proved rapid. In 1490 a treaty was signed at Damme between the people of Bruges and the archduke Maximilian, and very soon after this event the channel became completely closed up, and the foreign merchant gilds or "nations" left the place for Antwerp. This signified the death of the port and was indirectly fatal to Bruges as well. The marriage of Charles the Bold and Margaret of York, sister of Edward IV., was celebrated at Damme on the 2nd of July 1468. It will give some idea of the importance of the town to mention that it had its own maritime law, known as *Droit maritime de Damme*. The new ship canal from Zeebrugge will not revive the ancient port, as it follows a different route, leaving Damme and Ecluse quite untouched. Damme, although long neglected, preserves some remains of its former prosperity, thanks to its remoteness from the area of international strife in the Low Countries. The tower of Notre Dame, dating from 1180, is a landmark across the dunes, and the church behind it, although a shell, merits inspection. Out of a portion of the ancient markets a *hôtel-de-ville* of modest dimensions has been constructed, and in the hospital of St Jean are a few pictures. Camille Lemonnier has given in one of his *Causeries* a striking picture of this faded scene of former greatness, now a solitude in which the few residents seem spectres rather than living figures.

**DAMOCLES**, one of the courtiers of the elder Dionysius of Syracuse. When he spoke in extravagant terms of the happiness of his sovereign, Dionysius is said to have invited him to a sumptuous banquet, at which he found himself seated under

a naked sword suspended by a single hair (Cicero, *Tusc.* v. 21; Horace, *Odes*, iii. 1, 17; Persius iii. 40).

**DAMOH**, a town and district of British India, in the Jubbulpore division of the Central Provinces. The town has a railway station, 48 m. E. of Saugor. Pop. (1901) 13,355. It has a considerable cattle-market, and a number of small industries, such as weaving, dyeing and pottery-making.

The DISTRICT OF DAMOH has an area of 2816 sq. m. Except on the south and east, where the offshoots from the surrounding hills and patches of jungle break up the country, the district consists of open plains of varying degrees of fertility, interspersed with low ranges and isolated heights. The richest tracts lie in the centre. The gentle declivity of the surface and the porous character of the prevailing sandstone formation render the drainage excellent. All the streams flow from south to north. The Sunar and the Bairma, the two principal rivers, traverse the entire length of the district. Little use has been made of any of the rivers for irrigation, though in many places they offer great facilities for the purpose. Damoh was first formed into a separate district in 1861. In 1901 the population was 285,326, showing a decrease of 12% in one decade due to famine. Damoh suffered severely from the famine of 1896-1897. Fortunately the famine of 1900 was little felt. A branch of the Indian Midland railway was opened throughout from Saugor to Katni in January 1899.

**DAMON**, of Syracuse, a Pythagorean, celebrated for his disinterested affection for Phintias (not, as commonly given, Pythias), a member of the same sect. Condemned to death by Dionysius the Elder (or Younger) of Syracuse, Phintias begged to be set at liberty for a short time that he might arrange his affairs. Damon pledged his life for the return of his friend; and Phintias faithfully returned before the appointed day of execution. The tyrant, to express his admiration of their fidelity, released both the friends and begged to be admitted to their friendship (Diod. Sic. x. 4; Cicero, *De Off.* iii. 10). Hyginus (*Fab.* 257, who is followed by Schiller in his ballad, *Die Bürgschaft*) tells a similar story, in which the two friends are named Moerus and Selinuntius.

**DAMOPHON**, a Greek sculptor of Messene, who executed many statues for the people of Messene, Megalopolis, Aegium and other cities of Peloponnesus. Considerable fragments, including three colossal heads from a group by him representing Demeter, Persephone, Artemis and the giant Anytus, have been discovered on the site of Lycosura in Arcadia, where was a temple of the goddess called "The Mistress." They are preserved in part in the museum at Athens and partly on the spot. Hence there has arisen a great controversy as to the date of the artist, who has been assigned to various periods, from the 4th century B.C. to the 2nd A.D. A good account of the whole matter will be found in Frazer's *Pausanias*, iv. 372-379. Frazer wisely inclines to an early date; it is in fact difficult to find any period, when the cities mentioned were in a position to found temples, later than the time of Alexander.

**DAMP**, a common Teutonic word, meaning vapour or mist (cf. Ger. *Dampf*, steam), and hence moisture. In its primitive sense the word persists in the vocabulary of coal-miners. Their "firedamp" (formerly fulminating damp) is marsh gas, which, when mixed with air and exploded, produced "choke damp," "after damp," or "suffocating damp" (carbon dioxide). "Black damp" consists of accumulations of irrespirable gases, mostly nitrogen, which cause the lights to burn dimly, and the term "white damp" is sometimes applied to carbon monoxide. As a verb, the word means to stifle or check; hence damped vibrations or oscillations are those which have been reduced or stopped, instead of being allowed to die out naturally; the "dampers" of the piano are small pieces of felt-covered wood which fall upon the strings and stop their vibrations as the keys are allowed to rise; and the "damper" of a chimney or flue, by restricting the draught, lessens the rate of combustion.

**DAMPIER, WILLIAM** (1652-1715), English buccaneer, navigator and hydrographer, was born at East Coker, Somersetshire,

in 1652 (baptized 8th of June). Having early become an orphan, he was placed with the master of a ship at Weymouth, in which he made a voyage to Newfoundland. On his return he sailed to Bantam in the East Indies. He served in 1673 in the Dutch War under Sir Edward Sprague, and was present at two engagements (28th of May; 4th of June); but then fell sick and was put ashore. In 1674 he became an under-manager of a Jamaica estate, but continued only a short time in this situation. He afterwards engaged in the coasting trade, and thus acquired an accurate knowledge of all the ports and bays of the island. He made two voyages to the Bay of Campeachy (1675-1676), and remained for some time with the logwood-cutters, varying this occupation with buccaneering. In 1678 he returned to England, again visiting Jamaica in 1679 and joining a party of buccaneers, with whom he crossed the Isthmus of Darien, spent the year 1680 on the Peruvian coast, and sacking, plundering and burning, made his way down to Juan Fernandez Island. After serving with another privateering expedition in the Spanish Main, he went to Virginia and engaged with a captain named Cook for a privateering voyage against the Spaniards in the South Seas. They sailed in August 1683, touched at the Guinea coast, and then proceeded round Cape Horn into the Pacific. Having touched at Juan Fernandez, they made the coast of South America, cruising along Chile and Peru. They took some prizes, and with these they proceeded to the Galapagos Islands and to Mexico, which last they fell in with near Cape Blanco. While they lay here Captain Cook died, and the command devolved on Captain Davis, who, with several other pirate vessels, English and French, raided the west American shores for the next year, attacking Guayaquil, Puebla Nova, &c. At last Dampier, leaving Davis, went on board Swan's ship, and proceeded with him along the northern parts of Mexico as far as southern California. Swan then proposed, as the expedition met with "bad success" on the Mexican coast, to run across the Pacific and return by the East Indies. They started from Cape Corrientes on the 31st of March 1686, and reached Guam in the Ladrones on the 20th of May; the men, having almost come to an end of their rations, had decided to kill and eat their leaders next, beginning with the "lusty and fleshy" Swan. After six months' drunkenness and debauchery in the Philippines, the majority of the crew, including Dampier, left Swan and thirty-six others behind in Mindanao, cruised (1687-1688) from Manila to Pulo Condore, from the latter to China, and from China to the Spice Islands and New Holland (the Australian mainland). In March 1688 they were off Sumatra, and in May off the Nicobars, where Dampier was marooned (at his own request, as he declares, for the purpose of establishing a trade in ambergris) with two other Englishmen, a Portuguese and some Malays. He and his companions contrived to navigate a canoe to Achin in Sumatra; but the fatigues and distress of the voyage proved fatal to several and nearly carried off Dampier himself. After making several voyages to different places of the East Indies (Tongking, Madras, &c.), he acted for some time, and apparently somewhat unwillingly, as gunner to the English fort of Benkulen. Thence he ultimately contrived to return to England in 1691.

In 1699 he was sent out by the English admiralty in command of the "Roebuck," especially designed for discovery in and around Australia. He sailed from the Downs, the 14th of January, with twenty months' provisions, touched at the Canaries, Cape Verdes and Bahia, and ran from Brazil round the Cape of Good Hope direct to Australia, whose west coast he reached on the 26th of July, in about 26° S. lat. Anchoring in Shark's Bay, he began a careful exploration of the neighbouring shore-lands, but found no good harbour or estuary, no fresh water or provisions. In September, accordingly, he left Australia, recruited and refitted at Timor, and thence made for New Guinea, where he arrived on the 3rd of December. By sailing along to its easternmost extremity, he discovered that it was terminated by an island, which he named New Britain (now Neu Pommern), whose north, south and east coasts he surveyed. That St George's Bay was really St George's Channel, dividing the island into two, was not perceived by Dampier; it was the discovery

of his successor, Philip Carteret. Nor did Dampier visit the west coast of New Britain or realize its small extent on that side. He was prevented from prosecuting his discoveries by the discontent of his men and the state of his ship. In May 1700 he was again at Timor, and thence he proceeded homeward by Batavia (4th July—17th October) and the Cape of Good Hope. In February 1701 he arrived off Ascension Island, when the vessel foundered (21st—24th February), the crew reaching land and staying in the island till the 3rd of April, when they were conveyed to England by some East Indiamen and warships bound for home. In 1703—1707 Dampier commanded two government privateers on an expedition to the South Seas with grievous unsuccess; better fortune attended him on his last voyage, as pilot to Woodes Rogers in the circumnavigation of 1708—1711. On the former venture Alexander Selkirk, the master of one of the vessels, was marooned at Juan Fernandez; on the latter Selkirk was rescued and a profit of nearly £200,000 was made. But four years before the prize-money was paid Dampier died (March 1715) in St Stephen's parish, Coleman Street, London. Dampier's accounts of his voyages are famous. He had a genius for observation, especially of the scientific phenomena affecting a seaman's life; his style is usually admirable—easy, clear and manly. His knowledge of natural history, though not scientific, appears surprisingly accurate and trustworthy.

See Dampier's *New Voyage Round the World* (1697); his *Voyages and Descriptions* (1699), a work supplementary to the *New Voyage*; his *Voyage to New Holland in . . . 1699* (1703, 1709); also Funnell's *Narrative of the Voyage of 1703—1707*; Dampier's *Vindication of his Voyage* (1707); Welbe's *Answer to Captain Dampier's Vindication*; Woodes Rogers, *Cruising Voyage Round the World* (1712). (C. R. B.)

**DAN** (from a Hebrew word meaning "judge"), a tribe of Israel, named after a son of Jacob and Bilhah, the maid of Rachel. The meaning of the name (referred to in Gen. xxx. 5 seq., xlix. 16) connects Dan with Dinah ("judgment"), the daughter of Leah, whose story in Gen. xxxiv. (cf. xlix. 5 seq.) seems to point to an Israelite occupation of Shechem, a treacherous massacre of its Canaanite inhabitants by Simeon and Levi, and the subsequent scattering of the latter. But, historically, the occupation of Shechem, whether by conquest (Gen. xlviii. 22) or purchase (xxxiii. 19), is as obscure as the conquest of central Palestine itself (see JOSHUA), and the true relation between Dan and Dinah is uncertain. The earliest seats of Dan lay at Zorah, Eshtaol and Kirjath-jearim, west of Jerusalem, whence they were forced to seek a new home, and a valuable narrative detailing some of the events of the move is preserved in the story of the sanctuary of the Ephraimite Micah (*q.v.*). Laish (Leshem) was taken with the sword and re-named Dan (see below). Here a sanctuary was founded under the guardianship of Jonathan, the grandson of Moses, which survived until the "captivity of the land" (by Tiglath-Pileser IV. in 733—732), or, according to another notice, until the fall of Shiloh (Judg. xviii. 30 seq.). Dan formed the northern limit of the land,<sup>1</sup> and with Abel (-beth-Maacah) was an old place renowned for Israelite lore (2 Sam. xx. 18; on the text see the commentaries). Little can be made of Dan's history. The reference to it as a seafaring folk (Judg. v. 17) is difficult, and it is uncertain whether its character as represented in Gen. xlix. 17, Deut. xxxiii. 22, refers to its earlier or later seat. The post-exilic accounts of its southern border would make it part of Judah, and both of them are in tradition the greatest of the tribes in the wanderings in the wilderness. Dan was subsequently either regarded as the embodiment of wickedness or entirely ignored; late speculation that the Antichrist should spring from it appears to be based upon an interpretation of Gen. xlix. 17 (see further R. H. Charles, *Testaments of the Twelve Patriarchs*, pp. 128 seq.).

A brief record of the Danite migration is found in some old detached fragments which K. Budde (*Richter und Samuel*) ingeniously arranges thus:—Judg. i. 34 (Amorite pressure); Josh. xix. 47a (see the Septuagint), 47b; Judg. i. 35. The position

<sup>1</sup> On the late phrase "Dan to Beersheba" as the extreme points of religious life in Israel, see H. W. Hogg, *Expositor*, viii. 411—421 (1898); and for a complete discussion of the tribe, his art. "Dan" in *Encyc. Bib.*

of Judg. xvii. seq. (after the stories of Samson) may imply that the Philistines, not the Amorites, caused the migration (cf. 1 Sam. vii. 14, where the two ethnical terms interchange). The Mosaic priesthood and the reference to Shiloh suggest that the story of Eli may have belonged to this cycle of narratives; and the spoliation of the unknown sanctuary of the Ephraimite Micah and the character of the fierce Puritan tribesmen connect Dan with the problems of the tribes of Simeon and Levi. Dan's northern home lay near Beth-rehob, which appears to have been Aramean in David's time (2 Sam. x. 6), and it is possible that the migration has been antedated (cf. similarly the case of Jair, Num. xxxii. 41, Judg. x. 3—5). The Tyrian artificer sent to Solomon by Hiram was partly of Danite descent (2 Chron. ii. 13 seq.; but of Naphtali, so 1 Kings vii. 14); and of the two workers in brass who took part in the building of the tabernacle in the desert, one was Danite (Oholiab, Ex. xxxi. 6), while the other appears to have been Calebite (Bezalel, *ib.*, v. 2; 1 Chron. ii. 20). The Kenites, too, have been regarded as a race of metal-workers (see CAIN, KENITES), and there is evidence which would show that Danites, Calebites and Kenites were once closely associated in tradition.

See S. A. Cook, *Critical Notes*, Index, *s.v.*: E Meyer, *Israeliten*, pp. 525 seq. (S. A. C.)

**DAN**, a town of ancient Israel, near the head-waters of the Jordan, inhabited before its conquest by the Danites by a peaceful commercial population who called their city Laish or Leshem (Josh. xix. 47, Judg. xviii.). It appears to have been even at this early period a sacred city, the shrine of Micah being removed hither, and it was chosen by Jeroboam as the site of one of his calf-shrines. It makes the north limit of Palestine in the proverbial expression "from Dan to Beersheba." The town was plundered by Benhadad of Damascus, and appears from that time to have gradually declined. Its site is sought in the mound called Tell-el-Kadi, "the hill of the judge" (Dan="judge" in Hebrew), though weighty authorities incline to place it 4 m. east of this, at Baniyas, the old Caesarea Philippi. (See above.)

**DANA, CHARLES ANDERSON** (1819—1897), American journalist, was born in Hinsdale, New Hampshire, on the 8th of August 1819. At the age of twelve he became a clerk in his uncle's general store at Buffalo, which failed in 1837. In 1839 he entered Harvard, but the impairment of his eyesight in 1841 forced him to leave college, and caused him to abandon his intention of entering the ministry and of studying in Germany. From September 1841 until March 1846 he lived at Brook Farm, where he was made one of the trustees of the farm, was head waiter when the farm became a Fourierite phalanx, and was in charge of the phalanstery's finances when its buildings were burned in 1846. He had previously written for (and managed) the *Harbinger*, the Brook Farm organ, and had written as early as 1844 for the Boston *Chronotype*. In 1847 he joined the staff of the New York *Tribune*, and in 1848 he wrote from Europe letters to it and other papers on the revolutionary movements of that year. Returning to the *Tribune* in 1849, he became its managing-editor, and in this capacity actively promoted the anti-slavery cause, seeming to shape the paper's policy at a time when Greeley was undecided and vacillating. In 1862 his resignation was asked for by the board of managers of the *Tribune*, apparently because of wide temperamental differences between him and Greeley. Secretary of War Stanton immediately made him a special investigating agent of the war department; in this capacity Dana discovered frauds of quartermasters and contractors, and as the "eyes of the administration," as Lincoln called him, he spent much time at the front, and sent to Stanton frequent reports concerning the capacity and methods of various generals in the field; he went through the Vicksburg campaign and was at Chickamauga and Chattanooga, and urged the placing of General Grant in supreme command of all the armies in the field. Dana was second assistant-secretary of war in 1864—1865, and in 1865—1866 conducted the newly-established and unsuccessful Chicago *Republican*. He became the editor and part-owner of the New York *Sun* in 1868, and remained in control of it until his death at Glen Cove, Long Island, New York.

on the 17th of October 1897. Under Dana's control the *Sun* opposed the impeachment of President Johnson; it supported Grant for the presidency in 1868; it was a sharp critic of Grant as president; and in 1872 took part in the Liberal Republican revolt and urged Greeley's nomination. It favoured Tilden, the Democratic candidate for the presidency, in 1876, opposed the Electoral Commission and continually referred to Hayes as the "fraud president." In 1884 it supported Benjamin F. Butler, the candidate of Greenback-Labor and Anti-Monopolist parties, for the presidency, and opposed Blaine (Republican) and even more bitterly Cleveland (Democrat); it supported Cleveland and opposed Harrison in 1888, although it had bitterly criticized Cleveland's first administration, and was to criticize nearly every detail of his second, with the exception of Federal interference in the Pullman strike of 1894; and in 1896, on the free-silver issue, it opposed Bryan, the Democratic candidate for the presidency. Dana's literary style came to be the style of the *Sun*—simple, strong, clear, "boiled down." *The Art of Newspaper Making*, containing three lectures which he wrote on journalism, was published in 1900. With George Ripley he edited *The New American Cyclopaedia* (15 vols., 1857-1863), reissued as the *American Cyclopaedia* in 1873-1876. He had excellent taste in the fine arts and edited an anthology, *The Household Book of Poetry* (1857). He was a very good linguist, published several versions from the German, and read the Romance and Scandinavian languages; he was an art connoisseur and left a remarkable collection of Chinese porcelain. Dana's *Reminiscences of the Civil War* was published in 1898, as was his *Eastern Journeys, Notes of Travel*. He also edited a campaign *Life of U. S. Grant*, published over his name and that of General James H. Wilson in 1868.

See James Wilson, *The Life of Charles A. Dana* (New York, 1907).

**DANA, FRANCIS** (1743-1811), American jurist, was born in Charlestown, Massachusetts, on the 13th of June 1743. He was the son of Richard Dana (1699-1772), a leader of the Massachusetts provincial bar, and a vigorous advocate of colonial rights in the pre-revolutionary period. Francis Dana graduated at Harvard in 1762, was admitted to the bar in 1767, and, being an opponent of the British colonial policy, became a leader of the Sons of Liberty, and in 1774 was a member of the first provincial congress of Massachusetts. During a two years' visit to England he sought earnestly to gain friends to his colony's cause, but returned to Boston in April 1776 convinced that a friendly settlement of the dispute was impossible. He was a member of the Massachusetts executive council from 1776 to 1780, and a delegate to the Continental Congress from 1776 to 1778. As a member of the latter body he became chairman in January 1778 of the committee appointed to visit Washington at Valley Forge, and confer with him concerning the reorganization of the army. This committee spent about three months in camp, and assisted Washington in preparing the plan of reorganization which Congress in the main adopted. In this year he was also a member of a committee to consider Lord North's offer of conciliation, which he vigorously opposed. In the autumn of 1779 he was appointed secretary to John Adams, who had been selected as minister plenipotentiary to negotiate treaties of peace and commerce with Great Britain, and in December 1780 he was appointed diplomatic representative to the Russian government. He remained at St Petersburg from 1781 to 1783, but was never formally received by the empress Catherine. In February 1784 he was again chosen a delegate to Congress, and in January 1785 he became a justice of the Massachusetts supreme court. He was chief justice of this court from 1791 to 1806, and presided with ability and rare distinction. He was an earnest advocate of the adoption of the Federal constitution, was a member of the Massachusetts convention which ratified that instrument, and was one of the most influential advisers of the leaders of the Federalist party. His tastes were scholarly, and he was one of the founders of the American Academy of Arts and Sciences. He died at Cambridge, Massachusetts, on the 25th of April 1811.

His son, **RICHARD HENRY DANA** (1787-1879), was born in Cambridge, Massachusetts, on the 15th of November 1787. He

was educated at Harvard in the class of 1808. Subsequently he studied law and in 1811 was admitted to practice. But all other interests were early subordinated to his love of literature, to which the greater part of his long life was devoted. He became in 1814 a member of a literary society in Cambridge, known as the Anthology Club. This club began the publication of a monthly magazine, *The Monthly Anthology*, which gave way in 1815 to *The North American Review*. In the editorial control of this periodical he was associated with Jared Sparks and Edward T. Channing (1790-1856) until 1821, contributing essays and criticisms which attracted wide attention. In 1821-1822 he edited in New York a short-lived literary magazine, *The Idle Man*. He published his first volume of *Poems* in 1827, and in 1833 appeared his *Poems and Prose Writings*, republished in 1850 in two volumes, in which were included practically all of his poems and of his prose contributions to periodical literature. Although the bulk of his published writings was not large, his influence on American literature during the first half of the 19th century was surpassed by that of few of his contemporaries.

**RICHARD HENRY DANA** (1815-1882), son of the last-mentioned, was born in Cambridge, Massachusetts, on the 1st of August 1815. He entered Harvard in the class of 1835, but at the beginning of his junior year an illness affecting his sight necessitated a suspension of his college work, and in August 1834 he shipped before the mast for California, returning in September 1836. The rough experience of this voyage did more than endow him with renewed health; it changed him from a dreamy, sensitive boy, hereditarily disinclined to any sort of active career, into a self-reliant, energetic man, with broad interests and keen sympathies. He re-entered Harvard in December 1836 and graduated in June 1837. He was a student at the Harvard law school from 1837 to 1840, and from January 1839 to February 1840 he was also an instructor in elocution in the college. In 1840 the notes of his sea-trip were published under the title *Two Years Before the Mast*. The book attained an almost unprecedented popularity both in America and in Europe, where it was translated into several languages; and it came to be considered a classic. Immediately after the appearance of this book Dana began the practice of law, which brought him a large number of maritime cases. In 1841 he published *The Seaman's Friend*, republished in England as *The Seaman's Manual*, which was long the highest authority on the legal rights and duties of seamen. After gaining recognition as one of the most prominent members of the Suffolk bar, he became associated in 1848 with the Free Soil movement, and took a prominent part in the Buffalo convention of that year. This step, which caused him to be ostracized for a time from the Boston circles in which he had been reared, brought him the cases of the fugitive slaves, Shadrach, Sims and Burns, and of the rescuers of Shadrach. On the night following the surrender of Burns (May 1854) Dana was brutally assaulted on the Boston streets. In 1853 he took a prominent part in the state constitutional convention. He allied himself with the Republican party on its organization, but his inborn dislike for political manoeuvring prevented his ever becoming prominent in its councils. In 1857 he became a regular attendant at the meetings of the famous Boston Saturday Club, to the members of which he dedicated his account of a vacation trip, *To Cuba and Back* (1857). He returned to America from a trip round the world in time to participate in the presidential campaign of 1860, and after Lincoln's inauguration he was appointed United States district attorney for Massachusetts. In this office in 1863 he won before the Supreme Court of the United States the famous prize case of the "Amy Warwick," on the decision in which depended the right of the government to blockade the Confederate ports, without giving the Confederate States an international status as belligerents. He brought out in 1865 an edition of *Wheaton's International Law*, his notes constituting a most learned and valuable authority on international law and its bearings on American history and diplomacy; but immediately after its publication Dana was charged by the editor of two earlier editions, William Beach Lawrence, with infringing his copyright, and was involved in litigation which was continued

for thirteen years. In such minor matters as arrangement of notes and verification of citations the court found against Dana, but in the main Dana's notes were vastly different from Lawrence's. In 1865 Dana declined an appointment as a United States district judge. During the Reconstruction period he favoured the congressional plan rather than that of President Johnson, and on this account resigned the district-attorneyship. In 1867-1868 he was a member of the Massachusetts House of Representatives, and in 1867 was retained with William M. Evarts to prosecute Jefferson Davis, whose admission to bail he counselled. In 1877 he was one of the counsel for the United States before the commission which in accordance with the treaty of Washington met at Halifax, N.S., to arbitrate the fisheries question between the United States and Great Britain. In 1878 he gave up his law practice and devoted the rest of his life to study and travel. He died in Rome, Italy, on the 9th of January 1882.

See Charles Francis Adams, *Richard Henry Dana: a Biography* (2 vols., Boston, Mass., 1891).

**DANA, JAMES DWIGHT** (1813-1895), American geologist, mineralogist and zoologist, was born in Utica, New York, on the 12th of February 1813. He early displayed a taste for science, which had been fostered by Fay Edgerton, a teacher in the Utica high school, and in 1830 he entered Yale College, in order to study under Benjamin Silliman the elder. Graduating in 1833, for the next two years he was teacher of mathematics to midshipmen in the navy, and sailed to the Mediterranean while engaged in his duties. In 1836-1837 he was assistant to Professor Silliman in the chemical laboratory at Yale, and then, for four years, acted as mineralogist and geologist of a United States exploring expedition, commanded by Captain Charles Wilkes, in the Pacific ocean (see WILKES, CHARLES). His labours in preparing the reports of his explorations occupied parts of thirteen years after his return to America in 1842. In 1844 he again became a resident of New Haven, married the daughter of Professor Silliman, and in 1850, on the resignation of the latter, was appointed Silliman Professor of Natural History and Geology in Yale College, a position which he held till 1892. In 1846 he became joint editor and during the later years of his life he was chief editor of the *American Journal of Science and Arts* (founded in 1818 by Benjamin Silliman), to which he was a constant contributor, principally of articles on geology and mineralogy. A bibliographical list of his writings shows 214 titles of books and papers, beginning in 1835 with a paper on the conditions of Vesuvius in 1834, and ending with the fourth revised edition (finished in February 1895) of his *Manual of Geology*. His reports on *Zoophytes*, on the *Geology of the Pacific Area*, and on *Crustacea*, summarizing his work on the Wilkes expedition, appeared in 1846, 1849 and 1852-1854, in quarto volumes, with copiously illustrated atlases; but as these were issued in small numbers, his reputation more largely rests upon his *System of Mineralogy* (1837 and many later editions in 1892); *Manual of Geology* (1862; ed. 4, 1895); *Manual of Mineralogy* (1848), afterwards entitled *Manual of Mineralogy and Lithology* (ed. 4, 1887); and *Coral Islands* (1872; ed. 2, 1890). In 1887 Dana revisited the Hawaiian Islands, and the results of his further investigations were published in a quarto volume in 1890, entitled *Characteristics of Volcanoes*. By the Royal Society of London he was awarded the Copley medal in 1877; and by the Geological Society the Wollaston medal in 1874. His powers of work were extraordinary, and in his 82nd year he was occupied in preparing a new edition of his *Manual of Geology*, the 4th edition being issued in 1895. He died on the 14th of April 1895.

His son EDWARD SALISBURY DANA, born at New Haven on the 16th of November 1849, is author of *A Textbook of Mineralogy* (1877; new ed. 1898) and a *Text Book of Elementary Mechanics* (1881). In 1879-80 he was professor of natural philosophy and then became professor of physics at Yale.

See *Life of J. D. Dana*, by Daniel C. Gilman (1899).

**DANAE**, in Greek legend, daughter of Acrisius, king of Argos. Her father, having been warned by an oracle that she would bear a son by whom he would be slain, confined Danae in a brazen

tower. But Zeus descended to her in a shower of gold, and she gave birth to Perseus, whereupon Acrisius placed her and her infant in a wooden box and threw them into the sea. They were finally driven ashore on the island of Seriphus, where they were picked up by a fisherman named Dictys. His brother Polydectes, who was king of the island, fell in love with Danae and married her. According to another story, her son Perseus, on his return with the head of Medusa, finding his mother persecuted by Polydectes, turned him into stone, and took Danae back with him to Argos. Latin legend represented her as landing on the coast of Latium and marrying Pilumnus or Picumnus, from whom Turnus, king of the Rutulians, was descended. Danae formed the subject of tragedies by Aeschylus, Sophocles, Euripides, Livius Andronicus and Naevius. She is the personification of the earth suffering from drought, on which the fertilizing rain descends from heaven.

Apollodorus ii. 4; Sophocles, *Antigone*, 944; Horace, *Odes*, iii. 16; Virgil, *Aeneid*, vii. 410. See also P. Schwarz, *De Fabula Danae* (1881).

**DANAŌ**, a town of the province of Cebú, island of Cebú, Philippine Islands, on the E. coast, at the mouth of the Danao river, 17 m. N.N.E. of Cebú, the capital. Pop. (1903) 16,173. Danao has a comparatively cool and healthy climate, is the centre of a rich agricultural region producing rice, Indian corn, sugar, copra and cacao, and coal is mined in the vicinity. The language is Cebú-Visayan.

**DANAUS**, in Greek legend, son of Belus, king of Egypt, and twin-brother of Aegyptus. He was born at Chemmis (Panopolis) in Egypt, but having been driven out by his brother he fled with his fifty daughters to Argos, the home of his ancestress Io. Here he became king and taught the inhabitants of the country to dig wells. In the meantime the fifty sons of Aegyptus arrived in Argos, and Danaus was obliged to consent to their marriage with his daughters. But to each of these he gave a knife with injunctions to slay her husband on the marriage night. They all obeyed except Hyperm(n)estra, who spared Lynceus. She was brought to trial by her father, acquitted and afterwards married to her lover. Being unable to find suitors for the other daughters, Danaus offered them in marriage to the youths of the district who proved themselves victorious in racing contests (Pindar, *Pythia*, ix. 117). According to another story, Lynceus slew Danaus and his daughters and seized the throne of Argos (schol. on Euripides, *Hecuba*, 886). By way of expiation for their crime the Danaides were condemned to the endless task of filling with water a vessel which had no bottom. This punishment, originally inflicted on those who neglected certain mystic rites, was transferred to those who, like the Danaides, despised the mystic rite of marriage; cf. the water-bearing figure (*Λουτροφόρος*) on the grave of unmarried persons. The murder of the sons of Aegyptus by their wives is supposed to represent the drying up of the rivers and springs of Argolis in summer by the agency of the nymphs.

Apollodorus ii. 1; Horace, *Odes*, iii. 11; O. Waser, in *Archiv für Religionswissenschaft*, ii. Heft 1, 1899; articles in Pauly-Wissowa's *Realencyclopädie* and W. H. Roscher's *Lexikon der Mythologie*; Campbell Bonner, in *Harvard Studies*, xiii. (1902).

**DANBURITE**, a rare mineral species consisting of calcium and boron orthosilicate,  $\text{CaB}_2(\text{SiO}_4)_2$ , crystallizing in the orthorhombic system. It was discovered by C. U. Shepard in 1839 at Danbury, Connecticut, U.S.A., and named by him after this locality. The crystals are prismatic in habit, and closely resemble topaz in form and interfacial angles. There is an imperfect cleavage parallel to the basal plane. Crystals are transparent to translucent, and colourless to pale yellow; hardness 7; specific gravity 3.0. At Danbury the mineral occurs with microcline and oligoclase embedded in dolomite. Large crystals, reaching 4 in. in length, have been found with calcite in veins traversing granite at Russell in St Lawrence county, New York. Smaller but well-developed crystals have been found on gneiss at Mt. Scopi and Petersthal (the valley of the Vals Rhine) in Switzerland. Splendid crystals have recently been obtained from Japan.

**DANBURY**, a city and one of the county-seats of Fairfield county, Connecticut, U.S.A., in Danbury township, in the



south-west part of the state, on the Still river, a tributary of the Housatonic. Pop. (1890) 16,552; (1900) 16,537, of whom 3702 were foreign-born. In 1900 the population of the township, including that of the city, was 19,474, and in 1910, 23,502. Danbury is served by three divisions of the New York, New Haven & Hartford railway; by the Danbury & Harlem electric railway, which connects at Goldens Bridge, New York, with the Harlem division of the New York Central; and by an electric line to Bethel, Connecticut. Lake Kenosia, about 2½ m. from the centre of the city, is a pleasure resort. A state normal school was opened in Danbury in 1904, and there is a home for destitute and homeless children under private (unsectarian) control. The city has good water-power, and the municipality owns the water works. The principal industry is the manufacture of felt hats, begun in 1780, and in 1905 engaging about thirty factories, with a product for the year valued at \$5,798,107 (71.9% of the value of all the factory products of the city, and 15.8% of the value of all the felt hats produced in the United States). The city ranked first among the cities of the country in this industry in 1900 and second in 1905, and in 1905 no other city showed so high a degree of specialization in it. Silver-plated ware (mostly manufactured by Rogers Bros.) is another important product. At Danbury is held annually the well-known agricultural Danbury Fair. The township was settled in 1684 by emigrants from Norwalk, and received its present name in 1687. When the War of Independence opened, Enoch Crosby, believed to be the original of Harvey Birch, the hero of J. F. Cooper's *The Spy*, was a resident of Danbury. A depot of military supplies was established in the village of Danbury in 1776; in April 1777 Governor William Tryon, of New York, raided the place, destroying the military stores and considerable private property. During his retreat he was attacked (April 26th) at Ridgefield (about 9 m. south by east of Danbury) by the Americans under General David Wooster (1710-1777), who was fatally wounded in the conflict (being succeeded by General Benedict Arnold), and to whose memory a monument was erected in Danbury in 1854. Danbury was chartered as a borough in 1832 and as a city in 1880. In 1870 the *Danbury News* was established by the consolidation of the *Jeffersonian* and the *Times*, by James Montgomery Bailey (1841-1894), from 1865 to 1870 proprietor of the *Times*. He wrote for the *News* humorous sketches, which made him and the paper famous, Bailey being known as the "Danbury News Man"; among his books are *Life in Danbury* (1873), *The Danbury News Man's Almanac* (1873), *They All Do It* (1877), *England from a Back Window* (1878), *Mr Philip's Goneness* (1879), *The Danbury Boom* (1880), and *History of Danbury* (1896).

**DANBY, FRANCIS** (1793-1861), English painter, was born in the south of Ireland on the 16th of November 1793. His father farmed a small property he owned near Wexford, but his death caused the family to remove to Dublin, while Francis was still a schoolboy. He began to practice drawing at the Royal Dublin Society's schools; and under an erratic young artist named O'Connor he began painting landscape. Danby also made acquaintance with George Petrie, and all three left for London together in 1813. This expedition, undertaken with very inadequate funds, quickly came to an end, and they had to get home again by walking. At Bristol they made a pause, and Danby, finding he could get trifling sums for water-colour drawings, remained there working diligently and sending to the London exhibitions pictures of importance. There his large pictures in oil quickly attracted attention. "The Upas Tree" (1820) and "The Delivery of the Israelites" (1825) brought him his election as an associate of the Royal Academy. He left Bristol for London, and in 1828 exhibited his "Opening of the Sixth Seal" at the British Institution, receiving from that body a prize of 200 guineas; and this picture was followed by two others from the Apocalypse. He suddenly left London, declaring that he would never live there again, and that the Academy, instead of aiding him, had, somehow or other, used him badly. Some insurmountable domestic difficulty overtook him also, and for eleven or twelve years he lived on the Lake of Geneva, a

Bohemian with boat-building fancies, painting only now and then. He returned to England in 1841, when his sons, James and Thomas, both artists, were growing up. Other pictures by him were "The Golden Age" and "The Evening Gun," the first begun before he left England, the second painted after his return; he had taken up his abode at Exmouth, where he died on the 9th of February 1861.

**DANCE**, the name of an English family distinguished in architecture, art and the drama. **GEORGE DANCE**, the elder (1700-1768), obtained the appointment of architect to the city of London, and designed the Mansion House (1739); the churches of St Botolph, Aldgate (1741), St Luke's, Old Street; St Leonard, Shoreditch; the old excise office; Broad Street; and other public works of importance. He died on the 8th of February 1768. His eldest son, **JAMES DANCE** (1722-1744), was born on the 17th of March 1722, and educated at the Merchant Taylors' School and St John's College, Oxford, which he left before graduating. He took the name of Love, and became an actor and playwright of no great merit. In the former capacity he was for twelve years connected with Drury Lane theatre. He wrote "an heroic poem" on *Cricket*, about 1740, and a volume of *Poems on Several Occasions* (1754), and a number of comedies—the earliest *Pamela* (1742).

George Dance's third son, **Sir NATHANIEL DANCE-HOLLAND**, Bart. (1735-1811), was born on the 18th of May 1735, and studied art under Francis Hayman, and in Italy, where he met Angelica Kauffmann, to whom he was devotedly and hopelessly attached. From Rome he sent home "Dido and Aeneas" (1763), and he continued to paint occasional historical pictures of the same quasi-classic kind throughout his career. On his return to England he took up portrait-painting with great success, and contributed to the first exhibition of the Royal Academy, of which he was a foundation member, full-length portraits of George III. and his queen. These, and his portraits of Captain Cook and of Garrick as Richard III., engraved by Dixon, are his best-known works. Himself a rich man, in 1790 he married a widow with £15,000 a year, dropped his profession, and became M.P. for East Grinstead, taking the additional name of Holland. He was made a baronet in 1800. He died on the 15th of October 1811, leaving a fortune of £200,000.

George Dance's fifth and youngest son, **GEORGE DANCE**, the younger (1741-1825), succeeded his father as city surveyor and architect in 1768. He was then only twenty-seven, had spent several years abroad, chiefly in Italy with his brother Nathaniel, and had already distinguished himself by designs for Blackfriars Bridge sent to the 1761 exhibition of the Incorporated Society of Artists. His first important public work was the rebuilding of Newgate prison in 1770. The front of the Guildhall was also his. He, too, was a foundation member of the Royal Academy, and for a number of years the last survivor of the forty original academicians. His last years were devoted to art rather than to architecture, and after 1798 his Academy contributions consisted solely of chalk portraits of his friends, seventy-two of which were engraved and published (1808-1814). He resigned his office in 1815, and after many years of illness died on the 14th of January 1825, and was buried in St Paul's. His son, **CHARLES DANCE** (1794-1863), was for thirty years registrar, taxing officer and chief clerk of the insolvent debtors' court, retiring, when it was abolished, on an allowance. In collaboration with J. R. Planché and others, or alone, he wrote a great number of extravaganzas, farces and comediettas. He was one of the first, if not the first, of the burlesque writers, and was the author of those produced so successfully by Madame Vestris for years at the Olympic. Of his farces, *Delicate Ground*, *Who Speaks First?*, *A Morning Call* and others are still occasionally revived. He died on the 6th of January 1863.

**DANCE** (Fr. *danse*; of obscure origin, connected with Old High Ger. *danson*, to stretch). The term "dancing" in its widest sense includes three things:—(1) the spontaneous activity of the muscles under the influence of some strong emotion, such as social joy or religious exultation; (2) definite combinations of graceful movements performed for the sake of the pleasure

which the exercise affords to the dancer or to the spectator; (3) carefully trained movements which are meant by the dancer vividly to represent the actions and passions of other people. In the highest sense it seems to be for prose-gesture what song is for the instinctive exclamations of feeling. Regarded as the outlet or expression of strong feeling, dancing does not require much discussion, for the general rule applies that such demonstrations for a time at least sustain and do not exhaust the flow of feeling. The voice and the facial muscles and many of the organs are affected at the same time, and the result is a high state of vitality which among the spinning Dervishes or in the ecstatic worship of Bacchus and Cybele amounted to something like madness. Even here there is traceable an undulatory movement which, as Herbert Spencer says, is "habitually generated by feeling in its bodily discharge." But it is only in the advanced or volitional stage of dancing that we find developed the essential feature of *measure*, which has been said to consist in "the alternation of stronger muscular contractions with weaker ones," an alternation which, except in the cases of savages and children, "is compounded with longer rises and falls in the degree of muscular excitement." In analysing the state of mind which this measured dancing produces, we must first of all allow for the pleasant glow of excitement caused by the excess of blood sent to the brain. But apart from this, there is an agreeable sense of uniformity in the succession of muscular efforts, and in the spaces described, and also in the period of their recurrence. If the steps of dancing and the intervals of time be not precisely equal, there is still a pleasure depending on the gradually increasing intensity of motion, on the undulation which uniformly rises in order to fall. As Florizel says to Perdita, "When you do dance, I wish you a wave of the sea" (*Winter's Tale*, iv. 3). The mind feels the beauty of emphasis and cadence in muscular motion, just as much as in musical notes. Then, the figure of the dance is frequently a circle or some more graceful curve or series of curves,—a fact which satisfies the dancer as well as the eye of the spectator. But all such effects are intensified by the use of music, which not only brings a perfectly distinct set of pleasurable sensations to dancer and spectator, but by the control of dancing produces an inexpressibly sweet harmony of sound and motion. This harmony is further enriched if there be two dancing together on one plan, or a large company of dancers executing certain evolutions, the success of which depends on the separate harmonies of all the couples. The fundamental condition is that throughout the dance all the dancers keep within their bases of gravity. This is not only required for the dancers' own enjoyment, but, as in the famous Mercury on tiptoe, it is essential to the beautiful effect for the spectator. The idea of much being safely supported by little is what proves attractive in the posturing ballet. But this is merely one condition of graceful dancing, and if it be made the chief object the dancer sinks into the acrobat.

Dancing is, in fact, the universal human expression, by movements of the limbs and body, of a sense of rhythm which is implanted among the primitive instincts of the animal world. The rhythmic principle of motion extends throughout the universe, governing the lapse of waves, the flow of tides, the reverberations of light and sound, and the movements of celestial bodies; and in the human organism it manifests itself in the automatic pulses and flexions of the blood and tissues. Dancing is merely the voluntary application of the rhythmic principle, when excitement has induced an abnormally rapid oxidization of brain tissue, to the physical exertion by which the overcharged brain is relieved. This is primitive dancing; and it embraces all movements of the limbs and body expressive of joy or grief, all pantomimic representations of incidents in the lives of the dancers, all performances in which movements of the body are employed to excite the passions of hatred or love, pity or revenge, or to arouse the warlike instincts, and all ceremonies in which such movements express homage or worship, or are used as religious exercises. Although music is not an essential part of dancing, it almost invariably accompanies it, even in the crudest form of a rhythm beaten out on a drum.

*Primitive and Ancient Dancing.*—In Tigrè the Abyssinians dance the *chassée* step in a circle, and keep time by shrugging their shoulders and working their elbows backwards and forwards. At intervals the dancers squat on the ground, still moving the arms and shoulders in the same way. The Bushmen dance in their low-roofed rooms supporting themselves by sticks; one foot remains motionless, the other dances in a wild irregular manner, while the hands are occupied with the sticks. The Gonds, a hill-tribe of Hindustan, dance generally in pairs, with a shuffling step, the eyes on the ground, the arms close to the body, and the elbows at an angle with the closed hand. Advancing to a point, the dancer suddenly erects his head, and wheels round to the starting point. The women of the Pultooh tribe dance in a circle, moving backwards and forwards in a bent posture. The Santal women, again, are slow and graceful in dance; joining hands, they form themselves into the arc of a circle, towards the centre of which they advance and then retire, moving at the same time slightly towards the right, so as to complete the circle in an hour. The Kukis of Assam have only the rudest possible step, an awkward hop with the knees very much bent. The national dance of the Kamchadale is one of the most violent known, every muscle apparently quivering at every movement. But there, and in some other cases where men and women dance together, there is a trace of deliberate obscenity; the dance is, in fact, a rude representation of sexual passion. It has been said that some of the Tasmanian *corrobories* have a phallic design. The Yucatan dance of *naual* may also be mentioned. The Andamans hop on one foot and swing the arms violently backwards and forwards. The Veddahs jump with both feet together, patting their bodies, or clapping their hands, and make a point of bringing their long hair down in front of the face. In New Caledonia the dance consists of a series of twistings of the body, the feet being lifted alternately, but without change of place. The Fijians jump half round from side to side with their arms akimbo. The only modulation of the Samoan dance is one of time—a *crescendo* movement, which is well-known in the modern ball-room. The Javans are perhaps unique in their distinct and graceful gestures of the hands and fingers. At a Mexican feast called Huitzilopochtli, the noblemen and women danced tied together at the hands, and embracing one another, the arms being thrown over the neck. This resembles the dance variously known as the Greek Bracelet or Brawl, *Oppos*, or Bearsfeet; but all of them<sup>1</sup> probably are to a certain extent symbolical of the relations between the sexes. Actual contact of the partners, however, is quite intelligible as matter of pure dancing; for, apart altogether from the pleasure of the embrace, the harmony of the double rotation adds very much to the enjoyment. In a very old Peruvian dance of ceremony before the Inca, several hundreds of men formed a chain, each taking hold of the hand of the man beyond his immediate neighbour, and the whole body moving forwards and backwards three steps at a time as they approached the throne. In this, as in the national dance of the Coles of Lower Bengal, there was perhaps a suggestion of "l'union fait la force." In Yucatan stilts were occasionally used for dancing.

It seldom happens that dancing takes place without accompaniment, either by the dancers or by others. This is not merely because the feelings which find relief in dancing express themselves at the same time in other forms; in some cases, indeed, the vocal and instrumental elements largely predominate, and form the ground-work of the whole emotional demonstration. Whether they do so or not will of course depend on the intellectual advancement of the nation or tribe and upon the particular development of their aesthetical sensibility. A striking instance occurs among the Zulus, whose grand dances are merely the accompaniment to the colloquial war and hunting songs, in which the women put questions which are answered by the men. So also in Tahiti there is a set of national ballads and songs, referring to many events in the past and present lives of the

<sup>1</sup> Compare the Chica of South America, the Fandango of Spain, and the Angrismene or la Fachée of modern Greece. See also *Romaunt de la rose*, v. 776.

people. The fisherman, the woodsman, the canoe-builder, has each his trade song, which on public occasions at least is illustrated by dancing. But the accompaniment is often consciously intended, by an appeal to the ear, to regulate and sustain the excitement of the muscles. And a close relation will be found always to exist between the excellence of a nation's dancing and the excellence or complexity of its music and poetry. In some cases the performer himself sings or marks time by the clanking of ornaments on his person. In others the accompaniment consists sometimes of a rude chant improvised by those standing round, or of music from instruments, or of mere clapping of the hands, or of striking one stick against another or on the ground, or of "marking time," in the technical sense. The Tasmanians beat on a rolled-up kangaroo-skin. The Kamchadales make a noise like a continuous hiccup all through the dance. The Andamans use a large hollow dancing-board, on which one man is set apart to stamp. Sometimes it is the privilege of the tribal chief to sing the accompaniment while his people dance. The savages of New Caledonia whistle and strike upon the hip.

The rude imitative dances of early civilization are of extreme interest. In the same way the dances of the Ostyak tribes (Northern Asiatic) imitate the habitual sports of the chase and the gambols of the wolf and the bear and other wild beasts, the dancing consisting mainly of sudden leaps and violent turns which exhaust the muscular powers of the whole body. The Kamchadales, too, in dancing, imitate bears, dogs and birds. The *Kru* dances of the Coast Negroes represent hunting scenes; and on the Congo, before the hunters start, they go through a dance imitating the habits of the gorilla and its movements when attacked. The Damara dance is a mimic representation of the movements of oxen and sheep, four men stooping with their heads in contact and uttering harsh cries. The canter of the baboon is the humorous part of the ceremony. The Bushmen dance in long irregular jumps, which they compare to the leaping of a herd of calves, and the Hottentots not only go on all-fours to counterfeit the baboon, but they have a dance in which the buzzing of a swarm of bees is represented. The Kennowits in Borneo introduce the mias and the deer for the same purpose. The Australians and Tasmanians in their dances called *corrobories* imitate the frog and the kangaroo (both leaping animals). The hunt of the emu is also performed, a number of men passing slowly round the fire and throwing their arrows about so as to imitate the movements of the animal's head while feeding. The Gonds are fond of dancing the bison hunt, one man with skin and horns taking the part of the animal. Closely allied to these are the mimic fights, almost universal among tribes in which war is one of the great interests of life. The Bravery dance of the Dahomans and the Hoolee of the Bhill tribe in the Vindhya Hills are illustrations. The latter seems to have been reduced to an amusement conducted by professionals who go from village to village,—the battle being engaged in by women with long poles on the one side, and men with short cudgels on the other. There is here an element of comedy, which also appears in the Fiji club-dance. This, although no doubt originally suggested by war, is enlivened by the presence of a clown covered with leaves and wearing a mask. The monotonous song accompanying the club-dance is by way of commentary or explanation. So, also, in Guatemala there is a public *baile* or dance, in which all the performers, wearing the skins and heads of beasts, go through a mock battle, which always ends in the victory of those wearing the deer's head. At the end the victors trace in the sand with a pole the figure of some animal; and this exhibition is supposed to have some historical reference. But nearly all savage tribes have a regular war-dance, in which they appear in fighting costume, handle their weapons, and go through the movements of challenge, conflict, pursuit or defeat. The women generally supply the stimulus of music. There is one very picturesque dance of the Natal Kaffirs, which probably refers to the departure of the warriors for the battle. The women appeal plaintively to the men, who slowly withdraw, stamping on the ground and darting their short spears or *assegais* towards the sky.

In Madagascar, when the men are absent on war, the women dance for a great part of the day, believing that this inspires their husbands with courage. In this, however, there may be some religious significance. These war-dances are totally distinct from the institution of military drill, which belongs to a later period, when social life has become less impulsive and more reflective.<sup>1</sup> There can be little doubt that some of the characteristic movements of these primitive hunting and war-dances survive in the smooth and ceremonious dances of the present day. But the early mimetic dance was not confined to these two subjects; it embraced the other great events of savage life—the drama of courtship and marriage, the funeral dance, the consecration of labour, the celebration of harvest or vintage;<sup>2</sup> sometimes, too, purely fictitious scenes of dramatic interest, while other dances degenerated into games. For instance, in Yucatan one man danced in a cowering attitude round a circle, while another followed, hurling at him *bohordos* or canes, which were adroitly caught on a small stick. Again, in Tasmania, the dances of the women describe their "clamber for the opossum, diving for shell-fish, digging for roots, nursing children and quarrelling with husbands." Another dance, in which a woman by gesture taunts a chieftain with cowardice, gives him an opportunity of coming forward and recounting his courageous deeds in dance. The funeral dance of the Todas (another Indian hill-tribe) consists in walking backwards and forwards, without variation, to a howling tune of "ha! hoo!" The meaning of this is obscure, but it can scarcely be solely an outburst of grief. In Dahomey the blacksmiths, carpenters, hunters, braves and bards, with their various tools and instruments, join in a dramatic dance. We may add here a form of dance which is almost precisely equivalent to the spoken incantation. It is used by the professional devil-dancer of the wild Veddahs for the cure of diseases. An offering of eatables is put on a tripod of sticks, and the dancer, decorated with green leaves, goes into a paroxysm of dancing, in the midst of which he receives the required information. This, however, rather belongs to the subject of religious dances.

It is impossible here to enumerate either the names or the forms of the sacred dances which formed so prominent a part of the worship of antiquity. A mystic philosophy found in them a resemblance to the courses of the stars. This Pythagorean idea was expanded by Sir John Davies, in his epic poem *Orchestra*, published in 1596. They were probably adapted to many purposes,—to thanksgiving, praise, supplication and humiliation. It is only one striking illustration of this widespread practice, that there was at Rome a very ancient order of priests especially named *Salii*, who struck their shields and sang *assamenta* as they danced. The practice reappeared in the early church, special provision being made for dancing in the choir. Scaliger, who astonished Charles V. by his dancing powers, says the bishops were called *Praesules*, because they led the dance on feast days. According to some of the fathers, the angels are always dancing, and the glorious company of the apostles is really a *chorus* of dancers. Dancing, however, fell into discredit with the feast of the *Agapae*. St Augustine says, "Melius est fodere quam saltare"; and the practice was generally prohibited for some time. No church or sect has raged so fiercely against the cardinal sin of dancing as the Albigenses of Languedoc and the Waldenses, who agreed in calling it the devil's procession. After the middle of the 18th century there were still traces of religious dancing in the cathedrals of Spain, Portugal and Roussillon—especially in the Mozarabic Mass of Toledo. An account of the numerous secular dances, public and private, of Greece and Rome will be found in the classical histories, and in J. Weaver's *Essay towards a History of Dancing*, (London, 1712), which, however, must be revised by more recent authorities. The Pyrrhic (derived from the Memphitic) in all its local varieties,

<sup>1</sup> The Greek *kaprala* represented the surprise by robbers of a warrior ploughing a field. The gymnopaedic dances imitated the sterner sports of the palaestra.

<sup>2</sup> The Greek *Lenaea* and *Dionysia* had a distinct reference to the seasons.

the Bacchanalia and the Hymenaea were among the more important. The name of Lycurgus is also associated with the Trichoria. Among the stage dances of the Athenians, which formed interludes to the regular drama, one of the oldest was the Delian dance of the Labyrinth, ascribed to Theseus, and called *Γέπαρος*, from its resemblance to the flight of cranes, and one of the most powerful was the dance of the Eumenides. A further development of the art took place at Rome, under Augustus, when Pylades and Bathyllus brought serious and comic pantomime to great perfection. The subjects chosen were such as the labours of Hercules, and the surprise of Venus and Mars by Vulcan. The state of public feeling on the subject is well shown in Lucian's amusing dialogue *De Saltatione*. Before this Rome had only very inferior buffoons, who attended dinner parties, and whose art traditions belonged not to Greece, but to Etruria.<sup>1</sup> Apparently, however, the Romans, though fond of ceremony and of the theatre, were by temperament not great dancers in private. Cicero says: "Nemo fere saltat sobrius, nisi forte insanit." But the Italic dance of the imperial theatre, supported by music and splendid dresses, supplanted for a time the older dramas. It was the policy of Augustus to cultivate other than political interests for the people; and he passed laws for the protection and privilege of the pantomimists. They were freed from the *jus virgarum*, and they used their freedom against the peace of the city. Tiberius and Domitian oppressed and banished them; Trajan and Aurelius gave them such titles as decurions and priests of Apollo; but the pantomime stage soon yielded to the general corruption of the empire.

*Modern Dancing*.—In modern civilized countries dancing has developed as an art and pastime, as an entertainment. Its direct application to arouse emotion or religious feeling tends to be obscured and finally dropped out.

Italy, in the 15th century, saw the renaissance of dancing, and France may be said to have been the nursery of the modern art, though comparatively few modern dances are really French in origin. The national dances of other countries were brought to France, studied systematically, and made perfect there. An English or a Bohemian dance, practised only amongst peasants, would be taken to France, polished and perfected, and would at last find its way back to its own country, no more recognizable than a piece of elegant cloth when it returns from the printer to the place from which as "grey" material it was sent. The fact that the terminology of dancing is almost entirely French is a sufficient indication of the origin of the rules that govern it. The earliest dances that bear any relation to the modern art are probably the *danses basses* and *danses hautes* of the 16th century. The *danse basse* was the dance of the court of Charles IX. and of good society, the steps being very grave and dignified, not to say solemn, and the accompaniment a psalm tune. The *danses hautes* or *baladines* had a skipping step, and were practised only by clowns and country people. More lively dances, such as the *Gaillarde* and *Volta*, were introduced into France from Italy by Catherine de' Medici, but even in these the interest was chiefly spectacular. Other dances of the same period were the *Branle* (afterwards corrupted to *Braule*, and known in England as the *Brawle*)—a kind of generic dance which was capable of an almost infinite amount of variety. Thus there were imitative dances—*Branles mimés*, such as the *Branles des Ermites*, *Branles des flambeaux*, and the *Branles des lavandières*. The *Branle* in its original form had steps like the *Allemande*. Perhaps the most famous and stately dance of this period was the *Pavane* (of Spanish origin), which is very fully described in Tabouret's *Orchésographie*, the earliest work in which a dance is found minutely described. The *Pavane*, which was really more a procession than a dance, must have been a very gorgeous and noble sight, and it was perfectly suited to the dress of the period, the stiff brocades of the ladies and the swords and heavily-plumed hats of the gentlemen being displayed in its simple and dignified measures to great advantage. The dancers

<sup>1</sup> The Pantomimus was an outgrowth from the *canticum* or choral singing of the older comedies and *fabulae Atellanæ*.

in the time of Henry III. of France usually sang, while performing the *Pavane*, a *chanson*, of which this is one of the verses:

"Approche donc, ma belle,  
Approche-toi, mon bien;  
Ne me sois plus rebelle,  
Puisque mon cœur est tien;  
Pour mon âme apaiser,  
Donne-moi un baiser."

In the *Pavane* and *Branle*, and in nearly all the dances of the 17th and 18th centuries, the practice of kissing formed a not unimportant part, and seems to have added greatly to the popularity of the pastime. Another extremely popular dance was the *Saraband*, which, however, died out after the 17th century. It was originally a Spanish dance, but enjoyed an enormous success for a time in France. Every dance at that time had its own tune or tunes, which were called by its own name, and of the *Saraband* the chevalier de Grammont wrote that "it either charmed or annoyed everyone, for all the guitarists of the court began to learn it, and God only knows the universal twanging that followed." Vauquelin des Yveteaux, in his eightieth year, desired to die to the tune of the *Saraband*, "so that his soul might pass away sweetly." After the *Pavane* came the *Courante*, a court dance performed on tiptoe with slightly jumping steps and many bows and curtsies. The *Courante* is one of the most important of the strictly modern dances. The minuet and the waltz were both in some degree derived from it, and it had much in common with the famous *Seguidilla* of Spain. It was a favourite dance of Louis XIV., who was an adept in the art, and it was regarded in his time as of such importance that a nobleman's education could hardly have been said to be begun until he had mastered the *Courante*.

The dance which the French brought to the greatest perfection—which many, indeed, regard as the fine flower of the art—was the *Minuet*. Its origin, as a rustic dance, is not less antique than that of the other dances from which the modern art has been evolved. It was originally a *branle* of Poitou, derived from the *Courante*. It came to Paris in 1650, and was first set to music by Lully. It was at first a gay and lively dance, but on being brought to court it soon lost its sportive character and became grave and dignified. It is mentioned by Beauchamps, the father of dancing-masters, who flourished in Louis XIV.'s reign, and also by Blondy, his pupil; but it was Pécour who really gave the minuet its popularity, and although it was improved and made perfect by Dauberval, Gardel, Marcel and Vestris, it was in Louis XV.'s reign that it saw its golden age. It was then a dance for two in moderate triple time, and was generally followed by the *gavotte*. Afterwards the minuet was considerably developed, and with the *gavotte* became chiefly a stage dance and a means of display; but it should be remembered that the minuets which are now danced on the stage are generally highly elaborated with a view to their spectacular effect, and have imported into them steps and figures which do not belong to the minuet at all, but are borrowed from all kinds of other dances. The original court minuet was a grave and simple dance, although it did not retain its simplicity for long. But when it became elaborated it was glorified and moulded into a perfect expression of an age in which deportment was most sedulously cultivated and most brilliantly polished. The "languishing eye and smiling mouth" had their due effect in the minuet; it was a school for chivalry, courtesy and ceremony; the hundred slow graceful movements and curtsies, the pauses which had to be filled by neatly-turned compliments, the beauty and bravery of attire—all were eloquent of graces and outward refinements which we cannot boast now. The fact that the measure of the minuet has become incorporated in the structure of the symphony shows how important was its place in the polite world. The *Gavotte*, which was often danced as a pendant to the minuet, was also originally a peasant's dance, a *danse des Gavots*, and consisted chiefly of kissing and capering. It also became stiff and artificial, and in the later and more prudish half of the 18th century the ladies received bouquets instead of kisses in dancing the *gavotte*. It rapidly became a stage dance, and it has never been restored to the ballroom. Grétry attempted

to revive it, but his arrangement never became popular. Other dances which were naturalized in France were the *Écossaise*, popular in 1760; the *Cotillon*, fashionable under Charles X., derived from the peasant *branles* and danced by ladies in short skirts; the *Galop*, imported from Germany; the *Lancers*, invented by Laborde in 1836; the *Polka*, brought by a dancing-master from Prague in 1840; the *Schottische*, also Bohemian, first introduced in 1844; the *Bourrée*, or French clog-dance; the *Quadrille*, known in the 18th century as the *Contre-danse*; and the *Waltz*, which was danced as a *volte* by Henry III. of France, but only became popular in the beginning of the 19th century. We shall return to the history of some of these later dances in discussing the dances at present in use.

If France has been the nursery and school of the art of dancing, Spain is its true home. There it is part of the national life, the inevitable expression of the gay, contented, irresponsible, sun-burnt nature of the people. The form of Spanish dances has hardly changed; some of them are of great antiquity, and may be traced back with hardly a break to the performances in ancient Rome of the famous dancing-girls of Cadiz. The connexion is lost during the period of the Arab invasion, but the art was not neglected, and Jovellanos suggests that it took refuge in the Asturias. At any rate, dances of the 10th and 12th centuries have been preserved uncorrupted. The earliest dances known were the *Turdion*, the *Gibidana*, the *Pié-de-gibao*, and (later) the *Madama Orleans*, the *Alemana* and the *Pavana*. Under Philip IV. theatrical dancing was in high popularity, and ballets were organized with extraordinary magnificence of decoration and costume. They supplanted the national dances, and the *Zarabanda* and *Chacona* were practically extinct in the 18th century. It is at this period that the famous modern Spanish dances, the *Bolero*, *Seguidilla* and the *Fandango*, first appear. Of these the *Fandango* is the most important. It is danced by two people in 6-8 time, beginning slowly and tenderly, the rhythm marked by the click of castanets, the snapping of the fingers and the stamping of feet, and the speed gradually increasing until a whirl of exaltation is reached. A feature of the *Fandango* and also of the *Seguidilla* is a sudden pause of the music towards the end of each measure, upon which the dancers stand rigid in the attitudes in which the stopping of the music found them, and only move again when the music is resumed. M. Vuillier, in his *History of Dancing*, gives the following description of the *Fandango*:—"Like an electric shock, the notes of the *Fandango* animate all hearts. Men and women, young and old, acknowledge the power of this air over the ears and soul of every Spaniard. The young men spring to their places, rattling castanets or imitating their sound by snapping their fingers. The girls are remarkable for the willowy languor and lightness of their movements, the voluptuousness of their attitudes—beating the exactest time with tapping heels. Partners tease and entreat and pursue each other by turns. Suddenly the music stops, and each dancer shows his skill by remaining absolutely motionless, bounding again into the full life of the *Fandango* as the orchestra strikes up. The sound of the guitar, the violin, the rapid tic-tac of heels (*taconeos*), the crack of fingers and castanets, the supple swaying of the dancers, fill the spectator with ecstasy. The measure whirls along in a rapid triple time. Spangles glitter; the sharp clank of ivory and ebony castanets beats out the cadence of strange, throbbing, deepening notes—assonances unknown to music, but curiously characteristic, effective and intoxicating. Amidst the rustle of silks, smiles gleam over white teeth, dark eyes sparkle and droop and flash up again in flame. All is flutter and glitter, grace and animation—quivering, sonorous, passionate, seductive."

The *Bolero* is a comparatively modern dance, having been invented by Sebastian Cerezo, a celebrated dancer of the time of King Charles III. It is remarkable for the free use made in it of the arms, and is said to be derived from the ancient *Zarabanda*, a violent and licentious dance, which has entirely disappeared, and with which the later *Saraband* has practically nothing in common. The step of the *Bolero* is low and gliding but well marked. It is danced by one or more couples. The *Seguidilla* is

hardly less ancient than the *Fandango*, which it resembles. Every province in Spain has its own *Seguidilla*, and the dance is accompanied by *coplas*, or verses, which are sung either to traditional melodies or to the tunes of local composers; indeed, the national music of Spain consists largely of these *coplas*. Baron Davillier, among several specimens of *Seguidilla*, gives this one

" Mi corazon volando  
Se fué á tu pecho;  
Le cortaste las alas,  
Y quédo dentro.  
Por atrevido  
Se quedará por siempre  
En el metido."<sup>1</sup>

M. Vuillier quotes a *copla* which he heard at Polenza, in the Balearic Islands. This verse is formed on the rhythm of the *Malagueña*:

" Una estrella se ha perdida  
En el ciel y no parece;  
En tu cara se ha metido;  
Y en tu frente resplandece."<sup>2</sup>

The *Jota* is the national dance of Aragon, a lively and splendid, but withal dignified and reticent, dance derived from the 16th-century *Passacaille*. It is still used as a religious dance. The *Cachuca* is a light and graceful dance in triple time. It is performed by a single dancer of either sex. The head and shoulders play an important part in the movements of this dance. Other provincial dances now in existence are the *Jaleo de Jerez*, a whirling measure performed by gipsies, the *Palotía*, the *Polo*, the *Gallegada*, the *Muyneria*, the *Habas Verdes*, the *Zapateado*, the *Zorongo*, the *Vito*, the *Tirano* and the *Tripola* *Trapola*. Most of these dances are named either after the places where they are danced or after the composers who have invented tunes for them. Many of them are but slight variations from the *Fandango* and *Seguidilla*.

The history of court dancing in Great Britain is practically the same as that of France, and need not occupy much of our attention here. But there are strictly national dances still in existence which are quite peculiar to the country, and may be traced back to the dances and games of the Saxon gleemen. The *Egg* dance and the *Carole* were both Saxon dances, the *Carole* being a Yule-tide festivity, of which the present-day Christmas carol is a remnant. The oldest dances which remain unchanged in England are the *Morris* dances, which were introduced in the time of Edward III. The name *Morris* or *Moorish* refers to the origin of these dances, which are said to have been brought back by John of Gaunt from his travels in Spain. The *Morris* dances are associated with May-day, and are danced round a maypole to a lively and capering step, some of the performers having bells fastened to their knees in the *Moorish* manner. They are dressed as characters of old English tradition, such as Robin Hood, Maid Marian, Friar Tuck, Little John and Tom the Piper. All the true country dances of Great Britain are of an active and lively measure; they may all, indeed, be said to be founded on the jig; and the hornpipe, which is a kind of jig, is the national dance of England. Captain Cook, on his voyages, made his sailors dance hornpipes in calm weather to keep them in good health. A characteristic of English dances was that they partook to a great extent of the nature of games; there was little variety in the steps, which were nearly all those of the jig or hornpipe, but these were incorporated into various games or plays, of which the *Morris* dances were the most elaborate. Richard Baxter wrote that "sometimes the *Morris* dancers would come into the church in all their linen and scarves and antic dresses, with *Morris* bells jingling at their legs; and as soon as Common Prayer was read, did haste and presently to their play again." May-day has always been celebrated in England with rustic dances and festivities. Before the Reformation there were no

<sup>1</sup> " My heart flew to thy breast. Thou didst cut its wings, so that it remained there. And now it has waxed daring, and will stay with thee for evermore."

<sup>2</sup> " A star is lost and appears not in the sky; in thy face it has set itself; on thy brow it shines."



really national dances in use at court; but in the reign of Elizabeth the homely, domestic style of dancing reached the height of its popularity. Remnants of many of these dances remain to-day in the games played by children and country people; " Hunt the Slipper," " Kiss in the Ring," " Here we go round the Mulberry Bush," are examples. All the Tudor dances were kissing dances, and must have been the occasion of a great deal of merriment. Mrs Groves gives the following description of the Cushion dance:—" The dance is begun by a single person, man or woman, who, taking a cushion in hand, dances about the room, and at the end of a short time stops and sings: ' This dance it will no farther go,' to which the musician answers: ' I pray you, good sir, why say so?' ' Because Joan Sanderson will not come to.' ' She must come to whether she will or no,' returns the musician, and then the dancer lays the cushion before a woman; she kneels and he kisses her, singing ' Welcome, Joan Sanderson.' Then she rises, takes up the cushion, and both dance and sing ' Prinkum prankum is a fine dance, and shall we go dance it over again?' Afterwards the woman takes the cushion and does as the man did." Other popular dances—generally adapted to the tunes of popular songs, the nature of some of which may be guessed from their titles—were the Trenchmore, Omnium-gatherum, Tolly-polly, Hoite cum toite, Dull Sir John, Faine I would, Sillinger, All in a Garden Green, An Old Man's a Bed Full of Bones, If All the World were Paper, John, Come Kiss Me Now, Cuckholds All Awry, Green Sleeves and Pudding Pies, Lumps of Pudding, Under and Over, Up Tails All, The Slaughter House, Rub her Down with Straw, Have at thy Coat Old Woman, The Happy Marriage, Dissembling Love, Sweet Kate, Once I Loved a Maiden Fair. Dancing practically disappeared during the Puritan régime, but with the Restoration it again became popular. It underwent no considerable developments, however, until the reign of Queen Anne, when the glories of Bath were revived in the beginning of the 18th century, and Beau Nash drew up his famous codes of rules for the regulation of dress and manners, and founded the balls in which the polite French dances completely eclipsed the simpler English ones. An account of a dancing lesson witnessed by a fond parent at this time is worth quoting, as it shows how far the writer (but not his daughter) had departed from the jolly, romping traditions of the old English dances:—" As the best institutions are liable to corruption, so, sir, I must acquaint you that very great abuses are crept into this entertainment. I was amazed to see my girl handed by and handing young fellows with so much familiarity, and I could not have thought it had been my child. They very often made use of a most impudent and lascivious step called *setting* to partners, which I know not how to describe to you but by telling you that it is the very reverse of *back to back*. At last an impudent young dog bid the fiddlers play a dance called *Moll Patley*, and, after having made two or three capers, ran to his partner, locked his arms in hers, and whisked her round cleverly above ground in such a manner that I, who sat upon one of the lowest benches, saw farther above her shoe than I can think fit to acquaint you with. I could no longer endure these enormities, wherefore, just as my girl was going to be made a whirligig, I ran in, seized my child and carried her home." What we may call polite dancing, when it became fashionable, soon invaded London, its first home being Madame Cornely's famous Carlisle House in Soho Square. Ranelagh and Vauxhall and Almack's were all extensively patronized, and the rage for magnificent entertainment and dancing culminated in the erection of the palatial Pantheon in Oxford Street—a place so universally patronized that even Dr Johnson was to be found there. White's and Boodle's were also famous assembly rooms, but the most exclusive of all these establishments was Almack's, the original of Brooks's Club.

The only true national dances of Scotland are reels, strathspeys and flings, while in Ireland there is but one dance—the jig, which is there, however, found in many varieties and expressive of many shades of emotion, from the maddest gaiety to the wildest lament. Curiously enough, although the Welsh dance often, they have no strictly national dances.

Dancing in present-day society is a comparatively simple affair, as five-sixths of almost all ball programmes consists of waltzes. The origin of the waltz is a much-debated subject, the French, Italians and Bavarians each claiming for their respective countries the honour of having given birth to it. As a matter of fact the waltz, as it is now danced, comes from Germany; but it is equally true that its real origin is French, since it is a development of the *Volte*, which in its turn came from the *Lavolta* of Provence, one of the most ancient of French dances. The *Lavolta* was fashionable in the 16th century and was the delight of the Valois court. The *Volte* danced by Henry III. was really a *Valse à deux pas*; and Castil-Blaze says that " the waltz which we took again from the Germans in 1795 had been a French dance for four hundred years." The change, it is true, came upon it during its visit to Germany, hence the theory of its German origin. The first German waltz tune is dated 1770—" Ach! du lieber Augustin." It was first danced at the Paris opera in 1793, in Gardel's ballet *La Dansomanie*. It was introduced to English ballrooms in 1812, when it roused a storm of ridicule and opposition, but it became popular when danced at Almack's by the emperor Alexander in 1816. The waltz *à trois temps* has a sliding step in which the movements of the knees play an important part. The *tempo* is moderate, so as to allow three distinct movements on the three beats of each bar; and the waltz is written in 3-4 time and in eight-bar sentences. Walking up and down the room and occasionally breaking into the step of the dance is not true waltzing, and the habit of pushing one's partner backwards along the room is an entirely English one. But the dancer must be able to waltz equally well in all directions, pivoting and crossing the feet when necessary in the reverse turn. It need hardly be said that the feet should never leave the floor in the true waltz. Gungl, Waldteufel and the Strauss family may be said to have moulded the modern waltz to its present form by their rhythmical and agreeable compositions. There are variations which include hopping and lurching steps; these are degradations, and foreign to the spirit of the true waltz.

The *Quadrille* is of some antiquity, and a dance of this kind was first brought to England from Normandy by William the Conqueror, and was common all over Europe in the 16th and 17th centuries. The term quadrille means a kind of card game, and the dance is supposed to be in some way connected with the game. A species of quadrille appeared in a French ballet in 1745, and since that time the dance has gone by that name. Like many other dances, it came from Paris to Almack's in 1815, and in its modern form was danced in England for the first time by Lady Jersey, Lady Harriet Butler, Lady Susan Ryder and Miss Montgomery, with Count Aldegarde, Mr Montgomery, Mr Harley and Mr Montague. It immediately became popular. It then consisted of very elaborate steps, which in England have been simplified until the degenerate practice has become common of walking through the dance. The quadrille, properly danced, has many of the graces of the minuet. It is often stated that the square dance is of modern French origin. This is incorrect, and probably arises from a mistaken identification of the terms quadrille and square dance. " Dull Sir John " and " Faine I would " were square dances popular in England three hundred years ago.

An account of the country-dance, with the names of some of the old dance-tunes, has been given above. The word is not, as has been supposed, an adaptation of the French *contre-danse*, neither is the dance itself French in origin. According to the *New English Dictionary*, *contre-danse* is a corruption of " country-dance," possibly due to a peculiar feature of many of such dances, like Sir Roger de Coverley, where the partners are drawn up in lines opposite to each other. The earliest appearance of the French word is in its application to English dances, which are contrasted with the French; thus in the *Memoirs of Grammont*, Hamilton says: " On quitta les danses françaises pour se mettre aux contre-danses." The English " country-dances " were introduced into France in the early part of the 18th century and became popular; later French modifications were brought back

to England under the French form of the name, and this, no doubt, caused the long-accepted but confused derivation.

The *Lancers* were invented by Laborde in Paris in 1836. They were brought over to England in 1850, and were made fashionable by Madame Sacré at her classes in Hanover Square Rooms. The first four ladies to dance the lancers in England were Lady Georgina Lygon, Lady Jane Fielding, Mdlle. Olga de Lechner and Miss Berkeley.

The *Polka*, the chief of the Bohemian national dances, was adopted by Society in 1835 at Prague. Josef Neruda had seen a peasant girl dancing and singing the polka, and had noted down the tune and the steps. From Prague it readily spread to Vienna, and was introduced to Paris by Cellarius, a dancing-master, who gave it at the Odéon in 1840. It took the public by storm, and spread like an infection through England and America. Everything was named after the polka, from public-houses to articles of dress. Mr Punch exerted his wit on the subject weekly, and even *The Times* complained that its French correspondence was interrupted, since the polka had taken the place of politics in Paris. The true polka has three slightly jumping steps, danced on the first three beats of a four-quaver bar, the last beat of which is employed as a rest while the toe of the unemployed foot is drawn up against the heel of the other.

The *Galop* is strictly speaking a Hungarian dance, which became popular in Paris in 1830. But some kind of a dance corresponding to the galop was always indulged in after *Voltes* and *Contre-danses*, as a relief from their grave and constrained measures.

The *Washington Post* and several varieties of *Barn-dance* are of American origin, and became fashionable towards the end of the 19th century.

The *Polka-Mazurka* is extremely popular in Vienna and Budapest, and is a favourite theme with Hungarian composers. Their movements of this dance occupy two bars of 3-4 time, and consist of a mazurka step joined to the polka. It is of Polish origin.

The *Polonaise* and *Mazurka* are both Polish dances, and are still fashionable in Russia and Poland. Every State ball in Russia is opened with the ceremonious Polonaise.

The *Schottische*, a kind of modified polka, was "created" by Markowski, who was the proprietor of a famous dancing academy in 1850. The *Highland Schottische* is a fling. The Fling and Reel are Celtic dances, and form the national dances of Scotland and Denmark. They are complicated measures of a studied and classical order, in which free use is made of the arms and of cries and stampings. The *Strathspey* is a slow and grandiose modification of the Reel.

*Sir Roger de Coverley* is the only one of the old English social dances which has survived to the present day, and it is frequently danced at the conclusion of the less formal sort of balls. It is a merry and lively game in which all the company take part, men and women facing each other in two long rows. The dancers are constantly changing places in such a way that if the dance is carried to its conclusion everyone will have danced with everyone else. The music was first printed in 1685, and is sometimes written in 2-4 time, sometimes in 6-8 time, and sometimes in 3-9 time.

The *Cotillon* is a modern development of the French dance of the same name referred to above. It is an extremely elaborate dance, in which a great many toys and accessories are employed; hundreds of figures may be contrived for it, in which presents, toys, lighted tapers, biscuits, air-balloons and hurdles are used.

*Ballet, &c.*—The modern ballet (*q.v.*) seems to have been first produced on a considerable scale in 1489 at Tortona, before Duke Galeazzo of Milan. It soon became a common amusement on great occasions at the European courts. The ordinary length was five acts, each containing several *entrées*, and each *entrée* containing several quadrilles. The accessories of painting, sculpture and movable scenery were employed, and the representation often took place at night. The allegorical, moral and ludicrous ballets were introduced to France by Baif in the time of Catherine de' Medici. The complex nature of these exhibitions may be gathered from the title of one played at Turin in 1634—

*La verità nemica della apparenza, sollevata dal tempo.* Of the ludicrous, one of the best known was the Venetian ballet of *La verità raminga*. Now and then, however, a high political aim may be discovered, as in the "Prosperity of the Arms of France," danced before Richelieu in 1641, or "Religion uniting Great Britain to the rest of the World," danced at London on the marriage of Princess Elizabeth to the elector Frederick. Outside the theatre, the Portuguese revived an ambulatory ballet which was played on the canonization of Carlo Borromeo, and to which they gave the name of the Tyrrhenic Pomp. During this time also the ceremonial ball (with all its elaborate detail of *courante*, minuet and saraband) was cultivated. The fathers of the church assembled at Trent gave a ball in which they took a part. Masked balls, too, resembling in some respects the Roman Saturnalia, became common towards the end of the 17th century. In France a ball was sometimes diversified by a masquerade, carried on by a limited number of persons in character-costume. Two of the most famous were named "au Sauvage" and "des Sorciers." In 1715 the regent of France started a system of public balls in the opera-house, which did not succeed. Dancing, also, formed a leading element in the Opéra Français introduced by Quinault. His subjects were chiefly marvellous, drawn from the classical mythologies; and the choral dancing was not merely *divertissement*, but was intended to assist and enrich the dramatic action of the whole piece.

*Musical Gymnastics.*—Dancing is an important branch of physical education. Long ago Locke pointed out (*Education*, §§ 67, 196) that the effects of dancing are not confined to the body; it gives to children, he says, not mere outward gracefulness of motion, but manly thoughts and a becoming confidence. Only lately, however, has the advantage been recognized of making gymnastics attractive by connecting it with what Homer calls "the sweetest and most perfect of human enjoyments." The practical principle against heavy weights and intense monotonous exertion of particular muscles was thus stated by Samuel Smiles (*Physical Education*, p. 148):—"The greatest benefit is derived from that exercise which calls into action the greatest number of muscles, and in which the action of these is intermitted at the shortest intervals." It required only one further step to see how, if light and changing movements were desirable, music would prove a powerful stimulus to gymnastics. It touches the play-impulse, and substitutes a spontaneous flow of energy for the mechanical effort of the will. The force of imitation or contagion, one of the most valuable forces in education, is also much increased by the state of exhilaration into which dancing puts the system. This idea was embodied by Froebel in his *Kindergarten* plan, and was developed by Jahn and Schreber in Germany, by Dio Lewis in the United States, and by Ling (the author of the *Swedish Cure Movement*) in Sweden.

*AUTHORITIES.*—For the old division of the *Ars Gymnastica* into *palaestrica* and *saltatoria*, and of the latter into *cubistica*, *sphaeristica* and *orchestica*, see the learned work of Hieronymus Mercurialis, *De arte Gymnastica* (Amsterdam, 1572). Cubistic was the art of throwing somersaults, and is described minutely by Tuccaro in his *Trois Dialogues* (Paris, 1599). Sphaeristic included several complex games at ball and tilting—the Greek *κρόνος*, and the Roman *trigonalis* and *pagonica*. Orchestic, divided by Plutarch into *latio*, *figura* and *indicatio*, was really imitative dancing, the "silent poetry" of Simonides. The importance of the *χειρονομία* or hand-movement is indicated by Ovid:—"Si vox est, canta; si mollia brachia, salta." For further information as to modern dancing, see Rameau's *Le maître à danser* (1726); Querlon's *Le triomphe des grâces* (1774); Cahousac, *La danse ancienne et moderne* (1754); Vuillier, *History of Dancing* (Eng. trans., 1897); Giraudet, *Traité de la danse* (1900).

(W. C. S.; A. B. F. Y.)

**DANCOURT, FLORENT CARTON** (1661-1725), French dramatist and actor, was born at Fontainebleau on the 1st of November 1661. He belonged to a family of rank, and his parents entrusted his education to Père de la Rue, a Jesuit, who made earnest efforts to induce him to join the order. But he had no religious vocation and proceeded to study law. He practised at the bar for some time, but his marriage to the daughter of the comedian François Lenoir de la Thorillière led him to become an actor, and in 1685, in spite of the strong opposition of his family, he

appeared at the Théâtre Français. His gifts as a comedian gave him immediate and marked success, both with the public and with his fellow actors. He was the spokesman of his company on occasions of state, and in this capacity he frequently appeared before Louis XIV., who treated him with great favour. One of his most famous impersonations was Alceste in the *Misanthrope* of Molière. His first play, *Le Notaire obligeant*, produced in 1685, was well received. *La Désolation des joueuses* (1687) was still more successful. *Le Chevalier à la mode* (1687) is generally regarded as his best work, though his claim to original authorship in this and some other cases has been disputed. In *Le Chevalier à la mode* appears the *bourgeoise* infatuated with the desire to be an aristocrat. The type is developed in *Les Bourgeoises à la mode* (1692) and *Les Bourgeoises de qualité* (1700). Dancourt was a prolific author, and produced some sixty plays in all. Some years before his death he terminated his career both as an actor and as an author by retiring to his château at Courcelles le Roi, in Berry, where he employed himself in making a poetical translation of the Psalms and in writing a sacred tragedy. He died on the 7th of December 1725. The plays of Dancourt are faithful descriptions of the manners of the time, and as such have real historical value. The characters are drawn with a realistic touch that led to his being styled by Charles Palissot the Teniers of comedy. He is very successful in his delineation of low life, and especially of the peasantry. The dialogue is sparkling, witty and natural. Many of the incidents of his plots were derived from actual occurrences in the "fast" and scandalous life of the period, and several of his characters were drawn from well-known personages of the day. Most of the plays incline to the type of farce rather than of pure comedy. Voltaire defined his talent in the words: "Ce que Regnard était à l'égard de Molière dans la haute comédie, le comédien Dancourt l'était dans la farce."

His two daughters, Manon and Marie Anne (Mimi), both obtained success on the stage of the Théâtre Français.

The complete works of Dancourt were published in 1760 (12 vols. 12mo). An edition of his *Théâtre choisi*, with a preface by F. Sarcey, appeared in 1884.

**DANDELION** (*Taraxacum officinale*), a perennial herb belonging to the natural order Compositae. The plant has a wide range, being found in Europe, Central Asia, North America, and the Arctic regions, and also in the south temperate zone. The leaves form a spreading rosette on the very short stem; they are smooth, of a bright shining green, sessile, and tapering downwards. The name dandelion is derived from the French *dent-de-lion*, an appellation given on account of the tooth-like lobes of the leaves. The long tap-root has a simple or many-headed rhizome; it is black externally, and is very difficult of extirpation. The flower-stalks are smooth, brittle, leafless, hollow, and very numerous. The flowers bloom from April till August, and remain open from five or six in the morning to eight or nine at night. The flower-heads are of a golden yellow, and reach 1½ to 2 in. in width; the florets are all strap-shaped. The fruits are olive or dull yellow in colour, and are each surmounted by a long beak, on which rests a pappus of delicate white hairs, which occasions the ready dispersal of the fruit by the wind; each fruit contains one seed. The globes formed by the plumed fruits are nearly two inches in diameter. The involucre consists of an outer spreading (or reflexed) and an inner and erect row of bracts. In all parts of the plant a milky juice is contained, which has a somewhat complex composition. The chief constituent is taraxacin, a neutral principle. In addition the juice contains taraxacerin (derived from the former), asparagin, inulin, resins and salts. An extract (dose 5-15 grains), a liquid extract (dose ½-1 drachm) and a succus (dose 1-2 drachms) of the root are all used medicinally. For the purposes formerly recognized taraxacum is now never used, but it has been shown to possess definite cholagogue properties, and may therefore be prescribed along with ammonium chloride in cases of hepatic constipation, which it very constantly relieves. The root—which is the medicinal product—is most bitter from March to July, but the milky juice it contains is less abundant in the summer than in the autumn,

For this reason, the extract and succus are usually prepared during the months of September and October. After a frost a change takes place in the root, which loses its bitterness to a

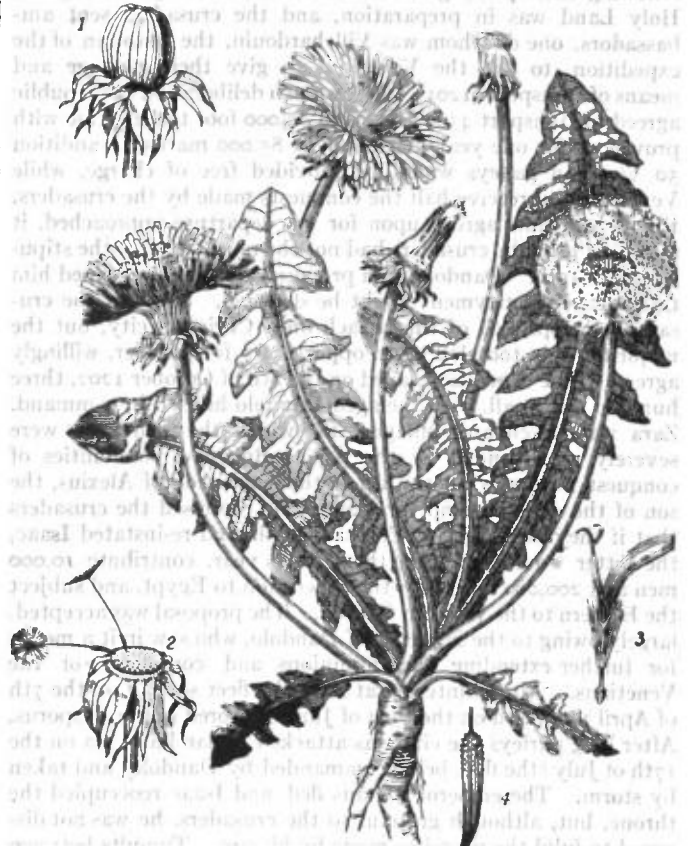

Dandelion (*Taraxacum officinale*).

1, Unopened head, ¾ natural size; 2, ripe head from which all the fruits except two have been removed, ¾ natural size; 3, one floret, enlarged; 4, one fruit, magnified four times.

large extent. In the dried state the root will not keep well, being quickly attacked by insects. Externally it is brown and wrinkled, internally white, with a yellow centre and concentric paler rings. It is two inches to a foot long, and about a quarter to half an inch in diameter. The leaves are bitter, but are sometimes eaten as a salad; they serve as food for silkworms when mulberry leaves are not to be had. The root is roasted as a substitute for coffee. Several varieties of the dandelion are recognized by botanists; they differ in the degree and mode of cutting of the leaf-margin and the erect or spreading character of the outer series of bracts. The variety *palustre*, which affects boggy situations, and flowers in late summer and autumn, has nearly entire leaves, and the outer bracts of its involucre are erect.

**DANDOLO**, the name of one of the most illustrious patrician families of Venice, of which the earliest recorded member was one of the electors of the first doge (A.D. 697). The Dandolo gave to Venice four doges; of these the first and most famous was Enrico Dandolo (c. 1120-1205), elected on the 1st of January 1193 (*more Veneto*, 1192). He had distinguished himself in various military enterprises and diplomatic negotiations in the course of an active career, and although over seventy years old and of very weak sight (the story that he had been made blind by the emperor Manuel Comnenus while he was at Constantinople is a legend), he proved a most energetic and capable ruler. His first care was to re-establish Venetian authority over the Dalmatians who had rebelled with the king of Hungary's protection, but he failed to capture Zara, owing to the arrival of the Pisan fleet, and although the latter was defeated by the Venetians, the undertaking was suspended. In the meanwhile the situation in the East was becoming critical. The Eastern emperor Isaac II. Angelus had been deposed, imprisoned, and blinded by his

brother Alexius, who usurped the throne. The new emperor proved unfriendly to the Venetians and made difficulties about renewing their privileges. In the West a new crusade to the Holy Land was in preparation, and the crusaders sent ambassadors, one of whom was Villehardouin, the historian of the expedition, to ask the Venetians to give them passage and means of transport (1201). After much deliberation the republic agreed to transport 4500 horse and 29,000 foot to Palestine with provisions for one year, for a sum of 85,000 marks; in addition 50 Venetian galleys would be provided free of charge, while Venice was to receive half the conquests made by the crusaders. But as the time agreed upon for the departure approached, it appeared that the crusaders had not the money to pay the stipulated advance. Dandolo then proposed that if they helped him to reduce Zara payment might be deferred. Some of the crusaders disapproved of this attack on a Christian city, but the majority, only too glad of an opportunity for plunder, willingly agreed. The expedition sailed on the 8th of October 1202, three hundred sail in all, with the aged Dandolo himself in command. Zara was taken and pillaged, for which the Venetians were severely reprimanded by the pope. But new possibilities of conquest were now opened up at the suggestion of Alexius, the son of the deposed emperor Isaac. He promised the crusaders that if they went first to Constantinople and re-instated Isaac, the latter would maintain them for a year, contribute 10,000 men and 200,000 marks for the expedition to Egypt, and subject the Eastern to the Western Church. The proposal was accepted, largely owing to the influence of Dandolo, who saw in it a means for further extending the dominions and commerce of the Venetians. After wintering at Zara the fleet set sail on the 7th of April 1203, and on the 23rd of June anchored in the Bosphorus. After long parleys the city was attacked by land and sea on the 17th of July (the fleet being commanded by Dandolo) and taken by storm. The emperor Alexius fled, and Isaac reoccupied the throne, but, although grateful to the crusaders, he was not disposed to fulfil the promises made by his son. Tumults between crusaders and Greeks arose, and the people of the city, excited by a certain Alexis Murzuphlus, murmured at the new taxes which were imposed on them. A revolt broke out, and an officer named Nicholas Canabus was placed on the throne; Prince Alexius was strangled by order of Murzuphlus, Isaac died of the shock, Murzuphlus imprisoned Canabus and made himself emperor (Alexius V.). The crusaders thereupon attacked Constantinople a second time (12th of April 1204), and after a desperate struggle captured the city, which they subjected to hideous carnage. Immense booty was secured, the Venetians obtaining among other treasures the four bronze horses which adorn the façade of St Mark's. The Eastern empire was abolished, and a feudal Latin empire erected in its stead. The leaders of the crusaders then met to elect an emperor. Dandolo was one of the candidates, but Count Baldwin of Flanders was elected and crowned on the 23rd of May. The Venetians were given Crete and several other islands and ports in the Levant, which formed an uninterrupted chain from Venice to the Black Sea, a large part of Constantinople (whence the doge assumed the title of "lord of a quarter and a half of Romania"), and many valuable privileges. But hardly had the new state been established when various provinces rose in rebellion and the Bulgarians invaded Thrace. A Latin army was defeated by them at Adrianople (April 1205), and the emperor himself was captured and killed, the fragments of the force being saved only by Dandolo's prowess. But he was now old and ill, and on the 23rd of June 1205 he died. He certainly consolidated Venice's dominion in the East and increased its commercial prosperity to a very high degree. But the policy he pursued in turning the crusaders against Constantinople, in order to promote the interests of the republic, while serving to break up the Greek empire, created in its place a Latin state that was far too feeble to withstand the onslaught of Greek national feeling and Orthodox fanaticism; at the same time the Greeks were greatly weakened and their power of resisting the Turks consequently lessened. This paved the way for the Turkish invasion of

Europe, which proved an unmixed calamity for all Christendom, Venice included.

Enrico Dandolo's sons distinguished themselves in the public service, and his grandson Giovanni was doge from 1280 to 1289. The latter's son Andrea commanded the Venetian fleet in the war against Genoa in 1294, and, having been defeated and taken prisoner, he was so overwhelmed with shame that he committed suicide by beating his head against the mast (according to Andrea Navagero). Francesco Dandolo, also known as Dandolo Cane, was doge from 1329 to 1339. During his reign the Venetians went to war with Martino della Scala, lord of Verona, with the result that they occupied Treviso and otherwise extended their possessions on the *terra firma*. Andrea Dandolo (1307/10-1354), the last doge of the family, reigned from 1343 to 1354. He had been the first Venetian noble to take a degree at the university of Padua, where he had also been professor of jurisprudence. The terrible plague of 1348, wars with Genoa, against whom the great naval victory of Lojera was won in 1353, many treaties, and the subjugation of the seventh revolt of Zara, are the chief events of his reign. The poet Petrarch, who was the doge's intimate friend, was sent to Venice on a peace mission by Giovanni Visconti, lord of Milan. "Just, incorruptible, full of zeal and of love for his country, and at the same time learned, of rare eloquence, wise, affable, and humane," is the poet's verdict on Andrea Dandolo (*Varior. epist.* xix.). Dandolo died on the 7th of September 1354. He is chiefly famous as a historian, and his *Annals* to the year 1280 are one of the chief sources of Venetian history for that period; they have been published by Muratori (*Rer. Ital. Script.* tom. xxi.). He also had a new code of laws compiled (issued in 1346) in addition to the statute of Jacopo Tiepolo.

Another well-known member of this family was Silvestro Dandolo (1796-1866), son of Girolamo Dandolo, who was the last admiral of the Venetian republic and died an Austrian admiral in 1847. Silvestro was an Italian patriot and took part in the revolution of 1848.

BIBLIOGRAPHY.—S. Romanin, *Storia documentata di Venezia* (Venice, 1853); among more recent books H. Kretschmayr's excellent *Geschichte von Venedig* (Gotha, 1905) should be consulted: it contains a bibliography of the authorities and all the latest researches and discoveries; C. Cipolla and G. Monticolo have published many essays and editions of chronicles in the *Archivio Veneto*, and the "Fonti per la Storia d'Italia," in the *Istituto storico italiano*; H. Simonsfeld has written a life of *Andrea Dandolo* in German (Munich, 1876). (L. V.)\*

**DANDOLO, VINCENZO**, COUNT (1758-1819), Italian chemist and agriculturist, was born at Venice, of good family, though not of the same house as the famous doges, and began his career as a physician. He was a prominent opponent of the oligarchical party in the revolution which took place on the approach of Napoleon; and he was one of the envoys sent to seek the protection of the French. When the request was refused, and Venice was placed under Austria, he removed to Milan, where he was made member of the great council. In 1799, on the invasion of the Russians and the overthrow of the Cisalpine republic, Dandolo retired to Paris, where, in the same year, he published his treatise *Les Hommes nouveaux, ou moyen d'opérer une régénération nouvelle*. But he soon after returned to the neighbourhood of Milan, to devote himself to scientific agriculture. In 1805 Napoleon made him governor of Dalmatia, with the title of *providiteur général*, in which position Dandolo distinguished himself by his efforts to remove the wretchedness and idleness of the people, and to improve the country by draining the pestilential marshes and introducing better methods of agriculture. When, in 1809, Dalmatia was re-annexed to the Illyrian provinces, Dandolo returned to Venice, having received as his reward from the French emperor the title of count and several other distinctions. He died in his native city on the 13th of December 1819.

Dandolo published in Italian several treatises on agriculture, vine-cultivation, and the rearing of cattle and sheep; a work on silk-worms, which was translated into French by Fontanelle; a work on the discoveries in chemistry which were made in the last

quarter of the 18th century (published 1796); and translations of several of the best French works on chemistry.

**DANDY**, a word of uncertain origin which about 1813-1816 became a London colloquialism for the exquisite or fop of the period. It seems to have been in use on the Scottish border at the end of the 18th century, its full form, it is suggested, being "Jack-a-Dandy," which from 1659 had a sense much like its later one. It is probably ultimately derived from the French *dandin*, "a ninny or booby," but a more direct derivation was suggested at the time of the uprise of the Regency dandies. In *The Northampton Mercury*, under date of the 17th of April 1819, occurs the following: "Origin of the word 'dandy.' This term, which has been recently applied to a species of reptile very common in the metropolis, appears to have arisen from a small silver coin struck by King Henry VII., of little value, called a *dandiprat*; and hence Bishop Fleetwood observes the term is applied to worthless and contemptible persons."

It was Beau Brummel, the high-priest of fashion, who gave dandyism its great vogue. But before his day foppery in dress had become something more than the personal eccentricity which it had been in the Stuart days and earlier. About the middle of the 18th century was founded the Macaroni Club. This was a band of young men of rank who had visited Italy and sought to introduce the southern elegances of manner and dress into England. The Macaronis gained their name from their introduction of the Italian dish to English tables, and were at their zenith about 1772, when their costume is described as "white silk breeches, very tight coat and vest with enormous white neckcloths, white silk stockings and diamond-buckled red-heeled shoes." For some time the moving spirit of the club was Charles James Fox. It was with the advent of Brummel, however, that the cult of dandyism became a social force. Beau Brummel was supreme dictator in matters of dress, and the prince regent is said to have wept when he disapproved of the cut of the royal coat. Around the Beau collected a band of young men whose insolent and affected manners made them universally unpopular. Their chief glory was their clothes. They wore coats of blue or brown cloth with brass buttons, the coat-tails almost touching the heels. Their trousers were buckskin, so tight that it is said they "could only be taken off as an eel would be divested of his skin." A pair of highly-polished Hessian boots, a waistcoat buttoned incredibly tight so as to produce a small waist, and opening at the breast to exhibit the frilled shirt and cravat, completed the costume of the true dandy. Upon the Beau's disgrace and ruin, Lord Alvanley was regarded as leader of the dandies and "first gentleman in England." Though in many ways a worthier man than Brummel, his vanity exposed him to much derision, and he fought a duel on Wimbledon Common with Morgan O'Connell, who, in the House of Commons, had called him a "bloated buffoon." After 1825 "dandy" lost its invidious meaning, and came to be applied generally to those who were neat in dress rather than to those guilty of effeminacy.

See Barbey D'Aurevilly, *Du dandysme et de G. Brummel* (Paris, 1887).

**DANEGELD**, an English national tax originally levied by Æthelred II. (the Unready) as a means of raising the tribute which was the price of the temporary cessation of the Danish ravages. This expedient of buying off the invader was first adopted in 991 on the advice of certain great men of the kingdom. It was repeated in 994, 1002, 1007 and 1012. With the accession of the Danish king Canute, the original *raison d'être* of the tax ceased to exist, but it continued to be levied, though for a different purpose, assuming now the character of an occasional war-tax. It was exceedingly burdensome, and its abolition by Edward the Confessor in 1051 was welcomed as a great relief. William the Conqueror revived it immediately after his accession, as a convenient method of national taxation, and it was with the object of facilitating its collection that he ordered the compilation of Domesday Book. It continued to be levied until 1163, in which year the name Danegeld appears for the last time in the

Rolls. Its place was taken by other imposts of similar character but different name.

**DANELAGH**, the name given to those districts in the north and north-east of England which were settled by Danes and other Scandinavian invaders during the period of the Viking invasions. The real settlement of England by Danes began in the year 866 with the appearance of a large army in East Anglia, which turned north in the following year. The Danes captured York and overthrew the Northumbrian kingdom, setting up a puppet king of their own. They encamped in Nottingham in 868, and Northern Mercia was soon in their hands; in 870 Edmund, king of the East Anglians, fell before them. During the next few years they maintained their hold on Mercia, and we have at this time coins minted in London with the inscription "Alfdene rex," the name of the Danish leader. In the winter of 874-875 they advanced as far north as the Tyne, and at the same time Cambridge was occupied. In the meantime the great struggle with Alfred the Great was being carried on. This was terminated by the peace of Wedmore in 878, when the Danes withdrew from Wessex and settled finally in East Anglia under their king Guthrum. This peace was finally and definitely ratified in the document known as the peace of Alfred and Guthrum, which is probably to be referred to the year 880. The peace determined the boundary of Guthrum's East Anglian kingdom. According to the terms of the agreement the boundary was to run along the Thames estuary to the mouth of the Lea (a few miles east of London), then up the Lea to its source near Leighton Buzzard, then due north to Bedford, then eastwards up the Ouse to Watling Street somewhere near Fenny or Stony Stratford. From this point the boundary is left undefined, perhaps because the kingdoms of Alfred and Guthrum ceased to be conterminous here, though if Northamptonshire was included in the kingdom of Guthrum, as seems likely, the boundary must be carried a few miles along Watling Street. Thus Northern Mercia, East Anglia, the greater part of Essex and Northumbria were handed over to the Danes and henceforth constitute the district known as the Danelagh.

The three chief divisions of the Danelagh were (1) the kingdom of Northumbria, (2) the kingdom of East Anglia, (3) the district of the Five (Danish) Boroughs—lands grouped round Leicester, Nottingham, Derby, Stamford and Lincoln, and forming a loose confederacy. Of the history of the two Danish kingdoms we know very little. Guthrum of East Anglia died in 890, and later we hear of a king Eric or Eohric who died in 902. Another Guthrum was ruling there in the days of Edward the Elder. The history of the Northumbrian kingdom is yet more obscure. After an interregnum consequent on the death of Healfdene the kingdom passed in 883 to one Guthred, son of Hardicanute, who ruled till 894, when his realm was taken over by King Alfred, though probably only under a very loose sovereignty. It may be noted here that Northumbria north of the Tyne, the old Bernicia, seems never to have passed under Danish authority and rule, but to have remained in independence until the general submission to Edward in 924.

More is known of the history of the five boroughs. From 907 onwards Edward the Elder, working together with Æthelred of Mercia and his wife, worked for the recovery of the Danelagh. In that year Chester was fortified. In 911-912 an advance on Essex and Hertfordshire was begun. In 914 Buckingham was fortified and the Danes of Bedfordshire submitted. In 917 Derby was the first of the five boroughs to fall, followed by Leicester a few months later. In the same year after a keen struggle all the Danes belonging to the "borough" of Northampton, as far north as the Welland (*i.e.* the border of modern Northamptonshire), submitted to Edward and at the same time Colchester was fortified; a large portion of Essex submitted and the whole of the East Anglian Danes came in. Stamford was the next to yield, soon followed by Nottingham, and in 920 there was a general submission on the part of the Danes and the reconquest of the Danelagh was now complete.

Though the independent occupation of the Danelagh by Viking invaders did not last for more than fifty years at the



outside, the Danes left lasting marks of their presence in these territories.

The divisions of the land are foreign not native. The grouping of shires round a county town as distinct from the old national shires is probably of Scandinavian origin, and so certainly is the division of Yorkshire and Lincolnshire into "ridings." In Derbyshire, Leicestershire, Lincolnshire, part of Northamptonshire, Nottinghamshire, Rutlandshire (of later formation) and Yorkshire we have the counties divided into "wapentakes" instead of "hundreds," again a mark of Danish influence.

When we turn to the social divisions we find in Domesday and other documents classes of society in these districts bearing purely Norse names, *dreng, karl, karlman, bonde, thrall, lysing, hold*; in the system of taxation we have an assessment by *carucates* and not by hides and *virgates*, and the duodecimal rather than the decimal system of reckoning.

The highly developed Scandinavian legal system has also left abundant traces in this district. We may mention specially the institution of the "lawmen," whom we find as a judicial body in several of the towns in or near the Danelagh. They are found at Cambridge, Stamford, Lincoln, York and Chester. There can be no doubt that these "lawmen," who can be shown to form a close parallel to and indeed the ultimate source of our jury, were of Scandinavian origin. Many other legal terms can be definitely traced to Scandinavian sources, and they are first found in use in the district of the Danelagh.

The whole of the place nomenclature of Yorkshire, Lincolnshire, Nottinghamshire and Northern Northamptonshire is Scandinavian rather than native English, and in the remaining districts of the Danelagh a goodly proportion of Danish place-names may be found. Their influence is also evident in the dialects spoken in these districts to the present day. It is probable that until the end of the 10th century Scandinavian dialects were almost the sole language spoken in the district of the Danelagh, and when English triumphed, after an intermediate bilingual state, large numbers of words were adopted from the earlier Scandinavian speech.

See *The Anglo-Saxon Chronicle*, edited by Earle and Plummer (Oxford, 1892-1899); J. C. H. R. Steenstrup, *Normannerne* (4 vols., 1876-1882); and A. Bugge, *Vikingerne* (2 vols.). (A. M. W.)

**DANGERFIELD, THOMAS** (c. 1650-1685), English conspirator, was born about 1650 at Waltham, Essex, the son of a farmer. He began his career by robbing his father, and, after a rambling life, took to coining false money, for which offence and others he was many times imprisoned. False to everyone, he first tried to involve the duke of Monmouth and others by concocting information about a Presbyterian plot against the throne, and this having been proved a lie, he pretended to have discovered a Catholic plot against Charles II. This was known as the "Meal-tub Plot," from the place where the incriminating documents were hidden at his suggestion, and found by the king's officers by his information. Mrs Elizabeth Cellier,—in whose house the tub was,—almoner to the countess of Powis, who had befriended Dangerfield when he posed as a Catholic, was, with her patroness, actually tried for high treason and acquitted (1680). Dangerfield, when examined at the bar of the House of Commons, made other charges against prominent Papists, and attempted to defend his character by publishing, among other pamphlets, *Dangerfield's Narrative*. This led to his trial for libel, and on the 20th of June 1685 he received sentence to stand in the pillory on two consecutive days, be whipped from Aldgate to Newgate, and two days later from Newgate to Tyburn. On his way back he was struck in the eye with a cane by a barrister, Robert Francis, and died shortly afterwards from the blow. The barrister was tried and executed for the murder.

**DANIEL**, the name given to the central figure<sup>1</sup> of the biblical Book of Daniel (see below), which is now generally regarded as a production dating from the time of Antiochus Epiphanes (175-

<sup>1</sup> Four personages of the name of Daniel appear in the Old Testament: (1) the patriarch of Ezekiel (see above); (2) a son of David (1 Chron. iii. 1); (3) a Levite contemporary with Ezra (Ezra viii. 2; Neh. x. 6); (4) our Daniel.

164 B.C.). There are no means of ascertaining anything definite concerning the origin of the hero Daniel. The account of him in Dan. i. has been generally misunderstood. According to i. 3, the Babylonian chief eunuch was commanded to bring "certain of the children of Israel, and of the king's seed, and of the nobles" to serve in the court. Many commentators have considered this to mean that some of the children were of the royal Judæan line of Jewish noble families, an interpretation which is not justified by the wording of the passage, which contains nothing to indicate that the author meant to convey the idea that Daniel was either royal or noble. Josephus,<sup>2</sup> never doubting the historicity of Daniel, made the prophet a relative of Zedekiah and consequently of Jehoiakim, a conclusion which he apparently drew from the same passage, i. 3. Pseudo-Epiphanus,<sup>3</sup> again, probably having the same source in mind, thought that Daniel was a Jewish noble. The true Epiphanius<sup>4</sup> even gives the name of his father as Sabaan, and states that the prophet was born at Upper Beth-Horon, a village near Jerusalem. The after life and death of the seer are as obscure as his origin. The biblical account throws no light on the subject. According to the rabbis,<sup>5</sup> Daniel went back to Jerusalem with the return of the captivity, and is supposed to have been one of the founders of the mythical Great Synagogue. Other traditions affirm that he died and was buried in Babylonia in the royal vault, while the Jewish traveller Benjamin of Tudela (12th cent. A.D.) was shown his tomb in Susa, which is also mentioned by the Arab, Abulfaragius (Bar-hebraeus). The author of *Daniel* did not pretend to give any sketch of the prophet's career, but was content merely with making him the central figure, around which to group more or less disconnected narratives and accounts of visions. In view of these facts, and also of the generally inaccurate character of all the historical statements in the work, there is really no evidence to prove even the existence of the Daniel described in the book bearing his name.

The question at once arises as to where the Maccabæan author of *Daniel* could have got the name and personality of his Daniel. It is not probable that he could have invented both name and character. There is an allusion in the prophet Ezekiel (xiv. 14, 20, xxviii. 3) to a Daniel whom he places as a great personality between Noah and Job. But this could not be our Daniel, whom Ezekiel, probably a man of ripe age at the time of the Babylonian deportation of the Jews, would hardly have mentioned in the same breath with two such characters, much less have put him *between* them, because, had the Daniel of the biblical book existed at this time, he would have been a mere boy, lacking any such distinction as to make him worthy of so high a mention. It is evident that Ezekiel considered his Daniel to be a celebrated ancient prophet, concerning whose date and origin, however, there is not a single trace to guide research. Hitzig's<sup>6</sup> conjecture that the Daniel of Ezekiel was Melchizedek is quite without foundation. The most that can be said in this connexion is that there may really have been a spiritual leader of the captive Jews who resided at Babylon and who was either named Daniel, perhaps after the unknown patriarch mentioned by Ezekiel, or to whom the same name had been given in the course of tradition by some historical confusion of persons. Following this hypothesis, it must be assumed that the fame of this Judæo-Babylonian leader had been handed down through the unclear medium of oral tradition until the time of Antiochus Epiphanes, when some gifted Jewish author, feeling the need of producing a work which should console his people in their affliction under the persecutions of that monarch, seized upon the personality of the seer who lived during a time of persecution bearing many points of resemblance to that of Antiochus IV., and moulded some of the legends then extant about the life and activity of this misty prophet into such a form as should be best suited to a didactic purpose.<sup>7</sup>

<sup>2</sup> Ant. x. 10, 1.

<sup>3</sup> Chap. x., on the Prophets.

<sup>4</sup> Panarion, *adv. Haeres.* 55, 3.

<sup>5</sup> Prince, *Dan.* p. 26, n. 6.

<sup>6</sup> *Dan.* p. viii.

<sup>7</sup> The account in chap. ii. of the promotion of Daniel to be governor of Babylon, as a reward for his correct interpretation of Nebuchadrezzar's dream, is very probably an imitation of the story of Joseph in Gen. xl-xli. The points of resemblance are very striking. In both accounts, we have a young Hebrew raised by the favour of a heathen

**DANIEL, BOOK OF.**—The Book of Daniel stands between Ezra and Esther in the third great division of the Hebrew Bible known as the *Hagiographa*, in which are classed all works which were not regarded as being part of the Law or the Prophets. The book presents the unusual peculiarity of being written in two languages, i.-ii. 4 and viii.-xii. being in Hebrew, while the text of ii. 4-vii. is the Palestinian dialect of Aramaic.<sup>1</sup> The subject matter, however, falls naturally into two divisions which are not co-terminous with the linguistic sections; viz. i.-vi. and vii.-xii. The first of these sense-divisions deals only with narratives regarding the reign of Nebuchadrezzar and his supposed son Belshazzar, while the second section consists exclusively of apocalyptic prophecies. There can be no doubt that a definite plan was followed in the arrangement of the work. The author's object was clearly to demonstrate to his readers the necessity of faith in Israel's God, who shall not for ever allow his chosen ones to be ground under the heel of a ruthless heathen oppressor. To illustrate this, he makes use on the one hand (i.-vi.) of carefully chosen narratives, somewhat loosely connected it is true, but all treating substantially the same subject,—the physical triumph of God's servant over his unbelieving enemies; and on the other hand (vii.-xii.), he introduces certain prophetic visions illustrative of God's favour towards the same servant, Daniel. So carefully is this record of the visions arranged that the first two chapters of the second part of the book (vii.-viii.) were no doubt purposely made to appear in a symbolic form, in order that in the last two revelations (xi.-xii.), which were couched in such direct language as to be intelligible even to the modern student of history, the author might obtain the effect of a climax. The book is probably not therefore a number of parts of different origin thrown loosely together by a careless editor, who does not deserve the title of author.<sup>2</sup> The more or less disconnected sections of the first part of the work were probably so arranged purposely, in order to facilitate its diffusion at a time when books were known to the people at large chiefly by being read aloud in public.

Various attempts have been made to explain the sudden change from Hebrew to Aramaic in ii. 4. It was long thought, for example, that Aramaic was the vernacular of Babylonia and was consequently employed as the language of the parts relating to that country. But this was not the case, because the Babylonian language survived until a later date than that of the events portrayed in Daniel.<sup>3</sup> Nor is it possible to follow the theory of Merx, that Aramaic, which was the popular tongue of the day when the Book of Daniel was written, was therefore used for the simpler narrative style, while the more learned Hebrew was made the idiom of the philosophical portions.<sup>4</sup> The first chapter, which is just as much in the narrative style as are the following Aramaic sections, is in Hebrew, while the distinctly apocalyptic chapter vii. is in Aramaic. A third view, that the bilingual character of the work points to a time when both languages were used indifferently, is equally unsatisfactory,<sup>5</sup> because it is highly questionable whether two idioms can ever be used quite indifferently. In fact, a hybrid work in two languages would be a literary monstrosity. In view of the apparent unity of the entire work, the only possible explanation seems to be that the book was written at first all in Hebrew, but for the convenience of the general reader whose vernacular was Aramaic, a translation, possibly from the same pen as the original, was made into Aramaic, owing to his extraordinary God-given ability to interpret dreams. In both versions, the heathen astrologers make the first attempt to solve the difficulty, which results in failure, whereupon the pious Israelite, being summoned to the royal presence, in both cases through the friendly intervention of a court official, triumphantly explains the mystery to the king's satisfaction (cf. Prince, *Dan.* p. 29).

<sup>1</sup> See Bevan, *Dan.* 28-40, on the Hebrew and Aramaic of Daniel.

<sup>2</sup> According to Lagarde, *Mitteilungen*, iv. 351 (1891); also Gött, *Gelehrte Anzeigen* (1891), 497-520.

<sup>3</sup> The latest connected Babylonian inscription is that of Antiochus Soter (280-260 B.C.), but the language was probably spoken until Hellenic times; cf. Gutbrod, *Zeitschr. für Assyriol.* vi. 27.

<sup>4</sup> Prince, *Dan.* 12.

<sup>5</sup> Bertholdt, *Dan.* 15; Franz Delitzsch, in Herzog, *Realencyklopädie*, 2nd ed., iii. 470.

Aramaic. It must be supposed then that, certain parts of the original Hebrew manuscript being lost, the missing places were supplied from the current Aramaic translation.<sup>6</sup>

It cannot be denied in the light of modern historical research that if the Book of Daniel be regarded as pretending to full historical authority, the biblical record is open to all manner of attack. It is now the general opinion of most modern scholars who study the Old Testament from a critical point of view that this work cannot possibly have originated, according to the traditional theory, at any time during the Babylonian monarchy, when the events recorded are supposed to have taken place.

The chief reasons for such a conclusion are as follows.<sup>7</sup>

1. The position of the book among the *Hagiographa*, instead of among the Prophetical works, seems to show that it was introduced after the closing of the Prophetical Canon. Some commentators have believed that Daniel was not an actual prophet in the proper sense, but only a seer, or else that he had no official standing as a prophet and that therefore the book was not entitled to a place among official prophetical books. But if the work had really been in existence at the time of the completion of the second part of the canon, the collectors of the prophetical writings, who in their care did not neglect even the parable of Jonah, would hardly have ignored the record of so great a prophet as Daniel is represented to have been.

2. Jesus ben Sirach (*Ecclesiasticus*), who wrote about 200-180 B.C., in his otherwise complete list of Israel's leading spirits (xlix.), makes no mention of Daniel. Hengstenberg's plea that Ezra and Mordecai were also left unmentioned has little force, because Ezra appears in the book bearing his name as nothing more than a prominent priest and scholar, while Daniel is represented as a great prophet.

3. Had the Book of Daniel been extant and generally known after the time of Cyrus (537-529 B.C.), it would be natural to look for some traces of its power among the writings of Haggai, Zechariah and Malachi, whose works, however, show no evidence that either the name or the history of Daniel was known to these authors. Furthermore, the manner in which the prophets are looked back upon in ix. 6-10 cannot fail to suggest an extremely late origin for the book. Besides this, a careful study of ix. 2 seems to indicate that the Prophetical Canon was definitely completed at the time when the author of Daniel wrote. It is also highly probable that much of the material in the second part of the book was suggested by the works of the later prophets, especially by Ezekiel and Zechariah.

4. Some of the beliefs set forth in the second part of the book also practically preclude the possibility of the author having lived at the courts of Nebuchadrezzar and his successors. Most noticeable among these doctrines is the complete system of angelology consistently followed out in the Book of Daniel, according to which the management of human affairs is entrusted to a regular hierarchy of commanding angels, two of whom, Gabriel and Michael, are even mentioned by name. Such an idea was distinctly foreign to the primitive Israelitish conception of the indivisibility of Yahweh's power, and must consequently have been a borrowed one. It could certainly not have come from the Babylonians, however, whose system of attendant spirits was far from being so complete as that which is set forth in the Book of Daniel, but rather from Persian sources where a more complicated angelology had been developed. As many commentators have brought out, there can be little doubt that the doctrine of angels in Daniel is an indication of prolonged Persian influence. Furthermore, it is now very generally admitted that the doctrine of the resurrection of the dead, which is advanced for the first time in the Old Testament in Daniel, also originated among the Persians,<sup>8</sup> and could only have been engrafted on the Jewish mind after a long period of intercourse with the Zoroastrian religion, which came into contact with the Jewish thinkers considerably after the time of Nebuchadrezzar.

<sup>6</sup> Bevan, *Dan.* 27 ff.; Prince, *Dan.* 13.

<sup>7</sup> For this whole discussion, see Prince, *Dan.* 15 ff.

<sup>8</sup> The investigations of Haug, Spiegel and Windischmann show that this was a real Zoroastrian doctrine.

5. All the above evidences are merely internal, but we are now able to draw upon the Babylonian historical sources to prove that Daniel could not have originated at the time of Nebuchadrezzar. There can be no doubt that the author of Daniel thought that Belshazzar (*q.v.*), who has now been identified beyond all question with *Bel-šar-uzur*, the son of Nabonidus, the last Semitic king of Babylon, was the son of Nebuchadrezzar, and that Belshazzar attained the rank of king.<sup>1</sup> This prince did not even come from the family of Nebuchadrezzar. Nabonidus, the father of Belshazzar, was the son of a nobleman *Nabu-baladsu-iqbi*, who was in all probability not related to any of the preceding kings of Babylon. Had Nabonidus been descended from Nebuchadrezzar he could hardly have failed in his records, which we possess, to have boasted of such a connexion with the greatest Babylonian monarch; yet in none of his inscriptions does he trace his descent beyond his father. Certain expositors have tried to obviate the difficulty, first by supposing that the expression "son of Nebuchadrezzar" in Daniel means "descendant" or "son," a view which is rendered untenable by the facts just cited. This school has also endeavoured to prove that the author of Daniel did not mean to imply Belshazzar's kingship of Babylon at all by his use of the word "king," but they suggest that the writer of Daniel believed Belshazzar to have been co-regent. If Belshazzar had ever held such a position, which is extremely unlikely in the absence of any evidence from the cuneiform documents, he would hardly have been given the unqualified title "king of Babylon" as occurs in Daniel.<sup>2</sup> For example, Cambyses, son of Cyrus, was undoubtedly co-regent and bore the title "king of Babylon" during his father's lifetime, but, in a contract which dates from the first year of Cambyses, it is expressly stated that Cyrus was still "king of the lands." This should be contrasted with Dan. viii. 1, where reference is made to the "third year of Belshazzar, king of Babylon" without any allusion to another over-ruler. Such attempts are at best subterfuges to support an impossible theory regarding the origin of the Book of Daniel, whose author clearly believed in the kingship of Belshazzar and in that prince's descent from Nebuchadrezzar.

Furthermore, the writer of Daniel asserts (v. 1) that a monarch "Darius the Mede" received the kingdom of Babylon after the fall of the native Babylonian house, although it is evident, from i. 21, x. 1, that the biblical author was perfectly aware of the existence of Cyrus.<sup>3</sup> The fact that in no other scriptural passage is mention made of any Median ruler between the last Semitic king of Babylon and Cyrus, and the absolute silence of the authoritative ancient authors regarding such a king, make it apparent that the late author of Daniel is again in error in this particular. It is known that Cyrus became master of Media by conquering Astyages, and that the troops of the king of Persia capturing Babylon took Nabonidus prisoner with but little difficulty. Unsuccessful attempts have been made to identify this mythical Darius with the Cyaxares, son of Astyages, of Xenophon's *Cyropaedia*, and also with the Darius of Eusebius, who was in all probability Darius Hystaspis. There is not only no room in history for this Median king of the Book of Daniel, but it is also highly likely that the interpolation of "Darius the Mede" was caused by a confusion of history, due both to the destruction of the Assyrian capital Nineveh by the Medes, sixty-eight years before the capture of Babylon by Cyrus, and also to the fame of the later king, Darius Hystaspis, a view which was advanced early in the history of biblical criticism as the days of the Benedictine monk, Marianus Scotus. It is important to note in this connexion that Darius the Mede is represented as the son of Xerxes (Ahasuerus) and it is stated that he established 120 satrapies. Darius Hystaspis was the father of Xerxes, and according to Herodotus (iii. 89) established twenty satrapies. Darius the Mede entered into possession of Babylon after the death of Belshazzar; Darius Hystaspis conquered Babylon

<sup>1</sup> Prince, *Dan.* 35-42.

<sup>2</sup> Certain tablets published by Strassmaier, bearing date continuously from Nabonidus to Cyrus, show that neither Belshazzar nor "Darius the Mede" could have had the title "king of Babylon." See Driver, *Introduction*,<sup>3</sup> xxii.

<sup>3</sup> Prince, *Dan.* 44-56.

from the hands of certain rebels (*Her.* iii. 153-160). In fine, the interpolation of a Median Darius must be regarded as the most glaring historical inaccuracy of the author of Daniel. In fact, this error of the author alone is proof positive that he must have lived at a very late period, when the record of most of the earlier historical events had become hopelessly confused and perverted.

With these chief reasons why the Book of Daniel cannot have originated in the Babylonian period, if the reader will turn more especially to the apocalyptic sections (vii.-xii.), it will be quite evident that the author is here giving a detailed account of historical events which may easily be recognized through the thin veil of prophetic mystery thrown lightly around them. It is indeed highly suggestive that just those occurrences which are the most remote from the assumed standpoint of the writer are the most correctly stated, while the nearer we approach the author's supposed time, the more inaccurate does he become. It is quite apparent that the predictions in the Book of Daniel centre on the period of Antiochus Epiphanes (175-164 B.C.), when that Syrian prince was endeavouring to suppress the worship of Yarweh and substitute for it the Greek religion.<sup>4</sup> There can be no doubt, for example, that in the "Little Horn" of vii. 8, viii. 9, and the "wicked prince" described in ix.-x., who is to work such evil among the saints, we have clearly one and the same person. It is now generally recognized that the king symbolized by the Little Horn, of whom it is said that he shall come of one of four kingdoms which shall be formed from the Greek empire after the death of its first king (Alexander), can be none other than Antiochus Epiphanes, and in like manner the references in ix. must allude to the same prince. It seems quite clear that xi. 21-45 refers to the evil deeds of Antiochus IV. and his attempts against the Jewish people and the worship of Yahweh. In xii. follows the promise of salvation from the same tyrant, and, strikingly enough, the predictions in this last section, x.-xiii., relating to future events, become inaccurate as soon as the author finishes the section describing the reign of Antiochus Epiphanes. The general style of all these prophecies differs materially from that of all other prophetic writings in the Old Testament. Other prophets confine themselves to vague and general predictions, but the author of Daniel is strikingly particular as to detail in everything relating to the period in which he lived, *i.e.* the reign of Antiochus IV. Had the work been composed during the Babylonian era, it would be more natural to expect prophecies of the return of the exiled Jews to Palestine, as in Jeremiah, Ezekiel and Isaiah, rather than the acclamation of an ideal Messianic kingdom such as is emphasized in the second part of Daniel.

As a specimen of the apocalyptic method followed in Daniel, the celebrated prophecy of the seventy weeks (ix. 24-27) may be cited, a full discussion of which will be found in Prince, *Daniel* 157-161. According to Jer. xxv. 11-12, the period of Israel's probation and trial was to last seventy years. In the angelic explanation in Daniel of Jeremiah's prophecy, these years were in reality year-weeks, which indicated a period of 490 years. This is the true apocalyptic system. The author takes a genuine prophecy, undoubtedly intended by Jeremiah to refer simply to the duration of the Babylonian captivity, and, by means of a purely arbitrary and mystical interpretation, makes it denote the entire period of Israel's degradation down to his own time. This prophecy is really nothing more than an extension of the vision of the 2300 evening-mornings of viii. 14, and of the "time, times and a half a time" of vii. 25. The real problem is as to the beginning and end of this epoch, which is divided into three periods of uneven length; viz. one of seven weeks; one of sixty-two weeks; and the last of one week. It seems probable that the author of Daniel, like the Chronicler, began his period with the fall of Jerusalem in 586. His first seven weeks, therefore, ending with the rule of "Messiah the Prince,"<sup>5</sup> probably Joshua ben Jozadak, the first high-priest after the exile (*Ezra* iii. 2), seem to coincide exactly with the duration of the Babylon exile, *i.e.* forty-nine years.

<sup>4</sup> Prince, *Dan.* 19-20, 140, 155, 179 ff.

<sup>5</sup> That "Messiah" or "Anointed One" was used of the High-Priest is seen from *Lev.* x. 3. v. 16.

The second period of the epoch, during which Jerusalem is to be peopled and built, and at the end of which the Messiah is to be cut off, is much more difficult to determine. The key to the problem lies undoubtedly in the last statement regarding the overthrow of the Messiah or Anointed One. Such a reference coming from a Maccabean author can only allude to the deposition by Antiochus IV. of the high-priest Onias III., which took place about 174 B.C., and the Syrian king's subsequent murder of the same person not later than 171 (2 Macc. iv. 33-36). The difficulty now arises that between 537 and 171 there are only 366 years instead of the required number 434. It was evidently not the author's intention to begin the second period of sixty weeks simultaneously with the first period, as some expositors have thought, because the whole passage shows conclusively that he meant seventy independent weeks. Besides, nothing is gained by such a device, which would bring the year of the end of the second period down to the meaningless date 152, too late to refer to Onias. Cornill therefore adopted the only tenable theory regarding the problem; viz. that the author of Daniel did not know the chronology between 537 and 312, the establishment of the Seleucid era, and consequently made the period too long. A parallel case is the much quoted example of Demetrius, who placed the fall of Samaria (722 B.C.) 573 years before the succession of Ptolemy IV. (222), thus making an error of seventy-three years. Josephus, who places the reign of Cyrus forty to fifty years too early, makes a similar error.

The last week is divided into two sections (26-27), in the first of which the city and sanctuary shall be destroyed and in the second the daily offering is to be suspended. All critical scholars recognize the identity of this second half-week with the "time, times and a half a time" of vii. 25. This last week must, therefore, end with the restoration of the temple worship in 164 B.C.

This whole prophecy, which is perhaps the most interesting in the Book of Daniel, presents problems which can never be thoroughly understood, first because the author must have been ignorant of both history and chronology, and secondly, because, in his effort to be as mystical as possible, he purposely made use of indefinite and vague expressions which render the criticism of the passage a most unsatisfactory task.

The Book of Daniel loses none of its beauty and force because we are bound, in the light of modern criticism, to consider it as a production of the reign of Antiochus Epiphanes, nor should conservative Bible-readers lament because the historical accuracy of the work is thus destroyed. The influence of the work was very great on the subsequent development of Christianity, but it was not the influence of the *history* contained in it which made itself felt, but rather of that sublime hope for a future deliverance of which the author of Daniel never lost sight. The allusion to the book by Jesus (Matt. xxiv. 15) shows merely that our Lord was referring to the work by its commonly accepted title, and implies no authoritative utterance with regard to its date or authorship. Our Lord simply made use of an apt quotation from a well-known work in order to illustrate and give additional force to his own prediction. If the book be properly understood, it must not only be admitted that the author made no pretence at accuracy of detail, but also that his prophecies were clearly intended to be merely an historical résumé, clothed for the sake of greater literary vividness in a prophetic garb. The work, which is certainly not a forgery, but only a consolatory political pamphlet, is just as powerful, viewed according to the author's evident intention, as a consolation to God's people in their dire distress at the time of Antiochus Epiphanes, as if it were, what an ancient but mistaken tradition had made it, really an accurate account of events which took place at the close of the Babylonian period.<sup>1</sup>

LITERATURE.—See bibliography in Bevan, *Daniel* 9, and add Kamphausen, *Dan.*, in Haupt's *Sacred Books of the Old Testament*; Behrmann, *Dan.* (1894); J. D. Prince, *Dan.* (1899); G. A. Barton, "The Compilation of the Book of Daniel," in *Journ. Bibl. Lit.* (1898), 62-86, against the unity of the book, &c., &c.; J. D. Davis, "Persian Words and the Date of O.T. Documents," in *Old Testament and Semitic Studies: in Memory of W. R. Harper* (Chicago, 1908). (J. D. PR.)

<sup>1</sup> Prince, *Dan.* 22-24.

ADDITIONS TO DANIEL.—The "additions to Daniel" are three in number: *Susannah and the Elders*, *Bel and the Dragon*, and *The Song of the Three Children*. Of these the two former have no organic connexion with the text. The case is otherwise with regard to the last. In some respects it helps to fill up a gap in the canonical text between verses 23 and 24 of chapter iii. And yet we find Polychronius, early in the 5th century, stating that this song was not found in the Syriac version.

*Susannah*.—This addition was placed by Theodotion before chap. i., and *Bel and the Dragon* at its close, whereas by the Septuagint and the Vulgate it was reckoned as chap. xiii. after the twelve canonical chapters, *Bel and the Dragon* as xiv. Theodotion's version is the source of the Peshitto and the Vulgate, for all three additions, and the Septuagint is the source of the Syro-Hexaplaric which has been published by Ceriani (*Mon. Sacr.* vii.). The legend recounts how that in the early days of the Captivity *Susannah*, the beautiful and pious wife of the rich Joakim, was walking in her garden and was there seen by two elders who were also judges. Inflamed with lust, they made infamous proposals to her, and when repulsed they brought against her a false charge of adultery. When brought before the tribunal she was condemned to death and was on the way to execution, when Daniel interposed and, by cross-questioning the accusers apart, convinced the people of the falsity of the charge.

The source of the story may, according to Ewald (*Gesch.*<sup>3</sup> iv. 636), have been suggested by the Babylonian legend of the seduction of two old men by the goddess of love (see also Koran, *Sur.* ii. 96). Another and much more probable origin of the work is that given by Brüll (*Das apocr. Susanna-Buch*, 1877) and Ball (*Speaker's Apocr.* ii. 323-331). The first half of the story is based on a tradition—originating possibly in Jer. xxix. 21-32 and found in the Talmud and Midrash—of two elders Ahab and Zedekiah, who in the Captivity led certain women astray under the delusion that they should thereby become the mother of the Messiah. But the most interesting part of the investigation is concerned with the latter half of the story, which deals with the trial. The characteristics of this section point to its composition about 100-90 B.C., when Simon ben Shetaḥ was president of the Sanhedrin. Its object was to support the attempts of the Pharisees to bring about a reform in the administration of the law courts. According to Sadducean principles the man who was convicted of falsely accusing another of a capital offence was not put to death unless his victim was already executed. The Pharisees held that the intention of the accusers was equivalent to murder. Our apocryphal upholds the Pharisaic contention. As Simon ben Shetaḥ insisted on a rigorous examination of the witnesses, so does our writer: as he and his party required that the perjurer should suffer the same penalty he sought to inflict on another, so our writer represents the death penalty as inflicted on the perjured elders.

The language was in all probability Semitic-Hebrew or Aramaic. The paronomasiae in the Greek in verses 54-55 (ὄπρὸ σχίσσον . . . σχίσσει) and 58-59 (ὄπρὸ πρίνον . . . πρίσει) present no cogent difficulty against this view; for they may be accidental and have arisen for the first time in the translation. But as Brüll and Ball have shown (see *Speaker's Apocr.* ii. 324), the same paronomasiae are possible either in Hebrew or Aramaic.

LITERATURE.—Ball in the *Speaker's Apocr.* ii. 233 sqq.; Schürer, *Gesch.*<sup>3</sup> iii. 333; Rothstein in Kautzsch's *Apocr. u. Pseud.* i. 176 sqq.; Kamphausen in *Ency. Bibl.*; Marshall in *Hastings' Bible Dict.*; Toy in the *Jewish Encyc.*

*Bel and the Dragon*.—We have here two independent narratives, in both of which Daniel appears as the destroyer of heathenism. The latter had a much wider circulation than the former, and is most probably a Judaized form of the old Semitic myth of the destruction of the old dragon, which represents primeval chaos (see Ball, *Speaker's Apocr.* ii. 346-348; Gunkel, *Schöpfung und Chaos*, 320-323). Marduk destroys Tiamat in a similar manner to that in which Daniel destroys the dragon (Delitzsch, *Das babylonische Welterschöpfung Epos*), by driving a storm-wind into the dragon which rends it asunder. Marshall (*Hastings' Bible Dict.* i. 267) suggests that the "pitch" of the Greek (Aramaic *ἄνεμος*) arose from the original term for storm-wind (*ἄνεμος*).

The Greek exists in two recensions, those of the Septuagint and Theodotion. Most scholars maintain a Greek original, but this is by no means certain. Marshall (*Hastings' Bib. Dict.* i. 268) argues for an Aramaic, and regards Gaster's Aramaic text [*Proceedings of the Society of Biblical Archaeology* (1894), pp. 280-290, 312-317; (1895) 75-94] as of primary value in this respect, but this is doubtful.

LITERATURE.—Fritzsch's *Handbuch zu den Apoc.*; Ball in the *Speaker's Apocr.* ii. 344 sqq.; Schürer, *Gesch.* iii. 332 sqq.; and the articles in the *Ency. Bibl.*, *Bible Dict.*, and *Jewish Encyc.*

The Greek text is best given in Swete iii., and the Syriac will be found in Walton's *Polyglot*, Lagarde and Neubauer's *Tobit*.

*Song of the Three Children*.—This section is composed of the Prayer of Azariah and the Song of Azariah, Ananias and Misael, and was inserted after iii. 23 of the canonical text of Daniel. According to Fritzsch, König, Schürer, &c., it was composed in Greek and added to the Greek translation. On the other hand, Delitzsch, Bissell, Ball, &c., maintain a Hebrew original. The latter view has been recently supported by Rothstein, *Apocr. und Pseud.* i. 173-176, who holds that these additions were made to the text before its translation into Greek. These additions still preserve, according to Rothstein, a fragment of the original text, i.e. verses 23-28, which came between verses 23 and 24 of chapter iii. of the canonical text. They certainly fill up excellently a manifest gap in this text. "The Song of the Three Children" was first added after the verses just referred to, and subsequently the Prayer of Azariah was inserted before these verses.

LITERATURE.—Ball in the *Speaker's Apocr.* ii. 305 sqq.; Rothstein in *Kautzsch's Apocr. und Pseud.* i. 173 sqq.; Schürer, *Gesch.* iii. 332 sqq. (R. H. C.)

**DANIEL (DANIL)**, of Kiev, the earliest Russian travel-writer, and one of the leading Russian travellers in the middle ages. He journeyed to Syria and other parts of the Levant about 1106-1107. He was the *igumen*, or abbot, of a monastery probably near Chernigov in Little Russia: some identify him with one Daniel, bishop of Suriev (fl. 1115-1122). He visited Palestine in the reign of Baldwin I., Latin king of Jerusalem (1100-1118), and apparently soon after the crusading capture of Acre (1104); he claims to have accompanied Baldwin, who treated him with marked friendliness, on an expedition against Damascus (c. 1107). Though Daniel's narrative, beginning (as it practically ends) at Constantinople, omits some of the most interesting sections of his journey, his work has considerable value. His picture of the Holy Land preserves a record of conditions (such as the Saracen raiding almost up to the walls of Christian Jerusalem, and the friendly relations subsisting between Roman and Eastern churches in Syria) peculiarly characteristic of the time; his account of Jerusalem itself is remarkably clear, minute and accurate; his three excursions—to the Dead Sea and Lower Jordan (which last he compares to a river of Little Russia, the Snov), to Bethlehem and Hebron, and towards Damascus—gave him an exceptional knowledge of certain regions. In spite of some extraordinary blunders in topography and history, his observant and detailed record, marked by evident good faith, is among the most valuable of medieval documents relating to Palestine: it is also important in the history of the Russian language, and in the study of ritual and liturgy (from its description of the Easter services in Jerusalem, the Descent of the Holy Fire, &c.). Several Russian friends and companions, from Kiev and Old Novgorod, are recorded by Daniel as present with him at the Easter Eve "miracle," in the church of the Holy Sepulchre.

There are seventy-six MSS. of Daniel's Narrative, of which only five are anterior to A.D. 1500; the oldest is of 1475 (St Petersburg, Library of Ecclesiastical History 9/1086). Three editions exist, of which I. P. Sakharov's (St Petersburg, 1849) is perhaps the best known (in *Narratives of the Russian People*, vol. ii. bk. viii. pp. 1-45). See also the French version in *Itinéraires russes en orient*, ed. M<sup>e</sup> B. de Khitrovo (Geneva, 1889) (*Société de l'orient latin*); and the account of Daniel in C. R. Beazley, *Dawn of Modern Geography*, ii. 155-174. (C. R. B.)

**DANIEL, GABRIEL** (1649-1728), French Jesuit historian, was born at Rouen on the 8th of February 1649. He was educated by the Jesuits, entered the order at the age of eighteen, and

became superior at Paris. He is best known by his *Histoire de France depuis l'établissement de la monarchie française* (first complete edition, 1713), which was republished in 1720, 1721, 1725, 1742, and (the last edition, with notes by Father Griffet) 1755-1760. Daniel published an abridgment in 1724 (English trans., 1726), and another abridgment was published by Dorival in 1751. Though full of prejudices which affect his accuracy, Daniel had the advantage of consulting valuable original sources. His *Histoire de la milice française, &c.* (1721) is superior to his *Histoire de France*, and may still be consulted with advantage. Daniel also wrote a by no means successful reply to Pascal's *Provincial Letters*, entitled *Entretiens de Cléanthe et d'Eudoxe sur les lettres provinciales* (1694); two treatises on the Cartesian theory as to the intelligence of the lower animals, and other works.

See Sommervogel, *Bibliothèque de la Compagnie de Jésus*, t. ii.

**DANIEL, SAMUEL** (1562-1619), English poet and historian, was the son of a music-master, and was born near Taunton, in Somersetshire, in 1562. Another son, John Daniel, was a musician, who held some offices at court, and was the author of *Songs for the Lute, Viol and Voice* (1606). In 1579 Samuel was admitted a commoner of Magdalen Hall, Oxford, where he remained for about three years, and then gave himself up to the unrestrained study of poetry and philosophy. The name of Samuel Daniel is given as the servant of Lord Stafford, ambassador in France, in 1586, and probably refers to the poet. He was first encouraged and, if we may believe him, taught in verse, by the famous countess of Pembroke, whose honour he was never weary of proclaiming. He had entered her household as tutor to her son, William Herbert. His first known work, a translation of Paulus Jovius, to which some original matter is appended, was printed in 1585. His first known volume of verse is dated 1592; it contains the cycle of sonnets to *Delia* and the romance called *The Complaint of Rosamond*. Twenty-seven of the sonnets had already been printed at the end of Sir Philip Sidney's *Astrophel and Stella* without the author's consent. Several editions of *Delia* appeared in 1592, and they were very frequently reprinted during Daniel's lifetime. We learn by internal evidence that *Delia* lived on the banks of Shakespeare's river, the Avon, and that the sonnets to her were inspired by her memory when the poet was in Italy. To an edition of *Delia* and *Rosamond*, in 1594, was added the tragedy of *Cleopatra*, a severe study in the manner of the ancients, in alternately rhyming heroic verse, diversified by stiff choral interludes. *The First Four Books of the Civil Wars*, an historical poem in *ottava rima*, appeared in 1595. The bibliography of Daniel's works is attended with great difficulty, but as far as is known it was not until 1599 that there was published a volume entitled *Poetical Essays*, which contained, besides the "Civil Wars," "Musophilus," and "A letter from Octavia to Marcus Antonius," poems in Daniel's finest and most mature manner. About this time he became tutor to Anne Clifford, daughter of the countess of Cumberland. On the death of Spenser, in the same year, Daniel received the somewhat vague office of poet-laureate, which he seems, however, to have shortly resigned in favour of Ben Jonson. Whether it was on this occasion is not known, but about this time, and at the recommendation of his brother-in-law, Giovanni Florio, he was taken into favour at court, and wrote a *Panegyric Congratulatory offered to the King at Burleigh Harrington in Rutlandshire*, in *ottava rima*. In 1603 this poem was published, and in many cases copies contained in addition his *Poetical Epistles* to his patrons and an elegant prose essay called *A Defence of Rima* (originally printed in 1602) in answer to Thomas Campion's *Observations on the Art of English Poesie*, in which it was contended that rhyme was unsuited to the genius of the English language. In 1603, moreover, Daniel was appointed master of the queen's revels. In this capacity he brought out a series of masques and pastoral tragedy-comedies,—of which were printed *A Vision of the Twelve Goddesses*, in 1604; *The Queen's Arcadia*, an adaptation of Guarini's *Pastor Fido*, in 1606; *Tethys Festival or the Queen's Wake*, written on the occasion of Prince Henry's becoming a Knight of the Bath, in 1610; and *Hymen's Triumph*, in honour



of Lord Roxburgh's marriage in 1615. Meanwhile had appeared, in 1605, *Certain Small Poems*, with the tragedy of *Philotas*; the latter was a study, in the same style as *Cleopatra*, written some five years earlier. This drama brought its author into difficulties, as *Philotas*, with whom he expressed some sympathy, was taken to represent Essex. In 1607, under the title of *Certaine small Workes heretofore divulged by Samuel Daniel*, the poet issued a revised version of all his works except *Delia* and the *Civil Wars*. In 1609 the *Civil Wars* had been completed in eight books. In 1612 Daniel published a prose *History of England*, from the earliest times down to the end of the reign of Edward III. This work afterwards continued, and published in 1617, was very popular with Drayton's contemporaries. The section dealing with William the Conqueror was published in 1692 as being the work of Sir Walter Raleigh, apparently without sufficient grounds.

Daniel was made a gentleman-extraordinary and groom of the chamber to Queen Anne, sinecure offices which offered no hindrance to an active literary career. He was now acknowledged as one of the first writers of the time. Shakespeare, Selden and Chapman are named among the few intimates who were permitted to intrude upon the seclusion of a garden-house in Old Street, St Luke's, where, Fuller tells us, he would "lie hid for some months together, the more retiredly to enjoy the company of the Muses, and then would appear in public to converse with his friends." Late in life Daniel threw up his titular posts at court and retired to a farm called "The Ridge," which he rented at Beckington, near Devizes in Wiltshire. Here he died on the 14th of October 1619.

The poetical writings of Daniel are very numerous, but in spite of the eulogies of all the best critics, they were long neglected. This is the more singular since, during the 18th century, when so little Elizabethan literature was read, Daniel retained his poetical prestige. In later times Coleridge, Charles Lamb and others expended some of their most genial criticisms on this poet. Of his multifarious works the sonnets are now, perhaps, most read. They depart from the Italian sonnet form in closing with a couplet, as is the case with most of the sonnets of Surrey and Wyatt, but they have a grace and tenderness all their own. Of a higher order is *The Complaint of Rosamond*, a soliloquy in which the ghost of the murdered woman appears and bewails her fate in stanzas of exquisite pathos. Among the *Epistles to Distinguished Persons* will be found some of Daniel's noblest stanzas and most polished verse. The epistle to Lucy, countess of Bedford, is remarkable among those as being composed in genuine *terza rima*, till then not used in English. Daniel was particularly fond of a four-lined stanza of solemn alternately rhyming iambics, a form of verse distinctly misplaced in his dramas. These, inspired it would seem by like attempts of the countess of Pembroke's, are hard and frigid; his pastorals are far more pleasing; and *Hymen's Triumph* is perhaps the best of all his dramatic writing. An extract from this masque is given in Lamb's *Dramatic Poets*, and it was highly praised by Coleridge. In elegiac verse he always excelled, but most of all in his touching address *To the Angel Spirit of the Most Excellent Sir Philip Sidney*. We must not neglect to quote *Musophilus* among the most characteristic writings of Daniel. It is a dialogue between a courtier and a man of letters, and is a general defence of learning, and in particular of poetic learning as an instrument in the education of the perfect courtier or man of action. It is addressed to Fulke Greville, and written, with much sententious melody, in a sort of *terza rima*, or, more properly, *ottava rima* with the couplet omitted. Daniel was a great reformer in verse, and the introducer of several valuable novelties. It may be broadly said of his style that it is full, easy and stately, without being very animated or splendid. It attains a high average of general excellence, and is content with level flights. As a gnomic writer Daniel approaches Chapman, but is far more musical and coherent. He is wanting in fire and passion, but he is pre-eminent in scholarly grace and tender, mournful reverie.

Daniel's works were edited by A. B. Grosart in 1885-1896.

(E. G.)

**DANIELL, JOHN FREDERIC** (1790-1845), English chemist and physicist, was born in London on the 12th of March 1790, and in 1831 became the first professor of chemistry at the newly founded King's College, London. His name is best known for his invention of the Daniell cell (*Phil. Trans.*, 1836), still extensively used for telegraphic and other purposes. He also invented the dew-point hygrometer known by his name (*Quar. Journ. Sci.*, 1820), and a register pyrometer (*Phil. Trans.*, 1830); and in 1830 he erected in the hall of the Royal Society a water-barometer, with which he carried out a large number of observations (*Phil. Trans.*, 1832). A process devised by him for the manufacture of illuminating gas from turpentine and resin was in use in New York for a time. His publications include *Meteorological Essays* (1823), an *Essay on Artificial Climate considered in its Applications to Horticulture* (1824), which showed the necessity of a humid atmosphere in hothouses devoted to tropical plants, and an *Introduction to the Study of Chemical Philosophy* (1839). He died suddenly of apoplexy on the 13th of March 1845, in London, while attending a meeting of the council of the Royal Society, of which he became a fellow in 1813 and foreign secretary in 1839.

**DANIELL, THOMAS** (1749-1840), English landscape painter, was born at the Chertsey inn, kept by his father, in 1749, and apprenticed to an heraldic painter. Daniell, however, was animated with a love of the romantic and beautiful in architecture and nature. Up to 1784 he painted topographical subjects and flower pieces. By this time his two nephews (see below) had come under his influence, the younger, Samuel, being apprenticed to Medland the landscape engraver, and the elder, William, being under his own care. In this year (1784) he embarked for India accompanied by William, and found at Calcutta ample encouragement. Here he remained ten years, and on returning to London he published his largest work, *Oriental Scenery*, in six large volumes, not completed till 1808. From 1795 till 1828 he continued to exhibit Eastern subjects, temples, jungle hunts, &c., and at the same time continued the publication of illustrated works. These are—*Views of Calcutta*; *Oriental Scenery*, 144 plates; *Views in Egypt*; *Excavations at Ellora*; *Picturesque Voyage to China*. These were for the most part executed in aquatint. He was elected an Academician in 1799, fellow of the Royal Society about the same time, and at different times member of several minor societies. His nephews both died before him; his Indian period had made him independent, and he lived a bachelor life in much respect at Kensington till his death on the 19th of March 1840.

**WILLIAM DANIELL** (1769-1837), his nephew, was fourteen when he accompanied his uncle to India. His own publications, engraved in aquatint, were—*Voyage to India*; *Zoography*; *Animated Nature*; *Views of London*; *Views of Bootan*, a work prepared from his uncle's sketches; and a *Voyage Round Great Britain*, which occupied him several years. The British Institution made him an award of £100 for a "Battle of Trafalgar," and he was elected R.A. in 1822. He turned to panorama painting before his death, beginning in 1832 with Madras, the picture being enlivened by a representation of the Hindu mode of taming wild elephants.

**SAMUEL DANIELL**, William's younger brother, was brought up as an engraver, and first appears as an exhibitor in 1792. A few years later he went to the Cape and travelled into the interior of Africa, with his sketching materials in his haversack. The drawings he made there were published, after his return, in his *African Scenery*. He did not rest long at home, but left for Ceylon in 1806, where he spent the remaining years of his life, publishing *The Scenery, Animals and Natives of Ceylon*.

**DANNAT, WILLIAM T.** (1853- ), American artist, was born in New York city in 1853. He was a pupil of the Royal Academy of Munich and of Munkacsy, and became an accomplished draughtsman and a distinguished figure and portrait painter. He early attracted attention with sketches and pictures made in Spain, and a large composition, "The Quartette," now in the Metropolitan Museum of Art, New York, was one of the successes of the Paris Salon of 1884. Dannat settled in Paris,

became an officer of the Legion of Honour, and is represented in the Luxembourg.

**DANNECKER, JOHANN HEINRICH VON** (1758-1841), German sculptor, was born at Stuttgart, where his father was employed in the stables of the duke of Württemberg, on the 15th of October 1758. The boy was entered in the military school at the age of thirteen, but after two years he was allowed to take his own taste for art. We find him at once associating with the young sculptors Scheffauer and Le Jeune, the painters Guibal and Harper, and also with Schiller, and the musician Zumsteeg. His busts of some of these are good; that of Schiller is well known. In his eighteenth year he carried off the prize at the Concours with his model of Milo of Crotona. On this the duke made him sculptor to the palace (1780), and for some time he was employed on child-angels and caryatides for the decoration of the reception rooms. In 1783 he left for Paris with Scheffauer, and placed himself under Pajou. His Mars, a sitting figure sent home to Stuttgart, marks this period; and we next find him, still travelling with his friend, at Rome in 1785, where he settled down to work hard for five years. Goethe and Herder were then in Rome and became his friends, as well as Canova, who was the hero of the day, and who had undoubtedly a great authoritative influence on his style. His marble statues of Ceres and Bacchus were done at this time. These are now in the Residenz-schloss, at Stuttgart. On his return to Stuttgart, which he never afterwards quitted except for short trips to Paris, Vienna and Zürich, the double influence of his admiration for Canova and his study of the antique is apparent in his works. The first was a girl lamenting her dead bird, which pretty light motive was much admired. Afterwards, Sappho, in marble for the Lustschloss, and two offering-bearers for the Jagdschloss; Hector, now in the museum, not in marble; the complaint of Ceres, from Schiller's poem; a statue of Christ, worthy of mention for its nobility, which has been skilfully engraved by Amsler; Psyche; kneeling water-nymph; Love, a favourite he had to repeat. These stock subjects with sculptors had freshness of treatment; and the Ariadne, done a little later, especially had a charm of novelty which has made it a European favourite in a reduced size. It was repeated for the banker Von Bethmann in Frankfort, and it now appears the ornament of the Bethmann Museum. Many of the illustrious men of the time were modelled by him. The original marble of Schiller is now at Weimar; after the poet's death it was again modelled in colossal size. Lavater, Metternich, Countess Stephanie of Baden, General Benkendorf and others are much prized. Dannecker was director of the Gallery of Stuttgart, and received many academic and other distinctions. His death in 1841 was preceded by a period of mental failure.

**DANNEWERK, or DANEWERK** (Danish, *Dannevirke* or *Danevirke*, "Danes' rampart"), the ancient frontier rampart of the Danes against the Germans, extending 10½ m. from just south of the town of Schleswig to the marshes of the river Trene near the village of Hollingstedt. The rampart was begun by Godefrid (Godefridus), king of Vestfold, early in the 9th century. In 934 it was passed by the German king Henry I., after which it was extended by King Harold Bluetooth (940-986), but was again stormed by the emperor Otto II. in 974. The chronicler Saxo Grammaticus mentions in his *Gesta Danorum* the "rampart of Jutland" (*Jutiae moenia*) as having been once more extended by Valdemar the Great (1157-1182), which has been cited among the proofs that Schleswig (*Sønderjylland*) forms an integral part of Jutland (*Manuel hist. de la question de Slesvig*, 1906). After the union of Schleswig and Holstein under the Danish crown, the Danevirke fell into decay, but in 1848 it was hastily strengthened by the Danes, who were, however, unable to hold it in face of the superiority of the Prussian artillery, and on the 23rd of April it was stormed. From 1850 onwards it was again repaired and strengthened at great cost, and was considered impregnable; but in the war of 1864 the Prussians turned it by crossing the Schlei, and it was abandoned by the Danes on the 6th of February without a blow. It was thereupon destroyed by the Prussians; in spite of which, however, a long line of imposing ruins still remains. The systematic excavation of these, begun in 1900, has

yielded some notable finds, especially of valuable runic inscriptions (F. de Jessen, *La Question de Slesvig*, pp. 25, 44-50, &c.).

See Lorenzen, *Dannevirke og Omegn* (2nd ed., Copenhagen, 1864); H. Handelmann, *Das Dannewerk* (Kiel, 1885); Philippsen and Sünksen, *Führer durch das Dannewerk* (Hamburg, 1903).

**DANSVILLE**, a village of Livingston county, New York, U.S.A., 49 m. S. of Rochester, on the Canaseraga Creek. Pop. (1890) 3758; (1900) 3633, of whom 417 were foreign-born; (1905, state census) 3908. The village is served by the Delaware, Lackawanna & Western, and the Dansville & Mount Morris railways. At Dansville is the Jackson Health Resort, a large sanatorium, with which a nurses' training school is connected. There is a public library. The village has large nurseries and vineyards, flour and paper mills, a large printing establishment, a foundry, and a shoe factory. Dansville, named in honour of Daniel P. Faulkner, was settled about 1800, and was incorporated in 1845.

**DANTE**, Dante (or Durante) Alighieri (1265-1321), the greatest of Italian poets, was born at Florence about the middle of May 1265. He was descended from an ancient family, but from one which at any rate for several generations had belonged to the burgher and not to the knightly class. His biographers have attempted on very slight grounds to deduce his origin from the Frangipani, one of the oldest senatorial families of Rome. We can affirm with greater certainty that he was connected with the Elisei who took part in the building of Florence under Charles the Great. Dante himself does not, with the exception of a few obscure and scattered allusions, carry his ancestry beyond the warrior Cacciaguida, whom he met in the sphere of Mars (*Par.* xv. 87, foll.). Of Cacciaguida's family nothing is known. The name, as he told Dante (*Par.* xv. 139, 5), was given him at his baptism; it has a Teutonic ring. The family may well have sprung from one of the barons who, as Villani tells us, remained behind Otto I. It has been noted that the phrase "Tonde venner quivi" (xvi. 44) seems to imply that they were not Florentines. He further tells his descendant that he was born in the year 1106 (or, if another reading of i. 37, 38 be adopted, in 1091), and that he married an Aldighieri from the valley of the Po. Here the German strain appears unmistakably; the name Aldighiero (Aldiger) being purely Teutonic. He also mentions two brothers, Moronte and Eliseo, and that he accompanied the emperor Conrad III. upon his crusade into the Holy Land, where he died (1147) among the infidels. From Eliseo was probably descended the branch of the Elisei; from Aldighiero, son of Cacciaguida, the branch of the Alighieri. Bellincione, son of Aldighiero, was the grandfather of Dante. His father was a second Aldighiero, a lawyer of some reputation. By his first wife, Lapa di Chiarissimo Cialuffi, this Aldighiero had a son Francesco; by his second, Donna Bella, whose family name is not known, Dante and a daughter. Thus the family of Dante held a most respectable position among the citizens of his beloved city; but had it been reckoned in the very first rank they could not have remained in Florence after the defeat of the Guelphs at Montaperti in 1260. It is clear, however, that Dante's mother at least did so remain, for Dante was born in Florence in 1265. The heads of the Guelph party did not return till 1267.

Dante was born under the sign of the twins, "the glorious stars pregnant with virtue, to whom he owes his genius such as it is." Astrologers considered this constellation as favourable to literature and science, and Brunetto Latini, the philosopher and diplomatist, his instructor, tells him in the *Inferno* (xv. 25, foll.) that, if he follows its guidance, he cannot fail to reach the harbour of fame. Boccaccio relates that before his birth his mother dreamed that she lay under a very lofty laurel, growing in a green meadow, by a very clear fountain, when she felt the pangs of childbirth,—that her child, feeding on the berries which fell from the laurel, and on the waters of the fountain, in a very short time became a shepherd, and attempted to reach the leaves of the laurel, the fruit of which had nurtured him,—that, trying to obtain them he fell, and rose up, no longer a man, but in the guise of a peacock. We know little of Dante's boyhood except that he was a hard student and was profoundly influenced by

Brunetto Latini. Boccaccio tells us that he became very familiar with Virgil, Horace, Ovid and Statius, and all other famous poets. From the age of eighteen he, like most cultivated young men of that age, wrote poetry assiduously, in the philosophical amatory style of which his friend, older by many years than himself, Guido Cavalcanti, was a great exponent, and of which Dante regarded Guido Guinicelli of Bologna as the master (*Purg.* xxvi. 97, 8). Leonardo Bruni of Arezzo, writing a hundred years or more after his death, says that "by study of philosophy, of theology, astrology, arithmetic and geometry, by reading of history, by the turning over many curious books, watching and sweating in his studies, he acquired the science which he was to adorn and explain in his verses." Of Brunetto Latini Dante himself speaks with the most loving gratitude and affection, though he does not hesitate to brand his vices with infamy. Under such guidance Dante became master of all the science of his age at a time when it was not impossible to know all that could be known. He had some knowledge of drawing; at any rate he tells us that on the anniversary of the death of Beatrice he drew an angel on a tablet. He was an intimate friend of Giotto, who has immortalized his youthful lineaments in the chapel of the Bargello, and who is recorded to have drawn from his friend's inspiration the allegories of Virtue and Vice which fringe the frescoes of the Scrovegni Chapel at Padua. Nor was he less sensible to the delights of music. Milton had not a keener ear for the loud uplifted angel trumpets and the immortal harps of golden wires of the cherubim and seraphim; and the English poet was proud to compare his own friendship with Henry Lawes with that between Dante and Casella, "met in the milder shades of purgatory." Of his companions the most intimate and sympathetic were the lawyer-poet Cino of Pistoia, Lapo Gianni, Guido Cavalcanti and others, similarly gifted and dowered with like tastes, who moved in the lively and acute society of Florence, and felt with him the first warm flush of the new spirit which was soon to pass over Europe. He has written no sweeter or more melodious lines than those in which he expresses the wish that he, with Guido and Lapo, might be wafted by enchantment over the sea wheresoever they might list, shielded from tempest and foul weather, in such contentment that they should wish to live always in one mind, and that the good enchanter should bring Monna Vanna and Monna Bice and that other lady into their barque, where they should for ever discourse of love and be for ever happy. It is a wonderful thing (says Leonardo Bruni) that, though he studied without intermission, it would not have appeared to anyone that he studied, from his joyous mien and youthful conversation. Like Milton he was trained in the strictest academical education which the age afforded; but Dante lived under a warmer sun and brighter skies, and found in the rich variety and gaiety of his early life a defence against the withering misfortunes of his later years. Milton felt too early the chill breath of Puritanism, and the serious musing on the experience of life, which saddened the verse of both poets, deepened in his case rather into grave and desponding melancholy, than into the fierce scorn and invective which disillusion wrung from Dante.

We must now consider the political circumstances in which lay the activity of Dante's manhood. From 1115, the year of

*Political life.*

the death of Matilda countess of Tuscany, to 1215, Florence enjoyed a nearly uninterrupted peace.

Attached to the Guelph party, it remained undivided against itself. But in 1215 a private feud between the families of Buondelmonte and Uberti introduced into the city the horrors of civil war. Villani (lib. v. cap. 38) relates how Buondelmonte de' Buondelmonti, a noble youth of Florence, being engaged to marry a lady of the house of Amidei, allied himself instead to a Donati, and how Buondelmonte was attacked and killed by the Amidei and Uberti at the foot of the Ponte Vecchio, close by the pilaster which bears the image of Mars. "The death of Messer Buondelmonte was the occasion and beginning of the accursed parties of Guelphs and Ghibellines in Florence." Of the seventy-two families then in Florence thirty-nine became Guelph under the leadership of the Buondelmonte and the rest Ghibelline under the Uberti. The strife of parties was for a while allayed

by the war against Pisa in 1222, and the constant struggles against Siena; but in 1248 Frederick II. sent into the city his natural son Frederick "of Antioch," with 1600 German knights. The Guelphs were driven away from the town, and took refuge, part in Montevarchi, part in Capraia. The Ghibellines, masters of Florence, behaved with great severity, and destroyed the towers and palaces of the Guelph nobles. At last the people became impatient. They rose in rebellion, reduced the powers of the podestà, elected a captain of the people to manage the internal affairs of the city, with a council of twelve, established a more democratic constitution, and, encouraged by the death of Frederick II. in December 1250, recalled the exiled Guelphs. Manfred, the bastard son of Frederick, pursued the policy of his father. He stimulated the Ghibelline Uberti to rebel against their position of subjection. A rising of the vanquished party was put down by the people, in July 1258 the Ghibellines were expelled from the town, and the towers of the Uberti razed to the ground. The exiles betook themselves to the friendly city of Siena. Manfred sent them a reinforcement of German horse, under his kinsman Count Giordano Lancia. The Florentines, after vainly demanding their surrender, despatched an army against them. On the 4th of September 1260 was fought the great battle of Montaperti, which dyed the Arbia red, and in which the Guelphs were entirely defeated. The hand which held the banner of the republic was sundered by the sword of a traitor (*Inf.* xxxii. 106). For the first time in the history of Florence the Carroccio was taken. Florence lay at the mercy of her enemies. A parliament was held at Empoli, in which the deputies of Siena, Pisa, Arezzo and other Tuscan towns consulted on the best means of securing their new war power. They voted that the accursed Guelph city should be blotted out. But Farinata degli Uberti stood up in their midst, bold and defiant as when he stood erect among the sepulchres of hell, and said that if, from the whole number of the Florentines, he alone should remain, he would not suffer, whilst he could wield a sword, that his country should be destroyed, and that, if it were necessary to die a thousand times for her, a thousand times would he be ready to encounter death. Help came to the Guelphs from an unexpected quarter. Clement IV., elected pope in 1265, offered the crown of Apulia and Sicily to Charles of Anjou. The French prince, passing rapidly through Lombardy, Romagna and the Marches, reached Rome by way of Spoleto, was crowned on the 6th of January 1266, and on the 23rd of February defeated and killed Manfred at Benevento. In such a storm of conflict did Dante first see the light. In 1267 the Guelphs were recalled, but instead of settling down in peace with their opponents they summoned Charles of Anjou to vengeance, and the Ghibellines were driven out. The meteor passage of Conradin gave hope to the imperial party, which was quenched when the head of the fair-haired boy fell on the scaffold at Naples. Pope after pope tried in vain to make peace. Gregory X. placed the rebellious city under an interdict; in 1278 Cardinal Latini by order of Nicholas III. effected a truce, which lasted for four years. The city was to be governed by a committee of fourteen *buonomini*, on which the Guelphs were to have a small majority. In 1282 the constitution of Florence received the final form which it retained till the collapse of freedom. From the three *arti maggiori* were chosen six priors, in whose hands was placed the government of the republic. Before the end of the century, seven greater arts were recognized, including the *speziali*,—druggists and dealers in all manner of oriental goods, and in books—among whom Dante afterwards enrolled himself. They remained in office for two months, and during that time lived and shared a common table in the public palace. We shall see what influence this office had upon the fate of Dante. The success of the "Sicilian Vespers" (March 1282), the death of Charles of Anjou (January 1285), and of Martin IV. in the following March, roused again the courage of the Ghibellines. They entered Arezzo, where the Ghibellines at present had the upper hand, and threatened to drive out the Guelphs from Tuscany. Skirmishes and raids, of which Villani and Bruni have left accounts, went on through the winter of 1288–1289, forming a prelude to the great

battle of Campaldino in the following summer. Then it was that Dante saw "horsemen moving camp and commencing the assault, and holding muster, and the march of foragers, the shock of tournaments, and race of jousts, now with trumpets and now with bells, with drums and castle signals, with native things and foreign" (*Inf.* xxii. 1, foll.). On the 11th of June 1289, at Campaldino near Poppi, in the Casentino, the Ghibellines were utterly defeated. They never again recovered their hold on Florence, but the violence of faction survived under other names. In a letter quoted, though not at first hand, by Leonardo Bruni, which is not now extant, Dante is said to mention that he himself fought with distinction at Campaldino. He was present shortly afterwards at the battle of Caprona (*Inf.* xxi. 95, foll.), and returned in September 1289 to his studies and his love. His peace was of short duration. On the 9th of June 1290 died Beatrice, whose mortal love had guided him for thirteen years, and whose immortal spirit purified his later life, and revealed to him the mysteries of Paradise.

Dante had first met Beatrice Portinari at the house of her father Folco on May-day 1274. In his own words, "already nine times after my birth the heaven of light had returned as it were to the same point, when there appeared to my eyes the glorious lady of my mind, who was by many called Beatrice who knew not what to call her. She had already been so long in this life that already in its time the starry heaven had moved towards the east the twelfth part of a degree, so that she appeared to me about the beginning of her ninth year, and I saw her about the end of my ninth year. Her dress on that day was of a most noble colour, a subdued and goodly crimson, girdled and adorned in such sort as best suited with her tender age. At that moment I saw most truly that the spirit of life which hath its dwelling in the secretest chamber of the heart began to tremble so violently that the least pulses of my body shook therewith; and in trembling it said these words, 'Ecce deus fortior me qui veniens dominabitur mihi.'" In the *Vita Nuova* is written the story of his passion from its commencement to within a year after the lady's death (June 9th, 1290). He saw Beatrice only once or twice, and she probably knew little of him. She married Simone de' Bardi. But the worship of her lover was stronger for the remoteness of its subject. The last chapter of the *Vita Nuova* relates how, after the lapse of a year, "it was given me to behold a wonderful vision, wherein I saw things which determined me to say nothing further of this blessed one until such time as I could discourse more worthily concerning her. And to this end I labour all I can, as she in truth knoweth. Therefore if it be His pleasure through whom is the life of all things that my life continue with me a few years, it is my hope that I shall yet write concerning her what hath not before been written of any woman. After the which may it seem good unto Him who is the master of grace that my spirit should go hence to behold the glory of its lady, to wit, of that blessed Beatrice who now gloriously gazes on the countenance of Him qui est per omnia saecula benedictus." In the *Convito* he resumes the story of his life. "When I had lost the first delight of my soul (that is, Beatrice) I remained so pierced with sadness that no comforts availed me anything, yet after some time my mind, desirous of health, sought to return to the method by which other disconsolate ones had found consolation, and I set myself to read that little-known book of Boetius in which he consoled himself when a prisoner and an exile. And hearing that Tully had written another work, in which, treating of friendship, he had given words of consolation to Laelius, I set myself to read that also." He so far recovered from the shock of his loss that in 1292 he married Gemma, daughter of Manetto Donati, a connexion of the celebrated Corso Donati, afterwards Dante's bitter foe. It is possible that she is the lady mentioned in the *Vita Nuova* as sitting full of pity at her window and comforting Dante for his sorrow. By this wife he had two sons and two daughters, and although he never mentions her in the *Divina Commedia*, and although she did not accompany him into exile, there is no reason to suppose that she was other than a good wife, or that the union was otherwise than happy. Certain it is that he spares the memory of Corso in his great poem, and speaks kindly of his kinsmen Piccarda and Forese.

In 1293 Giano della Bella, a man of old family who had thrown in his lot with the people, induced the commonwealth to adopt the so-called "Ordinances of Justice," a severely democratic constitution, by which among other things it was enacted that no man of noble family, even though engaged in trade, could hold office as prior. Two years later Giano was banished, but the ordinances remained in force, though the *grandi* recovered much of their power.

Dante now began to take an active part in politics. He was inscribed in the *arte* of the *Medici* and *Speziali*, which made him eligible as one of the six *priori* to whom the government of the city was entrusted in 1282. Documents still existing in the archives of Florence show that he took part in the deliberations of the several councils of the city in 1295, 1296, 1300 and 1301. The notice in the last year is of some importance. The pope had demanded a contingent of 100 Florentine knights to serve against his enemies, the Colonna family. On the 19th of June we read in the contemporary report of the debate on this question in the Council of a Hundred: "*Dantes Alagherius consuluit quod de servitio faciendo Domino Papae nihil feret.*" Other instances of his invariable opposition to Boniface occur. Filelfo says that he served on fourteen embassies, a statement not only unsupported by evidence, but impossible in itself. Filelfo does not mention the only embassy in which we know for certain that Dante was engaged, that to the town of San Gimignano in May 1300. From the 15th of June to the 15th of August 1300 he held the office of prior, which was the source of all the miseries of his life. The spirit of faction had again broken out in Florence. The two rival families were the Cerchi and the Donati,—the first of great wealth but recent origin, the last of ancient ancestry but poor. A quarrel had arisen in Pistoia between the two branches of the Cancellieri,—the Bianchi and Neri, the Whites and the Blacks. The quarrel spread to Florence, the Donati took the side of the Blacks, the Cerchi of the Whites. Pope Boniface was asked to mediate, and sent Cardinal Matteo d'Acquasparta to maintain peace. He arrived just as Dante entered upon his office as prior. The cardinal effected nothing, but Dante and his colleagues banished the heads of the rival parties in different directions to a distance from the capital. The Blacks were sent to Città della Pieve in the Tuscan mountains; the Whites, among whom was Dante's dearest friend Guido Cavalcanti, to Serrezzano in the unhealthy Maremma. After the expiration of Dante's office both parties returned, Guido Cavalcanti so ill with fever that he shortly afterwards died. At a meeting held in the church of the Holy Trinity the Whites were denounced as Ghibellines, enemies of the pope. The Blacks sought for vengeance. Their leader, Corso Donati, hastened to Rome, and persuaded Boniface VIII. to send for Charles of Valois, brother of the French king, Philip the Fair, to act as "peacemaker." The priors sent at the end of September four ambassadors to the pope, one of whom, according to the chronicler Dino, was Dante. There are, however, improbabilities in the story, and the passage quoted in support of it bears marks of later interpolation. He never again saw the towers of his native city. Charles of Valois, after visiting the pope at Anagni, retraced his steps to Florence, entering the city on All Saints' Day and taking up his abode in the Oltr' Arno. Corso Donati, who had been banished a second time, returned in force and summoned the Blacks to arms. The prisons were broken open, the podestà driven from the town, the Cerchi confined within their houses, a third of the city was destroyed with fire and sword. By the help of Charles the Blacks were victorious. They appointed Cante de' Gabrielli of Gubbio as podestà, a man devoted to their interests. More than 600 Whites were condemned to exile and cast as beggars upon the world. On the 27th of January 1302, Dante, with four others of the White party, was charged before the podestà, Cante de' Gabrielli, with *baratteria*, or corrupt jobbery and peculation when in office, and, not appearing, condemned to pay a fine of 5000 lire of small florins. If the money was not paid within three days their property was to be destroyed and laid waste; if they did pay the fine they were to be exiled for two years from Tuscany; in any case they were never again to hold office in the

republic. The charge in Dante's case was obviously preposterous, though ingeniously devised; for he was known to be at the time in somewhat straitened circumstances, and had recently been in control of certain public works. But of all sins, that of "barratry" was one of the most hateful to him. No doubt the papal finger may be traced in the affair. On the 10th of March Dante and fourteen others were condemned to be burned alive if they should come into the power of the republic. Similar sentences were passed in September 1311 and October 1315. The sentence was not formally reversed till 1494, under the government of the Medici.

Leonardo Bruni, who accepts the story of the embassy to Rome, states that Dante received the news of his banishment in that city, and at once joined the other exiles at Siena. How he escaped arrest in the papal states is not explained. The exiles met first at Gargonza, a castle between Siena and Arezzo, and then at Arezzo itself. They joined themselves to the Ghibellines, to which party the podestà Uguccione della Faggiuola belonged. The Ghibellines, however, were divided amongst themselves, and the more strict Ghibellines were not disposed to favour the cause of the White Guelphs. On the 8th of June 1302, however, a meeting was held at San Godenzo, a place in the Florentine territory, Dante's presence at which is proved by documentary evidence, and an alliance was there made with the powerful Ghibelline clan of the Ubaldini. The exiles remained at Arezzo till the summer of 1304. In September 1303 the fleur-de-lis had entered Anagni, and Christ had a second time been made prisoner in the person of his vicar. At the instigation of Philip the Fair, William of Nogaret and Sciarra Colonna had entered the papal palace at Anagni, and had insulted and, it is said, even beaten the aged pontiff under his own roof. Boniface did not survive the insult long, but died in the following month. He was succeeded by Benedict XI., and in March the cardinal da Prato came to Florence, sent by the new pope to make peace. The people received him with enthusiasm; ambassadors came to him from the Whites; and he did his best to reconcile the two parties. But the Blacks resisted all his efforts. He shook the dust from off his feet, and departed, leaving the city under an interdict. Foiled by the calumnies and machinations of the one party, the cardinal gave his countenance to the other. It happened that Corso Donati and the heads of the Black party were absent at Pistoia. Da Prato advised the Whites to attack Florence, deprived of its heads and impaired by a recent fire. An army was collected of 16,000 foot and 9000 horse. Communications were opened with the Ghibellines of Bologna and Romagna, and a futile attempt was made to enter Florence from Lastra, the failure of which further disorganized the party. Dante had, however, already separated from the "ill-conditioned and foolish company" of common party-politicians, who rejected his counsels of wisdom, and had learnt that he must henceforth form a party by himself. In 1303 he had left Arezzo and gone to Forlì in Romagna, of which city Scarpetta degli Ordelaffi was lord. To him, according to Flavius Blondus the historian (d. before 1484), a native of the place, Dante acted for a time as secretary.

From Forlì Dante probably went to Bartolommeo della Scala, lord of Verona, where the country of the great Lombard gave him his first refuge and his first hospitable reception. Can Grande, to whom he afterwards dedicated the *Paradiso*, was then a boy. Bartolommeo died in 1304, and it is possible that Dante may have remained in Verona till his death.

We must consider, if we would understand the real nature of Dante's Ghibellinism, that he had been born and bred a Guelph; but he saw that the conditions of the time were altered, and that other dangers menaced the welfare of his country. There was no fear now that Florence, Siena, Pisa, Arezzo should be razed to the ground in order that the castle of the lord might overlook the humble cottages of his contented subjects; but there was danger lest Italy should be torn in sunder by its own jealousies and passions, and lest the fair domain bounded by the sea and the Alps should never properly assert the force of its individuality, and should present a contemptible contrast to a united France and a confederated

Germany. Sick with petty quarrels and dissensions, Dante strained his eyes towards the hills for the appearance of a universal monarch, raised above the jars of faction and the spur of ambition, under whom each country, each city, each man, might, under the institutions best suited to it, lead the life and do the work for which it was best fitted. United in spiritual harmony with the vicar of Christ, he should show for the first time to the world an example of a government where the strongest force and the highest wisdom were interpenetrated by all that God had given to the world of piety and justice. In this sense and in no other was Dante a Ghibelline. The vision was never realized—the hope was never fulfilled. Not till 500 years later did Italy become united and the "greyhound of deliverance" chase from city to city the wolf of cupidity. But is it possible to say that the dream did not work its own realization, or to deny that the high ideal of the poet, after inspiring a few minds as lofty as his own, has become embodied in the constitution of a state which acknowledges no stronger bond of union than a common worship of the exile's indignant and impassioned verse?

It is very difficult to determine with exactness the order and the place of Dante's wanderings. Many cities and castles in Italy have claimed the honour of giving him shelter, or of being for a time the home of his inspired muse. He certainly spent some time with Count Guido Salvatico in the Casentino near the sources of the Arno, probably in the castle of Porciano, and with Uguccione in the castle of Faggiuola in the mountains of Urbino. After this he is said to have visited the university of Bologna; and in August 1306 we find him at Padua. Cardinal Napoleon Orsini, the legate of the French pope Clement V., had put Bologna under a ban, dissolved the university, and driven the professors to the northern city. In May or June 1307 the same cardinal collected the Whites at Arezzo and tried to induce the Florentines to recall them. The name of Dante is found attached to a document signed by the Whites in the church of St Gaudenzio in the Mugello. This enterprise came to nothing. Dante retired to the castle of Morello Malespina in the Lunigiana, where the marble ridges of the mountains of Carrara descend in precipitous slopes to the Gulf of Spezzia. From this time till the arrival of the emperor Henry VII. in Italy, October 1310, all is uncertain. His old enemy Corso Donati had at last allied himself with Uguccione della Faggiuola, the leader of the Ghibellines. Dante thought it possible that this might lead to his return. But in 1308 Corso was declared a traitor, attacked in his house, put to flight and killed. Dante lost his last hope. He left Tuscany, and went to Can Grande della Scala at Verona. From this place it is thought that he visited the university of Paris (1309), studied in the rue du Fouarre and went on into the Low Countries. That he ever crossed the Channel or went to Oxford, or himself saw where the heart of Henry, son of Richard, earl of Cornwall, murdered by his cousin Guy of Montfort in 1271, was "still venerated on the Thames," may safely be disbelieved. The only evidence for it is in the *Commentary* of John of Serravalle, bishop of Fermo, who lived a century later, had no special opportunity of knowing, and was writing for the benefit of two English bishops. The election in 1308 of Henry of Luxemburg as emperor stirred again his hopes of a deliverer. At the end of 1310, in a letter to the princes and people of Italy, he proclaimed the coming of the saviour; at Milan he did personal homage to his sovereign. The Florentines made every preparation to resist the emperor. Dante wrote from the Casentino a letter dated the 31st of March 1311, in which he rebuked them for their stubbornness and obstinacy. Henry still lingered in Lombardy at the siege of Cremona, when Dante, on the 16th of April 1311, in a celebrated epistle, upbraided his delay, argued that the crown of Italy was to be won on the Arno rather than on the Po, and urged the tarrying emperor to hew the rebellious Florentines like Agag in pieces before the Lord. Henry was as deaf to this exhortation as the Florentines themselves. After reducing Lombardy he passed from Genoa to Pisa, and on the 29th of June 1312 was crowned by some cardinals in the church of St John Lateran at Rome; the Vatican being in the hands of his adversary King Robert of Naples. Then at length he moved towards

*Dante's  
Ghibel-  
linism.*

*Wander-  
ings.*



Tuscany by way of Umbria. Leaving Cortona and Arezzo, he reached Florence on the 19th of September. He did not dare to attack it, but returned in November to Pisa. In the summer of the following year he prepared to invade the kingdom of Naples; but in the neighbourhood of Siena he caught a fever and died at the monastery of Buonconvento, on the 24th of August 1313. He lies in the Campo Santo of Pisa; and the hopes of Dante and his party were buried in his grave.

After the death of the emperor Henry (Bruni tells us) Dante passed the rest of his life as an exile, sojourning in various places throughout Lombardy, Tuscany and the Romagna, under the protection of various lords, until at length he retired to Ravenna, where he ended his life. Very

*Old age  
and death.*

little can be added to this meagre story. There is reason for supposing that he stayed at Gubbio with Bosone dei Rafaelli, and tradition assigns him a cell in the monastery of Sta Croce di Fonte Avellana in the same district, situated on the slopes of Catria, one of the highest peaks of the Apennines in that region. After the death of the French pope, Clement V., he addressed a letter, dated the 14th of July 1314, to the cardinals in conclave, urging them to elect an Italian pope. About this time he came to Lucca, then lately conquered by his friend Ugucione. Here he completed the last cantos of the *Purgatory*, which he dedicated to Ugucione, and here he must have become acquainted with Gentucca, whose name had been whispered to him by her countryman on the slopes of the Mountain of Purification (*Purg.* xxiv. 37). That the intimacy between the "world-worn" poet and the young married lady (who is thought to be identifiable with Gentucca Morla, wife of one Cosciorino Fondora) was other than blameless, is quite incredible. In August 1315 was fought the battle of Monte Catini, a day of humiliation and mourning for the Guelphs. Ugucione made but little use of his victory; and the Florentines marked their vengeance on his adviser by condemning Dante yet once again to death if he ever should come into their power. In the beginning of the following year Ugucione lost both his cities of Pisa and Lucca. At this time Dante was offered an opportunity of returning to Florence. The conditions given to the exiles were that they should pay a fine and walk in the dress of humiliation to the church of St John, and there do penance for their offences. Dante refused to tolerate this shame; and the letter is still extant in which he declines to enter Florence except with honour, secure that the means of life will not fail him, and that in any corner of the world he will be able to gaze at the sun and the stars, and meditate on the sweetest truths of philosophy. He preferred to take refuge with his most illustrious protector Can Grande della Scala of Verona, then a young man of twenty-five, rich, liberal and the favoured head of the Ghibelline party. His name has been immortalized by an eloquent panegyric in the seventeenth canto of the *Paradiso*. Whilst on a visit at the court of Verona he maintained, on the 20th of January 1320, the philosophical thesis *De aqua et terra*, on the levels of land and water, which is included in his minor works. The last three years of his life were spent at Ravenna, under the protection of Guido da Polenta. In his service Dante undertook an embassy to the Venetians. He failed in the object of his mission, and, returning disheartened and broken in spirit through the unhealthy lagoons, caught a fever and died in Ravenna on the 14th of September 1321. His bones still repose there. His doom of exile has been reversed by the union of Italy, which has made the city of his birth and the various cities of his wanderings component members of a common country. His son Piero, who wrote a commentary on the *Divina Commedia*, settled as a lawyer in Verona, and died in 1364. His daughter Beatrice lived as a nun in Ravenna, dying at some time between 1350 (when Boccaccio brought her a present of ten gold crowns from a Florentine gild) and 1370. His direct line became extinct in 1509.

*Dante's Works.*—Of Dante's works, that by which he is known to all the educated world, and in virtue of which he holds his place as one of the half-dozen greatest writers of all time, is of course the *Commedia*. (The epithet *divina*, it may be noted, was not given to the poem by its author, nor does it appear on a title-page until 1555, in the

*Divina  
Commedia.*

edition of Ludovico Dolce, printed by Giolito; though it is applied to the poet himself as early as 1512.) The poem is absolutely unique in literature; it may safely be said that at no other epoch of the world's history could such a work have been produced. Dante was steeped in all the learning, which in its way was considerable, of his time; he had read the *Summa Theologica* of Aquinas, the *Trésor* of his master Brunetto, and other encyclopaedic works available in that age; he was familiar with all that was then known of the Latin classical and post-classical authors. Further, he was a deep and original political thinker, who had himself borne a prominent part in practical politics. He was born into a generation in which almost every man of education habitually wrote verse, as indeed their predecessors had been doing for the last fifty years. Vernacular poetry had come late into Italy, and had hitherto, save for a few didactic or devotional treatises hitched into rough rhyme, been exclusively lyric in form. Amatory at first, later, chiefly in the hands of Guittone of Arezzo and Guido Cavalcanti, taking an ethical and metaphysical tone, it had never fully shaken off the Provençal influence under which it had started, and of which Dante himself shows considerable traces.

The age also was unique, though the two great events which made the 15th century a turning-point in the world's history—the invention of printing and the discovery of the new world (to which might perhaps be added the intrusion of Islam into Europe)—were still far in the future. But the age was essentially one of great men; of free thought and free speech; of brilliant and daring action, whether for good or evil. It is easy to understand how Dante's bitterest scorn is reserved for those "sorry souls who lived without infamy and without renown, displeasing to God and to His enemies."

The time was thus propitious for the production of a great imaginative work, and the man was ready who should produce it. It called for a prophet, and the prophet said, "Here am I." "Dante," says an acute writer, "is not, as Homer is, the father of poetry springing in the freshness and simplicity of childhood out of the arms of mother earth; he is rather, like Noah, the father of a second poetical world, to whom he pours forth his prophetic song fraught with the wisdom and the experience of the old world." Thus the *Commedia*, though often classed for want of a better description among epic poems, is totally different in method and construction from all other poems of that kind. Its "hero" is the narrator himself; the incidents do not modify the course of the story; the place of episodes is taken by theological or metaphysical disquisitions; the world through which the poet takes his readers is peopled, not with characters of heroic story, but with men and women known personally or by repute to him and those for whom he wrote. Its aim is not to delight, but to reprove, to rebuke, to exhort; to form men's characters by teaching them what courses of life will meet with reward, what with penalty, hereafter; "to put into verse," as the poet says, "things difficult to think." For such new matter a new vehicle was needed. We have Bembo's authority for believing that the *terza rima*, surpassed, if at all, only by the ancient hexameter, as a measure equally adaptable to sustained narrative, to debate, to fierce invective, to clear-cut picture and to trenchant epigram, was first employed by Dante.

The action of the *Commedia* opens in the early morning of the Thursday before Easter, in the year 1300. The poet finds himself lost in a forest, escaping from which he has his way barred by a wolf, a lion and a leopard. All this, like the rest of the poem, is highly symbolical. This branch of the subject is too vast to be entered on at any length here; but so far as this passage is concerned it may be said that it seems to indicate that at this period of his life, about the age of thirty-five, Dante went through some experience akin to what is now called "conversion." Having led up till then the ordinary life of a cultivated Florentine of good family; taking his part in public affairs, military and civil, as an hereditary member of the predominant Guelph party; dallying in prose which with all its beauty and passion is full of the conceits familiar to the 13th century, and in verse which save for the excellence of its execution differs in no way from that of his

predecessors, with the memory of his lost love; studying more seriously, perhaps, than most of his associates; possibly traveling a little,—gradually or suddenly he became convinced that all was not well with him, and that not by leading, however blamelessly, the “active” life could he save his soul. The strong vein of mysticism, found in so many of the deepest thinkers of that age, and conspicuous in Dante’s mind, no doubt played its part. His efforts to free himself from the “forest” of worldly cares were impeded by the temptations of the world—cupidity (including ambition), the pride of life and the lusts of the flesh, symbolized by the three beasts. But a helper is at hand. Virgil appears and explains that he has a commission from three ladies on high to guide him. The ladies are the Blessed Virgin, St Lucy (whom for some reason never yet explained Dante seems to have regarded as in a special sense his protector) and Beatrice. In Virgil we are apparently intended to see the symbol of what Dante calls philosophy, what we should rather call natural religion; Beatrice standing for theology, or rather revealed religion. Under Virgil’s escort Dante is led through the two lower realms of the next world, Hell and Purgatory; meeting on the way with many persons illustrious or notorious in recent or remoter times, as well as many well enough known then in Tuscany and the neighbouring states; but who, without the immortality, often unenviable, that the poet has conferred on them, would long ago have been forgotten. Popes, kings, emperors, poets and warriors, Florentine citizens of all degrees, are there found; some doomed to hopeless punishment, others expiating their offences in milder torments, and looking forward to deliverance in due time. It is remarkable to notice how rarely, if ever, Dante allows political sympathy or antagonism to influence him in his distribution of judgment. Hell is conceived as a vast conical hollow, reaching to the centre of the earth. It has three great divisions, corresponding to Aristotle’s three classes of vices, incontinence, brutishness and malice. The first are outside the walls of the city of Dis; the second, among whom are included unbelievers, tyrants, suicides, unnatural offenders, usurers, are within; the first apparently on the same level as those without, the rest separated from them by a steep descent of broken rocks. (It should be said that many Dante scholars hold that Aristotle’s “brutishness” has no place in Dante’s scheme; but the symmetry of the arrangement, the special reference made to that division, and certain expressions used elsewhere by Dante, seem to make it probable that he would here, as in most other cases, have followed his master in philosophy.) The sinners by malice, which includes all forms of fraud or treachery, are divided from the last by a yet more formidable barrier. They lie at the bottom of a pit, the depth of which is not stated, with vertical sides, and accessible only by supernatural means; a monster named Geryon bearing the poets down on his back. The torments here are of a more terrible, often of a loathsome character. Ignominy is added to pain, and the nature of Dante’s demeanour towards the sinners changes from pity to hatred. At the very bottom of the pit is Lucifer, immovably fixed in ice; climbing down his limbs they reach the centre of the earth, whence a cranny conducts them back to the surface, at the foot of the purgatorial mountain, which they reach as Easter Day is dawning. Before the actual Purgatory is attained they have to climb for the latter half of the day and rest at night. The occupants of this outer region are those who have delayed repentance till death was upon them. They include many of the most famous men of the last thirty years. In the morning the gate is opened, and Purgatory proper is entered. This is divided into seven terraces, corresponding to the seven deadly sins, which encircle the mountain and have to be reached by a series of steep climbs, compared by Dante in one instance to the path from Florence to Samminiato. The penalties are not degrading, but rather tests of patience or endurance; and in several cases Dante has to bear a share in them as he passes. On the summit is the Earthly Paradise. Here Beatrice appears, in a mystical pageant; Virgil departs, leaving Dante in her charge. By her he is led through the various spheres of which, according to both the astronomy and the theology of the time, Heaven is composed, to the supreme

Heaven, or Empyrean, the seat of the Godhead. For one moment there is granted him the intuitive vision of the Deity, and the comprehension of all mysteries, which is the ultimate goal of mystical theology; his will is wholly blended with that of God, and the poem ends.

The *Convito*, or *Banquet*, also called *Convivio* (Bembo uses the first form, Trissino the other), is the work of Dante’s manhood, as the *Vita Nuova* is the work of his youth. It consists, *Convito*. in the form in which it has come down to us, of an introduction and three treatises, each forming an elaborate commentary in a long canzone. It was intended, if completed, to have comprised commentaries on eleven more canzoni, making fourteen in all, and in this shape would have formed a *tesoro* or handbook of universal knowledge, such as Brunetto Latini and others have left to us. It is perhaps the least well known of Dante’s Italian works, but crabbed and unattractive as it is in many parts, it is well worth reading, and contains many passages of great beauty and elevation. Indeed a knowledge of it is quite indispensable to the full understanding of the *Divina Commedia* and the *De Monarchia*. The time of its composition is uncertain. As it stands it has very much the look of being the contents of note-books partially arranged. Dante mentions princes as living who died in 1309; he does not mention Henry VII. as emperor, who succeeded in 1310. There are some passages which seem to have been inserted at a later date. The canzoni upon which the commentary is written were probably composed between 1292 and 1300, when he was seeking in philosophy consolation for the loss of Beatrice. The *Convito* was first printed in Florence by Buonaccorsi in 1490. It has never been adequately edited.

The *Vita Nuova* (*Young Life* or *New Life*, for both significations seem to be intended) contains the history of his love for Beatrice. He describes how he met Beatrice as a child, himself a child, how he often sought her glance, how she once *Vita* greeted him in the street, how he feigned a false love *Nuova*. to hide his true love, how he felt ill and saw in a dream the death and transfiguration of his beloved, how she died, and how his health failed from sorrow, how the tender compassion of another lady nearly won his heart from its first affection, how Beatrice appeared to him in a vision and reclaimed his heart, and how at last he saw a vision which induced him to devote himself to study that he might be more fit to glorify her who gazes on the face of God for ever. This simple story is interspersed with sonnets, ballads and canzoni, arranged with a remarkable symmetry, to which Professor Charles Eliot Norton was the first to draw attention, chiefly written at the time to emphasize some mood of his changing passion. After each of these, in nearly every case, follows an explanation in prose, which is intended to make the thought and argument intelligible to those to whom the language of poetry was not familiar. The whole has a somewhat artificial air, in spite of its undoubted beauty; showing that Dante was still under the influence of the *Dugentisti*, many of whose conceits he reproduces. The book was probably completed by 1300. It was first printed by Sermartelli in Florence, 1576.

Besides the smaller poems contained in the *Vita Nuova* and *Convito* there are a considerable number of canzoni, ballate and sonnetti bearing the poet’s name. Of these many undoubtedly are genuine, others as undoubtedly *Canzo-* spurious. Some which have been preserved under the *niere*. name of Dante belong to Dante de Maiano, a poet of a harsher style; others which bear the name of Aldighiero are referable to Dante’s sons Jacopo or Pietro, or to his grandsons; others may be ascribed to Dante’s contemporaries and predecessors Cino da Pistoia and others. Those which are genuine secure Dante a place among lyrical poets scarcely if at all inferior to that of Petrarch. Most of these were printed in *Sonetti e canzoni* (Giunta, 1527). The best edition of the *Canzoniere* of Dante is that by Fraticelli published by Barbéra at Florence. His collection includes seventy-eight genuine poems, eight doubtful and fifty-four spurious. To these are added an Italian paraphrase of the seven penitential psalms in *tersa rima*, and a similar paraphrase of the Credo, the seven sacraments, the ten commandments, the Lord’s Prayer and the Ave Maria.

The Latin treatise *De monarchia*, in three books, contains the mature statement of Dante's political ideas. In it he propounds the theory that the supremacy of the emperor is derived from the supremacy of the Roman people over the world, which was given to them direct from God. As the emperor is intended to assure their earthly happiness, so does their spiritual welfare depend upon the pope, to whom the emperor is to do honour as to the first-born of the Father. The date of its publication is almost universally admitted to be the time of the descent of Henry VII. into Italy, between 1310 and 1313, although its composition may have been in hand from a much earlier period. The book was first printed by Oporinus at Basel in 1559, and placed on the Index of forbidden books.

The treatise *De vulgari eloquentia*, in two books, also in Latin, is mentioned in the *Convito*. Its object was first to establish the

Italian language as a literary tongue, and to distinguish the noble or "courtly" speech which might become the property of the whole nation, at once a bond of internal unity and a line of demarcation against external nations, from the local dialects peculiar to different districts; and secondly, to lay down rules for poetical composition in the language so established. The work was intended to be in four books, but only two are extant. The first of these deals with the language, the second with the style and with the composition of the canzone. The third was probably intended to continue this subject, and the fourth was destined to the laws of the ballata and sonetto. It contains much acute criticism of poetry and poetic diction. This work was first published in the Italian translation of Trissino at Vicenza in 1529. The original Latin was not published till 1577 at Paris by Jacopo Corbinelli, one of the Italians who were brought from Florence by Catherine de' Medici, from a MS. now preserved at Grenoble. The work was probably left unfinished in consequence of Dante's death.

Boccaccio mentions in his life of Dante that he wrote two eclogues in Latin in answer to Johannes de Virgilio, who invited him to come from Ravenna to Bologna and compose a great work in the Latin language. The most interesting passage in the work is that in the first poem, where he expresses his hope that when he has finished the three parts of his great poem his grey hairs may be crowned with laurel on the banks of the Arno. Although the Latin of these poems is superior to that of his prose works, we may feel thankful that Dante composed the great work of his life in his own vernacular. The versification, however, is good, and there are pleasant touches of gentle humour. The *Eclogues* have been edited by Messrs Wicksteed and Gardiner (*Dante and Giovanni del Virgilio*, London, 1902).

A treatise *De aqua et terra* has come down to us, which Dante tells us was delivered at Mantua in January 1320 (perhaps 1321) as a solution of the question which was being at that time much discussed—whether in any place on the earth's surface water is higher than the earth. It was first published at Venice in 1508, by an ecclesiastic named Moncetti, from a MS. which he alleged to be in his possession, but which no one seems to have seen. Its genuineness is accordingly very doubtful; but Dr Moore has from internal evidence made out a very strong case for it.

The *Letters* of Dante are among the most important materials for his biography. Giovanni Villani mentions three as specially remarkable—one to the government of Florence, in which he complains of undeserved exile; another to the emperor Henry VII., when he lingered too long at the siege of Brescia; and a third to the Italian cardinals to urge them to the election of an Italian pope after the death of Clement V. The first of these letters has not come down to us, the two last are extant. Besides these we have one addressed to the cardinal da Prato, one to a Florentine friend refusing the base conditions of return from exile, one to the princes and lords of Italy to prepare them for the coming of Henry of Luxembourg, another to the Florentines reproaching them with the rejection of the emperor, and a long letter to Can Grande della Scala, containing directions for interpreting the *Divina Commedia*, with especial reference to the *Paradiso*. Of less importance are the letters to the nephews

of Count Alessandro da Romena, to the marquis Moroello Malespina, to Cino da Pistoia and to Guido da Polenta. The genuineness of all the letters has at one time or another been impugned; but the more important are now generally accepted. They have been translated by Mr C. S. Latham, ed. by Mr G. R. Carpenter (Cambridge, Massachusetts and London, 1891).

Dante's reputation has passed through many vicissitudes, and much trouble has been spent by critics in comparing him with other poets of established fame. Read and commented upon with more admiration than intelligence in the Italian universities in the generation immediately succeeding his death, his name became obscured as the sun of the Renaissance rose higher towards its meridian. In the 16th century he was held inferior to Petrarch; in the 17th and first half of the 18th he was almost universally neglected. His fame is now fully vindicated. Translations and commentaries issue from every press in Europe and America, and many studies for separate points are appearing every year.

**AUTHORITIES.**—It would be impossible here to give anything like a complete account even of the editions of Dante's works; still more of the books which have been written to elucidate the *Commedia* as a whole, or particular points in it. The section "Dante" in the British Museum catalogue down to 1887 occupies twenty-nine folio pages; the supplement, to 1900, as many more. The catalogue of the Fiske collection, in Cornell University library, is in two quarto volumes and covers 606 pages. A few of the more important editions and of the more valuable commentaries and aids may, however, be recorded.

**Editions.**—The *Commedia* was first printed by John Numeister at Foligno, in April 1472. Two other editions followed in the same year: one at Jesi (*Federicus Veronensis*), and Mantua (*Georgius et Paulus Teutonicus*). These, together with a Naples edition of about 1477 (Francesco del Tuppo), were included by Lord Vernon in *Le Prime Quattro Edizioni* (1858). Another Neapolitan edition, without printer's name, is dated 1477, and in the same year Wendelin of Spire published the first Venetian edition. Milan followed in 1478 with that known from the name of its editor as the *Nidobeatine*. In 1481 appeared the first Florentine edition (*Nicola and Lorenzo della Magna*) with the commentary of Cristoforo Landino, and a series of copper engravings ascribed to Baccio Baldini, varying in number in different copies from two to twenty; a sumptuous and very carelessly printed volume. Venice supplied most of the editions for many years to come. Altogether twelve existed by the end of the century. In 1502 Aldus produced the first "pocket" edition in his new "italic" type, probably cut from the handwriting of his friend Bembo. A second edition of this is dated 1515. The firm of Giunta at Florence printed the poem in a small volume with cuts, in 1506; and for the rest of the 16th century edition follows edition, to the number of about thirty in all. The most noteworthy commentaries are those of Alessandro Vellutello (Venice, 1544), and Bernardo Daniello (Venice, 1568), both of Lucca. The Cruscan Academicians edited the text in 1595. The first edition with woodcuts is that of Boninus de Boninis (Brescia, 1487). Bernardino Benali followed at Venice in 1491, and from that time onward few if any of the folio editions are without them. The 17th century produced three (or perhaps four) small, shabby and inaccurate editions. In 1716 a revival of interest in Dante had set in, and before 1800 some score of editions had appeared, the best-known being those of G. A. Volpi (Padua, 1727), Pompeo Venturi (Venice, 1739) and Baldassare Lombardi (Rome, 1791).

**Commentaries.**—The *Commedia* began to be the subject of commentaries as soon as, if not before, the author was in his grave. One known as the *Anonimo* until in 1881 Dr Moore identified its writer as Graziolo de' Bambaglioli, was in course of writing in 1324. It was published by Lord Vernon, to whose munificence we owe the accessibility of most of the earlier commentaries, in 1848. That of Jacopo della Lana is thought to have been composed before 1340. It was printed in the Venice and Milan editions of 1477, and 1478 respectively. The so-called *Ultimo Comento* (Pisa, 1837) is of about the same date. It embodies parts of Lana's, but is largely an independent work. Witte ascribes it to Andrea della Lancia, a Florentine notary. Dante's sons Pietro and Jacopo also commented on their father's poem. Their works were published, again at Lord Vernon's expense, in 1845 and 1848. Boccaccio's lectures on the *Commedia*, cut short at *Inf.* xvii. 17 by his death in 1375, are accessible in various forms. His work was achieved by his disciple Benvenuto Rambaldi of Imola (d. c. 1390). Benvenuto's commentary, written in Latin, genial in temper, and often acute, was popular from the first. Extracts from it were used as notes in many MSS. Much of it was printed by Muratori in his *Antiquitates Italicae*; but the entire work was first published in 1887 by Mr William Warren Vernon, with the aid of Sir James Lacaita. No greater boon has ever been offered to students of Dante. Another early annotator who must not be overlooked is Francesco da Buti of Pisa, who lectured in that city towards the close

of the same century. His commentary, which served as the basis of Landino's already mentioned, was first printed in Pisa in 1858. One more commentary deserves mention. During the council of Constance, John of Serravalle, bishop of Fermo, fell in with the English bishops Robert Hallam and Nicholas Bubwith, and at their request compiled a voluminous exposition of the *Commedia*. This remained in MS. till recently, when it was printed in a costly form.

**Translations.**—Probably the first complete translation of Dante into a modern language was the Castilian version of Villena (1428). In the following year Andreu Febrer produced a rendering into Catalan verse. In 1515 Villegas published the *Inferno* in Spanish. The earliest French version is that of B. Grangier (1597). Chaucer has rendered several passages beautifully, and similar fragments are embedded in Milton and others. But the first attempt to reproduce any considerable portion of the poem was made by Rogers, who only completed the *Inferno* (1782). The entire poem appeared first in English in the version of Henry Boyd (1802) in six-line stanzas; but the first adequate rendering is the admirable blank verse of H. F. Cary (1814, 2nd ed. 1819), which has remained the standard translation, though others of merit, notably those of Pollock (1854) and Longfellow (1867) in blank verse, Plumptre (1887) and Haselfoot (1887) in *terza rima*; J. A. Carlyle (*Inferno* only, 1847). C. E. Norton (1891), and H. F. Tozer (1904), in prose, have since appeared. The best in German are those of "Philalethes" (the late King John of Saxony) and Witte, both in blank verse.

**Modern Editions and Commentaries.**—The first serious attempt to establish an accurate text in recent times was made by Carl Witte, whose edition (1862) has been subsequently used as the basis for the text of the *Commedia* in the Oxford edition of Dante's complete works (1896 and later issues). Dr Toynbee's text (1900) follows the Oxford, with some modifications. The notes of Cary, Longfellow, Witte and "Philalethes," appended to their several translations, and Tozer's, in an independent volume, are valuable. Scartazzini's commentary is the most voluminous that has appeared since the 15th century. With a good deal of superfluous, and some superficial, erudition, it cannot be neglected by any one who wishes to study the poem thoroughly. An edition by A. J. Butler contains a prose version and notes. Of modern Italian editions, Bianchi's and Fraticelli's are still as good as any.

**Other Aids.**—For beginners no introduction is equal to the essay on Dante by the late Dean Church. Maria Rossetti's *Shadow of Dante* is also useful. A *Study of Dante*, by J. A. Symonds, is interesting. More advanced students will find Dr Toynbee's *Dante Dictionary* indispensable, and Dr E. Moore's *Studies in Dante* of great service in its discussion of difficult places. Two concordances, to the *Commedia* by Dr Fay (Cambridge, Mass., 1888), and to the minor works by Messrs Sheldon and White (Oxford, 1905), are due to American scholars. Mr W. W. Vernon's *Readings in Dante* have profited many students. Dante's minor works still lack thorough editing and scholarly elucidation, with the exception of the *De vulgari eloquentia*, which has been well handled by Professor Pio Raina (1896), and the *Vita Nuova* by F. Beck (1896) and Barbi (1907). Good translations of the latter by D. G. Rossetti and C. E. Norton, and of the *De monarchia* by F. C. Church and P. H. Wicksteed are in existence. The best text is that of the Oxford *Dante*, though much confessedly remains to be done. The dates of their original publication have already been given.

**BIBLIOGRAPHY.**—The first attempt at a bibliography of editions of Dante was made in Pasquali's edition of his collected works (Venice, 1739); but the first really adequate work on the subject is that of the viscount Colomb de Batines (1846-1848). A supplement by Dr Guido Biagi appeared in 1888. Julius Petzholdt had already covered some of the same ground in *Bibliographia Dantea*, extending from 1865 to 1880. The period from 1891 to 1900 has been dealt with by SS. Passerini and Mazzi in *Un Decennio di bibliografia Dantesca* (1905). The catalogues of the two libraries already named, and that of Harvard University, are worth consulting. For the MSS. Dr E. Moore's *Textual Criticism* (1889) is the most complete guide. (A. J. B.\*)

**DANTON, GEORGE JACQUES** (1759-1794), one of the most conspicuous actors in the decisive episodes of the French Revolution, was born at Arcis-sur-Aube on the 26th of October 1759. His family was of respectable quality, though of very moderate means. They contrived to give him a good education, and he was launched in the career of an advocate at the Paris bar. When the Revolution broke out, it found Danton following his profession with apparent success, leading a cheerful domestic life, and nourishing his intelligence on good books. He first appears in the revolutionary story as president of the popular club or assembly of the district in which he lived. This was the famous club of the Cordeliers, so called from the circumstance that its meetings were held in the old convent of the order of the Cordeliers, just as the Jacobins derived their name from the refectory of the convent of the Jacobin brothers. It is an odd coincidence that the old rivalries of Dominicans and Franciscans

in the democratic movement inside the Catholic Church should be recalled by the names of the two factions in the democratic movement of a later century away from the church. The Cordeliers were from the first the centre of the popular principle in the French Revolution carried to its extreme point; they were the earliest to suspect the court of being irreconcilably hostile to freedom; and it was they who most vehemently proclaimed the need for root-and-branch measures. Danton's robust, energetic and impetuous temperament made him the natural leader in such a quarter. We find no traces of his activity in the two great insurrectionary events of 1789—the fall of the Bastille, and the forcible removal of the court from Versailles to the Tuileries. In the spring of 1790 we hear his voice urging the people to prevent the arrest of Marat. In the autumn we find him chosen to be the commander of the battalion of the national guard of his district. In the beginning of 1791 he was elected to the post of administrator of the department of Paris. This interval was for all France a barren period of doubt, fatigue, partial reaction and hoping against hope. It was not until 1792 that Danton came into the prominence of a great revolutionary chief.

In the spring of the previous year (1791) Mirabeau had died, and with him had passed away the only man who was at all likely to prove a wise guide to the court. In June of that year the king and queen made a disastrous attempt to flee from their capital and their people. They were brought back once more to the Tuileries, which from that time forth they rightly looked upon more as a prison than a palace or a home. The popular exasperation was intense, and the constitutional leaders, of whom the foremost was Lafayette, became alarmed and lost their judgment. A bloody dispersion of a popular gathering, known afterwards as the massacre of the Champ-de-Mars (July 1791), kindled a flame of resentment against the court and the constitutional party which was never extinguished. The Constituent Assembly completed its infertile labours in September 1791. Then the elections took place to its successor, the short-lived Legislative Assembly. Danton was not elected to it, and his party was at this time only strong enough to procure for him a very subordinate post in the government of the Parisian municipality. Events, however, rapidly prepared a situation in which his influence became of supreme weight. Between January and August 1792 the want of sympathy between the aims of the popular assembly and the spirit of the king and the queen became daily more flagrant and beyond power of disguise. In April war was declared against Austria, and to the confusion and distraction caused by the immense civil and political changes of the past two years was now added the ferment and agitation of war with an enemy on the frontier. The distrust felt by Paris for the court and its loyalty at length broke out in insurrection. On the memorable morning of the 10th of August 1792 the king and queen took refuge with the Legislative Assembly from the apprehended violence of the popular forces who were marching on the Tuileries. The share which Danton had in inspiring and directing this momentous rising is very obscure. Some look upon him as the head and centre of it. Apart from documents, support is given to this view by the fact that on the morning of the fall of the monarchy Danton is found in the important post of minister of justice. This sudden rise from the subordinate office which he had held in the commune is a proof of the impression that his character had made on the insurrectionary party. To passionate fervour for the popular cause he added a certain broad steadfastness and an energetic practical judgment which are not always found in company with fervour. Even in those days, when so many men were so astonishing in their eloquence, Danton stands out as a master of commanding phrase. One of his fierce sayings has become a proverb. Against Brunswick and the invaders, "*il nous faut de l'audace, et encore de l'audace, et toujours de l'audace*,"—we must dare, and again dare, and for ever dare. The tones of his voice were loud and vibrant. As for his bodily presence, he had, to use his own account of it, the athletic shape and the stern physiognomy of the Liberty for which he was ready to die. Jove the Thunderer, the rebel Satan, a Titan, Sardanapalus, were names that friends or enemies borrowed to describe his mien and port. He was

thought about as a coarser version of the great tribune of the Constituent Assembly; he was called the Mirabeau of the sans-culottes, and Mirabeau of the markets.

In the executive government that was formed on the king's dethronement, this strong revolutionary figure found himself the colleague of the virtuous Roland and others of the Girondins. Their strength was speedily put to a terrible test. The alarming successes of the enemy on the frontier, and the surrender of two important fortresses, had engendered a natural panic in the capital. But in the breasts of some of the wild men whom the disorder of the time had brought to prominent place in the Paris commune this panic became murderously heated. Some hundreds of captives were barbarously murdered in the prisons. There has always been much dispute as to Danton's share in this dreadful transaction. At the time, it must be confessed, much odium on account of an imputed direction of the massacres fell to him. On the whole, however, he cannot be fairly convicted of any part in the plan. What he did was to make the best of the misdeed, with a kind of sombre acquiescence. He deserves credit for insisting against his colleagues that they should not flee from Paris, but should remain firm at their posts, doing what they could to rule the fierce storm that was raging around them.

The elections to the National Convention took place in September, when the Legislative Assembly surrendered its authority. The Convention ruled France until October 1795. Danton was a member; resigning the ministry of justice, he took a foremost part in the deliberations and proceedings of the Convention, until his execution in April 1794. This short period of nineteen months was practically the life of Danton, so far as the world is concerned with him.

He took his seat in the high and remote benches which gave the name of the Mountain to the thoroughgoing revolutionists who sat there. He found himself side by side with Marat, whose exaggerations he never countenanced; with Robespierre, whom he did not esteem very highly, but whose immediate aims were in many respects his own; with Camille Desmoulins and Phélippeaux, who were his close friends and constant partisans. The foes of the Mountain were the group of the Girondins,—eloquent, dazzling, patriotic, but unable to apprehend the fearful nature of the crisis, too full of vanity and exclusive party-spirit, and too fastidious to strike hands with the vigorous and stormy Danton. The Girondins dreaded the people who had sent Danton to the Convention; and they insisted on seeing on his hands the blood of the prison massacres of September. Yet in fact Danton saw much more clearly than they saw how urgent it was to soothe the insurrectionary spirit, after it had done the work of abolition which to him, as to them too, seemed necessary and indispensable. Danton discerned what the Girondins lacked the political genius to see, that this control of Paris could only be wisely effected by men who sympathized with the vehemence and energy of Paris, and understood that this vehemence and energy made the only force to which the Convention could look in resisting the Germans on the north-east frontier, and the friends of reaction in the interior. "Paris," he said, "is the natural and constituted centre of free France. It is the centre of light. When Paris shall perish there will no longer be a republic."

Danton was among those who voted for the death of the king (January 1793). He had a conspicuous share in the creation of the famous revolutionary tribunal, his aim being to take the weapons away from that disorderly popular vengeance which had done such terrible work in September. When all executive power was conferred upon a committee of public safety, Danton had been one of the nine members of whom that body was originally composed. He was despatched on frequent missions from the Convention to the republican armies in Belgium, and wherever he went he infused new energy into the work of national liberation. He pressed forward the erection of a system of national education, and he was one of the legislative committee charged with the construction of a new system of government. He vainly tried to compose the furious dissensions between Girondins and Jacobins. The Girondins were irreconcilable, and made Danton the object of deadly attack. He was far too robust in character to lose

himself in merely personal enmities, but by the middle of May (1793) he had made up his mind that the political suppression of the Girondins had become indispensable. The position of the country was most alarming. Dumouriez, the victor of Valmy and Jemmappes, had deserted. The French arms were suffering a series of checks and reverses. A royalist rebellion was gaining formidable dimensions in the west. Yet the Convention was wasting time and force in the vindictive recriminations of faction. There is no positive evidence that Danton directly instigated the insurrection of the 31st of May and the 2nd of June, which ended in the purge of the Convention and the proscription of the Girondins. He afterwards spoke of himself as in some sense the author of this revolution, because a little while before, stung by some trait of factious perversity in the Girondins, he had openly cried out in the midst of the Convention, that if he could only find a hundred men, they would resist the oppressive authority of the Girondin commission of twelve. At any rate, he certainly acquiesced in the violence of the commune, and he publicly gloried in the expulsion of the men who stood obstinately in the way of a vigorous and concentrated exertion of national power. Danton, unlike the Girondins, accepted the fury of popular passion as an inevitable incident in the work of deliverance. Unlike Billaud Varenne or Hébert, or any other of the Terrorist party, he had no wish to use this frightful two-edged weapon more freely than was necessary. Danton, in short, had the instinct of the statesman. His object was to reconcile France with herself; to restore a society that, while emancipated and renewed in every part, should yet be stable; and above all to secure the independence of his country, both by a resolute defence against the invader, and by such a mixture of vigour with humanity as should reconcile the offended opinion of the rest of Europe. This, so far as we can make it out, was what was in his mind.

The position of the Mountain had now undergone a complete change. In the Constituent Assembly its members did not number more than 30 out of the 578 of the third estate. In the Legislative Assembly they had not been numerous, and none of their chiefs had a seat. In the Convention for the first nine months they had an incessant struggle for their very lives against the Girondins. They were now (June 1793) for the first time in possession of absolute power. It was not easy, however, for men who had for many months been nourished on the ideas and stirred to the methods of opposition, all at once to develop the instincts of government. Actual power was in the hands of the two committees—that of public safety and of general security. Both were chosen out of the body of the Convention. The drama of the nine months between the expulsion of the Girondins and the execution of Danton turns upon the struggle of the committee to retain power—first, against the insurrectionary commune of Paris, and second, against the Convention, from which the committees derived an authority that was regularly renewed on the expiry of each short term.

Danton, immediately after the fall of the Girondins, had thrown himself with extraordinary energy into the work to be done. The first task in a great city so agitated by anarchical ferment had been to set up a strong central authority. In this genuinely political task Danton was prominent. He was not a member of the committee of public safety when that body was renewed in the shape that speedily made its name so redoubtable all over the world. This was the result of a self-denying ordinance which he imposed upon himself. It was he who proposed that the powers of the committee should be those of a dictator, and that it should have copious funds at its disposal. In order to keep himself clear of any personal suspicion, he announced his resolution not to belong to the body which he had thus done his best to make supreme in the state. His position during the autumn of 1793 was that of a powerful supporter and inspirer, from without, of the government which he had been foremost in setting up. Danton was not a great practical administrator and contriver, like Carnot, for instance. But he had the gift of raising in all who heard him an heroic spirit of patriotism and fiery devotion, and he had a clear eye and a cool judgment in the



tempestuous emergencies which arose in such appalling succession. His distinction was that he accepted the insurrectionary forces, instead of blindly denouncing them as the Girondins had done. After these forces had shaken down the throne, and then, by driving away the Girondins, had made room for a vigorous government, Danton perceived the expediency of making all haste to an orderly state. Energetic prosecution of the war, and gradual conciliation of civil hatreds, had been, as we have said, the two marks of his policy ever since the fall of the monarchy. The first of these objects was fulfilled abundantly, partly owing to the energy with which he called for the arming of the whole nation against its enemies. His whole mind was now given to the second of them. But the second of them, alas, was desperate.

It was to no purpose that, both in his own action and in the writings of Camille Desmoulins (*Le Vieux Cordelier*), of whom he was now and always the intimate and inspirer, he worked against the iniquities of the bad men, like Carrier and Collot d'Herbois, in the provinces, and against the severity of the revolutionary tribunal in Paris. The black flood could not at a word or in an hour subside from its storm-lashed fury. The commune of Paris was now composed of men like Hébert and Chaumette, to whom the restoration of any sort of political order was for the time indifferent. They wished to push destruction to limits which even the most ardent sympathizers with the Revolution condemn now, and which Danton condemned then, as extravagant and senseless. Those men were not politicians, they were fanatics; and Danton, who was every inch a politician, though of a vehement type, had as little in common with them as John Calvin of Geneva had with John of Leiden and the Münster Anabaptists. The committee watched Hébert and his followers uneasily for many weeks, less perhaps from disapproval of their excesses than from apprehensions of their hostility to the committee's own power. At length the party of the commune proposed to revolt against the Convention and the committees. Then the blow was struck, and the Hébertists were swiftly flung into prison, and thence under the knife of the guillotine (March 24th, 1794). The execution of the Hébertists was the first victory of the revolutionary government over the extreme insurrectionary party. But the committees had no intention to concede anything to their enemies on the other side. If they refused to follow the lead of the anarchists of the commune, they were none the more inclined to give way to the Dantonian policy of clemency. Indeed, such a course would have been their own instant and utter ruin. The Terror was not a policy that could be easily transformed. A new policy would have to be carried out by new men, and this meant the resumption of power by the Convention, and the death of the Terrorists. In Thermidor 1794 such a revolution did take place, with those very results. But in Germinal feeling was not ripe. The committees were still too strong to be overthrown. And Danton seems to have shown a singular heedlessness. Instead of striking by vigour in the Convention, he waited to be struck. In these later days a certain discouragement seems to have come over his spirit. His wife had died during his absence on one of his expeditions to the armies; he had now married again, and the rumour went that he was allowing domestic happiness to tempt him from the keen incessant vigilance proper to the politician in such a crisis. He must have known that he had enemies. When the Jacobin club was "purified" in the winter, Danton's name would have been struck out as a moderate if Robespierre had not defended him. The committees had deliberated on his arrest soon afterwards, and again it was Robespierre who resisted the proposal. Yet though he had been warned of the lightning that was thus playing round his head, Danton did not move. Either he felt himself powerless, or he rashly despised his enemies. At last Billaud Varenne, the most prominent spirit of the committee after Robespierre, succeeded in gaining Robespierre over to his designs against Danton. Robespierre was probably actuated by the motives of selfish policy which soon proved the greatest blunder of his life. The Convention, aided by Robespierre and the authority of the committee, assented with ignoble unanimity. On the 30th of March Danton, Desmoulins and others of the

party were suddenly arrested. Danton displayed such vehemence before the revolutionary tribunal, that his enemies feared lest he should excite the crowd in his favour. The Convention, in one of its worst fits of cowardice, assented to a proposal made by St Just that, if a prisoner showed want of respect for justice, the tribunal might pronounce sentence without further delay. Danton was at once condemned, and led, in company with fourteen others, including Camille Desmoulins, to the guillotine (April 5th, 1794). "I leave it all in a frightful welter," he said; "not a man of them has an idea of government. Robespierre will follow me; he is dragged down by me. Ah, better be a poor fisherman than meddle with the government of men!"

Events went as Danton foresaw. The committees presently came to quarrel with the pretensions of Robespierre. Three months after Danton, Robespierre fell. His assent to the execution of Danton had deprived him of the single great force that might have supported him against the committee. The man who had "saved France from Brunswick" might perhaps have saved her from the White reaction of 1794.

**BIBLIOGRAPHY.**—Sources for the life of Danton abound in the national archives and in the columns of the *Moniteur*. His *Ceuvres* were published by A. Vermorel (Paris, 1866), and his speeches are included in H. Morse Stephens' *Principal Speeches of the Statesmen and Orators of the French Revolution* (vol. ii., Oxford, 1892); cf. F. V. Aulard, *Les Orateurs de la Législative et de la Convention* (Danton and his group; 2 vols., 1885-1886). The charges of corruption freely brought against Danton by contemporaries were accepted by many historians, and he has been persistently accused of instigating or at least abetting, by failure to use the power he possessed, the September massacres. A minute examination of the evidence by F. V. Aulard and J. F. E. Robinet in France, followed by A. H. Beesly in England, has placed his career and his character in a fairer light. The chief books on Danton's life are:—A. Bougeart, *Danton, documents pour servir à l'histoire de la Révolution française* (Brussels, 1861); J. F. E. Robinet, *Danton, mémoire sur sa vie privée* (Paris, 1865), *Le Procès des Dantonistes* (Paris, 1879), *Danton émigré* (Paris, 1887), *Danton, homme d'état* (Paris, 1889); F. V. Aulard, *Hist. pol. de la Rév. fr.* (Paris, 1901), and *Danton* (Paris, 1887); A. Dubost, *Danton et la politique contemporaine* (Paris, 1880); A. H. Beesly, *Life of Danton* (1899, new ed. 1906); H. Belloc, *Danton* (1899). There is a short "Life of Danton" in Morse Stephens' *Principal Speeches*, cited above. See also C. F. Warwick, *Danton and the French Revolution* (1909). (J. Mo.)

**DANUBE** (Ger. *Donau*, Hungarian *Duna*, Rumanian *Dunarea*. Lat. *Danubius* or *Danuvius*, and in the lower part of its course *Ister*), the most important river of Europe as regards the volume of its outflow, but inferior to the Volga in length and in the area of its drainage. It originates at Donaueschingen in the Black Forest, where two mountain streams, the Brigach and the Bregle, together with a third stream from the Palace Gardens, unite at an elevation of 2187 ft. above the sea to form the Danube so called. From this point it runs in an easterly direction until it falls into the Black Sea some 1750 m. from its source, being the only European river of importance with a course from west to east. Its basin, which comprises a territory of nearly 300,000 sq. m., is bounded by the Black Forest, some of the minor Alpine ranges, the Bohemian Forest and the Carpathian Mountains on the north, and by the Alps and the Balkan range on the south. From the point where the Danube first becomes navigable, *i.e.* at its junction with the Iller at Ulm (1505 ft. above sea-level), it is fed by at least 300 tributaries, the principal of which on the right bank are the Inn, the Drave and the Save; while on the left bank are the Theiss or Tisza, the Olt, the Sereth and the Pruth. These seven rivers have a total length of 2920 m. and drain one half of the basin of the Danube.

The course of this mighty river is rich in historical and political associations. For a long period it formed the frontier of the Roman empire; near Eining (above Regensburg) was the ancient Abusina, which for nearly five centuries was the chief Roman outpost against the northern barbarians. Traces of Trajan's wall still exist between that point and Wiesbaden, while another line of fortifications bearing the same emperor's name are found in the Dobrudja between Cernavoda (on the lower Danube) and Constantza. At intervening points are still found many notable Roman remains, such as Trajan's road, a marvellous work on the

*Historical  
and  
political  
associations.*

right bank of the river in the rocky Kazan defile (separating the Balkans on the south from the Carpathians on the north), where a contemporary commemorative tablet is still conspicuously visible. At Turnu Severin below the end of this famous gorge are the remains of a solid masonry bridge constructed by the same emperor at the period of his Dacian conquests. But since Roman days the central Danube has never formed the boundary of a state; on the contrary it became the route followed from east to west by successive hordes of barbarians—the Huns, Avars, Slavs, Magyars and Turks; while the Franks under Charlemagne, the Bavarians and the Crusaders all marched in the opposite direction towards the east. In more modern days its banks were the scenes of many bloody battles during the Napoleonic Wars. Still more recently it has become the great highway of commerce for central Europe. It has been pointed out by J. G. Kohl (*Austria and the Danube*, London, 1844) and others that, in consequence of the Danube having been in constant use as the line of passage of migratory hostile tribes, it nowhere forms the boundary between two states from Orsova upwards, and thus it traverses as a central artery Württemberg, Bavaria, Austria and Hungary, while on the other hand various tributaries both north and south, which formed serious obstacles to the march of armies, have become lines of separation between different states. Thus Hungary is separated from Austria by the rivers March and Leitha; the river Enns, for a considerable period the extreme western boundary of the Magyar kingdom, still separates Upper and Lower Austria; the Inn and the Salzach divide Austria from Bavaria, and farther west the Iller separates Bavaria from Württemberg.

The Danube after leaving Donaueschingen flows south-east in the direction of Lake Constance, and below Immendingen a considerable quantity of its waters escapes through subterranean fissures to the river Ach in the Rhine basin. At Gutmadingen it turns to the north-east, which general direction, although with many windings, it maintains as far as Linz. At Tuttlingen it contracts and the hills crowd close to the banks, while ruins of castles crown almost every possible summit. The scenery is wild and beautiful until the river passes Sigmaringen. At Ulm, where the river leaves Württemberg and enters Bavaria, it is joined by a large tributary, the Iller, and from this point becomes navigable downstream for specially constructed boats carrying 100 tons of merchandise. It is here some 78 yds. in breadth, with an average depth of 3 ft. 6 in. Continuing its north-easterly course it passes through Bavaria, gradually widening its channel first at Steppberg, then at Ingolstadt, but finally narrowing again until it reaches Regensburg (height 949 ft.). At this point it changes its direction to the south-east, and passing along the southern slopes of the Bavarian Forest enters Austria at Passau (height 800 ft.). In its passage through Bavaria it receives several important affluents on both banks, notably on the right the Alpine rivers Lech, Isar and Inn, the last of which at the junction near Passau exceeds in volume the waters of the Danube.

From Passau the Danube flows through Austria for a distance of 233 m. Closed in by mountains it flows past Linz in an unbroken stream—below, it expands and divides into many arms until it reaches the famous whirlpool near Grein where its waters unite and flow on in one channel for 40 m., through mountains and narrow passes. Beyond Krems it again divides, forming arms and islands beyond Vienna. The Danube between Linz and Vienna is renowned not only for its picturesque beauty but for the numerous medieval and modern buildings of historical and archaeological interest which crown its banks. The splendid Benedictine monastery of Melk and the ruins of Dürrenstein, the prison of Richard Cœur de Lion, are among the most interesting.

After passing Vienna and the Marchfeld, the Danube (here 316 yds. wide and 429 ft. above sea-level) passes through a defile formed by the lower spurs of the Alps and the Carpathians and enters Hungary at the ruined castle of Theben a little above Pressburg, the old Magyar capital, after leaving which the river passes through the Hungarian plains, receiving several affluents on both sides. It divides into three channels, forming several

islands. After passing the fortress of Komárom it loses its easterly course at Vác (Waitzen), and flows nearly due south for 230 m. down to its junction with the Drave (81 ft. above sea-level), passing in its course Budapest, the capital of Hungary, and farther on Mohács. Below Mohács the Franz Josef canal connects the Danube with the Theiss. After its junction with the Save the Danube follows a south-easterly direction for 200 m. until it is joined on the right bank of the Drave at Belgrade, above which it receives on the left bank the Theiss or Tisz., the largest of its Hungarian affluents. From Belgrade the Danube separates Hungary from Serbia. It flows eastward until it has passed through the stupendous Kazan defile, in which its waters (at Semlin 1700 yds. wide and 40 ft. deep) are hemmed in by precipitous rocks to a width of only 162 yds., with a depth of 150 ft. and a tremendous current. Emerging, above Orsova, at a height of 42 ft. above sea-level, it opens to nearly a mile in width and, turning south-eastwards, is again narrowed by its last defile, the Iron Gates, where it passes over the Prigrada rock. The course of the river through Hungary, from Pressburg to Orsova, is some 600 m.

The river now flows south, separating Serbia from Rumania down to its junction with the Timok, after which as far as Silistria, a distance of 284 m., it separates Rumania from Bulgaria. The north bank is mostly flat and marshy, whereas the Bulgarian bank is almost continuously crowned by low heights on which are built the considerable towns of Vidin (Widdin), Lom Palanka, Rustchuk and Silistria, all memorable names in Turko-Russian wars. From Silistria the river flows through Rumanian territory and after passing Cernavoda, where it is crossed by a modern railway bridge, it reaches (left bank) the important commercial ports of Braila and Galatz. A few miles east of Galatz the Pruth enters on the left bank, which is thenceforward Russian territory. The Danube flows in a single channel from Galatz for 30 m. to the Ismail Chatal (or fork), where it breaks up into the several branches of the delta. The Kilia branch from this point flows to the north-east past the towns of Ismail and Kilia, and 17 m. below the latter breaks up into another delta discharging by seven channels into the Black Sea. The Tulcea branch flows south-east from the Ismail Chatal, and 7 m. below the town of Tulcea separates into two branches. The St George's branch, holding a general, though winding, course to the south-east, discharges by two channels into the sea; and the Sulina branch, taking an easterly direction, emerges into the Black Sea 20 m. south of the Ochakov mouth of the Kilia, and 20 m. north of the Kedrilles mouth of the St George.

In 1857 the proportion of discharge by the three branches of the Danube was Sulina 7%, St George's 30% and Kilia 63%; but in 1905 the relative proportions had altered to Sulina 9%, St George's 24% and Kilia 67%. The average outflow by the three mouths combined is 236,432 cub. ft. per second. The delta enclosed between the Kilia and St George's branches, about 1000 sq. m. in area, mainly consists of one large marsh covered with reeds, and intersected by channels, relieved in places by isolated elevations covered with oak, beech and willows, many of them marking the ancient coast-line. On the eastern side of the Kilia delta the coast-line is constantly advancing and the sea becoming shallower, owing to the enormous amount of solid deposits brought down by the river. In time of ordinary flood the Kilia branch with its numerous mouths pours into the sea some 3000 cub. ft. of sand and mud per minute. Its effects are felt as far south as Sulina, and tend to necessitate the farther extension into the sea of the guiding piers of that port.

In the course of the 19th century, more especially during its latter half, much was done to render the Danube more available as a means of communication. In 1816 Austria and Bavaria made arrangements for the common utilization Navigation. of the upper portion of the river, and since then both governments have been liberal in expenditure on its improvement. In 1844 the Ludwigs Canal was constructed by King Louis of Bavaria. It is 110 m. in length and 7 ft. in depth, and connects the Danube at Kelheim (half way between Ulm and Passau) with the Rhine at Mainz by means of the rivers Altmühl, Regnitz and

**Main.** Various other projects exist, one for the connexion of the Danube (near Vienna) with the river Oder at Oderberg, another for a canal from the Danube to the Moldau at Budweis, 125 m. in length, which owing to the regularization of the Moldau is the last uncompleted link of a navigable channel 1875 m. in length between Sulina and Hamburg at the mouths of the Danube and the Elbe respectively. There also exist other schemes for joining the Danube with the rivers Neckar and Theiss, and also for connecting the Oder Canal with the Vistula and the Dniester. Between Ulm and Vienna, a distance of 629 m., works of rectification have been numerous and have greatly improved the navigability of the river. The draining of the Donau-moos between Neuburg and Ingolstadt, commenced in 1791, was successfully completed about 1835; and in 1853 the removal of the rocks which obstructed the river below Grein was finally achieved; while at Vienna itself the whole mass of the Danube was conducted nearer the town for a distance of nearly 2 m. through an artificial channel 10 m. in length and 330 yds. in width, with a depth of about 12 ft., and at a cost with subsidiary works of over three millions sterling. The work, begun in 1866, involved the removal of 12,000,000 cub. metres of sand and gravel, and proved a great success, not only amply realizing its principal object, the protection of Vienna from disastrous inundations, but also improving the navigability of the river in that portion of its course. The Hungarian government also, throughout the latter half of the 19th century, expended vast sums at Budapest for the improvement of navigation and the protection of the town from inundation, and in the regularization of the Danube down to Orsova.

In prehistoric times a great part of the plains of Hungary formed a large inland sea, which ultimately burst its bounds, whereupon the Danube forced its way through the Carpathians at the Kazan defile. Much of what then formed the bottom of this sea consisted until modern times of marshes and waste lands lying in the vicinity of its numerous rivers. The problem of draining and utilizing these lands was not the only difficulty to be surmounted by the Hungarian engineers; the requirements of navigation and the necessity in winter of preventing the formation of large ice-fields, such as caused the disastrous floods at Budapest in 1838, had also to be considered. In carrying out these works the Hungarian government between 1867 and 1895 spent seven millions sterling, and a further expenditure of three and a half millions was provided for up to 1907. At Budapest, where the formation of ice-fields at the upper entrance of the two side arms of the Danube—the Promontor on the north, 20 m. in length, and the Soroksar, 35 m. long,—caused the inundation alluded to, the latter branch has been artificially blocked and the whole of the Danube now flows through Budapest in a single channel. For the first section of 60 m. after entering Hungary, the bed of the river, here surcharged with gravel, was constantly changing its course. It has been regularized throughout, the width of the stream varying from 320 to 400 yds. In the second section from Gönyö to Paks, 164 m. in length, the river had a tendency to form islands and sandbanks—its width now varies uniformly from 455 to 487 yds. The third section of 113 m., from Paks to the mouth of the Drave, differed from the others and made innumerable twists and curves. No fewer than seventeen cuttings have been made, reducing the original course of the river by 75 m. The fourth section, 217 m. in length, from the Drave to Old Moldova, resembles in its characteristics the second section and has been similarly treated. Cuttings have also been made where necessary, and the widths of the channel are 487 yds. to the mouth of the Theiss, 650 between that point and the Save, and lower down 760 yds. In the fifth and last section from Old Moldova to Orsova and the Iron Gates the river is enclosed by mountains and rocky banks, and the obstacles to navigation are rocks and whirlpools.

Article VI. of the treaty of London (1871) authorized the powers which possess the shores of this part of the Danube to come to an understanding with the view of removing these impediments, and to have the right of levying a provisional tax on vessels of every flag which may henceforth benefit thereby

until the extinction of the debt contracted for the execution of the works. As the riverain powers could not come to an agreement on the subject, the great powers at the congress of Berlin (1878) entrusted to Austria-Hungary the execution of the works in question. Austria-Hungary subsequently conferred its rights on Hungary, by which country the works were carried out at a cost of about one and a half millions sterling.

The principal obstructions between Old Moldova and Turnu Severin were the Stenka Rapids, the Kozla Dojke Rapids, the Greben section and the Iron Gates. At the first named there was a bank of rocks, some of them dry at low water, extending almost across the river (985 yds. wide). The fall of the river bed is small, but the length of the rapid is 1100 yds. The Kozla Dojke, 9 m. below the Stenka Rapids, extend also for 1100 yds., with a fall of 1 in 1000, where two banks of rocks cause a sudden alternation in the direction of the current. The river is here only 170 to 330 yds. in width. Six miles farther on is the Greben section, the most difficult part of the works of improvement. A spur of the Greben mountains runs out below two shoals where the river suddenly narrows to 300 yds. at low water, but presently widens to 1½ m. Seven miles lower down are the Jucz Rapids, where the river-bed has a fall of 1 in 433. At the Iron Gates, 34 m. below the Greben, the Prigrada rocky bank nearly blocked the river at the point where it widens out after leaving the Kazan defile. The general object of the works was to obtain a navigable depth of water at all seasons of 2 metres (6·56 ft.) on that portion of the river above Orsova, and a depth of 3 metres (9·84 ft.) below that town. To effect this at Stenka, Kozla Dojke, Islaz and Tachtalia, channels 66 yds. wide had to be cut in the solid rock to a depth of 6 ft. 6 in. below low water. The point of the Greben spur had to be entirely removed for a distance of 167 yds. back from its original face. Below the Greben point a training wall 7 to 9 ft. high, 10 ft. at top and nearly 4 m. in length, has been built along the Servian shore in order to confine the river in a narrow channel. At Jucz another similar channel had to be cut and a training wall built. At the Iron Gates a channel 80 yds. wide, nearly 2000 yds. in length and 10 ft. deep (in the immediate vicinity of traces of an old Roman canal) had to be cut on the Servian side of the river through solid rock. Training walls have been built on either side of the channel to confine the water so as to raise its level; that on the right bank having a width of 19 ft. 6 in. at top, and serving as a tow-path; that on the left being 13 ft. in width. These training walls are built of stone with flat revetments to protect them against ice. These formidable and expensive works have not altogether realized the expectations that had been formed of them. One most important result, however, has been attained, *i.e.* vessels can now navigate the Iron Gates at all seasons of the year when the river is not closed by ice, whereas formerly at extreme low water, lasting generally for about three months in the late summer and autumn, through navigation was always at a standstill, and goods had to be landed and transported considerable distances by land. The canal was opened for traffic on the 1st of October 1898. It was designed of sufficient width, as was supposed, for the simultaneous passage of boats in opposite directions; but on account of the great velocity of the current this has been found to be impracticable.

From the Iron Gates down to Braila, which is the highest point to which large sea-going ships ascend the river, there have been no important works of improvement. From Braila to Sulina, a distance of about 100 m., the river falls under the jurisdiction of the European commission of the Danube, an institution of such importance as to merit lengthened notice. It was called into existence under Art. XVI. of the treaty of Paris (1856), and in November of that year a commission was constituted in which Austria, France, Great Britain, Prussia, Russia, Sardinia and Turkey were each represented by one delegate "to designate and cause to be executed the works necessary below Isaktcha<sup>1</sup> to clear the mouths of the Danube as well as the neighbouring parts of the sea, from

*European  
commission  
of  
the  
Danube.*

<sup>1</sup> Isakcea was 66 nautical m. from the sea measured by the Sulina arm of the Danube, 37 m. below Braila and 26 m. below Galatz.

the sands and other impediments which obstructed them, in order to put that part of the river and the said parts of the sea in the best possible state for navigation."

In Art. XVIII. of the same treaty it was anticipated that the European commission would have finished the works described within the period of two years, when it was to be dissolved and its powers taken over by a Riverain commission to be established under the same treaty; but this commission has never come into existence. Extended by short periods up to 1871, the powers of the European commission were then prolonged under the treaty of London for twelve years. At the congress of Berlin in 1878 its jurisdiction was extended from Isakcea to Galatz (26 m.), and it was decided that the commission, in which Rumania was henceforward to be represented by a delegate, should exercise its powers in complete independence of the territorial authority. By the treaty of London of 1883 the jurisdiction of the commission was extended from Galatz to Braila and its powers were prolonged for twenty-one years (*i.e.* till the 24th of April 1904), after which its existence was to continue by tacit prolongation for successive terms of three years unless one of the high contracting powers should propose any modification in its constitution or attributes. It was also decided that the European commission should no longer exercise any effective control over that portion of the Kilia branch of which the two banks belonged to one of the riverain powers (Russia and Rumania), while as regards that portion of it which separated the two countries, control was to be exercised by the Russian and Rumanian delegates on the European commission. Russia was also authorized to levy tolls intended to cover the expenses of any works of improvement that might be undertaken by her. Art. VII. of the same treaty declared that the regulations for navigation, river police, and superintendence drawn up on the 2nd of June 1882 by the European commission, assisted by the delegates of Servia and Bulgaria, should be made applicable to that part of the Danube situated between the Iron Gates and Braila. In consequence of Rumania's opposition, the proposed *Commission Mixte* was never formed, and these regulations have never been put in force. As regards the extension of the powers of the European commission to Braila, 11 m. above Galatz, and at the head of the maritime navigation, a tacit understanding has been arrived at, under which questions concerning navigation proper come under the jurisdiction of the commission, while the police of the ports remains in the hands of the Rumanian authorities.

Sir Charles Hartley, who was chief engineer of the commission from 1856 to 1907,<sup>1</sup> in a paper contributed to the Institution of Civil Engineers in 1873 (vol. xxxvi.), gave the following graphic description of the state of the Sulina mouth when the commission entered on its labours in 1856:—

"The entrance to the Sulina branch was a wild open seaboard strewn with wrecks, the hulls and masts of which, sticking out of the submerged sandbanks, gave to mariners the only guide where the deepest channel was to be found. The depth of the channel varied from 7 to 11 ft., and was rarely more than 9 ft.

"The site now occupied by wide quays extending several miles in length was then entirely covered with water when the sea rose a few inches above ordinary level, and that even in a perfect calm; the banks of the river near the mouth were only indicated by clusters of wretched hovels built on piles and by narrow patches of sand skirted by tall weeds, the only vegetable product of the vast swamps beyond.

"For some years before the improvements, an average of 2000 vessels of an aggregate capacity of 400,000 tons visited the Danube, and of this number more than three-fourths loaded either the whole or part of their cargoes from lighters in the Sulina roadstead, where, lying off a lee shore, they were frequently exposed to the greatest danger. Shipwrecks were of common occurrence, and occasionally the number of disasters was appalling. One dark winter night in 1855, during a terrific gale, 24 sailing ships and 60 lighters went ashore off the mouth and upwards of 300 persons perished."

The state of affairs in the river was not much better than at the Sulina mouth. Of the three arms of the Danube, the Kilia, the

<sup>1</sup> Sir Charles Hartley became consulting engineer in 1872, when he was succeeded as resident engineer by Mr Charles Kùhl, C.E., C.M.G. To those two gentlemen is mainly due the conspicuous success of the engineering works.

Sulina and the St George, the central or Sulina branch, owing to its greater depth of water over the bar, had from time immemorial been the principal waterway for sea-going vessels; its average depth throughout its course, which could not always be counted on, was 8 ft., but it contained numerous shoals where vessels had to lighten, so that cargo had often to be shifted several times in the voyage down the river. It also contained numerous bends and sharp curves, sources of the greatest difficulty to navigation.

The commission fixed its seat at Galatz. Provisional works of improvement were begun almost immediately at the mouth of the Sulina branch of the Danube, but two years were spent in discussing the relative claims to adoption of the Kilia, the Sulina and the St George's mouths. Unable to agree, the delegates referred the question to their respective governments, and a technical commission appointed by France, England, Prussia and Sardinia met at Paris and decided unanimously in favour of St George's; but recommended, instead of the embankment of the natural channel, the formation of an artificial canal 17 ft. in depth closed by sluices at its junction with the river, and reaching the sea at some distance from the natural embouchure. The choice of St George's made by this commission was adopted at Galatz in December 1858, and six of the seven representatives voted for its canalization; but owing to various political and financial considerations, it was ultimately decided to do nothing more in the meantime than render permanent and effective the provisional works already in progress at the Sulina mouth. These consisted of two piers forming a seaward prolongation of the fluvial channel, begun in 1858 and completed in 1861. The northern pier had a length of 4631 ft., the southern of 3000, and the depth of the water in which they were built varied from 6 to 20 ft. At the commencement of the works the depth of the channel was only 9 ft. but by their completion it had increased to 19 ft. The works designed and constructed by Sir Charles Hartley had in fact proved so successful that nothing more was ever heard of the St George's project. In 1865 a new lighthouse was erected at the end of the north pier. The value of these early works of the commission is shown by the fact that of 2928 vessels navigating the lower Danube in 1855, 36 were wrecked, while of 2676 in 1865 only 7 were wrecked. In 1871 it was found expedient to lengthen the piers seaward, and in 1876 the south jetty was prolonged, so as to bring its end exactly opposite the lighthouse on the north pier. This resulted in an increase of the depth to 20½ ft., and for fifteen years, from 1870 to 1895, this depth remained constant without the aid of dredging. In 1894, owing to the constantly increasing size of vessels frequenting the Danube, it was found necessary to deepen the entrance still further, and to construct two parallel piers between the main jetties, reducing the breadth of the river to 500 ft., and thereby increasing the scour. There is now a continuous channel 24 ft. in depth, 5200 ft. in length, and 300 ft. in width between the piers, and 600 ft. outside the extremities of the piers, until deep water is reached in the open sea. This depth is only maintained by constant dredging. The engineers of the commission have been equally successful in dealing with the Sulina branch of the river. Its original length of 45 m. from St George's Chatal to the sea was impeded at the commencement of the improvement works by eleven bends, each with a radius of less than 1000 ft., besides numerous others of somewhat larger radius, and its bed was encumbered by ten shifting shoals, varying from 8 to 13 ft. in depth at low water. By means of a series of training walls, by groynes thrown out from the banks, by revetments of the banks, and by dredging, all done with the view of narrowing the river, a minimum depth of 11 ft. was attained in 1865, and 13 ft. in 1871. In 1880 the needs of commerce and the increased size of steamers frequenting the river necessitated the construction of a new entrance from the St George's branch. This work, designed in 1857, but unexecuted during a quarter of a century, owing to insufficiency of funds, was completed in 1882; and in 1886, after other comparatively short cuttings had been made to get rid of difficult bends and further to deepen the channel without having to resort to dredgers, the desired minimum depth of 15 ft. was attained. Since that date a series of new cuttings

has been made. These have shortened the length of the Sulina canal by 11 nautical m., eliminated all the difficult bends and shoals, and provided an almost straight waterway 34 m. in length from Sulina to St George's Chatal, with a minimum depth of 20 ft. when the river is at its lowest.

In the early days of the commission, *i.e.* from 1857 to 1860, the money spent on the works of improvement, amounting to about £150,000, was advanced as a loan by the then territorial power, Turkey; but in 1860 the commission began to levy taxes on vessels frequenting the river, and since then has repaid its debt to the Turkish government, as well as various loans for short periods, and a larger one of £120,000 guaranteed by the powers, and raised in 1868, mainly through the energy of the British commissioner, Sir John Stokes. This last loan was paid off in 1882 and the commission became free from debt in 1887. It has now an average annual income of about £80,000 derived from taxes paid by ships when leaving the river. The normal annual expenditure amounts to about £56,000, while £24,000 is generally allotted to extraordinary works, such as new cuttings, &c. Between 1857 and 1905 a sum of about one and three quarter millions sterling was spent on engineering works, including the construction of quays, lighthouses, workshops and buildings, &c. Sulina from being a collection of mud hovels has developed into a town with 5000 inhabitants; a well-found hospital has been established where all merchant sailors receive gratuitous treatment; lighthouses, quays, floating elevators and an efficient pilot service all combine to make it a first-class port.

The result of all the combined works for the rectification of the Danube is that from Sulina up to Braila the river is navigable for sea-going vessels up to 4000 tons register, from Braila to Turnu Severin it is open for sea-going vessels up to 600 tons, and for flat barges of from 1500 to 2000 tons capacity. From Turnu Severin to Orsova navigation is confined to river steamers, tugs and barges drawing 6 ft. of water. Thence to Vienna the draught is limited to 5 ft., and from Vienna to Regensburg to a somewhat lower figure. Barges of 600 tons register can be towed from the lower Danube to Regensburg. Here petroleum tanks have been constructed for the storage of Rumanian petroleum, the first consignment of which in 1898, conveyed in tank boats, took six weeks on the voyage up from Giurgevo. The principal navigation company on the upper Danube is the Société Impériale et Royale Autrichienne de Vienna, which started operations in 1830. This company also owns the Fünfkirchen mines, producing annually 500,000 tons of coal. The society transports goods and passengers between Galatz and Regensburg. A less important society is the Rumanian State Navigation Company, possessing a large flotilla of tugs and barges, which run to Budapest, where they have established a combined service with the South Danube German Company for the transport of goods from Pest to Regensburg. A Hungarian Navigation Company, subsidized by the state, has also been formed, and the Hungarian railways, the Servian government and private owners own a large number of tugs and barges.

But it is the trade of the lower Danube that has principally benefited. Freights from Galatz and Braila to North Sea ports have fallen from 50s. to about 12s. or even 10s. per ton. Sailing ships of 200 tons register have given way to steamers up to 4000 tons register carrying a deadweight of nearly 8000 tons; and good order has succeeded chaos. From 1847 to 1860 an average of 203 British ships entered the Danube averaging 193 tons each; from 1861 to 1889, 486 ships averaging 796 tons; in 1893, 905 vessels of 1,287,762 tons, or 68% of the total traffic, and rather more than two and a half times the total amount of British tonnage visiting the Danube in the fourteen years between 1847 and 1860. The average amount of cereals (principally wheat) annually exported from the Danube during the period 1901-1905 was 13,000,000 quarters, *i.e.* about five times the average annual

<sup>1</sup> Ships pay no taxes to the commission on entering the river, but on leaving it every ship of over 1500 tons register pays 1s. 5d. per registered ton if loaded at Galatz or Braila, or 11d. per ton if loaded at Sulina. This includes pilotage and light dues. Smaller vessels pay less and ships of less than 300 tons are exempt.

exportation during the period 1861-1867. It has been calculated that between 1861 and 1902 the total tonnage of ships frequenting the Danube increased five-fold, while the mean size of individual ships increased ten-fold.

**BIBLIOGRAPHY.**—Marsiglius, *Danubius Pannonico-Mysicus* (the Hague, 1726); Schulte, *Donaufahrten* (1819-1829); Planche, *Descent of the Danube* (1828); Széchenyi, *Über die Donauschiffahrt* (1836); A. Müller, *Die Donau vom Ursprunge bis zu den Mündungen* (1839-1841); J. G. Kohl, *Die Donau* (Trieste, 1853-1854); G. B. Rennie, *Suggestions for the Improvement of the Danube* (1856); Sir C. A. Hartley, *Description of the Delta of the Danube* (1862 and 1874); *Mémoire sur le régime administratif établi aux embouchures du Danube* (Galatz, 1867); Desjardins, *Rhône et Danube, a defence of the canalization scheme* (Paris, 1870); *Carte du Danube entre Braila et la mer*, published by the European Commission (Leipzig, 1874); Peters, *Die Donau und ihr Gebiet, eine geologische Studie* (1876); A. F. Heksch, *Guide illustré sur le Danube* (Vienna, 1883); F. D. Millet, *The Danube* (New York, 1893); Schweiger-Lerchenfeld, *Die Donau als Völkerweg, Schiffsfahrtsstrasse, und Reiseroute* (Vienna, 1895); D. A. Sturza, *La Question des Portes de Fer et des cataractes du Danube* (Berlin, 1899); A. de Saint Clair, *Le Danube: étude de droit international* (Paris, 1899); D. A. Sturdza, *Recueil de documents relatifs à la liberté de navigation du Danube*, pp. 933 (Berlin, 1904); A. Schroth-U'kmar, *Donausagen von Passau bis Wien* (Vienna, 1904). (H. T. R.)

**DANVERS**, a township of Essex county, on the coast of Massachusetts, U.S.A., about 19 m. N. by E. of Boston. Pop. (1890) 7454; (1900) 8542, of whom 1873 were foreign-born; (1910 census) 9407. Danvers includes an area of 14 sq. m. of level country diversified by hills. There are several villages or business centres, the largest of which, bearing the same name as the township, is served by the Boston & Maine railway. In the township are a state insane asylum, with accommodation for 1000 patients; St John's Preparatory College (Roman Catholic), conducted by the Xavierian Brothers; and, in Peabody Park, the Peabody Institute, with a good public library and museum, the gift (1867) of George Peabody. The Danvers historical society has a valuable collection. Although chiefly a residential town, Danvers has various manufactures, the most important of which are leather, boots and shoes, bricks, boxes and electric lamps. The total value of the factory product in 1905 was \$2,017,908, of which more than one half was the value of leather. Danvers owns its water-works and its electric lighting and power plant. A part of what is now Danvers was included in the grant made by the court of assistants to Governor John Endecott and the Rev. Samuel Skelton of the Salem church in 1632. Danvers was set off from Salem as a district in 1752 and was incorporated as a township in 1757, but the act of incorporation was disallowed in 1759 by the privy council on the recommendation of the board of trade, in view of George II.'s disapproval of the incorporation of new townships at that time,—hence the significance of the words on the seal of Danvers, "The King Unwilling"; in 1775 the district was again incorporated. Salem Village, a part of the present township, was the centre of the famous witchcraft delusion in 1692. In 1885 South Danvers was set off as a separate township, and in 1868 was named Peabody in honour of George Peabody, who was born and is buried there. In 1857 part of Beverly was annexed to Danvers. Among distinguished natives of Danvers are Samuel Holton (1738-1816), a member (1778-1780 and 1782-1787) of the Continental Congress and (1793-1795) of the Federal Congress; Israel Putnam; Moses Porter (1755-1822), who served through the War of Independence and the War of 1812; and Grenville Mellen Dodge (b. 1831), a prominent railway engineer, who fought in the Union army in the Civil War, reaching the rank of major-general of volunteers, was a Republican member of the national House of Representatives in 1867-1869, and in 1898 president of the commission which investigated the management of the war with Spain.

See J. W. Hanson, *History of the Town of Danvers* (Danvers, 1848); Ezra D. Hines, *Historic Danvers* (Danvers, 1894) and *Historical Address* (Boston, 1907), in celebration of the 150th anniversary of the first incorporation; and A. P. White, "History of Danvers" in *History of Essex County, Mass.* (Philadelphia, 1888).

**DANVILLE**, a city and the county-seat of Vermilion county, Illinois, U.S.A., in the E. part of the state, near the Big Vermilion river, 120 m. S. of Chicago. Pop. (1890) 11,491; (1900) 16,354,



of whom 1435 were foreign-born; (1910) 27,871. Danville is served by the Chicago & Eastern Illinois (whose shops are here), the Wabash, the Chicago, Indiana & Southern, and the Cleveland, Cincinnati, Chicago & St Louis railways, and by three interurban lines. There are three public parks (Lincoln, Douglas and Ellsworth), a Carnegie library (1883), and a national home for disabled volunteer soldiers (opened in 1898). Situated in the vicinity of an extensive coalfield (the Grape Creek district), Danville has a large trade in coal; it has also several manufacturing establishments engaged principally in the construction and repair of railway cars, and in the manufacture of bricks, foundry products, glass, carriages, flour and hominy. The value of the factory products of the city in 1905 was \$3,304,120, an increase of 72.7% since 1900. Danville was first settled about 1830 and was first incorporated in 1839; in 1874 it was chartered as a city under the general state law of 1872 for the incorporation of municipalities. It annexed Vermilion Heights in 1905, South Danville (pop. in 1900, 898) in 1906, and Germantown (pop. in 1900, 1782) and Roselawn in 1907.

**DANVILLE**, a city and the county-seat of Boyle county, Kentucky, U.S.A., 113 m. S. by W. of Cincinnati. Pop. (1890) 3766; (1900) 4285 (1913 negroes) (1920) 5420. The city is served by the Southern and the Cincinnati Southern railways, the latter connecting at Junction city (4 m. S.) with the Louisville & Nashville railway. Danville is an attractive city, situated in the S.E. part of the fertile "Blue Grass region" of Kentucky. In McDowell Park there is a monument to the memory of Dr Ephraim McDowell (1771-1830), who after 1795 lived in Danville, and is famous for having performed in 1809 the first entirely successful operation for the removal of an ovarian tumour. Danville is the seat of several educational institutions, the most important of which is the Central University of Kentucky (Presbyterian), founded in 1901 by the consolidation of Centre College (opened at Danville in 1823), and the Central University (opened at Richmond, Ky., in 1874). The law school also is in Danville. The classical, scientific and literary department of the present university is still known as Centre College; the medical and dental departments are in Louisville, and the university maintains a preparatory school, the Centre College academy, at Danville. In 1908 the university had 87 instructors and 696 students. Other institutions at Danville are Caldwell College for women (1860; Presbyterian), and the Kentucky state institution for deaf mutes (1823). The Transylvania seminary was opened here in 1785, but four years later was removed to Lexington (*q.v.*), and a Presbyterian theological seminary was founded here in 1853, but was merged with the Louisville theological seminary (known after 1902 as the Presbyterian Theological Seminary of Kentucky) in 1901. The municipality owns and operates its water-works and power plant. From its first settlement in 1781 until the admission of Kentucky into the Union in 1792 Danville was an important political centre. There was an influential political club here from 1786 to 1790, and here, too, sat the several conventions—nine in all—which asked for a separation from Virginia, discussed the proposed conditions of separation from that commonwealth, framed the first state constitution, and chose Frankfort as the capital. Danville was incorporated in 1789. It was the birthplace of James G. Birney and of Theodore O'Hara.

**DANVILLE**, a borough and the county-seat of Montour county, Pennsylvania, U.S.A., on the N. branch of the Susquehanna river, about 65 m. N. by E. of Harrisburg. Pop. (1890) 7998; (1900) 8042, of whom 771 were foreign-born; (1906, estimate) 8066. It is served by the Delaware, Lackawanna & Western, and the Philadelphia & Reading railways, and by electric railway to Bloomsburg. The borough is built on an elevated bank of the river at the base of Montour Ridge, where the narrow valley appears to be shut in on every side by hills; the river is spanned by a steel bridge, built in 1905. Iron, coal and limestone abound in the vicinity, and the borough has large manufactories of stoves and furnaces, and of iron and steel, in one of which in 1845 a "T"-rail, probably the first in America, was rolled. It is the seat of a state hospital for the insane (established

in 1868). The water-works and electric light plant are owned and operated by the municipality. A settlement was first laid here about 1776 by Captain William Montgomery and his son Daniel; and a town was laid out in 1792 and called Dan's Town until the present name was adopted a few years later. Growth was slow until the discovery of iron ore on Montour Ridge, followed in 1832 by the completion of the N. branch of the Pennsylvania Canal, which runs through the centre of the borough. Danville was incorporated in 1849.

**DANVILLE**, a city in Pittsylvania county, Virginia, U.S.A., on the Dan river about 140 m. (by rail) S.W. of Richmond. Pop. (1890) 10,305; (1900) 16,520, of whom 6515 were negroes. It is on the main line of the Southern railway, and is the terminus of branches to Richmond and Norfolk; it is also served by the Danville & Western railway, a road (75 m. long) connecting with Stuart, Va., and controlled by the Southern, though operated independently. The city is built on high ground above the river. It has a city hall, a general hospital, a Masonic temple, and a number of educational institutions, including the Roanoke College (1860; Baptist), for young women; the Randolph-Macon Institute (1897; Methodist Episcopal, South), for girls; and a commercial college. The river furnishes valuable water-power, which is utilized by the city's manufactories (value of product in 1900, third in rank in the state, \$8,103,484, of which only \$3,693,792 was "factory" product; in 1905 the "factory" product was valued at \$4,774,818), including cotton mills—in 1905 Danville ranked first among the cities of the state in the value of cotton goods produced—a number of tobacco factories, furniture and overall factories, and flour and knitting mills. The city is a jobbing centre and wholesale market for a considerable area in southern Virginia and northern North Carolina, and is probably the largest loose-leaf tobacco market in the country, selling about 40,000,000 lb annually. In the industrial suburb of Schoolfield, which in 1908 had a population of about 3000, there is a large textile mill. The city owns and operates its water-supply system (with an excellent filtration plant installed in 1904) and its gas and electric lighting plants. Danville was settled about 1770, was first incorporated as a town in 1792, and became a city in 1833; it is politically independent of Pittsylvania county. To Danville, after the evacuation of Richmond on the 2nd of April 1865, the archives of the Confederacy were carried, and here President Jefferson Davis paused for a few days in his flight southward.

**DANZIG**, or **DANTSIC** (Polish *Gdansk*), a strong maritime fortress and seaport of Germany, capital of the province of West Prussia, on the left bank of the western arm of the Vistula, 4 m. S. of its entrance, at Neufahrwasser, into the Baltic, 253 m. N.E. from Berlin by rail. Pop. (1885) 114,805; (1905) 159,088. The city is traversed by two branches of the Mottlau, a small tributary of the Vistula, dredged to a depth of 15 ft., thus enabling large vessels to reach the wharves of the inner town. The strong fortifications which, with ramparts; bastions and wet ditches, formerly entirely surrounded the city, were removed on the north and west sides in 1895-1896, the trenches filled in, and the area thus freed laid out on a spacious plan. One portion, acquired by the municipality, has been turned into promenades and gardens, the Steffens Park, outside the Olivaer Tor, fifty acres in extent, occupying the north-western corner. The remainder of the massive defences remain, with twenty bastions, in the hands of the military authorities; the works for laying the surrounding country under water on the eastern side have been modernized, and the western side defended by a cordon of forts crowning the hills and extending down to the port of Neufahrwasser.

Danzig almost alone of larger German cities still preserves its picturesque medieval aspect. The grand old patrician houses of the days of its Hanseatic glory, with their lofty and often elaborately ornamented gables and their balconied windows, are the delight of the visitor to the town. Only one ancient feature is rapidly disappearing—owing to the exigencies of street traffic—the stone terraces close to the entrance doors and abutting on the street. Of its old gates the Hohe Tor, modelled after a Roman triumphal arch, is a remarkable monumental erection of the 16th

century. From it runs the Lange Gasse, the main street, to the Lange Markt. On this square stands the Artus- or Junker-hof (the merchant princes of the middle ages were in Germany styled *Junker*, squire); containing a hall richly decorated with wood carving and pictures; once used as a banqueting-room and now serving as the exchange. There are twelve Protestant and seven Roman Catholic churches and two synagogues. Of these the most important is St Mary's, begun in 1343 and completed in 1503, one of the largest Protestant churches in existence. It possesses a famous painting of the Last Judgment, formerly attributed to Jan van Eyck, but probably by Memlinc. Among other ancient buildings of note are the beautiful Gothic town hall, surmounted by a graceful spire; the armoury (Zeughaus) and the Franciscan monastery, restored in 1871, and now housing the municipal picture gallery and a collection of antiquities. Of modern structures, the government offices, the house of the provincial diet, the post office and the palace of the commander of the 17th army corps, which has its headquarters in Danzig, are the most noteworthy.

The manufacture of arms and artillery is carried on to a great extent, and the imperial and private docks and shipbuilding establishments, notably the Schichau yard, turn out ships of the largest size. The town is famous for its amber, beer, brandy and liqueurs, and its transit trade makes it one of the most important commercial cities of northern Europe. Danzig originally owed its commercial importance to the fact that it was the shipping port for the corn grown in Poland and the adjacent regions of Russia and Prussia; but for some few years past this trade has been slipping away from her. On the other hand, her trade in timber and sugar has grown proportionally. Nevertheless energetic efforts are being made to check any loss of importance—first, in 1898, by a determined attempt to make Danzig an industrial centre, manufacturing on a large scale; and secondly, by the construction and opening in 1890 of a free harbour at Neufahrwasser at the mouth of the Vistula. The industries which it has been the principal aim to foster and further develop are shipbuilding (naval and marine), steel foundries and rolling mills, sugar refineries, flour and oil mills, and distilleries.

*History.*—The origin of Danzig is unknown, but it is mentioned in 997 as an important town. At different times it was held by Pomerania, Poland, Brandenburg and Denmark, and in 1308 it fell into the hands of the Teutonic knights, under whose rule it long prospered. It was one of the four chief towns of the Hanseatic League. In 1455, when the Teutonic Order had become thoroughly corrupt, Danzig shook off its yoke and submitted to the king of Poland, to whom it was formally ceded, along with the whole of West Prussia, at the peace of Thorn. Although nominally subject to Poland, and represented in the Polish diets and at the election of Polish kings, it enjoyed the rights of a free city, and governed a considerable territory with more than thirty villages. It suffered severely through various wars of the 17th and 18th centuries, and in 1734, having declared in favour of Stanislus Leszczyński, was besieged and taken by the Russians and Saxons. At the first partition of Poland, in 1772, Danzig was separated from that kingdom; and in 1793 it came into the possession of Prussia. In 1807, during the war between France and Prussia, it was bombarded and captured by Marshal Lefebvre, who was rewarded with the title of duke of Danzig; and at the peace of Tilsit Napoleon declared it a free town, under the protection of France, Prussia and Saxony, restoring to it its ancient territory. A French governor, however, remained in it, and by compelling it to submit to the continental system almost ruined its trade. It was given back to Prussia in 1814.

See J. C. Schultz, *Danzig und seine Bauwerke* (Berlin, 1873); Wistulanus, *Geschichte der Stadt Danzig* (Danzig, 1891); *Défense de Danzig en 1813; documents militaires du lieutenant-général Campredon*, pub. by Auriel (Paris, 1888); Daniel, *Deutschland* (Leipzig, 1895).

**DAPHLA** (or **DAFLA**) **HILLS**, a tract of hilly country on the border of Eastern Bengal and Assam, occupied by an independent tribe called Daphla. It lies to the north of the Tezpur and North Lakhimpur subdivisions, and is bounded on the west by the Aka Hills and on the east by the Abor range. Colonel Dalton in

*The Ethnology of Bengal* considers the Daphlas to be closely allied to the hill Miris, and they are akin to and intermarry with the Abors. They have a reputation for cowardice, and as politically they are disunited, they are at the mercy of the Akas, their less numerous but more warlike neighbours on the west. Their clothing is scanty, and its most distinguishing feature is a cane cap with a fringe of bearskin or feathers, which gives them a very curious appearance. The men wear their hair in a plait, which is coiled into a ball on the forehead, to which they fasten their caps with a long skewer. In 1872 a party of independent Daphlas suddenly attacked a colony of their own tribesmen, who had settled at Amtola in British territory, and carried away forty-four captives to the hills. This led to the Daphla expedition of 1874, when a force of 1000 troops released the prisoners and reduced the tribe to submission. According to the census of 1901 the Daphlas in British territory numbered 954, the tribal country not being enumerated.

**DAPHNAE** (Tahpanhes, Taphne; mod. *Defenneh*), an ancient fortress near the Syrian frontier of Egypt, on the Pelusian arm of the Nile. Here King Psammetichus established a garrison of foreign mercenaries, mostly Carians and Ionian Greeks (Herodotus ii. 154). After the destruction of Jerusalem by Nebuchadrezzar in 588 B.C., the Jewish fugitives, of whom Jeremiah was one, came to Tahpanhes. When Naucratis was given by Amasis II. the monopoly of Greek traffic, the Greeks were all removed from Daphnae, and the place never recovered its prosperity; in Herodotus's time the deserted remains of the docks and buildings were visible. The site was discovered by Prof. W. M. Flinders Petrie in 1886; the name "Castle of the Jew's Daughter" seems to preserve the tradition of the Jewish refugees. There is a massive fort and enclosure; the chief discovery was a large number of fragments of pottery, which are of great importance for the chronology of vase-painting, since they must belong to the time between Psammetichus and Amasis, i.e. the end of the 7th or the beginning of the 6th century B.C. They show the characteristics of Ionian art, but their shapes and other details testify to their local manufacture.

See W. M. F. Petrie, *Tanis II., Nebesheh, and Defenneh* (4th Memoir of the Egypt Exploration Fund, 1888). (E. Gr.)

**DAPHNE** (Gr. for a laurel tree), in Greek mythology, the daughter of the Arcadian river-god Ladon or the Thessalian Peneus, or of the Laconian Amyclas. She was beloved by Apollo, and when pursued by him was changed by her mother Gaea into a laurel tree sacred to the god (Ovid, *Metam.* i. 452-567). In the Peloponnesian legends, another suitor of Daphne, Leucippus, son of Oenomatus of Pisa, disguised himself as a girl and joined her companions. His sex was discovered while bathing, and he was slain by the nymphs (Pausanias viii. 20; Parthenius, *Eroica*, 15).

**DAPHNE**, in botany, a genus of shrubs, belonging to the natural order Thymelaeaceae, and containing about forty species, natives of Europe and temperate Asia. *D. Laureola*, spurge laurel, a small evergreen shrub with green flowers in the leaf axils towards the ends of the branches and ovoid black very poisonous berries, is found in England in copses and on hedge-banks in stiff soils. *D. Mezereum*, mezereon, a rather larger shrub, 2 to 4 ft. high, has deciduous leaves, and bears fragrant pink flowers in clusters in the axils of last season's leaves, in early spring before the foliage. The bright red ovoid berries are cathartic, the whole plant is acrid and poisonous, and the bark is used medicinally. It is a native of Europe and north Asia, and found apparently wild in copses and woods in Britain. It is a well-known garden plant, and several other species of the genus are cultivated in the open air and as greenhouse plants. *D. Cneorum* (Europe) is a hardy evergreen trailing shrub, with bright pink sweet-scented flowers. *D. pontica* (Eastern Europe) is a hardy spreading evergreen with greenish-yellow fragrant flowers. *D. indica* (China) and *D. japonica* (Japan) are greenhouse evergreens with respectively red or white and pinkish-purple flowers.

**DAPHNEPHORIA**, a festival held every ninth year at Thebes in Boeotia in honour of Apollo Isménius or Galaxius. It consisted of a procession in which the chief figure was a boy of good family and noble appearance, whose father and mother must be alive.

Immediately in front of this boy, who was called Daphnephoros (laurel bearer), walked one of his nearest relatives, carrying an olive branch hung with laurel and flowers and having on the upper end a bronze ball from which hung several smaller balls. Another smaller ball was placed on the middle of the branch or pole (called *κωρῶ*), which was then twined round with purple ribbons, and at the lower end with saffron ribbons. These balls were said to indicate the sun, stars and moon, while the ribbons referred to the days of the year, being 365 in number. The Daphnephoros, wearing a golden crown, or a wreath of laurel, richly dressed and partly holding the pole, was followed by a chorus of maidens carrying suppliant branches and singing a hymn to the god. The Daphnephoros dedicated a bronze tripod in the temple of Apollo, and Pausanias (ix. 10. 4) mentions the tripod dedicated there by Amphitryon when his son Heracles had been Daphnephoros. The festival is described by Proclus (in Photius *cod.* 239).

See also A. Mommsen, *Feste der Stadt Athen* (1898); C. O. Müller, *Orchomenos* (1844); article in Daremberg and Saglio's *Dictionnaire des antiquités*.

**DAPHNIS**, the legendary hero of the shepherds of Sicily, and reputed inventor of bucolic poetry. The chief authorities for his story are Diodorus Siculus, Aelian and Theocritus. According to his countryman Diodorus (iv. 84), and Aelian (*Var. Hist.*, x. 18), Daphnis was the son of Hermes (in his character of the shepherd-god) and a Sicilian nymph, and was born or exposed and found by shepherds in a grove of laurels (whence his name.) He was brought up by the nymphs, or by shepherds, and became the owner of flocks and herds, which he tended while playing on the syrinx. When in the first bloom of youth, he won the affection of a nymph, who made him promise to love none but her, threatening that, if he proved unfaithful, he would lose his eyesight. He failed to keep his promise and was smitten with blindness. Daphnis, who endeavoured to console himself by playing the flute and singing shepherds' songs, soon afterwards died. He fell from a cliff, or was changed into a rock, or was taken up to heaven by his father Hermes, who caused a spring of water to gush out from the spot where his son had been carried off. Ever afterwards the Sicilians offered sacrifices at this spring as an expiatory offering for the youth's early death. There is little doubt that Aelian in his account follows Stesichorus (*q.v.*) of Himeras, who in like manner had been blinded by the vengeance of a woman (Helen) and probably sang of the sufferings of Daphnis in his recantation. Nothing is said of Daphnis's blindness by Theocritus, who dwells on his amour with Nais; his victory over Menalcas in a poetical competition; his love for Xenea brought about by the wrath of Aphrodite; his wanderings through the woods while suffering the torments of unrequited love; his death just at the moment when Aphrodite, moved by compassion, endeavours (but too late) to save him; the deep sorrow, shared by nature and all created things, for his untimely end (*Theocritus* i. vii. viii.). A later form of the legend identifies Daphnis with a Phrygian hero, and makes him the teacher of Marsyas. The legend of Daphnis and his early death may be compared with those of Narcissus, Linus and Adonis—all beautiful youths cut off in their prime, typical of the luxuriant growth of vegetation in the spring, and its sudden withering away beneath the scorching summer sun.

See F. G. Welcker, *Kleine Schriften zur griechischen Literaturgeschichte*, i. (1844); C. F. Hermann, *De Daphnide Theocriti* (1853); R. H. Klausen, *Aeneas und die Penaten*, i. (1840); R. Reitzenstein, *Epigramm und Skolion* (1893); H. W. Prescott in *Harvard Studies*, x. (1899); H. W. Stoll in Roscher's *Lexikon der Mythologie*; and G. Knaack in Pauly-Wissowa's *Realencyclopädie*.

**DARĀB** (originally **DARĀBGERD**), a district of the province of Fars in Persia. It has sixty-two villages, and possesses a hot climate, snow being rarely seen there in winter. It produces a great quantity of dates and much tobacco, which is considered the best in Persia. The town Darāb, the capital of the district, is situated in a very fertile plain, 140 m. S.E. of Shiraz. It has a population of about 5000, and extensive orchards of orange and lemon trees and immense plantations of date-palms. Legend ascribes the foundation of the city to Darius, hence its name Darāb-gerd (Darius-town). In the neighbourhood there are

various remains of antiquity, the most important of which 3½ m. S., is known as the Kalah i Darāb, or citadel of Darius, and consists of a series of earthworks arranged in a circle round an isolated rock. Nothing, however, remains to fix the date or explain the history of the fortification. Another monument in the vicinity is a gigantic bas-relief, carved on the vertical face of a rock, representing the victory of the Sassanian Shapur I. (Sapor) of Persia over the Roman emperor Valerian, A.D. 260.

**DARBHANGA**, a town and district of British India, in the Patna division of Bengal. The town is on the left bank of the Little Bagmati river, and has a railway station. Pop. (1901) 66,244. The town is really a collection of villages that have grown up round the residence of the raja. This is a magnificent palace, with gardens, a menagerie and a good library. There are a first-class hospital, with a Lady Dufferin hospital attached; a handsome market-place, and an Anglo-vernacular school. The district of Darbhanga extends from the Nepal frontier to the Ganges. It was constituted in 1875 out of the unwieldy district of Tirhoot. Its area is 3348 sq. m. In 1901 the population was 2,012,611, showing an increase of 4% in the decade. The district consists entirely of an alluvial plain, in which the principal rivers are the Ganges, Buri Gandak, Bagmati and Little Bagmati, Balan and Little Balan, and Tiljuga. The land is especially fertile in the more elevated part of the district S.W. of the Buri Gandak; rice is the staple crop, and it may be noted that the cultivator in Darbhanga is especially dependent on the winter harvest. The chief exports are rice, indigo, linseed and other seeds, saltpetre and tobacco. There are several indigo factories and saltpetre refineries, and a tobacco factory. The district is traversed by the main line of the Bengal & North-Western railway and by branch lines, part of which were begun as a famine relief work in 1874.

The maharaja bahadur of Darbhanga, a Rajput, whose ancestor Mahesh Thakor received the Darbhanga raj (which includes large parts of the modern districts of Darbhanga, Muzaffarpur, Monghyr, Purnea and Bhagalpur) from the emperor Akbar early in the 16th century, is not only the premier territorial noble of Behar but one of the greatest noblemen of all India. Maharaja Lachhmeswar Singh Bahadur, who succeeded to the raj in 1860 and died in 1898, was distinguished for his public services, and especially as one of the most munificent of living philanthropists. Under his supervision his raj came to be regarded as the model for good and benevolent management; he constructed hundreds of miles of roads planted with trees, bridged all the rivers, and constructed irrigation works on a great scale. His charities were without limit; thus he contributed £300,000 for the relief of the sufferers from the Bengal famine of 1873-1874, and it is computed that during his possession of the raj he expended at least £2,000,000 on charities, works of public utility, and charitable remissions of rent. For many years he served as a member of the legislative council of the viceroy with conspicuous ability and moderation of view. As representative of the landowners of Berar and Bengal he took an important part in the discussion on the Bengal Tenancy Bill. He was succeeded by his brother, Maharaja Rameshwar Singh Bahadur, who was born on the 16th of January 1860, and on attaining his majority in 1878 was appointed to the Indian Civil Service, serving as assistant magistrate successively at Darbhanga, Chhapra and Bhagalpur. In 1886 he was created a raja bahadur, exempted from attendance at the civil courts, and appointed a member of the legislative council of Bengal. He was created a maharaja bahadur on his succession to the raj in 1898. Like his brother, he was educated by an English tutor, and his administration carried on the enlightened traditions of his predecessor.

See Sir Roper Lethbridge, *The Golden Book of India*.

**D'ARBLAY, FRANCES** (1752-1840), English novelist and diarist, better known as **FANNY BURNEY**, daughter of Dr Charles Burney (*q.v.*), was born at King's Lynn, Norfolk, on the 13th of June 1752. Her mother was Esther Sleepe, granddaughter of a French refugee named Dubois. Fanny was the fourth child in a family of six. Of her brothers, James (1750-1821) became an admiral and sailed with Captain Cook on his second and third voyages, and Charles Burney (1757-1817) was a well-known

classical scholar. In 1760 the family removed to London, and Dr Burney, who was now a fashionable music master, took a house in Poland Street. Mrs Burney died in 1761, when Fanny was only nine years old. Her sisters Esther (Hetty), afterwards Mrs Charles Rousseau Burney, and Susanna, afterwards Mrs Phillips, were sent to school in Paris, but Fanny was left to educate herself. Early in 1766 she paid her first visit to Dr Burney's friend Samuel Crisp at Chessington Hall, near Epsom. Dr Burney had first made Samuel Crisp's acquaintance about 1745 at the house of Fulke Greville, grandfather of the diarists, and the two studied music while the rest of the guests hunted. Crisp wrote a play, *Virginia*, which was staged by David Garrick in 1754 at the request of the beautiful countess of Coventry (*née* Maria Gunning). The play had no great success, and in 1764 Crisp established himself in retirement at Chessington Hall, where he frequently entertained his sister, Mrs Sophia Gast, of Burford, Oxfordshire, and Dr Burney and his family, to whom he was familiarly known as "daddy" Crisp.<sup>1</sup> It was to her "daddy" Crisp and her sister Susan that Fanny Burney addressed large portions of her diary and many of her letters. After his wife's death in 1767, Dr Burney married Elizabeth Allen, widow of a King's Lynn wine-merchant.

From her fifteenth year Fanny lived in the midst of an exceptionally brilliant social circle, gathered round her father in Poland Street, and later in his new home in St Martin's Street, Leicester Fields. Garrick was a constant visitor, and would arrive before eight o'clock in the morning. Of the various "lyons" they entertained she leaves a graphic account, notably of Omai, the Otaheitan native, and of Alexis Orlov, the favourite of Catherine II. of Russia. Dr Johnson she first met at her father's home in March 1777. Her father's drawing-room, where she met many of the chief musicians, actors and authors of the day, was in fact Fanny's only school. Her reading, however, was by no means limited. Macaulay stated that in the whole of Dr Burney's library there was but one novel, Fielding's *Amelia*; but Austin Dobson points out that she was acquainted with the abbé Prévost's *Doyen de Killérine*, and with Marivaux's *Vie de Marianne*, besides *Clarissa Harlowe* and the books of Mrs Elizabeth Griffith and Mrs Frances Brooke. Her diary also contains the record of much more strenuous reading. Her step-mother, a woman of some cultivation, did not encourage habits of scribbling. Fanny, therefore, made a bonfire of her MSS., among them a *History of Caroline Evelyn*, a story containing an account of *Evelina's* mother. Luckily her journal did not meet with the same fate. The first entry in it was made on the 30th of May 1768, and it extended over seventy-two years. The earlier portions of it underwent wholesale editing in later days, and much of it was entirely obliterated. She planned out *Evelina*, or *A Young Lady's Entrance into the World*, long before it was written down. *Evelina* was published by Thomas Lowndes in the end of January 1778, but it was not until June that Dr Burney learned its authorship, when the book had been reviewed and praised everywhere. Fanny proudly told Mrs Thrale the secret. Mrs Thrale wrote to Dr Burney on the 22nd of July: "Mr Johnson returned home full of the Prayes of the *Book* I had lent him, and protesting that there were passages in it which might do *honour* to Richardson: we talk of it for ever, and he feels ardent after the denouement; he could not get *rid* of the Rogue, he said." Miss Burney soon visited the Thrales at Streatham, "the most consequential day I have spent since my birth" she calls the occasion. It was the prelude to much longer visits there. Dr Johnson's best compliments were made for her benefit, and eagerly transcribed in her diary. His affectionate friendship for "little Burney" only ceased with his death.

*Evelina* was a continued success. Sir Joshua Reynolds sat up all night to read it, as did Edmund Burke, who came next to Johnson in Miss Burney's esteem. She was introduced to Elizabeth Montagu and the other bluestocking ladies, to Richard Brinsley Sheridan, and to the gay Mrs Mary Cholmondeley, the sister of Peg Woffington, whose manners, as described in the diary,

<sup>1</sup> His letters to Mrs Gast and another sister, Anne, were edited with the title of *Burford Papers* (1906), by W. H. Hutton.

explain much of *Evelina*. At the suggestion of Mrs Thrale, and with offers of help from Arthur Murphy, and encouragement from Sheridan, Fanny began to write a comedy. Crisp, realizing the limitations of her powers, tried to dissuade her, and the piece, *The Willings*, was suppressed in deference to what she called a "hissing, groaning, catcalling epistle" from her two "daddies." Meanwhile her intercourse with Mrs Thrale proved very exacting, and left her little time for writing. She went with her to Bath in 1780, and was at Streatham again in 1781. Her next book was written partly at Chessington and after much discussion with Mr Crisp. *Cecilia; or, Memoirs of an Heiress*, by the author of *Evelina*, was published in 5 vols. in 1782 by Messrs Payne & Cadell (who paid the author £250—not £2000 as stated by Macaulay). If *Cecilia* has not quite the freshness and charm of *Evelina*, it is more carefully constructed, and contains many happy examples of what Johnson called Miss Burney's gift of "character-mongering." Burke sent her a letter full of high praise. But some of her friends found the writing too often modelled on Johnson's, and Horace Walpole thought the personages spoke too uniformly in character.

On the 24th of April 1783, Fanny Burney's "most judicious adviser and stimulating critic," "daddy" Crisp, died. He was her devoted friend, as she was to him, "the dearest thing on earth." The next year she was to lose two more friends. Mrs Thrale married Piozzi, and Johnson died. Fanny had met the celebrated Mrs Delany in 1783, and she now attached herself to her. Mrs Delany, who was living (1785) in a house near Windsor Castle presented to her by George III., was on the friendliest terms with both the king and queen, and Fanny was honoured with more than one royal interview. Queen Charlotte, soon afterwards, offered Miss Burney the post of second keeper of the robes, with a salary of £200 a year, which after some hesitation was accepted. Much has been said against Dr Burney for allowing the authoress of *Evelina* and *Cecilia* to undertake an office which meant separation from all her friends and a wearisome round of court ceremonial. On the other hand, it may be fairly urged that Fanny's literary gifts were really limited. She had written nothing for four years, and apparently felt she had used her best material. "What my daddy Crisp says," she wrote as early as 1779, "'that it would be the best policy, but for pecuniary advantages, for me to write no more,' is exactly what I have always thought since *Evelina* was published" (*Diary*, i. 258). Her misgivings as to her unfitness for court life were quite justified. From Queen Charlotte she received unvarying kindness, though she was not very clever with her waiting-maid's duties. She had to attend the queen's toilet, to take care of her lap-dog and her snuff-box, and to help her senior, Mrs Schwellenberg, in entertaining the king's equerries and visitors at tea. The constant association with Mrs Schwellenberg, who has been described as "a peevish old person of uncertain temper and impaired health, swaddled in the buckram of backstairs etiquette," proved to be the worst part of Fanny's duties. Her diary is full of amusing court gossip, and sometimes deals with graver matters, notably in the account of Warren Hastings' trial, and in the story of the beginning of George III.'s madness, as seen by a member of his household. But the strain told on her health, and after pressure both from Fanny and her numerous friends, Dr Burney prepared with her a joint memorial asking the queen's leave to resign. She left the royal service in July 1791 with a retiring pension of £100 a year, granted from the queen's private purse, and returned to her father's house at Chelsea. Dr Burney had been appointed organist at Chelsea Hospital in 1783, through Burke's influence.

In 1792 she became acquainted with a group of French exiles, who had taken a house, Juniper Hall, near Mickleham, where Fanny's sister, Mrs Phillips, lived. On the 31st of July 1793 she married one of the exiles, Alexandre D'Arblay, an artillery officer, who had been adjutant-general to La Fayette. They took a cottage at Bookham on the strength, it appears, of Miss Burney's pension. In 1793 she produced her *Brief Reflections relative to the Emigrant French Clergy*. Her son Alexandre was born on the 18th of December 1794. In the following spring

Sheridan produced at Drury Lane her *Edwy and Elgiva*, a tragedy which was not saved even by the acting of the Kembles and Mrs Siddons. The play was never printed. Money was now a serious object, and Madame D'Arbly was therefore persuaded to issue her next novel, *Camilla: or A Picture of Youth* (5 vols., 1796), by subscription. A month after publication Dr Burney told Horace Walpole that his daughter had made £2000 by the book, and this sum was almost certainly augmented later. It is interesting to note that Jane Austen was among the subscribers. Unfortunately its literary success was not as great. "How I like *Camilla*?" wrote Horace Walpole to Miss Hannah More (August 29th, 1796), "I do not care to say how little. Alas! she has reversed experience . . . this author knew the world and penetrated characters before she had stepped over the threshold; and, now she has seen so much of it, she has little or no insight at all: perhaps she apprehended having seen too much, and kept the bags of foul air that she brought from the Cave of Tempests too closely tied." Nevertheless *Camilla* has found judicious persons to admire it, notably Jane Austen in *Northanger Abbey*. A second play, *Love and Fashion*, was actually put in rehearsal in 1799, but was withdrawn in the next year. In 1801 Madame D'Arbly accompanied her husband to Paris, where General D'Arbly eventually obtained a place in the civil service. In 1812 she returned to England, bringing with her her son Alexandre to escape the conscription. In 1814 she published *The Wanderer; or Female Difficulties*. Possibly because readers expected to find a description of her impressions of revolutionary France, it had a large sale, from which the author realized £7000. Nobody, it has been said, ever read *The Wanderer*. In the end of the year General D'Arbly came to England and took his wife back to France. During the Hundred Days of 1815 she was in Belgium, and the vivid account in her Diary of Brussels during Waterloo may have been used by Thackeray in *Vanity Fair*. General D'Arbly now received permission to settle in England. After his death, which took place at Bath on the 3rd of May 1818, his wife lived in Bolton Street, Piccadilly. There she was visited in 1826 by Sir Walter Scott, who describes her (*Journal*, November 18th, 1826) as an elderly lady with no remains of personal beauty, but with a gentle manner and a pleasing countenance. The later years of her life were occupied with the editing of the *Memoirs of Dr Burney, arranged from his own Manuscripts, from family papers and from personal recollections* (3 vols., 1832). Her style had, as time went on, altered for the worse, and this book is full of extraordinary affectations. Madame D'Arbly died in London on the 6th of January 1840 and was buried at Walcot, Bath, near her son and husband.

Madame D'Arbly is still read in *Evelina*, but her best title to the affections of modern readers is the *Diary and Letters*. The small egotisms of the writer do not alienate other readers as they did John Wilson Croker. Dr Johnson lives in its pages almost as vividly as in those of Boswell, and King George and his wife in a friendlier light than in most of their contemporary portraits. Croker, in *The Quarterly Review*, April 1833 and June 1842, made two attacks on Madame D'Arbly. The first is an unfriendly but largely justifiable criticism on the *Memoirs of Dr Burney*. In the second, a review of the first three volumes of the *Diary and Letters*, Croker abused the writer's innocent vanity, and declared that, considering their bulk and pretensions, the *Diary and Letters* were "nearly the most worthless we have ever waded through." These pronouncements drew forth the eloquent defence by Lord Macaulay, first printed in *The Edinburgh Review*, January 1843, which, in spite of some inaccuracies and considerable exaggeration, has perhaps done more than anything else to maintain Madame D'Arbly's constant popularity.

**BIBLIOGRAPHY.**—The *Diary and Letters of Madame D'Arbly* was edited by her niece, Charlotte Frances Barrett, in 7 vols. (1842-1846). The text, covering the years 1778-1840, was edited with preface, notes and reproductions of contemporary portraits and other illustrations, by Mr Austin Dobson in 6 vols. (1904-1905). This *Diary*, which begins with the publication of *Evelina*, was supplemented in 1889 by *The Early Diary of Frances Burney* (1768-1778), which was in the first instance suppressed as being of purely private interest, edited by Mrs Annie Raine Ellis, with an introduction

giving many particulars of the Burney family. Mrs Ellis also edited *Evelina* for "Bohn's Novelist's Library" in 1881, and *Cecilia* in 1882. See also Austin Dobson's *Fanny Burney (Madame D'Arbly)* (1903), in the "English Men of Letters Series."

**DARBOY, GEORGES** (1813-1871), archbishop of Paris, was born at Fayl-Billot in Haut Marne on the 16th of January 1813. He studied with distinction at the seminary at Langres, and was ordained priest in 1836. Transferred to Paris as almoner of the college of Henry IV., and honorary canon of Notre Dame, he became the close friend of Archbishop Affre and of his successor Archbishop Sibour. He was appointed bishop of Nancy in 1859, and in January 1863 was raised to the archbishopric of Paris. The archbishop was a strenuous upholder of episcopal independence in the Gallican sense, and involved himself in a controversy with Rome by his endeavours to suppress the jurisdiction of the Jesuits and other religious orders within his diocese. Pius IX. refused him the cardinal's hat, and rebuked him for his liberalism in a letter which was probably not intended for publication. At the Vatican council he vigorously maintained the rights of the bishops, and strongly opposed the dogma of papal infallibility, against which he voted as inopportune. When the dogma had been finally adopted, however, he was one of the first to set the example of submission. Immediately after his return to Paris the war with Prussia broke out, and his conduct during the disastrous year that followed was marked by a devoted heroism which has secured for him an enduring fame. He was active in organizing relief for the wounded at the commencement of the war, remained bravely at his post during the siege, and refused to seek safety by flight during the brief triumph of the Commune. On the 4th of April 1871 he was arrested by the communists as a hostage, and confined in the prison at Mazas, from which he was transferred to La Roquette on the advance of the army of Versailles. On the 27th of May he was shot within the prison along with several other distinguished hostages. He died in the attitude of blessing and uttering words of forgiveness. His body was recovered with difficulty, and, having been embalmed, was buried with imposing ceremony at the public expense on the 7th of June. It is a noteworthy fact that Darboy was the third archbishop of Paris who perished by violence in the period between 1848 and 1871. Darboy was the author of a number of works, of which the most important are a *Vie de St Thomas Becket* (1859), a translation of the works of St Denis the Areopagite, and a translation of the *Imitation of Christ*.

See J. A. Foulon, *Histoire de la vie et des œuvres de Mgr. Darboy* (Paris, 1889), and J. Guillermin, *Vie de Mgr. Darboy* (Paris, 1888), biographies written from the clerical standpoint, which have called forth a number of pamphlets in reply.

**DARCY, THOMAS DARCY, BARON** (1467-1537), English soldier, was a son of Sir William Darcy (d. 1488), and belonged to a family which was seated at Templehurst in Yorkshire. In early life he served, both as a soldier and a diplomatist, in Scotland and on the Scottish borders, where he was captain of Berwick; and in 1505, having been created Baron Darcy, he was made warden of the east marches towards Scotland. In 1511 Darcy led some troops to Spain to help Ferdinand and Isabella against the Moors, but he returned almost at once to England, and was with Henry VIII. on his French campaign two years later. One of the most influential noblemen in the north of England, where he held several important offices, Darcy was also a member of the royal council, dividing his time between state duties in London and a more active life in the north. He showed great zeal in preparing accusations against his former friend, Cardinal Wolsey; however, after the cardinal's fall his words and actions caused him to be suspected by Henry VIII. Disliking the separation from Rome, Darcy asserted that matrimonial cases were matters for the decision of the spiritual power, and he was soon communicating with Eustace Chapuys, the ambassador of the emperor Charles V., about an invasion of England in the interests of the Roman Catholics. Detained in London against his will by the king, he was not allowed to return to Yorkshire until late in 1535, and about a year after his arrival in the north the rising known as the Pilgrimage of Grace broke out. For a short time Darcy defended Pontefract Castle against the rebels, but soon



he surrendered to them this stronghold, which he could certainly have held a little longer, and was with them at Doncaster, being regarded as one of their leaders. Upon the dispersal of the insurgents Darcy was pardoned, but he pleaded illness when Henry requested him to proceed to London. He may have assisted to suppress the rising which was renewed under Sir Francis Bigod early in 1537, but the king believed, probably with good reason, that he was guilty of fresh treasons, and he was seized and hurried to London. During his imprisonment he uttered his famous remark about Thomas Cromwell:—"Cromwell, it is thou that art the very original and chief causer of all this rebellion and mischief, . . . and I trust that or thou die, though thou wouldst procure all the noblemen's heads within the realm to be stricken off, yet shall there one head remain that shall strike off thy head." Tried by his peers, Darcy was found guilty of treason, and was beheaded on the 20th of June 1537. In 1548 his barony was revived in favour of his son George (d. 1557), but it became extinct on the death of George's descendant John in 1635.

**DARDANELLES** (Turk. *Bahr-Sefed Boghazi*), the strait, in ancient times called the Hellespont (*q.v.*), uniting the Sea of Marmora with the Aegean, so called from the two castles which protect the narrowest part and preserve the name of the city of Dardanus in the Troad, famous for the treaty between Sulla and Mithradates in 84 B.C. The shores of the strait are formed by the peninsula of Gallipoli on the N.W. and by the mainland of Asia Minor on the S.E.; it extends for a distance of about 47 m. with an average breadth of 3 or 4 m. At the Aegean extremity stand the castles of Sedil Bahr and Kum Kaleh respectively in Europe and Asia; and near the Marmora extremity are situated the important town of Gallipoli (Callipolis) on the northern side, and the less important though equally famous Lamsaki or Lapsaki (Lampsacus) on the southern. The two castles of the Dardanelles *par excellence* are Chanak-Kalehsi, Sultanieh-Kalehsi, or the Old Castle of Anatolia, and Kilid-Bahr, or the Old Castle of Rumelia, which were long but erroneously identified with Sestos and Abydos now located farther to the north. The strait of the Dardanelles is famous in history for the passage of Xerxes by means of a bridge of boats, and for the similar exploit on the part of Alexander. It is famous also from the story of Hero and Leander, and from Lord Byron's successful attempt (repeated by others) to rival the ancient swimmer. Strategically the Dardanelles is a point of great importance, since it commands the approach to Constantinople from the Mediterranean. The passage of the strait is easily defended, but in 1807 the English admiral (Sir) J. T. Duckworth made his way past all the fortresses into the Sea of Marmora. The treaty of July 1841, confirmed by the Paris peace of 1856, prescribed that no foreign ship of war might enter the strait except by Turkish permission, and even merchant vessels are only allowed to pass the castle of Chanak-Kalehsi during the day.

See Choiseul-Gouffier, *Voyage pittoresque* (Paris, 1842); Murray's *Handbook for Constantinople* (London, 1900).

**DARDANELLES** (Turk. *Sultanieh Kalehsi*, or *Chanak Kalehsi*), the chief town and seat of government of the lesser Turkish province of Bigha, Asia Minor. It is situated at the mouth of the Rhodius, and at the narrowest part of the strait of the Dardanelles, where its span is but a mile across. Its recent growth has been rapid, and it possesses a lyceum, a military hospital, a public garden, a theatre, quays and water-works. Exclusive of the garrison, the population is estimated at 13,000, of whom one-half are Turkish, and the remainder Greek, Jewish, Armenian and European. The town contains many mosques, Greek, Armenian and Catholic churches, and a synagogue. There is a resident Greek bishop. The civil governor, and the military commandants of the numerous fortresses on each side of the strait, are stationed here. Many important works have been added to the defences. The Ottoman fleet is stationed at Nagara (anc. *Abydos*). The average annual number of merchant vessels passing the strait is 12,000 and the regular commercial vessels calling at the port of Dardanelles are represented by numerous foreign agencies. Besides the Turkish telegraph service, the Eastern Telegraph Company has a station at Dardanelles, and

there are Turkish, Austrian, French and Russian post offices. The import trade consists of manufactures, sugar, flour, coffee, rice, leather and iron. The export trade consists of valonia (largely produced in the province), wheat, barley, beans, chick-peas, canary seed, liquorice root, pine and oak timber, wine and pottery. Excepting in the items of wine and pottery, the export trade shows steady increase. Every year sees a larger area of land brought under cultivation by immigrants, and adds to the number of mature (*i.e.* fruit-bearing) valonia trees. Vine-growers are discouraged by heavy fiscal charges, and by the low price of wine; many have uprooted their vineyards. The pottery trade is affected by change of fashion, and the factories are losing their importance. The lower quarters of the town were heavily damaged in the winter of 1900-1901 by repeated inundations caused by the overflow of the Rhodius.

See V. Cuinet, *Turquie d'Asie* (Paris, 1890-1900).

**DARDANUS**, in Greek legend, son of Zeus and Electra, the mythical founder of Dardanus on the Hellespont and ancestor of the Dardans of the Troad and, through Aeneas, of the Romans. His original home was supposed to have been Arcadia, where he married Chryse, who brought him as dowry the Palladium or image of Pallas, presented to her by the goddess herself. Having slain his brother Iasius or Iasion (according to others, Iasius was struck by lightning), Dardanus fled across the sea. He first stopped at Samothrace, and when the island was visited by a flood, crossed over to the Troad. Being hospitably received by Teucer, he married his daughter Batea and became the founder of the royal house of Troy.

See Apollodorus iii. 12; Diod. Sic. v. 48-75; Virgil, *Aeneid*, iii. 163 ff.; articles in Pauly-Wissowa's *Realencyclopädie* and Roscher's *Lexikon der Mythologie*.

**DARDISTAN**, a purely conventional name given by scientists to a tract of country on the north-west frontier of India. There is no modern race called Dards, and no country so named by its inhabitants, but the inhabitants of the right bank of the Indus, from the Kandia river to Batera, apply it to the dwellers on the left bank. In the scientific use of the appellation, Dardistan comprises the whole of Chitral, Yasin, Panyal, the Gilgit valley, Hunza and Nagar, the Astor valley, the Indus valley from Bunji to Batera, the Kohistan-Malazai, *i.e.* the upper reaches of the Panjkora river, and the Kohistan of Swat. The so-called Dard races are referred to by Pliny and Ptolemy, and are supposed to be a people of Aryan origin who ascended the Indus valley from the plains of the Punjab, reaching as far north as Chitral, where they dispossessed the Khos. They have left their traces in the different dialects, Khoswar, Burishki and Shina, spoken in the Gilgit agency.

The question of Dardistan is debated at length in Leitner's *Dardistan* (1877); Drew's *Jummoo and Kashmir Territories* (1875); Biddulph's *Tribes of the Hindu-Kush* (1880) and Durand's *The Making of a Frontier* (1899). For further details see GILGIT.

**DARES PHRYGIUS**, according to Homer (*Iliad*; v. 9) a Trojan priest of Hephaestus. He was supposed to have been the author of an account of the destruction of Troy, and to have lived before Homer (Aelian, *Var. Hist.* xi, 2). A work in Latin, purporting to be a translation of this, and entitled *Daretis Phrygii de excidio Trojae historia*, was much read in the middle ages, and was then ascribed to Cornelius Nepos, who is made to dedicate it to Sallust; but the language is extremely corrupt, and the work belongs to a period much later than the time of Nepos (probably the 5th century A.D.). It is doubtful whether the work as we have it is an abridgment of a larger Latin work or an adaptation of a Greek original. Together with the similar work of Dictys Cretensis (with which it is generally printed) the *De excidio* forms the chief source for the numerous middle age accounts of the Trojan legend. (See DICRYS; and O. S. von Fleschenberg, *Daresstudien*, 1908.)

**DAR-ES-SALAAM** ("The harbour of peace"), a seaport of East Africa, in 6° 50' S. 39° 20' E., capital of German East Africa. Pop. (1909) estimated at 24,000, including some 500 Europeans. The entrance to the harbor, which is perfectly sheltered (hence its name), is through a narrow opening in the palm-covered shore. The harbour is provided with a floating dock, completed in 1902. The town is built on the northern

sweep of the harbour and is European in character. The streets are wide and regularly laid out. The public buildings, which are large and handsome, include the government and customs offices on the quay opposite the spot where the mail boats anchor, the governor's house, state hospital, post office, and the Boma or barracks. Adjoining the governor's residence are the botanical gardens, where many European plants are tested with a view to acclimatization. There are various churches, and government and mission schools. In the town are the head offices of the Deutsch-Ostafrikanische Gesellschaft, the largest trading company in German East Africa. The mangrove swamps at the north-west end of the harbour have been drained and partially built over.

Until the German occupation nothing but an insignificant village existed at Dar-es-Salaam. In 1862 Said Majid, sultan of Zanzibar, decided to build a town on the shores of the bay, and began the erection of a palace, which was never finished, and of which but scanty ruins remain. In 1871 Said Majid died, and his scheme was abandoned. In 1876 Mr (afterwards Sir) William McKinnon began the construction of a road from Dar-es-Salaam to Victoria Nyanza, intending to make of Dar-es-Salaam an important seaport. This project however failed. In 1887 Dr Carl Peters occupied the bay in the name of the German East Africa Company. Fighting with the Arabs followed, and in 1889 the company handed over their settlement to the German imperial government. In 1891 the town was made the administrative capital of the colony. It is the starting point of a railway to Mrogoro, and is connected by overland telegraph via Ujiji with South Africa. A submarine cable connects the town with Zanzibar. Dar-es-Salaam was laid out by the Germans on an ambitious scale in the expectation that it would prove an important centre of commerce, but trade developed very slowly. Ivory, rubber and copal are the chief exports. The trade returns are included in those of German East Africa (*q.v.*).

**DARESTE DE LA CHAVANNE, ANTOINE ELISABETH CLÉOPHAS** (1820-1882), French historian, was born in Paris on the 28th of October 1820, of an old Lyons family. Educated at the École des Chartes, he became professor in the faculty of letters at Grenoble in 1844, and in 1849 at Lyons, where he remained nearly thirty years. He died on the 6th of August 1882. His works comprise: *Histoire de l'administration en France depuis Philippe-Auguste* (2 vols., 1848); *Histoire des classes agricoles en France depuis saint Louis jusqu'à Louis XVI* (2 vols., 1853 and 1858), now quite obsolete; and a *Histoire de France* (8 vols., 1865-1873), completed by a *Histoire de la Restauration* (2 vols., 1880), a good summary of the work of Veil-Castel, and by a *Histoire du Gouvernement de Juillet*, a dry enumeration of dates and facts. Before the publication of Lavisse's great work, Dareste's general history of France was the best of its kind; it surpassed in accuracy the work of Henri Martin, especially in the ancient periods, just as Martin's in its turn was an improvement upon that of Sismondi.

**DARESTE DE LA CHAVANNE, RODOLPHE MADELEINE CLÉOPHAS** (1824- ), French jurist, was born in Paris on the 25th of December 1824. He studied at the École des Chartes and the École de Droit, and starting early on a legal career he rose to be counsellor to the court of cassation (1877 to 1900). His first publication was an *Essai sur François Hotman* (1850), completed later by his publication of Hotman's correspondence in the *Revue historique* (1876), and he devoted the whole of his leisure to legal history. Of his writings may be mentioned *Les Anciennes Lois de l'Islande* (1881); *Mémoire sur les anciens monuments du droit de la Hongrie* (1885), and *Études d'histoire du droit* (1889). On Greek law he wrote some notable works: *Du prêt à la grosse chez les Athéniens* (1867); *Les Inscriptions hypothécaires en Grèce* (1885), *La Science du droit en Grèce: Platon, Aristote, Théophraste* (1893), and *Étude sur la loi de Gortyne* (1885). He collaborated with Théodore Reinach and B. Haussoullier in their *Recueil des inscriptions juridiques grecques* (1905), and his name is worthily associated with the edition of Philippe de Beaumanoir's *Coutumes de Beauvaisis*, published by Salmon (2 vols., 1899, 1900).

**DARFUR**, a country of east central Africa, the westernmost state of the Anglo-Egyptian Sudan. It extends from about 10° N. to 16° N. and from 21° E. to 27° 30' E., has an area of some 150,000 sq. m., and an estimated population of 750,000. It is bounded N. by the Libyan desert, W. by Wadai (French Congo), S. by the Bahr-el-Ghazal and E. by Kordofan. The two last-named districts are *mudirias* (provinces) of the Anglo-Egyptian Sudan. The greater part of the country is a plateau from 2000 to 3000 ft. above sea-level. A range of mountains of volcanic origin, the Jebel Marra, runs N. and S. about the line of the 24° E. for a distance of over 100 m., its highest points attaining from 5000 to 6000 ft. East to west this chain extends about 80 m. Eastward the mountains fall gradually into sandy, bush-covered steppes. North-east of Jebel Marra lies the Jebel Medob (3500 ft. high), a range much distorted by volcanic action, and Bir-el-Melh, an extinct volcano with a crater 150 ft. deep. South of Jebel Marra are the plains of Dar Dima and Dar Uma; S.W. of the Marra the plain is 4000 ft. above the sea. The watershed separating the basins of the Nile and Lake Chad runs north and south through the centre of the country. The mountains are scored by numerous *khors*, whose lower courses can be traced across the tableland. The khors formerly contained large rivers which flowed N.E. and E. to the Nile, W. and S.W. to Lake Chad, S. and S.E. to the Bahr-el-Ghazal. The streams going N.E. drain to the Wadi Melh, a dry river-bed which joins the Nile near Debba, but on reaching the plain the waters sink into the sandy soil and disappear. The torrents flowing directly east towards the Nile also disappear in the sandy deserts. The khors in the W., S.W. and S.,—the most fertile part of Darfur—contain turbulent torrents in the rainy season, when much of the southern district is flooded. Not one of the streams is perennial, but in times of heavy rainfall the waters of some khors reach the Bahr-el-Homr tributary of the Bahr-el-Ghazal. (For some 200 m. the Bahr-el-Homr marks the southern frontier of the country.) In the W. and S. water can always be obtained in the dry season by digging 5 or 6 ft. below the surface of the khors.

The climate, except in the south, where the rains are heavy and the soil is a damp clay, is healthy except after the rains. The rainy season lasts for three months, from the middle of June to the middle of September. In the neighbourhood of the khors the vegetation is fairly rich. The chief trees are the acacias whence gum is obtained, and baobab (*Adansonia digitata*); while the sycamore and, in the Marra mountains, the *Euphorbia candelabrum* are also found. In the S.W. are densely forested regions. Cotton and tobacco are indigenous. The most fertile land is found on the slopes of the mountains, where wheat, durra, *dukhn* (a kind of millet and the staple food of the people) and other grains are grown. Other products are sesame, cotton, cucumbers, water-melons and onions.

Copper is obtained from Hofrat-el-Nahas in the S.E., iron is wrought in the S.W.; and there are deposits of rock-salt in various places. The copper mines (in 9° 48' N. 24° 5' E.) are across the Darfur frontier in the Bahr-el-Ghazal province. The vein runs N.W. and S.E. and in places rises in ridges 2 ft. above the general level of ground. There is an immense quantity of ore. (silicate and carbonate) specimens containing 14% of metal. Camels and cattle are both numerous and of excellent breeds. Some of the Arab tribes, such as the Baggara, breed only cattle, those in the north and east confine themselves to rearing camels. Horses are comparatively rare; they are a small but sturdy breed. Sheep and goats are numerous. The ostrich, common in the eastern steppes, is bred by various Arab tribes, its feathers forming a valuable article of trade.

*Inhabitants*.—The population of Darfur consists of negroes and Arabs. The negro *For*, forming quite half the inhabitants, occupy the central highlands and part of the Dar Dima and Dar Uma districts; they speak a special language, and are subdivided into numerous tribes, of which the most influential are the Masabat, the Kunjara and the Kera. They are of middle height, and have rather irregular features. The *For* are described as clean and industrious, somewhat fanatical, but generally amenable to civilization, and freedom-loving. The *Massali* are

a negro tribe which, breaking off from the For some centuries back, have now much Arab blood, and speak Arabic; while the *Tunjur* are an Arab tribe which must have arrived in the Sudan at a very early date, as they have incorporated a large For element, and no longer profess Mahomedanism. The *Dago* (*Tago*) formerly inhabited Jebel Marra, but they have been driven to the south and west, where they maintain a certain independence in Dar Sula, but are treated as inferiors by the For. The *Zaghawa*, who inhabit the northern borders, are on the contrary regarded by the For as their equals, and have all the prestige of a race that at one time made its influence felt as far as Bornu. Among other tribes may be mentioned the Berti and Takruri, the Birgirid, the Beraunas, and immigrants from Wadai and Bagirmi, and Fula from west of Lake Chad. Genuine Arab tribes, e.g. the Baggara and Homr, are numerous, and they are partly nomadic and partly settled. The Arabs have not, generally speaking, mixed with the negro tribes. They are great hunters, making expeditions into the desert for five or six days at a time in search of ostriches.

Slaves, ostrich feathers, gum and ivory used to be the chief articles of trade, a caravan going annually by the Arbain ("Forty Days") road to Assiut in Egypt and taking back cloth, fire-arms and other articles. The slave trade has ceased, but feathers, gum and ivory still constitute the chief exports of the country. The principal imports are cotton goods, sugar and tea. There is also an active trade in camels and cattle.

The internal administration of the country is in the hands of the sultan, who is officially recognized as the agent of the Sudan government. The administrative system resembles that of other Mahomedan countries.

*Towns*.—The capital is El-Fasher, pop. about 10,000, on the western bank of the Wadi Tendelty in an angle formed by the junction of that wadi with the Wadi-el-Kho, one of the streams which flow towards the Bahr-el-Homr. Fasher is the residence of the sultan. There are a few fine buildings, but the town consists mainly of tukls and box-shaped straw sheds. It is 500 m. W.S.W. of Khartum. Dara, a small market town, is 110 m. S. of El-Fasher. Shakka is in the S.E. of the country near the Bahr-el-Homr, and was formerly the headquarters of the slave dealers.

*History*.—The Dago or Tago negroes, inhabitants of Jebel Marra, appear to have been the dominant race in Darfur in the earliest period to which the history of the country goes back. How long they ruled is uncertain, little being known of them save a list of kings. According to tradition the Tago dynasty was displaced, and Mahomedanism introduced, about the 14th century, by Tunjur Arabs, who reached Darfur by way of Bornu and Wadai. The first Tunjur king was Ahmed-el-Makur, who married the daughter of the last Tago monarch. Ahmed reduced many unruly chiefs to submission, and under him the country prospered. His great-grandson, the sultan Dali, a celebrated figure in Darfur histories, was on his mother's side a For, and thus was effected a union between the negro and Arab races. Dali divided the country into provinces, and established a penal code, which, under the title of *Kitab Dali* or Dali's Book, is still preserved, and shows principles essentially different from those of the Koran. His grandson Soleiman (usually distinguished by the Forian epithet *Solon*, the Arab or the Red) reigned from 1596 to 1637, and was a great warrior and a devoted Mahomedan. Soleiman's grandson, Ahmed Bahr (1682-1722), made Islam the religion of the state, and increased the prosperity of the country by encouraging immigration from Bornu and Bagirmi. His rule extended east of the Nile as far as the banks of the Atbara. Under succeeding monarchs the country, involved in wars with Sennar and Wadai, declined in importance. Towards the end of the 18th century a sultan named Mahommed Terab led an army against the Funj, but got no further than Omdurman. Here he was stopped by the Nile, and found no means of getting his army across the river. Unwilling to give up his project, Terab remained at Omdurman for months. He was poisoned by his wife at the instigation of disaffected chiefs, and the army returned to Darfur. The next monarch was Abd-er-Rahman, surnamed el-Raschid or the Just. It was during his reign that Napoleon

Bonaparte was campaigning in Egypt; and in 1799 Abd-er-Rahman wrote to congratulate the French general on his defeat of the Mamelukes. To this Bonaparte replied by asking the sultan to send him by the next caravan 2000 black slaves upwards of sixteen years old, strong and vigorous. To Abd-er-Rahman likewise is due the present situation of the *Fasher*, or royal township. The capital had formerly been at a place called Kobbé. Mahommed-el-Fadhl, his son, was for some time under the control of an energetic eunuch, Mahommed Kurra, but he ultimately made himself independent, and his reign lasted till 1839, when he died of leprosy. He devoted himself largely to the subjection of the semi-independent Arab tribes who lived in the country, notably the Rizighat, thousands of whom he slew. In 1821 he lost the province of Kordofan, which in that year was conquered by the Egyptians. Of his forty sons, the third, Mahommed Hassin, was appointed his successor. Hassin is described as a religious but avaricious man. In the later part of his reign he became involved in trouble with the Arab slave raiders who had seized the Bahr-el-Ghazal, looked upon by the Darfurians as their especial "slave preserve." The negroes of Bahr-el-Ghazal paid tribute of ivory and slaves to Darfur, and these were the chief articles of merchandise sold by the Darfurians to the Egyptian traders along the Arbain road to Assiut. The loss of the Bahr-el-Ghazal caused therefore much annoyance to the people of Darfur. Hassin died in 1873, blind and advanced in years, and the succession passed to his youngest son Ibrahim, who soon found himself engaged in a conflict with Zobeir (*q.v.*), the chief of the Bahr-el-Ghazal slave traders, and with an Egyptian force from Khartum. The war resulted in the destruction of the kingdom. Ibrahim was slain in battle in the autumn of 1874, and his uncle Hassab Alla, who sought to maintain the independence of his country, was captured in 1875 by the troops of the khedive, and removed to Cairo with his family. The Darfurians were restive under Egyptian rule. Various revolts were suppressed, but in 1879 General Gordon (then governor-general of the Sudan) suggested the reinstatement of the ancient royal family. This was not done, and in 1881 Slatin Bey (Sir Rudolf von Slatin) was made governor of the province. Slatin defended the province against the forces of the Mahdi, who were led by a Rizighat sheik named Madibbo, but was obliged to surrender (December 1883), and Darfur was incorporated in the Mahdi's dominions. The Darfurians found Dervish rule as irksome as that of the Egyptians had been, and a state of almost constant warfare ended in the gradual retirement of the Dervishes from Darfur. Following the overthrow of the khalifa at Omdurman in 1898 the new (Anglo-Egyptian) Sudan government recognized (1899) Ali Dinar, a grandson of Mahommed-el-Fadhl, as sultan of Darfur, on the payment by that chief of an annual tribute of £500. Under Ali Dinar, who during the *Mahdia* had been kept a prisoner in Omdurman, Darfur enjoyed a period of peace.

The first European traveller known to have visited Darfur was William George Browne (*q.v.*), who spent two years (1793-1795) at Kobbé. Sheik Mahommed-el-Tounsi travelled in 1803 through various regions of Africa, including Darfur, in search of Omar, his father, and afterwards gave to the world an account of his wanderings, which was translated into French in 1845 by M. Perron. Gustav Nachtigal in 1873 spent some months in Darfur, and since that time the country has become well known through the journeys of Gordon, Slatin and others.

*AUTHORITIES*.—Browne's account of Darfur will be found in his *Travels in Africa, Egypt and Syria* (London, 1799); Nachtigal's *Sahara and Sudan* gives the results of that traveller's observations. The first ten chapters of Slatin Pasha's book *Fire and Sword in the Sudan* (English edition, London, 1896) contain much information concerning the country, its history, and a full account of the overthrow of Egyptian authority by the Mahdi. See also *The Anglo-Egyptian Sudan* (London, 1905), edited by Count Gleichen, and the bibliography given under *SUDAN*.

**DARGAI**, the name of a mountain peak and a frontier station in the north-west Frontier Province of India. The mountain peak is situated on the Samana Range, and the Kohat border, and is famous for the stand made there by the Afridis and Orakzais in

the Tirah Campaign. (See TIRAH CAMPAIGN.) Dargai station is situated on the Peshawar border, and is the terminus of the frontier railway running from Nowshera to the Malakand Pass.

**DARGOMIJSKY, ALEXANDER SERGEIVICH** (1813-1869), Russian composer, was born in 1813, and educated in St Petersburg. He was already known as a talented musical amateur when in 1833 he met Glinka and was encouraged to devote himself to composition. His light opera *Esmeralda* was written in 1839, and his *Roussalka* was performed in 1856, but he had but small success or recognition either at home or abroad, except in Belgium, till the 'sixties, when he became one of Balakirev's circle. His opera *The Stone Guest* then became famous among the progressive Russian school, though it was not performed till 1872. Dargomijsky died in January 1869. His compositions include a number of songs, and some orchestral pieces.

**DARIAL**, a gorge in the Caucasus, at the east foot of Mt. Kasbek, pierced by the river Terek for a distance of 8 m. between vertical walls of rock (5900 ft.). It is mentioned in the Georgian annals under the names of Ralani, Dargani, Darialani; the Persians and Arabs knew it as the Gate of the Alans; Strabo calls it *Porta Caucasica* and *Porta Cumana*; Ptolemy, *Porta Sarmatica*; it was sometimes known as *Portae Caspiae* (a name bestowed also on the "gate" or pass beside the Caspian at Derbent); and the Tatars call it *Darioly*. Being the only available passage across the Caucasus, it has been fortified since a remote period—at least since 150 B.C. In Russian poetry it has been immortalized by Lermontov. The present Russian fort, Darial, which guards this section of the Georgian military road, is at the northern issue of the gorge, at an altitude of 4746 ft.

**DARIEN**, a district covering the eastern part of the isthmus joining Central and South America. It is mainly within the republic of Panama, and gives its name to a gulf of the Caribbean Sea. Darien is of great interest in the history of geographical discovery. It was reconnoitred in the first year of the 16th century by Rodrigo Bastidas of Seville; and the first settlement was Santa Maria la Antigua, situated on the small Darien river, north-west of the mouth of the Atrato. In 1513 Vasco Nuñez de Balboa stood "silent upon a peak in Darien,"<sup>1</sup> and saw the Pacific at his feet stretching inland in the Gulf of San Miguel; and for long this narrow neck of land seemed alternately to proffer and refuse a means of transit between the two oceans. The first serious attempt to turn the isthmus to permanent account as a trade route dates from the beginning of the 18th century, and forms an interesting chapter in Scottish history. In 1695 an act was passed by the Scottish parliament giving extensive powers to a company trading to Africa and the Indies; and this company, under the advice of one of the most remarkable economists of the period, William Paterson (*q.v.*), determined to establish a colony on the isthmus of Darien as a general emporium for the commerce of all the nations of the world. Regarded with disfavour both in England and Holland, the project was taken up in Scotland with the enthusiasm of national rivalry towards England, and the "subscriptions sucked up all the money in the country." On the 26th of July 1698 the pioneers set sail from Leith amid the cheers of an almost envious multitude; and on the 4th of November, with the loss of only fifteen out of 1200 men, they arrived at Darien, and took up their quarters in a well-defended spot, with a good harbour and excellent outlook. The country they named New Caledonia, and two sites selected for future cities were designated respectively New Edinburgh and New St Andrews. At first all seemed to go well; but by and by lack of provisions, sickness and anarchy reduced the settlers to the most miserable plight; and in June 1699 they re-embarked in three vessels, a weak and hopeless company, to sail whithersoever Providence might direct. Meanwhile a supplementary expedition had been prepared in Scotland; two vessels were despatched in May, and four others followed in August. But this venture proved even more unfortunate than the former. The colonists arrived broken in health; their spirits were crushed

<sup>1</sup> Keats, in his famous sonnet beginning:—"Much have I travelled in the realms of gold," of which this is the concluding line, inaccurately substitutes Cortez for Balboa.

by the fate of their predecessors, and embittered by the harsh fanaticism of the four ministers whom the general assembly of the Church of Scotland had sent out to establish a regular presbyterial organization. The last addition to the settlement was the company of Captain Alexander Campbell of Fonab, who arrived only to learn that a Spanish force of 1500 or 1600 men lay encamped at Tubacanti, on the river Santa Maria, waiting for the appearance of a Spanish squadron in order to make a combined attack on the fort. Captain Campbell, on the second day after his arrival, marched with 200 men across the isthmus to Tubacanti, stormed the camp in the night-time, and dispersed the Spanish force. On his return to the fort on the fifth day he found it besieged by the Spaniards from the men-of-war; and, after a vain attempt to maintain its defence, he succeeded with a few companions in making his escape in a small vessel. A capitulation followed, and the Darien colony was no more. Of those who had taken part in the enterprise only a miserable handful ever reached their native land.

See J. H. Burton, *The Darien Papers* (Bannatyne Club, 1849); Macaulay, *History of England* (London, 1866); and A. Lang, *History of Scotland*, vol. iv. (Edinburgh, 1907).

**DARIUS** (Pers. *Dārayavaush*; Old Test. *Daryavesh*), the name of three Persian kings.

1. **DARIUS THE GREAT**, the son of Hystaspes (*q.v.*). The principal source for his history is his own inscriptions, especially the great inscription of Behistun (*q.v.*), in which he relates how he gained the crown and put down the rebellions. In modern times his veracity has often been doubted, but without any sufficient reason; the whole tenor of his words shows that we can rely upon his account. The accounts given by Herodotus and Ctesias of his accession are in many points evidently dependent on this official version, with many legendary stories interwoven, *e.g.* that Darius and his allies left the question as to which of them should become king to the decision of their horses, and that Darius won the crown by a trick of his groom.

Darius belonged to a younger branch of the royal family of the Achaemenidae. When, after the suicide of Cambyses (March 521), the usurper Gaumata ruled undisturbed over the whole empire under the name of Bardiya (Smerdis), son of Cyrus, and no one dared to gainsay him, Darius, "with the help of Ahuramazda," attempted to regain the kingdom for the royal race. His father Hystaspes was still alive, but evidently had not the courage to urge his claims. Assisted by six noble Persians, whose names he proclaims at the end of the Behistun inscription, he surprised and killed the usurper in a Median fortress (October 521; for the chronology of these times cf. E. Meyer, *Forschungen zur alten Geschichte*, ii. 472 ff.), and gained the crown. But this sudden change was the signal for an attempt on the part of all the eastern provinces to regain their independence. In Susiana, Babylon, Media, Sagartia, Margiana, usurpers arose, pretending to be of the old royal race, and gathered large armies around them; in Persia itself Vahyazdāta imitated the example of Gaumata and was acknowledged by the majority of the people as the true Bardiya. Darius with only a small army of Persians and Medes and some trustworthy generals overcame all difficulties, and in 520 and 519 all the rebellions were put down (Babylon rebelled twice, Susiana even three times), and the authority of Darius was established throughout the empire.

Darius in his inscriptions appears as a fervent believer in the true religion of Zoroaster. But he was also a great statesman and organizer. The time of conquests had come to an end; the wars which Darius undertook, like those of Augustus, only served the purpose of gaining strong natural frontiers for the empire and keeping down the barbarous tribes on its borders. Thus Darius subdued the wild nations of the Pontic and Armenian mountains, and extended the Persian dominion to the Caucasus; for the same reasons he fought against the Sacae and other Turanian tribes. But by the organization which he gave to the empire he became the true successor of the great Cyrus. His organization of the provinces and the fixing of the tributes is described by Herodotus iii. 90 ff., evidently from good official sources. He fixed the coinage and introduced the gold coinage

of the Daric (which is not named after him, as the Greeks believed, but derived from a Persian word meaning "gold"; in Middle Persian it is called *zarig*). He tried to develop the commerce of the empire, and sent an expedition down the Kabul and the Indus, led by the Carian captain Scylax of Caryanda, who explored the Indian Ocean from the mouth of the Indus to Suez. He dug a canal from the Nile to Suez, and, as the fragments of a hieroglyphic inscription found there show, his ships sailed from the Nile through the Red Sea by Saba to Persia. He had connexions with Carthage (*i.e.* the *Karkā* of the Nakshi Rustam inscr.), and explored the shores of Sicily and Italy. At the same time he attempted to gain the good-will of the subject nations, and for this purpose promoted the aims of their priests. He allowed the Jews to build the Temple of Jerusalem. In Egypt his name appears on the temples which he built in Memphis, Edfu and the Great Oasis. He called the high-priest of Saïs, Uzahor, to Susa (as we learn from his inscription in the Vatican), and gave him full powers to reorganize the "house of life," the great medical school of the temple of Saïs. In the Egyptian traditions he is considered as one of the great benefactors and lawgivers of the country (Herod. ii. 110, Diod. i. 95). In similar relations he stood to the Greek sanctuaries (*cf.* his rescript to "his slave" Godatas, the inspector of a royal park near Magnesia, on the Maeander, in which he grants freedom of taxes and forced labour to the sacred territory of Apollo. See Cousin and Deschamps, *Bulletin de corresp. hellén.*, xiii. (1889), 529, and Dittenberger, *Sylloge inscr. graec.*, 2); all the Greek oracles in Asia Minor and Europe therefore stood on the side of Persia in the Persian wars and admonished the Greeks to attempt no resistance.

About 512 Darius undertook a war against the Scythians. A great army crossed the Bosphorus, subjugated eastern Thrace, and crossed the Danube. The purpose of this war can only have been to attack the nomadic Turanian tribes in the rear and thus to secure peace on the northern frontier of the empire. It was based upon a wrong geographical conception; even Alexander and his Macedonians believed that on the Hindu Kush (which they called *Caucasus*) and on the shores of the Jaxartes (which they called *Tanais, i.e.* Don) they were quite near to the Black Sea. Of course the expedition undertaken on these grounds could not but prove a failure; having advanced for some weeks into the Russian steppes, Darius was forced to return. The details given by Herodotus (according to him Darius had reached the Volga!) are quite fantastical; and the account which Darius himself had given on a tablet, which was added to his great inscription in Behistun, is destroyed with the exception of a few words. (See R. W. Macan, *Herodotus*, vol. ii. appendix 3; G. B. Grundy, *Great Persian War*, pp. 48-64; J. B. Bury in *Classical Review*, July 1897.)

Although European Greece was intimately connected with the coasts of Asia Minor, and the opposing parties in the Greek towns were continually soliciting his intervention, Darius did not meddle with their affairs. The Persian wars were begun by the Greeks themselves. The support which Athens and Eretria gave to the rebellious Ionians and Carians made their punishment inevitable as soon as the rebellion had been put down. But the first expedition, that of Mardonius, failed on the cliffs of Mt. Athos (492), and the army which was led into Attica by Datis in 490 was beaten at Marathon. Before Darius had finished his preparations for a third expedition an insurrection broke out in Egypt (486). In the next year Darius died, probably in October 485, after a reign of thirty-six years. He is one of the greatest rulers the east has produced.

2. DARIUS II., OCHUS. Artaxerxes I., who died in the beginning of 424, was followed by his son Xerxes II. But after a month and a half he was murdered by his brother Secydianus, or Sogdianus (the form of the name is uncertain). Against him rose a bastard brother, Ochus, satrap of Hyrcania, and after a short fight killed him, and suppressed by treachery the attempt of his own brother Arsites to imitate his example (Ctesias *op. cit.* Phot. 44; Diod. xii. 71, 108; Pausan. vi. 5, 7). Ochus adopted the name Darius (in the chronicles called *Nothos*, the bastard). Neither Xerxes II. nor Secydianus occurs in the dates of the numerous Babylonian tablets from Nippur; here the dates of Darius II.

follow immediately on those of Artaxerxes I. Of Darius II.'s reign we know very little (a rebellion of the Medes in 409 is mentioned in Xenophon, *Hellen.* i. 2. 19), except that he was quite dependent on his wife Parysatis. In the excerpts from Ctesias some harem intrigues are recorded, in which he played a disreputable part. As long as the power of Athens remained intact he did not meddle in Greek affairs; even the support which the Athenians in 413 gave to the rebel Amorges in Caria would not have roused him (Andoc. iii. 29; Thuc. viii. 28, 54; Ctesias wrongly names his father Pissuthnes in his stead; an account of these wars is contained in the great Lycian stele from Xanthus in the British Museum), had not the Athenian power broken down in the same year before Syracuse. He gave orders to his satraps in Asia Minor, Tissaphernes and Pharnabazus, to send in the overdue tribute of the Greek towns, and to begin war with Athens; for this purpose they entered into an alliance with Sparta. In 408 he sent his son Cyrus to Asia Minor, to carry on the war with greater energy. In 404 he died after a reign of nineteen years, and was followed by Artaxerxes II.

3. DARIUS III., CODOMANNUS. The eunuch Bagoas (*q.v.*), having murdered Artaxerxes III. in 338 and his son Arses in 336, raised to the throne a distant relative of the royal house, whose name, according to Justin x. 3, was Codomannus, and who had excelled in a war against the Cadusians (*cf.* Diod. xvii. 5 ff., where his father is called Arsames, son of Ostanes, a brother of Artaxerxes). The new king, who adopted the name of Darius, took warning by the fate of his predecessors, and saved himself from it by forcing Bagoas to drink the cup himself. Already in 336 Philip II. of Macedon had sent an army into Asia Minor, and in the spring of 334 the campaign of Alexander began. In the following year Darius himself took the field against the Macedonian king, but was beaten at Issus and in 331 at Arbela. In his flight to the east he was deposed and killed by Bessus (July 330).

The name Darius was also borne by many later dynasts of Persian origin, among them kings of Persis (*q.v.*), Darius of Media Atropatene who was defeated by Pompeius, and Darius, king of Pontus in the time of Antony. (Ed. M.)

**DARJEELING**, a hill station and district of British India, in the Bhagalpur division of Bengal. The sanatorium is situated 367 m. by rail north of Calcutta. In 1901 it had a population of 16,924. It is the summer quarters of the Bengal government and has a most agreeable climate, which neither exceeds 80° F. in summer, nor falls below 30° in winter. The great attraction of Darjeeling is its scenery, which is unspeakably grand. The view across the hills to Kinchinjunga discloses a glittering white wall of perpetual snow, surrounded by towering masses of granite. There are several schools of considerable size for European boys and girls, and a government boarding school at Kurseong. The buildings and the roads suffered severely from the earthquake of the 12th of June 1897. But a more terrible disaster occurred in October 1899, when a series of landslips carried away houses and broke up the hill railway. The total value of the property destroyed was returned at £160,000.

The district of Darjeeling comprises an area of 1164 sq. m. It consists of two well-defined tracts, *viz.* the lower Himalayas to the south of Sikkim, and the *tarai*, or plains, which extend from the south of these ranges as far as the northern borders of Purnea district. The plains from which the hills take their rise are only 300 ft. above sea-level; the mountains ascend abruptly in spurs of 6000 to 10,000 ft. in height. The scenery throughout the hills is picturesque, and in many parts magnificent. The two highest mountains in the world, Kinchinjunga in Sikkim (28,156 ft.) and Everest in Nepal (29,002 ft.), are visible from the town of Darjeeling. The principal peaks within the district are—Phalut (11,811 ft.), Subargum (11,636), Tanglu (10,084), Situng and Sinchal Pahai (8163). The chief rivers are the Tista, Great and Little Ranjit, Ramman, Mahananda, Balasan and Jaldhaka. None of them is navigable in the mountain valleys; but the Tista, after it debouches on the plains, can be navigated by cargo boats of considerable burthen. Bears, leopards and musk deer are found on the higher mountains, deer on the lower ranges, and



a few elephants and tigers on the slopes nearest to the plains. In the lowlands, tigers, rhinoceroses, deer and wild hogs are abundant. A few wolves are also found. Of small game, hares, jungle fowl, peacocks, partridges, snipe, woodcock, wild ducks and geese, and green pigeons are numerous in the *tarai*, and jungle fowl and pheasants in the hills. The mahseer fish is found in the Tista.

In 1901 the population was 249,117, showing an increase of 12% since 1891, compared with an increase of 43% in the previous decade. The inhabitants of the hilly tract consist to a large extent of Nepali immigrants and of aboriginal highland races; in the *tarai* the people are chiefly Hindus and Mahomedans. The Lepchas are considered to be the aboriginal inhabitants of the hilly portion of the district. They are a fine, frank race, naturally open-hearted and free-handed, fond of change and given to an out-door life; but they do not seem to improve on being brought into contact with civilization. It is thought that they are now being gradually driven out of the district, owing to the increase of regular cultivation, and to the government conservation of the forests. They have no word for plough in their language, and they still follow the nomadic form of tillage known as *jum* cultivation. This consists in selecting a spot of virgin soil, clearing it of forest and jungle by burning, and scraping the surface with the rudest agricultural implements. The productive powers of the land become exhausted in a few years, when the clearing is abandoned, a new site is chosen, and the same operations are carried on *de novo*. The Lepchas are also the ordinary out-door labourers on the hills. They have no caste distinctions but speak of themselves as belonging to one of nine septs or clans, who all eat together and intermarry with each other. In the upper or northern *tarai*, along the base of the hills, the Mechs form the principal ethnical feature. This tribe inhabits the deadly jungle with impunity, and cultivates cotton, rice and other ordinary crops, by the *jum* process described above. The cultivation of tea was introduced in 1856, and is now a large industry. Cinchona cultivation was introduced by the government in 1862, and has since been taken up by private enterprise. There is a coal mine at Daling. The Darjeeling Himalayan railway of 2 ft. gauge, opened in 1880, runs for 50 m. from Siliguri in the plains on the Eastern Bengal line.

The British connexion with Darjeeling dates from 1816, when, at the close of the war with Nepali, the British made over to the Sikkim raja the *tarai* tract, which had been wrested from him and annexed by Nepâl. In 1835 the nucleus of the present district of British Sikkim or Darjeeling was created by a cession of a portion of the hills by the raja of Sikkim to the British as a sanatorium. A military expedition against Sikkim, rendered necessary in 1850 by the imprisonment of Dr A. Campbell, the superintendent of Darjeeling, and Sir Joseph Hooker, resulted in the stoppage of the allowance granted to the raja for the cession of the hill station of Darjeeling, and in the annexation of the Sikkim *tarai* at the foot of the hills and of a portion of the hills beyond. In August 1866 the hill territory east of the Tista, acquired as the result of the Bhutan campaign of 1864, was added to the jurisdiction of Darjeeling.

**DARLEY, GEORGE** (1795-1846), Irish poet, was born in Dublin in 1795. His parents, who were gentle folks of independent means, emigrated to America, leaving the boy in charge of his grandfather at Springfield, Co. Dublin. He was educated at Trinity College, Dublin, graduating in 1820; but an unfortunate stammer prevented him from going into the church or to the bar, and he established himself in London, where he published his first volume of poems, the *Errors of Ecstasie*, in 1822, and became a regular contributor to *The London Magazine*. He was intimate with Cary, the translator of Dante, and with Charles Lamb. In 1826 he published under the name of "Grey Penseval" a volume of prose tales and sketches, *Labour in Idleness* (1826), one of which, "The Enchanted Lyre," is plainly autobiographical. *Sylvia, or the May Queen* (1827, reprint 1892), a fairy opera, met with no success, but about 1830 he became dramatic and art critic to the *Athenaeum*. His other works are: *Nepenthe* (1835, reprint 1897), his most considerable poem; introduction to the works of Beaumont and Fletcher (1840); with two plays,

*Thomas à Becket* (1840), and *Ethelstan* (1841). He died in London on the 23rd of November 1846.

*Selections from the Poems of George Darley*, with an introduction by R. A. Streatfield, appeared in 1904. See also the edition by Ramsay Colles in the "Muses' Library" (1906).

**DARLING, GRACE HORSLEY** (1815-1842), British heroine, was born at Bamborough, Northumberland, on the 24th of November 1815. Her father, William Darling, was the keeper of the Longstone (Farne Islands) lighthouse. On the morning of the 7th of September 1838, the "Forfarshire," bound from Hull to Dundee, with sixty-three persons on board, struck on the Farne Islands, forty-three being drowned. The wreck was observed from the lighthouse, and Darling and his daughter determined to try and reach the survivors. They recognized that though they might be able to get to the wreck, they would be unable to return without the assistance of the shipwrecked crew, but they took this risk without hesitation. By a combination of daring, strength and skill, the father and daughter reached the wreck in their coble and brought back four men and a woman to the lighthouse. Darling and two of the rescued men then returned to the wreck and brought off the four remaining survivors. This gallant exploit made Grace Darling and her father famous. The Humane Society at once voted them its gold medal, the treasury made a grant, and a public subscription was organized. Grace Darling, who had always been delicate, died of consumption on the 20th of October 1842.

See *Grace Darling, her true story* (London, 1880).

**DARLING**, a river of Australia. It rises in Queensland and flows into New South Wales, forming for a considerable distance the boundary of the two colonies; in its upper reaches it is known as the Barwon, but from Bourke to its junction on the Victorian border with the river Murray, it is called the Darling. Its length is 1160 m., and with its affluents it drains an area of about 200,000 sq. m. During the dry season its course is marked by a series of shallow pools, but during the winter, when it is subject to sudden floods, it is navigable as far as Bourke for steamers of light draft. Excepting a narrow strip on the banks of the river, the country through which it passes is, for the most part, an arid plain.

**DARLINGTON**, a market town and municipal and parliamentary borough of Durham, England, 232 m. N. by W. of London, on the North-Eastern railway. Pop. (1891) 38,060; (1901) 44,511. It lies in a slightly undulating plain on the small river Skerne, a tributary of the Tees, not far from the main river. Its appearance is almost wholly modern, but there is a fine old parish church dedicated to St Cuthbert. It is cruciform, and in style mainly transitional Norman. It has a central tower surmounted by a spire of the 14th century, which necessitated the building of a massive stone screen across the chancel arch to support the piers. Traces of an earlier church were discovered in the course of restoration. Educational establishments include an Elizabethan grammar school, a training college for school-mistresses (British and Foreign School Society), and a technical school. There is a park of forty-four acres. The industries of Darlington are large and varied. They include worsted spinning mills; collieries, ironstone mines, quarries and brickworks; the manufacture of iron and steel, both in the rough and in the form of finished articles, as locomotives, bridge castings, ships' engines, gun castings and shells, &c. The parliamentary borough returns one member. The town was incorporated in 1867, and the corporation consists of a mayor, six aldermen and eighteen councillors. Area, 3956 acres.

Not long after the bishop and monks of Lindisfarne had settled at Durham in 995, Styr the son of Ulf gave them the vill of Darlington (Dearthington, Darnington), which by 1083 had grown into importance, probably owing to its situation on the road from Watling Street to the mouth of the Tees. Bishop William of St Carileph in that year changed the church to a collegiate church, and placed there certain canons whom he removed from Durham. Bishop Hugh de Puiset rebuilt the church and built a manor house which was for many years the occasional residence of the bishops of Durham. Boldon Book,

dated 1183, contains the first mention of Darlington as a borough, rated at £5, while half a mark was due from the dyers of cloth. The next account of the town is in Bishop Hatfield's Survey (c. 1380), which states that "Ingelram Gentill and his partners hold the borough of Derlyngton with the profits of the mills and dye houses and other profits pertaining to the borough rendering yearly four score and thirteen pounds and six shillings." Darlington possesses no early charter, but claimed its privileges as a borough by a prescriptive right. Until the 19th century it was governed by a bailiff appointed by the bishop. The mention of dyers in the Boldon Book and Hatfield's Survey probably indicates the existence of woollen manufacture. Before the 19th century Darlington was noted for the manufacture of linen, worsted and flax, but it owes its modern importance to the opening of the railway between Darlington and Stockton on the 27th of September 1825. "Locomotive No. 1," the first that ever ran on a public railway, stands in Bank Top station, a remarkable relic of the enterprise. As part of the palatinate of Durham, Darlington sent no members to parliament until 1862, when it was allowed to return one member. The fairs and markets in Darlington were formerly held by the bishop and were in existence as early as the 11th century. According to Leland, Darlington was in his time the best market town in the bishopric with the exception of Durham. In 1664 the bishop, finding that the inhabitants of the town had set up a market "in the season of the year unaccustomed," i.e. from the fortnight before Christmas to Whit Monday, prohibited them from continuing it. The markets and fairs were finally in 1854 purchased by the local authority, and now belong to the corporation.

**DARLINGTONIA** (called after William Darlington, an American botanist), a Californian pitcher-plant, belonging to the order Sarraceniaceae. There is only one species, *D. californica*, which is found at 5000 ft. altitude on the Sierra Nevadas of California, growing in sphagnum-bogs along with sundews and rushes.

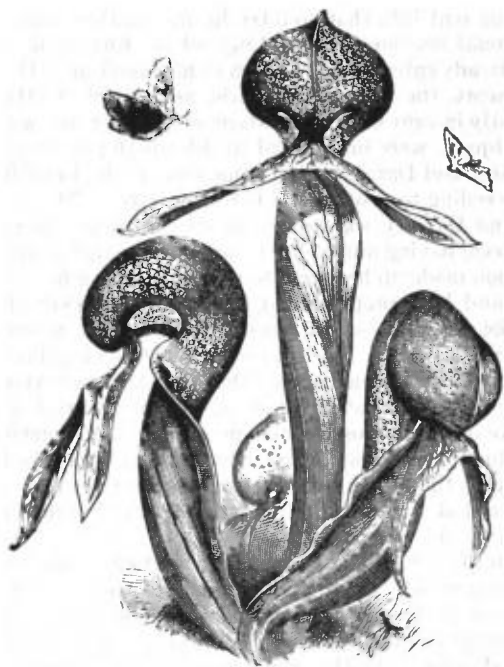

*Darlingtonia californica.*

The pitcher-like leaves form a cluster, and are 1 to 2 ft. high, slender, erect, and end in a rounded hooded top, from which hangs a blade shaped like a fish-tail which guards the entrance to the pitcher. Insects are attracted to the leaves by the bright colouring, especially of the upper part; entering they pass down the narrow funnel guided by downward pointing hairs which also prevent their ascent. They form a putrefying mass in the bottom of the pitcher, and the products of their decomposition are presumably absorbed by the leaf for food.

**DARLY, MATTHIAS**, 18th-century English caricaturist, designer and engraver. This extremely versatile artist not only issued political caricatures, but designed ceilings, chimney-pieces, mirror frames, girandoles, decorative panels and other mobiliary accessories, made many engravings for Thomas Chippendale, and sold his own productions over the counter. He was apparently an architect by profession. The first publication which can be attributed to him with certainty is a coloured caricature, "The Cricket Players of Europe" (1741). In 1754 he issued *A new Book of Chinese Designs*, which was intended to minister to the passing craze for furniture and household decorations in the Chinese style. It was in this year that he engraved many of the plates for the *Director* of Thomas Chippendale. He published from many addresses, most of them in the Strand or its immediate neighbourhood, and his shop was for a long period perhaps the most important of its kind in London. In his book *Nollekens and his Times*, J. T. Smith, writing of Richard Cosway, says:—"So ridiculously foppish did he become that Matth. Darly, the famous caricature print seller, introduced an etching of him in his window in the Strand as the 'Macaroni Miniature Painter.'" Darly was for many years in partnership with a man named Edwards, and together they published many political prints, which were originally issued separately and collected annually into volumes under the title of *Political and Satirical History*. Darly was a member both of the Incorporated Society of Artists and the Free Society of Artists, forerunners of the Royal Academy, and to their exhibitions he contributed many architectural drawings, together with a profile etching of himself (1775). Upon one of these etchings, published from 39 Strand, he is described as "Professor of Ornament to the Academy of Great Britain." Darly's most important publication was *The Ornamental Architect or Young Artists' Instructor* (1770-1771), a title which was changed in the edition of 1773 to *A Compleat Body of Architecture, embellished with a great Variety of Ornaments*. He also issued *Sixty Vases by English, French and Italian Masters* (1767). In addition to his immense mass of other productions Darly executed many book plates, illustrated various books and cabinet-makers' catalogues, and gave lessons in etching. His skill as a caricaturist brought him into close personal relations with the politicians of his time, and in 1763 he was instrumental in saving John Wilkes, whose partisan he was, from death at the hands of James Dunn, who had determined to kill him. Darly, who described himself as "Liveryman and block maker," issued his last caricature in October 1780, and as his shop, No. 39 Strand, was let to a new tenant in the following year, it is to be presumed that he had by that time died, or become incapable of further work. As a designer of furniture Darly travelled in a dozen years or so from the extremes of pseudo-Chinese affectation to classical severity of the type popularized by the brothers Adam.

**DARMESTETER, JAMES** (1849-1894), French author and antiquarian, was born of Jewish parents on the 28th of March 1849 at Château Salins, in Alsace. The family name had originated in their earlier home of Darmstadt. He was educated in Paris, where, under the guidance of Michel Bréal and Abel Bergaigne, he imbibed a love for Oriental studies, to which for a time he entirely devoted himself. He was a man of vast intellectual range. In 1875 he published a thesis on the mythology of the *Zend Avesta*, and in 1877 became teacher of Zend at the *École des Hautes Études*. He followed up his researches with his *Études iraniennes* (1883), and ten years later published a complete translation of the *Zend Avesta*, with historical and philological commentary (3 vols., 1892-1893), in the *Annales du musée Guimet*. He also edited the *Zend Avesta* for Max Müller's *Sacred Books of the East*. Darmesteter regarded the extant texts as far more recent than was commonly believed, placing the earliest in the 1st century B.C., and the bulk in the 3rd century A.D. In 1885 he was appointed professor in the Collège de France, and was sent to India in 1886 on a mission to collect the popular songs of the Afghans, a translation of which, with a valuable essay on the Afghan language and literature, he published on his return. His impressions of English dominion in India

were conveyed in *Lettres sur l'Inde* (1888). England interested him deeply; and his attachment to the gifted English writer, A. Mary F. Robinson, whom he shortly afterwards married (and who in 1901 became the wife of Professor E. Duclaux, director of the Pasteur Institute at Paris), led him to translate her poems into French in 1888. Two years after his death a collection of excellent essays on English subjects was published in English. He also wrote *Le Mahdi depuis les origines de l'Islam jusqu'à nos jours* (1885); *Les Origines de la poésie persane* (1888); *Prophètes d'Israël* (1892), and other books on topics connected with the east, and from 1883 onwards drew up the annual reports of the *Société Asiatique*. He had just become connected with the *Revue de Paris*, when his delicate constitution succumbed to a slight attack of illness on the 19th of October 1894.

His elder brother, ARSÈNE DARMESTETER (1846-1888), was a distinguished philologist and man of letters. He studied under Gaston Paris at the École des Hautes Études, and became professor of Old French language and literature at the Sorbonne. His *Life of Words* appeared in English in 1888. He also collaborated with Adolphe Hatzfeld in a *Dictionnaire général de la langue française* (2 vols., 1895-1900). Among his most important work was the elucidation of Old French by means of the many glosses in the medieval writings of Rashi and other French Jews. His scattered papers on romance and Jewish philology were collected by James Darmesteter as *Arsène Darmesteter, reliques scientifiques* (2 vols., 1890). His valuable *Cours de grammaire historique de la langue française* was edited after his death by E. Muret and L. Sudre (1891-1895; English edition, 1902).

There is an *éloge* of James Darmesteter in the *Journal asiatique* (1894, vol. iv. pp. 519-534), and a notice by Henri Cordier, with a list of his writings, in *The Royal Asiatic Society's Journal* (January 1895); see also Gaston Paris, "James Darmesteter," in *Penseurs et poètes* (1896), pp. 1-61).

**DARMSTADT**, a city of Germany, capital of the grand-duchy of Hesse-Darmstadt, on a plain gently sloping from the Odenwald to the Rhine, 21 m. by rail S.E. from Mainz and 17 m. S. from Frankfort-on-Main. Pop. (1905) 83,000. It is the residence of the grand-duke and the seat of government of the duchy. Darmstadt consists of an old and a new town, the streets of the former being narrow and gloomy and presenting no attractive features. The new town, however, which includes the greater part of the city, contains broad streets and several fine squares. Among the latter is the stately Luisenplatz, on which are the house of parliament, the old palace and the post office, and in the centre of which is a column surmounted by the statue of the grand-duke Louis I., the founder of the new town. The square is crossed by the Rhein-strasse, the most important thoroughfare in the city, leading directly from the railway station to the ducal palace. This last, a complex of buildings, dating from various centuries, but possessing few points of special interest, is surrounded by grounds occupying the site of the old moat. Opposite to it, on the north side, and adjoining the pretty palace gardens, are the court theatre and the armoury, and a little farther west the handsome buildings of the new museum, erected in 1905 and containing the valuable scientific and art collections of the state, which were formerly housed in the palace: a library of 600,000 volumes and 4000 MSS., a museum of Egyptian and German antiquities, a picture gallery with masterpieces of old German and Dutch schools, a natural history collection and the state archives. To the right of the entrance to the palace gardens is the tomb of the "great landgravine," Caroline Henrietta, wife of the landgrave Louis IX., surmounted by a marble urn, the gift of Frederick the Great of Prussia, bearing the inscription *femina sexu, ingenio vir*. To the south of the castle lies the old town, with the market square, the town hall (lately restored and enlarged) and the town church. Of the eight churches (seven Evangelical) only the Roman Catholic is in any way imposing. There are two synagogues. The town possesses a technical high school, having (since 1900) power to confer the degree of doctor of engineering, and attended by about 2000 students, two gymnasia, a school of agriculture, an artisans' school and a botanical garden. The chemist, Justus von Liebig, was born

in Darmstadt in 1803. Among the chief manufactures are the production of machinery, carpets, playing cards, chemicals, tobacco, hats, wine and beer.

The surroundings of Darmstadt are attractive and contain many features of interest. To the east of the town lies the Mathildenhöhe, formerly a park and now converted into villa residences. Here are the Alice hospital and the pretty Russian church, built (1898-1899) by the emperor Nicholas II. of Russia in memory of the empress Maria, wife of Alexander II. In the vicinity is the Rosenhöhe, with the mausoleum of the ducal house, with the tomb of the grand-duchess Alice, daughter of Queen Victoria of England.

Darmstadt is mentioned in the 11th century, but in the 14th century it was still a village, held by the counts of Katzenelnbogen. It came by marriage into the possession of the house of Hesse in 1479, the male line of the house of Katzenelnbogen having in that year become extinct. The imperial army took it in the Schmalkaldic War, and destroyed the old castle. In 1567, after the death of Philip the Magnanimous, his youngest son George received Darmstadt and chose it as his residence. He was the founder of the line of Hesse-Darmstadt. Its most brilliant days were those of the reign of Louis X. (1790-1830), the first grand-duke, under whom the new town was built.

See Walther, *Darmstadt wie es war und wie es geworden* (Darma. 1865); and Zernin und Wörner, *Darmstadt und seine Umgebung* (Zürich, 1890).

**DARNLEY, HENRY STEWART** or **STUART**, LORD (1545-1567), earl of Ross and duke of Albany, second husband of Mary, queen of Scots, was the eldest son of Matthew Stewart, earl of Lennox (1516-1571), and through his mother Lady Margaret Douglas (1515-1578) was a great-grandson of the English king Henry VII. Born at Temple Newsam in Yorkshire on the 7th of December 1545, he was educated in England, and his lack of intellectual ability was compensated for by exceptional skill in military exercises. After the death of Francis II. of France in 1560 Darnley was sent into that country by his mother, who hoped that he would become king of England on Elizabeth's death, and who already entertained the idea of his marriage with Mary, queen of Scots, the widow of Francis, as a means to this end. Consequently in 1561 both Lady Margaret and her son, who were English subjects, were imprisoned by Elizabeth; but they were soon released, and Darnley spent some time at the English court before proceeding to Scotland in February 1565. The marriage of Mary and Darnley was now a question of practical politics, and the queen, having nursed her new suitor through an attack of measles, soon made up her mind to wed him, saying he "was the properest and best proportioned long man that ever she had seen." The attitude of Elizabeth towards this marriage is difficult to understand. She had permitted Darnley to journey to Scotland, and it has been asserted that she entangled Mary into this union; but on the other hand she and her council declared their dislike of the proposed marriage, and ordered Darnley and his father to repair to London, a command which was disobeyed. In March 1565 there were rumours that the marriage had already taken place, but it was actually celebrated at Holyrood on the 29th of July 1565.

Although Mary had doubtless a short infatuation for Darnley, the union was mainly due to political motives, and in view of the characters of bride and bridegroom it is not surprising that trouble soon arose between them. Contrary to his expectations Darnley did not receive the crown matrimonial, and his foolish and haughty behaviour, his vicious habits, and his boisterous companions did not improve matters. He was on bad terms with the regent Murray and other powerful nobles, who disliked the marriage and were intriguing with Elizabeth. Scotland was filled with rumours of plot and assassination, and civil war was only narrowly avoided. Unable to take any serious part in affairs of state, Darnley soon became estranged from his wife. He believed that Mary's relations with David Rizzio injured him as a husband, and was easily persuaded to assent to the murder of the Italian, a crime in which he took part. Immediately afterwards, however, flattered and cajoled by the queen, he

betrayed his associates to her, and assisted her to escape from Holyrood to Dunbar. Owing to these revelations he was deserted and distrusted by his companions in the murder, and soon lost the queen's favour. In these circumstances he decided to leave Scotland, but a variety of causes prevented his departure; and meanwhile at Craigmillar a band of nobles undertook to free Mary from her husband, who refused to be present at the baptism of his son, James, at Stirling in December 1566. The details of the conspiracy at Craigmillar are not clear, nor is it certain what part, if any, Mary took in these proceedings. The first intention may have been to obtain a divorce for the queen, but it was soon decided that Darnley must be killed. Rumours of the plot came to his ears, and he fled from Stirling to Glasgow, where he fell ill, possibly by poisoning, and where Mary came to visit him. Another reconciliation took place between husband and wife, and Darnley was persuaded to journey with Mary by easy stages to Edinburgh. Apartments were prepared for the pair at Kirk o' Field, a house just inside the city walls, and here they remained for a few days. On the evening of the 9th of February 1567 Mary took an affectionate farewell of her husband, and went to attend some gaieties in Edinburgh. A few hours later, on the morning of the 10th, Kirk o' Field was blown up with gunpowder. Darnley's body was found at some distance from the house, and it is supposed that he was strangled whilst making his escape. The remains were afterwards buried in the chapel at Holyrood.

Much discussion has taken place about this crime, and the guilt or innocence of Mary is still a question of doubt and debate. It seems highly probable, however, that the queen was accessory to the murder, which was organized by her lover and third husband, Bothwell (*q.v.*). As the father of King James I., Darnley is the direct ancestor of all the sovereigns of England since 1603. Personally he was a very insignificant character and his sole title to fame is his connexion with Mary, queen of Scots.

For further information, and also for a list of the works bearing on his life, see the article MARY, QUEEN OF SCOTS.

**DARRANG**, a district of British India, in the province of Eastern Bengal and Assam. It lies between the Bhutan and Daphla Hills and the Brahmaputra, including many islands in the river. The administrative headquarters are at Tezpur. Its area is 3418 sq. m. It is for the most part a level plain watered by many tributaries of the Brahmaputra. The two subdivisions of Tezpur Mangaldai differ greatly in character. Tezpur is part of Upper Assam and shares in the prosperity which tea cultivation has brought to that part of the valley. In this portion of the district there are still large areas of excellent land awaiting settlement, and the cultivator finds a market for his produce in the flourishing tea-gardens, to which large quantities of coolies are imported every year. In Mangaldai, on the other hand, most of the good rice land was settled about 1880-1890 when the subdivision had a population of 146 to the square mile, as against 42 for Tezpur; the soil is not favourable for tea, and the population is stationary or receding. In 1901 the population of the whole district was 337,313, showing an increase of 10% in the decade. The principal grain-crop is rice. The principal means of communication is by river. A steam tramway of 2½ ft. gauge has been opened from Tezpur to Balipara, a distance of 20 m.

Darrang originally formed, according to tradition, part of the dominions of Bana Raja, who was defeated by Krishna in a battle near Tezpur ("the town of blood"). The massive granite ruins found near by prove that the place must have been the seat of powerful and civilized rulers. In the 16th century Darrang was subject to the Koch king of Kamarupa, Nar Narayan, and on the division of his dominions among his heirs passed to an independent line of rajas. Early in the 17th century the raja Bali Narayan invoked the aid of the Ahoms of Upper Assam against the Mussulman invaders; after his defeat and death in 1637 the Ahoms dominated the whole district, and the Darrang rajas sank into petty feudatories. About 1785 they took advantage of the decay of the Ahom kingdom to try and re-establish their independence, but they were defeated by a British expedition in 1792, and in 1826 Darrang, with the rest of Assam, passed under British control.

**DARTFORD**, a market town in the Dartford parliamentary division of Kent, England, on the Darent, 17 m. E.S.E. of London by the South-Eastern & Chatham railway. Pop. of

urban district (1891), 11,962; (1901) 18,644. The town lies low, flanked by two chalky eminences, called East and West Hills. It possesses a town hall, a grammar school (1576), and a Martyr's Memorial Hall. The most noteworthy building, however, is the parish church, restored in 1863, which contains a curious old fresco and several interesting brasses, and has a Norman tower. The prosperity of the town depends on the important works in its vicinity, including powder works, paper mills, and engineering, iron, chemical and cement works. One of the first attempts at the manufacture of paper in England was made here by Sir John Spielman (d. 1607), jeweller to Queen Elizabeth. Dartford was the scene, in 1235, of the marriage, celebrated by proxy, between Isabella, sister of Henry III., and the Emperor Frederick II.; and in 1331 a famous tournament was held in the place by Edward III. The same monarch established an Augustinian nunnery on West Hill in 1355, of which, however, few remains exist. After the Dissolution it was used as a private residence by Henry VIII., Anne of Cleves and Elizabeth. The chantry of St Edmund the Martyr which stood on the opposite side of the town was a part of Edward III.'s endowment to the priory, and became so famous as a place of pilgrimage, especially for those on their way to Canterbury, that the part of Watling Street which crossed there towards London was sometimes called "St Edmund's Way." It was here also that Wat Tyler's insurrection began in 1377, and the house in which he resided is shown. On Dartford Heath is a lunatic asylum of the London County Council, and, at Long Reach, the infectious diseases hospital of the Metropolitan Asylums Board. Stone church, 2 m. E. of Dartford, mainly late Early English (1251-1274), and carefully restored by G. E. Street in 1860, is remarkable; the richness of the work within increases from west to east, culminating in a choir arcade decorated with work among the finest of its period extant; the period is that of the choir of Westminster Abbey, and from a comparison of building materials, choir arcades and sculpture of foliage, a common architect has been suggested. Greenhithe, on the banks of the Thames, has large chalk quarries in its neighbourhood, from which lime and cement are manufactured.

**DARTMOOR**, a high plateau in the south-west of Devonshire, England. Its length is about 23 m. from N. to S. and its extreme breadth 20 m., the mean altitude being about 1500 ft. The area exceeding 1000 ft. in elevation is about 200 sq. m. It is the highest and easternmost in a broken chain of granitic elevations which extends through Cornwall to the Scilly Isles. The higher parts are open, bleak and wild, strongly contrasting with the more gentle scenery of the well-wooded lowlands surrounding it. Sloping heights rise from the main tableland in all directions, crested with broken masses of granite, locally named *tors*, and often singularly fantastic in outline. The highest of these are Yes Tor and High Willhays in the north-west, reaching altitudes of 2028 and 2039 ft. Large parts of the moor, especially in the centre, are covered with morasses; and head-waters of all the principal streams of Devonshire (*q.v.*) are found here. Two main roads cross the moor, one between Exeter and Plymouth, and the other between Ashburton and Tavistock, intersecting at Two Bridges. Both avoid the higher part of the moor, which, for the rest, is traversed only in part by a few rough tracks. The central part of Dartmoor was a royal forest from a date unknown, but apparently anterior to the Conquest. Its woods were formerly more extensive than now, but a few small tracts in which dwarf oaks are characteristic remain in the lower parts. Previous to 1337, the forest had been granted to Richard, earl of Cornwall, by Henry III., and from that time onward it has belonged to the duchy of Cornwall. The districts immediately surrounding the moor are called the Venville or Fenfield districts. The origin of this name is not clear. The holders of land by Venville tenure under the duchy have rights of pasture, fishing, &c. in the forest, and their main duty is to "drive" the moor at certain times in order to ascertain what head of cattle are pastured thereon, and to prevent trespassing. The antiquarian remains of Dartmoor are considered among those of Devonshire.

Dartmoor convict prison, near Princetown, was adapted to its present purpose in 1850; but the original buildings were erected

in 1809 for the accommodation of French prisoners. A tract of moorland adjacent to the prison has been brought under cultivation by the inmates.

See S. Rowe, *Perambulation of the . . . forest of Dartmoor* (Plymouth, 1848); J. L. W. Page, *Exploration of Dartmoor* (London, 1889); S. Baring-Gould, *Book of Dartmoor* (London, 1900).

**DARTMOUTH**, a town in Halifax county, Nova Scotia, Canada, on the north-eastern side of Halifax harbour, connected by a steam ferry with Halifax, of which it is practically a suburb. Pop. (1901) 4806. It contains a large sugar refinery, foundries, machine shops, saw mills, skate, rope, nail, soap and sash factories.

**DARTMOUTH**, a seaport, market town, and municipal borough in the Torquay parliamentary division of Devonshire, England, 27 m. E. of Plymouth. Pop. (1901) 6579. It is beautifully situated on the west bank and near the mouth of the river Dart, which here forms an almost land-locked estuary. The town is connected by a steam ferry with Kingswear on the opposite bank, which is served by a branch of the Great Western railway. The houses of Dartmouth, many of which are ancient, rise in tiers from the shore, beneath a range of steep hills. An embankment planted with trees fronts the river. The cruciform church of St Saviour is of the 14th and 15th centuries, and contains a graceful rood-screen of the 16th century, an ancient stone pulpit and interesting monuments. Dartmouth Castle, in part of Tudor date, commands the river a little below the town. Portions of the cottage of Thomas Newcomen, one of the inventors of the steam-engine, are preserved. Dartmouth is a favourite yachting centre, and shipbuilding, brewing, engineering and paint-making are carried on. Coal is imported, and resold to ships calling at the harbour. The borough is under a mayor, four aldermen and twelve councillors. Area, 1924 acres.

*History.*—Probably owing its origin to Saxon invaders, Dartmouth (*Darentamuthan*, *Dertemue*) was a seaport of importance when Earl Beorn was buried in its church in 1049. From its sheltered harbour William II. embarked for the relief of Mans, and the crusading squadron set sail in 1190, while John landed here in 1214. The borough, first claimed as such in the reign of Henry I., was in existence by the middle of the 13th century, since a deed of Gilbert Fitz-Stephen, lord of the manor, mentions the services due from "his burgesses of Dertemue," and a borough seal of 1280 is extant. The king in 1224 required the bailiffs and good men of Dartmouth to keep all ships in readiness for his service, and in 1302 they were to furnish two ships for the Scottish expedition, an obligation maintained throughout the century. The men of the vill were made quit of toll in 1337, and in 1342 the town was incorporated by a charter frequently confirmed by later sovereigns. Edward III. in 1372 granted that the burgesses should be sued only before the mayor and bailiffs, and Richard II. in 1393 granted extended jurisdiction and a coroner; further charters were obtained in 1604 and 1684. A French attack on the town was repulsed in 1404, and in 1485 the burgesses received a royal grant of £40 for walling the town and stretching a chain across the river mouth. Dartmouth fitted out two ships against the Armada, and was captured by both the royalists and parliamentarians in the Civil War. It returned two representatives to parliament in 1298, and from 1350 to 1832. In the latter year the representation was reduced to one, and was merged in that of the county in 1868. Manorial markets were granted for Dartmouth in 1231 and 1301. These were important since as early as 1225 the fleet resorted there for provisions. During the 14th and 15th centuries there was a regular trade with Bordeaux and Brittany, and complaints of piracies by Dartmouth men were frequent.

**DARTMOUTH COLLEGE**, an American institution of higher education, in Hanover, New Hampshire. It is Congregational in its affiliations, but is actually non-sectarian. The college is open only to men except during the summer session, when women also are admitted. Dartmouth embraces, in addition to the original college, incorporated in 1769, a medical school, dating from the establishment of a professorship of medicine in the college in 1798; the Thayer school of civil engineering, established in 1867

by the bequest of Gen. Sylvanus Thayer; and the Amos Tuck school of administration and finance, established in 1900 by Edward Tuck—a remarkable feature, as it was the first, and, until the establishment at Harvard of a similar graduate school, the only commercial school in the country whose work is largely post-graduate. The Chandler school of science and the arts was founded by Abiel Chandler in 1851, in connexion with Dartmouth, and was incorporated into the collegiate department in 1893 as the Chandler scientific course in the college. From 1866 to 1893 the New Hampshire college of agriculture and the mechanic arts, now at Durham, was connected with Dartmouth. The medical school offers a four years' course, and each of the other two professional schools a two years' course, the first year of which may, under certain conditions, be counted as the senior year of the undergraduate department. The college has a beautiful campus or "yard"; a library of more than 100,000 volumes, housed in Wilson Hall (1885); instruction halls, residence halls—Thornton and Wentworth (1828), Hallgarten (1874), Richardson (1897), and Fayerweather (1900); a gymnasium (Bissell Hall, built in 1867); an athletic field, known as Alumni Oval; Bartlett Hall (1890-1891), the house of the College Young Men's Christian Association; Rollins Chapel (1885); College Hall (1901), a social headquarters; an astronomical and meteorological observatory (Shattuck Observatory, 1854); the Mary Hitchcock hospital (1893), associated with the medical college; museums (especially the Butterfield Museum); Culver Hall (1871), the chemical laboratory; and Wilder Hall (1899), the physical laboratory. The college in 1908 had 100 officers of administration and instruction and 1219 students. It is maintained chiefly by the proceeds of a productive endowment fund amounting to \$2,700,000 and by tuition fees (\$125 a year for each student). The government is entrusted to a board of twelve trustees, five of whom are elected upon the nomination of the alumni.

Dartmouth is the outgrowth of Moor's Indian charity school, founded by Eleazer Wheelock (1711-1779) about 1750 at Lebanon, Connecticut; this school was named in 1755 in honour of Joshua Moor, who in this year gave to it lands and buildings. In 1765 Samson Occom (c. 1723-1792), an Indian preacher and former student of the school, visited England and Scotland in its behalf and raised £10,000, whereupon plans were made for enlargement and for a change of site to Hanover. In 1769 the school was incorporated by a charter granted by George III. as Dartmouth College, being named after the earl of Dartmouth, president of the trustees of the funds raised in Great Britain. The first college building, Dartmouth Hall (closely resembling Nassau Hall at Princetown and the University Hall of Brown University), was built in 1784-1791 and is still standing, as are the typical college church, built in 1796 and enlarged in 1877 and 1889, and Moor Hall, the second building for Moor's charity school, since 1852 called the Chandler building. During the War of Independence the support from Great Britain was mostly withdrawn. In 1815 President John Wheelock (1754-1817), who had succeeded his father in 1779, and was a Presbyterian and a Republican, was removed by the majority of the board of trustees, who were Congregationalists and Federalists, and Francis Brown was chosen in his place. Wheelock, upon his appeal to the legislature, was reinstated at the head of a new corporation, called Dartmouth University. The state courts upheld the legislature and the "University," but in 1819 after the famous argument of Daniel Webster (*q.v.*) in behalf of the "College" board of trustees as against the "University" board before the United States Supreme Court, that body decided that the private trust created by the charter of 1769 was inviolable, and Dr Francis Brown and the old "College" board took possession of the institution's property. This was one of the most important decisions ever made by the United States Supreme Court.

See Frederick Chase, *A History of Dartmouth College and the Town of Hanover* (Cambridge, 1891). For the Dartmouth College Case see Shirley, *The Dartmouth College Causes* (St Louis, Missouri, 1879); Kent, *Commentaries on American Law* (vol. i. Boston, 1884); and Joseph Story, *Commentaries on the Constitution* (vol. ii., Boston, 1891).



**DARTMOUTH, EARL OF**, an English title borne by the family of Legge from 1710 to the present day.

**WILLIAM LEGGE** (c. 1609–1670), the eldest son of Edward Legge (d. 1616), vice-president of Munster, gained some military experience on the continent of Europe and then returning to England assisted Charles I. in his war against the Scots in 1638. He was also very useful to the king during the months which preceded the outbreak of the Civil War, although his attempt to seize Hull in January 1642 failed. During the war Legge distinguished himself at Chalgrove and at the first battle of Newbury, and in 1645 he became governor of Oxford. However, he only held this position for a few months, as he shared the disgrace of Prince Rupert, to whom he was very devoted; but he was largely instrumental in putting an end to the quarrel between the king and the prince. Legge helped Charles to escape from Hampton Court in 1647, and after attending upon him he was arrested in May 1648. He was soon released, but was again captured in the following year while proceeding to Ireland in the interests of Charles II. Regaining his freedom in 1653, he spent some years abroad, but in 1659 he was once more in England inciting the royalists to rise. Legge enjoyed the favour of Charles II., who offered to make him an earl. The old royalist died on the 13th of October 1670.

Legge's eldest son, **GEORGE, BARON DARTMOUTH** (1647–1691), served as a volunteer in the navy during the Dutch war of 1665–1667, and quickly won his way to high rank. He was also a member of the household of the duke of York, afterwards James II.; was governor of Portsmouth and master-general of the army; in 1678 he commanded as colonel the troop at Nieuport, and in 1682 he was created Baron Dartmouth. In 1683 as "admiral of a fleet" he sailed to Tangiers, dismantled the fortifications and brought back the English troops, a duty which he discharged very satisfactorily. Under James II. Dartmouth was master of the horse and governor of the Tower of London; and in 1688, when William of Orange was expected, James II. made him commander-in-chief of his fleet. Although himself loyal to James, the same cannot be said of many of his officers, and an engagement with the Dutch fleet was purposely avoided. Dartmouth, however, refused to assist in getting James Edward, prince of Wales, out of the country, and even reproved the king for attempting this proceeding. He then left the fleet and took the oath of allegiance to William and Mary, but in July 1691 he was arrested for treason, and was charged with offering to hand over Portsmouth to France and to command a French fleet. Macaulay believed that this accusation was true, but there are those who hold that Dartmouth spoke the truth when he protested his innocence. Further proceedings against him were prevented by his death, which took place in the Tower of London on the 25th of October 1691.

Lord Dartmouth's only son, **WILLIAM, 1ST EARL OF DARTMOUTH** (1672–1750), succeeded to his father's barony in 1691. In 1702 he was appointed a member of the board of trade and foreign plantations, and eight years later he became secretary of state for the southern department and joint keeper of the signet for Scotland. In 1711 he was created viscount Lewisham and earl of Dartmouth; in 1713 he exchanged his offices for that of keeper of the privy seal, which he held until the end of 1714. After a long period of retirement from public life he died on the 15th of December 1750. Dartmouth's eldest son George, viscount Lewisham (c. 1703–1732), predeceased his father. Other sons were: Heneage Legge (1704–1759), judge of the court of exchequer; Henry Legge (q.v.), afterwards Bilson-Legge; and Edward Legge (1710–1747), who served for some time in the navy and died on the 19th of September 1747.

**WILLIAM, 2ND EARL OF DARTMOUTH** (1731–1801), was a son of George, viscount Lewisham, and a grandson of the 1st earl, whom he succeeded in 1750. For a few months in 1765 and 1766 he was president of the board of trade and foreign plantations; in 1772 he returned to the same office holding also that of secretary for the colonies; and in 1775 he became lord privy seal. With regard to the American colonies Dartmouth advised them in 1777 to accept the conciliatory proposals put forward by

Lord North, but in 1776 he opposed similar proposals and advocated the employment of force. In March 1782 he resigned his office as lord privy seal and in 1783 he was lord steward of the household; he died on the 15th of July 1801. Dartmouth was a friend of Selina, countess of Huntingdon, and his piety and his intimacy with the early Methodists won for him the epithet of the *Psalm-singer*. Dartmouth College was named after him, and among his papers preserved at Patshull House, Wolverhampton, are many letters from America relating to the struggle for independence. His sixth son, Sir Arthur Kaye Legge (d. 1835), was an admiral of the blue, and his seventh son, Edward Legge (d. 1827), was bishop of Oxford.

**GEORGE, 3RD EARL OF DARTMOUTH** (1755–1810), the eldest son of the 2nd earl, was lord warden of the stannaries and president of the board of control; later he was lord steward and then lord chamberlain of the royal household. He died on the 1st of November 1810, when his eldest son, William (1784–1853), became 4th earl. William's son, William Walter (1823–1891), became 5th earl in 1853 and was succeeded in 1891 by his son William Heneage Legge (b. 1851) as 6th earl of Dartmouth. As Lord Lewisham this nobleman was a member of parliament from 1878 to 1891, and was vice-chamberlain of the household in 1885–1886, and again from 1886 to 1892.

**DARU, PIERRE ANTOINE NOËL BRUNO, COUNT** (1767–1829), French soldier and statesman, was born at Montpellier on the 12th of January 1767. He was educated at the military school of Tournon, conducted by the Oratorians, and entered the artillery at an early age. His fondness for literature, however, soon made itself felt, and he published several slight pieces, until the outbreak of the French Revolution called him to a sterner occupation. In 1793 he became commissary to the army, protecting the coasts of Brittany from projected descents of the British, or of French royalists. Thrown into prison on a frivolous charge of friendliness to the royalists and England, he was released after the fall of Robespierre in the summer of 1794, and rose in the service until, in 1799, he became chief commissary to the French army serving under Masséna in the north of Switzerland. In that position he won repute for his organizing capacity, great power of work and unswerving probity—the last of which qualities was none too common in the French armies at that time. These exacting tasks did not absorb all his energies. He found time, even during the campaign, to translate part of Horace and to compose two poems, the *Poème des Alpes* and the *Chant de guerre*. The latter celebrated in indignant strains the murder of the French envoys to the congress of Rastadt.

The accession of Napoleon Bonaparte to power in November 1799 led to the employment of Daru as chief commissary to the Army of Reserve intended for North Italy, and commanded nominally by Berthier, but really by the First Consul. Conjointly with Berthier and Dejean, he signed the armistice with the Austrians which closed the campaign in North Italy in June 1800. Daru now returned, for a time, mainly to civil life, and entered the tribunate, where he ably maintained the principles of democratic liberty. On the renewal of war with England, in May 1803, he again resumed his duties as chief commissary for the army on the northern coasts. It was afterwards asserted that, on Napoleon's resolve to turn the army of England against Austria, Daru had set down at the emperor's dictation all the details of the campaign which culminated at Ulm. The story is apocryphal; but Napoleon's confidence in him was evinced by his being appointed to similar duties in the Grand Army, which in the autumn of 1805 overthrew the armies of Austria and Russia. After the battle of Austerlitz, he took part in the drafting of the treaty of Presburg. At this time, too, he became intendant-general of the military household of Napoleon. In the campaigns of 1806–1807 he served, in his usual capacity, in the army which overthrew the forces of Russia and Prussia; and he had a share in drawing up the treaty of Tilsit (7th of July 1807). After this he supervised the administrative and financial duties in connexion with the French army which occupied the principal fortresses of Prussia, and was one of the chief agents through whom Napoleon pressed hard on that land. At the congress of Erfurt, Daru had

the privilege of being present at the interview between Goethe and Napoleon, and interposed tactful references to the works of the great poet. Daru fulfilled his usual duties in the campaign of 1809 against Austria. Afterwards, when the subject of the divorce of Josephine and the choice of a Russian or of an Austrian princess came to be discussed, Daru, on being consulted by Napoleon, is said boldly to have counselled his marriage with a French lady; and Napoleon, who admired his frankness and honesty, took the reply in good part.

In 1811 he became secretary of state in succession to Maret, duc de Bassano, and showed his usual ability in the administration of the vast and complex affairs of the French empire, including the arrangements connected with the civil list and the imperial domains. But neither his devotion to civic duty nor to the administration of the affairs of the Grand Army could ward off disaster. Late in the year 1813 he took up the portfolio of military affairs. After the first abdication of Napoleon in 1814, Daru retired into private life, but aided Napoleon during the Hundred Days. After the second Restoration he became a member of the Chamber of Peers, in which he ably defended the cause of popular liberty against the attacks of the ultra-royalists. He died at Meulan on the 5th of September 1829.

Few men of the Napoleonic empire have been more generally admired and respected than Daru. On one occasion when he expressed a fear that he lacked all the gifts of a courtier, Napoleon replied, "Courtiers! They are common enough about me; I shall never be in want of them. What I want is an enlightened, firm and vigilant administrator; and that is why I have chosen you." At another time Napoleon said, "Daru is good on all sides; he has good judgment, a good intellect, a great power for work, and a body and mind of iron." The only occasion on which he is known to have sunk beneath the weight of his duties was in the course of writing letters at the emperor's dictation for the third night in succession.

Of Daru's literary works may be mentioned his *Histoire de Venise*, published at Paris in 7 vols. in 1819; the *Histoire de Bretagne*, in 3 vols. (Paris, 1826); a poetical translation of Horace (of which Le Brun remarked: "Je ne lis point Daru, j'aime trop mon Horace"); *Discours en vers sur les facultés de l'homme* (Paris, 1825), and *Astronomie*, a didactic poem in six cantos (Paris, 1820).

See the "Notice" by Viennet prefixed to the fourth edition of Daru's *Histoire de la république de Venise* (9 vols., 1853), and three articles by Sainte-Beuve in *Causeries du lundi*, vol. ix. For the many letters of Napoleon to Daru see the *Correspondance de Napoléon I<sup>er</sup>* (32 vols., Paris, 1858-1870). (J. H. L. R.)

**DARWEN**, a municipal borough in the Darwen parliamentary division of Lancashire, England, 20 m. N.W. from Manchester by the Lancashire & Yorkshire railway. Pop. (1891) 34,192; (1901) 38,212. It lies on the river Darwen, which traverses a densely populated manufacturing district, and is surrounded by high-lying moors. Darwen is a centre of the cotton trade and has also blast furnaces, and paper-making, paper-staining and fire-clay works. In the neighbourhood are collieries and stone quarries. The market hall is the chief public building; there are technical schools, a free library, and two public parks. Darwen was incorporated in 1788. The corporation consists of a mayor, six aldermen and eighteen councillors.

**DARWIN, CHARLES ROBERT** (1809-1882), English naturalist, author of the *Origin of Species*, was born at Shrewsbury on the 12th of February 1809. He was the younger of the two sons and the fourth child of Dr Robert Waring Darwin, son of Dr Erasmus Darwin (q.v.). His mother, a daughter of Josiah Wedgwood (1730-1795), died when Charles Darwin was eight years old. Charles Darwin's elder brother, Erasmus Alvey (1804-1881), was interested in literature and art rather than science: on the subject of the wide difference between the brothers Charles wrote that he was "inclined to agree with Francis Galton in believing that education and environment produce only a small effect on the mind of anyone, and that most of our qualities are innate" (*Life and Letters*, London, 1887, p. 22). Darwin considered that his own success was chiefly due to "the love of science, unbounded

patience in long reflecting over any subject, industry in observing and collecting facts, and a fair share of invention as well as of common sense" (*l.c.* p. 107). He also says: "I have steadily endeavoured to keep my mind free so as to give up any hypothesis, however much beloved (and I cannot resist forming one on every subject), as soon as facts are shown to be opposed to it" (*l.c.* p. 103). The essential causes of his success are to be found in this latter sentence, the creative genius ever inspired by existing knowledge to build hypotheses by whose aid further knowledge could be won, the calm unbiassed mind, the transparent honesty and love of truth which enabled him to abandon or to modify his own creations when they ceased to be supported by observation. The even balance between these powers was as important as their remarkable development. The great naturalist appeared in the ripeness of time, when the world was ready for his splendid generalizations. Indeed naturalists were already everywhere considering and discussing the problem of evolution, although Alfred Russel Wallace was the only one who, independently of Darwin, saw his way clearly to the solution. It is true that hypotheses essentially the same as natural selection were suggested much earlier by W. C. Wells (*Phil. Trans.*, 1813), and Patrick Matthew (*Naval Timber and Arboriculture*, 1831), but their views were lost sight of and produced no effect upon the great body of naturalists. In the preparation for Darwin Sir Charles Lyell's *Principles of Geology* played an important part, accustoming men's minds to the vast changes brought about by natural processes, and leading them, by its lucid and temperate discussion of Lamarck's and other views, to reflect upon evolution.

Darwin's early education was conducted at Shrewsbury, first for a year at a day-school, then for seven years at Shrewsbury School under Dr Samuel Butler (1774-1839). He gained but little from the narrow system which was then universal. In 1825 he went to Edinburgh to prepare for the medical profession, for which he was unfitted by nature. After two sessions his father realized this, and in 1828 sent him to Cambridge with the idea that he should become a clergyman. He matriculated at Christ's College, and took his degree in 1831, tenth in the list of those who do not seek honours. Up to this time he had been keenly interested in sport, and in entomology, especially the collecting of beetles. Both at Edinburgh, where in 1826 he read his first scientific paper, and at Cambridge he gained the friendship of much older scientific men—Robert Edmond Grant and William Macgillivray at the former, John Stevens Henslow and Adam Sedgwick at the latter. He had two terms' residence to keep after passing his last examination, and studied geology with Sedgwick. Returning from their geological excursion together in North Wales (August 1831), he found a letter from Henslow urging him to apply for the position of naturalist on the "Beagle," about to start on a surveying expedition. His father at first disliked the idea, but his uncle, the second Josiah Wedgwood, pleaded with success, and Darwin started on the 27th of December 1831, the voyage lasting until the 2nd of October 1836. It is practically certain that he never left Great Britain after this latter date. After visiting the Cape de Verde and other islands of the Atlantic, the expedition surveyed on the South American coasts and adjacent islands (including the Galapagos), afterwards visiting Tahiti, New Zealand, Australia, Tasmania, Keeling Island, Maldives, Mauritius, St Helena, Ascension; and Brazil, de Verdes and Azores on the way home. His work on the geology of the countries visited, and that on coral islands, became the subject of volumes which he published after his return, as well as his *Journal of a Naturalist*, and his other contributions to the official narrative. The voyage must be regarded as the real preparation for his life-work. His observations on the relation between animals in islands and those of the nearest continental areas, near akin and yet not the same, and between living animals and those most recently extinct and found fossil in the same country, here again related but not the same, led him even then to reflect deeply upon the modification of species. He had also been much impressed by "the manner in which closely allied animals replace one another in proceeding southwards" in South America. On his return home Darwin worked at his

collections, first at Cambridge for three months and then in London. His pocket-book for 1837 contains the words: "In July opened first note-book on Transmutation of Species. Had been greatly struck from about the month of previous March [while still on the voyage and just over twenty-eight years old] on character of South American fossils, and species on Galapagos Archipelago. These facts (especially latter) origin of all my views." From 1838 to 1841 he was secretary of the Geological Society, and saw a great deal of Sir Charles Lyell, to whom he dedicated the second edition of his *Journal*. On the 29th of January 1839 he married his cousin, Emma Wedgwood, the daughter of Josiah Wedgwood of Maer. They lived in London until September 1842, when they moved to Down, which was Darwin's home for the rest of his life. His health broke down many times in London, and remained precarious during the whole of his life. The immense amount of work which he got through was only made possible by the loving care of his wife. For eight years (1846 to 1854) he was chiefly engaged upon four monographs on the recent and fossil Cirripede Crustacea (*Ray Soc.*, 1851 and 1854; *Palaeontograph. Soc.*, 1851 and 1854). Towards the close of this work Darwin became very wearied of it, especially of the synonymy. For a time he hoped to start a movement which should discourage the habit of appending the name of the describer to the name of the species, a custom which he thought led to bad and superficial work. From this time he was engaged upon the numerous lines of inquiry which led to the great work of his life, the *Origin of Species*, published in November 1859.

Soon after opening his note-book in July 1837 he began to collect facts bearing upon the formation of the breeds of domestic animals and plants, and quickly saw "that selection was the keystone of man's success. But how selection could be applied to organisms living in a state of nature remained for some time a mystery to me." Various ideas as to the causes of evolution occurred to him, only to be successively abandoned. He had the idea of "laws of change" which affected species and finally led to their extinction, to some extent analogous to the causes which bring about the development, maturity and finally death of an individual. He also had the conception that species must give rise to other species or else die out, just as an individual dies unrepresented if it bears no offspring. These and other ideas, of which traces exist in his Diary, arose in his mind, together with perhaps some general conception of natural selection, during the fifteen months after the opening of his note-book. In October 1838 he read *Malthus on Population*, and his observations having long since convinced him of the struggle for existence, it at once struck him "that under these circumstances favourable variations would tend to be preserved, and unfavourable ones to be destroyed. The result of this would be the formation of new species. Here, then, I had a theory by which to work." In June 1842 he wrote out a sketch, which two years later he expanded to an essay occupying 231 pages folio. The idea of progressive divergence as an advantage in itself, because the competition is most severe between organisms most closely related, did not occur to him until long after he had come to Down. During the growth of the *Origin* Sir Joseph Hooker was his most intimate friend, and on the 11th of January 1844 he wrote: "At last gleams of light have come, and I am almost convinced (quite contrary to the opinion I started with) that species are not (it is like confessing a murder) immutable" (*l.c.* ii. 13). In 1855 he began a correspondence with the great American botanist Asa Gray, and in 1857 explained his views in a letter which afterwards became classical. In 1856, urged by Lyell, he began the preparation of a third and far more expanded treatise, and had completed about half of it when, on the 18th of June 1858, he received a manuscript essay from A. R. Wallace, who was then at Ternate in the Moluccas. Wallace wanted Darwin's opinion on the essay, which he asked should be forwarded to Lyell. Darwin was much startled to find in the essay a complete abstract of his own theory of natural selection. He forwarded it the same day, writing to Lyell, "your words have come true with a vengeance—that I should be forestalled." He placed himself in the hands of Lyell and Hooker, who decided to

send Wallace's essay to the Linnean Society, together with an abstract of Darwin's work, which they asked him to prepare, the joint essay being accompanied by a preface in the form of an explanatory letter written by them to the secretary. The title of the joint communication was "On the Tendency of Species to form Varieties; and on the Perpetuation of Varieties and Species by Natural Means of Selection." It was read on the 1st of July 1858, and appears in the *Linn. Soc. Journal* (Zoology) for that year. In this statement of the theory of natural selection, Darwin's part consisted of two sections, the first being extracts from his 1844 essay, including a brief account of sexual selection, and the second an abstract of his letter to Asa Gray dated the 5th of September 1857. This latter, probably his first attempt to expound natural selection, cannot be surpassed as a clear statement of the theory. Darwin explained at the outset, what he insisted on elsewhere, that the facts of adaptation or contrivance in nature are the real difficulty to be explained by a theory of evolution, the stumbling-block of every previous suggestion. Until he could explain "the mistletoe, with its pollen carried by insects, and seed by birds—the woodpecker, with its feet and tail, beak and tongue, to climb the tree and secure insects," he was "scientifically orthodox." Nevertheless he was led to believe in evolution, apart from any possible motive-cause, by "general facts in the affinities, embryology, rudimentary organs, geological history, and geographical distribution of organic beings." He then proceeds to describe the manner in which he met the difficulty of adaptation by "his notions on the means by which Nature makes her species." The essentials of the statement are as follows:—I. Man has made his domestic breeds of animals and plants by selection, conscious or unconscious, of very slight or greater variations. II. The material for selection exists in nature, namely, slight variations of all parts of the organism. III. The "unerring power" which sifts these variations is "natural selection . . . which selects exclusively for the good of each organic being." The rate of increase is such that only a few in each generation can live: hence the never sufficiently appreciated struggle for life. "What a trifling difference must often determine which shall survive and which perish!" The remaining heads explain the complex nature of the struggle, the reasons for deficient direct evidence, the advantage of divergence, &c. In the joint essay the phrases "natural selection" and "sexual selection" were first made public by Darwin, the "struggle for existence" by Wallace. Darwin and Wallace had met only once before the departure of the latter for the East. Their rivalry in the discovery of the great principle of natural selection was the beginning of a lifelong friendship. Wallace was lying ill with intermittent fever at Ternate in February 1858 when he began to think of Malthus's *Essay on Population*, read several years before: suddenly the idea of the survival of the fittest flashed upon him. In two hours he had "thought out almost the whole of the theory," and in three evenings had finished his essay. Darwin, also inspired after reading Malthus, in October 1838, did not publish until nearly twenty years had elapsed, and then only when Wallace sent him his essay. Canon H. B. Tristram was the first to apply the new theory, explaining by its aid the colours of desert birds, &c. (*Ibis*, October 1859).

Acting under the advice of Lyell and Hooker, Darwin then began to prepare what was to become the great work of his life. It appeared on the 24th of November 1859, with the full title, *On the Origin of Species by Means of Natural Selection, or the Preservation of Favoured Races in the Struggle for Life*. The whole edition of 1250 copies was exhausted on the day of issue. The first four chapters explain the operation of artificial selection by man and of natural selection in consequence of the struggle for existence. The fifth chapter deals with the laws of variation and causes of modification other than natural selection. The five succeeding chapters consider difficulties in the way of a belief in evolution generally as well as in natural selection. The three remaining chapters (omitting the recapitulation which occupies the last) deal with the evidence for evolution. The theory which suggested a cause of evolution is thus given the foremost place,

and the evidence for the existence of evolution considered last of all. This method of presentation was no doubt adopted because it was just the want of a reasonable motive-cause which more than anything else prevented the acceptance of evolution. But the other side of the book must not be eclipsed by the brilliant theory of Darwin and Wallace. The evidence for evolution itself had never before been thought out and marshalled in a manner which bears any comparison with that of Darwin in the *Origin*, and the work would have been in the highest degree epoch-making had it consisted of the later chapters alone. In the fifth chapter Darwin incorporated a certain proportion of the doctrines of Buffon,—modifications due to the direct influence of environment; and of Lamarck,—the hereditary effects of use and disuse. Lyell for a long time hesitated to accept the new teaching, and Darwin carried on a long correspondence with him. His public confession of faith was made at the anniversary dinner of the Royal Society in 1864. A storm of controversy arose over the book, reaching its height at the meeting of the British Association at Oxford in 1860, when the celebrated duel between T. H. Huxley and Bishop Wilberforce of Oxford took place. Throughout these struggles Huxley was the foremost champion for evolution and for fair play to natural selection, although he never entirely accepted the latter theory, holding that until man by his selection had made his domestic breed sterile *inter se*, there was no sufficient evidence that selection accounts for natural species which are thus separated by the barrier of sterility. The theory of natural selection was at first greatly misunderstood. Thus some writers thought it implied conscious choice in the animals themselves, others that it was the personification of some active power. By many it was thought to be practically the same idea as Lamarck's. Herbert Spencer's alternative phrase, "the survival of the fittest," probably helped to spread a clear appreciation of Darwin's meaning.

The history of opinion since 1850 may be summed up as follows. Evolution soon gained general acceptance, except among a certain number of those of middle or more advanced age at the time when the *Origin* appeared. Although natural selection had been an essential force in producing this conviction, there gradually grew up a tendency to minimize its importance in relation to the causes originally suggested by Buffon and Lamarck, which were ably presented and further elaborated by Herbert Spencer. In America a school of Neo-Lamarckians appeared, and for a time flourished under the inspiration of the vigorous personality of E. D. Cope. The writings of August Weismann next raised a controversy over the scope of heredity, assailing the very foundation of the hypotheses of Buffon, Lamarck and Herbert Spencer by demanding evidence that the "acquired characters" upon which they rest are capable of hereditary transmission. The quantitative determination of heredity has been the subject of much patient investigation under the leadership of Francis Galton. The question of isolation as a factor in species-formation has been greatly discussed, G. J. Romanes proposing, in his hypothesis of "Physiological Selection," that the barrier of sterility may arise spontaneously by variation between two sets of individuals as the beginning instead of the climax of specific distinction. Others have fixed their attention upon the variations, which provided the material for natural selection, and have advocated the view that evolution proceeds by immense strides instead of the minute steps in which Darwin and Wallace believed. Others, again, have found significance in the artificial production of "monstrosities" or huge modifications during individual development. All through the period a varying proportion of naturalists, probably larger now than at any other time, has followed the founders of the theory, and has sought the motive-cause of evolution in "the accumulative power of natural selection," which Darwin, as his first public statement indicates, looked upon "as by far the most important element in the production of new forms." They hold, with Darwin and Wallace, that although variation provides the essential material, natural selection, from its accumulative power, is of such paramount importance that it may be said to create new species as truly as a man may be said to make a building out of the material provided

by stones of various shapes, a metaphor suggested and elaborated by Darwin, and forming the concluding sentences of *The Variation of Animals and Plants under Domestication*. This, probably the second in importance of all his works, was published in 1868, and may be looked upon as a complete account of the material of which he had given a very condensed abstract in the first chapter of the *Origin*, together with the conclusions suggested by it. He finally brought together an immense number of apparently disconnected sets of observations under his "provisional hypothesis of pangenesis," which assumes that every cell in the body, at every stage of growth and in maturity, is represented in each germ-cell by a gemmule. The germ-cell is only the meeting-place of gemmules, and the true reproductive power lies in the whole of the body-cells which despatch their representatives, hence "pangenesis." There are reasons for believing that this infinitely complex conception, in which, as his letters show, he had great confidence, was forced upon Darwin in order to explain the hereditary transmission of acquired characters involved in the small proportion of Lamarckian doctrine which he incorporated. If such transmission does not occur, a far simpler hypothesis based on the lines of Weismann's "continuity of the germ-plasm" is sufficient to account for the facts.

The *Descent of Man, and Selection in Relation to Sex*, was published in 1871; as the title implies, it really consists of two distinct works. The first, and by far the shorter, was the full justification of his statement in the *Origin* that "light would be thrown on the origin of man and his history." In the second part he brought together a large mass of evidence in support of his hypothesis of sexual selection which he had briefly described in the 1858 essay. This hypothesis explains the development of colours and structures peculiar to one sex and displayed by it in courtship, by the preferences of the other sex. The majority of naturalists probably agree with Darwin in believing that the explanation is real, but relatively unimportant. It is interesting to note that only in this subject and those treated of in the *Variation under Domestication* had Darwin exhausted the whole of the material which he had collected. The *Expression of the Emotions*, published in 1872, offered a natural explanation of phenomena which appeared to be a difficulty in the way of the acceptance of evolution. In 1876 Darwin brought out his two previously published geological works on *Volcanic Islands* and *South America* as a single volume. The widely read *Formation of Vegetable Mould through the Action of Worms* appeared in 1881. He also published various volumes on botanical subjects. The *Fertilization of Orchids* appeared in 1862. The subject of cross-fertilization of flowers was in Darwin's mind, as shown by his note-book in 1837. In 1841 Robert Brown directed his attention to Christian Conrad Sprengel's work (Berlin, 1793), which confirmed his determination to pursue this line of research. The *Effects of Cross- and Self-Fertilization in the Vegetable Kingdom* (1876) contained the direct evidence that the offspring of cross-fertilized individuals are more vigorous, as well as more numerous, than those produced by a self-fertilized parent. *Different Forms of Flowers on Plants of the Same Species* appeared in 1877. It is here shown that each different form, although possessing both kinds of sexual organs, is specially adapted to be fertilized by the pollen of another form, and that when artificially fertilized by its own pollen less vigorous offspring, bearing some resemblance to hybrids, are produced. He says, "no little discovery of mine ever gave me so much pleasure as the making out the meaning of heterostyled flowers" (*Autobiography*). *Climbing Plants* was published in 1875, although it had, in large part, been communicated to the Linnean Society, in whose publications much of the material of several of his other works appeared. This inquiry into the nature of the movements of twining plants was suggested to him in a paper by Asa Gray. *The Power of Movement in Plants* (1880) was produced by him in conjunction with his son Francis. It was an inquiry into the minute power of movement possessed, he believed, by plants generally, out of which the larger movements of climbing plants of many different groups had been evolved. The work included an investigation of other kinds of plant movement due to light, gravity, &c., all of which

he regarded as modifications of the one fundamental movement (circumnutation) which exists in a highly specialized form in climbing plants. *Insectivorous Plants* (1875) is principally concerned with the description of experiments on the Sun-dew (*Drosera*), although other insect-catching plants, such as *Dionaea*, are also investigated.

Charles Darwin's long life of patient, continuous work, the most fruitful, the most inspiring, in the annals of modern science, came to an end on the 19th of April 1882. He was buried in Westminster Abbey on the 26th. It is of much interest to attempt to set forth some of the main characteristics of the man who did so much for modern science, and in so large a measure moulded the form of modern thought. Although his ill-health prevented Darwin, except on rare occasions, from attending scientific and social meetings, and thus from meeting and knowing the great body of scientific and intellectual workers of his time, probably no man has ever inspired a wider and deeper personal interest and affection. This was in part due to the intimate personal friends who represented him in the circles he was unable frequently to enter, but chiefly to the kindly, generous, and courteous nature which was revealed in his large correspondence and published writings, and especially in his treatment of opponents.

In a deeply interesting chapter of the *Life and Letters* Francis Darwin has given us his reminiscences of his father's everyday life. Rising early, he took a short walk before breakfasting alone at 7.45, and then at once set to work, "considering the 1½ hours between 8.0 and 9.30 one of his best working times." He then read his letters and listened to reading aloud, returning to work at about 10.30. At 12 or 12.15 "he considered his day's work over," and went for a walk, whether wet or fine. For a time he rode, but after accidents had occurred twice, was advised to give it up. After lunch he read the newspaper and wrote his letters or the MS. of his books. At about 3.0 he rested and smoked for an hour while being read to, often going to sleep. He then went for a short walk, and returning about 4.30, worked for an hour. After this he rested and smoked, and listened to reading until tea at 7.30, a meal which he came to prefer to late dinner. He then played two games of backgammon, read to himself, and listened to music and to reading aloud. He went to bed, generally very much tired, at 10.30, and was often much troubled by wakefulness and the activity of his thoughts. It is thus apparent that the number of hours devoted to work in each day was comparatively few. The immense amount he achieved was due to concentration during these hours, also to the unflinching and, because of his health, the necessary regularity of his life.

The appearance of Charles Darwin has been made well known in numerous portraits and statues. He was tall and thin, being about six feet high, but looked less because of a stoop, which increased towards the end of his life. As a young man he had been active, with considerable powers of endurance, and possessed in a marked degree those qualities of eye and hand which make the successful sportsman.

Charles Darwin was, as a young man, a believer in Christianity, and was sent to Cambridge with the idea that he would take orders. It is probable, however, that he had merely yielded to the influences of his home, without thinking much on the subject of religion. He first began to reflect deeply on the subject during the two years and a quarter which intervened between his return from the "Beagle" (October 2nd, 1836) and his marriage (January 29th, 1839). His own words are, "disbelief crept over me at a very slow rate, but was at last complete. The rate was so slow that I felt no distress." His attitude was that of the tolerant unaggressive agnostic, sympathizing with and helping in the social and charitable influences of the English Church in his parish. He was evidently most unwilling that his opinions on religious matters should influence others, holding, as his son, Francis Darwin, says, "that a man ought not to publish on a subject to which he has not given special and continuous thought" (*l.c.* i. p. 305).

In addition to the personal qualities and powers of Charles Darwin, there were other contributing causes without which the world could never have reaped the benefit of his genius. It is

evident that Darwin's health could barely have endured the strain of working for a living, and that nothing would have been left over for his researches. A deep debt of gratitude is owing to his father for placing him in a position in which all his energy could be devoted to scientific work and thought. But his ill-health was such that this important and essential condition would have been insufficient without another even more essential. Francis Darwin, in the *Life and Letters* (i. pp. 159-160), writes these eloquent and pathetic words:—"No one indeed, except my mother, knows the full amount of suffering he endured, or the full amount of his wonderful patience. For all the latter years of his life she never left him for a night; and her days were so planned that all his resting hours might be shared with her. She shielded him from every avoidable annoyance, and omitted nothing that might save him trouble, or prevent him becoming over-tired, or that might alleviate the many discomforts of his ill-health. I hesitate to speak thus freely of a thing so sacred as the lifelong devotion which prompted all this constant and tender care. But it is, I repeat, a principal feature of his life, that for nearly forty years he never knew one day of the health of ordinary men, and that thus his life was one long struggle against the weariness and the strain of sickness. And this cannot be told without speaking of the one condition which enabled him to bear the strain and fight out the struggle to the end."

Charles Darwin was honoured by the chief societies of the civilized world. He was made a knight of the Prussian order, "Pour le Mérite," in 1867, a corresponding member of the Berlin Academy of Sciences in 1863, a fellow in 1878, and later in the same year a corresponding member of the French Institute in the botanical section. He received the Bressa prize of the Royal Academy of Turin, and the Baly medal of the Royal College of Physicians in 1879, the Wollaston medal of the Geological Society in 1859, a Royal medal of the Royal Society in 1853, and the Copley medal in 1864. His health prevented him from accepting the honorary degree which Oxford University wished to confer on him, but his own university had stronger claims, and he received its honorary LL.D. in 1877.

Two daughters and five sons survived him, four of the latter becoming prominent in the scientific world,—Sir George Howard (b. 1845), who became professor of astronomy and experimental philosophy at Cambridge in 1883; Francis (b. 1848), the distinguished botanist; Leonard (b. 1850), a major in the royal engineers, and afterwards well known as an economist; and Horace (b. 1851), civil engineer.

See *The Life and Letters of Charles Darwin, including an autobiographical chapter*, edited by his son Francis Darwin (3 vols., London, 1887); *Charles Darwin and the Theory of Natural Selection*, by E. B. Poulton (London, 1896); *Life and Letters of Thomas Henry Huxley*, by Leonard Huxley (2 vols., London, 1900); A. R. Wallace, *Darwinism* (1889); G. J. Romanes, *Darwin and after Darwin* (1895). Also the article on T. H. HUXLEY. (E. B. P.)

**DARWIN, ERASMUS** (1731-1802), English man of science and poet, was born at Elton, in Nottinghamshire, on the 12th of December 1731. After studying at St John's College, Cambridge, and at Edinburgh, he settled in 1756 as a physician at Nottingham, but meeting with little success he moved in the following year to Lichfield. There he gained a large practice, and did much, both by example and by more direct effort, to diminish drunkenness among the lower classes. In 1781 he removed to Derby, where he died suddenly on the 18th of April 1802. The fame of Erasmus Darwin as a poet rests upon his *Botanic Garden*, though he also wrote *The Temple of Nature, or the Origin of Society, a Poem, with Philosophical Notes* (1803), and *The Shrine of Nature* (posthumously published). The *Botanic Garden* (the second part of which—*The Loves of the Plants*—was published anonymously in 1789, and the whole of which appeared in 1791) is a long poem in the decasyllabic rhymed couplet. Its merit lies in the genuine scientific enthusiasm and interest in nature which pervade it; and of any other poetic quality—except a certain, sometimes felicitous but oftener ill-placed, elaborated pomp of words—it may without injustice be said to be almost destitute. It was for the most part written laboriously, and polished with



unsparing care, line by line, often as he rode from one patient to another, and it occupied the leisure hours of many years. The artificial character of the diction renders it in emotional passages stilted and even absurd, and makes Canning's clever caricature—*The Loves of the Triangles*—often remarkably like the poem it satirizes: in some passages, however, it is not without a stately appropriateness. Gnomes, sylphs and nereids are introduced on almost every page, and personification is carried to an extraordinary excess. Thus he describes the *Loves of the Plants* according to the Linnaean system by means of a most ingenious but misplaced and amusing personification of each plant, and often even of the parts of the plant. It is significant that botanical notes are added to the poem, and that its eulogies of scientific men are frequent. Erasmus Darwin's mind was in fact rather that of a man of science than that of a poet. His most important scientific work is his *Zoonomia* (1794–1796), which contains a system of pathology, and a treatise on generation, in which he, in the words of his famous grandson, Charles Robert Darwin, "anticipated the views and erroneous grounds of opinions of Lamarck." The essence of his views is contained in the following passage, which he follows up with the conclusion "that one and the same kind of living filaments is and has been the cause of all organic life":—

"Would it be too bold to imagine that, in the great length of time since the earth began to exist, perhaps millions of ages before the commencement of the history of mankind,—would it be too bold to imagine that all warm-blooded animals have arisen from one living filament, which the great First Cause endued with animality, with the power of acquiring new parts, attended with new propensities, directed by irritations, sensations, volitions and associations, and thus possessing the faculty of continuing to improve by its own inherent activity, and of delivering down these improvements by generation to its posterity, world without end!"

In 1799 Darwin published his *Phytologia, or the Philosophy of Agriculture and Gardening* (1799), in which he states his opinion that plants have sensation and volition. A paper on *Female Education in Boarding Schools* (1797) completes the list of his works.

Robert Waring Darwin (1766–1848), his third son by his first marriage, a doctor at Shrewsbury, was the father of the famous Charles Darwin; and Violetta, his eldest daughter by his second marriage, was the mother of Francis Galton.

See Anna Seward, *Memoirs of the Life of Dr Darwin* (1804); and Charles Darwin, *Life of Erasmus Darwin, an introduction to an essay on his works by Ernst Krause* (1879).

**DASENT, SIR GEORGE WEBBE** (1817–1896), English writer, was born in St Vincent, West Indies, on the 22nd of May 1817, the son of the attorney-general of that island. He was educated at Westminster school, King's College, and Oxford, where he was a contemporary of J. T. Delane (*q.v.*), whose friend he had become at King's College. On leaving the university in 1840 he was appointed to a diplomatic post in Stockholm. Here he met Jacob Grimm, and at his suggestion first interested himself in Scandinavian literature and mythology. In 1842 he published the results of his studies, a version of *The Prose or Younger Edda*, and in the following year he issued a *Grammar of the Icelandic or Old-Norse Tongue*, taken from the Swedish. Returning to England in 1845, he became assistant editor of *The Times* under Delane, whose sister he married; but he still continued his Scandinavian studies, publishing translations of various Norse stories. In 1853 he was appointed professor of English literature and modern history at King's College, London. In 1861–1862 he visited Iceland, and subsequently published *Gisli the Outlaw* and other translations from the Icelandic. In 1870 he was appointed a civil service commissioner and consequently resigned his post on *The Times*. In 1876 he was knighted. He retired from the public service in 1892, and died at Ascot on the 11th of June 1896. In addition to the works mentioned above, he published *The Story of Burnt Njal*, from the Icelandic of the *Njals Saga* (1861).

See the *Life of Delane* (1908), by Arthur Irwin Dasent.

**DASHKOV, CATHERINA ROMANOVNA VORONTSOV**, PRINCESS (1744–1810), Russian *littérateur*, was the third daughter of Count Roman Vorontsov, a member of the Russian senate, distinguished for his intellectual gifts. (For the family see

VORONTSOV.) She received an exceptionally good education, having displayed from a very early age the masculine ability and masculine tastes which made her whole career so singular. She was well versed in mathematics, which she studied at the university of Moscow, and in general literature her favourite authors were Bayle, Montesquieu, Boileau, Voltaire and Helvetius. While still a girl she was connected with the Russian court, and became one of the leaders of the party that attached itself to the grand duchess (afterwards empress) Catherine. Before she was sixteen she married Prince Mikhail Dashkov, a prominent Russian nobleman, and went to reside with him at Moscow. In 1762 she was at St Petersburg and took a leading part, according to her own account the leading part, in the *coup d'état* by which Catherine was raised to the throne. (See CATHERINE II.) Another course of events would probably have resulted in the elevation of the Princess Dashkov's elder sister, Elizabeth, who was the emperor's mistress, and in whose favour he made no secret of his intention to depose Catherine. Her relations with the new empress were not of a cordial nature, though she continued devotedly loyal. Her blunt manners, her unconcealed scorn of the male favourites that disgraced the court, and perhaps also her sense of unrequited merit, produced an estrangement between her and the empress, which ended in her asking permission to travel abroad. The cause of the final breach was said to have been the refusal of her request to be appointed colonel of the imperial guards. Her husband having meanwhile died, she set out in 1768 on an extended tour through Europe. She was received with great consideration at foreign courts, and her literary and scientific reputation procured her the *entrée* to the society of the learned in most of the capitals of Europe. In Paris she secured the warm friendship and admiration of Diderot and Voltaire. She showed in various ways a strong liking for England and the English. She corresponded with Garrick, Dr Blair and Principal Robertson; and when in Edinburgh, where she was very well received, she arranged to entrust the education of her son to Principal Robertson. In 1782 she returned to the Russian capital, and was at once taken into favour by the empress, who strongly sympathized with her in her literary tastes, and specially in her desire to elevate Russ to a place among the literary languages of Europe. Immediately after her return the princess was appointed "directeur" of the St Petersburg Academy of Arts and Sciences; and in 1784 she was named the first president of the Russian Academy, which had been founded at her suggestion. In both positions she acquitted herself with marked ability. She projected the Russian dictionary of the Academy, arranged its plan, and executed a part of the work herself. She edited a monthly magazine; and wrote at least two dramatic works, *The Marriage of Fabian*, and a comedy entitled *Toissikoff*. Shortly before Catherine's death the friends quarrelled over a tragedy which the princess had allowed to find a place in the publications of the Academy, though it contained revolutionary principles, according to the empress. A partial reconciliation was effected, but the princess soon afterwards retired from court. On the accession of the emperor Paul in 1796 she was deprived of all her offices, and ordered to retire to a miserable village in the government of Novgorod, "to meditate on the events of 1762." After a time the sentence was partially recalled on the petition of her friends, and she was permitted to pass the closing years of her life on her own estate near Moscow, where she died on the 4th of January 1810.

Her son, the last of the Dashkov family, died in 1807 and bequeathed his fortune to his cousin Illarion Vorontsov, who thereupon by imperial licence assumed the name Vorontsov-Dashkov; and Illarion's son, Illarion Ivanovich Vorontsov-Dashkov (b. 1837), held an appointment in the tsar's household from 1881 to 1897.

The *Memoirs of the Princess Dashkoff written by herself* were published in 1840 in London in two volumes. They were edited by Mrs W. Bradford, who, as Miss Wilmot, had resided with the princess between 1803 and 1808, and had suggested their preparation.

**DASS, PETER** (1647–1708), the "father" of modern Norwegian poetry, was the son of Peter Dundas, a Scottish merchant of Dundee, who, leaving his country about 1630 to

escape the troubles of the Presbyterian church, settled in Bergen, and in 1646 married a Norse girl of good family. Petter Dass was born in 1647 on the island of Nord Herö, on the north coast of Norway. Seven years later his father died, and his mother placed him with his aunt, the wife of the priest of another little island-parish. In 1660 he was sent to school at Bergen, in 1665 to the university of Copenhagen, and in 1667 he began to earn his daily bread as a private tutor. In 1672 he was ordained priest, and remained till 1681 as under-chaplain at Nesne, a little parish near his birthplace; for eight years more he was resident chaplain at Nesne; and at last in 1689 he received the living of Alstahoug, the most important in the north of Norway. The rule of Alstahoug extended over all the neighbouring districts, including Dass's native island of Herö, and its privileges were accompanied by great perils, for it was necessary to be constantly crossing stormy firths of sea. Dass lived here in quietude, with something of the honours and responsibilities of a bishop, brought up his family in a God-fearing way, and wrote endless reams of verses. In 1700 he asked leave to resign his living in favour of his son Anders Dass, but this was not permitted; in 1704, however, Anders became his father's chaplain. About this time Petter went to Bergen, where he visited Dorothea Engelbrechtsdatter, with whom he had been for many years in correspondence. He continued to write till 1707, and died in August 1708. The materials for his biography are very numerous; he was regarded with universal curiosity and admiration in his lifetime; and, besides, he left a garrulous autobiography in verse. A portrait, painted in middle age, now in the church of Melhus, near Trondhjem, represents him in canonicals, with deep red beard and hair, the latter waved and silky, and a head of massive proportions. The face is full of fire and vigour. His writings passed in MS. from hand to hand, and few of them were printed in his lifetime. *Nordlands Trompet* (The Trumpet of Nordland), his greatest and most famous poem, was not published till 1739; *Den norske Dale-Vise* (The Norwegian Song of the Valley) appeared in 1696; the *Aandelig Tidsfordriv* (Spiritual Pastime), a volume of sacred poetry, was published in 1711. *The Trumpet of Nordland* remains as fresh as ever in the memories of the inhabitants of the north of Norway; boatmen, peasants, priests will alike repeat long extracts from it at the slightest notice, and its popularity is unbounded. It is a rhyming description of the province of Nordland, its natural features, its trades, its advantages and its drawbacks, given in dancing verse of the most breathless kind, and full of humour, fancy, wit and quaint learning. The other poems of Petter Dass are less universally read; they abound, however, in queer turns of thought, and fine homely fancies.

The collected writings of Dass were edited (3 vols., Christiania, 1873-1877) by Dr A. E. Eriksen.

**DASYURE**, a bookname for any member of the zoological family *Dasyuridae*. (See MARSUPIALIA.) The name is better restricted to animals of the typical genus *Dasyurus*, sometimes called true Dasyures. These are mostly inhabitants of the Australian continent and Tasmania, where in the economy of nature they take the place of the smaller predaceous Carnivora, the cats, civets and weasels of other parts of the world. They hide themselves in the daytime in holes among rocks or in hollow trees, but prowl about at night in search of the small living mammals and birds which constitute their prey, and are to some extent arboreal in habit. The spot-tailed dasyure (*D. maculatus*), about the size of a cat, inhabiting Tasmania and Southern Australia, has transversely striated pads on the soles of the feet. These organs are also present in the North Australian dasyure (*D. hallucatus*) and the Papuan *D. albopunctatus*, and are regarded by Oldfield Thomas as indication of arboreal habits; in the common dasyure (*D. viverrinus*) from Tasmania and Victoria, and the black-tailed dasyure (*D. geoffroyi*) from South Australia, these feet-pads are absent, whence these species are believed to seek their prey on the ground. The ursine dasyure (*Sarcophilus ursinus*), often called the "Tasmanian Devil," constitutes a distinct genus. In size it may be compared to an English badger; the general colour of the fur is black tinged

with brown, with white patches on the neck, shoulders, rump and chest. It is a burrowing animal, of nocturnal habits, intensely carnivorous, and commits great depredations on the sheepyards and poultry-lofts of the settlers. In writing of this species Kreffit says that one—by no means a large one—escaped from confinement and killed in two nights fifty-four fowls, six geese, an albatross and a cat. It was recaptured in what was considered a stout trap, with a door constructed of iron bars as thick as a lead pencil, but escaped by twisting this solid obstacle aside.

**DATE PALM.** The dates<sup>1</sup> of commerce are the fruit of a species of palm, *Phoenix dactylifera*, a tree which ranges from the Canary Islands through Northern Africa and the south-east of Asia to India. It has been cultivated and much prized throughout most of these regions from the remotest antiquity. Its cultivation and use are described on the mural tablets of the ancient Assyrians. In Arabia it is the chief source of national wealth, and its fruit forms the staple article of food in that country. The tree has also been introduced along the Mediterranean shores of Europe; but as its fruit does not ripen so far north, the European plants are only used to supply leaves for the festival of Palm Sunday among Christians, and for the celebration of the Passover by Jews. It was introduced into the new world by early Spanish missionaries, and is now cultivated in the dry districts of the south-western United States and in Mexico. The date palm is a beautiful tree, growing to a height of from 60 to 80 ft., and its stem, which is strongly marked with old leaf-scars, terminates in a crown of graceful shining pinnate leaves. The flowers spring in branching spadices from the axils of the leaves, and as the trees are unisexual it is necessary in cultivation to fertilize the female flowers by artificial means. The fruit is oblong, fleshy and contains one very hard seed which is deeply furrowed on the inside. The fruit varies much in size, colour and quality under cultivation. Regarding this fruit, W. G. Palgrave (*Central and Eastern Arabia*) remarked: "Those who, like most Europeans at home, only know the date from the dried specimens of that fruit shown beneath a label in shop-windows, can hardly imagine how delicious it is when eaten fresh and in Central Arabia. Nor is it, when newly gathered, heating,—a defect inherent to the preserved fruit everywhere; nor does its richness, however great, bring satiety; in short it is an article of food alike pleasant and healthy." In the oases of Sahara, and in other parts of Northern Africa, dates are pounded and pressed into a cake for food. The dried fruit used for dessert in European countries contains more than half its weight of sugar, about 6% of albumen, and 12% of gummy matter. All parts of the date palm yield valuable economic products. Its trunk furnishes timber for house-building and furniture; the leaves supply thatch; their footstalks are used as fuel, and also yield a fibre from which cordage is spun.

*Date sugar* is a valuable commercial product of the East Indies, obtained from the sap or toddy of *Phoenix sylvestris*, the toddy palm, a tree so closely allied to the date palm that it has been supposed to be the parent stock of all the cultivated varieties. The juice, when not boiled down to form sugar, is either drunk fresh, or fermented and distilled to form arrack. The uses of the other parts and products of this tree are the same as those of the date palm products. *Date palm meal* is obtained from the stem of a small species, *Phoenix farinifera*, growing in the hill country of southern India.

For further details see Sir G. Watt, *Dictionary of the Economic Products of India* (1892); and *The Date Palm*, U.S. Department of Agriculture, Bureau of Plant Industry, Bulletin No. 53 (W. T. Swingle), 1904.

**DATIA**, a native state of Central India, in the Bundelkhand agency. It lies in the extreme north-west of Bundelkhand, near Gwalior, and is surrounded on all sides by other states of Central India, except on the east where it meets the United Provinces. The state came under the British government after the treaty of Bassein in 1802. Area, 911 sq. m. Pop. (1901) 173,759. Estimated revenue, £70,000; tribute to Sindhia paid through the

<sup>1</sup> Lat. *dactylus*, finger, hence fruit of the date palm, gave O. Fr. *date*, mod. *datte*; distinguish "date," in chronology, from Lat. *datum*, *data*, given, used at the beginning of a letter, &c., to show time and place of writing, e.g. *Datum Romae*.

British Government, £1000. The chief, whose title is maharaja, is a Rajput of the Bundela clan, being descended from a younger son of a former chief of Orchha. The state suffered from famine in 1896-1897, and again to a less extent in 1899-1900. It is traversed by the branch of the Indian Midland railway from Jhansi to Gwalior. The town of Datia has a railway station, 16 m. from Jhansi. Pop. (1901) 24,071. It is surrounded by a stone wall, enclosing handsome palaces, with gardens; the palace of Bir Singh Deo, of the 17th century, is "one of the finest examples of Hindu domestic architecture in India" (*Imperial Gazetteer of India*, 1908).

**DATIVE** (Lat. *dativus*, giving or given, from *dare*, to give), the name, in grammar, of the case of the "indirect object," the person or thing to or for whom or which anything is given or done. In law, the word signifies something, such as an office, which may be disposed of at will or pleasure, and is opposed to perpetual. In Scots law the term is applied to persons, duties or powers, appointed or granted by a court of law; thus an "executor-dative" is an executor appointed by the court and not by a testator. It answers, therefore, to the English administrator (*q.v.*). In Roman law, a *tutor* was either *dativus*, if expressly nominated in a testament, or *optivus*, if a power of selection was given.

**DATOLITE**, a mineral species consisting of basic calcium and boron orthosilicate,  $\text{Ca}(\text{BOH})\text{SiO}_4$ . It was first observed by J. Esmark in 1806, and named by him from *δαρέισθαι*, "to divide," and *λίθος*, "stone," in allusion to the granular structure of the massive mineral. It usually occurs as well-developed glassy crystals bounded by numerous bright faces, many of which often have a more or less pentagonal outline. The crystals were for a long time considered to be orthorhombic, and indeed they approach closely to this system in habit, interfacial angles and optical orientation; humboldtite was the name given by A. Lévy in 1823 to monoclinic crystals supposed to be distinct from datolite, but the two were afterwards proved to be identical. The mineral also occurs as masses with a granular to compact texture; when compact the fractured surfaces have the appearance of porcelain. A fibrous variety with a botryoidal or globular surface is known as botryolite. Datolite is white or colourless, often with a greenish tinge; it is transparent or opaque. Hardness 5-5½; specific gravity 3.0.

Datolite is a mineral of secondary origin, and in its mode of occurrence it resembles the zeolites, being found with them in the amygdaloidal cavities of basic igneous rocks such as basalt; it is also found in gneiss and serpentine, and in metalliferous veins and in beds of iron ore. At Arendal in Norway, the original locality for both the crystallized and botryoidal varieties, it is found in a bed of magnetite. In amygdaloidal basaltic rocks it is found at Bishopton in Renfrewshire and near Edinburgh; and as excellent crystallized specimens at several localities in the United States, *e.g.* at Westfield in Massachusetts, Bergen and Paterson in New Jersey, and in the copper-mining region of Lake Superior. At St Andreasberg in the Harz it occurs both in diabase and in the veins of silver ore. Fine specimens have recently been obtained from Tasmania.

Large crystals of datolite completely altered to chalcodony were formerly found with magnetite in the Haytor iron mine on Dartmoor in Devonshire; to these pseudomorphs the name haytorite has been applied. (L. J. S.)

**DAUB, KARL** (1765-1836), German Protestant theologian, was born at Cassel on the 20th of March 1765. He studied philosophy, philology and theology at Marburg in 1786, and eventually (1795) became professor ordinarius of theology at Heidelberg, where he died on the 22nd of November 1836. Daub was one of the leaders of a school which sought to reconcile theology and philosophy, and to bring about a speculative reconstruction of orthodox dogma. In the course of his intellectual development, he came successively under the influence of Kant, Schelling and Hegel, and on account of the different phases through which he passed he was called the Talleyrand of German thought. There was one great defect in his speculative theology: he ignored historical criticism. His purpose was, as Otto Pfeiderer says, "to connect the metaphysical ideas, which

had been arrived at by means of philosophical dialectic, directly with the persons and events of the Gospel narratives, thus raising these above the region of ordinary experience into that of the supernatural, and regarding the most absurd assertions as philosophically justified. Daub had become so hopelessly addicted to this perverse principle that he deduced not only Jesus as the embodiment of the philosophical idea of the union of God and man, but also Judas Iscariot as the embodiment of the idea of a rival god, or Satan." The three stages in Daub's development are clearly marked in his writings. His *Lehrbuch der Katechetik* (1801) was written under the spell of Kant. His *Theologumena* (1806), his *Einleitung in das Studium der christl. Dogmatik* (1810), and his *Judas Iscarioth* (2 vols., 1816, 2nd ed., 1818), were all written in the spirit of Schelling, the last of them reflecting a change in Schelling himself from theosophy to positive philosophy. Daub's *Die dogmatische Theologie jetziger Zeit oder die Selbstsucht in der Wissenschaft des Glaubens* (1833), and *Vorlesungen über die Prolegomena zur Dogmatik* (1839), are Hegelian in principle and obscure in language.

See Rosenkranz, *Erinnerungen an Karl Daub* (1837); D. Fr. Strauss, *Charakteristiken und Kritiken* (2nd ed., 1844); and cf. F. Lichtenberger, *History of German Theology* (1889); Otto Pfeiderer, *Development of Theology* (1890). (M. A. C.)

**DAUBENTON, LOUIS-JEAN-MARIE** (1716-1800), French naturalist, was born at Montbar (Côte d'Or) on the 29th of May 1716. His father, Jean Daubenton, a notary, destined him for the church, and sent him to Paris to learn theology, but the study of medicine was more to his taste. The death of his father in 1736 set him free to follow his own inclinations, and accordingly in 1741 he graduated in medicine at Reims, and returned to his native town with the intention of practising as a physician. But about this time Buffon, also a native of Montbar, had formed the plan of bringing out a grand treatise on natural history, and in 1742 he invited Daubenton to assist him by providing the anatomical descriptions for that work. The characters of the two men were opposed in almost every respect. Buffon was violent and impatient; Daubenton, gentle and patient; Buffon was rash in his judgments, and imaginative, seeking rather to divine than to discover truths; Daubenton was cautious, and believed nothing he had not himself been able to see or ascertain. From nature each appeared to have received the qualities requisite to temper those of the other; and a more suitable coadjutor than Daubenton it would have been difficult for Buffon to obtain. In the first section of the natural history Daubenton gave descriptions and details of the dissection of 182 species of quadrupeds, thus procuring for himself a high reputation, and exciting the envy of Réaumur, who considered himself as at the head of the learned in natural history in France. A feeling of jealousy induced Buffon to dispense with the services of Daubenton in the preparation of the subsequent parts of his work, which, as a consequence, lost much in precision and scientific value. Buffon afterwards perceived and acknowledged his error, and renewed his intimacy with his former associate. The number of dissertations on natural history which Daubenton published in the memoirs of the French Academy is very great. Zoological descriptions and dissections, the comparative anatomy of recent and fossil animals, vegetable physiology, mineralogy, experiments in agriculture, and the introduction of the merino sheep into France gave active occupation to his energies; and the cabinet of natural history in Paris, of which in 1744 he was appointed keeper and demonstrator, was arranged and considerably enriched by him. From 1775 Daubenton lectured on natural history in the college of medicine, and in 1783 on rural economy at the Alfort school. He was also professor of mineralogy at the Jardin du Roi. As a lecturer he was in high repute, and to the last retained his popularity. In December 1799 he was appointed a member of the senate, but at the first meeting which he attended he fell from his seat in an apoplectic fit, and after a short illness died at Paris on the 1st of January 1800.

**DAUBENY, CHARLES GILES BRIDLE** (1795-1867), English chemist, botanist and geologist, was the third son of the Rev. James Daubeny, and was born at Stratton in Gloucestershire on

the 11th of February 1795. In 1808 he went to Winchester, and in 1810 he was elected to a demyship at Magdalen College, Oxford, where the lectures of Dr Kidd first awakened in him a desire for the cultivation of natural science. In 1814 he graduated with second-class honours, and in the next year he obtained the prize for the Latin essay. From 1815 to 1818 he studied medicine in London and Edinburgh. He took his M.D. degree at Oxford, and was a fellow of the College of Physicians. In 1819, in the course of a tour through France, he made the volcanic district of Auvergne a special study, and his *Letters on the Volcanos of Auvergne* were published in *The Edinburgh Journal*, 1820-21. He was elected F.R.S. in 1822. By subsequent journeys in Hungary, Transylvania, Italy, Sicily, France and Germany he extended his knowledge of volcanic phenomena; and in 1826 the results of his observations were given in a work entitled *A Description of Active and Extinct Volcanos* (2nd ed., 1848). In common with Gay Lussac and Davy, he held subterranean thermic disturbances to be probably due to the contact of water with metals of the alkalis and alkaline earths. In November 1822 Daubeny succeeded Dr Kidd as professor of chemistry at Oxford, and retained this post until 1855; and in 1834 he was appointed to the chair of botany, to which was subsequently attached that of rural economy. At the Oxford botanic garden he conducted numerous experiments upon the effect of changes in soil, light and the composition of the atmosphere upon vegetation. In 1830 he published in the *Philosophical Transactions* a paper on the iodine and bromine of mineral waters. In the following year appeared his *Introduction to the Atomic Theory*, which was succeeded by a supplement in 1840, and in 1850 by a second edition. In 1831 Daubeny represented the universities of England at the first meeting of the British Association, which at his request held their next session at Oxford. In 1836 he communicated to the Association a report on the subject of mineral and thermal waters. In 1837 he visited the United States, and acquired there the materials for papers on the thermal springs and the geology of North America, read in 1838 before the Ashmolean Society and the British Association. In 1856 he became president of the latter body at its meeting at Cheltenham. In 1841 Daubeny published his *Lectures on Agriculture*; in 1857 his *Lectures on Roman Husbandry*; in 1863 *Climate: an inquiry into the causes of its differences and into its influence on Vegetable Life*; and in 1865 an *Essay on the Trees and Shrubs of the Ancients*, and a *Catalogue of the Trees and Shrubs indigenous to Greece and Italy*. His last literary work was the collection of his *Miscellanies*, published in two volumes, in 1867. In all his undertakings Daubeny was actuated by a practical spirit and a desire for the advancement of knowledge; and his personal influence on his contemporaries was in keeping with the high character of his various literary productions. He died in Oxford on the 12th of December 1867.

See Obituary by John Phillips in *Proceedings of Ashmolean Soc.*, 1868.

**DAUBIGNY, CHARLES FRANÇOIS** (1817-1878), French landscape painter, allied in several ways with the Barbizon School, was born in Paris, on the 15th of February 1817, but spent much time as a child at Valmondois, a village on the Oise to the north-west of Paris. Daubigny was the son of an artist, and most of his family were painters. He began to paint very early in life, and at the age of seventeen he took a studio of his own. Within twelve months he had saved enough to go to Italy, where he studied and painted for nearly two years; he then returned to Paris, not to leave it again until, in 1860, he took a house at Auvers on the Oise. By 1837 Daubigny had become famous as a river and landscape painter, although he had been devoting himself as well to drawing in black-and-white, to etching, wood engraving, and lithography. In 1855 his picture, "Lock at Optevoz," now in the Louvre, was purchased by the state; four years later Daubigny was created knight of the Legion of Honour, and in 1874 he was promoted to be an officer. In 1866, at the invitation of Lord, then Mr, Leighton and others, he visited London, where, however, he was hurt by his now famous "Moonlight" being badly hung in the Old Royal Academy. But the personal

encouragement of his admirers in England made up for the disappointment, and the sale of his picture to a Royal Academician greatly pleased him. In 1870-1871 he again visited London, and subsequently Holland, where he painted a number of river scenes with windmills. In 1874, having returned to Paris, he fell ill, and from that time until he died (on the 19th of February 1878) his work won less distinction than before. In 1904 the municipality of Auvers-sur-Oise decided to erect a bronze monument to Daubigny's memory.

Daubigny's finest pictures were painted between 1864 and 1874, and these for the most part consist of carefully completed landscapes with trees, river and a few ducks. It has curiously been said, yet with some appearance of truth, that when Daubigny liked his pictures himself he added another duck or two, so that the number of ducks often indicates greater or less artistic quality in his pictures. One of his sayings was, "The best pictures do not sell," as he frequently found his finest achievements little understood. Yet although during the latter part of his life he was considered a highly successful painter, the money value of his pictures since his death has increased nearly tenfold. Daubigny is chiefly preferred in his riverside pictures, of which he painted a great number, but although there are two large landscapes by Daubigny in the Louvre, neither is a river view. They are for that reason not so typical as many of his smaller Oise and Seine pictures.

The works of Daubigny are, like Corot's, to be found in many modern collections. His most ambitious canvases are: "Spring-time" (1857), in the Louvre; "Borde de la Cure, Morvan" (1864); "Villerville sur Mer" (1864); "Moonlight" (1865); "Andrésy sur Oise" (1868); and "Return of the Flock—Moonlight" (1878).

His followers and pupils were his son Karl (who sometimes painted so well that his works are occasionally mistaken for those of his father, though in few cases do they equal his father's mastery), Oudinot, Delpy and Damoye.

See Fred Henriet, *C. Daubigny et son œuvre* (Paris, 1878); D. Croal Thomson, *The Barbizon School of Painters* (London, 1890); J. W. Mollett, *Daubigny* (London, 1890); J. Claretie, *Peintres et sculpteurs contemporains: Daubigny* (Paris, 1882); Albert Wolff, *La Capitale de l'art: Ch. François Daubigny* (Paris, 1881).

(D. C. T.)

**DAUBRÉE, GABRIEL AUGUSTE** (1814-1896), French geologist, was born at Metz, on the 25th of June 1814, and educated at the École Polytechnique in Paris. At the age of twenty he had qualified as a mining engineer, and in 1838 he was appointed to take charge of the mines in the Bas-Rhin (Alsace), and subsequently to be professor of mineralogy and geology at the Faculty of Sciences, Strassburg. In 1859 he became engineer in chief of mines, and in 1861 he was appointed professor of geology at the museum of natural history in Paris and was also elected member of the Academy of Sciences. In the following year he became professor of mineralogy at the École des Mines, and in 1872 director of that school. In 1880 the Geological Society of London awarded to him the Wollaston medal. His published researches date from 1841, when the origin of certain tin minerals attracted his attention; he subsequently discussed the formation of bog-iron ore, and worked out in detail the geology of the Bas-Rhin (1852). From 1857 to 1861, while engaged in engineering works connected with the springs of Plombières, he made a series of interesting observations on thermal waters and their influence on the Roman masonry through which they made their exit. He was, however, especially distinguished for his long-continued and often dangerous experiments on the artificial production of minerals and rocks. He likewise discussed the permeability of rocks by water, and the effects of such infiltration in producing volcanic phenomena; he dealt with the subject of metamorphism, with the deformations of the earth's crust, with earthquakes, and with the composition and classification of meteorites. He died in Paris on the 29th of May 1896.

His publications were: *Études et expériences synthétiques sur le métamorphisme et sur la formation des roches cristallines* (1860); *Études synthétiques de géologie expérimentale* (1879); *Les Eaux souterraines à l'époque actuelle* (2 vols., 1887); *Les Eaux souterraines aux époques anciennes* (1887).

**DAUDET, ALPHONSE** (1840-1897), French novelist, was born at Nîmes on the 13th of May 1840. His family, on both sides, belonged to the *bourgeoisie*. The father, Vincent Daudet, was a silk manufacturer—a man dogged through life by misfortune and failure. The lad, amid much truancy, had but a depressing boyhood. In 1856 he left Lyons, where his schooldays had been mainly spent, and began life as an usher at Alais, in the south. The position proved to be intolerable. As Dickens declared that all through his prosperous career he was haunted in dreams by the miseries of his apprenticeship to the blacking business, so Daudet says that for months after leaving Alais he would wake with horror thinking he was still among his unruly pupils. On the 1st of November 1857 he abandoned teaching, and took refuge with his brother Ernest, only some three years his senior, who was trying, "and thereto soberly," to make a living as a journalist in Paris. Alphonse betook himself to his pen likewise,—wrote poems, shortly collected into a small volume *Les Amoureu-ses* (1858), which met with a fair reception,—obtained employment on the *Figaro*, then under Cartier de Villemessant's energetic editorship, wrote two or three plays, and began to be recognized, among those interested in literature, as possessing individuality and promise. Morny, the emperor's all-powerful minister, appointed him to be one of his secretaries,—a post which he held till Morny's death in 1865,—and showed him no small kindness. He had put his foot on the road to fortune.

In 1866 appeared *Lettres de mon moulin*, which won the attention of many readers. The first of his longer books, *Le petit chose* (1868), did not, however, produce any very popular sensation. It is, in its main feature, the story of his own earlier years told with much grace and pathos. The year 1872 produced the famous *Aventures prodigieuses de Tartarin de Tarascon*, and the three-act piece *L'Arlésienne*. But *Fromont jeune et Risler aîné* (1874) at once took the world by storm. It struck a note, not new certainly in English literature, but comparatively new in French. Here was a writer who possessed the gift of laughter and tears, a writer not only sensible to pathos and sorrow, but also to moral beauty. He could create too. His characters were real and also typical; the *ratés*, the men who in life's battle had flashed in the pan, were touched with a master hand. The book was alive. It gave the illusion of a real world. *Jack*, the story of an illegitimate child, a martyr to his mother's selfishness, which followed in 1876, served only to deepen the same impression. Henceforward his career was that of a very successful man of letters,—publishing novel on novel, *Le Nabab* (1877), *Les Rois en exil* (1879), *Numa Roumestan* (1881), *Sapho* (1884), *L'Immortel* (1888),—and writing for the stage at frequent intervals,—giving to the world his reminiscences in *Trente ans de Paris* (1887), and *Souvenirs d'un homme de lettres* (1888). These, with the three *Tartarins*,—Tartarin the mighty hunter, Tartarin the mountaineer, Tartarin the colonist,—and the admirable short stories, written for the most part before he had acquired fame and fortune, constitute his life work.

Though Daudet defended himself from the charge of imitating Dickens, it is difficult altogether to believe that so many similarities of spirit and manner were quite unsought. What, however, was purely his own was his style. It is a style that may rightly be called "*impressionist*," full of light and colour, not descriptive after the old fashion, but flashing its intended effect by a masterly juxtaposition of words that are like pigments. Nor does it convey, like the style of the Goncourts, for example, a constant feeling of effort. It is full of felicity and charm,—*un charmeur* Zola has called him. An intimate friend of Edmond de Goncourt (who died in his house), of Flaubert, of Zola, Daudet belonged essentially to the naturalist school of fiction. His own experiences, his surroundings, the men with whom he had been brought into contact, various persons who had played a part, more or less public, in Paris life—all passed into his art. But he vivified the material supplied by his memory. His world has the great gift of life. *L'Immortel* is a bitter attack on the French Academy, to which august body Daudet never belonged.

Daudet wrote some charming stories for children, among which may be mentioned *La Belle Nivernaise*, the story of an old boat

and her crew. His married life—he married in 1867 Julia Allard—seems to have been singularly happy. There was perfect intellectual harmony, and Madame Daudet herself possessed much of his literary gift; she is known by her *Impressions de nature et d'art* (1879), *L'Enfance d'une Parisienne* (1883), and by some literary studies written under the pseudonym of Karl Steen. In his later years Daudet suffered from insomnia, failure of health and consequent use of chloral. He died in Paris on the 17th of December 1897.

The story of Daudet's earlier years is told in his brother Ernest Daudet's *Mon frère et moi*. There is a good deal of autobiographical detail in Daudet's *Trente ans de Paris* and *Souvenirs d'un homme de lettres*, and also scattered in his other books. The references to him in the *Journal des Goncourts* are numerous. See also L. A. Daudet, *Alphonse Daudet* (1898), and biographical and critical essays by R. H. Sherard (1894); by A. Gerstmann (1883); by B. Diederich (1900); by A. Hermant (1903), and a bibliography by J. Brivois (1895); also *The Works of Alphonse Daudet*, translated by L. Ensor, H. Frith, E. Bartow (1902, etc.). Criticism of Daudet is also to be found in F. Brunetière, *Le Roman naturaliste* (new ed., 1897); J. Lemaitre, *Les Contemporains* (vols. ii. and iv.); G. Pellissier, *Le Mouvement littéraire au XIX<sup>e</sup> siècle* (1890); A. Symons, *Studies in Prose and Verse* (1904). (F. T. M.)

**DAULATABAD**, a hill-fortress in Hyderabad state, India, about 10 m. N.W. of the city of Aurangabad. The former city of Daulatabad (Deogiri) has shrunk into a mere village, though to its earlier greatness witness is still borne by its magnificent fortress, and by remains of public buildings noble even in their decay. The fortress stands on a conical rock crowning a hill that rises almost perpendicularly from the plain to a height of some 600 ft. The outer wall, 2½ m. in circumference, once enclosed the ancient city of Deogiri (Devagiri), and between this and the base of the upper fort are three lines of defences. The fort is a place of extraordinary strength. The only means of access to the summit is afforded by a narrow bridge, with passage for not more than two men abreast, and a long gallery, excavated in the rock, which has for the most part a very gradual upward slope, but about midway is intercepted by a steep stair, the top of which is covered by a grating destined in time of war to form the hearth of a huge fire kept burning by the garrison above. Besides the fortifications Daulatabad contains several notable monuments, of which the chief are the Chand Minar and the Chini Mahal. The Chand Minar, considered one of the most remarkable specimens of Mahomedan architecture in southern India, is a tower 210 ft. high and 70 ft. in circumference at the base, and was originally covered with beautiful Persian glazed tiles. It was erected in 1445 by Ala-ud-din Bahmani to commemorate his capture of the fort. The Chini Mahal, or China Palace, is the ruin of a building once of great beauty. In it Abul Hasan, the last of the Kutb Shahi kings of Golconda, was imprisoned by Aurangzeb in 1687.

Deogiri is said to have been founded c. A.D. 1187 by Bhillama I. the prince who renounced his allegiance to the Chalukyas and established the power of the Yadava dynasty in the west. In 1294 the fort was captured by Ala-ud-din Khilji, and the rajas, so powerful that they were held by the Mussulmans at Delhi to be the rulers of all the Deccan, were reduced to pay tribute. The tribute falling into arrear, Deogiri was again occupied by the Mahomedans under Malik Kafur, in 1307 and 1310, and in 1318 the last raja, Harpal, was flayed alive. Deogiri now became an important base for the operations of the Mussulman conquering expeditions southwards, and in 1339 Mahommed ben Tughlak Shah determined to make it his capital, changed its name to Daulatabad ("Abode of Prosperity"), and made arrangements for transferring to it the whole population of Delhi. The project was interrupted by troubles which summoned him to the north; during his absence the Mussulman governors of the Deccan revolted; and Daulatabad itself fell into the hands of Zafar Khan, the governor of Gulbarga. It remained in the hands of the Bahmanis till 1526, when it was taken by the Nizam Shahis. It was captured by the emperor Akbar, but in 1595 it again surrendered to Ahmad Nizam Shah of Ahmednagar, on the fall of whose dynasty in 1607 it passed into the hands of the usurper, the Nizam Shahi minister Malik Amber, originally an Abyssinian slave, who was the founder of Kharki (the present Aurangabad).



His successors held it until their overthrow by Shah Jahan, the Mogul emperor, in 1633; after which it remained in the possession of the Delhi emperors until, after the death of Aurangzeb, it fell to the first nizams of Hyderabad. Its glory, however, had already decayed owing to the removal of the seat of government by the emperors to Aurangabad.

**DAUMIER, HONORÉ** (1808–1879), French caricaturist and painter, was born at Marseilles. He showed in his earliest youth an irresistible inclination towards the artistic profession, which his father vainly tried to check by placing him first with a *huissier*, and subsequently with a bookseller. Having mastered the technique of lithography, Daumier started his artistic career by producing plates for music publishers, and illustrations for advertisements; these were followed by anonymous work for publishers, in which he followed the style of Charlet and displayed considerable enthusiasm for the Napoleonic legend. When, in the reign of Louis Philippe, Philipon launched the comic journal, *La Caricature*, Daumier joined its staff, which included such powerful artists as Devéria, Raffet and Grandville, and started upon his pictorial campaign of scathing satire upon the foibles of the bourgeoisie, the corruption of the law and the incompetence of a blundering government. His caricature of the king as "Gargantua" led to Daumier's imprisonment for six months at Ste Pélagie in 1832. The publication of *La Caricature* was discontinued soon after, but Philipon provided a new field for Daumier's activity when he founded the *Charivari*. For this journal Daumier produced his famous social caricatures, in which bourgeois society is held up to ridicule in the figure of Robert Macaire, the hero of a then popular melodrama. Another series, "*L'histoire ancienne*," was directed against the pseudo-classicism which held the art of the period in fetters. In 1848 Daumier embarked again on his political campaign, still in the service of *Charivari*, which he left in 1860 and rejoined in 1864. In spite of his prodigious activity in the field of caricature—the list of Daumier's lithographed plates compiled in 1904 numbers no fewer than 3958—he found time for flight in the higher sphere of painting. Except for the searching truthfulness of his vision and the powerful directness of his brushwork, it would be difficult to recognize the creator of *Robert Macaire*, of *Les Bas bleus*, *Les Bohémiens de Paris*, and the *Masques*, in the paintings of "Christ and His Apostles" at the Ryks Museum in Amsterdam, or in his "Good Samaritan," "Don Quixote and Sancho Panza," "Christ Mocked," or even in the sketches in the Ionides Collection at South Kensington. But as a painter, Daumier, one of the pioneers of naturalism, was before his time, and did not meet with success until in 1878, a year before his death, when M. Durand-Ruel collected his works for exhibition at his galleries and demonstrated the full range of the genius of the man who has been well called the Michelangelo of caricature. At the time of this exhibition Daumier, totally blind, was living in a cottage at Valmondois, which was placed at his disposal by Corot, and where he breathed his last in 1879. An important exhibition of his works was held at the École des Beaux-Arts in 1900.

His life and art were made the subject of an important volume by Arsène Alexandre in 1888; see also Gustave Geffroy, *Daumier* (Paris, Librairie de l'Art), and Henri Frantz and Octave Uzanne, *Daumier and Gavarni* (London, *The Studio*, 1904), with a large selection of the artist's work.

**DAUN (DHAUN), LEOPOLD JOSEF, COUNT VON** (1705–1766), prince of Thiano, Austrian field marshal, was born at Vienna on the 24th of September 1705. He was intended for the church, but his natural inclination for the army, in which his father and grandfather had been distinguished generals, proved irresistible. In 1718 he served in the campaign in Sicily, in his father's regiment. He had already risen to the rank of colonel when he saw further active service in Italy and on the Rhine in the War of the Polish Succession (1734–35). He continued to add to his distinctions in the war against the Turks (1737–39), in which he attained the rank of a general officer. In the War of the Austrian Succession (1740–42), Daun, already a lieutenant field marshal in rank, distinguished himself by the careful leadership which was afterwards his greatest military quality. He was

present at Chotusitz and Prague, and led the advanced guard of Khevenhüller's army in the victorious Danube campaign of 1743. Field Marshal Traun, who succeeded Khevenhüller in 1744, thought equally highly of Daun, and entrusted him with the rearguard of the Austrian army when it escaped from the French to attack Frederick the Great. He held important commands in the battles of Hohenfriedberg and Soor, and in the same year (1745) was promoted to the rank of *Feldzeugmeister*. After this he served in the Low Countries, and was present at the battle of Val. He was highly valued by Maria Theresa, who made him commandant of Vienna and a knight of the Golden Fleece, and in 1754 he was elevated to the rank of field marshal.

During the interval of peace that preceded the Seven Years' War he was engaged in carrying out an elaborate scheme for the reorganization of the Austrian army; and it was chiefly through his instrumentality that the military academy was established at Wiener-Neustadt in 1751. He was not actively employed in the first campaigns of the war, but in 1757 he was placed at the head of the army which was raised to relieve Prague. On the 18th of June 1757 Daun defeated Frederick for the first time in his career in the desperately fought battle of Kolin (*q.v.*). In commemoration of this brilliant exploit the queen immediately instituted a military order bearing her name, of which Daun was nominated first grand cross. The union of the relieving army with the forces of Prince Charles at Prague reduced Daun to the position of second in command, and as such he took part in the pursuit of the Prussians and the victory of Breslau. Frederick now reappeared and won the most brilliant victory of the age at Leuthen. Daun was present on that field, but was not held accountable for the disaster, and when Prince Charles resigned his command, Daun was appointed in his place. With the campaign of 1758 began the war of manœuvre in which Daun, if he missed, through over-caution, many opportunities of crushing the Prussians, at least maintained a steady and cool resistance to the fiery strategy of Frederick. In 1758 Major-General Loudon, acting under Daun's instructions, forced the king to raise the siege of Olmütz, and later in the same year Daun himself surprised Frederick at Hochkirch and inflicted a severe defeat upon him (October 14th). In the following year the war of manœuvre continued, and on the 20th and 21st of November he surrounded the entire corps of General Finck at Maxen, forcing the Prussians to surrender. These successes were counterbalanced in the following year by the defeat of Loudon at Liegnitz, which was attributed to the dilatoriness of Daun, and Daun's own defeat in the great battle of Torgau (*q.v.*). In this engagement Daun was so severely wounded that he had to return to Vienna to recruit.

He continued to command until the end of the war, and afterwards worked with the greatest energy at the reorganization of the imperial forces. In 1762 he had been appointed president of the *Hofkriegsrath*. He died on the 5th of February 1766. By the order of Maria Theresa a monument to his memory was erected in the church of the Augustinians, with an inscription styling him the "saviour of her states." In 1888 the 56th regiment of Austrian infantry was named after him. As a general Daun has been reproached for the dilatoriness of his operations, but wariness was not misplaced in opposing a general like Frederick, who was quick and unexpected in his movements beyond all precedent. Less defence perhaps may be made for him on the score of inability to profit by a victory.

See *Der deutsche Fabius Cunctator, oder Leben u. Thaten S. E. des H. Leopold Reichsgrafen v. Dhaun K.K.F.M.* (Frankfort and Leipzig, 1759–1760), and works dealing with the wars of the period.

**DAUNOU, PIERRE CLAUDE FRANÇOIS** (1761–1840), French statesman and historian, was born at Boulogne-sur-Mer, and after a brilliant career in the school of the Oratorians there, joined the order in Paris in 1777. He was professor in various seminaries from 1780 till 1787, when he was ordained priest. He was already known in literary circles by several essays and poems, when the revolution opened a wider career. He threw himself with ardour into the struggle for liberty, and refused to be

silenced in his advocacy of the civil constitution of the clergy by the offer of high office in the church. Elected to the Convention by Pas-de-Calais, he associated himself with the Girondists, but strongly opposed the death sentence on the king. He took little part in the struggle against the Mountain, but was involved in the overthrow of his friends, and was imprisoned for a year. In December 1794 he returned to the Convention, and was the principal author of the constitution of the year III. It seems to have been due to his Girondist ideas that the Ancients were given the right of convoking the *corps législatif* outside Paris, an expedient which made possible Napoleon's *coup d'état* of the 18th and 19th Brumaire. The creation of the Institute was also due to Daunou, who drew up the plan for its organization. His energy was largely responsible for the suppression of the royalist insurrection of the 13th Vendémiaire, and the important place he occupied at the beginning of the Directory is indicated by the fact that he was elected by twenty-seven departments as member of the Council of Five Hundred, and became its first president. He had himself set the age qualification of the directors at forty, and thus debarred himself as candidate, as he was only thirty-four. The direction of affairs having passed into the hands of Talleyrand and his associates, Daunou turned once more to literature, but in 1798 he was sent to Rome to organize the republic there, and again, almost against his will, he lent his aid to Napoleon in the preparation of the constitution of the year VIII. His attitude towards Napoleon was not lacking in independence, but in this controversy with the pope, the emperor was able again to secure from him the learned treatise *Sur la puissance temporelle du Pape* (1809). Still he took little part in the new régime, with which at heart he had no sympathy, and turned more and more to literature. At the Restoration he was deprived of the post of archivist of the empire, which he had held from 1807, but from 1819 to 1830 (when he again became archivist of the kingdom) he held the chair of history and ethics at the Collège de France, and his courses were among the most famous of that age of public lectures. During the reign of Louis Philippe he received many honours. In 1839 he was made a peer. He died in 1840.

In politics Daunou was a Girondist without combativeness; a conflicted republican, who lent himself always to the policy of conciliation, but whose probity remained unchallenged. He belonged essentially to the centre, and lacked both the genius and the temperament which would secure for him a commanding place in a revolutionary era. As an historian his breadth of view is remarkable for his time; for although thoroughly imbued with the classical spirit of the 18th century, he was able to do justice to the middle ages. His *Discours sur l'état des lettres au XIII<sup>e</sup> siècle*, in the sixteenth volume of the *Histoire littéraire de France*, is a remarkable contribution to that vast collection, especially as coming from an author so profoundly learned in the ancient classics. Daunou's lectures at the Collège de France, collected and published after his death, fill twenty volumes (*Cours d'études historiques*, 1842-1846). They treat principally of the criticism of sources and the proper method of writing history, and occupy an important place in the evolution of the scientific study of history in France. All his works were written in the most elegant style and chaste diction; but apart from his share in the editing of the *Historiens de la France*, they were mostly in the form of separate articles on literary and historical subjects. Personally Daunou was reserved and somewhat austere, preserving in his habits a strange mixture of bourgeois and monk. His indefatigable work as archivist in the time when Napoleon was transferring so many treasures to Paris is not his least claim to the gratitude of scholars.

See Mignet, *Notice historique sur la vie et les travaux de Daunou* (Paris, 1843); Taillandier, *Documents bibliographiques sur Daunou* (Paris, 1847), including a full list of his works; Sainte-Beuve, *Daunou* in his *Portraits Contemporains*, t. iii. (unfavourable and somewhat unfair).

**DAUPHIN** (Lat. *Delphinus*), an ancient feudal title in France, borne only by the counts and dauphins of Vienne, the dauphins of Auvergne, and from 1364 by the eldest sons of the kings of

France. The origin of this curious title is obscure and has been the subject of much ingenious controversy; but it now seems clear that it was in the first instance a proper name. Among the Norsemen, and in the countries colonized by them, the name Dolphin or Dolfin (*dolfr*, "a wound") was fairly common, e.g. in the north of England; thus a Dolfin is mentioned among the tenants-in-chief in Domesday Book, and there was a Dolphin, lord of Carlisle, towards the end of the 11th century. It has thus been conjectured by some that the dauphins of Vienne derived their title from Teutonic sources through Germany. But in the south, too, the name—not necessarily derived from the same root—was not unknown, though exceedingly rare, and was moreover illustrated by two conspicuous figures in the Catholic martyrology: St Delphinus, bishop of Bordeaux from 380 to 404, and St Annemundus, surnamed Dalphinus, bishop of Lyons from c. 650 to 657. Whatever its origin, this name was borne by Guigo, or Guigue IV. (d. 1142), count of Albon and Grenoble, as an additional name, during the lifetime of his father, and was also adopted by his son Guigue V. Beatrice, daughter and heiress of Guigue V., whose second husband was Hugh III., duke of Burgundy, bestowed the name on their son André, to recall his descent from the ancient house of the counts of Albon, and in the charters he is called sometimes Andreas Dalphinus, sometimes Dalphinus simply, but his style is still "count of Albon and Vienne." His successors Guigue VI. (d. 1270) and John I. (d. 1282) call themselves sometimes Delphinus, sometimes Delphini, the name being obviously treated as a patronymic, and in the latter form it was borne by the sons of the reigning "dauphin." But even under Guigue VI. foreigners had begun to confuse the name with a title of dignity, an imperial diploma of 1248 describing Guigue as "Guigo Dalphinus Viennensis."

It was not until the third dynasty, founded by the marriage of Anne, heiress of John I., with Humbert, lord of La Tour du Pin, that "dauphin" became definitely established as a title. Humbert not only assumed the name of Delphinus, but styled himself regularly Dauphin of the Viennois (*Dalphinus Viennensis*), and in a treaty concluded in 1285 between Humbert and Robert, duke of Burgundy, the word *delphinatus* (Dauphiné) appears for the first time, as a synonym for *comitatus* (county). In 1349 Humbert II., the last of his race, sold Dauphiné to Charles of Valois, who, when he became king of France in 1364, transferred it to his eldest son. From that time the eldest sons of the kings of France were always either actual or titular dauphins of the Viennois. The "canting arms" of a dolphin, which they quartered with the royal *fleurs de lys*, were originally assumed by Dauphin, count of Clermont, instead of the arms of Auvergne (the earliest extant example is appended to a deed of 1199), and from him they were borrowed by the counts of the Viennois. Guigue VI. used this device on his secret seal from his accession, the earliest extant example dating from 1237, but, though no specimens have survived, M. Prudhomme thinks it probable that the dolphin was also borne by André Dauphin. It was also assumed by Guigue V., count of Forez (1203-1241), a descendant of Guigue Raymond of the Viennois, count of Forez, in right of his wife Ida Raymonde. It is thus abundantly clear that the name of Dauphin was not assumed from the armorial device, but vice versa.

The eldest son of the French king was sometimes called "the king dauphin" (*le roy daulphin*), to distinguish him from the dauphin of Auvergne, who was known, since Auvergne became an appanage of the royal house, as "the prince dauphin." The dauphinat of Auvergne, which is to be distinguished from the county, dates from 1155, when William VII., count of Auvergne, was deposed by his uncle William VIII. "the Old." William VII. had married a daughter of Guigue IV. Dauphin, after whom their son was named Dauphin (Delphinus). The name continued, as in Viennois, as a patronymic, and was not used as a title until 1281, when Robert II., count of Clermont, in his will, styles himself for the first time Dauphin of Auvergne (*Alvernie delphinus*) for the portion of the county of Auvergne left to his house. In 1428 Jeanne, heiress of the dauphin Béraud III., married Louis de Bourbon, count of Montpensier (d. 1486), thus bringing the

dauphinate into the royal house of France. It was annexed to the crown in 1693.

See A. Prudhomme, "De l'origine et du sens des mots dauphin et dauphiné" in *Bibliothèque de l'École des Chartes*, liv. an. 1893 (Paris, 1893).

**DAUPHINÉ**, one of the old provinces (the name being still in current use in the country) of pre-Revolutionary France, in the south-east portion of France, between Provence and Savoy; since 1790 it forms the departments of the Isère, the Drôme and the Hautes Alpes.

After the death of the last king of Burgundy, Rudolf III., in 1032, the territories known later as Dauphiné (as part of his realm) reverted to the far-distant emperor. Much confusion followed, out of which the counts of Albon (between Valence and Vienne) gradually came to the front. The first dynasty ended in 1162 with Guigue V., whose daughter and heiress, Beatrice, carried the possessions of her house to her husband, Hugh III., duke of Burgundy. Their son, André, continued the race, this second dynasty making many territorial acquisitions, among them (by marriage) the Embrunais and the Gapençais in 1232. In 1282 the second dynasty ended in another heiress, Anna, who carried all to her husband, Humbert, lord of La Tour du Pin (between Lyons and Grenoble). The title of the chief of the house was Count (later Dauphin) of the Viennois, *not* of Dauphiné. (For the origin of the terms Dauphin and Dauphiné see DAUPHIN.) Humbert II. (1333-1349), grandson of the heiress Anna, was the last independent Dauphin, selling his dominions in 1349 to Charles of Valois, who on his accession to the throne of France as Charles V. bestowed Dauphiné on his eldest son, and the title was borne by all succeeding eldest sons of the kings of France. In 1422 the Diois and the Valentinois, by the will of the last count, passed to the eldest son of Charles VI., and in 1424 were annexed to the Dauphiné. Louis (1440-1461), later Louis XI. of France, was the last Dauphin who occupied a semi-independent position, Dauphiné being annexed to the crown in 1456. The suzerainty of the emperor (who in 1378 had named the Dauphin "Imperial Vicar" within Dauphiné and Provence) gradually died out. In the 16th century the names of the reformer Guillaume Farel (1489-1565) and of the duke of Lesdiguières (1543-1626) are prominent in Dauphiné history. The "States" of Dauphiné (dating from about the middle of the 14th century) were suspended by Louis XIII. in 1628, but their unauthorized meeting (on the 21st of July 1788) in the tennis court (*Salle du Jeu de Paume*) of the castle of Vizille, near Grenoble, was one of the earliest premonitory signs of the great French Revolution of 1789. It was at Laffrey, near Grenoble, that Napoleon (March 7th, 1815) was first acclaimed by his old soldiers sent to arrest him.

**BIBLIOGRAPHY.**—J. Brun-Durand, *Dictionnaire topographique du département de la Drôme* (Paris, 1891); Jules Chevalier, *Essai historique sur l'église et la ville de Die*, Montélimar and Valence (2 vols., 1888 and 1896); W. A. B. Coolidge, H. Duhamel and Félix Perrin, *Climbers' Guide to the Central Alps of the Dauphiny* (a revision of a French work by the same, issued at Grenoble in 1887), London, 1892 (new ed. 1905); J. J. Guiffrey, *Histoire de la réunion du Dauphiné à la France* (Paris, 1868); Joanne, *Dauphiné* (Paris, 1905); A. Prudhomme, *Histoire de Grenoble* (Grenoble, 1888); *Ib.*, "De l'origine des mots 'Dauphin' et Dauphiné" (article in vol. liv. (1893) of the *Bibliothèque de l'École des Chartes*); A. Rochas, *Biographie du Dauphiné* (2 vols., Paris, 1856); J. Roman, *Dictionnaire topographique* (Paris, 1884); *Tableau historique* (Paris, 2 vols., 1887 and 1890); and *Répertoire archéologique du département des Hautes-Alpes* (Paris, 1888); J. Roman, *Histoire de la ville de Gap* (Gap, 1892); A. De Terrebasse, *Notice sur les Dauphins de Viennois* (Vienne, 1875); J. M. De Valbonnais, *Histoire de Dauphiné* (2 vols., Geneva, 1722); J. A. Félix Faure, *Les Assemblées de Vizille et de Romans*, 1788 (Paris, 1887); O. Chenavas, *La Révolution de 1788 en Dauphiné* (Grenoble, 1888); C. Lory, *Description géologique du Dauphiné* (Paris, 1860). (W. A. B. C.)

**DAURAT** (or DORAT), **JEAN** (in Lat. AURATUS), (1508-1588), French poet and scholar, and member of the Pléiade, was born at Limoges in 1508. His name was originally Dinemandy. He belonged to a noble family, and, after studying at the college of Limoges, came up to Paris to be presented to Francis I., who made him tutor to his pages. He rapidly gained an immense

reputation as a classical scholar. As a private tutor in the house of Lazare de Baif, he had J. A. de Baif for his pupil. His son, Louis, showed great precocity, and at the age of ten translated into French verse one of his father's Latin pieces; his poems were published with his father's. Jean Daurat became the director of the Collège de Coqueret, where he had among his pupils, besides Baif, Ronsard, Remy, Belleau and Pontus de Tyard. Joachim du Bellay was added by Ronsard to this group; and these five young poets, under the direction of Daurat, formed a society for the reformation of the French language and literature. They increased their number to seven by the initiation of the dramatist Étienne Jodelle, and thereupon they named themselves La Pléiade, in emulation of the seven Greek poets of Alexandria. The election of Daurat as their president proved the weight of his personal influence, and the value his pupils set on the learning to which he introduced them, but as a writer of French verse he is the least important of the seven. Meanwhile he collected around him a sort of Academy, and stimulated the students on all sides to a passionate study of Greek and Latin poetry. He himself wrote incessantly in both those languages, and was styled the Modern Pindar. His influence extended beyond the bounds of his own country, and he was famous as a scholar in England, Italy and Germany. In 1556 he was appointed professor of Greek at the Collège Royale, a post which he continued to hold until, in 1567, he resigned it in favour of his nephew, Nicolas Goulu. Charles IX. gave him the title of *poeta regius*. His flow of language was the wonder of his time; he is said to have composed more than 15,000 Greek and Latin verses. The best of these he published at Paris in 1586 as *J. Aurati Lemovicis poetae et interpretis regii poemata*. He died at Paris on the 1st of November 1588, having survived all his illustrious pupils of the Pléiade, except Pontus de Tyard. He was a little, restless man, of untiring energy, rustic in manner and appearance. His unequalled personal influence over the most graceful minds of his age gives him an importance in the history of literature for which his own somewhat vapid writings do not fully account.

The *Œuvres poétiques* in the vernacular of Jean Daurat were edited (1875) with biographical notice and bibliography by Ch. Marty-Laveaux in his *Pléiade française*.

**DAVENANT, CHARLES** (1656-1714), English economist, eldest son of Sir William Davenant, the poet, was born in London, and educated at Cheam grammar school and Balliol College, Oxford, but left the university without taking a degree. At the age of nineteen he had composed a tragedy, *Circe*, which met with some success, but he soon turned his attention to law, and having taken the degree of LL.D., he became a member of Doctors' Commons. He was member of parliament successively for St Ives, Cornwall, and for Great Bedwyn. He held the post of commissioner of excise from 1683 to 1689, and that of inspector-general of exports and imports from 1705 till his death in 1714. He was also secretary to the commission appointed to treat for the union with Scotland. As an economist, he must be classed as a strong supporter of the mercantile theory, and in his economic pamphlets—as distinct from his political writings—he takes up an eclectic position, recommending governmental restrictions on colonial commerce as strongly as he advocates freedom of exchange at home. Of his writings, a complete edition of which was published in London in 1771, the following are the more important:—*An Essay on the East India Trade* (1697); *Two Discourses on the Public Revenues and Trade of England* (1698); *An Essay on the probable means of making the people gainers in the balance of Trade* (1699); *A Discourse on Grants and Resumptions and Essays on the Balance of Power* (1701).

**DAVENANT** (or D'AVENANT), **SIR WILLIAM** (1606-1668), English poet and dramatist, was baptized on the 3rd of March 1606; he was born at the Crown Inn, Oxford, of which his father, a wealthy vintner, was proprietor. It was stated that Shakespeare always stopped at this house in passing through the city of Oxford, and out of his known or rumoured admiration of the hostess, a very fine woman, there sprang a scandalous story which attributed Davenant's paternity to Shakespeare, a legend which there is reason to believe Davenant himself encouraged,

but which later criticism has cast aside as spurious. In 1621 the vintner was made mayor of Oxford, and in the same year his son left the grammar school of All Saints, where his master had been Edward Sylvester, and was entered an undergraduate of Lincoln College, Oxford. He did not stay at the university, however, long enough to take a degree, but was hurried away to appear at court as a page, in the retinue of the gorgeous duchess of Richmond. From her service he passed into that of Fulke Greville, Lord Brooke, in whose house he remained until the murder of that eminent man in 1628. This blow threw him upon the world, not altogether without private means, but greatly in need of a profitable employment.

He turned to the stage for subsistence, and in 1629 produced his first play, the tragedy of *Albovine*. It was not a very brilliant performance, but it pleased the town, and decided the poet to pursue a dramatic career. The next year saw the production at Blackfriars of *The Cruel Brother*, a tragedy, and *The Just Italian*, a tragi-comedy. Inigo Jones, the court architect, for whom Ben Jonson had long supplied the words of masques and complimentary pieces, quarrelled with his great colleague in the year 1634, and applied to William Davenant for verses. The result was *The Temple of Love*, performed by the queen and her ladies at Whitehall on Shrove Tuesday, 1634, and printed in that year. Another masque, *The Triumphs of the Prince D'Amour*, followed in 1636. The poet returned to the legitimate drama by the publication of the tragi-comedy of *The Platonic Lovers*, and the famous comedy of *The Wits*, in 1636, the latter of which, however, had been licensed in 1633. The masque of *Britannica Triumphans* (1637) brought him into some trouble, for it was suppressed as a punishment for its first performance having been arranged for a Sunday. By this time Davenant had, however, thoroughly ingratiated himself with the court; and on the death of Ben Jonson in 1637 he was rewarded with the office of poet-laureate, to the exclusion of Thomas May, who considered himself entitled to the honour. It was shortly after this event that Davenant collected his minor lyrical pieces in a volume entitled *Madagascar and other Poems* (1638); and in 1639 he became manager of the new theatre in Drury Lane. The civil war, however, put a check upon this prosperous career; and he was among the most active partisans of royalty through the whole of that struggle for supremacy.

As early as May 1642, Davenant was accused before the Long Parliament of being mainly concerned in a scheme to seduce the army to overthrow the Commons. He was accordingly apprehended at Faversham, and imprisoned for two months in London; he then attempted to escape to France, and succeeded in reaching Canterbury, where he was recaptured. Escaping a second time, he made good his way to the queen, with whom he remained in France until he volunteered to carry over to England some military stores for the army of his old friend the earl of Newcastle, by whom he was induced to enter the service as lieutenant-general of ordnance. He acquitted himself with so much bravery and skill that, after the siege of Gloucester, in 1643, he was knighted by the king. After the battle of Naseby he retired to Paris, where he became a Roman Catholic, and spent some months in the composition of his epic poem of *Gondibert*. In 1646 he was sent by the queen on a mission to Charles I., then at Newcastle, to advise him to "part with the church for his peace and security." The king dismissed him with some sharpness, and Davenant returned to Paris, where he was the guest of Lord Jermyn. In 1650 he took the command of a colonizing expedition that set sail from France to Virginia, but was captured in the Channel by a parliamentary man-of-war, which took him back to the Isle of Wight. Imprisoned in Cowes castle until 1651, he tempered the discomfort and suspense of his condition by continuing the composition of *Gondibert*. He was sent up to the Tower to await his trial for high treason, but just as the storm was about to break over his head, all cleared away. It is believed that the personal intercession of Milton led to this result. Another account is that he was released by the desire of two aldermen of York, once his prisoners, whom he had allowed to escape. Davenant, released from prison, immediately published *Gondibert*,

the work on which his fame mainly rests, a chivalric epic in the four-line stanza which Sir John Davies had made popular by his *Nosce teipsum*, the influence of which is strongly marked in the philosophical passages of *Gondibert*. It is a cumbrous, dull production, but is relieved with a multitude of fine and felicitous passages, and lends itself most happily to quotation.

During the civil war one of his plays had been printed, the tragedy of *The Unfortunate Lovers*, in 1643. One of his best plays, *Love and Honour*, was published in 1649, but appears to have been acted long before. He found that there were many who desired him to recommence his theatrical career. Such a step, however, was absolutely forbidden by Puritan law. Davenant, therefore, by the help of some influential friends, obtained permission to open a sort of theatre at Rutland House, in Charterhouse Yard, where, on the 21st of May 1656, he began a series of representations, which he called *operas*, as an inoffensive term. This word was then first introduced into the English language. The opening piece was a kind of dialogue defending the drama in the abstract. This was followed by his own *Siege of Rhodes*, printed the same year, which was performed with stage decorations and machinery of a kind hitherto quite unthought of in England. Two other innovations in its production were the introduction of recitative and the appearance of a woman, Mrs Coleman, on the stage. He continued until the Restoration to produce ephemeral works of this kind, only one of which, *The Cruelty of the Spaniards in Peru*, in 1658, was of sufficient literary merit to survive. In 1660 he had the infinite satisfaction of being able to preserve the life of that glorious poet who had, nine years before, saved his own from a not less imminent danger. The mutual relations of Milton and Davenant do honour to the generosity of two men who, sincerely opposed in politics, knew how to forget their personal anger in their common love of letters. In 1659 Davenant suffered a short imprisonment for complicity in Sir George Booth's revolt. Under Charles II. Davenant flourished in the dramatic world; he opened a new theatre in Lincoln's Inn Fields, which he called the Duke's; and he introduced a luxury and polish into the theatrical life which it had never before known in England. Under his management, the great actors of the Restoration, Betterton and his coevals, took their peculiar French style and appearance; and the ancient simplicity of the English stage was completely buried under the tinsel of decoration and splendid scenery. Davenant brought out six new plays in the Duke's Theatre, *The Rivals* (1668), an adaptation of *The Two Noble Kinsmen*, which Davenant never owned, *The Man's the Master* (1669), comedies translated from Scarron, *News from Plymouth*, *The Distresses*, *The Siege*, *The Fair Favourite*, tragi-comedies, all of which were printed after his death, and only one of which survived their author on the stage. He died at his house in Lincoln's Inn Fields on the night of the 7th of April 1668, and two days afterwards was buried in Poets' Corner, Westminster Abbey, with the inscription "O rare Sir William Davenant!" In 1672 his writings were collected in folio. His last work had been to travesty Shakespeare's *Tempest* in company with Dryden.

The personal character, adventures and fame of Davenant, and more especially his position as a leading reformer, or rather debaser, of the stage, have always given him a prominence in the history of literature which his writings hardly justify. His plays are utterly unreadable, and his poems are usually stilted and unnatural. With Cowley he marks the process of transition from the poetry of the imagination to the poetry of the intelligence; but he had far less genius than Cowley, and his influence on English drama must be condemned as wholly deplorable. (E. G.)

**DAVENPORT, EDWARD LOOMIS** (1816-1877), American actor, born in Boston, made his first appearance on the stage in Providence in support of Junius Brutus Booth. Afterwards he went to England, where he supported Mrs Anna Cora Mowatt (Ritchie) (1819-1870), Macready and others. In 1854 he was again in the United States, appearing in Shakespearian plays and in dramatizations of Dickens's novels. As Bill Sykes he was

especially successful, and his Sir Giles Overreach and Brutus were also greatly admired. He died at Canton, Pennsylvania, on the 1st of September 1877. In 1849 he had married Fanny Vining (Mrs Charles Gill) (d. 1891), an English actress also in Mrs Mowatt's company. Their daughter FANNY (LILY GIPSY) DAVENPORT (1850-1898) appeared in America at the age of twelve as the king of Spain in *Faint Heart Never Won Fair Lady*. Later (1869) she was a member of Daly's company; and afterwards, with a company of her own, acted with especial success in Sardou's *Fédora* (1883), *Cleopatra* (1890), and similar plays. Her last appearance was on the 25th of March 1898, shortly before her death.

**DAVENPORT, ROBERT** (fl. 1623-1639), English dramatist, is mentioned as the author of a play licensed in 1624 under the title of *Henry I*. In 1653 *Henry I. and Henry II.* was entered at Stationers' Hall by Humphrey Moseley with a second part said to be the work of Davenport and Shakespeare. Of this play or plays nothing has been discovered, but *King John and Matilda* (printed 1655), which probably dates from about the same time, has survived. Throughout the play, as in its closing scene quoted by Charles Lamb in his *Dramatic Specimens*, there is much "passion and poetry" which saves the piece from being classed as pure melodrama. *The City-Night-Cap* was licensed in 1624, but not printed until 1661. The underplot of this unsavoury play was borrowed from Cervantes and Boccaccio, and Mrs Aphra Behn's *Amorous Prince* (1671) is an adaptation from it. *A New Tricke to Cheat the Devil* (printed 1639) is a farcical comedy, which contains among other things the idea of the popular supper story which reappears in Hans Andersen's *Little Claus and Big Claus*. As told by Davenport the story closely resembles the *Scottish Freires of Berwick*, which was printed in 1603. Three other plays entered in the Stationers' Register as Davenport's are lost, and he collaborated in two plays with Thomas Drue.

Davenport's plays were reprinted by A. H. Bullen in *Old English Plays* (new series, 1890). The volume includes two didactic poems, which first saw the light in 1623.

**DAVENPORT**, a city and the county seat of Scott county, Iowa, U.S.A., on the Mississippi river, opposite Rock Island, Illinois, with which it is connected by two fine bridges and by a ferry. It is the third largest city in the state. Pop. (1890) 26,872; (1900) 35,254, including 8479 foreign-born (6111 German), and 19,230 of foreign parentage (13,294 German); (1905, state census) 39,797; (1910) 43,028. Davenport is served by the Chicago, Burlington & Quincy, the Chicago, Milwaukee & St Paul, the Chicago, Rock Island & Pacific, the Iowa & Illinois (interurban), and the Davenport, Rock Island & North Western railways; opposite the city is the western terminus of the Illinois and Mississippi, or Hennepin, Canal (which connects the Mississippi and Illinois rivers). Davenport lies on the slope of a bluff affording extensive views of landscape and river scenery. In the city are an excellent public library, an Academy of Sciences, several turn-halls and other German social organizations, the Iowa soldiers' orphans' home, Brown business college, and several minor Roman Catholic institutions. Davenport is an episcopal see of the Roman Catholic and the Protestant Episcopal churches. The city has a large commerce, and trade by water and rail in coal and grain, which are produced in the vicinity, is of special importance. With Rock Island and Moline it forms one great commercial unit. Among Davenport's manufactures are the products of foundries and machine shops, and of flouring, grist and planing mills; glucose syrup and products; locomotives, steel cars and car parts, washing machines, waggons, carriages, agricultural implements, buttons, macaroni, crackers and brooms. The value of the total factory product for 1905 was \$13,695,978, an increase of 38.7% over that of 1900. Davenport was founded in 1835, under the leadership of Colonel George Davenport; it was incorporated as a town in 1838, and was chartered as a city in 1851.

**DAVENTRY**, a market town and municipal borough in the Southern parliamentary division of Northamptonshire, England, 74 m. N.W. from London by the London & North Western

railway. Pop. (1901) 3780. It is picturesquely situated on a sloping site in a rich undulating country. On the adjacent Borough Hill are extensive earthworks, and the discovery of remains here and at Burnt Walls, immediately south, proves the existence of a considerable Roman station. The chief industry of the town is the manufacture of boots and shoes. The borough is under a mayor, four aldermen and twelve councillors. Area, 3633 acres.

In spite of the Roman remains on Borough Hill, nothing is known of the town itself until the time of the Domesday Survey, when the manor consisting of eight hides belonged to the countess Judith, the Conqueror's niece. According to tradition, Daventry was created a borough by King John, but there is no extant charter before that of Elizabeth in 1576, by which the town was incorporated under the name of the bailiff, burgesses and commonalty of the borough of Daventry. The bailiff was to be chosen every year in the Moot Hall and to be assisted by fourteen principal burgesses and a recorder. James I. confirmed this charter in 1605-1606, and Charles II. in 1674-1675 granted a new charter. The "quo warranto" rolls show that a market every Wednesday and a fair on St Augustine's day were granted to Simon son of Walter by King John. The charter of 1576 confirms this market and fair to the burgesses, and grants them two new fairs each continuing for two days, on Tuesday after Easter and on the feast of St Matthew the Apostle. Wednesday is still the market day. The town was an important coaching centre, and there was a large local industry in the manufacture of whips. During the civil wars Daventry was the headquarters of Charles I. in the summer of 1645, immediately before the battle of Naseby, at which he was defeated. A Cluniac priory founded here shortly after the Conquest has left no remains.

**DAVEY OF FERNHURST, HORACE DAVEY, BARON** (1833-1907), English judge, son of Peter Davey, of Horton, Bucks, was born on the 30th of August 1833, and educated at Rugby and University College, Oxford. He took a double first-class in classics and mathematics, was senior mathematical scholar and Eldon law scholar, and was elected a fellow of his college. In 1861 he was called to the Bar at Lincoln's Inn, and read in the chambers of Mr (afterwards Vice-Chancellor) Wickens. Devoting himself to the Chancery side, he soon acquired a large practice, and in 1875 became a Q.C. In 1880 he was returned to parliament as a Liberal for Christchurch, Hants, but lost his seat in 1885. On Gladstone's return to power in 1886 he was appointed solicitor-general and was knighted, but had no seat in the House, being defeated at both Ipswich and Stockport in 1886; in 1888 he found a seat at Stockton-on-Tees, but was rejected by that constituency in 1892. As an equity lawyer Sir Horace Davey ranked among the finest intellects and the most subtle pleaders ever known at the English bar. He was standing counsel to the university of Oxford, and senior counsel to the Charity Commissioners, and was engaged in all the important Chancery suits of his time. Among the chief leading cases in which he took a prominent part were those of *The Mogul Steamship Company v. M'Gregor*, 1892, *Boswell v. Coaks*, 1884, *Erlanger v. New Sombbrero Company*, 1878, and the *Ooregum Gold Mines Company v. Roper*, 1892; he was counsel for the promoters in the trial of the bishop of Lincoln, and leading counsel in the Berkeley peerage case. In 1862 he married Miss Louisa Donkin, who, with two sons and four daughters, survived him. In 1893 he was raised to the bench as a lord justice of appeal, and in the next year was made a lord of appeal in ordinary and a life peer. He died in London on the 20th of February 1907. Lord Davey's great legal knowledge was displayed in his judgments no less than at the bar. In legislation he took no conspicuous part, but he was a keen promoter of the act passed in 1906 for the checking of gambling.

**DAVID** (a Hebrew name meaning probably *beloved*<sup>1</sup>), in the Bible, the son of Jesse, king of Judah and Israel, and founder of the royal Judaean dynasty at Jerusalem. The chronology of his period is uncertain: the usual date, 1055-1015 B.C., is probably

<sup>1</sup> See further the third edition of Schrader's *Keilinschr. u. das Alte Test.* pp. 225, 483.



thirty years to half a century too early. The books of Samuel (strictly, 1 Sam. xvi.—1 Kings ii.), which are our principal source for the history of David, show how deep an impression the personality of the king, his character, his genius and the romantic story of his early years had left on the mind of the nation. Of no hero of antiquity do we possess so life-like a portrait. Minute details and traits of character are portrayed with a vividness which bears all the marks of contemporary narrative. But the record is by no means all of one piece or of one date. This history, as we now have it, is extracted from various sources of unequal value, which are fitted together in a way which offers considerable difficulties to the critic. In the history of David's early adventures, for example, the narrative is not seldom disordered, and sometimes seems to repeat itself with puzzling variations of detail, which have led critics to the unanimous conclusion that the First Book of Samuel is drawn from at least two sources. It is indeed easy to understand that the romantic incidents of this period were much in the mouths of the people—to whom David was a popular hero—and in course of time were written down in various forms which were not combined into perfect harmony by later editors, who gave excerpts from several sources rather than a new and independent history. These excerpts, however, have been so pieced together, that it is often impossible to separate them with precision, and to distinguish accurately between earlier and later elements. It even appears from a study of the Greek text that some copies of the books of Samuel incorporated narratives which other copies did not acknowledge. For the literary problems of these books, see also SAMUEL (BOOKS).

The parallel history of David in 1 Chron. xi.—xxix. contains a great deal of additional matter, which can rarely be treated as of equal historical value with the preceding. Where it follows the chapters in Samuel it is important for textual and other critical problems, but it omits narratives in which it is not interested (David's youth, persecution by Saul, Absalom's revolt, &c.), and adds long passages (David's arrangements for the temple, &c.) which reflect the views of a much later age than David's. The lists of officers, &c., are fuller than those in Samuel, and here and there contain notices of value. A comparison of the two records, however, is especially important for its illustration of the later tendency to idealize the figure of David, and the historical critic has to bear in mind the possibility that this tendency had begun long before the Chronicler's time, and that it may be found in the relatively older records preserved in Samuel.

David's father, Jesse, was a citizen of Bethlehem in Judah, 5 m. south of Jerusalem; the polite deprecation in 1 Sam. xviii. 18 means little (cf. Saul in ix. 21). Tradition made him a descendant of the ancient nobles of Judah through Boaz and the Moabitess Ruth, but the tendency to furnish a noble ancestry for a noble figure—especially one of obscure birth—is widespread (cf. GENEALOGY). He was the youngest of eight sons,<sup>1</sup> and spent his youth in an occupation which the Hebrews as well as the Arabs seem to have held in low esteem. He kept his father's sheep in the desert steppes of Judah, and there developed the strength, agility, endurance and courage which distinguished him throughout life (cf. 1 Sam. xvii. 34, xxiv. 2; 2 Sam. xvii. 9). There, too, he acquired that skill in music which led to his first introduction to Saul (1 Sam. xvi. 14-23, and the apocryphal Psalm of David, Ps. cli. in the Septuagint). He found favour in the king's eye, and became his armour-bearer.<sup>2</sup> But traditions varied. In 1 Sam. xvii. he does not follow his master to the field against the Philistines; he is an obscure untried shepherd lad sent by his father with supplies for his brothers in the Israelite camp. He does not even present himself before the king, and his brothers treat him with a petulance hardly conceivable if he stood well at court, and it

*Introduction to Saul.*

appears from the close that neither Saul nor his captain Abner had heard of him before (vv. 55-58). There is, indeed, a flat contradiction between the two accounts, but a family of Greek MSS. represented by the Vatican text omit xvii. 12-31, xvii. 55-xviii. 5, and thus the difficulty is greatly lessened. Characteristic of the omitted portions are the friendship which sprang up between Jonathan and David and the latter's appointment to a command in the army. A further difficulty is caused by 2 Sam. xxi. 19, which makes Elhanan the slayer of Goliath. David's exploit is not referred to in 1 Sam. xxi. 10-15, xxix., and on this and other grounds the simpler tradition in 2 Sam. is usually preferred. (See GOLIATH.) But it must have been by some valiant deed that Saul was led to notice him (cf. xiv. 52), and David soon became both a popular hero and an object of jealousy to Saul. According to the Hebrew text of 1 Sam. xviii., Saul's jealousy leaped at once to the conclusion that David's ambition would not stop short of the kingship. Such a suspicion would be intelligible if we could suppose that the king had heard something of the significant act of Samuel, which now stands at the head of the history of David in witness of that divine election and union with the spirit of Yahweh on which his whole career hung (xvi. 1-13). But this passage is the sequel to the rejection of Saul in xv., and Samuel's position agrees with that of the late writer in vii., viii. and xii.<sup>3</sup>

The shorter text, represented by the Septuagint, gives an account of Saul's jealousy which is psychologically more intelligible.<sup>4</sup> According to this text Saul was simply possessed with such a personal dislike and dread of David as might easily occupy his disordered brain. To be quit of his hateful presence he gave him a military command. In this charge David increased his reputation as a soldier and became a general favourite. Saul's daughter Michal loved him; and her father, whose jealousy continued to increase, resolved to put the young captain on a perilous enterprise, promising him the hand of Michal as a reward of success, but secretly hoping that he would perish in the attempt. David's good fortune did not desert him; he won his wife, and in this new advancement continued to grow in the popular favour, and to gain fresh laurels in the field. At this point it is necessary to look back on the proposed marriage of David with Saul's eldest daughter Merab (xviii. 17-19; cf. xvii. 25). When the time came for Saul to fulfil his promise, Merab was given to Adriel of Abel-Meholah (perhaps an Aramaean). What is said of this affair interrupts the original context of chap. xviii., to which the insertion has been clumsily fitted by an interpolation in the second half of ver. 21 (LXX omits). We have here, therefore, a notice drawn from a distinct source which connects itself with the other omitted passage, xvii. 12-31, where Saul had promised his daughter to the one who should overthrow Goliath (ver. 25). Since Merab and Michal are confounded in 2 Sam. xxi. 8, the whole episode of Merab and David perhaps rests on a similar confusion of names.

*Conflicts with Saul.*

As the king's son-in-law, David was necessarily again at court. He became chief of the bodyguard, as Ewald rightly interprets 1 Sam. xxii. 14, and ranked next to Abner (xx. 25), so that Saul's insane fears were constantly exasperated by personal contact with him. On at least one occasion the king's frenzy broke out in an attempt to murder David with his own hand.<sup>5</sup> At another time Saul actually gave commands to assassinate his son-in-law, but the breach was made up by Jonathan, whose chivalrous spirit had united him to David in a covenant of closest friendship (xix. 1-7). The circumstances of the final outburst of Saul's hatred, which drove David into exile, are not easily disentangled.

<sup>1</sup> See SAMUEL. The older history repeatedly indicates that David's kingship was predicted by a divine oracle, but would hardly lead us to place the prediction so early (1 Sam. xxv. 30; 2 Sam. iii. 9, v. 2).

<sup>2</sup> The LXX omits xviii. 1-6 (to "Philistine"), the first and last clauses of 8, 10-11, the reason given for Saul's fear in 12, 17-19, the second half of 21. It also modifies 28, and omits the second half of 29 and the whole of 30.

<sup>3</sup> 1 Sam. xix. 9. The parallel narrative, xviii. 10 sqq., is wanting in the Greek, and in the light of subsequent events is improbable. Its aim is to paint Saul's character as black as possible.

<sup>1</sup> But four in xvii. 13 sqq., and seven in 1 Chron. ii. 13-15.

<sup>2</sup> An armour-bearer was not a full warrior but a sort of page or apprentice-in-arms, whose most warlike function is to kill outright those whom his master has struck down—an office which among the Arabs was often performed by women.

The narrative of 1 Sam. xx., which is the principal account of the matter, cannot originally have been preceded by xix. 11-24; in chap. xx. David appears to be still at court, and Jonathan is even unaware that he is in any danger, whereas the preceding verses represent him as already a fugitive. It may also be doubted whether the narrative of David's escape from his own house by the aid of his wife Michal (xix. 11-17) has any close connexion with ver. 10, and does not rather belong to a later period.<sup>1</sup> David's daring spirit might very well lead him to visit his wife even after his first flight. The danger of such an enterprise was diminished by the reluctance to violate the apartments of women and attack a sleeping foe, which appears also in Judges xvi. 2, and among the Arabs.<sup>2</sup>

According to chap. xx. David was still at court in his usual position when he became certain that the king was aiming at his life. He betook himself to Jonathan, who thought his suspicions groundless, but undertook to test them. A plan was arranged by which Jonathan should draw from the king an expression of his feelings, and a tremendous explosion revealed that Saul regarded David as the rival of his dynasty, and Jonathan as little better than a fellow-conspirator. After a final interview (xx. 40-42), which must be regarded as a later expansion, they parted and David fled. He sought the sanctuary at Nob, where he had been wont to consult the priestly oracle (xxii. 15), and here, concealing his disgrace by a fictitious story, he also obtained bread from the consecrated table and the sword of Goliath (chap. xxi. 1-9).<sup>3</sup> His hasty flight—without food and weapon—suggests that the narrative should follow upon xix. 17.

It was perhaps after this that David made a last attempt to find a place of refuge in the prophetic circle of Samuel at Ramah (xix. 18-24). The episode now stands in another connexion, where it is certainly out of place. It might, however, fit into the break that plainly exists in the history at xxi. 10 after the affair at Nob. Deprived of the protection of religion as well as of justice, David tried his fortune among the Philistines at Gath. Recognized and suspected as a redoubtable foe, he made his escape by feigning madness, which in the East has inviolable privileges (xxi. 11-16).<sup>4</sup> The passage anticipates chap. xxvii., and it is hardly probable that the slayer of Goliath or of any other Philistine giant fled to the Philistines with their dead hero's sword. He returned to the wilds of Judah, and was joined at Adullam<sup>5</sup> by his father's house and by a small band of outlaws, of which he became the head. Placing his parents under the charge of the king of Moab, he took up the life of a guerilla captain, cultivating friendly relations with the townships of Judah (xxx. 26), which were glad to have on their frontiers a protector so valiant as David, even at the expense of the blackmail which he levied in return. A clear conception of his life at this time, and of the respect which he inspired by the discipline in which he held his men, and of the generosity which tempered his fiery nature, is given in chap. xxv. His force gradually swelled, and he was joined by the prophet Gad (note his message xxii. 5) and by the priest Abiathar, the only survivor of a terrible massacre by which Saul took revenge for the favours which David had received at the sanctuary of Nob. He was even able to strike at the Philistines, and to rescue Kēilah (south of Adullam and to the east of Beit Jibrīn) from their attack

**Outlaw life.**

Here he was anointed king, the first ruler of the southern kingdom. If the chronological notice may be trusted, he was then thirty years of age, and he reigned there for seven and a half years (2 Sam. ii. 1-4a, 11, v. 4 sq.). The noble elegy on the death of Saul and Jonathan, quoted from the Book of Jashar (2 Sam. i.), is marked by the absence both of religious feeling and of allusions to his earlier experiences with Saul which David might have been expected to make. It was deemed only natural that he should sympathize deeply with the disasters of the northern kingdom. His vengeance on the Amalekite who slew Saul—the account is a doublet of 1 Sam. xxxi.—is consistent with his generous treatment of his late adversary in his outlaw life, and with this agrees his embassy of thanks to the men of Jabesh-Gilead for their chivalrous rescue of the bodies of the fallen heroes (2 Sam. ii. 4b-7). The embassy threw out a hint,—their lord was dead and David himself had been anointed king over Judah; but the relation between Jabesh-Gilead and Saul had been a close one, and it was not to be expected that its eyes would be turned upon the king of Judah when Saul's son was installed at the not distant Mahanaim.

<sup>1</sup> The close of ver. 10 in the Hebrew is corrupt, and the words " (and it came to pass) that night " seem to belong to the next verse (so the Greek). H. P. Smith suggests that the passage originally followed upon xviii. 27.

<sup>2</sup> Wellhausen cites a closely parallel case from Sprenger's *Leben Muhammad*, vol. ii. p. 543.

<sup>3</sup> On the meaning of this difficult passage, see the discussions by W. R. Smith, *Religion of the Semites* (?), p. 455 sqq., and Schwally *Semit. Kriegsalterthümer*, p. 60 sqq.

<sup>4</sup> Interesting parallels in Barhebraeus *Chron.*, ed. Brun and Kirsch, p. 222, and Ewald, *Hist. Israel*, iii. p. 84.

<sup>5</sup> The cave of Adullam has been traditionally placed (since the 12th century) at Khareitūn, two hours' journey south of Bethlehem. But the town of Adullam, which has not been identified with any certainty, lay in the low country of Judah (Josh. xv. 35). The "cave" is also spoken of as a "hold" or fortress, and this is everywhere the true reading. The name has been identified with 'Id-el-mā (or -miye) about 12 m. S.W. of Bethlehem.

(xxiii. 1-13). Forced to flee by the treachery of the very men whom he had succoured, he lived for a time in constant fear of being captured by Saul, and at length took refuge with Achish king of Gath and established himself in Ziklag. Popular tradition, as though unwilling to let David escape from Saul, told of that king's continual pursuit of the outlaw, of the attempt of the men of Ziph (S.E. of Hebron) to betray him, of David's magnanimity displayed on two occasions, and of Jonathan's visit to console his bosom friend (xxiv.-xxvi.).<sup>6</sup> The situation was one which lent itself to the imagination.

The site of Ziklag is unknown. It hardly lay near Gath (probably Tell es-Sāfi, 12 m. E. of Ashdod), but rather to the south of Judah (Josh. xix. 5). Here he occupied himself in chastening the Amalekites and other robber tribes who made raids on Judah and the Philistines without distinction (xxvii.). The details of the text are obscure, and seem to imply that David systematically attacked populations friendly to Achish whilst pretending that he had been making forays against Judah. If this were an attempt to steer a middle course his true actions could not have been kept secret long, and as it is implied that the Philistines subsequently acquiesced in David's sovereignty in Hebron, it is not easy to see what interest they had in embroiling him with the men of Judah. At length, in the second year, he was called to join his master in a great campaign against Saul. The Philistines for once directed their forces towards the plain of Jezreel (Esdraelon) in the north; and Saul, forsaken by Yahweh, already gave himself up for lost. David accompanied the army as a matter of course. But his presence was not observed until they reached their destination, when the jealousy of the Philistines overrode his protestations of fidelity and he was ordered to return. He reached Ziklag only to find the town pillaged by the Amalekites. Pursuing the foes, he inflicted upon them a signal chastisement and took a great booty, part of which he spent in politic gifts to the leading men of the towns in the south country.<sup>7</sup>

Meantime Saul had fallen in battle, and northern Israel was in a state of chaos. The Philistines took possession of the fertile lowlands of Jezreel and the Jordan, and the shattered forces of Israel were slowly rallied by Abner in the remote city of Mahanaim in Gilead, under the nominal sovereignty of Saul's son Ishbaal. David now took the first great step to the throne. He was no longer an outlaw with a band of wandering companions, but a petty chieftain, head of a small colony of men, allied with families of Caleb and Jezreel (in Judah), and on friendly footing with the sheikhs south of Hebron. In response to an oracle he was bidden to move northwards to Judah and successfully occupied it with Hebron as his capital. *King at Hebron.*

Here he was anointed king, the first ruler of the southern kingdom. If the chronological notice may be trusted, he was then thirty years of age, and he reigned there for seven and a half years (2 Sam. ii. 1-4a, 11, v. 4 sq.). The noble elegy on the death of Saul and Jonathan, quoted from the Book of Jashar (2 Sam. i.), is marked by the absence both of religious feeling and of allusions to his earlier experiences with Saul which David might have been expected to make. It was deemed only natural that he should sympathize deeply with the disasters of the northern kingdom. His vengeance on the Amalekite who slew Saul—the account is a doublet of 1 Sam. xxxi.—is consistent with his generous treatment of his late adversary in his outlaw life, and with this agrees his embassy of thanks to the men of Jabesh-Gilead for their chivalrous rescue of the bodies of the fallen heroes (2 Sam. ii. 4b-7). The embassy threw out a hint,—their lord was dead and David himself had been anointed king over Judah; but the relation between Jabesh-Gilead and Saul had been a close one, and it was not to be expected that its eyes would be turned upon the king of Judah when Saul's son was installed at the not distant Mahanaim.

<sup>6</sup> According to a late Rabbinical story, David, like Bruce of Scotland, was once saved by a spider which spun its web over the cave wherein he was concealed.

<sup>7</sup> The law of the distribution of booty after war enacted by David (xxx. 24 sqq.) is given as a Mosaic precedent in the post-exilic priestly legislation (Num. xxxi. 27). On the importance of this explicit statement, see W. R. Smith, *Old Test. in Jewish Church* (?), 386 sq.

The interest of the narratives is now directed away from the Philistines to the decaying fortunes of Saul's house. (See ABNER and SAUL.) Abner had taken Saul's son Ishbaal and his authority was gradually consolidated in the north. War broke out between the two parties at Gibeon a few miles north of Jerusalem. A sham contest was changed into a fatal fray by the treachery of Ishbaal's men; and in the battle which ensued Abner was not only defeated, but, by slaying Asahel, drew upon himself a blood-feud with Joab. The war continued. Ishbaal's party became weaker and weaker; and at length Abner quarrelled with his nominal master and offered the kingdom to David. The king seized the opportunity to demand the return of Michal, his wife. The passage (iii. 12-16) is not free from difficulties, but it is intelligible that David should desire to ally himself as closely as possible with Saul's family (cf. xii. 8). The base murder of Abner by Joab did not long defer the inevitable issue of events. Ishbaal lost hope, and after he had been foully assassinated by two of his own followers, all Israel sought David as king.

The biblical narrative is admittedly not so constructed as to enable us to describe in chronological order the thirty-three years of David's reign over all Israel. It is possible that some of the incidents ascribed to this period properly belong to an earlier part of his life, and that tradition has idealized the life of David the king even as it has not failed to colour the history of David the outlaw and king of Hebron.

In the preceding account the biblical narratives have been followed as closely as possible in the light of the critical results generally accepted. That they have been affected by the growth of popular tradition is patent from the traces of duplicate narratives, from the difficulty caused, for example, by the story of Goliath (*q.v.*), and from a closer study of the chapters. The later views of the history of this period are represented in the book of Chronicles, where immediately after Saul's death David is anointed at Hebron king over all Israel (1 Chron. xi.). It is quite in harmony with this that the same source speaks of the Israelites who joined David at Ziklag (1 Chron. xii. 1-22), and of the host which came to him at Hebron to turn over to him Saul's kingdom (xii. 23-40). This treatment of history can be at once corrected by the books of Samuel, but it is only from a deeper study of the internal evidence that these, too, appear to give expression to doubtful and conflicting views. It is questionable whether David could have become king over all Israel immediately after the death of Ishbaal. The chronological notices in ii. 10 sqq. allow an interval of no less than five and a half years, and nowhere do the events of these years appear to be recorded. But David's position in the south of Judah is clear. He is related by marriage with south Judaeans of Caleb, Jezreel, and probably Geshur. (See ABSALOM.) He was at the head of a small colony (1 Sam. xxvii. 3), and on friendly terms with the sheikhs south of Hebron (xxx. 26-31).<sup>1</sup> His step forward to Hebron is in every way intelligible and is the natural outcome of his policy. It is less easy to trace his previous moves. There are gaps in the narratives, and the further back we proceed the more serious do their difficulties become. These chapters bring him farther north, and they commence by depicting David as a man of Bethlehem, high in the court of Saul, the king's son-in-law, and a popular favourite with the people. But notwithstanding this, the relation is broken off, and years elapse before David gains hold upon the Hebrews of north Israel, the weakness of the union being proved by the ease with which it was subsequently broken after Solomon's death. Much of the life of Saul is obscure, and this too, it would seem, because tradition loved rather to speak of the founder of the ideal monarchy than of his less successful rival. (See SAUL.) It is not impossible that some traditions did not bring them together. If Jerusalem and its immediate neighbourhood were first conquered by David (2 Sam. v.), it is probable that Beeroth and Gibeon (2 Sam. iv. 2, xxi. 2), Shaalbim, Har-heres and Aijalon (Judg. i. 35), Gezer (*ib.* i. 29), Chephirah and Kirjath-jearim (Josh. ix. 17) had remained Canaanite. The evidence has obviously some bearing upon the history of Saul, as also upon the intercourse between Judah and Benjamin which David's early history implies. It has been conjectured, therefore, that David's original home lay in the south. Since the early historical narrative (1 Sam. xxv. 2) finds him in Maon, Winckler has suggested that he was a Calebite chief, while a criticism of the details relating to David's family has induced Marquart<sup>2</sup> to conjecture that he was born at Arad (Tell 'Arād)

<sup>1</sup> Bethel (ver. 27) is probably the Bethuel near Ziklag (1 Chron. iv. 30). David's friendly relations with the Philistines find a parallel in Isaac's covenant with Abimelech (*q.v.*). In Ps. xxxiv. the latter name actually appears in place of Achish.

<sup>2</sup> *Fundamente israel. u. jüd. Gesch.* (1896), pp. 23 sqq.; see also Winckler, *Gesch. Isr.* i. 24; *Keilinschr. u. d. Alte Test.* (4), p. 228 sqq.

about 17 m. S.E. of Hebron. Once indeed we find him in the wilderness of Paran (1 Sam. xxv. 1, LXX reads Maon), and a more southerly origin has been thought of (Winckler). This is involved with other views of the early history of the Israelites; see further below.

David owed his success to his troop of freebooters (1 Sam. xxii. 2), now an organized force, and absolutely attached to his person. The valour of these "mighty men" (*gibbōrim*) was topical. The names of the most honoured are preserved, and we have some interesting accounts of their exploits in the days of the giants (2 Sam. xxi., xxiii.). We hear of two great battles with the "Philistines" in the valley of Rephaim, near Jerusalem, at a time when David's base was Adullam (v. 17-25). In one conflict a giant thought to slay him, but he was saved by Abishai, the brother of Joab, and the men took an oath that David should no more go to battle lest he "quench the light of Israel." On another occasion, Elhanan of Bethlehem slew the giant Goliath of Gath, and David's own brother Shimei (or Shammah) overthrew a monster who could boast of twenty-four fingers and toes. In yet another incident the Philistines maintained a garrison in Bethlehem, and David expressed a wish for a drink from its well. The wish was gratified at the risk of the lives of three brave men, and he recognized the solemnity of the occasion by pouring out the water as an offering unto Yahweh.

From a later summary (viii. 1) it seems that the Philistines were at length vanquished, and the unknown Metheg-Ammah taken out of their hands.<sup>3</sup> Not until the district was cleared could Jerusalem be taken, and the capture of the almost impregnable Jebusite fortress furnished a centre for future action. Here, in the midst of a region which had been held by aliens, he fortified the "city of David" and garrisoned it with his men. Meanwhile the ark of Yahweh, the only sanctuary of national significance, had remained in obscurity since its return from the Philistines in the early youth of Samuel. (See ARK.) David brought it up from Baalah of Judah with great pomp, and pitched a tent for it in Zion, amidst national rejoicings. The narrative (2 Sam. vi.) represents the act as that of a loyal and God-fearing heart which knew that the true principle of Israel's unity and strength lay in national adherence to Yahweh; but the event was far from having the significance which later times ascribed to it (1 Chron. xiii., xv. sqq.); even Solomon visited the sanctuary at Gibeon, and Absalom vowed his vow unto Yahweh at Hebron. It was not unnatural that the king who had his palace built by Tyrian artists should have proposed to erect a permanent temple to Yahweh. Such, at least, was the thought of later writers, who have given effect to the belief in chap. viii. It was said that the prophet Nathan commanded the execution of this plan to be delayed for a generation; but David received at the same time a prophetic assurance that his house and kingdom should be established for ever before Yahweh.

What remains to be said of his internal policy may be briefly detailed. In civil matters the king looked heedfully to the execution of justice (viii. 15), and was always accessible to the people (xiv. 4). But he does not appear to have made any change in the old local administration of justice, or to have appointed a central tribunal (xv. 2, where, however, Absalom's complaint that the king was inaccessible is merely factious). A few great officers of state were appointed at the court of Jerusalem (viii. 16-18, xx. 23-26), which was not without a splendour hitherto unknown in Israel. Royal pensioners, of whom Jonathan's son Mephibosheth was one, were gathered round a princely table. The art of music was not neglected (xix. 35). A more dangerous piece of magnificence was the harem. Another innovation was the census; it was undertaken despite the protests of Joab, and was checked by the rebukes of the prophet Gad and the visitation of a pestilence (xxiv.). Striking, too, is the conception of the national God who incites the king to do an act for which he was to be punished.<sup>4</sup> To us, the proposal to number the people seems innocent and

<sup>3</sup> 1 Chron. xviii. 1 reads "Gath and her dependent villages"; the original reading is a matter for conjecture.

<sup>4</sup> Cf. the idea in 1 Kings xxii. 19-23; Ezek. xiv. 9; contrast 1 Chron. xxi. 1.

Capture  
of Jeru-  
salem.

Internal  
policy.

laudable, and the latest sources of the Pentateuch contain several such lists. This new procedure, we may imagine, was resented by the northern Hebrews as an encroachment upon their liberties. We learn that the destroying angel was stayed at the threshing-floor of Araunah the Jebusite,<sup>1</sup> and the spot thus sanctified was made a sanctuary, and commemorated by an altar. It was the very place upon which Solomon's temple was supposed to be founded. The census-taking may have been a preliminary to the great wars, but the latter, on the other hand, are obviously presupposed by the extent of his kingdom. For his wars a larger force than his early bodyguard was required, and the Chronicler gives an account of the way in which an army of nearly 300,000 was raised and held by David's thirty heroes (1 Chron. xxvii.). It is certain at all events that no small body of soldiers would be needed, and this alone would imply that all Israel was by this time under his entire control.

Apart from the Ammonite war, our sources are confined to a mere summary (viii.), which includes even the Amalekites

(viii. 12, cf. 1 Sam. xxx.). After the defeat of the Philistines came the turn of Moab. It was under the care of the king of Moab that David placed his parents when he fled from Saul (1 Sam. xxii. 3 sqq.), and what led to the war is unknown. The severity with which the land was treated may pass for a gentle reprisal if the Moabites of that day were not more humane than their descendants in the days of King Mesha.<sup>2</sup> A deadly conflict with the Ammonites was provoked by a gross insult to friendly ambassadors of Israel;<sup>3</sup> and this war, of which we have pretty full details in 2 Sam. x. 1-11, xii. 26-31, assumed unexpected dimensions when the Ammonites procured the aid of their Aramean neighbours. The defeat of Hadadezer brought about the submission of other lesser kings. The glory of this victory was increased by the complete subjugation of Edom in a war conducted by Joab with characteristic severity (2 Sam. viii. 13; 1 Kings xi. 15-17; Ps. lx., title). The fall of Rabbah concludes David's war-like exploits; he carried off the jewelled crown of their god (Milcom), and subjected the people, not to torture (1 Chron. xx. 3), but to severe menial labour (xii. 26-31).

The Aramean states, Beth-rehob, Maacah, Tob, &c., lay partly to the north of Gilead and partly in the region which was the scene of the fight with Jabin (Josh. xi. 1-9, Judg. iv.; see DEBORAH). Apparently it was here, too, that the Danites found a settlement (Judg. xviii. 28); the migration has perhaps been ante-dated. (See DAN, *tribe*.) The account of David's wars is remarkable for the inclusion of the Syrians of Damascus and beyond the Euphrates; some exaggeration has been suspected (cf. 2 Sam. viii. 5 with x. 16). Some misunderstanding has been caused by the confusion of Edom (עֲדוּמָא) and Aram (אַרָמָא) in viii. 13. A more moderate idea of David's power has been found in Ps. lx. 6-12, or, preferably, in the description of the boundaries (2 Sam. xxiv. 5 sqq.). To the east of the Jordan he held rule from Aroer to Gad and Gilead; on its west his power extended from Beersheba in the south to Dan and Ijon at the foot of Hermon. Moab, Ammon and Edom would appear to have been merely tributary, whilst in the north among his allies David could number the king of Hamath. To the north-west Israel bordered upon Tyre, with whom its relations were friendly. The king of Tyre, who recognized David's newly won position (v. 11 seq.), is called Hiram; possibly—unless the notice is an anticipation of 1 Kings v.—his father Abibaal is meant.<sup>4</sup>

As the birth of Solomon is placed before the capture of Rabbah of Ammon (xii.), it would appear that David's wars were ended within the first half of his reign at Jerusalem, and the tributary nations thus do not seem to have attempted any revolt during his lifetime (see 1 Kings xi. 14 sqq. and 25). It was only when the nation was no longer knit

<sup>1</sup> This un-Hebraic name, which is not unlike *arōm*, "ark," should possibly be corrected to Adonijah (Cheyne, *Ency. Bib.* s.v.).

<sup>2</sup> David destroyed two-thirds of the Moabites—presumably of their fighting men (2 Sam. viii. 2); Mesha destroys the inhabitants of the captured cities in honour of his god Chemosh.

<sup>3</sup> It finds a parallel in the fate of the heralds of Orchomenus (Frazer, *Pausan.* v. 135) and in an Arabian story (Ibn Athir, viii. 360; Nöldeke in Budde, *Hand-Commentar*, ad loc.); cf. also Ewald, iii. 152.

<sup>4</sup> On the questions raised see the commentaries upon 2 Sam. viii. and x. and the *Ency. Biblica*, s.v. "David," "Merom," "Zobah." The main problem is whether the account of David's rule has been exaggerated, or whether the attempt has been made to throw back to the time of the first king of all Israel later political conditions.

together by the fear of danger from without that the internal difficulties of the new kingdom became more manifest. Such at least is the impression which the narratives convey.<sup>5</sup> So, after David had completed a series of conquests which made Palestine the greatest of the petty states of the age, troubles arose with the Israelites, who in times past had sought for him to be king (iii. 17, v. 1-3), with his old subjects the men of Judah, and with the members of his own household. The northern tribes, who appear to have submitted willingly to his rule, were not all of one mind. There were men of stronger build than the weak Ishbaal and the crippled son of Jonathan, the survivors of Saul's house, and it is only to be expected that David's first care must have been to cement the union of the north and south. The choice of Jerusalem, standing on neutral ground, may be regarded as a stroke of genius, and there is nothing to show that the king exercised that rigour which was to be the cause of his grandson's undoing. (See REHOBOAM.) On the other hand, when Sheba, probably one of Saul's clan, headed a rising and was promptly pursued by Joab to Abel-beth-maacah on the west of Dan, honour was satisfied by the death of the rebel, and no further steps were taken (xx.).<sup>6</sup> This policy of leniency towards Israel is characteristic of David, and may well have become a popular theme in the tales of succeeding generations. This same magnanimity towards the survivors of Saul's house has left its mark upon many of the narratives, and helps to a truer understanding of the stories of his early life. Thus it was quite in keeping with the romantic attachment between David and Saul's son Jonathan that when he became king of Israel he took Jonathan's son Meribbaal under his care (ix.).<sup>7</sup> The deed was not merely generous, it was politic to have Saul's grandson under his eyes. The hope of restoring the lost kingdom had not died out (cf. xvi. 3). But from another source we gain quite a different idea of the relations. A disastrous famine ravaged the land for three long years, and when Yahweh was consulted the reply came that there was "blood upon Saul and upon his house because he put the Gibeonites to death." The unavenged blood was the cause of divine anger, and retribution must be made. This David recognized, and, summoning the injured clan, inquired what expiation could be made. Bloodshed could only be atoned by blood-money or by shedding the blood of the offender or of his family. The Gibeonites demanded the latter, and five sons of Merab (the text by a mistake reads Michal) and two sons of Saul's concubine were sacrificed. The awful deed took place at the beginning of harvest (April-May), and the bodies remained suspended until, with the advent of the autumn rains, Yahweh was once more reconciled to his land (xxi. 1-14). The incident is a valuable picture of crude ideas of Yahweh, and, if nothing else were needed, it was sufficient to involve David in a feud with the Benjamites.<sup>8</sup> Here, too, we learn of the tardy burial of the bones of Saul and Jonathan which had remained in Jabesh-Gilead since the battle of Gilboa;—the history of David's dealings with the family of Saul has been obscured. That he took over his harem is only in accordance with the Eastern policy (cf. xii. 8).

The harem, an indispensable part of Eastern state, was responsible for many fatal disorders, although it is clear from 2 Sam. xvi. 21 that the nation at large was not very sensitive to the enormities which flow from this system. David's deep fall in the matter of Bathsheba (xi.) was too great an iniquity to be passed over lightly, and the base murder of her

<sup>5</sup> Viz. the present position of 2 Sam. ix.-xx. after the miscellaneous collection of details in v.-viii. See, on the other hand, the view of 1 Kings v. 3, 4.

<sup>6</sup> The present position of this incident, immediately after Absalom's rebellion was quelled, is almost inconceivable (Winckler, H. P. Smith, B. Luther, Ed. Meyer). See next page.

<sup>7</sup> He was five years of age at the battle of Gilboa (iv. 4), and is now grown up and with a young child (ix. 12). But the narrative loses its point unless David's kindness "for Jonathan's sake" comes at an early date soon after he became king, and although the youth is found at Lo-debar (east of the Jordan) under the protection of Machir, the independent fragment in ii. 8 sqq. implies that the Israelites had recovered the position they had lost at the battle of Gilboa.

<sup>8</sup> There is an unmistakable reference to the occurrence in the episode of Shimei, who hovers in the background of Absalom's revolt with a large body of men at his command (xvi. 7 sqq.).

husband Uriah the Hittite could not go unavenged. Bathsheba's influence added a new element of danger to the usual jealousies of the harem, and two of David's sons perished in vain attempts to claim the throne, which she appears to have viewed as the rightful inheritance of her own child. This, at least, is certain in the revolt of Adonijah (see SOLOMON), and it was probably believed that the action of the impulsive Absalom arose from the suspicion that the birth of Solomon was the death-blow to his succession.

As a piece of writing the vivid narratives are without an equal. David's sons were estranged from one another, and acquired all the vices of Oriental princes. The severe impartiality of the sacred historian has concealed no feature in this dark picture,—the brutal passion of Amnon, the shameless counsel of the wily Jonadab, the "black scowl" that rested on the face of Absalom through two long years of meditated revenge, the panic of the court when the blow was struck and Amnon was assassinated in the midst of his brethren. Not until five years had elapsed was Absalom fully reconciled with his father. Then he meditated revolt. As heir-apparent he collected a bodyguard, and studiously courting personal popularity by a pretended interest in the administration of kingly justice, ingratiated himself with the mass. Four years later (so read in xv. 7) he ventured to raise the standard of revolt in Hebron, with the malcontent Judaeans as his first supporters, and the crafty Ahithophel as his chief adviser. Arrangements had been made for the simultaneous proclamation of Absalom in all parts of the land. The surprise was complete, and David was compelled to evacuate Jerusalem, where he might have been crushed before he had time to rally his faithful subjects. He was warmly received by the Gileadites, and the first battle destroyed the party of Absalom, who was himself captured and slain by Joab. Then all the people repented except the men of Judah, who were not to be conciliated without a virtual admission of prerogative of kinship to the king. This concession involved important consequences. The precedence claimed by Judah was challenged by the northern tribes even on the day of David's victorious return to his capital, and a rupture ensued, headed by Sheba, which but for the energy of Joab might have led to a second and more dangerous rebellion.

Several indications suggest that the revolt was one in which the men of Judah originally took the leading if not the only part. The unruly clans which David knew how to control when he was at Ziklag or Hebron were doubtless ready to support the rebellious son. The removal of the court to Jerusalem provided a suitable opportunity, and an element of jealousy even may not have been wanting. If Geshur be the district in Josh. xiii. 2, 1 Sam. xxvii. 8, it is significant that the scene of Absalom's exile lay to the south, that Ahithophel was a south Judaeans, and that Amasa probably belonged to the Jezreel<sup>2</sup> with which David was connected through his wife Ahinoam. The eleven years which elapsed between the murder of Amnon and the revolt would seem to disprove any connexion between the two; the chronology may rest upon the tradition that Solomon was twelve years old when he came to the throne. David's hurried flight, attended only by his bodyguard, indicates that his position was not a very strong one, and it is difficult to connect this with the fact that he had already waged the wars mentioned in 2 Sam. viii. and x. If his reason for taking refuge in Ishbaal's capital Mahanaim is not obvious, it is even more remarkable that he should have been received kindly by the Ammonites whom he had previously decimated. On the theory that the revolt of Absalom chronologically should precede the great wars, a slight correction of the already corrupt text in xvii. 27 makes Nahash himself David's ally, and accounts for David's eagerness to repay to Hanun, the son of Nahash, the kindness which he had received from the father (x. 2). That the revolt of Sheba is in an impossible position is obvious. Tradition has probably confused Benjamite risings with Absalom's misguided enterprise; the parts played by Shimei and Meribbaal, at all events, are extremely suggestive. See ABSALOM, AHITHOPHEL.

The Appendix ascribes to David a song of triumph and some exceedingly obscure "last words" (xxii.—xxiii. 7) which cannot be used as historical material. The history of his life is immediately continued in 1 Kings i., where his old age and weakness are for the first time vividly emphasized. The events of the remaining years after 2 Sam. xx. are left untold, but the Chronicler omits the revolt of Absalom and

<sup>1</sup> If Ewald's brilliant interpretation of an obscure word in 2 Sam. xiii. 32 be correct.

<sup>2</sup> "Israelite" (2 Sam. xvii. 25) is a very unnecessary designation; 1 Chron. ii. 17 would make him an Ishmaelite.

represents the king as busily occupied with schemes concerning the future temple. The last spark of his old energy was called forth to secure the succession of Solomon against the ambition of Adonijah. It is noteworthy that, as in the case of Absalom, the pretender, though supported by Joab and Abiathar, found his chief stay among the men of Judah (1 Kings i. 9). (See SOLOMON.)

To estimate the work of David it is necessary to take into account the situation before and after his period. According to the prevailing traditions, Saul at his death had left North Israel disunited and humiliated. From this condition David raised the land to the highest state of prosperity and glory, and by his conquests made the united kingdom the most powerful state of the age. To do this other qualities than mere military capacity were required. David was not only a great captain, he was a national hero in whom all the noblest elements of the Hebrew genius were combined. His talent enabled him to weld together the mixed southern clans which became incorporated under Judah, and to build up a monarchy which represented the highest conception of national life possible under the circumstances. The structure, it is true, was not permanent. Under his successor it began to decay, and in the next generation it fell asunder and lived only in the hearts of the people as the proudest memory of past history and the prophetic ideal of future glory.<sup>3</sup> Opinion will differ, however, as to the extent to which later ideals have influenced the narratives upon which the student of Hebrew history and religion is dependent, and how far the reigns of David and Solomon altered the face of Hebrew history. The foundation of the united monarchy was the greatest advance in the whole course of the history of the Israelites, and around it have been collected the hopes and fears which a varied experience of monarchical government aroused. Many of the narratives furnish a vivid picture of the life of David with a minuteness of personal detail which has suggested to some that their author was intimately acquainted with the events, and, if not a contemporary, belonged to the succeeding generation, while to others it has seemed more probable that these reflect rather "the plastic mould of popular tradition." It cannot be doubted that the three types of David, represented by the books of Samuel, of Chronicles, and the superscriptions of the Psalms, are irreconcilable, and that they represent successive developments of the original traditions. That the oldest of these three does not contain earlier attempts to idealize him is unlikely. "Political circumstances naturally led to an ever-increasing appreciation of his person and his work as the unifier of Israel. In the eyes of posterity he became more and more completely the model of an Israelitish king and the natural consequence was that he was idealized. The hope of the regeneration of his dynasty, and, at a later period, of its restoration to the throne—the Messianic expectation—must have worked powerfully in the same direction. And meanwhile the religious convictions of the highest minds in Israel were undergoing a marked change. The conceptions of Yahweh and of the religion which was acceptable to him were constantly being elevated and purified. This could not but have an influence on the current ideas concerning David. He, too, must be remodelled as the conceptions of God were changed."<sup>4</sup> But what is lost as regards historical material is a distinct gain to the study of the development of Hebrew thought and philosophy of history.

David's character must be judged partly in the light of the times in which he lived and partly in connexion with the great truths which he represents, truths whose value is not impaired should they prove to be the convictions of later ages. Accordingly, David is not to be condemned for failing to subdue the sensuality which is the chief stain on his character, but should rather be judged by his habitual recognition of a generous standard of conduct, by the undoubted purity and lofty justice of an administration which was never stained by selfish considerations or motives of personal rancour,<sup>5</sup> and finally by the calm

<sup>3</sup> See HEBREW RELIGION, MESSIAH, PROPHECY.

<sup>4</sup> Kuonen, "The Critical Method," *Modern Review*, 1880, p. 701 (*Gesammelte Abhandlungen*, Germ. ed. by Budde, p. 33).

<sup>5</sup> His charges to Solomon in 1 Kings ii. 5-9 do not arise necessarily from motives of revenge; a young and untried sovereign could not



courage which enabled him to hold an even and noble course in the face of dangers and treachery. His great sin in the matter of Uriah would have been forgotten but for his repentance: the things at which modern ideas are most offended are not always those that would have given umbrage to early writers. That he did not reform at a stroke all ancient abuses appears particularly in relation to the practice of blood revenge; to put an end to this deep-rooted custom would have been an impossibility. But it is clear from 2 Sam. iii. 28 sqq., xiv. 1-10, that his sympathies were against the barbarous usage. Nor is it just to accuse him of cruelty in his treatment of enemies. As it was impossible to establish a military cordon along the borders of Canaan, it was necessary absolutely to cripple the adjoining tribes. From the lust of conquest for its own sake David appears to have been wholly free.

The generous elevation of David's character is seen most clearly in those parts of his life where an inferior nature would have been most at fault,—in his conduct towards Saul, in the blameless reputation of himself and his band of outlaws in the wilderness of Judah, in his repentance under the rebuke of Nathan and in his noble bearing on the revolt of Absalom. His touching love for his worthless son is one of the most beautiful descriptions of paternal affection. His unflinching insight into character, and his power of winning men's hearts and touching their better impulses, appear in innumerable traits (e.g. 2 Sam. xiv. 18-20, iii. 31-37, xxiii. 15-17), and here, as elsewhere, the charm which the life of David has upon its readers is entirely unaffected by technical questions of literary and historical criticism.

To the later generations David was pre-eminently the Psalmist and the founder of the Temple service. The Hebrew titles ascribe to him seventy-three psalms; the Septuagint adds some fifteen more; and later opinion, both Jewish and Christian, claimed for him the authorship of the whole Psalter (so the Talmud, Augustine and others). That the tradition of the titles requires careful sifting is no longer doubted, and the results of recent criticism have been to confirm the view that "it is no longer possible to treat the psalms as a record of David's spiritual life through all the steps of his chequered career" (W. R. Smith, *Old Test. in Jew. Church*<sup>2</sup>, p. 224). Nor can it be maintained that the elaborate ritual ascribed to David by the chronicler has any historical value. See further CHRONICLES, PSALMS.

On the other hand, these traditions, however unhistorical in their present form, cannot be pure imagination. The male and female singers (if the reading be correct) whom Sennacherib carried off from Jerusalem in Hezekiah's time, may well have belonged to an old foundation (A. Jeremias, *Alte Test. im Lichte d. Allen Oriens*<sup>2</sup>, p. 527), and though David's skill referred to in Amos vi. 5 may be due to a gloss, it is a Judæan narrative which tells of the invention of music, ascribing it possibly to a Judæan legendary hero (Gen. iv. 21). And although the Levitical organization, as ascribed to David, is manifestly post-exilic, it is at least certain that many of the Levitical families were of southern origin. It is in David's history that the clans of the south first attained prominence, and some of them are known to have been staunch upholders of a purer worship of Yahweh, or to have been associated with the introduction of religious institutions among the Israelites. (See LEVITES.)

The difficulty of the historical problems increases when the narratives of David are more closely studied: (a) 2 Sam. iii. 18, xiv. 9 show that according to one view David delivered *Israel* (not Judah) from the Philistines. This is in contradiction to ii. 8 sqq. (from another source), where Saul's son recovers Israelite territory, but is supported by ix., where Mephibosheth is found at Lo-debar. This historical view has probably left its trace upon the present traditions of Saul, whose defeat by the "Philistines" (here found in the north and not as usual in the south) left Israel in much the same position as when he was anointed king (cf. 1 Sam. xxxi. 7 with xiii. 7). Again (b) the primitive stories of conflicts with "Philistine" giants between Hebron and Jerusalem (2 Sam. v. 17 sqq., xxi. 15 sqq. and xxiii.) find their analogy in Caleb's overthrow of the sons of Anak (Judg. i. 10; Josh. xv. 14), and in the allusion to the same prehistoric folk in the account of the spies (Num. xiii. 28). From a number of points of evidence there appears to have been a group of traditions of a movement from the south (probably Kadesh, Num. xiii. 26) associ-

afford to continue the clemency which his father was strong enough to extend to dangerous enemies. Apart from this, it is possible that the words have been written to shift from Solomon's shoulders the bloodshed incurred in establishing his throne.

ated with Caleb, David and the Levites. If the clans of Moses' kin which moved into Judah bore the ark (Num. x. 29 sqq.; see KENITES), and if Abiathar carried it before David (1 Kings ii. 26), there were traditions of the ark distinct from those which associate it with Joshua and Shiloh (cf. 2 Sam. vii. 6). But the stories of conflicts in a much larger area than the few cities in the immediate neighbourhood of Jerusalem (see above) can scarcely be read with the numerous narratives which recount or imply relations between the young David of Bethlehem and Saul or the Israelites. It is possible, therefore, that one early account of David was that of an entrance into the land of Judah, and that round him have gathered traditions partly individual and partly tribal or national. See further S. A. Cook, *Critical Notes on O.T. History*, pp. 122 sqq., and art. JEWS (*History*), §§ 6-8.

LITERATURE.—Robertson Smith's later views subsequent to 1877 (when he wrote the article on David for this *Encyclopaedia*) were expressed partly in the *Old Test. in Jewish Church* (1881 and 1892), *passim*, and partly in the article on the Books of Samuel in the *Ency. Brit.* (9th ed.); on David's character see especially his criticism of Renan, *Eng. Hist. Rev.*, 1888, pp. 134 sqq. Mention may be made of Stähelin's *Leben Davids* (Basel, 1866), still valuable for the numerous parallels adduced from oriental history; Cheyne's *Aids to Devout Study of Criticism* (1892), a criticism of David's history in its bearing upon religion; Marcel Dieulafoy, *David the King* (1902), full, but not critical; H. A. White, *Hastings Dict. art. "David"*; Cheyne, *Ency. Bib. art. "David"*; and (on the romantic element in the narratives) Luther in Ed. Meyer, *Israeliten und ihre Nachbarstämme* (1906), pp. 181 sqq. (W. R. S.; S. A. C.)

DAVID, ST (*Dewi, Sant*), the national and tutelar saint of Wales, whose annual festival, known as "St David's Day," falls on the 1st of March. Few historical facts are known regarding the saint's life and actions, and the dates both of his birth and death are purely conjectural, although there is reason to suppose he was born about the year 500 and died at a great age towards the close of the 6th century. According to his various biographers he was the son of Sandde, a prince of the line of Cunedda, his mother being Non, who ranks as a Cymric saint. He seems to have taken a prominent part in the celebrated synod of Llanddewi-Brefi (see CARDIGANSHIRE), and to have presided at the so-called "Synod of Victory," held some years later at Caerleon-on-Usk. At some date unknown, St David, as *pen-escoli* or primate of South Wales, moved the seat of ecclesiastical government from Caerleon to the remote headland of Mynyw, or Menevia, which has ever since, under the name of St David's (*Ty-Dewi*), remained the cathedral city of the western see. St David founded numerous churches throughout all parts of South Wales, of which fifty-three still recall his name, but apparently he never penetrated farther north than the region of Powys, although he seems to have visited Cornwall. With the passing of time the saint's fame increased, and his shrine at St David's became a notable place of pilgrimage, so that by the time of the Norman conquest his importance and sanctity were fully recognized, and at Henry I.'s request he was formally canonized by Pope Calixtus II. about 1120.

Of the many biographies of St David, the earliest known is that of Rhyddmarch, or Ricemarchus (c. 1090), one of the last British bishops of St David's, from whose work Giraldus Cambrensis (*g.v.*) chiefly compiled his extravagant life of the saint.

DAVID I. (1084-1153), king of Scotland, the youngest son of Malcolm Canmore and (Saint) Margaret, sister of Edgar Ætheling, was born in 1084. He married in 1113 Matilda, daughter and heiress of Waltheof, earl of Northumbria, and thus became possessed of the earldom of Huntingdon. On the death of Edgar, king of Scotland, in 1107, the territories of the Scottish crown were divided in accordance with the terms of his will between his two brothers, Alexander and David. Alexander, together with the crown, received Scotland north of the Forth and Clyde, David the southern district with the title of earl of Cumbria. The death of Alexander I. in 1124 gave David possession of the whole. In 1127, in the character of an English baron, he swore fealty to Matilda as heiress to her father Henry I., and when the usurper Stephen ousted her in 1135 David vindicated her cause in arms and invaded England. But Stephen marched north with a great army, whereupon David made peace. The peace, however, was not kept. After threatening an invasion in 1137, David marched into England in 1138, but sustained a crushing defeat on Cutton Moor in the engagement known as the battle of the Standard. He returned to Carlisle, and soon

afterwards concluded peace. In 1141 he joined Matilda in London and accompanied her to Winchester, but after a narrow escape from capture he returned to Scotland. Henceforth he remained in his own kingdom and devoted himself to its political and ecclesiastical reorganization. A devoted son of the church, he founded five bishoprics and many monasteries. In secular politics he energetically forwarded the process of feudalization which had been initiated by his immediate predecessors. He died at Carlisle on the 24th of May 1153.

**DAVID II.** (1324–1371), king of Scotland, son of King Robert the Bruce by his second wife, Elizabeth de Burgh (d. 1327), was born at Dunfermline on the 5th of March 1324. In accordance with the terms of the treaty of Northampton he was married in July 1328 to Joanna (d. 1362), daughter of the English king, Edward II., and became king of Scotland on his father's death in June 1329, being crowned at Scone in November 1331. Owing to the victory of Edward III. of England and his protégé, Edward Baliol, at Halidon Hill in July 1333, David and his queen were sent for safety into France, reaching Boulogne in May 1334, and being received very graciously by the French king, Philip VI. Little is known about the life of the Scottish king in France, except that Château Gaillard was given to him for a residence, and that he was present at the bloodless meeting of the English and French armies at Vironfosse in October 1339. Meanwhile his representatives had obtained the upper hand in Scotland, and David was thus enabled to return to his kingdom in June 1341, when he took the reins of government into his own hands. In 1346 he invaded England in the interests of France, but was defeated and taken prisoner at the battle of Neville's Cross in October of this year, and remained in England for eleven years, living principally in London and at Odiham in Hampshire. His imprisonment was not a rigorous one, and negotiations for his release were soon begun. Eventually, in October 1357, after several interruptions, a treaty was signed at Berwick by which the Scottish estates undertook to pay 100,000 marks as a ransom for their king. David, who had probably recognized Edward III. as his feudal superior, returned at once to Scotland; but owing to the poverty of the kingdom it was found impossible to raise the ransom. A few instalments were paid, but the king sought to get rid of the liability by offering to make Edward III., or one of his sons, his successor in Scotland. In 1364 the Scottish parliament indignantly rejected a proposal to make Lionel, duke of Clarence, the next king; but David treated secretly with Edward III. over this matter, after he had suppressed a rising of some of his unruly nobles. The king died in Edinburgh Castle on the 22nd of February 1371. His second wife was Margaret, widow of Sir John Logie, whom he divorced in 1369; but he left no children, and was succeeded by his nephew, Robert II. David was a weak and incapable ruler, without a spark of his father's patriotic spirit.

See Andrew of Wyntoun, *The orygyne cronykil of Scotland*, edited by D. Laing (Edinburgh, 1872–1879); John of Fordun, *Chronica gentis Scotorum*, edited by W. F. Skene (Edinburgh, 1871–1872); J. H. Burton, *History of Scotland*, vol. ii. (Edinburgh, 1905); and A. Lang, *History of Scotland*, vol. i. (Edinburgh, 1900).

**DAVID**, the name of three Welsh princes.

**DAVID I.** (d. 1203), a son of Prince Owen Gwynedd (d. 1169), came into prominence as a leader of the Welsh during the expedition of Henry II. in 1157. In 1170 he became lord of Gwynedd (*i.e.* the district around Snowdon), but some regarded him as a bastard, and Gwynedd was also claimed by other members of his family. After fighting with varying fortunes he sought an ally in the English king, whom he supported during the baronial rising in 1173; then after this event he married Henry's half-sister Emma. But his enemies increased in power, and about 1194 he was driven from Wales by the partisans of his half-brother Llewelyn ab Iorwerth. The chronicler Benedictus Abbas calls David *rex*, and Rhuddlan castle was probably the centre of his vague authority.

**DAVID II.** (c. 1208–1246) was a son of the great Welsh prince, Llewelyn ab Iorwerth, and through his mother Joanna was a grandson of King John. He married an English lady, Isabella

de Braose, and, having been recognized as his father's heir both by Henry III. and by the Welsh lords, he had to face the hostility of his half-brother Gruffydd, whom he seized and imprisoned in 1239. When Llewelyn died in April 1240, David, who had already taken some part in the duties of government, was acknowledged as a prince of North Wales, doing homage to Henry III. at Gloucester. However, he was soon at variance with the English king, who appears to have espoused the cause of the captive Gruffydd. Henry's Welsh campaign in 1241 was bloodless but decisive. Gruffydd was surrendered to him; David went to London and made a full submission, but two or three years later he was warring against some English barons on the borders. To check the English king he opened negotiations with Innocent IV., doubtless hoping that the pope would recognize Wales as an independent state, but here, as on the field of battle, Henry III. was too strong for him. Just after Henry's second campaign in Wales the prince died in March 1246.

**DAVID III.** (d. 1283) was a son of Gruffydd and thus a nephew of David II. His life was mainly spent in fighting against his brother, the reigning prince, Llewelyn ab Gruffydd. His first revolt took place in 1254 or 1255, and after a second about eight years later he took refuge in England, returning to Wales when Henry III. made peace with Llewelyn in 1267. Then about 1274 the same process was repeated. David attended Edward I. during the Welsh expedition of 1277, receiving from the English king lands in North Wales; but in 1282 he made peace with Llewelyn and suddenly attacked the English garrisons, a proceeding which led to Edward's final conquest of Wales. After Llewelyn's death in December 1282 David maintained the last struggle of the Welsh for independence. All his efforts, however, were vain; in June 1283 he was betrayed to Edward, was tried by a special court and sentenced to death, and was executed with great barbarity at Shrewsbury in October 1283. As the last native prince of Wales, David's praises have been sung by the Welsh bards, but his character was not attractive, and a Welsh historian says "his life was the bane of Wales."

**DAVID, FÉLICIE** (1810–1876), French composer, was born on the 13th of April 1810 at Cadenet, in the department of Vaucluse. As a child he showed unusual musical precocity, and being early left an orphan he was admitted into the choir of Saint Sauveur at Aix. He was for a time employed in an attorney's office, but quitted his service to become *chef d'orchestre* in the theatre at Aix, and chapel-master at Saint Sauveur. Then he went to Paris, being provided with £100 a year by a rich uncle. After having studied for a while at the Paris Conservatoire, he joined the sect of Saint Simonians, and in 1833 travelled in the East in order to preach the new doctrine. After three years' absence, during which Constantinople and Smyrna were visited and some time was spent in Egypt, he returned to France and published a collection of *Oriental Melodies*. For several years he worked in retirement, and wrote two symphonies, some chamber music and songs. On the 8th of December 1844 he suddenly leapt into fame through the extraordinary success obtained by his symphonic ode *Le Désert*, which was produced at the Conservatoire. In this work David had struck out a new line. He had attempted in simple strains to evoke the majestic stillness of the desert. Notwithstanding its title of "symphonic ode," *Le Désert* has little in common with the symphonic style. What distinguishes it is a certain naïveté of expression and an effective oriental colouring. In this last respect David may be looked upon as the precursor of a whole army of composers. His succeeding works, *Moïse au Sinai* (1846), *Christophe Colomb* (1847), *L'Éden* (1848), scarcely bore out the promise shown in *Le Désert*, although the second of these compositions was successful at the time of its production. David now turned his attention to the theatre, and produced the following operas in succession: *La Perle du Brésil* (1851), *Herculanum* (1859), *Lalla-Roukh* (1862), *Le Saphir* (1865). Of these, *Lalla-Roukh* is the one which has obtained the greatest success. In 1868 he gained the award of the French Institute for the biennial prize given by the emperor; and in 1869 he was made librarian at the Conservatoire instead of Berlioz, whom subsequently he succeeded as a member of the Institute. He died

at Saint-Germain-en-Laye on the 29th of August 1876. If David can scarcely be placed in the first rank of French composers, he nevertheless deserves the consideration due to a sincere artist, who was undoubtedly inspired by lofty ideals. At a time when the works of Berlioz were still unappreciated by the majority of people, David succeeded in making the public take interest in music of a picturesque and descriptive kind. Thus he may be considered as one of the pioneers of modern French musical art.

**DAVID, GERARD** [GHEERAERT DAVIT], (?-1523), Netherlands painter, born at Oudewater in Holland between 1450 and 1460, was the last great master of the Bruges school. He was only rescued from complete oblivion in 1860-1863 by Mr W. J. H. Weale, whose researches in the archives of Bruges brought to the light the main facts of the master's life. We have now documentary evidence that David came to Bruges in 1483, presumably from Haarlem, where he had formed his early style under the tuition of Ouwater; that he joined the gild of St Luke at Bruges in 1484 and became dean of the gild in 1501; that he married in 1496 Cornelia Cnoop, daughter of the dean of the Goldsmiths' gild; became one of the leading citizens of the town; died on the 13th of August 1523; and was buried in the Church of Our Lady at Bruges. In his early work he had followed the Haarlem tradition as represented by Dirck Bouts, Ouwater and Geertgen of Haarlem, but already gave evidence of his superior power as colourist. To this early period belong the "St John" of the Kaufmann collection in Berlin, and Mr Salting's "St Jerome." In Bruges he applied himself to the study and the copying of the masterpieces by the Van Eycks, Van der Weyden, and Van der Goes, and came under the direct influence of the master whom he followed most closely, Hans Memlinc. From him he acquired the soulful intensity of expression, the increased realism in the rendering of the human form and the orderly architectonic arrangement of the figures. Yet another master was to influence him later in life when, in 1515, he visited Antwerp and became impressed with the life and movement of Quentin Matsys, who had introduced a more intimate and more human conception of sacred themes. David's "Pietà" in the National Gallery, and the "Descent from the Cross," in the Cavallo collection, Paris (Guildhall, 1906), were painted under this influence and are remarkable for their dramatic movement. But the works on which David's fame will ever rest most securely are the great altar-pieces executed by him before his visit to Antwerp—the "Marriage of St Catherine," at the National Gallery; the triptych of the "Madonna Enthroned and Saints" of the Brignole-Sale collection in Genoa; the "Annunciation" of the Sigmaringen collection; and, above all, the "Madonna with Angels and Saints" which he painted gratuitously for the Carmelite Nuns of Sion at Bruges, and which is now in the Rouen museum. Only a few of his works have remained in Bruges—"The Judgment of Cambyses," "The Flaying of Sisamnes" and the "Baptism of Christ" in the Town museum, and the "Transfiguration" in the Church of Our Lady. The rest were scattered all over the world, and to this may be due the oblivion into which his very name had fallen—partly to this, and partly to the fact that with all the beauty and soulfulness of his work he had no new page to add to the history of the progressive development of art, and even in his best work only gave new variations of the tunes sung by his great precursors and contemporaries. That he is worthy to rank among the masters was only revealed to the world when a considerable number of his paintings were assembled at Bruges on the occasion of the exhibition of early Flemish masters in 1902. At the time of his death the glory of Bruges, and also of the Bruges school, was on the wane, and Antwerp had taken the leadership in art as in political and commercial importance. Of David's pupils in Bruges, only Isenbrandt, A. Cornelis and Ambrosius Benson achieved importance. Among other Flemish painters Joachim Patinir and Mabuse were to some degree influenced by him.

Eberhard Freiherr von Bodenhausen published in 1905 a very comprehensive monograph on *Gerard David and his School* (Munich, F. Bruckmann), together with a *catalogue raisonné* of his works, which, after careful sifting, are reduced to the number of forty-three. (P. G. K.)

**DAVID, JACQUES LOUIS** (1748-1825), French painter, was born in Paris on the 30th of April 1748. His father was killed in a duel, when the boy was but nine years old. His education was begun at the Collège des Quatre Nations, where he obtained a smattering of the classics; but, his artistic talent being already obvious, he was soon placed by his guardian in the studio of François Boucher. Boucher speedily realized that his own erotic style did not suit the lad's genius, and recommended him to J. M. Vien, the pioneer of the classical reaction in painting. Under him David studied for some years, and, after several attempts to win the *prix de Rome*, at last succeeded in 1775, with his "Loves of Antiochus and Stratonice." Vien, who had just been appointed director of the French Academy at Rome, carried the youth with him to that city. The classical reaction was now in full tide; Winckelmann was writing, Raphael Mengs painting; and the treasures of the Vatican galleries helped to confirm David in a taste already moulded by so many kindred influences. This severely classical spirit inspired his first important painting, "*Date obolum Belisario*," exhibited at Paris in 1780. The picture exactly suited the temper of the times, and was an immense success. It was followed by others, painted on the same principles, but with greater perfection of art: "The Grief of Andromache" (1783), "The Oath of the Horatii" (Salon, 1785), "The Death of Socrates," "Love of Paris and Helen" (1788), "Brutus" (1789). In the French drama an unimaginative imitation of ancient models had long prevailed; even in art Poussin and Le Sueur were successful by expressing a bias in the same direction; and in the first years of the revolutionary movement the fashion of imitating the ancients even in dress and manners went to the most extravagant length. At this very time David returned to Paris; he was now painter to the king, Louis XVI., who had been the purchaser of his principal works, and his popularity was soon immense. At the outbreak of the Revolution in 1789, David was carried away by the flood of enthusiasm that made all the intellect of France believe in a new era of equality and emancipation from all the ills of life.

The success of his sketch for the picture of the "Oath of the Tennis Court," and his pronounced republicanism, secured David's election to the Convention in September 1792, by the *Section du Muséum*, and he quickly distinguished himself by the defence of two French artists in Rome who had fallen into the merciless hands of the Inquisition. As, in this matter, the behaviour of the authorities of the French Academy in Rome had been dictated by the tradition of subservience to authority, he used his influence to get it suppressed. In the January following his election into the Convention his vote was given for the king's death. Thus the man who was so greatly indebted to the Roman academy and to Louis XVI. assisted in the destruction of both, no doubt in obedience to a principle, like the act of Brutus in condemning his sons—a subject he painted with all his powers. Cato and stoicism were the order of the day. Hitherto the actor had walked the stage in modern dress. Brutus had been applauded in red-heeled shoes and *culottes jarretées*; but Talma, advised by David, appeared in toga and sandals before an enthusiastic audience. At this period of his life Mademoiselle de Noailles persuaded him to paint a sacred subject, with Christ as the hero. When the picture was done, the Saviour was found to be another Cato. "I told you so," he replied to the expostulations of the lady, "there is no inspiration in Christianity now!" David's revolutionary ideas, which led to his election to the presidency of the Convention and to the committee of general security, inspired his pictures "Last Moments of Lepelletier de Saint-Fargeau" and "Marat Assassinated." He also arranged the programme of the principal republican festivals. When Napoleon rose to power David became his enthusiastic admirer. His picture of Napoleon on horseback pointing the way to Italy is now in Berlin. During this period he also painted the "Rape of the Sabines" and "Leonidas at Thermopylae." Appointed painter to the emperor, David produced the two notable pictures "The Coronation" (of Josephine) and the "Distribution of the Eagles."

On the return of the Bourbons the painter was exiled with the other remaining regicides, and retired to Brussels, where he again

returned to classical subjects: "Amor quitting Psyche," "Mars disarmed by Venus," &c. He rejected the offer, made through Baron Humboldt, of the office of minister of fine arts at Berlin, and remained at Brussels till his death on the 29th of December 1825. His end was true to his whole career and to his nationality. While dying, a print of the Leonidas, one of his favourite subjects, was submitted to him. After vaguely looking at it a long time, "Il n'y a que moi qui pouvais concevoir la tête de Léonidas," he whispered, and died. His friends and his party thought to carry the body back to his beloved Paris for burial, but the government of the day arrested the procession at the frontier, an act which caused some scandal, and furnished the occasion of a terrible song of Béranger's.

It is difficult for a generation which has witnessed another complete revolution in the standards of artistic taste to realize the secret of David's immense popularity in his own day. His style is severely academic, his colour lacking in richness and warmth, his execution hard and uninteresting in its very perfection. Subjects and treatment alike are inspired by the passing fashion of an age which had deceived itself into believing that it was living and moving in the spirit of classical antiquity. The inevitable reaction of the romantic movement made the masterpieces, which had filled the men of the Revolution with enthusiasm, seem cold and lifeless to those who had been taught to expect in art that atmosphere of mystery which in nature is everywhere present. Yet David was a great artist, and exercised in his day and generation a great influence. His pictures are magnificent in their composition and their draughtsmanship; and his keen observation and insight into character are evident, especially in his portraits, notably of Madame Récamier, of the Conventional Gérard and of Boissy d'Anglas.

See E. J. Delécluze, *Louis David, son école et son temps* (Paris, 1855), and *Le Peintre Louis David. Souvenirs et documents inédits*, by J. L. Jules David, the painter's grandson (Paris, 1880).

**DAVID, PIERRE JEAN** (1789–1856), usually called David d'Angers, French sculptor, was born at Angers on the 12th of March 1789. His father was a sculptor, or rather a carver, but he had thrown aside the mallet and taken the musket, fighting against the Chouans of La Vendée. He returned to his trade at the end of the civil war, to find his customers gone, so that young David was born into poverty. As the boy grew up his father wished to force him into some more lucrative and certain way of life. At last he succeeded in surmounting the opposition to his becoming a sculptor, and in his eighteenth year left for Paris to study the art upon a capital of eleven francs. After struggling against want for a year and a half, he succeeded in taking the prize at the École des Beaux-Arts. An annuity of 600 francs (£24) was granted by the municipality of his native town in 1809, and in 1811 David's "Epaminondas" gained the *prix de Rome*. He spent five years in Rome, during which his enthusiasm for the works of Canova was often excessive.

Returning from Rome about the time of the restoration of the Bourbons, he would not remain in the neighbourhood of the Tuileries, which swarmed with foreign conquerors and returned royalists, and accordingly went to London. Here Flaxman and others visited upon him the sins of David the painter, to whom he was erroneously supposed to be related. With great difficulty he made his way to Paris again, where a comparatively prosperous career opened upon him. His medallions and busts were in much request, and orders for monumental works also came to him. One of the best of these was that of Gutenberg at Strassburg; but those he himself valued most were the statue of Barra, a drummer boy who continued to beat his drum till the moment of death in the war in La Vendée, and the monument to the Greek liberator Bozzaris, consisting in a young female figure called "Reviving Greece," of which Victor Hugo said: "It is difficult to see anything more beautiful in the world; this statue joins the grandeur of Pheidias to the expressive manner of Puget." David's busts and medallions were very numerous, and among his sitters may be found not only the illustrious men and women of France, but many others both of England and Germany—countries which he visited professionally in 1827 and 1829. His

medallions, it is affirmed, number 500. He died on the 4th of January 1856. David's fame rests firmly on his pediment of the Panthéon, his monument to General Gobert in Père Lachaise and his marble "Philopoemen" in the Louvre. In the Musée David at Angers is an almost complete collection of his works either in the form of copies or in the original moulds. As an example of his benevolence of character may be mentioned his rushing off to the sick-bed of Rouget de Lisle, the author of the "Marseillaise Hymn," modelling and carving him in marble without delay, making a lottery of the work, and sending to the poet in the extremity of need the seventy-two pounds which resulted from the sale.

See H. Jouin, *David d'Angers et ses relations littéraires* (1890); *Lettres de P. J. David d'Angers à Louis Dupré* (Paris, 1891); *Collection de portraits des contemporains d'après les médaillons de P. J. David* (Paris, 1838).

**DAVIDISTS**, a fancy name rather than a recognized designation for three religious sects. It has been applied (1) to the followers (if he had any) of David of Dinant, in Belgium, the teacher or pupil of Amalric (Amaury) of Bena, both of whom taught apparently a species of pantheism. David's *Quaterni*, or *Quaternuli*, condemned and burnt at Paris (1209), is a lost book, known only by references in Albertus Magnus and Thomas Aquinas. Its author would have been burnt had he not fled. The name has been given (2) to the followers of David George or Joris (q.v.), and (3) to the followers of Francis Dávid (1510–1579), the apostle of Transylvanian unitarianism. (See SOCINUS, UNITARIANISM.)

**DAVIDSON, ANDREW BRUCE** (1831–1902), Scottish divine, was born in 1831 at Kirkhill in Aberdeenshire, where his father Andrew Davidson had a farm. The Davidsons belonged to the congregation of James Robertson (1803–1860) of Ellon, one of the ministers of Strathbogie Presbytery, which in the controversy which led to the disruption, resisted the "dangerous claims of the established church to self-government." When the disruption came the principles at stake were keenly canvassed in Ellon, and eventually Andrew Davidson, senior, went with the Free Church. In 1845 the boy, who had been a "herd" on the farm, went for six months to the grammar school at Aberdeen and was there prepared for a university bursary, which was sufficient to pay his fees, but no more. During his four years at the university his mother supplied him fortnightly with provisions from the farm; sometimes she walked the whole twenty miles from Kirkhill and handed the coach fee to her son. He graduated in 1849. At the university he had acquired a distrust of philosophy, and found it difficult to choose between mathematical and linguistic studies. A Free Church school having been opened in Ellon, he became master there for three years. Here he developed special aptitude for linguistic and philological studies. Besides Hebrew he taught himself French, German, Dutch, Italian and Spanish. In November 1852 he entered New College, Edinburgh. There he took the four years' theological course, and was licensed in 1856. For two years he preached occasionally and took vacancies. In 1858 the New College authorities appointed him assistant to the professor of Hebrew. He taught during the winter, and in the long vacation continued his preparation for his life work. One year he worked in Germany under Ewald, another year he went to Syria to study Arabic. In 1862 he published the first part of a commentary on Job. It was never finished and deals only with one-third of the book, but it is recognized as the first really scientific commentary on the Old Testament in the English language. In 1863 he was appointed by the general assembly professor of oriental languages at New College. He was junior colleague of Dr John Duncan (Rabbi Duncan) till 1870, and then for thirty years sole professor. He was a member of the Old Testament revision committee, and his work was recognized by several honorary distinctions, LL.D. (Aberdeen), D.D. (Edinburgh), Litt.D. (Cambridge). Among his students were Professors Elmslie, Skinner, Harper of Melbourne, Walker of Belfast, George Adam Smith of Glasgow and W. Robertson Smith. He understood it to be the first duty of an exegete to ascertain the meaning of the writer, and he showed that this could be done by the use of grammar and history and the historical imagination. He supplied guidance when it was much

needed as to the methods and results of the higher criticism. Being a master of its methods, but very cautious in accepting assertions about its results, he secured attention early in the Free Church for scientific criticism, and yet threw the whole weight of his learning and his caustic wit into the argument against critical extravagance. He had thought himself into the ideas and points of view of the Hebrews, and his work in Old Testament theology is unrivalled. He excels as an expositor of the governing Hebrew ideas such as holiness, righteousness, Spirit of God, Messianism. In 1897 he was chosen moderator of the general assembly, but his health prevented his accepting the post. He died, unmarried, on the 26th of January 1902.

Besides the commentary on Job he published a book on the *Hebrew Accents*, the only Scottish performance of the kind since the days of Thomas Boston. His *Introductory Hebrew Grammar* has been widely adopted as a class-book in theological colleges. His *Hebrew Syntax* has the same admirable clearness, precision and teaching quality. His *Commentary on the Epistle to the Hebrews* is one of a series of handbooks for Bible classes. These were followed by commentaries on Job, Ezekiel, Nahum, Habakkuk and Zephaniah, in the Cambridge series; and a Bible-class primer on *The Exile and Restoration*. His lectures on *Old Testament Prophecy* were published after his death by Professor J. A. Paterson. The *Theology of the Old Testament* in the "International Theological Library" is a posthumous volume edited by Professor Salmond. "Isaiah" in the *Temple Bible* was finished, but not revised, when he died; and he also had in hand the volume on Isaiah for the *International Critical Commentary*; to which must be added a mass of articles contributed to *The Imperial Bible Dictionary*, *The Encyclopaedia Britannica*, and the chief religious reviews. Various articles in *Dr Hastings' Bible Dictionary* were by Davidson, especially the article "God." Two volumes of sermons, *The Called of God*, and *Waiting upon God*, were published from MS. after Davidson's death.

**DAVIDSON, JOHN** (1857-1909), British poet, playwright and novelist, son of the Rev. Alexander Davidson, a minister of the Evangelical Union, was born at Barrhead, Renfrewshire, Scotland, on the 11th of April 1857. After a schooling at the Highlanders' Academy, Greenock, at the age of thirteen he was set to work in that town, by helping in a sugar factory laboratory and then in the town analyst's office; and at fifteen he went back to his old school as a pupil-teacher. In 1876 he studied for a session at Edinburgh University, and then went as a master to various Scotch schools till 1890, varying his experiences in 1884 by being a clerk in a Glasgow thread firm. He had married in 1885, and meanwhile his literary inclinations had shown themselves, without attracting any public success, in the publication of his poetical and fantastic plays, *Bruce* (1886), *Smith; a tragic farce* (1888) and *Scaramouch in Naxos* (1889). Determining at all costs to follow his literary vocation, he went to London in 1890, but at first had a hard struggle. There his prose-romance *Perfervid* (1890) was published, one of the most original and fascinating stories of "young blood" and child adventure ever written, but for some reason it did not catch the public; and a sort of sequel in *The Great Men* (1891) met no better fate. He contributed, however, to newspapers and became known among literary journalists, and his volume of verse *In a Music-Hall* (1891) prepared the way for the genuine success two years later of his *Fleet Street Eclogues* (1893), which sounded a new and vigorous note and at once established his position among the younger generation of poets. He subsequently produced several more books in prose, romantic stories like *Baptist Lake* (1894) and *Earl Lavender* (1895), and an admirable piece of descriptive landscape writing in *A Random Itinerary* (1894); but his acceptance as a poet gave a more emphatic impulse to his work in verse, and most attention was given to the increasing proof of his powers shown in his *Ballads and Songs* (1894), *Second Series of Fleet Street Eclogues* (1895), *New Ballads* (1896), *The Last Ballad*, &c. (1898), all full of remarkably fresh and unconventional beauty. In spite of the strangely neglected genius of this early *Perfervid*, it is accordingly as a writer of verse rather than of prose-fiction that he occupies a leading place, with a decided character of his own, in recent English literature, his revival of a modernized ballad form being a considerable achievement in itself, and his poems being packed with fine thought, robust and masterful in expression and imagery. Meanwhile in 1896 he produced an English verse adaptation, in *For the Crown* (acted by Forbes

Robertson and Mrs Patrick Campbell), of François Coppée's drama *Pour la couronne*, which had considerable success and was revived in 1905; and he wrote several other literary plays, remarkable none the less for dramatic qualities,—*Godfrida* (1898), *Self's the Man* (1901), *The Knight of the Maypole* (1902) and *The Theatocrat* (1905), in the last of which a tendency to be extraordinary is rather too manifest. This tendency was not absent from his volume of *Holiday and Other Poems* (1906), containing many fine things, together with an "essay on blank verse" illustrated from his own compositions, the outspoken criticisms of a writer of admitted originality and insight, but not devoid of eccentric volubility. But if the identification of "eccentricity" and "greatness" by Cosmo Mortimer in Mr Davidson's own *Perfervid* sometimes obtrudes itself on the memory in considering his more peculiarly "robust" and somewhat volcanic deliverances, no such objection can detract from the genuine inspiration of his best work, in which the true poetic afflatus is unmistakable. This is to be found in his poems published from 1893 to 1898, five years during which his reputation steadily and deservedly grew,—the *Fleet Street Eclogues*, with their passionate modern criticism of life combined with their breath of rural beauty, and such intense ballads as those "Of a Nun," and "Of Heaven and Hell." In his ethical and didactic utterances, *The Testament of a Vivisector* and *The Testament of a Man Forbid* (1901), *The Testament of an Empire Builder* (1902), *Mammon and his Message* (1908), &c., the fine quality of the verse is wedded with a certain fervid satirical journalism of subject, less admirable than the detachment of thought in the earlier volumes. In later years he lived at Penzance, provided with a small Civil List pension, but otherwise badly off, for his writings brought in very little money. On March 23rd, 1909, he disappeared, in circumstances pointing to suicide, and six months later his body was found in the sea.

See an article by Filson Young on "The New Poetry," in the *Fortnightly Review*, January 1909.

**DAVIDSON, RANDALL THOMAS** (1848— ), archbishop of Canterbury, son of Henry Davidson, of Muirhouse, Edinburgh, was born in Edinburgh and educated at Harrow and Trinity College, Oxford. He took orders in 1874 and held a curacy at Dartford, in Kent, till 1877, when he became resident chaplain and private secretary to Dr Tait, archbishop of Canterbury, a position which he occupied till Dr Tait's death, and retained for a short time (1882-1883) under his successor Dr Benson. He married in 1878 Edith, the second daughter of Archbishop Tait, whose *Life* he eventually wrote (1891). In 1882 he became honorary chaplain and sub-almoner to Queen Victoria, and in the following year was appointed dean of Windsor, and domestic chaplain to the queen. His advice upon state matters was constantly sought by the queen and greatly valued. From 1891 to 1903 he was clerk of the closet, first to Queen Victoria and afterwards to King Edward VII. He was made bishop of Rochester in 1891, and was translated to Winchester in 1895. In 1903 he succeeded Temple as archbishop of Canterbury. The new archbishop, without being one of the English divines who have made notable contributions to theological learning, already had a great reputation for ecclesiastical statesmanship; and in subsequent years his diplomatic abilities found ample scope in dealing not only with the difficulties caused in the church by doctrinal questions, but pre-eminently with the education crisis, and with the new problems arising in the enlarged Anglican Communion. As the chief representative of the Church of England in the House of Lords, his firmness, combined with broadmindedness, in regard to the attitude of the nonconformists towards denominational education, made his influence widely felt. In 1904 he visited Canada and the United States, and was present at the triennial general convention of the Protestant Episcopal Church of the United States and Canada. In 1908 he presided at the Pan-Anglican congress held in London, and at the Lambeth conference which followed. He had edited in 1889 *The Lambeth Conferences*, an historical account of the conferences of 1867, 1878 and 1888, giving the official reports and resolutions, and the sermons preached on these occasions.



**DAVIDSON, SAMUEL** (1807–1898), Irish biblical scholar, was born near Ballymena in Ireland. He was educated at the Royal College of Belfast, entered the Presbyterian ministry in 1835, and was appointed professor of biblical criticism at his own college. Becoming a Congregationalist, he accepted in 1842 the chair of biblical criticism, literature and oriental languages at the Lancashire Independent College at Manchester; but he was obliged to resign in 1857, being brought into collision with the college authorities by the publication of an introduction to the Old Testament entitled *The Text of the Old Testament, and the Interpretation of the Bible*, written for a new edition of Horne's *Introduction to the Sacred Scripture*. Its liberal tendencies caused him to be accused of unsound views, and a most exhaustive report prepared by the Lancashire College committee was followed by numerous pamphlets for and against. After his resignation a fund of £3000 was subscribed as a testimonial by his friends. In 1862 he removed to London to become scripture examiner in London University, and he spent the rest of his life in literary work. He died on the 1st of April 1898. Davidson was a member of the Old Testament Revision Committee. Among his principal works are:—*Sacred Hermeneutics Developed and Applied* (1843), rewritten and republished as *A Treatise on Biblical Criticism* (1852), *Lectures on Ecclesiastical Polity* (1848), *An Introduction to the New Testament* (1848–1851), *The Hebrew Text of the Old Testament Revised* (1855), *Introduction to the Old Testament* (1862), *On a Fresh Revision of the Old Testament* (1873), *The Canon of the Bible* (1877), *The Doctrine of Last Things in the New Testament* (1883), besides translations of the New Testament from Von Tischendorf's text, Gieseler's *Ecclesiastical History* (1846) and Fürst's *Hebrew and Chaldee Lexicon*.

**DAVIDSON, THOMAS** (1817–1885), British palaeontologist, was born in Edinburgh on the 17th of May 1817. His parents possessed considerable landed property in Midlothian. Educated partly in the university at Edinburgh and partly in France, Italy and Switzerland, and early acquiring an interest in natural history, he benefited greatly by acquaintance with foreign languages and literature, and with men of science in different countries. He was induced in 1837, through the influence of Leopold von Buch, to devote his special attention to the brachiopoda, and in course of time he became the highest authority on this group. The great task of his life was the *Monograph of British Fossil Brachiopoda*, published by the Palaeontographical Society (1850–1886). This work, with supplements, comprises six quarto volumes with more than 200 plates drawn on stone by the author. He also prepared an exhaustive memoir on "Recent Brachiopoda," published by the Linnean Society. He was elected F.R.S. in 1857. He was awarded in 1865 the Wollaston medal by the Geological Society of London, and in 1870 a Royal medal by the Royal Society; and in 1882 the degree of LL.D. was conferred upon him by the university of St Andrews. He died at Brighton on the 14th of October 1885, bequeathing his fine collection of recent and fossil brachiopoda to the British Museum.

See biography with portrait and list of papers in *Geol. Mag.* for 1871, p. 145.

**DAVIES, DAVID CHARLES** (1826–1891), Welsh nonconformist divine, was born at Aberystwyth on the 11th of May 1826, his father being a merchant and a pioneer of Welsh Methodism, his mother a niece of Thomas Charles (*q.v.*) of Bala. He was educated in his native town by a noted schoolmaster, John Evans, at Bala College, and at University College, London, where he graduated B.A. in 1847 and M.A. (in mathematics) in 1849. He had already begun to preach, and after an evangelistic tour in South Wales supplied the pulpit of the English presbyterian church at Newtown for six months, and settled as pastor of the bilingual church at Builth in 1851. He returned to this charge after a pastorate at Liverpool (1853–1856), left it again in 1858 for Newtown, and went in May 1859 to the Welsh church at Jewin Crescent, London. Here he remained until 1876, and from that date till 1882, although living at Bangor for reasons of health, had the chief oversight of the church. In 1888 he accepted the principalship of the Calvinistic Methodist College at Trevecca in Brecknockshire. His work here was successful, but

short; he died at Bangor on the 26th of September 1891, and was buried at Aberystwyth.

Though Davies stood somewhat apart from the main currents of thought both without and within his church, and was largely unknown to English audiences or readers, he exercised a strong influence on Welsh life and thought in the 19th century. He was a serious student, especially of anti-theistic positions, a good speaker, and a frequent contributor to Welsh theological journals. Several of his articles have been collected and published, the most noteworthy being expositions on *The First Epistle of John* (1889), *Ephesians* (2 vols., 1896, 1901), *Psalms* (1897), *Romans* (1902); and *The Atonement and Intercession of Christ* (1899, English trans. by D. E. Jenkins, 1901).

**DAVIES, SIR JOHN** (1569–1626), English philosophical poet, was baptized on the 16th of April 1569, at Tisbury, Wiltshire, where his parents lived at the manor-house of Chicks Grove. He was educated at Winchester College, and became a commoner of Queen's College, Oxford, in 1585. In 1588 he entered the Middle Temple, and was called to the bar in 1595. In his general onslaught on literature in 1599 the archbishop of Canterbury ordered to be burnt the notorious and now excessively rare volume, *All Ovid's Elegies, 3 Bookes, by C. M. Epigrams by J. D.* (Middleburgh, 1598?), which contained posthumous work by Marlowe. The epigrams by Davies, although not devoid of wit, were coarse enough to deserve their fate. It is probable that they were earlier in date of composition than the charming fragment entitled *Orchestra* (1596), written in praise of dancing. The poet, in the person of Antinous, tries to induce Penelope to dance by arguing that all harmonious natural processes partake of the nature of a conscious and well-ordered dance. He closes his argument by foreshadowing in a magic mirror the revels of the court of Cynthia (Elizabeth). *Orchestra* was dedicated to the author's "very friend, Master Richard Martin," but in the next year the friends quarrelled, and Davies was expelled from the society for having struck Martin with a cudgel in the hall of the Middle Temple. He spent the year after his expulsion at Oxford in the composition of his philosophical poem on the nature of the soul and its immortality—*Nosce teipsum* (1599). The style of the work was entirely novel; and the stanza in which it was written—the decasyllabic quatrain with alternate rhymes—had never been so effectively handled. Its force, eloquence and ingenuity, the orderly and lucid arrangement of its matter, place it among the finest of English didactic poems. In 1599 he also published a volume of twenty-six graceful acrostics on the words *Elisabetha Regina*, entitled *Hymns to Astraea*. He produced no more poetry except his contributions to Francis Davison's *Poetical Rhapsody* (1608). These were two dialogues which had been written as entertainments for the queen, and "Yet other Twelve Wonders of the World," satirical epigrams on the courtier, the divine, the maid, &c., and "A Hymn in praise of Music." Ten sonnets to Philomel are signed J. D., and are assigned to Davies (*Poetical Rhapsody*, ed. A. H. Bullen, 1890). In 1601 Davies was restored to his position at the bar, after making his apologies to Martin, and in the same year he sat for Corfe Castle in parliament. James I. received the author of *Nosce teipsum* with great favour, and sent him (1603) to Ireland as solicitor-general, conferring the honour of knighthood upon him in the same year. In 1606 he was promoted to be attorney-general for Ireland, and created serjeant-at-arms. Of the difficulties in the way of the prosecution of his work, and his untiring industry in overcoming them, there is abundant evidence in his letters to Cecil preserved in the *State Papers on Ireland*. One of his chief aims was to establish the Protestant religion firmly in Ireland, and he took strict measures to enforce the law for attendance at church. With the same end in view he took an active part in the "plantation" of Ulster. In 1612 he published his prose *Discoverie of the true causes why Ireland was never entirely subdued untill the beginning of his Majestie's happie raigne*.<sup>1</sup> In the same year he entered the Irish parliament as member for Fermanagh, and was elected speaker after a scene of disorder in which the

<sup>1</sup> Edited by Henry Morley in his *Ireland under Elizabeth and James I.* (1890).

Catholic nominee, Sir John Everard, who had been installed, was forcibly ejected. In the capacity of speaker he delivered an excellent address reviewing previous Irish parliaments. He resigned his Irish offices in 1619, and sat in the English parliament of 1621 for Newcastle-under-Lyme. With Sir Robert Cotton he was one of the founders of the Society of Antiquaries. He was appointed lord chief justice in 1626, but died suddenly (December 8th) before he could enter on the office. He had married (1609) Eleanor Touchet, daughter of George, Baron Audley. She developed eccentricity, verging on madness, and wrote several fanatical books on prophecy.

In 1615 Davies published at Dublin *Le Primer Discours des Cases et Matters in Ley resolues et adjudges en les Courts del Roy en cest Realm* (reprinted 1628). He issued an edition of his poems in 1622. His prose publications were mainly posthumous. *The Question concerning Impositions, Tonnage, Poundage* . . . was printed in 1656, and four of the tracts relating to Ireland, with an account of Davies and his services to that country, were edited by G. Chalmers in 1786. His works were edited by Dr A. B. Grosart (3 vols. 1869-1876), with a full biography, for the Fuller Worthies Library.

He is not to be confounded with another poet, JOHN DAVIES of Hereford (1565?-1618), among whose numerous volumes of verse may be mentioned *Mirum in modum* (1602), *Microcosmus* (1603), *The Holy Rood* (1609), *Wittes Pilgrimage* (c. 1610), *The Scourge of Folly* (c. 1611), *The Muses Sacrifice* (1612) and *Wittes Bedlam* (1607); his *Scourge of Folly* contains verses addressed to many of his contemporaries, to Shakespeare among others; he also wrote *A Select Second Husband for Sir Thomas Overbury's Wife* (1616), and *The Writing Schoolmaster* (earliest known edition, 1633); his works were collected by Dr A. B. Grosart (2 vols., 1873) for the Chertsey Worthies Library.

DAVIES (DAVISIUS), JOHN (1679-1732), English classical scholar and critic, was born in London on the 22nd of April 1679. He was educated at Charterhouse and Queens' College, Cambridge, of which society he was elected fellow (July 7th, 1701). He subsequently became rector of Fen Ditton, prebendary of Ely, and president of his college. He died on the 7th of March 1731-1732, and was buried in the college chapel. Davies was considered one of the best commentators on Cicero, his attention being chiefly devoted to the philosophical works of that author. Amongst these he edited the *Tusculanae disputationes* (1709), *De natura deorum* (1718), *De divinatione* and *De fato* (1725), *Academica* (1725), *De legibus* (1727), *De finibus* (1728). His nearly finished notes on the *De officiis* he bequeathed to Dr Richard Mead, with a view to their publication. Mead, finding himself unable to carry out the undertaking, transferred the notes to Thomas Bentley (nephew of the famous Richard Bentley), by whose carelessness they were burnt. Davies's editions, which were intended to supplement those of Graevius, show great learning and an extensive knowledge of the history and systems of philosophy, but he allows himself too much licence in the matter of emendation. He also edited Maximus of Tyre's *Dissertationes* (1703); the works of Caesar (1706); the *Octavius* of Minucius Felix (1707); the *Epitome divinarum institutionum* of Lactantius (1718). Although on intimate terms with Richard Bentley, he found himself unable to agree with the great scholar in regard to his dispute with Trinity College.

DAVIES, SIR LOUIS HENRY (1845- ), Canadian politician and jurist, was born in Prince Edward Island in 1845, of Huguenot descent. From 1869 to 1879 he took part in local politics, and was premier from 1876-1879; in 1882 he entered the Canadian parliament as a Liberal, and from 1896 to 1901 was minister of marine and fisheries. In the latter year he became one of the judges of the supreme court of Canada. In 1877 he was counsel for Great Britain before the Anglo-American fisheries arbitration at Halifax; in 1897 he was a joint delegate to Washington with Sir Wilfrid Laurier on the Bering Sea seal question; and in 1898-1899 a member of the Anglo-American joint high commission at Quebec.

DAVIES, RICHARD (c. 1505-1581), Welsh bishop and scholar, was born in North Wales, and was educated at New Inn Hall, Oxford, becoming vicar of Burnham, Buckinghamshire, in 1550. Being a reformer he took refuge at Geneva during the reign of Mary, returning to England and to parochial work after the

accession of Elizabeth in 1558. His connexion with Wales was renewed almost at once; for, after serving on a commission which visited the Welsh dioceses, he was, in January 1560, consecrated bishop of St Asaph, whence he was translated, early in 1561, to the bishopric of St Davids. As a bishop Davies was an earnest reformer, very industrious, active and liberal, but not very scrupulous with regard to the property of the church. He was a member of the council of Wales, was very friendly with Matthew Parker, archbishop of Canterbury, and was regarded both by Parker and by William Cecil, Lord Burghley, as a trustworthy adviser on Welsh concerns. Another of the bishop's friends was Walter Devereux, first earl of Essex. Assisting William Salisbury, Davies took part in translating the New Testament into Welsh, and also did some work on the Welsh translation of the Book of Common Prayer. He helped to revise the "Bishops' Bible" of 1568, being himself responsible for the book of Deuteronomy, and the second book of Samuel. He died on the 7th of November 1581, and was buried in Abergwili church.

DAVILA, ENRICO CATERINO (1576-1631), Italian historian, was descended from a Spanish noble family. His immediate ancestors had been constables of the kingdom of Cyprus for the Venetian republic since 1464. But in 1570 the island was taken by the Turks; and Antonio Davila, the father of the historian, had to leave it, despoiled of all he possessed. He travelled into Spain and France, and finally returned to Padua, and at Sacco on the 30th of October 1576 his youngest son, Enrico Caterino, was born. About 1583 Antonio took this son to France, where he became a page in the service of Catherine de' Medici, wife of King Henry II. In due time he entered the military service, and fought through the civil wars until the peace in 1598. He then returned to Padua, where, and subsequently at Parma, he led a studious life until, when war broke out, he entered the service of the republic of Venice and served with distinction in the field. But during the whole of this active life, many details of which are very interesting as illustrative of the life and manners of the time, he never lost sight of a design which he had formed at a very early period, of writing the history of those civil wars in France in which he had borne a part, and during which he had had so many opportunities of closely observing the leading personages and events. This work was completed about 1630, and was offered in vain by the author to all the publishers in Venice. At last one Tommaso Baglioni, who had no work for his presses, undertook to print the manuscript, on condition that he should be free to leave off if more promising work offered itself. The printing of the *Istoria delle guerre civili di Francia* was, however, completed, and the success and sale of the work were immediate and enormous. Over two hundred editions followed, of which perhaps the best is the one published in Paris in 1644. Davila was murdered, while on his way to take possession of the government of Cremona for Venice in July 1631, by a ruffian, with whom some dispute seems to have arisen concerning the furnishing of the relays of horses ordered for his use by the Venetian government.

The *Istoria* was translated into French by G. Baudouin (Paris, 1642); into Spanish by Varen de Soto (Madrid, 1651, and Antwerp, 1686); into English by W. Aylesbury (London, 1647), and by Charles Cotterel (London, 1666), and into Latin by Pietro Francesco Cornazzano (Rome, 1745). The best account of the life of Davila is that by Apostolo Zeno, prefixed to an edition of the history printed at Venice in 2 vols. in 1733. Peter Bayle is severe on certain historical inaccuracies of Davila, and it is true that Davila must be read with due remembrance of the fact that he was not only a Catholic but the especial protégé of Catherine de' Medici, but it is not to be forgotten that Bayle was as strongly Protestant.

DAVIS, ANDREW JACKSON (1826-1910), American spiritualist, was born at Blooming Grove, Orange county, New York, on the 11th of August 1826. He had little education, though probably much more than he and his friends pretended. In 1843 he heard lectures in Poughkeepsie on "animal magnetism," as the phenomena of hypnotism was then termed, and found that he had remarkable clairvoyant powers; and in the following year he had, he said, spiritual messages telling him of his life work. For the next three years (1844-1847) he practised magnetic healing with much success; and in 1847 he published *The Principles of Nature, Her Divine Revelations, and a Voice to*

*Mankind*, which in 1845 he had dictated while in a trance to his "scribe," William Fishbough. He lectured with little success and returned to writing (or "dictating") books, publishing about thirty in all, including *The Great Harmonia* (1850-1861), an "encyclopaedia" in six volumes; *The Philosophy of Special Providences* (1850), which with its evident rehash of old arguments against special providences and miracles would seem to show that Davis's inspiration was literary; *The Magic Staff: an Autobiography* (1857), which was supplemented by *Arabula: or the Divine Guest, Containing a New Collection of New Gospels* (1867), the gospels being those "according to" St Confucius, St John (G. Whittier), St Gabriel (Derzhavin), St Octavius (Frothingham), St Gerrit (Smith), St Emma (Hardinge), St Ralph (W. Emerson), St Selden (J. Finney), St Theodore (Parker), &c.; and *A Stellar Key to the Summer Land* (1868) and *Views of Our Heavenly Home* (1878), each with illustrative diagrams. Davis was much influenced by Swedenborg and by the Shakers, who reprinted his panegyric of Ann Lee in an official *Sketch of Shakers and Shakerism* (1884).

**DAVIS, CHARLES HOWARD** (1857- ), American landscape painter, was born at East Cambridge, Massachusetts, on the 2nd of February 1857. A pupil of the schools of the Boston Museum of Fine Arts, he was sent to Paris in 1880. Having studied at the Academy Julian under Lefebvre and Boulanger, he went to Barbizon and painted much in the forest of Fontainebleau under the traditions of the "men of thirty." He became a full member of the National Academy of Design in 1906, and received many awards, including a silver medal at the Paris Exhibition of 1889. He is represented by important works in the Metropolitan Museum of Art, New York; the Corcoran Art Gallery, Washington; the Pennsylvania Academy, Philadelphia, and the Boston Museum of Fine Arts.

**DAVIS, CUSHMAN KELLOGG** (1838-1900), American political leader and lawyer, was born in Henderson, New York, on the 16th of June 1838. He was taken by his parents to Wisconsin Territory in the year of his birth, and was educated at Carroll College, Waukesha, Wisconsin, and at the university of Michigan, from which he graduated in 1857. After studying law in the office of Alexander W. Randall, he was admitted to the bar in 1860. During the Civil War, as a first lieutenant of Federal volunteers, he served in the western campaigns of 1862 and 1863, and in 1864 was an aide to General Willis A. Gorman (1814-1876). Resigning his commission (1864) on account of ill-health, he soon settled in St Paul, Minnesota, where he practised law in partnership with General Gorman, and soon became prominent both at the bar and, as a Republican, in politics. He served in the state House of Representatives in 1867, 1868-1873 was United States district attorney for Minnesota. In 1874-1876 he was governor of the state, and from 1887 until his death was a member of the United States Senate. In the Senate he was one of the acknowledged leaders of his party, an able and frequent speaker and a committee worker of great industry. In March 1897 he became chairman of the committee on foreign relations at a time when its work was peculiarly influential in shaping American foreign policy. His extensive knowledge of international law, and his tact and diplomacy, enabled him to render services of the utmost importance in connexion with the Spanish-American War, and he was one of the peace commissioners who negotiated and signed the treaty of Paris by which the war was terminated. He died at St Paul on the 27th of November 1900. Few public men in the United States since the Civil War have combined skill in diplomacy, constructive statesmanship, talent for political organization, oratorical ability and broad culture to such a degree as Senator Davis. In addition to various speeches and public addresses, he published an essay entitled *The Law of Shakespeare* (1899).

**DAVIS, HENRY WILLIAM BANKS** (1833- ), English painter, received his art training in the Royal Academy schools, where he was awarded two silver medals. He was elected an associate of the Academy in 1873, and academician in 1877. He made a considerable reputation as an accomplished painter of quiet pastoral subjects and carefully elaborated landscapes with cattle. His pictures, "Returning to the Fold" (1880), and

"Approaching Night" (1899), bought for the Chantrey Fund Collection, are now in the National Gallery of British Art (Tate Gallery).

**DAVIS, HENRY WINTER** (1817-1865), American political leader, was born at Annapolis, Maryland, on the 16th of August 1817. His father, Rev Henry Lyon Davis (1775-1836), was a prominent Protestant Episcopal clergyman of Maryland, and for some years president of St John's College at Annapolis. The son graduated at Kenyon College, Gambier, Ohio, in 1837, and from the law department of the university of Virginia in 1841, and began the practice of law in Alexandria, Virginia, but in 1850 removed to Baltimore, Maryland, where he won a high position at the bar. Early becoming imbued with strong anti-slavery views, though by inheritance he was himself a slave holder, he began political life as a Whig, but when the Whig party disintegrated, he became an "American" or "Know-Nothing," and as such served in the national House of Representatives from 1855 to 1861. By his independent course in Congress he won the respect and esteem of all political groups. In the contest over the speakership at the opening of the Thirty-Sixth Congress (1859) he voted with the Republicans, thereby incurring a vote of censure from the Maryland legislature, which called upon him to resign. In 1860, not being quite ready to ally himself wholly with the Republican party, he declined to be a candidate for the Republican nomination for the vice-presidency, and supported the Bell and Everett ticket. He was himself defeated in this year for re-election to Congress. In the winter of 1860-1861 he was active on behalf of compromise measures. Finally, after President Lincoln's election, he became a Republican, and as such was re-elected in 1862 to the national House of Representatives, in which he at once became one of the most radical and aggressive members, his views commanding especial attention owing to his being one of the few representatives from a slave state. From December 1863 to March 1865 he was chairman of the committee on foreign affairs; as such, in 1864, he was unwilling to leave the delicate questions concerning the French occupation of Mexico entirely in the hands of the president and his secretary of state, and brought in a report very hostile to France, which was adopted in the House, but fortunately, as it proved later, was not adopted by the Senate. With other radical Republicans Davis was a bitter opponent of Lincoln's plan for the reconstruction of the Southern States, and on the 15th of February 1864 he reported from committee a bill placing the process of reconstruction under the control of Congress, and stipulating that the Confederate States, before resuming their former status in the Union, must disfranchise all important civil and military officers of the Confederacy, abolish slavery, and repudiate all debts incurred by or with the sanction of the Confederate government. In his speech supporting this measure Davis declared that until Congress should "recognize a government established under its auspices, there is no government in the rebel states save the authority of Congress." The bill—the first formal expression by Congress with regard to Reconstruction—did not pass both Houses until the closing hours of the session, and failed to receive the approval of the president, who on the 8th of July issued a proclamation defining his position. Soon afterwards, on the 5th of August 1864, Davis joined Benjamin F. Wade of Ohio, who had piloted the bill through the Senate, in issuing the so-called "Wade-Davis Manifesto," which violently denounced President Lincoln for encroaching on the domain of Congress and insinuated that the reconstructing policy would leave slavery unimpaired in the reconstructed states. In a debate in Congress some months later he declared, "When I came into Congress ten years ago this was a government of law. I have lived to see it a government of personal will." He was one of the radical leaders who preferred Frémont to Lincoln in 1864, but subsequently withdrew his opposition and supported the President for re-election. He early favoured the enlistment of negroes, and in July 1865 publicly advocated the extension of the suffrage to them. He was not a candidate for re-election to Congress in 1864, and died in Baltimore, Maryland, on the 30th of December 1865. Davis was a man of scholarly tastes, an orator of unusual ability and

great eloquence, tireless and fearless in fighting political battles, but impulsive to the verge of rashness, impractical, tactless and autocratic. He wrote an elaborate political work entitled *The War of Ormusd and Ahriman in the Nineteenth Century* (1853), in which he combated the Southern contention that slavery was a divine institution.

See *The Speeches of Henry Winter Davis* (New York, 1867), to which is prefixed an oration on his life and character delivered in the House of Representatives by Senator J. A. J. Creswell of Maryland.

**DAVIS, JEFFERSON** (1808-1889), American soldier and statesman, president of the Confederate states in the American Civil War, was born on the 3rd of June 1808 at what is now the village of Fairview, in that part of Christian county, Kentucky, which was later organized as Todd county. His father, Samuel Davis (1756-1824), who served in the War of Independence, was of Welsh, and his mother, Jane Cook, of Scotch-Irish descent; during his infancy the family moved to Wilkinson county, Mississippi. Jefferson Davis was educated at Transylvania University (Lexington, Kentucky) and at the United States Military Academy at West Point. From the latter he graduated in July 1828, and became by brevet a second lieutenant of infantry. He was assigned for duty to Jefferson Barracks at St Louis, and on reaching this post was ordered to Fort Crawford, near Prairie du Chien, Wisconsin. In 1833 he took part in the closing scenes of the Black Hawk War, was present at the capture of Black Hawk, and was sent to Dixon, Illinois, to muster into service some volunteers from that state. Their captain was Abraham Lincoln, and Lieutenant Davis is said to have administered to him his first oath of allegiance. In June 1835 he resigned from the army, married Miss Knox Taylor, daughter of Colonel (later General) Zachary Taylor, and became a cotton planter in Warren county, Miss. In September of the same year, while visiting in Louisiana to escape the fever, his wife died of it and Davis himself was dangerously ill. For the next few months he travelled to regain his health; and in the spring of 1836 returned to his cotton plantation, where for several years he devoted his time largely to reading political philosophy, political economy, public law and the English classics, and by careful management of his estate he acquired considerable wealth. In 1843 Davis entered the field of politics as a Democrat, and exhibited great power as a public speaker. In 1844 he was chosen as a presidential elector on the Polk and Dallas ticket; in February 1845 he married Miss Varina Howell (1826-1906) of Mississippi (a granddaughter of Governor Richard Howell of New Jersey), and in the same year became a Democratic representative in Congress. From the beginning of his political career he advocated a strict construction of the Federal constitution. He was an ardent admirer of John C. Calhoun, and eventually became his successor as the leader of the South. In his rare speeches in the House of Representatives he clearly defined his position in regard to states rights, which he consistently held ever afterwards. During his first session, war with Mexico was declared, and he resigned his seat in June 1846 to take command of the first regiment raised in his state—the Mississippi Rifles. He served in the Northern Campaign under his father-in-law, General Taylor, and was greatly distinguished for gallantry and soldierly conduct at Monterey and particularly at Buena Vista, where he was severely wounded early in the engagement, but continued in command of his regiment until victory crowned the American arms. While still in the field he was appointed (May 1847) by President Polk to be brigadier-general of volunteers; but this appointment Davis declined, on the ground, as he afterwards said, "that volunteers are militia and the Constitution reserves to the state the appointment of all militia officers." Afterwards, Davis himself, as president of the Confederate States, was to appoint many volunteer officers.

Upon his return to his home late in 1847 he was appointed to fill a vacancy in the United States Senate, and in 1850 he was elected for a full term of six years. He resigned in 1851, but was again elected in 1857, and continued as a member from that year until the secession of his State in 1861. As a senator he stood in the front rank in a body distinguished for ability; his purity

of character and courteous manner, together with his intellectual gifts, won him the esteem of all parties; and he became more and more the leader of the Southern Democrats. He was, however, possessed of a logical rather than an intuitive mind. In his famous speech in the Senate on the 12th of July 1848, on the question of establishing a government for Oregon Territory, he held that a slave should be treated by the Federal government on the same basis as any other property, and therefore that it was the duty of Congress to protect the owner's right to his slave in whatever state or territory of the Union that slave might be. In the debates on the Compromise Measures of 1850 he took an active part, strongly opposing these measures, while Henry Stuart Foote (1800-1880), the other Mississippi senator, was one of their leading advocates. But although still holding to the theory expounded in his July speech of 1848, he was now ready with the proposal that slavery might be prohibited north of latitude 36° 30' N. provided it should not be interfered with in any territory south of that line. He resigned from the Senate in 1851 to become a candidate of the Democratic States-Rights party for the governorship of his state against Foote, the candidate of the Union Democrats. In the campaign he held, in opposition to the wishes of the more radical members of his party, that although secession might be resorted to as a last alternative the circumstances were not yet such as to justify it. A temporary loss of eyesight interfered with his canvass, and he was defeated by a small majority (1009), the campaign having been watched with the greatest interest throughout the country. In 1853 he accepted the position of secretary of war in the cabinet of President Pierce, and for four years performed the duties of the office with great distinction and with lasting benefit to the nation. He organized the engineer companies which explored and reported on the several proposed routes for a railway connecting the Mississippi valley with the Pacific Ocean; he effected the enlargement of the army, and made material changes in its equipment of arms and ammunition, utilizing the latest improvements; he made his appointments of subordinates on their merits, regardless of party considerations; he revised the system of tactics, perfected the signal corps service, and enlarged the coast and frontier defences of the country. During all this time he was on terms of intimate friendship with the president, over whom he undoubtedly exerted a powerful, but probably not, as is often said, a dominating influence; for instance he is generally supposed to have won the president's support for the Kansas-Nebraska Bill of 1854. After the passage of this bill, Davis, who as secretary of war had control of the United States troops in Kansas, sympathized strongly with the pro-slavery party there. At the end of his service in the cabinet, he was returned to the Senate. To his insistence in 1860 that the Democratic party should support his claim to the protection of slavery in the territories by the Federal government, the disruption of that party was in large measure due. At the same time he practically told the Senate that the South would secede in the event of the election of a radical Republican to the presidency; and on the 10th of January 1861, not long after the election of Lincoln, he argued before that body the constitutional right of secession and declared that the treatment of the South had become such that it could no longer remain in the Union without being degraded. When his state had passed the ordinance of secession he resigned his seat, and his speech on the 21st of January was a clear and able statement of the position taken by his state, and a most pathetic farewell to his associates.

On the 25th of January 1861 Davis was commissioned major-general of the forces Mississippi was raising in view of the threatened conflict. On the 9th of February he received the unanimous vote of the Provisional Congress of the seceded states as president of the "Confederate States of America." He was inaugurated on the 18th of February, was subsequently, after the adoption of the permanent constitution, regularly elected by popular vote, for a term of six years, and on the 22nd of February 1862 was again inaugurated. He had not sought the office, preferring service in the field. His brilliant career, both as

a civilian and as a soldier, drew all eyes to him as best fitted to guide the fortunes of the new Confederacy, and with a deep sense of the responsibility he obeyed the call. He heartily approved of the peace conference, which attempted to draw up a plan of reconciliation between the two sections, but whose failure made war inevitable. Montgomery, in Alabama, was the first Confederate capital, but after Virginia joined her sister states, the seat of government was removed to Richmond, on the 29th of May 1861. How Davis—of whom W. E. Gladstone, in the early days of English sympathy with the South, said that he had “made a nation”—bore himself in his most responsible position during the gigantic conflict which ensued, cannot here be related in detail. (See CONFEDERATE STATES; and AMERICAN CIVIL WAR.) In the shortest time he organized and put into the field one of the finest bodies of soldiers of which history has record. Factories sprang up in the South in a few months, supplying the army with arms and munitions of war, and the energy of the president was everywhere apparent. That he committed serious errors, his warmest admirers will hardly deny. Unfortunately his firmness developed into obstinacy, and exhibited itself in continued confidence in officers who had proved to be failures, and in dislike of some of his ablest generals. He committed the great mistake, too, of directing the movements of distant armies from the seat of government, though those armies were under able generals. This naturally caused great dissatisfaction, and more than once resulted in irreparable disaster. Moreover, he was not, like Lincoln, a great manager of men; he often acted without tact; he was charged with being domineering and autocratic, and at various times he was seriously hampered by the meddling of the Confederate Congress and the opposition of such men as the vice-president, A. H. Stephens, Governor Joseph E. Brown of Georgia, and Governor Zebulon Vance of North Carolina.

During the winter of 1864-1865 the resources of the government showed such exhaustion that it was apparent that the end would come with the opening of the spring campaign. This was clearly stated in the reports of the heads of departments and of General Lee. President Davis, however, acted as if he was assured of ultimate success. He sent Duncan F. Kenner as special commissioner to the courts of England and France to obtain recognition of the Confederacy on condition of the abolition of slavery. When a conference was held in Hampton Roads on the 3rd of February 1865 between President Lincoln and Secretary Seward on the one side, and A. H. Stephens, R. M. T. Hunter, and Judge James A. Campbell, representing President Davis, on the other, he instructed his representatives to insist on the recognition of the Confederacy as a condition to any arrangement for the termination of the war. This defeated the object of the conference, and deprived the South of terms which would have been more beneficial than those imposed by the conqueror when the end came a few weeks later. The last days of the Confederate Congress were spent in recriminations between that body and President Davis, and the popularity with which he commenced his administration had almost entirely vanished. In January 1865 the Congress proposed to supersede the president and make General Lee dictator,—a suggestion, however, to which the Confederate commander refused to listen.

After the surrender of the armies of Lee and Johnston in April 1865, President Davis attempted to make his way, through Georgia, across the Mississippi, in the vain hope of continuing the war with the forces of Generals Smith and Magruder. He was taken prisoner on the 10th of May by Federal troops near Irwinville, Irwin county, Georgia, and was brought back to Old Point, Virginia, in order to be confined in prison at Fortress Monroe. In prison he was chained and treated with great severity. He was indicted for treason by a Virginia grand jury, persistent efforts were made to connect him with the assassination of President Lincoln, he was unjustly charged with having deliberately and wilfully caused the sufferings and deaths of Union prisoners at Andersonville and for two years he was denied trial or bail. Such treatment aroused the sympathy of the Southern people, who regarded him as a martyr to their cause, and in a great measure restored him to that place in their esteem which

by the close of the war he had lost. It also aroused a general feeling in the North, and when finally he was admitted to bail (in May 1867), Horace Greeley, Gerrit Smith, and others in that section who had been his political opponents, became his sureties. Charles O'Connor, a leader of the New York bar, volunteered to act as his counsel. With him was associated Robert Ould of Richmond, a lawyer of great ability. They moved to quash the indictment on which he was brought to trial. Chief Justice Chase and Judge John C. Underwood constituted the United States circuit court sitting for Virginia before which the case was brought in December 1868; the court was divided, the chief justice voting to sustain the motion and Underwood to overrule it. The matter was thereupon certified to the Supreme Court of the United States, but as the general amnesty of the 25th of December 1868 included Davis, an order of *nolle prosequi* was entered in February 1869, and Davis and his bondsmen were thereupon released. After his release he visited Europe, and spent the last years of his life in retirement, during which he wrote his *Rise and Fall of the Confederate Government* (2 vols., 1881). In these volumes he attempted to vindicate his administration, and in so doing he attacked the records of those generals he disliked. He also wrote a *Short History of the Confederate States of America* (1890). He died on the 6th of December 1889, at New Orleans, leaving a widow and two daughters—Margaret, who married J. A. Hayes in 1877, and Varina Anne (1864-1898), better known as “Winnie” Davis, the “daughter of the Confederacy,” who was the author of several books, including *A Sketch of the Life of Robert Emmet* (1888), a novel, *The Veiled Doctor* (1895), and *A Romance of Summer Seas* (1898). A monument to her, designed by George J. Zolnay, and erected by the Daughters of the Confederacy, was unveiled in Hollywood cemetery, Richmond, Va, on the 9th of November 1899. Mrs Davis, who exerted a marked influence over her husband, survived him many years, passed the last years of her life in New York City, and died there on the 16th of October 1906.

**AUTHORITIES.**—Several biographies and memoirs of Davis have been published, of which the best are: *Jefferson Davis, Ex-President of the Confederate States* (2 vols., New York, 1890), by his widow; F. H. Alfriend's *Life of Jefferson Davis* (Cincinnati, 1868), which defended him from the charges of incompetence and despotism brought against him; E. A. Pollard's *Life of Jefferson Davis, with a Secret History of the Southern Confederacy* (Philadelphia, 1869), a somewhat partisan arraignment by a prominent Southern journalist; and W. E. Dodd's *Jefferson Davis* (Philadelphia, 1907), which embodies the results of recent historical research. *The Prison Life of Jefferson Davis* (New York, 1866) by John J. Craven (d. 1893), a Federal army surgeon who was Davis's physician at Fortress Monroe, was long popular; it gives a vivid and sympathetic picture of Mr Davis as a prisoner, but its authenticity and accuracy have been questioned. (W. W. H.\*; N. D. M.)

**DAVIS (or DAVYS), JOHN** (1550?-1605), one of the chief English navigators and explorers under Elizabeth, especially in Polar regions, was born at Sandridge near Dartmouth about 1550. From a boy he was a sailor, and early made several voyages with Adrian Gilbert; both the Gilbert and Raleigh families were Devonians of his own neighbourhood, and through life he seems to have profited by their friendship. In January 1583 he appears to have broached his design of a north-west passage to Walsingham and John Dee; various consultations followed; and in 1585 he started on his first north-western expedition. On this he began by striking the ice-bound east shore of Greenland, which he followed south to Cape Farewell; thence he turned north once more and coasted the west Greenland littoral some way, till, finding the sea free from ice, he shaped a “course for China” by the north-west. In 66° N., however, he fell in with Baffin Land, and though he pushed some way up Cumberland Sound, and professed to recognize in this the “hoped strait,” he now turned back (end of August). He tried again in 1586 and 1587; in the last voyage he pushed through the straits still named after him into Baffin's Bay, coasting west Greenland to 73° N., almost to Upernavik, and thence making a last effort to find a passage westward along the north of America. Many points in Arctic latitudes (Cumberland Sound, Cape Walsingham, Exeter Sound, &c.) retain names given them by Davis, who ranks with Baffin and Hudson as the greatest of early Arctic explorers and, like



Frobisher, narrowly missed the discovery of Hudson's Bay via Hudson's Straits (the "Furious Overfall" of Davis). In 1588 he seems to have commanded the "Black Dog" against the Spanish Armada; in 1589 he joined the earl of Cumberland off the Azores; and in 1591 he accompanied Thomas Cavendish on his last voyage, with the special purpose, as he tells us, of searching "that north-west discovery upon the back parts of America." After the rest of Cavendish's expedition returned unsuccessful, he continued to attempt on his own account the passage of the Strait of Magellan; though defeated here by foul weather, he discovered the Falkland Islands. The passage home was extremely disastrous, and he brought back only fourteen of his seventy-six men. After his return in 1593 he published a valuable treatise on practical navigation in *The Seaman's Secrets* (1594), and a more theoretical work in *The World's Hydrographical Description* (1595). His invention of back-staff and double quadrant (called a "Davis Quadrant" after him) held the field among English seamen till long after Hadley's reflecting quadrant had been introduced. In 1596-1597 Davis seems to have sailed with Raleigh (as master of Sir Walter's own ship) to Cadiz and the Azores; and in 1598-1600 he accompanied a Dutch expedition to the East Indies as pilot, sailing from Flushing, returning to Middleburg, and narrowly escaping destruction from treachery at Achin in Sumatra. In 1601-1603 he accompanied Sir James Lancaster as first pilot on his voyage in the service of the East India Company; and in December 1604 he sailed again for the same destination as pilot to Sir Edward Michelborne (or Michelbourn). On this journey he was killed by Japanese pirates off Bintang near Sumatra.

*A Traverse Book made by John Davis in 1587, an Account of his Second Voyage in 1586, and a Report of Master John Davis of his three voyages made for the Discovery of the North West Passage* were printed in Hakluyt's collection. Davis himself published *The Seaman's Secrets, divided into two Parts* (London, 1594), *The World's Hydrographical Description . . . whereby appears that there is a short and speedy Passage into the South Seas, to China, Molucca, Philippina, and India, by Northerly Navigation* (London, 1595). Various references to Davis are in the *Calendars of State Papers, Domestic* (1591-1594), and *East Indies* (1513-1616). See also *Voyages and Works of John Davis*, edited by A. H. Markham (London, Hakluyt Society, 1880), and the article "John Davys" by Sir J. K. Laughton in the *Dictionary of National Biography*. (C. R. B.)

**DAVIS, THOMAS OSBORNE** (1814-1845), Irish poet and journalist, was born at Mallow, Co. Cork, on the 14th of October 1814. His father, James Thomas Davis, a surgeon in the royal artillery, who died in the month of his son's birth, belonged to an English family of Welsh extraction, and his mother, Mary Atkins, belonged to a Protestant Anglo-Irish family. Davis graduated B.A. at Trinity College, Dublin, in 1836, and was called to the bar two years later. Brought up in an English and Tory circle, he was led to adopt nationalist views by the study of Irish history, a complicated subject in which text-books and the ordinary guides to knowledge were then lacking. In 1840 he made a speech appealing to Irish sentiment before the college historical society, which had been reorganized in 1839. With a view to indoctrinating the Irish people with the idea of nationality he joined John Blake Dillon in editing the *Dublin Morning Register*. The proprietor very soon dismissed him, and Davis saw that his propaganda would be ineffective if he continued to stand outside the national organization. He therefore announced himself a follower of Daniel O'Connell, and became an energetic worker (1841) on the committee of the repeal association. He helped Dillon and Charles Gavan Duffy to found the weekly newspaper, *The Nation*, the first number of which appeared on the 15th of October 1842. The paper was chiefly written by these three promoters, and its concentrated purpose and vigorous writing soon attracted attention. Davis, who had never written verse, was induced to attempt it for the new undertaking. The "Lament of Owen Roe O'Neill" was printed in the sixth number, and was followed by a series of lyrics that take a high place in Irish national poetry—"The Battle of Fontenoy," "The Geraldines," "Máire Bhán a Stoif" and many others. Davis contemplated a history of Ireland, an edition of the speeches of Irish orators, one volume of which appeared, and

a life of Wolfe Tone. These projects remained incomplete, but Davis's determination and continuous zeal made their mark on his party. Differences arose between O'Connell and the young writers of *The Nation*, and as time went on became more pronounced. Davis was accused of being anti-Catholic, and was systematically attacked by O'Connell's followers. But he differed, said Sir Charles Gavan Duffy, from earlier and later Irish tribunes, "by a perfectly genuine desire to remain unknown, and reap neither recognition nor reward for his work." His early death from scarlet fever (September 15th, 1845) deprived "Young Ireland" of its most striking personality.

His *Poems* and his *Literary and Historical Essays* were collected in 1846. There is an edition of his prose writings (1889) in the *Camelot Classics*. See the monograph on *Thomas Davis* by Sir Charles Gavan Duffy (1890, abridged ed. 1896), and the same writer's *Young Ireland* (revised edition, 1896).

**DAVISON, WILLIAM** (c. 1541-1608), secretary to Queen Elizabeth, was of Scottish descent, and in 1566 acted as secretary to Henry Killigrew (d. 1603), when he was sent into Scotland by Elizabeth on a mission to Mary, queen of Scots. Remaining in that country for about ten years, Davison then went twice to the Netherlands on diplomatic business, returning to England in 1586 to defend the hasty conduct of his friend, Robert Dudley, earl of Leicester. In the same year he became member of parliament for Knaresborough, a privy councillor, and assistant to Elizabeth's secretary, Thomas Walsingham; but he soon appears to have acted rather as the colleague than the subordinate of Walsingham. He was a member of the commission appointed to try Mary, queen of Scots, although he took no part in its proceedings. When sentence was passed upon Mary the warrant for her execution was entrusted to Davison, who, after some delay, obtained the queen's signature. On this occasion, and also in subsequent interviews with her secretary, Elizabeth suggested that Mary should be executed in some more secret fashion, and her conversation afforded ample proof that she disliked to take upon herself any responsibility for the death of her rival. Meanwhile, the privy council having been summoned by Lord Burghley, it was decided to carry out the sentence at once, and Mary was beheaded on the 8th of February 1587. When the news of the execution reached Elizabeth she was extremely indignant, and her wrath was chiefly directed against Davison, who, she asserted, had disobeyed her instructions not to part with the warrant. The secretary was arrested and thrown into prison, but, although he defended himself vigorously, he did not say anything about the queen's wish to get rid of Mary by assassination. Charged before the Star Chamber with misprision and contempt, he was acquitted of evil intention, but was sentenced to pay a fine of 10,000 marks, and to imprisonment during the queen's pleasure; but owing to the exertions of several influential men he was released in 1589. The queen, however, refused to employ him again in her service, and he retired to Stepney, where he died in December 1608. Davison appears to have been an industrious and outspoken man, and was undoubtedly made the scapegoat for the queen's pusillanimous conduct. By his wife, Catherine Spelman, he had a family of four sons and two daughters. Two of his sons, Francis and Walter, obtained some celebrity as poets.

Many state papers written by him, and many of his letters, are extant in various collections of manuscripts. See Sir N. H. Nicolas, *Life of W. Davison* (London, 1823); J. A. Froude, *History of England* (London, 1881 fol.); *Calendar of State Papers 1580-1609*; and *Correspondence of Leicester during his Government of the Low Countries*, edited by J. Bruce (London, 1844).

**DAVIS STRAIT**, the broad strait which separates Greenland from North America, and connects Baffin Bay with the open Atlantic. At its narrowest point, which occurs just where the Arctic Circle crosses it, it is nearly 200 m. wide. This part is also the shallowest, a sounding of 112 fathoms being found in the centre, whereas the depth increases rapidly both to north and to south. Along the western shore (Baffin Land) a cold current passes southward; but along the east there is a warm northward stream, and there are a few Danish settlements on the Greenland coast. The strait takes its name from the explorer John Davis.

**DAVITT, MICHAEL** (1846-1906), Irish Nationalist politician, son of a peasant farmer in Co. Mayo, was born on the 25th of March 1846. His father was evicted for non-payment of rent in 1851, and migrated to Lancashire, where at the age of ten the boy began work in a cotton mill at Haslingden. In 1857 he lost his right arm by a machinery accident, and he had to get employment as a newsboy and printer's "devil." He drifted into the ranks of the Fenian brotherhood in 1865, and in 1870 he was arrested for treason-felony in arranging for sending fire-arms into Ireland, and was sentenced to fifteen years' penal servitude. After seven years he was released on ticket of leave. He at once rejoined the "Irish Republican Brotherhood," and went to the United States, where his mother, herself of American birth, had settled with the rest of the family, in order to concert plans with the Fenian leaders there. Returning to Ireland he helped C. S. Parnell to start the Land League in 1879, and his violent speeches resulted in his re-arrest and consignment to Portland by Sir William Harcourt, then home secretary. He was released in 1882, but was again prosecuted for seditious speeches in 1883, and suffered three months' imprisonment. He had been elected to parliament for Meath as a Nationalist in 1882, but being a convict was disqualified to sit. He was included as one of the respondents before the Parnell Commission (1888-1890) and spoke for five days in his own defence, but his prominent association with the revolutionary Irish schemes was fully established. (See PARNELL.) He took the anti-Parnellite side in 1890, and in 1892 was elected to parliament for North Meath, but was unseated on petition. He was then returned for North-East Cork, but had to vacate his seat through bankruptcy, caused by the costs in the North Meath petition. In 1895 he was elected for West Mayo, but retired before the dissolution in 1900. He died on the 31st of May 1906, in Dublin. A sincere but embittered Nationalist, anti-English to the backbone, anti-clerical, and sceptical as to the value of the purely parliamentary agitation for Home Rule, Davitt was a notable representative of the survival of the Irish "physical force" party, and a strong link with the extremists in America. In later years his Socialistic Radicalism connected him closely with the Labour party. He wrote constantly in American and colonial journals, and published some books, always with the strongest bias against English methods; but his force of character earned him at least the respect of those who could make calm allowance for an open enemy of the established order, and a higher meed of admiration from those who sympathized with his objects or were not in a position to be threatened by them.

**DAVOS** (Romansch *Tavaus*, a name variously explained as meaning a sheep pasture or simply "behind"), a mountain valley in the Swiss canton of the Grisons, lying east of Coire (whence it is 40 m. distant by rail, and north-west of the Lower Engadine (accessible at Sûs in 18 m. by road). It contains two main villages, 2 m. from each other, Dörfli and Platz (the chief hamlet), which are 5015 ft. above the sea-level, and had a population in 1900 of 8089, a figure exceeded in the Grisons only by the capital Coire. Of the population 5391 were Protestants, 2564 Romanists, and 81 Jews; while 6048 were German-speaking and 486 Romansch-speaking. In 1860 the population was only 1705, rising to 2002 in 1870, to 2865 in 1880, to 3891 in 1888, and to 8089 in 1890. This steady increase is due to the fact that the valley is now much frequented in winter by consumptive patients, as its position, sheltered from cold winds and exposed to brilliant sunshine in the daytime, has a most beneficial effect on invalids in the first stages of that terrible disease. A local doctor, by name Spengler, first noticed this fact about 1865, and the valley soon became famous. It is now provided with excellent hotels, sanatoria, &c.; but as lately as 1860 there was only one inn there, housed in the 16th-century *Rathhaus* (town hall), which is still adorned by the heads of wolves shot in the neighbourhood. At the north end of the valley is the fine lake of Davos, used for skating in the winter, while from Platz the splendidly engineered *Landwasserstrasse* leads (20 m.) down to the *Alvaneubad* station on the Albula railway from Coire to the Engadine.

We first hear of Tavaus or Tavauns in 1160 and 1213, as a

mountain pasture or "alp." It was then in the hands of a Romansch-speaking population, as is shown by many surviving field names. But, some time between 1260 and 1282, a colony of German-speaking persons from the Upper Valais (first mentioned in 1289) was planted there by its lord, Walter von Vaz, so that it has long been a Teutonic island in the midst of a Romansch-speaking population. Historically it is associated with the Prättigau or Landquart valley to the north, as it was the most important village of the region, and in 1436 became the capital of the League of the Ten Jurisdictions. (See GRISONS.) It formerly contained many iron mines, and belonged from 1477 to 1649 to the Austrian Habsburgs. In 1779 Davos was visited and described by Archdeacon W. Coxe. (W. A. B. C.)

**DAVOUT, LOUIS NICOLAS**, duke of Auerstädt and prince of Eckmühl (1770-1823), marshal of France, was born at Annou (Yonne) on the 10th of May 1770. His name is also, less correctly, spelt Davout and Davoust. He entered the French army as a sub-lieutenant in 1788, and on the outbreak of the Revolution he embraced its principles. He was *chef de bataillon* in a volunteer corps in the campaign of 1792, and distinguished himself at Neerwinden in the following spring. He had just been promoted general of brigade when he was removed from the active list as being of noble birth. He served, however, in the campaigns of 1794-1797 on the Rhine, and accompanied Desaix in the Egyptian expedition of Bonaparte. On his return he took part in the campaign of Marengo under Napoleon, who placed the greatest confidence in his abilities, made him a general of division soon after Marengo, and in 1801 gave him a command in the consular guard. At the accession of Napoleon as emperor, Davout was one of the generals who were created marshals of France. As commander of the III. corps of the *Grande Armée* Davout rendered the greatest services. At Austerlitz, after a forced march of forty-eight hours, the III. corps bore the brunt of the allies' attack. In the Jena campaign Davout with a single corps fought and won the brilliant victory of Auerstädt against the main Prussian army. (See NAPOLEONIC CAMPAIGNS.) He took part, and added to his renown, in the campaign of Eylau and Friedland. Napoleon left him as governor-general in the grand-duchy of Warsaw when the treaty of Tilsit put an end to the war (1807), and in 1808 created him duke of Auerstädt. In the war of 1809 Davout took a brilliant part in the actions which culminated in the victory of Eckmühl, and had an important share in the battle of Wagram (*q.v.*). He was created prince of Eckmühl about this time. It was Davout who was entrusted by Napoleon with the task of organizing the "corps of observation of the Elbe," which was in reality the gigantic army with which the emperor invaded Russia in 1812. In this Davout commanded the I. corps, over 70,000 strong, and defeated the Russians at Mohilev before he joined the main army, with which he continued throughout the campaign and the retreat from Moscow. In 1813 he commanded the Hamburg military district, and defended Hamburg, a city ill fortified and provisioned, and full of disaffection, through a long siege, only surrendering the place on the direct order of Louis XVIII. after the fall of Napoleon in 1814.

Davout's military character was on this, as on many other occasions, interpreted as cruel and rapacious, and he had to defend himself against many attacks upon his conduct at Hamburg. He was a stern disciplinarian, almost the only one of the marshals who exacted rigid and precise obedience from his troops, and consequently his corps was more trustworthy and exact in the performance of its duty than any other. Thus, in the earlier days of the *Grande Armée*, it was always the III. corps which was entrusted with the most difficult part of the work in hand. The same criterion is to be applied to his conduct of civil affairs. His rapacity was in reality Napoleon's, for he gave the same undeviating obedience to superior orders which he enforced in his own subordinates. As for his military talents, he was admitted by his contemporaries and by later judgment to be one of the ablest, perhaps the ablest, of all Napoleon's marshals. On the first restoration he retired into private life, openly displaying his hostility to the Bourbons, and when Napoleon returned from Elba, Davout at once joined him.

Appointed minister of war, he reorganized the French army as far as the limited time available permitted, and he was so far indispensable to the war department that Napoleon kept him at Paris during the Waterloo campaign. To what degree his skill and bravery would have altered the fortunes of the campaign of 1815 can only be surmised, but it has been made a ground of criticism against Napoleon that he did not avail himself in the field of the services of the best general he then possessed. Davout directed the gallant, but hopeless, defence of Paris after Waterloo, and was deprived of his marshalate and his titles at the second restoration. When some of his subordinate generals were proscribed, he demanded to be held responsible for their acts, as executed under his orders, and he endeavoured to prevent the condemnation of Ney. After a time the hostility of the Bourbons towards Davout died away, and he was reconciled to the monarchy. In 1817 his rank and titles were restored, and in 1819 he became a member of the chamber of peers. He died at Paris on the 1st of June 1823.

See the marquise de Blocqueville, *Le Maréchal Davout raconté par les siens et lui-même* (Paris, 1870-1880, 1887); Chenier, *Davout, duc d'Auerstädt* (Paris, 1866).

**DAVY, SIR HUMPHRY**, Bart. (1778-1829), English chemist, was born on the 17th of December 1778 at or near Penzance in Cornwall. During his school days at the grammar schools of Penzance and Truro he showed few signs of a taste for scientific pursuits or indeed of any special zeal for knowledge or of ability beyond a certain skill in making verse translations from the classics and in story-telling. But when in 1794 his father, Robert Davy, died, leaving a widow and five children in embarrassed circumstances, he awoke to his responsibilities as the eldest son, and becoming apprentice to a surgeon-apothecary at Penzance set to work on a systematic and remarkably wide course of self-instruction which he mapped out for himself in preparation for a career in medicine. Beginning with metaphysics and ethics and passing on to mathematics, he turned to chemistry at the end of 1797, and within a few months of reading Nicholson's and Lavoisier's treatises on that science had produced a new theory of light and heat. About the same time he made the acquaintance of two men of scientific attainments—Gregory Watt (1777-1804), a son of James Watt, and Davies Giddy, afterwards Gilbert (1767-1839), who was president of the Royal Society from 1827 to 1831. By the latter he was recommended to Dr Thomas Beddoes, who was in 1798 establishing his Medical Pneumatic Institution at Bristol for investigating the medicinal properties of various gases. Here Davy, released from his indentures, was installed as superintendent towards the end of 1798. Early next year two papers from his pen were published in Beddoes' *West Country Contributions*—one "On Heat, Light and the Combinations of Light, with a new Theory of Respiration and Observations on the Chemistry of Life," and the other "On the Generation of Phosoxygen (Oxygen gas) and the Causes of the Colours of Organic Beings." These contain an account of the well-known experiment in which he sought to establish the immateriality of heat by showing its generation through the friction of two pieces of ice in an exhausted vessel, and further attempt to prove that light is "matter of a peculiar kind," and that oxygen gas, being a compound of this matter with a simple substance, would more properly be termed phosoxygen. Founded on faulty experiments and reasoning, the views he expressed were either ignored or ridiculed; and it was long before he bitterly regretted the temerity with which he had published his hasty generalizations.

One of his first discoveries at the Pneumatic Institution on the 9th of April 1799 was that pure nitrous oxide (laughing gas) is perfectly respirable, and he narrates that on the next day he became "absolutely intoxicated" through breathing sixteen quarts of it for "near seven minutes." This discovery brought both him and the Pneumatic Institution into prominence. The gas itself was inhaled by Southey and Coleridge among other distinguished people, and promised to become fashionable, while further research yielded Davy material for his *Researches, Chemical and Philosophical, chiefly concerning Nitrous Oxide*,

published in 1800, which secured his reputation as a chemist. Soon afterwards, Count Rumford, requiring a lecturer on chemistry for the recently established Royal Institution in London, opened negotiations with him, and on the 16th of February 1801 he was engaged as assistant lecturer in chemistry and director of the laboratory. Ten weeks later, having "given satisfactory proofs of his talents" in a course of lectures on galvanism, he was appointed lecturer, and his promotion to be professor followed on the 31st of May 1802. One of the first tasks imposed on him by the managers was the delivery of a course of lectures on the chemical principles of tanning, and he was given leave of absence for July, August and September 1801 in order to acquaint himself practically with the subject. The main facts he discovered from his experiments in this connexion were described before the Royal Society in 1803. In 1802 the board of agriculture requested him to direct his attention to agricultural subjects; and in 1803, with the acquiescence of the Royal Institution, he gave his first course of lectures on agricultural chemistry and continued them for ten successive years, ultimately publishing their substance as *Elements of Agricultural Chemistry* in 1813. But his chief interest at the Royal Institution was with electro-chemistry. Galvanic phenomena had already engaged his attention before he left Bristol, but in London he had at his disposal a large battery which gave him much greater opportunities. His first communication to the Royal Society, read in June 1801, related to galvanic combinations formed with single metallic plates and fluids, and showed that an electric cell might be constructed with a single metal and two fluids, provided one of the fluids was capable of oxidizing one surface of the metal; previous piles had consisted of two different metals, or of one plate of metal and the other of charcoal, with an interposed fluid. Five years later he delivered before the Royal Society his first Bakerian lecture, "On some Chemical Agencies of Electricity," which J. J. Berzelius described as one of the most remarkable memoirs in the history of chemical theory. He summed up his results in the general statement that "hydrogen, the alkaline substances, the metals and certain metallic oxides are attracted by negatively electrified metallic surfaces, and repelled by positively electrified metallic surfaces; and contrariwise, that oxygen and acid substances are attracted by positively electrified metallic surfaces and repelled by negatively electrified metallic surfaces; and these attractive and repulsive forces are sufficiently energetic to destroy or suspend the usual operation of elective affinity." He also sketched a theory of chemical affinity on the facts he had discovered, and concluded by suggesting that the electric decomposition of neutral salts might in some cases admit of economical applications and lead to the isolation of the true elements of bodies. A year after this paper, which gained him from the French Institute the medal offered by Napoleon for the best experiment made each year on galvanism, he described in his second Bakerian lecture the electrolytic preparation of potassium and sodium, effected in October 1807 by the aid of his battery. According to his cousin, Edmund Davy,<sup>1</sup> then his laboratory assistant, he was so delighted with this achievement that he danced about the room in ecstasy. Four days after reading his lecture his health broke down, and severe illness kept him from his professional duties until March 1808. As soon as he was able to work again he attempted to obtain the metals of the alkaline earths by the same methods as he had used for those of the fixed alkalis, but they eluded his efforts and he only succeeded in preparing them as amalgams with mercury, by a process due to Berzelius. His attempts to decompose "alumine, silica, zircon and glucine" were still less fortunate. At the end of 1808 he read his third Bakerian lecture, one of the longest of his papers but not one of the best. In it he disproved the idea advanced by Gay Lussac that potassium was a compound of hydrogen, not an element; but on the other hand he cast doubts on the elementary

<sup>1</sup> Edmund Davy (1785-1857) became professor of chemistry at Cork Institution in 1813, and at the Royal Dublin Society in 1826. His son, Edmund William Davy (born in 1826), was appointed professor of medicine in the Royal College, Dublin, in 1870.

character of phosphorus, sulphur and carbon, though on this point he afterwards corrected himself. He also described the preparation of boron, for which at first he proposed the name boracium, on the impression that it was a metal. About this time a voluntary subscription among the members of the Royal Institution put him in possession of a new galvanic battery of 2000 double plates, with a surface equal to 128,000 sq. in., to replace the old one, which had become unserviceable. His fourth Bakerian lecture, in November 1809, gave further proofs of the elementary nature of potassium, and described the properties of telluretted hydrogen. Next year, in a paper read in July and in his fifth Bakerian lecture in November, he argued that oxymuriatic acid, contrary to his previous belief, was a simple body, and proposed for it the name "chlorine."

Davy's reputation was now at its zenith. As a lecturer he could command an audience of little less than 1000 in the theatre of the Royal Institution, and his fame had spread far outside London. In 1810, at the invitation of the Dublin Society, he gave a course of lectures on electro-chemical science, and in the following year he again lectured in Dublin, on chemistry and geology, receiving large fees at both visits. During his second visit Trinity College conferred upon him the honorary degree of LL.D., the only university distinction he ever received. On the 8th of April 1812 he was knighted by the prince regent; on the 9th he gave his farewell lecture as professor of chemistry at the Royal Institution; and on the 11th he was married to Mrs Apreece, daughter and heiress of Charles Kerr of Kelso, and a distant connexion of Sir Walter Scott. A few months after his marriage he published the first and only volume of his *Elements of Chemical Philosophy*, with a dedication to his wife, and was also re-elected professor of chemistry at the Royal Institution, though he would not pledge himself to deliver lectures, explaining that he wished to be free from the routine of lecturing in order to have more time for original work. Towards the end of the year he began to investigate chloride of nitrogen, which had just been discovered by P. L. Dulong, but was obliged to suspend his inquiries during the winter on account of injury to his eye caused by an explosion of that substance. In the spring of 1813 he was engaged on the chemistry of fluorine, and though he failed to isolate the element, he reached accurate conclusions regarding its nature and properties. In October he started with his wife for a continental tour, and with them, as "assistant in experiments and writing," went Michael Faraday, who in the previous March had been engaged as assistant in the Royal Institution laboratory. Having obtained permission from the French emperor to travel in France, he went first to Paris, where during his two months' stay every honour was accorded him, including election as a corresponding member of the first class of the Institute. He does not, however, seem to have reciprocated the courtesy of his French hosts, but gave offence by the brusqueness of his manner, though his supercilious bearing, according to his biographer, Dr Paris, was to be ascribed less to any conscious superiority than to an "ungraceful timidity which he could never conquer." Nor was his action in regard to iodine calculated to conciliate. That substance, recently discovered in Paris, was attracting the attention of French chemists when he stepped in and, after a short examination with his portable chemical laboratory, detected its resemblance to chlorine and pronounced it an "undecomposed body." Towards the end of December he left for Italy. At Genoa he investigated the electricity of the torpedo-fish, and at Florence, by the aid of the great burning-glass in the Accademia del Cimento, he effected the combustion of the diamond in oxygen and decided that, beyond containing a little hydrogen, it consisted of pure carbon. Then he went to Rome and Naples and visited Vesuvius and Pompeii, called on Volta at Milan, spent the summer in Geneva, and returning to Rome occupied the winter with an inquiry into the composition of ancient colours.

A few months after his return, through Germany, to London in 1815, he was induced to take up the question of constructing a miner's safety lamp. Experiments with samples of fire-damp sent from Newcastle soon taught him that "explosive mixtures

of mine-damp will not pass through small apertures or tubes"; and in a paper read before the Royal Society on the 9th of November he showed that metallic tubes, being better conductors of heat, were superior to glass ones, and explained that the heat lost by contact with a large cooling surface brought the temperature of the first portions of gas exploded below that required for the firing of the other portions. Two further papers read in January 1816 explained the employment of wire gauze instead of narrow tubes, and later in the year the safety lamps were brought into use in the mines. A large collection of the different models made by Davy in the course of his inquiries is in the possession of the Royal Institution. He took out no patent for his invention, and in recognition of his disinterestedness the Newcastle coal-owners in September 1817 presented him with a dinner-service of silver plate.<sup>1</sup>

In 1818, when he was created a baronet, he was commissioned by the British government to examine the papyri of Herculaneum in the Neapolitan museum, and he did not arrive back in England till June 1820. In November of that year the Royal Society, of which he had become a fellow in 1803, and acted as secretary from 1807 to 1812, chose him as their president, but his personal qualities were not such as to make him very successful in that office, especially in comparison with the tact and firmness of his predecessor, Sir Joseph Banks. In 1821 he was busy with electrical experiments and in 1822 with investigations of the fluids contained in the cavities of crystals in rocks. In 1823, when Faraday liquefied chlorine, he read a paper which suggested the application of liquids formed by the condensation of gases as mechanical agents. In the same year the admiralty consulted the Royal Society as to a means of preserving the copper sheathing of ships from corrosion and keeping it smooth, and he suggested that the copper would be preserved if it were rendered negatively electrical, as would be done by fixing "protectors" of zinc to the sheathing. This method was tried on several ships, but it was found that the bottoms became extremely foul from accumulations of seaweed and shellfish. For this reason the admiralty decided against the plan, much to the inventor's annoyance, especially as orders to remove the protectors already fitted were issued in June 1825, immediately after he had announced to the Royal Society the full success of his remedy.

In 1826 Davy's health, which showed signs of failure in 1823, had so declined that he could with difficulty indulge in his favourite sports of fishing and shooting, and early in 1827, after a slight attack of paralysis, he was ordered abroad. After a short stay at Ravenna he removed to Salzburg, whence, his illness continuing, he sent in his resignation as president of the Royal Society. In the autumn he returned to England and spent his time in writing his *Salmonia or Days of Flyfishing*, an imitation of *The Compleat Angler*. In the spring of 1828 he again left England for Illyria, and in the winter fixed his residence at Rome, whence he sent to the Royal Society his "Remarks on the Electricity of the Torpedo," written at Trieste in October. This, with the exception of a posthumous work, *Consolations in Travel, or the Last Days of a Philosopher* (1830), was the final production of his pen. On the 20th of February 1829 he suffered a second attack of paralysis which rendered his right side quite powerless, but under the care of his brother, Dr John Davy (1791-1868), he rallied sufficiently to be removed to Geneva, where he died on the 29th of May.

Of a sanguine, somewhat irritable temperament, Davy displayed characteristic enthusiasm and energy in all his pursuits. As is shown by his verses and sometimes by his prose, his mind was highly imaginative; the poet Coleridge declared that if he "had not been the first chemist, he would have been the first poet

<sup>1</sup> Davy's will directed that this service, after Lady Davy's death, should pass to his brother, Dr John Davy, on whose decease, if he had no heirs who could make use of it, it was to be melted and sold, the proceeds going to the Royal Society "to found a medal to be given annually for the most important discovery in chemistry anywhere made in Europe or Anglo-America." The silver produced £736, and the interest on that sum is expended on the Davy medal, which was awarded for the first time in 1877, to Bunsen and Kirchhoff for their discovery of spectrum analysis.

of his age," and Southey said that "he had all the elements of a poet; he only wanted the art." In spite of his ungainly exterior and peculiar manner, his happy gifts of exposition and illustration won him extraordinary popularity as a lecturer, his experiments were ingenious and rapidly performed, and Coleridge went to hear him "to increase his stock of metaphors." The dominating ambition of his life was to achieve fame, but though that sometimes betrayed him into petty jealousy, it did not leave him insensible to the claims on his knowledge of the "cause of humanity," to use a phrase often employed by him in connexion with his invention of the miners' lamp. Of the smaller observances of etiquette he was careless, and his frankness of disposition sometimes exposed him to annoyances which he might have avoided by the exercise of ordinary tact.

See Dr J. A. Paris, *The Life of Sir Humphry Davy* (1831), vol. ii. of which on pp. 450-456 gives a list of his publications. Dr John Davy, *Memoirs of Sir Humphry Davy* (1836); *Collected Works* (with shorter memoir, 1839); *Fragmentary Remains, Literary and Scientific* (1858). T. E. Thorpe, *Humphry Davy, Poet and Philosopher* (1896).

**DAWARI**, or **DAURI**, a Pathan tribe on the Waziri border of the North-West Frontier Province of India. The Dawaris inhabit the Tochi Valley (*q.v.*), otherwise known as Dawar or Daur, and are a homogeneous tribe of considerable size, numbering 5200 fighting men. Though surrounded on all four sides by a Waziri population they bear little resemblance to Waziris. They are an agricultural and the Waziris a pastoral race, and they are much richer than their neighbours. They thrive on a rich sedimentary soil copiously irrigated in the midst of a country where cultivable land of any kind is scarce and water in general hardly to be obtained. But they pay a heavy tax in health and well-being for the possession of their fertile acres. Fevers and other ravaging diseases are bred in the wet sodden lands of the Tochi Valley, lying at the bottom of a deep depression exposed to the burning rays of the sun; and the effects of these ailments may be clearly traced in the drawn or bloated features and the shrunken or swollen limbs of nearly every Dawari that has passed middle life. They have an evil name for indolence, drug-eating and unnatural vices, and are morally the lowest of the Afghan races; but in spite of these defects, and of the contempt with which they are regarded by the other Afghan tribes, they have held their own for centuries against the warlike and hardy Waziris. The secret of this is that the Dawaris stand together, and the Waziris do not, while the weaker race is gifted with infinite patience and tenacity of purpose. With the advent of British government, however, the Dawaris are now secured in the possession of their ancestral lands.

See J. G. Lorimer, *Grammar and Vocabulary of Waziri Pushtu* (1902).

**DAWES, HENRY LAURENS** (1816-1903), American lawyer, was born at Cummington, Massachusetts, on the 30th of October 1816. After graduating at Yale in 1839, he taught for a time at Greenfield, Mass., and also edited *The Greenfield Gazette*. In 1842 he was admitted to the bar and began the practice of law at North Adams, where for a time he conducted *The Transcript*. He served in the Massachusetts House of Representatives in 1848-1849 and in 1852, in the state Senate in 1850, and in the Massachusetts constitutional convention in 1853. From 1853 to 1857 he was United States district attorney for the western district of Massachusetts; and from 1857-1875 he was a Republican member of the national House of Representatives. In 1875 he succeeded Charles Sumner as senator from Massachusetts, serving until 1893. During this long period of legislative activity he served in the House on the committees on elections, ways and means, and appropriations, took a prominent part in the anti-slavery and reconstruction measures during and after the Civil War, in tariff legislation, and in the establishment of a fish commission and the inauguration of daily weather reports. In the Senate he was chairman of the committee on Indian affairs, and gave much attention to the enactment of laws for the benefit of the Indians. On leaving the Senate, in 1893, he became chairman of the Commission to the Five Civilized Tribes (sometimes called the Dawes Indian Commission),

and served in this capacity for ten years, negotiating with the tribes for the extinction of the communal title to their land and for the dissolution of the tribal governments, with the object of making the tribes a constituent part of the United States.<sup>1</sup> Dawes died at Pittsfield, Mass., on the 5th of February 1903.

**DAWES, RICHARD** (1708-1766), English classical scholar, was born in or near Market Bosworth. He was educated at the town grammar school under Anthony Blackwall, and at Emmanuel College, Cambridge, of which society he was elected fellow in 1731. His peculiar habits and outspoken language made him unpopular. His health broke down in consequence of his sedentary life, and it is said that he took to bell-ringing at Great St Mary's as a restorative. He was a bitter enemy of Bentley, who he declared knew nothing of Greek except from indexes. In 1738 Dawes was appointed to the mastership of the grammar school, Newcastle-on-Tyne, combined with that of St Mary's hospital. From all accounts his mind appears to have become unhinged; his eccentricities of conduct and continual disputes with his governing body ruined the school, and finally, in 1749, he resigned his post and retired to Heworth, where he chiefly amused himself with boating. He died on the 21st of March 1766. Dawes was not a prolific writer. The book on which his fame rests is his *Miscellanea critica* (1745), which gained the commendation of such distinguished continental scholars as L. C. Valckenaer and J. J. Reiske. The *Miscellanea*, which was re-edited by T. Burgess (1781), G. C. Harles (1800) and T. Kidd (1817), for many years enjoyed a high reputation, and although some of the "canons" have been proved untenable and few can be accepted universally, it will always remain an honourable and enduring monument of English scholarship.

See J. Hodgson, *An Account of the Life and Writings of Richard Dawes* (1828); H. R. Luard in *Dict. of Nat. Biog.*; J. E. Sandys, *Hist. of Classical Scholarship*, ii. 415.

**DAWISON, BOGUMIL** (1818-1872), German actor, was born at Warsaw, of Jewish parents, and at the age of nineteen went on the stage. In 1839 he received an appointment to the theatre at Lemberg in Galicia. In 1847 he played at Hamburg with marked success, was from 1849 to 1854 a member of the Burg theatre in Vienna, and then became connected with the Dresden court theatre. In 1864 he was given a life engagement, but resigned his appointment, and after starrng through Germany visited the United States in 1866. He died in Dresden on the 1st of February 1872. Dawison was considered in Germany an actor of a new type; a leading critic wrote that he and Marie Seebach "swept like fresh gales over dusty tradition, and brushing aside the monotony of declamation gave to their rôles more character and vivacity than had hitherto been known on the German stage." His chief parts were Mephistopheles, Franz Moor, Mark Antony, Hamlet, Charles V., Richard III. and King Lear.

**DAWKINS, WILLIAM BOYD** (1838- ), English geologist and archaeologist, was born at Buttington vicarage near Welshpool, Montgomeryshire, on the 26th of December 1838. Educated at Rossall School and Oxford, he joined the Geological Survey in 1862, and in 1869 became curator of the Manchester museum, a post which he retained till 1890. He was appointed professor of geology and palaeontology in Owens College, Manchester, in 1874. He paid special attention to the question of the existence of coal in Kent, and in 1882 was selected by the Channel tunnel committee to make a special survey of the French and English coasts. He was also employed in the scheme of a tunnel beneath the Humber. His chief distinctions, however, were won in the realms of anthropology by his researches into the lives of the cave-dwellers of prehistoric times, labours which have borne fruit in his books *Cave-hunting* (1874); *Early Man in Britain* (1880); *British Pleistocene Mammalia* (1866-1887). He became a Fellow of the Royal Society in 1867, and acted as president of the anthropological section of the British Association in 1882 and of the geological section in 1888.

<sup>1</sup> The commission completed its labours on the 1st of July 1905, after having allotted 20,000,000 acres of land among 90,000 Indians and absorbed the five Indian governments into the national system. The "five tribes" were the Cherokee, Chickasaw, Choctaw, Creek and Seminole Indians.



**DAWLISH**, a watering-place in the Ashburton parliamentary division of Devonshire, England, on the English Channel, near the outflow of the Exe, 12 m. S. of Exeter by the Great Western railway. Pop. of urban district (1901) 4003. It lies on a cove sheltered by two projecting headlands. A small stream which flows through the town is lined on both sides by pleasure-grounds. Dawlish owes its prosperity to the visitors attracted, in spring and early summer, by the warm climate and excellent bathing. An annual pleasure fair is held on Easter Monday, and a regatta in August or September. Until its sale in the 19th century, the site of Dawlish belonged to Exeter cathedral, having been given to the chapter by Leofric, bishop of Exeter, in 1050.

**DAWN** (the 16th-century form of the earlier "dawning" or "dawning," from an old verb "daw," O. Eng. *dagian*, to become day; cf. Dutch *dagen*, and Ger. *lagen*), the time when light appears (daws) in the sky in the morning. The dawn colours appear in the reverse order of the sunset colours and are due to the same cause. When the sun is lowest in both cases the colour is deep red; this gradually changes through orange to gold and brilliant yellow as the sun approaches the horizon. These colours follow each other in order of refrangibility, reproducing all the colours of the spectrum in order except the blue rays which are scattered in the sky. The colours of the dawn are purer and colder than the sunset colours since there is less dust and moisture in the atmosphere and less consequent sifting of light rays.

**DAWSON, GEORGE** (1821-1876), English nonconformist divine, was born in London on the 24th of February 1821, and was educated at Marischal College, Aberdeen, and at the university of Glasgow. In 1843 he accepted the pastorate of the Baptist church at Rickmansworth, and in 1844 a similar charge at Mount Zion, Birmingham, where he attracted large congregations by his eloquence and his unconventional views. Desiring freedom from any definite creed, he left the Baptist church and became minister of the "Church of the Saviour," a building erected for him by his supporters. Here he exercised a stimulating and varied ministry for nearly thirty years, gathering round him a congregation of all types and especially of such as found the dogmas of the age distasteful. He had much sympathy with the Unitarian position, but was not himself a Unitarian. Indeed he had no fixed standpoint, and discussed truths and principles from various aspects. His sermons, though not particularly speculative, were unconventional and quickening. He was the friend of Carlyle and Emerson, and did much to popularize their teachings, his influence being conspicuous, especially in his demand for a high ethical standard in everyday life and his insistence on the Christianization of citizenship. He was warmly supported by Dr R. W. Dale, and by J. T. Bunce, editor of *The Birmingham Daily Post*. Both Dawson and Dale were disqualified as ministers from seats on the town council, but both served on the Birmingham school board. Dawson also lectured on English literature at the Midland Institute and helped to found the Shakespeare Memorial library in Birmingham. He died suddenly at King's Norton on the 30th of November 1876. Four volumes of *Sermons*, two of *Prayers* and two of *Biographical Lectures* were published after his death.

See *Life* by H. W. Crosskey (1876) and an article by R. W. Dale in *The Nineteenth Century* (August 1877).

**DAWSON, SIR JOHN WILLIAM** (1820-1899), Canadian geologist, was born at Pictou, Nova Scotia, on the 30th of October 1820. Of Scottish descent, he went to Edinburgh to complete his education, and graduated at the university in 1842, having gained a knowledge of geology and natural history from Robert Jameson. On his return to Nova Scotia in 1842 he accompanied Sir Charles Lyell on his first visit to that territory. Subsequently he was appointed to the post of superintendent of education (1850-1853); at the same time he entered zealously into the geology of the country, making a special study of the fossil forests of the coal-measures. From these strata, in company with Lyell (during his second visit) in 1852, he obtained the first remains of an "air-breathing reptile" named *Dendropteron*. He also described the fossil plants of the Silurian,

Devonian and Carboniferous rocks of Canada for the Geological Survey of that country (1871-1873). From 1855 to 1893 he was professor of geology and principal of M'Gill University, Montreal, an institution which under his influence attained a high reputation. He was elected F.R.S. in 1862. When the Royal Society of Canada was constituted he was the first to occupy the presidential chair, and he also acted as president of the British Association at its meeting at Birmingham in 1886, and of the American Association for the Advancement of Science. Sir William Dawson's name is especially associated with the *Eozoon canadense*, which in 1864 he described as an organism having the structure of a foraminifer. It was found in the Laurentian rocks, regarded as the oldest known geological system. His views on the subject were contested at the time, and have since been disproved, the so-called organism being now regarded as a mineral structure. He was created C.M.G. in 1881, and was knighted in 1884. In his books on geological subjects he maintained a distinctly theological attitude, declining to admit the descent or evolution of man from brute ancestors, and holding that the human species only made its appearance on this earth within quite recent times. Besides many memoirs in the *Transactions* of learned societies, he published *Acadian Geology: The geological structure, organic remains and mineral resources of Nova Scotia, New Brunswick, and Prince Edward Island* (1855; ed. 3, 1878); *Air-breathers of the Coal Period* (1863); *The Story of the Earth and Man* (1873; ed. 6, 1880); *The Dawn of Life* (1875); *Fossil Men and their Modern Representatives* (1880); *Geological History of Plants* (1888); *The Canadian Ice Age* (1894). He died on the 20th of November 1899.

His son, **GEORGE MERCER DAWSON** (1840-1901), was born at Pictou on the 1st of August 1840, and received his education at M'Gill University and the Royal School of Mines, London, where he had a brilliant career. In 1873 he was appointed geologist and naturalist to the North American boundary commission, and two years later he joined the staff of the geological survey of Canada, of which he became assistant director in 1883, and director in 1895. He was in charge of the Canadian government's Yukon expedition in 1887, and his name is permanently written in Dawson City, of gold-bearing fame. As one of the Bering Sea Commissioners he spent the summer of 1891 investigating the facts of the seal fisheries on the northern coasts of Asia and America. For his services there, and at the subsequent arbitration in Paris, he was made a C.M.G. He was elected F.R.S. in 1891, and in the same year was awarded the Bigsby medal by the Geological Society of London. He was president of the Royal Society of Canada in 1893. He died on the 2nd of March 1901. He was the author of many scientific papers and reports, especially on the surface geology and glacial phenomena of the northern and western parts of Canada.

**DAWSON CITY**, or **DAWSON**, the capital of the Yukon territory, Canada, on the right bank of the Yukon river, and in the middle of the Klondyke gold region, of which it is the distributing centre. It is situated in beautiful mountainous country, 1400 ft. above the sea, and 1500 m. from the mouth of the Yukon river. It is reached by a fleet of river steamers, and has telegraphic communication. Founded in 1896, its population soon reached over 20,000 at the height of the gold rush; in 1901 it was officially returned as 9142, and is now not more than 5000. The temperature varies from 90° F. in summer to 50° below zero in winter. It possesses three opera-houses and numerous hotels, and is a typical mining town, though even at first there was much less lawlessness than is usually the case in such cities.

**DAX**, a town of south-western France, capital of an arrondissement in the department of Landes, 92 m. S.S.W. of Bordeaux, on the Southern railway between that city and Bayonne. Pop. (1906) 8585. The town lies on the left bank of the Adour, a stone bridge uniting it to its suburb of Le Sablar on the right bank. It has remains of ancient Gallo-Roman fortifications, now converted into a promenade. The most remarkable building in the town is the church of Notre-Dame, once a cathedral; it was rebuilt from 1656 to 1719, but still preserves a sacristy, a porch and a fine sculptured doorway of the 13th century. The

church of St Vincent, to the south-west of the town, derives its name from the first bishop, whose tomb it contains. The church of St. Paul-lès-Dax, a suburb on the right bank of the Adour, belongs mainly to the 15th century, and has a Romanesque apse adorned with curious bas-reliefs. On a hill to the west of Dax stands a tower built in memory of the sailor and scientist Jean Charles Borda, born there in 1733; a statue was erected to him in the town in 1891. Dax, which is well known as a winter resort, owes much of its importance to its thermal waters and mud-baths (the deposit of the Adour), which are efficacious in cases of rheumatism, neuralgia and other disorders. The best-known spring is the Fontaine Chaude, which issues into a basin 160 ft. wide in the centre of the town. The principal of numerous bathing establishments are the Grands Thermes, the Bains Salés, adjoining a casino, and the Baignots, which fringe the Adour and are surrounded by gardens. Dax has a sub-prefecture, tribunals of first instance and of commerce, a communal college, a training college and a library. It has salt workings, tanneries, saw-mills, manufactures of soap and corks; commerce is chiefly in the pine wood, resin and cork of the Landes, in mules, cattle, horses and poultry.

Dax (*Aquae Tarbellicae*, *Aquae Augustae*, later *D'Acqs*) was the capital of the Tarbelli under the Roman domination, when its waters were already famous. Later it was the seat of a viscounty, which in the 11th century passed to the viscounts of Béarn, and in 1177 was annexed by Richard Cœur de Lion to Gascony. The bishopric, founded in the 3rd century, was in 1801 attached to that of Aire.

**DAY, JOHN** (1574-1640?), English dramatist, was born at Cawston, Norfolk, in 1574, and educated at Ely. He became a sizar of Caius College, Cambridge, in 1592, but was expelled in the next year for stealing a book. He became one of Henslowe's playwrights, collaborating with Henry Chettle, William Haughton, Thomas Dekker, Richard Hathway and Wentworth Smith, but his almost incessant activity seems to have left him poor enough, to judge by the small loans, of five shillings and even two shillings, that he obtained from Henslowe. The first play in which Day appears as part-author is *The Conquest of Brute, with the finding of the Bath* (1598), which, with most of his journeyman's work, is lost. A drama dealing with the early years of the reign of Henry VI., *The Blind Beggar of Bednal Green* (acted 1600, printed 1659), written in collaboration with Chettle, is his earliest extant work. It bore the sub-title of *The Merry Humor of Tom Strowd, the Norfolk Yeoman*, and was so popular that second and third parts, by Day and Haughton, were produced in the next year. *The Ile of Guls* (printed 1606), a prose comedy founded upon Sir Philip Sidney's *Arcadia*, contains in its light dialogue much satire to which the key is now lost, but Mr Swinburne notes in Manasses's burlesque of a Puritan sermon a curious anticipation of the eloquence of Mr Chadband in *Bleak House*. In 1607 Day produced, in conjunction with William Rowley and George Wilkins, *The Travailes of the Three English Brothers*, which detailed the adventures of Sir Thomas, Sir Anthony and Robert Shirley.

*The Parliament of Bees* is the work on which Day's reputation chiefly rests. This exquisite and unique drama, or rather masque, is entirely occupied with "the doings, the births, the wars, the wooings" of bees, expressed in a style at once most singular and most charming. The bees hold a parliament under Prorex, the Master Bee, and various complaints are preferred against the humble-bee, the wasp, the drone and other offenders. This satirical allegory of affairs ends with a royal progress of Oberon, who distributes justice to all. The piece contains much for which parallel passages are found in Dekker's *Wonder of a Kingdom* (1636) and Samuel Rowley's (or Dekker's) *Noble Soldier* (printed 1634). There is no earlier known edition of *The Parliament of Bees* than that in 1641, but a persistent tradition has assigned the piece to 1607. In 1608 Day published two comedies, *Law Trickes, or Who Would have Thought it?* and *Humour out of Breath*. The date of his death is unknown, but an elegy on him by John Tatham, the city poet, was published in 1640. The six dramas by John Day which we possess show

a delicate fancy and dainty inventiveness all his own. He preserved, in a great measure, the dramatic tradition of John Lyly, and affected a kind of subdued euphuism. *The Maydes Metamorphosis* (1600), once supposed to be a posthumous work of Lyly's, may be an early work of Day's. It possesses, at all events, many of his marked characteristics. His prose *Peregrinatic Scholastica* or *Learnings Pilgrimage*, dating from his later years, was printed by Mr A. H. Bullen from a MS. of Day's. Considerations partly based on this work have suggested that he had a share in the anonymous *Pilgrimage to Parnassus* and the *Return from Parnassus*. The beauty and ingenuity of *The Parliament of Bees* were noted and warmly extolled by Charles Lamb; and Day's work has since found many admirers.

His works, edited by A. H. Bullen, were printed at the Chiswick Press in 1881. The same editor included *The Maydes Metamorphosis* in vol. i. of his *Collection of Old Plays*. *The Parliament of Bees* and *Humour out of Breath* were printed in *Nero and other Plays* (Mermaid Series, 1888), with an introduction by Arthur Symons. An appreciation by Mr A. C. Swinburne appeared in *The Nineteenth Century* (October 1897).

**DAY, THOMAS** (1748-1789), British author, was born in London on the 22nd of June 1748. He is famous as the writer of *Sandford and Merton* (1783-1789), a book for the young, which, though quaintly didactic and often ridiculous, has had considerable educational value as inculcating manliness and independence. Day was educated at the Charterhouse and at Corpus Christi College, Oxford, and became a great admirer of J. J. Rousseau and his doctrine of the ideal state of nature. Having independent means he devoted himself to a life of study and philanthropy. His views on marriage were typical of the man. He brought up two foundlings, one of whom he hoped eventually to marry. They were educated on the severest principles, but neither acquired the high quality of stoicism which he had looked for. After several proposals of marriage to other ladies had been rejected, he married an heiress who agreed with his ascetic programme of life. He finally settled at Ottershaw in Surrey and took to farming on philanthropic principles. He had many curious and impracticable theories, among them one that all animals could be managed by kindness, and while riding an unbroken colt he was thrown near Wargrave and killed on the 28th of September 1789. His poem *The Dying Negro*, published in 1773, struck the keynote of the anti-slavery movement. It is also obvious from his other works, such as *The Devoted Legions* (1776) and *The Desolation of America* (1777), that he strongly sympathized with the Americans during their War of Independence.

**DAY** (O. Eng. *dæg*, Ger. *Tag*; according to the *New English Dictionary*, "in no way related to the Lat. *dies*"), in astronomy, the interval of time in which a revolution of the earth on its axis is performed. Days are distinguished as solar, sidereal or lunar, according as the revolution is taken relatively to the sun, the stars or the moon. The solar day is the fundamental unit of time, not only in daily life but in astronomical practice. In the latter case, being determined by observations of the sun, it is taken to begin with the passage of the mean sun over the meridian of the place, or at mean noon, while the civil day begins at midnight. A vigorous effort was made during the last fifteen years of the 19th century to bring the two uses into harmony by beginning the astronomical day at midnight. In some isolated cases this has been done; but the general consensus of astronomers has been against it, the day as used in astronomy being only a measure of time, and having no relation to the period of daily repose. The time when the day shall begin is purely a matter of convenience. The present practice being the dominant one from the time of Ptolemy until the present, it was felt that the confusion in the combination of past and present astronomical observations, and the doubts and difficulties in using the astronomical ephemerides, formed a decisive argument against any change.

The question of a possible variability in the length of the day is one of fundamental importance. One necessary effect of the tidal retardation of the earth's rotation is gradually to increase this length. It is remarkable that the discussion of

ancient eclipses of the moon, and their comparison with modern observations, show only a small and rather doubtful change, amounting perhaps to less than one-hundredth of a second per century. As this amount seems to be markedly less than that which would be expected from the cause in question, it is probable that some other cause tends to accelerate the earth's rotation and so to shorten the day. The moon's apparent mean motion in longitude seems also to indicate slow periodic changes in the earth's rotation; but these are not confirmed by transits of Mercury, which ought also to indicate them. (See MOON and TIDES.) (S. N.)

**Legal Aspects.**—In law, a day may be either a *dies naturalis* or natural day, or a *dies artificialis* or artificial day. A natural day includes all the twenty-four hours from midnight to midnight. Fractions of the day are disregarded to avoid dispute, though sometimes the law will consider fractions, as where it is necessary to show the first of two acts. In cases where action must be taken for preserving or asserting a right, a day would mean the natural day of twenty-four hours, but on the other hand, as in cases of survivorship, for testamentary or other purposes, it would suffice if a person survived for even the smallest portion of the last day necessary.

When a statute directs any act to be done within so many days, these words mean *clear days*, i.e. a number of perfect intervening days, not counting the terminal days: if the statute says nothing about Sunday, the days mentioned mean consecutive days and include Sundays. Under some statutes (e.g. the Parliamentary Elections Act 1868, the Corrupt and Illegal Practices Prevention Act 1883) Sundays and holidays are excluded in reckoning days, and consequently all the Sundays, &c., of a prescribed sequence of days would be eliminated. So also, by custom, the word "day" may be understood in some special sense. In bills of lading and charter parties, when "days" or "running days" are spoken of without qualification, they usually mean consecutive days, and Sundays and holidays are counted, but when there is some qualification, as where a charter party required a cargo "to be discharged in fourteen days," "days" will mean *working days*. Working days, again, vary in different ports, and the custom of the port will decide in each case what are working days. In English charter parties, unless the contrary is expressed, Christmas day and other recognized holidays are included as working days. A *weather working day*, a term sometimes used in charter parties, means a day when work is not prevented by the weather, and unless so provided for, a day on which work was rendered impossible by bad weather would still be counted as a working day. *Lay days*, which are days given to the charterer in a charter party either to load or unload without paying for the use of the ship, are days of the week, not periods of twenty-four hours.

**Days of Grace.**—When a bill of exchange is not payable at sight or on demand, certain days (called days of grace, from being originally a gratuitous favour) are added to the time of payment as fixed by the bill, and the bill is then due and payable on the last day of grace. In the United Kingdom, by the Bills of Exchange Act 1882, three days are allowed as days of grace, but when the last day of grace falls on Sunday, Christmas day, Good Friday or a day appointed by royal proclamation as a public fast or thanksgiving day, the bill is due and payable on the preceding business day. If the last day of grace is a bank holiday (other than Christmas day or Good Friday), or when the last day of grace is a Sunday, and the second day of grace is a bank holiday, the bill is due and payable on the succeeding business day. Days of grace (*dies non*) are in existence practically among English-speaking peoples only. They were abolished by the French Code (Code de Commerce, Liv. i. tit. 8, art. 135), and by most, if not all, of the European codes since framed.

**Civil Days.**—An artificial or civil day is, to a certain extent, difficult to define; it "may be regarded as a convenient term to signify all the various kinds of 'day' known in legal proceedings other than the natural day" (*Ency. English Law*, tit. "Day"). The Jews, Chaldeans and Babylonians began the day at the rising of the sun; the Athenians at the fall; the

Umhri in Italy began at midday; the Egyptians and Romans at midnight; and in England, the United States and most of the countries of Europe the Roman civil day still prevails, the day usually commencing as soon as the clock begins to strike 12 P.M. of the preceding day.

In England the period of the civil day may also vary under different statutes. In criminal law the day formerly commenced at sunrise and extended to sunset, but by the Larceny Act 1861 the day is that period between six in the morning and nine in the evening. The same period of time comprises a day under the Housing of the Working Classes Act 1885 and the Public Health (London) Act 1891, but under the Public Health (Scotland) Act 1897 "day" is the period between 9 A.M. and 6 P.M. By an act of 1845, regulating the labour of children in print-works, "day" is defined as from 6 A.M. to 10 P.M. Daytime, within which distress for rent must be made, is from sunrise to sunset (*Tulton v. Darke*, 1860, 2 L.T. 361). An obligation to pay money on a certain day is theoretically discharged if the money is paid before midnight of the day on which it falls due, but custom has so far modified this that the law requires reasonable hours to be observed. If, for instance, payment has to be made at a bank or place of business, it must be within business hours.

When an act of parliament is expressed to come into operation on a certain day, it is to be construed as coming into operation on the expiration of the previous day (Interpretation Act 1889, § 36; Statutes [Definition of Time] Act 1880).

Under the orders of the supreme court the word "day" has two meanings. For purposes of personal service of writs, it means any time of the day or night on week-days, but excludes the time from twelve midnight on Saturday till twelve midnight on Sunday. For purposes of service not required to be personal, it means before six o'clock on any week-day except Saturday, and before 2 P.M. on Saturday.

**Closed Days**, i.e. Sunday, Christmas day and Good Friday, are excluded from all fixtures of time less than six days: otherwise they are included, unless the last day of the time fixed falls on one of those days (R.S.C., O. lxxiv.).

**American Practice.**—In the United States a day is the space of time between midnight and midnight. The law pays no regard to fractions of a day except to prevent injustice. A "day's work" is by statute in New York fixed at eight hours for all employees except farm and domestic servants, and for employees on railroads at ten hours (Laws 1897, ch. 415). In the recording acts relating to real property, fractions of a day are of the utmost importance, and all deeds, mortgages and other instruments affecting the property, take precedence in the order in which they were filed for record. Days of grace are abolished in many of the seventeen states in which the Negotiable Instruments law has been enacted. Sundays and public holidays are usually excluded in computing time if they are the last day within which the act was to be done. General public holidays throughout the United States are Christmas, Thanksgiving (last Thursday in November) and Independence (July 4th) days and Washington's birthday (February 22nd). The several states have also certain local public holidays. (See also MONTH: TIME.) (T. A. I.)

**DAYLESFORD**, a town of Talbot county, Victoria, Australia. 74 m. by rail N.W. of Melbourne. Pop. (1901) 3384. It lies on the flank of the Great Dividing Range, at an elevation of 2030 ft. On Wombat Hill are beautiful public gardens commanding extensive views, and a fine convent of the Presentation Order. Much wheat is grown in the district, and gold-mining, both quartz and alluvial, is carried on. Daylesford has an important mining school. Near the town are the Hephurn mineral springs and a number of beautiful waterfalls, and 6 m. from it is Mount Franklin, an extinct volcano.

**DAYTON**, a city of Campbell county, Kentucky, U.S.A., on the S. bank of the Ohio river, opposite Cincinnati, and adjoining Bellevue and Newport, Ky. Pop. (1890) 4264; (1900) 6104 including 65 foreign-born and 63 negroes; (1910) 6970. It is served by the Chesapeake & Ohio railway at Newport, of which it is a suburb, largely residential. It has manufactories of watch-cases

and pianos, and whisky distilleries. In the city is the Speers Memorial hospital. Dayton was settled and incorporated in 1849.

**DAYTON**, a city and the county-seat of Montgomery county, Ohio, U.S.A., at the confluence of Wolf Creek, Stillwater river and Mad river with the Great Miami, 57 m. N.N.E. of Cincinnati and about 70 m. W.S.W. of Columbus. Pop. (1890) 61,220; (1900) 85,333; (1910) 116,577. In 1900 there were 10,053 foreign-born and 3387 negroes; of the foreign-born 6820 were Germans and 1253 Irish. Dayton is served by the Erie, the Cleveland, Cincinnati, Chicago & St. Louis, the Pittsburg, Cincinnati, Chicago & St. Louis, the Cincinnati, Hamilton & Dayton, and the Dayton & Union railways, by ten interurban electric railways, centring here, and by the Miami & Erie Canal. The city extends more than 5 m. from E. to W., and 3½ m. from N. to S., lies for the most part on level ground at an elevation of about 740 ft. above sea-level, and numerous good, hard gravel roads radiate from it in all directions through the surrounding country, a fertile farming region which abounds in limestone, used in the construction of public and private buildings. Among the more prominent buildings are the court-house—the portion first erected being designed after the Parthenon—the Steele high school, St. Mary's college, Notre Dame academy, the Memorial Building, the Arcade Building, Reibold Building, the Algonquin Hotel, the post office, the public library (containing about 75,000 volumes), the Young Men's Christian Association building and several churches. At Dayton are the Union Biblical seminary, a theological school of the United Brethren in Christ, and the publishing house of the same denomination. By an agreement made in 1907 the school of theology of Ursinus College (Collegeville, Pennsylvania; the theological school since 1898 had been in Philadelphia) and the Heidelberg Theological seminary (Tiffin, Ohio) united to form the Central Theological seminary of the German Reformed Church, which was established in Dayton in 1908. The boulevard and park along the river add attractiveness to the city. Among the charitable institutions are the Dayton state hospital (for the insane), the Miami Valley and the St. Elizabeth hospitals, the Christian Deaconess, the Widows' and the Children's homes, and the Door of Hope (for homeless girls); and 1 m. W. of the city is the central branch of the National Home for disabled volunteer soldiers, with its beautifully ornamented grounds; about 1 sq. m. in extent. The Mad river is made to furnish good water-power by means of a hydraulic canal which takes its water through the city, and Dayton's manufactures are extensive and varied, the establishments of the National Cash Register Company employing in 1907 about 4000 wage-earners. This company is widely known for its "welfare work" on behalf of its operatives. Baths, lunch-rooms, rest-rooms, clubs, lectures, schools and kindergartens have been supplied, and the company has also cultivated domestic pride by offering prizes for the best-kept gardens, &c. From April to July 1901 there was a strike in the already thoroughly unionized factories; complaint was made of the hectoring of union men by a certain foreman, the use in toilet-rooms of towels laundered in non-union shops (the company replied by allowing the men to supply towels themselves), the use on doors of springs not union-made (these were removed by the company), and especially the discharge of four men whom the company refused to reinstate. The company was victorious in the strike, and the factory became an "open shop." In addition to cash registers, the city's manufactured products include agricultural implements, clay-working machinery, cotton-seed and linseed oil machinery, filters, turbines, railway cars (the large Barney-Smith car works employed 1800 men in 1905), carriages and wagons, sewing-machines (the Davis Sewing Machine Co.), automobiles, clothing, flour, malt liquors, paper, furniture, tobacco and soap. The total value of the manufactured product, under the "factory system," was \$31,015,293 in 1900 and \$39,596,773 in 1905. Dayton's site was purchased in 1795 from John Cleves Symmes by a party of Revolutionary soldiers, and it was laid out as a town in 1796 by Israel Ludlow (one of the owners), by whom it was named in honour of Jonathan Dayton (1750-1824), a soldier in the War of

Independence, a member of Congress from New Jersey in 1791-1799, and a United States senator in 1799-1805. It was made the county-seat in 1803, was incorporated as a town in 1805, grew rapidly after the opening of the canal in 1828, and in 1841 was chartered as a city.

**DEACON** (Gr. *δίακονος*, minister, servant), the name given to a particular minister or officer of the Christian Church. The status and functions of the office have varied in different ages and in different branches of Christendom.

(a) *The Ancient Church*.—The office of deacon is almost as old as Christianity itself, though it is impossible to fix the moment at which it came into existence. Tradition connects its origin with the appointment of "the Seven" recorded in Acts vi. This connexion, however, is questioned by a large and increasing number of modern scholars, on the ground that "the Seven" are not called deacons in the New Testament and do not seem to have been identified with them till the time of Irenaeus (A.D. 180). The first definite reference to the diaconate occurs in St Paul's Epistle to the Philippians (i. 1), where the officers of the Church are described as "bishops and deacons"—though it is not unlikely that earlier allusions are to be found in 1 Cor. xii. 28 and Romans xii. 7. In the pastoral epistles the office seems to have become a permanent institution of the Church, and special qualifications are laid down for those who hold it (1 Tim. iii. 8). By the time of Ignatius (A.D. 110) the "three orders" of the ministry were definitely established, the deacon being the lowest of the three and subordinate to the bishop and the presbyters. The inclusion of deacons in the "three orders" which were regarded as essential to the existence of a true Church sharply distinguished them from the lower ranks of the ministry, and gave them a status and position of importance in the ancient Church.

The functions attaching to the office varied at different times. In the apostolic age the duties of deacons were naturally vague and undefined. They were "helpers" or "servants" of the Church in a general way and served in any capacity that was required of them. With the growth of the episcopate, however, the deacons became the immediate ministers of the bishop. Their duties included the supervision of Church property, the management of Church finances, the visitation of the sick, the distribution of alms and the care of widows and orphans. They were also required to watch over the souls of the flock and report to the bishop the cases of those who had sinned or were in need of spiritual help. "You deacons," says the Apostolical Constitutions (4th century), "ought to keep watch over all who need watching or are in distress, and let the bishop know." With the growth of hospitals and other charitable institutions, however, the functions of deacons became considerably curtailed. The social work of the Church was transferred to others, and little by little the deacons sank in importance until at last they came to be regarded merely as subordinate officers of public worship, a position which they hold in the Roman Church to-day, where their duties are confined to such acts as the following:—censing the officiating priest and the choir, laying the corporal on the altar, handing the paten or cup to the priest, receiving from him the pyx and giving it to the subdeacon, putting the mitre on the archbishop's head (when he is present) and laying his pall upon the altar.

(b) *The Church of England*.—The traditional position of the diaconate as one of the "three orders" is here maintained. Deacons may conduct any of the ordinary services in the church, but are not permitted to pronounce the absolution or consecrate the elements for the Eucharist. In practice the office has become a stepping-stone to the priesthood, the deacon corresponding to the licentiate in the Presbyterian Church. Candidates for the office must have attained the age of twenty-three and must satisfy the bishop with regard to their intellectual, moral and spiritual fitness. The functions of the office are defined in the Ordinal—"to assist the priest in divine service and specially when he ministereth the Holy Communion, to read Holy Scriptures and Homilies in the church, to instruct the youth in the catechism; to baptize in the absence of the priest, to preach if he be admitted thereto by the bishop, and furthermore to search

for the sick, poor and impotent people and intimate their estates and names to the curate."

(c) *Churches of the Congregational Order*.—In these (which of course include Baptists) the diaconate is a body of laymen appointed by the members of the church to act as a management committee and to assist the minister in the work of the church. There is no general rule as to the number of deacons, though the traditional number of seven is often kept, nor as to the frequency of election, each church making its own arrangements in this respect. The deacons superintend the financial affairs of the church, co-operate with the minister in the various branches of his work, assist in the visitation of the sick, attend to the church property and generally supervise the activities of the church.

See Thomassinus, *Vetus ac nova disciplina*, pars i. lib. i. c. 51 f. and lib. ii. c. 29 f. (Lugdunum, 1706); J. N. Seidl, *Der Diakonat in der katholischen Kirche* (Regensburg, 1884); R. Sohm, *Kirchenrecht*, i. 121-137 (Leipzig, 1892); F. J. A. Hort, *The Christian Ecclesia* (London, 1897).

**DEACONESS** (ἡ διάκονος or διακόνισσα, servant, minister), the name given to a woman set apart for special service in the Christian Church. The origin and early history of the office are veiled in obscurity. It is quite certain that from the 3rd century onward there existed in the Eastern Church an order of women, known as deaconesses, who filled a position analogous to that of deacons. They are quite distinct from the somewhat similar orders of "virgins" and "widows," who belonged to a lower plane in the ecclesiastical system. The order is recognized in the canons of the councils of Nicaea (325) and Chalcedon (451), and is frequently mentioned in the writings of Chrysostom (some of whose letters are addressed to deaconesses at Constantinople), Epiphanius, Basil, and indeed most of the more important Fathers of the 4th and 5th centuries. Deaconesses, upon entering their office, were ordained much in the same way as deacons, but the ordination conveyed no sacerdotal powers or authority. Epiphanius says quite distinctly that they were woman-elders and not priestesses in any sense of the term, and that their mission was not to interfere with the functions allotted to priests but simply to perform certain offices in connexion with the care of women. Several specimens of the ordination service for deaconesses have been preserved (see Cecilia Robinson, *The Ministry of Deaconesses*, London, 1878, appendix B, p. 197). The functions of the deaconess were as follows: (1) To assist at the baptism of women, especially in connexion with the anointing of the body which in the ancient Church always preceded immersion; (2) to visit the women of the Church in their homes and to minister to the needs of the sick and afflicted; (3) according to the Apostolical Constitutions they acted as door-keepers in the church, received women as they entered and conducted them to their allotted seats. In the Western Church, on the other hand, we hear nothing of the order till the 4th century, when an attempt seems to have been made to introduce it into Gaul. Much opposition, however, was encountered, and the movement was condemned by the council of Orange in 441 and the council of Epaone in 517. In spite of the prohibition the institution made some headway, and traces of it are found later in Italy, but it never became as popular in the West as it was in the East. In the middle ages the order fell into abeyance in both divisions of the Church, the abbess taking the place of the deaconess. Whether deaconesses, in the later sense of the term, existed before 250 is a disputed point. The evidence is scanty and by no means decisive. There are only three passages which bear upon the question at all. (i) Romans xvi. 1: Phoebe is called ἡ διάκονος, but it is quite uncertain whether the word is used in its technical sense. (ii) 1 Tim. iii. 11: after stating the qualifications necessary for deacons the writer adds, "Women in like manner must be grave—not slanderers," &c.; the Authorized Version took the passage as referring to deacons' wives, but many scholars think that by "women" deaconesses are meant. (iii) In Pliny's famous letter to Trajan respecting the Christians of Bithynia mention is made of two Christian maidservants "*quas ministræ dicebantur*"; whether *ministræ* is equivalent to *διάκονα*, as is often supposed, is dubious. On the whole the evidence does not

seem sufficient to prove the contention that an order of deaconesses—in the ecclesiastical sense of the term—existed from the apostolic age.

In modern times several attempts have been made to revive the order of deaconesses. In 1833 Pastor Fleidner founded "an order of deaconesses for the Rhenish provinces of Westphalia" at Kaiserswerth. The original aim of the institution was to train nurses for hospital work, but its scope was afterwards extended and it trained its members for teaching and parish work as well. Kaiserswerth became the parent of many similar institutions in different parts of the continent. A few years later, in 1847, Miss Sellon formed for the first time a sisterhood at Devonport in connexion with the Church of England. Her example was gradually followed in other parts of the country, and in 1898 there were over two thousand women living together in different sisterhoods. The members of these institutions do not represent the ecclesiastical deaconesses, however, since they are not ministers set apart by the Church; and the sisterhoods are merely voluntary associations of women banded together for spiritual fellowship and common service. In 1861 Bishop Tait set apart Miss Elizabeth Ferard as a deaconess by the laying on of hands, and she became the first president of the London Deaconess Institution. Other dioceses gradually adopted the innovation. It has received the sanction of Convocation, and the Lambeth Conference in 1897 declared that it "recognized with thankfulness the revival of the office of deaconess," though at the same time it protested against the indiscriminate use of the title and laid it down emphatically that the name must be restricted to those who had been definitely set apart by the bishop for the position and were working under the direct supervision and control of the ecclesiastical authority in the parish.

In addition to Miss Robinson's book cited above, see *Church Quarterly Review*, xlvii. 302 ff., art. "On the Early History and Modern Revival of Deaconesses" (London, 1899), and the works there referred to; D. Latas, *Χριστιανική Αρχαιολογία*, i. 163-171 (Athens, 1883); *Testamentum Domini*, ed. Rahmani (Mainz, 1899); L. Zacharnack, *Der Dienst der Frau in den ersten Jahrhunderten der chr. Kirche* (1902).

**DEAD SEA**, a lake in Palestine occupying the deepest part of the valley running along the line of a great "fault" that has been traced from the Gulf of Akaba (at the head of the Red Sea) to Hermon. This fracture was caused after the end of the Eocene period by the earth-movement which resulted in the raising of the whole region out of the sea. Level for level, the more ancient rocks are on the eastward side of the lake: the cretaceous limestones that surmount the older volcanic substrata come down on the western side to the water's edge, while on the eastern side they are raised between 3000 and 4000 feet above it. In the Pleistocene period the whole of this depression was filled with water forming a lake about 200 m. long north to south, whose waters were about the same level as that of the Mediterranean Sea. With the diminishing rainfall and increased temperature that followed that period the effects of evaporation gradually surpassed the precipitation, and the waters of the lake slowly diminished to about the extent which they still display.

The length of the sea is 47 m., and its maximum breadth is about 9½ m.; its area is about 340 sq. m. It lies nearly north and south. Its surface being 1289-1300 ft. below the level of the Mediterranean Sea, it has of course no outlet. It is bounded on the north by the broad valley of the Jordan; on the east by the rapidly rising terraces which culminate in the Moabite plateau, 3100 ft. above the level of the lake; on the south by the desert of the Arabah, which rises to the watershed between the Dead and the Red Sea—65½ m. from the former, 46½ from the latter; height 660 ft.—and on the west by the Judean mountains which attain a height of 3300 ft. On the east side a peninsula, El-Lisān ("the tongue"), of white calcareous marl with beds of salt and gypsum, divides the sea into two unequal parts: this peninsula is about 50 ft. high, and is connected by a narrow strip of marshland with the shore. Its northern and southern extremities have been named Cape Costigan and Cape Molyneux, in memory of two explorers who were among the first in modern times to navigate the sea and succumbed to the consequent fever and



exhaustion. North of the peninsula the lake has a maximum depth of 1278 ft.; south of it the water is nowhere more than 12 ft., and in some places only 3 ft. The surface level of the lake varies with the season, and recent observations taken on behalf of the Palestine Exploration Fund seem to show that there are probably cyclical variations also (ultimately dependent on the rainfall), the nature and periodicity of which there are as yet no sufficient data to determine. In 1858 there was a small island near the north end rising 10 or 12 ft. above the surface and connected with the shore by a causeway; this has been submerged since 1892; and owing to the gradual rise of level within these years the fords south of the Lisān, and the pathway which formerly rounded the Ras Feshkhah, are now no longer passable.

The slopes on each side of the sea are furrowed with water-courses, some of them perennial, others winter torrents only. The chief affluents of the sea are as follows:—on the north, Jordan and 'Ain es-Suweimeh; on the east Wadis Ghuweir, Zerka Ma'in (Callirrhoe), Mōjib (Arnon), Ed-Dera'a, and el-Hesi; on the west, Wadis Muhawāt and Seyāl, 'Ain Jidi (En-Gedi), Wadi el Merabbah, 'Ain Ghuweir, Wadi el-Nar, 'Ain Feshkhah. The quantity of water poured daily into the sea is not less than 6,000,000 tons, all of which has to be carried off by evaporation. The consequence of the ancient evaporation, by which the great Pleistocene lake was reduced to its present modest dimensions, and of the ceaseless modern daily evaporation, is the impregnation of the waters of the lake with salts and other mineral substances to a remarkable degree. Ocean water contains on an average 4.6% of salts: Dead Sea water contains 25%. The following analysis, by Dr Bernays, gives the contents of the water more accurately:—

Specific gravity 1.1528 at 15.5° C.	
Calcium carbonate . . . . .	70.00 grains
Calcium sulphate . . . . .	163.39
Magnesium nitrate . . . . .	175.01
Potassium chloride . . . . .	1089.06
Sodium chloride . . . . .	5106.00
Calcium chloride . . . . .	594.46
Magnesium chloride . . . . .	7388.21
Magnesium bromide . . . . .	345.80
Iron and aluminium oxides . . . . .	10.50
Organic matter, water of crystallization, loss . . . . .	317.57
Total residue per gallon . . . . .	15260.00

The density of the water averages 1.166. It increases from north to south, and with the depth. The increase is at first rapid, then, after reaching a certain point, becomes more uniform. At 300 metres its density is 1.253. The boiling point is 221° F. To the quantity of solid matter suspended in its water the Dead Sea owes, beside its saltiness, its buoyancy and its poisonous properties. The human body floats on the surface without exertion. Owing principally to the large proportion of chloride and bromide of magnesia no animal life can exist in its water. Fish, which abound in the Jordan and in the brackish spring-fed lagoons that exist in one or two places around its shores (such as 'Ain Feshkhah), die in a very short time if introduced into the main waters of the lake. The only animal life reported from the lake has been some tetanus and other bacilli said to have been found in its mud; but this discovery has not been confirmed. To the chloride of calcium is due the smooth and oily feeling of the water, and to the chloride of magnesia its disagreeable taste. In Roman times curative properties were ascribed to the waters: Mukaddasi (A.D. 985) asserts that people assembled to drink it on a feast day in August. The salt of the Dead Sea is collected and sold in Jerusalem; smuggling of salt (which in Turkey is a government monopoly) is a regular occupation of the Bedouin. The bitumen which floats to shore is also collected. The origin of this bitumen is disputed: it was supposed to be derived from subaqueous strata of bituminous marl and rose to the surface when loosened by earthquakes. It is, however, now more generally believed that it exists in the breccia of some of the valleys on the west side of the lake, which is washed into the sea and

submerged, till the small stones by which it is sunk are loosened and fall out, when the bitumen rises to the surface.

*History.*—The earliest references to the sea or its basin are in the patriarchal narratives of Lot and Abraham, the most striking being the destruction of the neighbouring cities of Sodom and Gomorrah. (See Sodom.) The biblical name is the Salt Sea, the Sea of the Arabah (the south end of the Jordan valley), or the East Sea. The name in Josephus is *Asphaltites*, referring to the hituminous deposits above alluded to. The modern name is Bahr Lūt or "Sea of Lot"—a name hardly to be explained as a survival of a vague tradition of the patriarch, but more probably due to the literary influences of the Hebrew Scriptures and the Koran filtering through to the modern inhabitants or their ancestors. The name Dead Sea first appears in late Greek writers, as Pausanias and Galen. At En-Gedi on its western bank David for a while took refuge. South of it is the stronghold of Masada, built by Jonathan Maccabaeus and fortified by Herod in 42 B.C., where the last stand of the Jews was made against the Romans after the fall of Jerusalem, and where the garrison, when the defences were breached, slew themselves rather than fall into Roman hands.

The sea has been but little navigated. Tacitus and Josephus mention boats on the lake, and boats are shown upon it in the Madeba mosaic. The navigation dues formed part of the revenue of the lords of Kerak under the crusaders. In modern times navigation is practically *nil*. The lake, with the whole Jericho plain, is claimed as the personal property of the sultan.

The medieval travellers brought home many strange legends of the sea and its peculiarities—some absurd, others with a basis of fact. The absence of sea-birds, due to the absence of fish, probably accounts for the story that no birds could fly over it. The absence of vegetation on its shores, due to the scanty rainfall and general want of fresh water—except in the neighbourhood of springs like 'Ain Feshkhah and 'Ain Jidi, where a luxuriant subtropical vegetation is found—accounts for the story that no plant could live in the poisonous air which broods over the sea. The mists, due to the great heat and excessive evaporation, and the noxious miasmata, especially of the southern region, were exaggerated into the noisome vapours that the "black and stinking" waters ever exhaled. The judgment on Sodom and Gomorrah (which of course they believed to be *under* the waters of the lake, in accordance with the absurd theory first found in Josephus and still often repeated) blinded these good pilgrims to the ever-fresh beauty of this most lovely lake, whose blue and sparkling waters lie deep between rocks and precipices of unsurpassable grandeur. The play of brilliant colours and of ever-changing contrasts of light and shade on those rugged mountain-sides and on the surface of the sea itself might have been expected to appeal to the most prosaic. The surface of the sea is generally smooth (seldom, however, absolutely inert as the pilgrims represented it), but is frequently raised by the north winds into waves, which, owing to the weight and density of the water, are often of great force.

The first to navigate the sea in modern times was an Irish traveller, Costigan by name, in August and September 1835. Owing largely to the folly of his Greek servant, who, without his master's knowledge, threw overboard the drinking-water to lighten the boat, the explorer after circumnavigating the sea reached Jericho in an exhausted condition, and was there attacked by a severe fever. The greatest difficulty was experienced in obtaining assistance for him, but he was ultimately conveyed on camel-back to Jerusalem, where he died; his grave is in the Franciscan cemetery there. His fate was shared by his successor, a British naval officer, Lieutenant Molyneux (1847), whose party was attacked and robbed by Bedouins. W. F. Lynch, an American explorer (1848), equipped by the United States government, was more successful, and he may claim to be the first who examined its shores and sounded its depths. Since his time the duc de Luynes, Lartet, Wilson, Hull, Blanckenhorn, Gautier, Libbey, Masterman and Schmidt, to name but a few, have made contributions to our knowledge of this lake; but still many problems present themselves for solution. Among these may be mentioned

(1) the explanation of a remarkable line of white foam that extends along the axis of the lake almost every morning—supposed by Blanckenhorn to mark the line of a fissure, thermal and asphaltic, under the bed of the lake, but otherwise explained as a consequence of the current of the Jordan, which is not completely expended till it reaches the Lisān, or as a result of the mingling of the salt water with the brackish spring water especially along the western shore; (2) a northward current that has been observed along the east coast; (3) various disturbances of level, due possibly to differences of barometric pressure; (4) some apparently electrical phenomena that have been observed in the valley. Before we can be said to know all that we might regarding this most interesting of lakes further extensive scientific observations are necessary; but these are extremely difficult owing to the impossibility of maintaining self-registering instruments in a region practically closed to Europeans for nearly half the year by the stifling heat, and inhabited only by Bedouins, who are the worst kind of ignorant, thievish and mischievous savages. (R. A. S. M.)

**DEADWOOD**, a city and the county-seat of Lawrence county, South Dakota, U.S.A., about 180 m. W. of Pierre. Pop. (1890) 2366; (1900) 3498, of whom 707 were foreign-born; (1905, state census) 4364. It is served by the Chicago, Burlington & Quincy and the Chicago & North-Western railways. It lies on hilly ground in the canyon of Whitewood Creek at an elevation of about 4530 ft. Deadwood is the commercial centre of the Black Hills. About it are several gold mines (including the well-known Homestake mine), characterized by the low grade of their ores (which range from \$2 to \$8 per ton), by their vast quantity, and by the ease of mining and of extracting the metal. The ore contains free gold, which is extracted by the simple process of stamping and amalgamation, and refractory values, extracted by the cyaniding process. Several hundred tons of ore are treated thus in Deadwood and its environs daily, and its stamp mills are exceeded in size only by those of the Treadwell mine in S.E. Alaska, and by those on the Rand in South Africa. The discovery of gold here was made known in June 1875, and in February 1877 the United States government, after having purchased the land from the Sioux Indians, opened the place for legal settlement.

**DEAF AND DUMB.**<sup>1</sup> The term "deaf" is frequently applied to those who are deficient in hearing power in any degree, however slight, as well as to people who are unable to detect the loudest sounds by means of the auditory organs. It is impossible to draw a hard and fast line between the deaf and the hearing at any particular point. For the purposes of this article, however, that denotation which is generally accepted by educators of the deaf may be given to the term. This makes it refer to those who are so far handicapped as to be incapable of instruction by the ordinary means of the ear in a class of those possessing normal hearing. Paradoxical though it may seem, it is yet true to say that "dumbness" in our sense of the word does not, strictly speaking, exist, though the term "dumb" may, for all practical purposes, fairly be applied to many of the deaf even after they are supposed to have learnt how to speak. Oral teachers now confess that it is not worth while to try to teach more than a large percentage of the deaf to speak at all. We are not concerned with aphasia, stammering or such inability to articulate as may be due to malformation of the vocal organs. In the case of the deaf and dumb, as these words are generally understood, dumbness is merely the result of ignorance in the use of the voice, this ignorance being due to the deafness. The vocal organs are perfect. The deaf man can laugh, shout, and in fact utter any and every sound that the normal person can. But he does not speak English (if that happens to be his nationality) for the same reason that a French child does not, which is that he has never heard it. There is in fact no more a priori reason why an English

baby, born in England, should talk English than that it should talk any other language. English may be correctly described as its "mother tongue," but not its *natural* language; the only reason why one person speaks English and another Russian is that each imitated that particular language which he heard in infancy. This imitation depends upon the ability to hear. Hence if one has never heard, or has lost hearing in early childhood, he has never been able to imitate that language which his parents and others used, and the condition of so-called dumbness is added to his deafness. From this it follows that if the sense of hearing be not lost till the child has learnt to speak fluently, the ability to speak is unaffected by the calamity of deafness, except that after many years the voice is likely to become high-pitched, or too guttural, or peculiar in some other respect, owing to the absence of the control usually exercised by the ear. It also follows that, to a certain extent, the art of speech can be taught the deaf person even though he were born deaf. Theoretically, he is capable of talking just as well as his hearing brother, for the organs of speech are as perfect in one as in the other, except that they suffer from lack of exercise in the case of the deaf man. Practically, he can never speak perfectly, for even if he were made to attempt articulation as soon as he is discovered to be deaf, the fact that the ear, the natural guide of the voice, is useless, lays upon him a handicap which can never be wiped out. He can never hear the tone of his teacher's voice nor of his own; he can only see small and, in many instances, scarcely discernible movements of the lips, tongue, nose, cheeks and throat in those who are endeavouring to teach him to speak, and he can never hope to succeed in speech through the instrumentality of such unsatisfactory appeals to his eye as perfectly as the hearing child can with the ideal adaptation of the voice to the ear. Sound appeals to the ear, not the eye, and those who have to rely upon the latter to imitate speech must suffer by comparison.

Deafness then, in our sense, means the incapacity to be instructed by means of the ear in the normal way, and dumbness means only that ignorance of how to speak one's mother tongue which is the effect of the deafness.

Of such deaf people many can hear sound to some extent. Dr Kerr Love quotes several authorities (*Deaf Mutism*, pp. 58 ff.) to show that 50 or 60% are absolutely deaf, while 25% can detect loud sounds such as shouting close to the ear, and the rest can distinguish vowels or even words. He himself thinks that not more than 15 or 20% are totally deaf—sometimes only 7 or 8%; that ability to hear speech exists in about one in four, while ten or fifteen in each hundred are only semi-deaf. He rightly warns against the use of tuning forks or other instruments held on the bones of the head as tests of hearing, because the vibration which is felt, not heard, may very often be mistaken for sound.

Dr Edward M. Gallaudet, president of the Columbia Institution for the Deaf in Washington, D.C., suggests the following terms for use in dividing the whole class of the deaf into its main sections, though it is obviously impossible to split them up into perfectly defined subdivisions, where, as a matter of fact, you have each degree of deafness and dumbness shading into the next:—the *speaking deaf*, the *semi-speaking deaf*, the *mute deaf* (or *deaf-mute*), the *speaking semi-deaf*, the *mute semi-deaf*, the *hearing mute* and the *hearing semi-mute*. He points out that the last two classes are usually persons of feeble mental power. We should exclude these altogether from the list, since their hearing is, presumably, perfect, and should add the *semi-speaking semi-deaf* before the *mute semi-deaf*. This would give two main divisions—those who cannot hear at all, and those who have partial hearing—with three subsections in each main division—those who speak, those who have partial speech and those who do not speak at all. Where the hearing is perfect it is paradoxical to class a person with the deaf, and the dumbness in such a case is due (where there is no malformation of the vocal organs) to inability of the mind to pay attention to, and imitate, what the ear really hears. In such cases this mental weakness is generally shown in other ways besides that of not hearing sounds. Probably no sign will be given of recognizing persons or objects around; there will be,

<sup>1</sup> The two words are common to Teutonic languages, cf. Ger. *taub* and *dumm* (only in the sense of "stupid"), Dutch *doof* and *dom*; the original meaning seems to have been dull of perception, stupid, obtuse, and the words may be ultimately related. The Gr. τυφλός blind, and τῆφος, smoke, mist, probably show the same base.

in fact, a general incapacity of the whole body and senses. It is incorrect to designate such persons as deaf and feeble-minded or deaf and idiotic, because in many cases their organs of hearing are as perfect as are other organs of their body, and they are no more deaf than blind, though they may pay no attention to what they hear any more than to what they see. They are simply weak in intellect, and this is shown by the disuse of any and all of their senses; hence it is incorrect to classify them according to one, and one only, of the evidences of this mental weakness.

*Extent of Deafness.*—The following table shows the number of deaf and dumb persons in the United Kingdom at successive censuses:—

YEAR.	NUMBER OF DEAF AND DUMB PERSONS.			
	United Kingdom.	England & Wales.	Scotland.	Ireland.
1851	17,649	10,314	2155	5180
1861	20,224	12,236	2335	5653
1871	19,159	11,518	2087	5554
1881	20,573	13,295	2142	5136
1891	20,781	14,192	2125	4464
1901	21,855	15,246	2638	3971

From this we find that the proportion of deaf and dumb to the population has been as follows:—

YEAR.	PROPORTION OF DEAF AND DUMB TO THE POPULATION.			
	United Kingdom.	England & Wales.	Scotland.	Ireland.
1851	1 in 1550	1 in 1739	1 in 1340	1 in 1264
1861	1 in 1430	1 in 1639	1 in 1310	1 in 1025
1871	1 in 1642	1 in 1972	1 in 1610	1 in 974
1881	1 in 1694	1 in 1953	1 in 1745	1 in 1008
1891	1 in 1814	1 in 2040	1 in 1893	1 in 1053
1901	1 in 1897	1 in 2132	1 in 1694	1 in 1122

There has, therefore, been on the whole a steady decrease of those described as "deaf and dumb" in proportion to the population in Great Britain and Ireland. But in the census for 1901, in addition to the 15,246 returned as "deaf and dumb" in England and Wales, 18,507 were entered as being "deaf," 2433 of whom were described as having been "deaf from childhood."

Mr B. H. Payne, the principal of the Royal Cambrian Institution, Swansea, makes the following remarks upon these figures:—

"The natural conclusion, of course, is that there has been a large increase, relative as well as absolute, of the class in which we are interested, which we call the deaf, and which includes the deaf and dumb. Indeed, the number, large as it is, cannot be considered as complete, for the schedules did not require persons who were only deaf to state their infirmity, and, though many did so, it may be presumed that more did not."

"On the other hand, circumstances exist which may reasonably be held to modify the conclusion that there has been a large relative increase of the deaf. The spread of education, the development of local government, and an improved system of registration, may have had the effect of procuring fuller enumeration and more appropriate classification than heretofore, while 1368 persons described simply as dumb, and who therefore probably belong, not to the deaf, but to the feeble-minded and aphasic classes, are included in the 'deaf and dumb' total. It is also to be noted that some of those who described themselves as 'deaf' though not born so may have been educated in the ordinary way before they lost their hearing, and are therefore outside the sphere of the operation of schools for the deaf."

"In connexion with the census of 1891, it has been remarked in the report of the institution that no provision was made in the schedules for distinguishing the congenital from the non-congenital deaf, and that it was desirable to draw such a distinction. To ascertain the relative increase or decrease of one or the other section of the class would contribute to our knowledge of the incidence of known causes of deafness or to the confirmation or discovery of other causes, and so far indicate the appropriate measures of prevention, while such an inquiry as that recommended has, besides, a certain bearing upon educational views."

"The exact number of 'deaf and dumb' and 'deaf' children who are of school age cannot be ascertained from the census tables, which give the numbers in quinquennial age-groups, while the school age is seven to sixteen. It is a pity that in this respect the functions of the census department are not co-ordinated with those of the Board of Education."

Dr John Hitz, the superintendent of the Volta Bureau for the Increase of Knowledge Relating to the Deaf, Washington, D.C., U.S.A., gives the number of schools for deaf children, and pupils, in different countries in 1900 as follows:—

### AFRICA.

Country.	Schools.	Teachers.	Pupils.
Algeria	1	3	37
Egypt	1	2	6
Cape Colony	4	9 <sup>1</sup>	77
Natal	1	2	7
	7	16 <sup>1</sup>	127

### ASIA.

Country.	Schools.	Teachers.	Pupils.
China	3	10	43
India	3	13	73
Japan	3	24	337
	9	47	453

### AUSTRALASIA.

Country.	Schools.	Teachers.	Pupils.
Australia	6	41	282
New Zealand	1	5	50
	7	46	332

### EUROPE.

Country.	Schools.	Teachers.	Pupils.
Austria-Hungary	38	291	2440
Belgium	12	181	1265
Denmark	5	57	348
France	71	598	4098
Germany	99	798	6497
Great Britain	95	462	4222
Italy	47	234	2519
Luxemburg	1	3	22
Netherlands	3	74	473
Norway	5	54	309
Portugal	2	9	64
Rumania	1	3	46
Russia, Finland, Livonia	34	118	1719
Servia	2	2 <sup>1</sup>	26 <sup>1</sup>
Spain	11	60	462
Sweden	9	124	726
Switzerland	14	84	650
Turkey	1		
	450	3152	25,886

### NORTH AMERICA.

Country.	Schools.	Teachers.	Pupils.
Canada	7	130	768
United States	126	1347	10,946
Mexico	1	13	46
Cuba	1		
	135	1490	11,760

### SOUTH AMERICA.

Country.	Schools.	Teachers.	Pupils.
Argentine	4	18	133
Brazil	1	9	35
Chile	1	7	61
Uruguay	1		
	7	34	229

<sup>1</sup> Incomplete.

## SUMMARY.

Continent.	Schools.	Teachers.	Pupils.
Africa	7	16	127
Asia	9	47	453
Australia	7	46	332
Europe	450	3152	25,886
North America	135	1490	11,760
South America	7	34	229
	615	4785	38,787

These figures refer only to deaf children who are actually under instruction, not to the whole deaf population.

While it is gratifying to find that so much is being done in the way of educating this class of the community, the number of schools in most parts of the world is still lamentably inadequate. For instance, taking the school age as from seven to sixteen, which is now made compulsory by Act of Parliament in Great Britain, and assuming that 20% of the deaf population are of that age, as they are in England, there should be 40,000 deaf pupils under instruction in India alone, whereas there are but seventy-three. There are 200,000 deaf of all ages in India. And what an enormous total should be in schools in China instead of forty-three! The whole of the rest of Asia, with the exception of Japan, has apparently not a single school. There must be many thousands of thousands of deaf (hundreds of thousands, if not thousands of thousands of whom are of school age) in that continent, unless indeed they are destroyed, which is not impossible. What are we to say of Africa, where only 100 pupils are being taught; of South America, with its paltry 200, and Australia's 300? To come to Europe itself, Russia should have many times more pupils than her 1700. Even in Great Britain the education of the deaf was not made compulsory till 1893, and there are many still evading the law and growing up uneducated. Mr Payne of Swansea estimated (*Institution Report, 1903-1904*) from the 1901 census, that there must be approximately 204 deaf of school age in South Wales and Monmouthshire, while only 144 were accounted for in all the schools in that district according to Dr Hitz's statistics.

Dr Kerr Love (*Deaf Mutism, p. 217*) gives the following table, which shows the number of deaf people in proportion to the population in the countries named:—

Switzerland	1 in	408
Austria	"	765
Hungary	"	792
Sweden	"	977
Prussia	"	981
Finland	"	981
Canada	"	1003
Norway	"	1052
Germany (exclusive of Prussia)	"	1074
Portugal	"	1333
Ireland	"	1398 <sup>1</sup>
India	"	1459
United States	"	1514
Denmark	"	1538
Greece	"	1548
France	"	1600
Italy	"	1862
Scotland	"	1885 <sup>1</sup>
Cape Colony	"	1904
England	"	2043 <sup>1</sup>
Spain	"	2178
Belgium	"	2247
Australasia	"	2692
Holland	"	2985
Ceylon	"	4328

According to a tabular statement of British and Colonial schools, June 1899, the proportion of those born deaf to those who lost hearing after birth was, at that time and in those countries, 2126 to 1251, as far as returns had been made. Several schools had, however, failed to give statistics. These figures show a proportion of nearly 59% congenitally deaf persons to over 41% whose deafness is acquired. Professor Fay, whose monumental work, *Marriages of the Deaf in America*, deserves particular attention, mentions (p. 38) that of 23,931 persons who attended American schools for the deaf up to the year 1890, 9842, or 41%, were reported as congenitally deaf, and 14,089, or 59%, as adventitiously deaf,—figures which exactly reverse those just quoted. The classification of deafness acquired in infancy with congenital deafness by some other authorities (giving rise to the rather absurd term "toto-congenital" to describe the latter) is unscientific. There is reason for the opinion that the non-congenital, even when hearing has been lost in early infancy, acquire language better, and it is a mistake from any point of view to include them in the born deaf.

<sup>1</sup> The figures for England, Scotland and Ireland, according to the 1901 census, are different and have been given above.

Other statistics vary very much as to the proportion of born deaf, some being as low as a quarter, and some as high as three-quarters, of the whole class. We can only say, speaking of both sides of the Atlantic, and counterbalancing one period with another, that the general average appears to be about 50% for each. Probably the percentage varies in different places for definite reasons, which we shall now briefly consider.

*Causes of Deafness.*—These may be considered in two divisions, pre-natal and post-natal.

1. *Pre-Natal.*—A small percentage of these is due, it seems, to malformation of some portion of the auditory apparatus. Another percentage is known to represent the children of the intermarriage of blood relations. Dr Kerr Love (*Deaf Mutism, p. 117*) gives statistics from thirteen British institutions which show that on a general average at least 8% of the congenitally deaf are the offspring of such marriages. Besides this, little is known. Beyond all doubt a much larger percentage of deaf children are the offspring of marriages in which one or both partners were born deaf than of ordinary marriages. But inquiries into such phenomena have generally been directed towards tracing deafness and not consanguinity, or at least the inquirer has rarely troubled to make sure whether the grandparents or great-grandparents on either side were relations or not. Such investigations rarely go beyond ascertaining if the parents were related to each other, though we have proof that a certain tendency towards any particular abnormality may not exhibit itself in every generation of the family in question. To give an illustration, suppose that G is a deaf man. Several inquirers may trace back to the preceding generation F, and to the grandparents E, and even to the great-grandparents D, in search of an ancestor who is deaf, and such they may discover in the third generation D. But probably not one of these several inquirers will ask G if any of his grandparents or great-grandparents married a cousin, for instance, though they may ask if his father did. To continue this hypothetical case, the investigators will again trace back along the family tree to generations C, B and A in search of an original deaf ancestor, on whose shoulders they seek to lay the blame of both D's and G's deafness. Not finding any such, they will again content themselves with asking if D's parents (generation C) were blood relations or not, and, receiving an answer in the negative, desist from further inquiry in this direction, assuming that D's deafness is the original cause of G's deafness. They do not, we fear, inquire if any grandparents or great-grandparents (hearing people) were related, with the same persistency as they ask if any were deaf. The search for deafness is pushed through several generations, the search for consanguinity is only extended to one generation. Perhaps if it were carried further, it would be discovered that A married his niece, and there lay the secret of the deafness in both D and G. In other words, the deafness in D is not the cause of that in G, but the deafness in both D and G are effects of the consanguineous marriage in A. All this is, however, merely by way of suggestion. We submit that if deafness in one generation may be followed by deafness two or even three generations later, while the tendency to deafness exists, but does not appear, in the intermediate generations, it is only logical to inquire if deafness in the first discoverable instance in a family may not be caused by consanguinity, the effect of which is not seen for two or three generations in a similar manner. Moreover it is probable that consanguinity in parents or grandparents may often be denied. An exhaustive investigation along these lines is desirable, for we believe that congenital deafness would be proved to be due to consanguinity in hearing people, if the search were pushed far enough back and the truth were told, in a far greater percentage of cases than is now suspected. This is not disproved by quoting numbers of cases where no deafness follows consanguinity in any generation, for resulting weakness may be shown (where it exists) in many other ways than by deafness.

This theory receives support from the statistics quoted by Dr Kerr Love (*Deaf Mutism, p. 132*), where the percentage of defective children resulting from the consanguineous marriages of hearing people increases in almost exact proportion to the nearness of affinity of the parents. It is further borne out by



statistics of the duchy of Nassau, and of Berlin, both quoted by Dr Kerr Lové (pp. 119, 120). These show 1 deaf person in 1397 Roman Catholics, 1 for Evangelicals and 508 Jews in the former case, and 1 in 3000 Roman Catholics, 2000 Protestants and 400 Jews in the latter. When we are told that "Roman Catholics prohibit marriages between persons who are near blood relations, Protestants view such marriages as permissible, and Jews encourage intermarriage with blood relations," these figures become suggestive. We find the same greater tendency to deafness in thinly-populated and out-of-the-way districts and countries where, owing to the circle of acquaintances being limited, people are more likely to marry relations.

With regard to the question of marriages of the deaf, Professor Edward Allen Fay's work is so complete that the results of his six years' labour are particularly worthy of notice, for, as the introduction states, the book is a "collection of records of marriages of the deaf far larger than all previous collections put together," and it deals in detail with 4471 such marriages. The summary of statistics is as follows (*Marriages of the Deaf in America*, p. 134):—

MARRIAGES OF THE DEAF.	NUMBER OF MARRIAGES.		NUMBER OF CHILDREN.		PERCENTAGE.	
	Total.	Resulting in deaf offspring.	Total.	Deaf.	Marriages resulting in deaf offspring.	Deaf children.
One or both partners deaf	3078	300	6782	588	9.7	8.6
Both partners deaf	2377	220	5072	429	9.2	8.4
One partner deaf, the other hearing	599	75	1532	151	12.5	9.8
One or both partners congenitally deaf	1477	194	3401	413	13.1	12.1
One or both partners adventitiously deaf	2212	124	4701	199	5.6	4.2
Both partners congenitally deaf	335	83	779	202	24.7	25.9
One partner congenitally deaf, the other adventitiously deaf	814	66	1820	119	8.1	6.5
Both partners adventitiously deaf	845	30	1720	40	3.5	2.3
One partner congenitally deaf, the other hearing	191	28	528	63	14.6	11.9
One partner adventitiously deaf, the other hearing	310	10	713	16	3.2	2.2
Both partners had deaf relatives	437	103	1060	222	23.5	20.9
One partner had deaf relatives, the other had not	541	36	1210	78	6.6	6.4
Neither partner had deaf relatives	471	11	1044	13	2.3	1.2
Both partners congenitally deaf; both had deaf relatives	172	49	429	130	28.4	30.3
Both partners congenitally deaf; one had deaf relatives, the other had not	49	8	105	21	16.3	20.0
Both partners congenitally deaf; neither had deaf relatives	14	1	24	1	7.1	4.1
Both partners adventitiously deaf; both had deaf relatives	57	10	114	15	17.5	9.6
Both partners adventitiously deaf; one had deaf relatives, the other had not	167	7	357	10	4.1	2.8
Both partners adventitiously deaf; neither had deaf relatives	284	2	550	2	0.7	0.3
Partners consanguineous	31	14	100	30	45.1	30.0

One point deserves special attention in the above list. It is that where there are no deaf relatives (i.e. where there has not been a history of deafness in the family) only one child out of twenty-four is deaf, even when the parents were both born deaf themselves. Where there were deaf relatives already in the family on both sides, and the parents were born deaf, the percentage of deaf children is seven and a half times as great. This seems to show that there are causes of congenital deafness which are, comparatively speaking, unlikely to be transmitted to future generations, while other causes of congenital deafness are so liable to be perpetuated that one child in every three is deaf. We conjecture that one original cause of congenital deafness which reappears in a family is consanguinity—for instance, the intermarriage of first or second cousins (hearing people) in some previous generation. Out of the 2245 deaf persons who were born deaf, 269 had parents who were blood relations, according to Fay. And perhaps many more refrained from acknowledging the fact. Eleven had grandparents who were cousins. This theory calls for investigation, and while the marriage of deaf people is not encouraged, it is fair to ask those who so strenuously oppose such unions whether they may not be spending their energies on trying to check an effect instead of a cause, and if that cause may not really be consanguinity,—witness the percentage of deaf people among Roman Catholics, Protestants and Jews before noticed. On the principle that prevention is better than cure it is the intermarriage of cousins and other relations which should be discouraged. The marriage of deaf people is inadvisable where there has been deafness in the family in former generations, but the same warning applies to all the other members of that family, for the hearing members are as likely to transmit the defect of which deafness is a symptom as the deaf members are. We are more concerned to discover the primary cause of the defect, and take steps to prevent the latter from occurring at all. Those who have no dissuasions for hearing people, who might perhaps cause the misery, and only give counsel to those among the transmitters of it who happen to be deaf, are acting in a manner which is hardly logical.

2. *Post-Natal*.—We have collected and grouped the stated causes of deafness in those partners of the marriages in America noticed by Fay. About a hundred and thirty did not mention how they lost hearing. Any errors in this calculation must be less than 1% at most, and can make no material difference. In some cases two or more diseases are given as the cause of deafness. In such cases where one is a very common cause of deafness, and the other is unusual, the former is credited with being the reason for the defect. Where both are common, we have divided the cases between them in a rough proportion.

Scarlet fever	973	scarlatina	3	scarlet rash	2	978		
Spotted fever	260	meningitis	92	spinal meningitis	76			
		cerebro-spinal meningitis	70	spinal fever	28	spinal disease	8	
		congestion of spine	2			536		
Brain fever	309	inflammation of brain	62	congestion of brain	30	disease in brain	3	
						404		
Typhoid	127	"fever" (unspecified)	117	typhus	17	intermittent fever	14	
		bilious fever	11	other fevers	14		300	
Gatherings, inflammations, in head; ulcers, disease, sores, risings, &c., all but 22 being explicitly stated to be in head or ears							276	
"Sickness" 167; "illness" 49; "disease" 8; no definite specification 12							236	
Measles							191	
Colds 101; colds in head, &c. 35; catarrh 19; catarrhal fevers 10; chills, &c. 17							182	
Whooping cough 77; diphtheria 34; lung fever, and various diseases of lungs and throat 60							171	
Falls							143	
Fits and convulsions 58; spasms 18; teething 16							92	
Scrofula 35; mumps 25; swellings on neck 2							62	
Many various and unusual causes							60	
Smallpox 8; chickenpox 6; cholera, &c. 7; canker, &c. 11; erysipelas 13							45	
Paralysis, &c. 12; nerve diseases 12; fright 8; palsy 3							35	
Hydrocephalus 14; dropsy on brain or in head 17; dropsy 2							33	
Various accidents, blows, kicks, &c.							31	
Quinine 22; other medicines 7							29	
							Total	3804

We have counted a hundred and thirty of those who were returned as having lost hearing who were also stated to be the offspring of consanguineous marriages.



Dr Kerr Love (*Deaf Mutism*, p. 150) gives the following list compiled from the registers of British institutions:—

Scarlet fever . . . . .	331
Miscellaneous causes . . . . .	175
Teething, convulsions, &c. . . . .	171
Meningitis, brain fever, &c. . . . .	166
Measles . . . . .	138
Falls and accidents . . . . .	122
Enteric and other fevers . . . . .	119
Disease, illness, &c. . . . .	37
Whooping cough . . . . .	33
Suppurative ear diseases . . . . .	18
Syphilis . . . . .	2
	1312
Unknown causes . . . . .	98

The same writer quotes Hartmann's table, compiled in 1880 from continental statistics, as follows:—

Cerebral affections, inflammations, convulsions . . . . .	644
Cerebro-spinal meningitis . . . . .	295
Typhus . . . . .	260
Scarlatina . . . . .	205
Measles . . . . .	84
Ear disease, proper . . . . .	77
Lesions of the head . . . . .	70
Other diseases . . . . .	354
	1989

There appears to be no cure for deafness that is other than partial; but with the advance of science preventive treatment is expected to be efficacious in scarlet fever, measles, &c.

#### *Condition of the Deaf.*

1. *In Childhood.*—It is difficult to impress people with two facts in connexion with teaching language to the average child who was born deaf, or lost hearing in early infancy. One is the necessity of the undertaking, and the other is that this necessity is not due to mental deficiency in the pupil. To the born deaf-mute in an English-speaking country English is a foreign language. His inability to speak is due to his never having heard that tongue which his mother uses. The same reason holds good for his entire ignorance of that language. The hearing child does not know a word of English when he is born, and never would learn it if taken away from where it is spoken. He learns English unconsciously by imitating what he hears. The deaf child never hears English, and so he never learns it till he goes to school. Here he has to start learning English—or whatever is the language of his native land—in the same way as a hearing boy learns a foreign language.

But another reason exists which renders his task much more difficult than that of a normal English schoolboy learning, say, German. The latter has two channels of information, the eye and the ear; the deaf boy has only one, the eye. The hearing boy learns German by what he hears of it in class as well as by reading it; the deaf boy can only learn by what he sees. It is as if you tried to fill two cisterns of the same capacity with two inlets to one and only one inlet to the other; supposing the inlets to be the same size, the former will fill twice as fast. So it is in the case of the hearing boy as compared with his deaf brother. The cerebral capacity and quality are the same, but in one case one of the avenues to the brain is closed, and consequently the development is less rapid. Moreover, the thoughts are precisely those which would be expected in people who form them only from what they see. We were often asked by our deaf playmates in our childhood such questions (in signs) as "What does the cat say?"—"The dog talks, does he not?"—"Is the rainbow very hot on the roof of that house?" They have often told us such things as that they used to think someone went to the end of the earth and climbed up the sky to light the stars, and to pour down rain through a sieve.

But there is yet a third disadvantage for the already handicapped deaf boy. He has no other language to build upon, while the other has his mother tongue with which to compare the foreign language he is learning. The latter already has a general idea of sentences and clauses, of tense and mood, of gender,

number and case, of substantives, verbs and prepositions; and he knows that one language must form some sort of parallel to another. He is already prepared to find a subject, predicate and object, in the sentence of a foreign language, even when he knows not a word of any but his own mother tongue. If he is told that a certain word in German is an adjective, he understands what its function is, even when he has yet to learn the meaning of the word. All this goes for nothing in the case of the deaf pupil. The very elementary fact that certain words denote certain objects—that there is such a class of word as substantives—comes as a revelation to most deaf children. They have to begin at seven laboriously and artificially to learn what an ordinary baby has unconsciously and naturally discovered at the age of two. English, spoken, written, printed or finger-spelled, is no more natural, comprehensible or easy of acquirement to the deaf than is Chinese. The manual alphabet is simply one way of expressing the vernacular on the fingers; it is no more the deaf-mute's "natural" language than speech or writing, and if he cannot express himself by the latter modes of communicating, he cannot by spelling on the fingers. The last is simply a case of *vicaria lingue manus*. None of these are languages in themselves; whether you use pen or type, hand or voice, you are but adopting one or other method of expressing one and the same tongue—English or whatever it may be, that of a "people of a strange speech and of a hard language, whose words they cannot understand." The deaf child's natural mode of communication—more natural to him than any verbal language is to hearing people—is the world-wide, natural language of signs.

2. *Natural Language of the Deaf.*—We have just called signs a natural language. While a purist might properly object to this adjective being applied to all signs, yet it is not an unfair term to use as regards this method of conversing as a whole, even in the United States, where signs, being to a great extent the French signs invented by de l'Épée, are more artificial than in England. The old story, by the way, of the pupil of de l'Épée failing to write more than "hand, breast," as describing what an incredulous investigator did when he laid his hand on his breast, proves nothing. In all probability he had no idea that he was expected to describe an action, and thought that he was being asked the names of certain parts of the body. The hand was held out to him and he wrote "hand." Then the breast was indicated by placing the hand on it, and he wrote "breast." Moreover, the artificial element is much less pronounced than is supposed by most of those who are loudest in their condemnation of signs, there being almost invariably an obvious connexion between the sign and idea. These critics are generally people whose acquaintance with the subject is rather limited, and the thermometer of whose zeal in waging war against gestures generally falls in proportion as the photometer of their knowledge about them shows an increasing light. We may go still further and point out that to object to any sign on the ground of artificiality *per se*, is to strain at the gnat and to swallow the camel, for English itself is one of the most artificial languages in existence, and certainly is more open to such an objection than signs. If we apply the same test to English that is applied to signs by those who would rule out any which they suppose cannot come under the head of natural gesture or pantomime, what fraction of our so-called natural language should we have left? For a spoken word to be "natural" in this sense it must be onomatopoeic, and what infinitesimal percentage of English words are such? A foreigner, unacquainted with the language, could not glean the drift of a conversation in English, except perhaps a trifle from the tone of the voices and more from the natural signs used—the smiles and frowns, the expressions of the faces, the play of eyes, lips, hands and whole body. The only words he could possibly understand without such aids are some such onomatopoeic words as the cries of animals—"mew," "chirrup," &c., and a few more like "bang" or "swish."

The reason why we insist emphatically upon the importance of teaching English in schools for the deaf in English-speaking countries, is, firstly, because that is the language which the pupil will be called upon to use in his intercourse with his fellow-men

after he leaves school, and secondly, because, if his grasp of that tongue only be sufficient and his interest in books be properly aroused, he can go on educating himself in after-life by means of reading. Time tables are overcrowded with kindergarden, clay modelling, wood-carving, carpentry, and other things which are excellent in themselves. But there is not time for everything, and these are not as important in the case of the deaf pupil as language. Putting aside the question of religion and moral training, we consider the flooding of their minds with general knowledge, and the teaching of English to enable them to express their thoughts to their neighbours, to be of paramount importance, so paramount that all other branches of education in their turn pale into insignificance by comparison with these, while the question of methods of instruction should be subservient to these main ends. Too many make speech in itself an end. This is a mistake. Speech is not in itself English; it is only one way of expressing that language. And we are little concerned to inquire by what means the deaf pupil expresses himself in English so long

“*Observations.*—People speak of ‘manual signs.’ Of course there are signs which are made with the hands only, as there are others which are labial, &c. But the sign language is comprehensive, and at times the whole frame is engaged in its use. A late American teacher could and did ‘sign’ a story to his pupils with his hands behind him. Facial expression plays an important part in the language. Sympathetic gestures are individualistic and spontaneous, and are sometimes unconsciously made. The speaker, feeling that words are inadequate, reinforces them with gesture. Arbitrary signs are, e.g., drumming with three separated fingers on the chin for ‘uncle.’ Grammatical signs are those which are used for inflections, parts of speech, or letters as in the manual alphabet, and some numerical signs, though other numerals may be classed as natural; also signs for sounds, and even labial signs. Signs, whether natural or arbitrary, which gain acceptance, especially if they are shortened, are ‘conventional.’ ‘Mimic action’ refers, e.g., to the sign for sawing, the side of one hand being passed to and fro over the side or back of the other. ‘Pantomime’ means, e.g., when the signer pretends to hang up his hat and coat, roll up his sleeves, kneel on his board, guide the saw with his thumb, saw through, wipe his forehead, &c.”

Illustrations of one style of numerical signs are given below.



FIG. 1.

as he does so express himself, whether by speech or writing or finger-spelling—for if he can finger-spell he can write. It is not the mere fact that he can make certain sounds or write certain letters or form the alphabet on his hands that should signify. It is the actual language that he uses, whatever be the means, and the thoughts that are enshrined in the language, that should be our criterion when judging of his education.

The importance of English is insisted upon because to place the deaf child in touch with his English-speaking fellow-men we must teach him their language, and also because he can thereby educate himself by means of books if, and when, he has a sufficient command of that language. The reason is not because the vernacular is actually superior to signs as a means of conversation. The sign language is quite equal to the vernacular as a means of expression. The former is as much our mother tongue, if we may say so, as the latter; we used one language as soon as the other, in our earliest infancy; and, after a lifelong experience of both, we affirm that signs are a more beautiful language than English, and provide possibilities of a wealth of expression which English does not possess, and which probably no other language possesses.

That others whose knowledge of signs is lifelong hold similar opinions is shown by the following extract from *The Deaf and their Possibilities*, by Dr Gallaudet:—

“Thinking that the question may arise in the minds of some, ‘Does the sign language give the deaf, when used in public addresses, all that speech affords to the hearing?’ I will say that my experience and observation lead me to answer with a decided affirmative. On occasions almost without number it has been my privilege to interpret, through signs to the deaf, addresses given in speech; I have addressed hundreds of assemblages of deaf persons in the college, in schools I have visited, and elsewhere, using signs for the original expression of thought; I have seen many more lectures and public debates given originally in signs; I have seen conventions of deaf-mutes in which no word was spoken, and yet all the forms of parliamentary proceedings were observed, and the most earnest, and even excited, discussions were carried on. I have seen the ordinances of religion administered, and the full service of the Church rendered in signs; and all this with the assurance growing out of my complete understanding of the language—a knowledge which dates from my earliest childhood—that for all the purposes enumerated gestural expression is in no respect inferior, and is in many respects superior, to oral, verbal utterance as a means of communicating ideas.

The following is an analysis of the sign language given by Mr Payne of the Swansea Institution, together with his explanatory notes:—

“*Analysis of the Sign Language.*”

- I. Facial expression.
  - II. Gesture {
    - 1. Sympathetic
    - 2. Representative (= Natural signs)
    - 3. Systematic {
      - (a) Arbitrary signs
      - (b) Grammatical signs
- Conventional especially in shortened form.
- III. Mimic action.
  - IV. Pantomime.

Units are signified with the palm turned inwards; tens with the palm turned outwards; hundreds with the fingers downwards; thousands with the left hand to the right shoulder; millions with the hand near the forehead. For 12, sign 10 outwards and 2 inwards, and so on up to 19. 21 = 2 outwards, 1 inwards, and so on up to 30. 146 = 1 downwards, 4 outwards, 6 inwards. 207,837 = 2 downwards, 7 inwards (both at shoulder), 8 downwards, 3 outwards, 7 inwards. 599,126,345 = 5 downwards, 9 outwards, 9 inwards (all near forehead); 1 downwards, 2 outwards, 6 inwards (all at shoulder); 3 downwards, 4 outwards, 5 inwards (in front of chest).

Only the third, and a few of the second, subdivision of the second section of the above classes of signs can be excluded when talking of signs as being the deaf-mute’s natural language. In fact we hesitate to call representative gesture—e.g. the horns and action of milking for “cow,” the smelling at something grasped in the hand for “flower,” &c.—conventional at all, except when shortened as the usual sign for “cat” is, for instance, from the sign for whiskers plus stroking the fur on back and tail plus the action of a cat licking its paw and washing its face, to the sign for whiskers only.

The deaf child expresses himself in the sign language of his own accord. The supposition that in manual or combined schools generally they “teach them signs” is incorrect, except that perhaps occasionally a few pupils may be drilled and their signs polished for a dramatic rendering of a poem at a prize distribution or public meeting, which is no more “teaching them signs” than training hearing children to recite the same poem orally and polishing their rendering of it is teaching them English. If the deaf boy meets with some one who will use gesture to him, a new sign will be invented as occasion requires by one or other to express a new idea, and if it be a good one is tacitly adopted to express that idea, and so an entire language is built up. It follows that in different localities signs will differ to a great extent, but one who is accustomed to signing can readily see the connexion and understand what is meant even when the signs are partly novel to him. We are sometimes asked if we can make a deaf child understand abstract ideas by this language. Our answer is that we can, if a hearing child of no greater age and intelligence can understand the same ideas in English. Signs are particularly the best means of conveying religious truths to the deaf. If you wish to appeal to him, to impress him, to reach his heart and his sympathies (and, incidentally, to offer the best possible substitute for music), use his own eloquent language of signs. We have conversed by signs with deaf people from all parts of the British Isles, from France, Norway and Sweden, Poland, Finland, Italy, Russia, Turkey, the United States, and found that they are indeed a world-wide means of communication,

even when we wandered on to most unusual and abstract subjects. Deaf people in America converse with Red Indians with ease thereby, which shows how natural the generality of even de l'Epée signs are. The sign language is everybody's natural language, not only the deaf-mute's.

Addison (*Deaf Mutism*, p. 283) quotes John Bulwer as follows:—"What though you (the deaf and dumb) cannot express your minds in those verbal contrivances of man's invention: yet you want not speech who have your whole body for a tongue, having a language which is more natural and significant, which is common to you with us, to wit, gesture, the general and universal language of human nature." The same writer says further on (p. 297): "The same process of growth goes on alike with the signs of the deaf and dumb as with the spoken words of the hearing. Arnold, than whom no stronger advocate of the oral method exists, recognizes this in his comment on this principle of the German school; for he writes: 'It is much to be regretted that teachers should indulge in unqualified assertions of the impossibility of deaf-mutes attaining to clear conceptions and abstract thinking by signs or mimic gestures. Facts are against them.' Again, Graham Bell, who is generally considered an opponent of the sign system, says: 'I think that if we have the mental condition of the child alone in view without reference to language, no language will reach the mind like the language of signs; it is the method of reaching the mind of the deaf child.'

The opinions of the deaf themselves, from all parts of the world, are practically unanimous on this question. In the words of Dr Smith, president of the World's Congress of the Deaf held at St Louis, Missouri, in 1904, under the auspices of the National Association of the Deaf, U.S.A., "the educated deaf have a right to be heard in these matters, and they must and shall be heard." A portion may be quoted of the resolutions passed at that congress of 570 of the best-informed deaf the world has ever seen, at least scores, if not hundreds, of them holding degrees, and being as well educated as the vast majority of teachers of the deaf in England: "Resolved, that the oral method, which withholds from the congenitally and quasi-congenitally deaf the use of the language of signs outside the school-room, robs the children of their birthright; that those champions of the oral method, who have been carrying on a warfare, both overt and covert, against the use of the language of signs by the adult deaf, are not friends of the deaf; and that, in our opinion, it is the duty of every teacher of the deaf, no matter what method he or she uses, to have a working command of the sign language."

It is often urged as an objection to the use of signs that those who use them think in them, and that their English (or other vernacular language) suffers in consequence. There is, however, no more objection to thinking in signs than to thinking in any other language, and as to the second objection, facts are against such a statement. The best-educated deaf in the world, as a class, are in America, and the American deaf sign almost to a man. It is true that at first a beginner in school may, when at a loss how to express himself in words, render his thoughts in sign-English, if we may use the expression, just as a schoolboy will sometimes put Latin words in the English order. That is, the deaf pupil puts the word in the natural order of the signs, which is really the logical order, and is much nearer the Latin sequence of words than the English. But, firstly, if he had always been forbidden to use signs he would not express himself in English any better in that particular instance; he would simply not attempt to express himself at all,—so he loses nothing, at least; and secondly, it is perfectly easy to teach him in a very short time that each language has its own idiom and that the thought is expressed in a different order in each.

Of the deaf child's moral condition nothing more need be said than that it is at first exactly that of his hearing brother, and his development therein depends entirely upon whether he is trained to the same degree. The need of this is great. He is quite as capable of religious and moral instruction, and benefits as much by what he receives of it. Happiness is a noticeable feature of the character of the deaf when they are allowed to mix with each other. The charge of bad temper can usually be sustained only when the fault is on the side of those with whom they live. For instance, the latter often talk in the presence of the deaf person without saying a word to him, and if he then shows irritation, which is not often in any case, it is no more to be wondered at than if a hearing person resents whispering or other secret communication in his presence.

3. *Social Status, &c.*—From the 1901 census "Summary Tables" we gather the following facts concerning the occupations of the deaf, aged ten and upwards, in England and Wales.

About half of the total number, taking males and females together (13,450), are engaged in occupations—6665. The rest—6785—are retired or unoccupied. Of the former, the following table given below shows the distribution:—

In general or local government work (clerks, messengers, &c.)	11
In professional occupations and subordinate services	87
In domestic offices or services	788
In commercial occupations	12
In work connected with conveyance of men, goods or messages	144
In agriculture	568
In fishing	3
In and about mines and quarries, &c.	151
In work connected with metals, machines, implements, &c.	503
In work connected with precious metals, jewels, games, &c.	46
In building and works of construction	485
In work connected with wood, furniture, fittings and decorations	470
In work connected with brick, cement, pottery and glass	153
In work connected with chemicals, oil, soap, &c.	46
In work connected with skins, hair and feathers	137
In work connected with paper, prints, books, &c.	238
In work connected with textile fabrics	407
In work connected with dress	1829
In work connected with food, tobacco, drink and lodging	194
In work connected with gas, water and electric supply, and sanitary service	22
Other general and undefined workers and dealers	371
Total	6665

Among those in professional occupations are a clergyman, five law clerks, ten schoolmasters, teachers, &c., thirty-seven painters, engravers and sculptors, and seven photographers. Of those not engaged in occupations, 235 have retired from business, and 245 are living on their own means. Probably a very large number of the remainder were out of work or engaged in odd jobs at the time of the census; it would certainly be incorrect to take the words "Without specified occupations or unoccupied" to mean that those classified as such were permanently unable to support themselves.

The commonest occupations of men are bootmaking (555), tailoring (429), farm-labouring (287), general labouring (257), carpentry (195), cabinet-making (142), painting, decorating and glazing (95), French-polishing (88), harness-making, &c. (80).

The commonest occupations of women are dressmaking (484), domestic service (367), laundry and washing service (230), tailoring (170), shirtmaking, &c. (81), charring (79).

In Munich there are about sixty deaf artists, especially painters and sculptors. In Germany and Austria generally, deaf lithographers, xylographers and photographers are well employed, as are bookbinders in Leipzig in particular, and labourers in the provinces.

In France there are several deaf writers, journalists, &c., two principals of schools, an architect, a score or so of painters, several of whom are ladies, nine sculptors, and a few engravers, photographers, proof-readers, &c.

Italy boasts deaf wood-carvers, sculptors, painters, and architects graduating from the universities and academies of fine arts with prizes and medals; also type-setters, pressmen, carvers of coral, ivory and precious stones.

Two gentlemen in the office of the Norwegian government are deaf, as are four in the engraving department of the land survey; one is a master-lithographer, another a master-printer, a third a civil engineer, and the rest are engaged in the usual trades, as are those in Sweden.

The deaf form societies of their own to guard their interests, for social intercourse and other purposes. In England there is the British Deaf and Dumb Association; in America the National Association of the Deaf and many lesser societies; Germany has no fewer than 150 such associations, some of which are athletic clubs, benefit societies, dramatic clubs, and so forth. The central Federation is the largest German association. France has the National Union of Deaf-Mutes and others, many being benefit clubs. Italy has some societies; Sweden has eight.

In the United States there are no fewer than fifty-three publications devoted to the interests of the deaf, most of them being school magazines published in the institutions themselves. Great Britain and Ireland have six, four of them being school magazines. France, Germany, Sweden, Hungary have several,

and Finland, Russia, Norway, Denmark and Austria are represented. Canada has three.

There are many Church and other missions to the deaf in England and abroad, which are much needed owing to the difficulty the average deaf person has in understanding the archaic language of both Bible and Prayer-book. Until they have this explained to them it is useless to place these books in their hands, and even where they are well-educated and can follow the services, they fail to get the sermon. Chaplains and missionaries engage in all branches of pastoral work among them, and also try to find them employment, interpret for them where necessary, and interview people on their behalf.

The difficulty of obtaining employment for the deaf has been increased in Great Britain by the Employers' Liability and Workmen's Compensation Acts, for masters are afraid—needlessly, as facts show—to employ them, under the impression that they are more liable to accidents owing to their affliction.

The new After-Care Committees of the London County Council are a late confession of a need which other bodies have long endeavoured to supply. Education should be a development of the whole nature of the child. The board of education in England provides for intellectual, industrial and physical training, but does not take cognizance of those parts of education which are far more important—the social, moral and spiritual. Some teachers, both oral and manual, do an incalculable amount of good at the cost of great self-sacrifice and in face of much discouragement. They deserve the highest praise for so doing, and such work needs to be carried on after their pupils leave school.

#### Education.

*History.*<sup>1</sup>—"Who hath made man's mouth? or who maketh a man dumb, or deaf, or seeing, or blind? Is it not I the Lord?" (Ex. iv. 11). Such is the first known reference to the deaf. But the significance of this statement was not realized by the ancients, who mercilessly destroyed all the defective, the deaf among the rest. Greek and Roman custom demanded their death, and they were thrown into the river, or otherwise killed, without causing any comment but that so many encumbrances had been removed. They were regarded as being on a mental level with idiots and utterly incapable of helping themselves. In later times Roman law forbade those who were deaf and dumb from birth to make a will or bequest, placing them under the care of guardians who were responsible for them to the state; though if a deaf person had lost hearing after having been educated, and could either speak or write, he retained his rights. Herodotus refers to a deaf son of Croesus, whom he declares to have suddenly recovered his speech upon seeing his father about to be killed. Gellius makes a similar statement with reference to a certain athlete. Hippocrates was in advance of Aristotle when he realized that deaf-mutes did not speak simply because they did not know how to; for the last-named seems to have considered that some defect of the intellect was the cause of their inability to utter articulate sounds. Pliny the elder and Massala Corvinus mention deaf-mutes who could paint.

The true mental condition of the deaf was realized, however, by few, if any, before the time of Christ. He, as He opened the ears of the deaf man and loosened his tongue, talked to him in his own language, the language of signs.

St Augustine erred amazingly when he declared that the deaf could have no faith, since "faith comes by hearing only." The Talmud, on the other hand, recognized that they could be taught, and were therefore not idiotic.

It is, however, with those who attempted to educate the deaf that we are here chiefly concerned. The first to call for notice is St John of Beverley. The Venerable Bede tells how this bishop made a mute speak and was credited with having performed a miracle in so doing. Probably it was nothing more than the first attempt to teach by the oral method, and the greatest credit is due to him for being so far in advance of his times as to try to instruct

his pupil at all. Bede himself invented a system of counting on the hands; and also a "manual speech," as he called it,—using his numerals to indicate the number of the letter of the alphabet; thus, the sign for "seven" would also signify the letter "g," and so forth. But we do not know that he intended this alphabet for the use of the deaf.

It is not until the 16th century that we hear much of anybody else who was interested in the deaf, but at this date we find Girolamo Cardan stating that they can be instructed by writing, after they have been shown the signification of words, since their mental power is unaffected by their inability to hear.

Pedro Ponce de Leon (c. 1520-1584), a Spanish Benedictine monk, is more worthy of notice, as he, to use his own words, taught the deaf "to speak, read, write, reckon, pray, serve at the altar, know Christian doctrine, and confess with a loud voice." Some he taught languages and science. That he was successful was proved by other witness than his own, for Panduro, Valles and de Morales all give details of his work, the last-named giving an account by one of Ponce's pupils of his education. De Morales says further that Ponce de Leon addressed his scholars either by signs or writing, and that the reply came by speech. It appears that this master committed his methods to writing. Though this work is lost it is probable that his system was put into practice by Juan Pablo Bonet. This Spaniard successfully instructed a brother of his master the constable of Castile, who had lost hearing at the age of two. His method corresponded in a great measure to that which is now called the combined system, for, in the work which he wrote, he shows how the deaf can be taught to speak by reducing the letters to their phonetic value, and also urges that finger-spelling and writing should be used. The connexion between all three, he goes on to say, should be shown the pupils, but the manual alphabet should be mastered first. Nouns he taught by pointing to the objects they represented; verbs he expressed by pantomime; while the value of prepositions, adverbs and interjections, as well as the tenses of verbs, he believed could be learnt by repeated use. The pupil should be educated by interrogation, conversation, and carefully graduated reading. The success of Bonet's endeavours are borne witness to by Sir Kenelm Digby, who met the teacher at Madrid.

Bonifacio's work on signs, in which he uses every part of the body for conversational purposes, may be mentioned before passing to John Bulwer, the first Englishman to treat of teaching the deaf. In his three works, *Philocophus*, *Chirologia* and *Chironomia*, he enlarges upon Sir Kenelm Digby's account, and argues about the possibility of teaching the deaf by speech. But he seems to have had no practical experience of the art.

Dr John Wallis is more important, though it has been disputed whether he was not indebted to his predecessors for some ideas. He taught by writing and articulation. He took the trouble to classify to a certain extent the various sounds, dividing both vowels and "open" consonants into gutturals, palatals and labials. The "closed" consonants he subdivided into mutes, semi-mutes and semi-vowels. Language, Wallis maintained, should be taught when the pupil had first learned to write, and the written characters should be associated with some sort of manual alphabet. Names of things should be given first, and then the parts of those things, e.g. "body" first, and then, under that, "head," "arm," "foot," &c. Then the singular and plural should be given, then possessives and possessive pronouns, followed by particles, other pronouns and adjectives. These should be followed by the copulative verb; after which should come the intransitive verb and its nominative in the different tenses, and the transitive with its object in the same way. Lastly, prepositions and conjunctions should be taught. All this, Wallis held, ought to be done by writing as well as signing, for he did not lose sight of the fact that "we must learn the pupil's language in order to teach him ours."

Dr William Holder, who read an essay before the Royal Society in 1668-1669 on the "Elements of Speech," added an appendix concerning the deaf and dumb. He describes the organs of speech and their positions in articulation, suggesting

<sup>1</sup> For our résumé of the history we are indebted solely to Arnold (*Education of Deaf Mutes, Teachers' Manual*) as far as the date of the founding of the Old Kent Road Institution.

teaching the pupil the sounds in order of simplicity, though he held that he must learn to write first. Afterwards the pupil must associate the letters with a manual alphabet. Holder notices that dumbness is due to the want of hearing, and therefore speech can be acquired through watching the lips, though he admits the task is a laborious one. He also urges the teacher to be patient and to make the work as interesting to the pupil as possible. Command of language, he maintains, will enable the deaf person to read a sentence from the lips if he gets most of the words; for he will be able to supply those he did not see, from his knowledge of English.

Johan Baptist van Helmont treated of the work of the vocal organs. Amman says that Van Helmont had discovered a manual alphabet and used it to instruct the deaf, but had not attained very good results.

George Sibscota published a work in 1670 called the *Deaf and Dumb Man's Discourse*, in which he contradicts Aristotle's opinion that people are dumb because of defects in the vocal organs; for they are, he believed, dumb because never taught to speak. They can gain knowledge by sight, he maintained; can write, converse by signs, speak and lip-read. Ramirez de Carrion also taught the deaf to speak and write, as did P. Lana Terzi.

About George Dalgarno more is known. He wrote, in 1680, his *Didascalocophus*, or *Deaf-Mute's Preceptor*, in which he makes the mistake of saying that the deaf have the advantage over the blind in opportunities for learning language. The deaf can, in his opinion, be taught to speak, and also to read the lips if the letters are very distinct. They ought to read, write and spell on the fingers constantly, but use no signs. Substantives are to be taught by associating them with the things they represent; then adjectives should be joined to them. Verbs should be taught by suiting the action to the words, and associating the pronouns with them. Other parts of speech should be given as opportunities of explaining them present themselves. Dalgarno invented an alphabet, the letters being on the joints of the fingers and palm of the left hand.

John Conrad Amman published his *Dissertatio de Loquela* in 1700. In the first chapter he treats, among other things, of the nature of the breath and voice and the organs of speech. In the second chapter he classifies sounds into vowels, semi-vowels and consonants, and a detailed description of each sound is given. The third chapter is devoted to showing how to produce and control the voice, to utter each sound from writing or from the lips, and to combine them into syllables and words. It was only after the pupil had attained to considerable success in articulation and lip-reading that Amman taught the meaning of words and language; but the name of this teacher will long stand as that of one of the most successful the world has known.

Passing over Camerarius, Schott, Kerger (who began teaching language sooner than Amman did, and depended more on writing and signs), Raphael (who instructed three deaf daughters), Lasius, Arnoldi, Lucas, Vanin, de Fay (himself deaf) and many others, we come to Giacobbo Rodriguez Pereira, the pioneer of deaf-mute education in France, if we except de Fay. Beginning his experience by instructing his deaf sister, he soon attained to considerable success with two other pupils; his chief aim being, as he said, to make them comprehend the meaning of, and express their thoughts in, language. A commission of the French Academy of Sciences, before whom he appeared, testified to the genuineness of his achievements, noticing that he wrote and signed to his pupils, and stating that he hoped to proceed to the instruction of lip-reading. Pereira soon after came under the notice of the duc de Chaulnes, whose deaf godson, Saboureux de Fontenay, became his pupil; and in five years this boy was well able to speak and read the lips. Pereira had several other pupils. Probably kindness and affection were two of the secrets of his success, for the love his scholars showed for him was unbounded. His method is only partly known, but he used a manual alphabet which indicated the pronunciation of the letters and some combinations. He used reading and writing; but signs were only called to his aid when absolutely necessary. Language he

taught by founding it on action where possible, abstract ideas being gradually developed in later stages of the education.

We now come to the abbé de l'Épée (*q.v.*). The all-important features in this teacher's character and method were his intense devotion to his scholars and their class, and the fact that he lived among them and talked to them as one of themselves. Meeting with two girls who were deaf, he started upon the task of instructing them, and soon had a school of sixty pupils, supported entirely by himself. He spared himself no expense and no trouble in doing his utmost to benefit the deaf, learning Spanish for the sole purpose of reading Bonet's work, and making this book and Amman's *Dissertatio de Loquela* his guiding lights. But de l'Épée was the first to attach great importance to signs; and he used them, along with writing, until the pupil had some knowledge of language before he passed on to articulation and lip-reading. To the latter method, however, he never paid as much attention as he did to instructing by signs and writing, and finally he abandoned it altogether through lack of time and means. He laboured long on a dictionary of signs, but never completed it. He was attacked by Pereira, who condemned his method as being detrimental, and this was the beginning of the disputes as to the merits of the different methods which have lasted to the present day; but whatever opinions we may hold as to the best means of instructing the deaf we cannot but admire the devoted teacher who spent his life and his all in benefiting this class of the community.

Samuel Heinicke first began his work in 1754 at Dresden, but in 1778 he removed to Leipzig and started on the instruction of nine pupils. His methods he kept secret; but we know that he taught orally, using signs only when he considered them helpful, and spelling only to combine ideas. He wrote two books and several articles on the subject of educating the deaf, but it is from Walther and Fornari that we learn most about his system. At first Heinicke laid stress on written language, starting with the concrete and going on to the abstract; and he only passed to oral instruction when the pupils could express themselves in fairly correct language. Subsequently, however, he expressed the opinion that speech should be the sole method of instruction, and, strange to say, that by speech alone could thoughts be fully expressed.

Henry Baker became tutor to a deaf girl in 1720, and his success led to the establishment of a private school in London. He also kept his system a secret, but recently his work on lessons for the deaf was discovered, from which we gather that he adopted writing, drawing, speech and lip-reading as his course of instruction. The point to notice is that after the primary stages Baker turned events of every-day life to use in his teaching. His pupils went about with him, and he taught by conversation upon what they saw in the streets,—an excellent method; but it is a pity that such a good teacher had not the philanthropy to make his methods known and to give the poorer deaf the benefit of them, as de l'Épée did.

A school was established in Edinburgh in 1760 by Thomas Braidwood, who taught by the oral method. He taught the sounds first, then syllables, and finally words, teaching their meaning. In 1783 Braidwood came to Hackney, whence he moved to Old Kent Road, and in 1809 there were seventy pupils in what was lately the Old Kent Road Institution. Braidwood's method was practically a development of Wallis's. We must regard him as the founder of the first public school for the deaf in England.

It was only at the beginning of the 19th century that a brighter day dawned on the deaf as a class. With the sole exception of de l'Épée no teacher had yet undertaken the instruction of a deaf child who could not pay for it. Now things began to be different. Institutions were founded, and their doors were opened to nearly all.

Dr Watson, the first principal of the Old Kent Road "Asylum," taught by articulation and lip-reading, reading and writing, explaining by signs to some extent, but using pictures much more, according to Addison, and composing a book of these for the use of his pupils. From Addison (*Deaf Mutism*, pp. 248 ff.) we learn what developments followed. In Vienna, Prague and Berlin, schools had been founded in rapid succession before



the 19th century dawned, and in 1810 the Edinburgh institution opened its doors. Nine years later the Glasgow school was established and, under the able guidance of Mr Duncan Anderson (after several other headmasters had been tried) from 1831, taught pupils whose grasp of English was equal to that of the very best educated deaf in England to-day, as has been proved by conversation with the survivors. Mr Anderson's great aim was to teach his pupils language, and we might look almost in vain for a teacher in England to succeed as well with a whole class in the beginning of the 20th century as he did in the middle of the 19th. He wrote a dictionary, used pictures and signs to explain English, and apparently paid little or no attention to most of the numerous subjects attempted to-day in schools for the deaf, which, while excellent in themselves, generally exclude what is far more important from the curriculum.

Addison further mentions Mr Baker of Doncaster, a contemporary of Anderson, as having compiled many lesson books for deaf children which came to be used in ordinary schools also, and Mr Scott of Exeter as having, together with Baker, "exercised a profound influence on the course of deaf-mute education in this country." "Written language," explained by signs where necessary, was the watchword of these teachers.

Moritz Hill is credited with being principally responsible for having evolved the German, or "pure," oral method out of the experimental stage to that at which it has arrived at the present day. Arnold of Riehen is also honourably mentioned.

The great "oral revival" now swept all before it. The German method was enthusiastically welcomed in all parts of Europe, and at the Milan conference in 1880 was almost unanimously adopted by teachers from all countries. Those in high places countenanced it; educational authorities awoke to the fact that the deaf needed special teaching, and came to the conclusion that the "pure" oral method was the panacea that would restore all the deaf to a complete equality with the hearing in any conversation upon any subject that might be broached; many governments suddenly took the deaf under the shelter of their own ample wings, and the "bottomless pocket of the ratepayer," instead of the purse of the charitable, became in many cases the fount of supply for what has been a costly and by no means entirely satisfactory experiment in the history of their education. The "pure" oral method has had a long and unique trial in England in circumstances which other methods have never enjoyed.

Meanwhile in the United States Dr Thomas Hopkins Gallaudet was elected in 1815 to go to Europe to inquire into the methods of educating the deaf in vogue there. This was at a meeting held in the house of a physician named Cogswell, in Hartford, Connecticut, and was the result of the latter's discovery that eighty-four persons in the state besides his own little girl were deaf. Henry Winter Syle, himself deaf, tells how "four months were spent in learning that the doors of the British schools were 'barred with gold, and opened but to golden keys,'" and how, disappointed in England, Gallaudet met with a ready response to his inquiries in Paris. With Laurent Clerc, a deaf teacher, he returned to the United States in 1816, and the "Connecticut Asylum" was founded a year after with seven pupils. The name was changed to "The American Asylum" later, when it was enlarged. This was followed by the Pennsylvania, New York and Kentucky institutions, with the second of which the Peet family were connected. Dr Gallaudet married one of his deaf pupils, Sophia Fowler, and, after a very happy married life, Mrs Gallaudet accompanied her youngest son, Edward Miner Gallaudet, to the Columbia institution for the Deaf and Dumb, Washington, D. C., founded in 1857 by Congress and largely supported by Amos Kendall, and to the National Deaf Mute College, which was founded in 1864, was renamed the Gallaudet College, in honour of Dr T. H. Gallaudet, in 1893, and with the Kendall School (secondary), now forms the Columbia Institution. This college is supported by Congress.

The following account of the work done at the National Deaf-Mute College at Washington is worth attention, as the results are unique, and are often strangely ignored.

Here is a statement of the course for the B.A. degree:—

First year: Algebra, grammar, punctuation, history of England, composition, Latin grammar, Caesar.

Second year: Algebra (from quadratics), geometry, composition, Caesar (Gallic War), Cicero (Orations), Allen and Greenough's *Latin Grammar*, Myer's *General History*, Goodwin's *Greek Grammar* (optional), Xenophon's *Anabasis* (optional).

Third year: Olney's or Loomis's *Plane and Spherical Trigonometry*, Loomis's *Analytical Geometry* (optional), Orton's *Zoology*, Gray's *Botany*, Remsen's *Chemistry*, laboratory practice, Virgil's *Aeneid*, Homer's *Iliad* (optional), Meiklejohn's *History of English Literature and Language* (two books), Maertz's *English Literature*, Hadley's *History*, original composition.

Fourth year: Loomis's *Calculus* (optional), Dana's *Mechanics*, Gage's *Natural Philosophy*, Young's *Astronomy*, laboratory practice, qualitative analysis, Steel's *Hygienic Physiology*, Edgren's *French Grammar*, Super's *French Reader*, *Demosthenes on the Crown* (optional), Hart's *Composition and Rhetoric*, original composition, Hill's *Jevon's Elementary Logic*.

Fifth year: Maertz's *Manual of English Literature*, Maertz's *English Literature*, original composition, Guizot's *History of Civilization*, Sheldon's *German Grammar*, Joynes's *German Reader*, Le Conte's *Geology*, Guyot's *Earth and Man*, Hill's *Elements of Psychology*, Haven's *Moral Philosophy*, Butler's *Analogy*, Bascom's *Elements of Beauty*, Perry's *Political Economy*, Gallaudet's *International Law*.

Even in 1893 we were told that of the graduates of the college "fifty-seven have been engaged in teaching, four have entered the ministry; three have become editors and publishers of newspapers; three others have taken positions connected with journalism; fifteen have entered the civil service of the government,—one of these, who had risen rapidly to a high and responsible position, resigned to enter upon the practice of law in patent cases, in Cincinnati and Chicago, and has been admitted to practise in the Supreme Court of the United States; one is the official botanist of a state, who has correspondents in several countries of Europe who have repeatedly purchased his collections, and he has written papers upon seed tests and related subjects which have been published and circulated by the agricultural department; one, while filling a position as instructor in a western institution, has rendered important service to the coast survey as a microscopist, and one is engaged as an engraver in the chief office of the survey; of three who became draughtsmen in architects' offices, one is in successful practice as an architect on his own account, which is also true of another, who completed his preparation by a course of study in Europe; one has been repeatedly elected recorder of deeds in a southern city, and two others are recorders' clerks in the west; one was elected and still sits as a city councilman; another has been elected city treasurer and is at present cashier of a national bank; one has become eminent as a practical chemist and assayer; two are members of the faculty of the college, and two others are rendering valuable service as instructors therein; some have gone into mercantile and other offices; some have undertaken business on their own account; while not a few have chosen agricultural and mechanical pursuits, in which the advantages of thorough mental training will give them a superiority over those not so well educated. Of those alluded to as having engaged in teaching, one has been the principal of a flourishing institution in Pennsylvania; one is now in his second year as principal of the Ohio institution; one has been at the head of a day school in Cincinnati, and later of the Colorado institution; a third has had charge of the Oregon institution; a fourth is at the head of a day school in St Louis; three others have respectively founded and are now at the head of schools in New Mexico, North Dakota, and Evansville, Indiana, and others have done pioneer work in establishing schools in Florida and in Utah."

Later years would unfold a similar tale of subsequent students; in 1907 there were 134 in the college and 59 in the Kendall School.

There is a normal department attached to the college, to which are admitted six hearing young men and women for one year who are recommended as being anxious to study methods of teaching the deaf and likely to profit thereby. Their course of study for 1898-1899 included careful training in the oral method, instruction in Bell's *Visible Speech*, instruction in the anatomy of the vocal organs, lectures on sound, observation of methods, oral and manual, in Kendall School, lectures on various subjects connected with the deaf and their education, lectures on pedagogy, lessons in the language of signs, practical work with classes in Kendall School under the direction of the teachers, correction of essays of the introductory class, &c. But the greatest advantage of the year's course is that the half-dozen hearing students live in the college, have their meals with the hundred deaf, and mix with them all day long—if they wish it—in social intercourse and recreation. We are very far indeed from saying that one such year is sufficient to make a hearing man a qualified teacher of the deaf, but the arrangement is based on the right principle, and it sets his feet on the right path to learn how to teach—so far as this art can be learned. The recent regulation of the board of education in England, prohibiting hearing pupil teachers in schools for the deaf, is deplorable, retrograde and inimical to the best interests of the deaf. It shows a complete ignorance of their needs. The younger a teacher begins to mix with that class the better he will teach them.

In 1886 a royal commission investigated the condition and education of the deaf in Great Britain, and in 1889 issued its report. Some of the recommendations most worthy of notice were that deaf children from seven to sixteen years of age should be compelled to attend a day school or institution, part, or the whole, of the expense being borne by the local school authority; that technical instruction should be given, and that all the children should be taught to speak and lip-read on the "pure" oral method unless physically or mentally disqualified, those who had partial hearing or remains of speech being entirely educated by that method. To the last mentioned recommendation—concerning the method to be adopted—two of the commissioners took exception, and another stated his recognition of some advantage in the manual method.

As a result of the report of the royal commission a bill was passed in 1893 making it compulsory for all deaf children to be educated. This was to be done by the local education authority, either by providing day classes or an institution for them, or by sending them to an already existing institution, parents having the choice, within reasonable limits, of the school to which the child should go. School-board classes came into existence in almost every large town where there was no institution, and sometimes where one existed. Those who uphold the day-school system advance the arguments that the pupils are not, under it, cut off from the influence of home life as they are in institutions; that such influences are of great advantage; that this system permits the deaf to mix freely with their hearing brethren, &c. The objections, however, to this arrangement outweigh its possible advantages. The latter, indeed, amount to little; for home influences in many cases, especially in the poorer parts of the large cities, are not the best, and communication with the hearing children who attend some of the day schools may not be an unmixed blessing, nor is freedom to run wild on the streets between school hours. But it may be urged further that it is difficult, except in very large towns, to obtain a sufficient number of deaf children attending a day school to classify them according to their status, while it is more than one teacher can do to give sufficient attention to several children, each at a different stage of instruction from any other. Moreover, the deaf need more than mere school work; they need training in morals and manners, and receive much less of it from their parents than their hearing brothers and sisters. This can only be given in an institution wherein they board and lodge as well as attend classes. The existing institutions were from 1893 placed, by the act of that date, either partly or wholly under the control of the school board. They were put under the inspection of the government, and as long as they fulfilled the requirements of the inspectors as regards education, manual and physical training, outdoor recreation and suitable class-room and dormitory accommodation, they might remain in the hands of a committee who collected, or otherwise provided, one-third of the total expenditure, and received two-thirds from public sources. Or else, the institution might be surrendered entirely to the management of the public school authority, and then the whole of the expenditure was to be borne by that body. Extra government grants of five guineas per pupil are now given for class work and manual or technical training. Such is the state of things at the present day, except, of course, that the school board has given place to the county council as local authority.

Some teachers have asked for the children to be sent to school at the age of five instead of seven. This savours of another confession that the "pure" oral method had not done what was expected of it at first. First, the demand was for the method itself; then came requests for more teachers, so that, the classes being smaller, each pupil should receive more attention; this meant more money, and so this was asked for; then day schools would remedy the failure by giving the pupils opportunities of talking with the public in general; then we were told the teachers were unskilful; finally, more time is needed. And yet the language of the pupils is no better to-day than it was in 1881, even though they were at school only four or five years then as opposed to nine or ten now.

To Addison's *Report on a Visit to some Continental Schools for the Deaf (1904-1905)* we are indebted for the following information. The new school at Frankfort-on-Maine, accommodating forty or fifty children at a cost of £40 to £50 per head, is modelled on the plan of

a family home. The main objects are to obtain good speech and lip-reading and to use these colloquially; the work is very thorough and the teaching very skilful. At Munich those of the hundred pupils who have some hearing are separated from the others and taught by ear as well as eye. At Vienna (Royal Institution) a small proportion of the pupils are day scholars, as they are at Munich, and the teaching is, of course, carried on by the oral method, as it is all over Germany. Here, however, the teachers "think it impossible to educate fully all deaf-mutes by the oral method only." In the Jews' Home at Vienna the semi-deaf are taught by the acoustic method, and are not allowed to see the teacher's lips at all. At Dresden, a large school of 240 pupils, the director favours smaller institutions than his own, considers the oral method possible for all but the "weak-minded deaf," and divides his pupils into A, B and C divisions, according to intellect. In the first division good speech is obtained. Saxony boasts a home for deaf homeless women, grants premiums for deaf apprentices, and trains its teachers of the deaf in the institution itself—a good record and plan. In the royal institution at Berlin Addison saw good lip-reading and thorough work, though the deaf in the city—as in most of the schools—signed. The men in Berlin "like the adult deaf generally, were all in favour of a combination of methods, and condemned the pure oral theory as impracticable." At Hamburg, again, "hand signs" were used at least for Sunday service. Schleswig has two schools. Pupils are admitted first to the residential institution, where they are instructed for a year, and are then divided into A, B and C classes, "according to intellect." The lowest class (C) remain at this institution for the rest of the eight years, and a "certain amount of signing" is allowed in their instruction. A and B classes are boarded out in the town and attend classes at a day school specially built for them, being taught orally exclusively.

In Denmark Addison saw what impressed him most. All the children of school age go to Fredericia and remain for a year in the boarding institution. They are then examined and the semi-deaf—29% of the whole—are sent to Nyborg. The rest—all the totally deaf—remain another year at Fredericia and are then divided into the A, B and C divisions before mentioned, and on the same criterion—intellect. Those in C—the lowest class, 28% of the totally deaf—are sent to Copenhagen, where they are taught by the manual method, no oral work being attempted. Those in B class, numbering 19% of the deaf, remain in the residential institution in Fredericia and are taught orally, while the best pupils—A class—are boarded out in the town and attend a special day school. These form 26% of the deaf, and those with whom they live encourage them to speak when out of as well as when in school. The buildings and equipment generally are excellent. "Hand signs" are used at Nyborg, indicating the position of the vocal organs when speaking, and, as might be expected, the "lip"-reading is 90% more correct when these symbols—indefinitely more visible than most of the movements of the vocal organs and face when speaking—are used at the same time. The idea of these hand signs, by the way, corresponds to that of Graham Bell's *Visible Speech*, in which a written symbol is used to indicate the position of the vocal organs when uttering each sound; it is a kind of phonetic writing which is to a slight extent illustrative at the same time. We find natural signs of the utmost value when teaching articulation, to describe the position of the vocal organs. We give these details from Mr Addison's notes because it is to Germany that so many look for guidance to-day, and it is the home of the so-called "pure" oral method; while the system of classification in Denmark into the four schools which are controlled by one authority, struck him very favourably and is given rather fully.

In France most of the schools are supported by charity, and the only three government institutions are those at Paris for boys, with 263 pupils lately, at Bordeaux for girls, having 225 inmates, and at Chambéry with 86 boys and 38 girls. In the great majority the method of instruction is professedly pure oral. "But," said Henri Gaillard (*Report, World's Congress of the Deaf, Missouri, 1904*), "this is only in appearance. In reality all of the schools use the combined method; only they are not willing to admit it, because the oral method is the official method, imposed by the inspectors of the minister of the interior."

In Italy, again, we are told that the teachers sign in most of the schools, which are professedly pure oral.

In Sweden, schools for the deaf have ceased to depend, as they did up to 1891, upon private benevolence. The system is generally the combined, and in schools where the oral method is adopted the pupils are divided into A, B and C divisions, as in Denmark and Dresden, in the two latter divisions of which signs are allowed. In Norway the method is the oral.

*Methods of Teaching.*—There have always been two principal methods of teaching the deaf, and all education at the present time is carried on by means of one or other or both of these. Where there is sufficient hearing to be utilized, instruction is sometimes given thereby as well, though this auricular method does not seem to make much headway, and experience is not in favour of believing that the sense of hearing, where a little exists, can be "cultivated" to any marked degree. It is really

impossible to draw hard and fast lines between these means of instruction. One merges into another, and this other into the next; and no two teachers will, or can, adopt exactly the same lines. It is not desirable that they should, for much must be left to individuality. Orders, rules, methods, should not be absolute laws. Observe them generally, but dispense with them as circumstances, the pupil and opportunity may require. Strong individuality, sympathy, enthusiasm, long intercourse with the deaf, are needed in the teacher, and it is surely obvious that every teacher should have a full command of all the primary means of instruction to begin with, and not of one only.

Where deafness is absolute, or practically so, we have to seek

130 words a minute can be attained when spelling on the fingers. Words are quite readable at this speed.

Although reading and writing are common to both methods, the manual and oral, as a matter of fact they seem to be used considerably more in the former than in the latter.

In the oral method articulation and lip-reading are chiefly relied upon; reading and writing are also adopted. The phonetic values of the letters are taught, not the names of the letters; for instance, the *sound* of the letter *h* in "hat" is taught instead of the *name* of the letter (long A), though of course the latter is taught where such is the proper pronunciation, as in "hate."

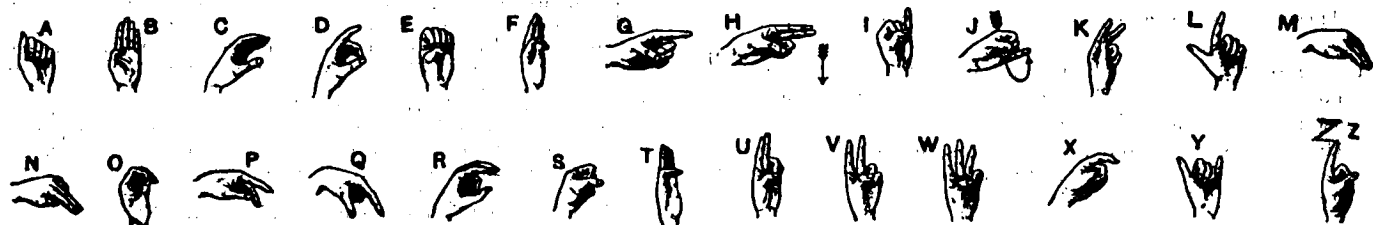

The Manual Alphabet. (One-handed.)

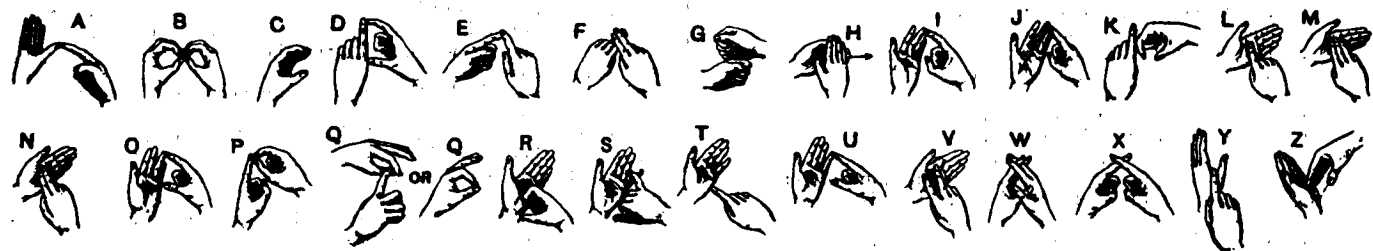

FIG. 2.—The Manual Alphabet. (Two-handed.)

for means that will appeal to the eye instead of the ear. Of these, we have the sign language, writing and printing, pictures, manual alphabets and lip-reading. We have to choose which of these is to be used, if not all, and which must be rejected, if any. Moreover, we have to decide how much or how little one or another is to be adopted if we employ more than one. Hence it is obvious that there may be many different systems and subdivisions of systems. But the two main methods are the *manual*, which generally depends upon all the above-mentioned means of appealing to the eye except lip-reading, and the *oral*, which adopts what the manual method rejects, uses writing and printing and perhaps pictures, but excludes finger-spelling and (theoretically) signs. To these two we must add a third means of instruction—the *combined system*—which rejects no means of teaching, but uses all in most cases. The dual method need hardly be called a separate method or system, for it implies simply the use of the manual method for some pupils and of the oral for others. Nor need we call the mother's (= intuitive or natural) a separate method in the sense in which we are using the word here, for it is rather a mode of procedure which can be applied manually or orally indifferently. The same may be said of the grammatical "method"; also of the "word method," which is really the "mother's." The "eclectic method" is practically the combined system, or something between that and the dual method, and hardly needs separate classification.

Let us notice the manual method, the oral method, and the combined system, considering with the last the "dual method."

The chief elements of the manual method are finger-spelling, reading and writing and signing. These are used, that is to say, as means of teaching English and imparting ideas. **Manual.** Signs are used to awaken the child's thoughts, finger-spelling and writing are used to express these thoughts in the vernacular. The latter are used to express English, the former to explain English.

We give two manual alphabets, the one-handed being used in America, on the continent of Europe with some variations and additions, in Ireland, and also to some extent in England; the two-handed in Great Britain, Ireland and Australia. A speed of

Here is a chart which was lately in use:

Articulation Sheets.

ANALYSIS OF THE VOWEL SOUNDS.							
Long.		Middle.		Short.		Broad.	
Diacritic mark.	Phonetic spelling.	Diacritic mark.	Phonetic spelling.	Diacritic mark.	Phonetic spelling.	Diacritic mark.	Phonetic spelling.
fāt(e) = feit		fār = far		fāt = fat		fāll = } fawl, fol	
mē = } mee				mēt = met			
mi = } mi				pīn = pin			
pīn(e) = pain		mōve = muv		nōt = not			
nō = not		būll = bul		tūb = tub			
rūb(e) = tjub							

Order in which the Vowel Sounds are to be taught.

2	Diacritic Mark	ā									
		wall									
2	Phonetic Spelling										
		aw, o									
1	Diacritic Mark	ā	ō	ū	ē	ē	ō	ī	ā	ū	ōē
		path	hot	blu(e)	set	see	ton(e)	pi(e)	lat(e)	mul(e)	boy
1	Phonetic Spelling										
		o	u	e	i	ou	ai	ei	iu	oi	
3	Diacritic Mark	ä	ü	ī							
		hat	hut	hit							
3	Phonetic Spelling										
		a	u	i							
3	Diacritic Mark	ä	ü	ī							
		hat	hut	hit							
3	Phonetic Spelling										
		a	u	i							

The consonants are as follows, though the order of teaching them varies:—

p; f; s; h; sh; v=f; th (thin; moth); th (then; smooth); l; r; t; k; b; d; g (go; egg); z=s; m; n; ch=tsh; j=dzh=g; ph=f; kc=k; cs=s; q=kw; x=ks; ng; w=oo; wh=hw; y=e.

The following mode of writing the sounds is now preferred by some as it renders the diacritical marks unnecessary:—

*Middle, Broad and Long Vowel Sounds.*

ar	or	oo	ee	er	oa	igh	ai	ew	oi	ou
	aw		ea	ir	o-e	i-e	a-e	u-e	oy	ow
	au			ur			ay			
	a—									

*Short Vowel Sounds.*

a	o	oo	e	i	u
---	---	----	---	---	---

*Consonants.*

h	p	{ ph }	t	s	th	sh	ch	{ k }	l	r	m	n	ng	w
		{ f }						{ ck }						
b	v		d	z	th	zh	{ j }							
							{ dzh }	g						

These charts are given as examples of those used, but they vary in different schools, as does the order of teaching the vowel and consonant sounds and the combinations. The exact order is not important. Words are made up by combining vowels and consonants as soon as the pupil can say each sound separately.

Here are extracts from the directions on articulation written by a principal to the teacher of the lowest class, which show the method of procedure:—

- (1) Produce the sound of a letter. Each pupil to reproduce, and write it on the tablet.
- (2) Point to the letter on the tablet, and make each pupil say it.
- (3) The same with combinations of vowels and consonants.
- (4) Instead of tablet, each pupil to use rough exercise-book.
- (5) Write on tablet and make each pupil articulate from teacher's writing.
- (6) When a combination is made of which a word may be made make all write it in their books, thus:—'te—tea,' 'shō—show,' 'ōv—of,' 'nālz—nails,' &c.
- (7) When one pupil produces a combination correctly make the others lip-read it from him. In this way make them exercise each other.
- (8) When they have a good many sounds and combinations written in their books make them sit down and say them off their books as hearing children do.
- (9) Make them say the sounds off the cards, and form combinations on the cards for them to say.
- (10) Take each vowel separately and make each pupil use it before and after each consonant.
- (11) Take each consonant and put it before and after each vowel.

The above will suggest other exercises to the teacher. Give breathing exercises. Incite emulation as to deep breathing and slow expiration. Never force the voice. Make the pupil speak out, but do not let him strain either the voice or vocal organs. Do not force the tongue, lips, or any organ into position more than you can help. Do all as gently as possible. Register their progress. 'A' (as in 'path'; 'father'). As 'A' is the basis of all the vowels, being most like all, it is taken first. It is an open vowel. Do not make grimaces, or exaggerate. If false sound be produced do not let the pupil speak loudly; make him speak quietly. If nasal sound be produced do not pinch the nose, but first take the back of the child's hand, warmly breathe on it, or get a piece of glass, and let the child breathe on it, or press the back of the tongue down. Show the child that when you are saying 'a' your tongue lies flat or nearly so, and you do not raise the back of the tongue. Prefix 'h' to 'a' and make the pupil say 'ha' first, then 'a' alone.

'P.' If the child does not imitate at the first the teacher should take the back of the hand and let the child feel the puff of air as 'p' is formed on the lips.

'P' is produced by the volume of air brought into the cavity of the mouth being checked by the perfect closure of the lips, which are then opened, and the accumulated air is propelled. The outburst of this propelled air creates the sound of 'p.' Take the pupil to see porridge boiling. Pretend to smoke. 'P' is taken first because it has no vibration and is the most simple. The consonants should first be joined to each vowel separately, and to prevent the pupils making an after-sound the letters should be said with a pause between, viz. 'A . . p,' and as they become more familiar with them, lessen the pause until it is pronounced properly:—'ap.'"

These directions, which are only brief examples of those given for one particular subject in one particular class, will give an idea of the mode of beginning to teach articulation and lip-reading.

The combined system, as before mentioned, makes use of both the manual and oral method, as well as the auricular, without any hard and fast rule as regards the amount of instruction to be given by means of each, but using more of one and less of another, or *vice versa*, according to the aptitude of the child. It thus follows the sensible, obvious plan

of fitting the method to the child and not the unnatural one of forcing the child to try to fit the method.

The following is the way the same principal would teach language to beginners by the combined system:—

"The letters p, q, b and d of the Roman text are to be taught first. The pupils are to do them 9 in. long on the blackboard or tablet first; then trace them on the frames; then on slips of paper with pen and ink, or in rough exercise-book with pen and ink.

"The whole of the Roman text is then to be taught in the same manner, also the small and capital script.

"When the English alphabet has been mastered in the above four forms the pupil may proceed to the printing and writing of his own name. Then his teacher's and class-mates' names. Then the names of other persons and the places, things and actions with which he has to do in his daily life. Every direction the teacher has to give in school and out of school should be expressed in speech, writing or finger-spelling, or by any two or all three means. Repetition of such directions by the pupil enables him to learn words before he has finished the alphabet.

"All words to be spelled on one hand first; then two. When a few words have been memorized, they should be written on slips of paper, then in the exercise-books and dated. After this there should be further repetition and exercising. The same course should be taken with phrases and short sentences. Names of persons should be written on cards and slips of paper and pinned to the chest. Names of things to be affixed to them, or written on them. Names of apartments on cards laid in the rooms. Where the object is not available use a picture, or draw the outline and make pupil do the same. Never nod, or point, or jerk the finger, or use any other gesture, without previously giving the word, and when the latter is understood drop the gesture altogether.

"Never allow a single mistake to pass uncorrected, and make pupils always learn the corrections.

"Language should be a translation of life. It should proceed all day long, out of school as well as in it. If spoken so much the better, but finger-spelling is not a hindrance but a valuable help to its acquisition.

"In most language lessons, especially those exemplifying a particular form of sentence, the pupils should:

(1) Correct each other's mistakes. Correct 'mistakes' designedly made by the teacher.

(2) Teacher rubs out a word here and there on the blackboard or tablet; pupils to supply them.

(3) Pupils to answer questions, giving the subject, predicate and object of the sentence as required, e.g. 'A farmer ploughs the ground.' 'Who ploughs the ground?' 'What does a farmer do?' 'What does he plough?' Also additional and illustrative questions; e.g. 'Does the ground plough the farmer?' 'Does a farmer plough the sea?' 'Does he eat the ground?' &c.

"The pupils should learn meanings or synonyms of unfamiliar words before such words are signed.

(4) Teacher gives a word, and requires pupils to exemplify it in a sentence, e.g. 'sows,' 'He sows the seed.'

(5) Let them give as many sentences as they can think of in the same form.

"Occurrences, incidents, objects, pictures, reading-books, newspaper cuttings and correspondence should all be used."

The "pure" oral method, as before noticed, came with a bound into popularity in the early seventies. Since then it has had everything in its favour, but the results have been by no means entirely satisfactory, and there is a marked tendency among advocates of this method to with-

draw from the extreme position formerly held. Opinion has gradually veered round till they have come to seek for some sort of *via media* that shall embrace the good points of both methods. Some now suggest the "dual method"—that those pupils who show no aptitude for oral training shall be taught exclusively by the manual method and the rest by the oral only. While this is a concession which is positively amazing when compared with the title of the booklet containing utterances of the Abbé Tarra, president of the Milan conference in 1880—"The Pure Oral Method the Best for All Deaf Children"—yet we believe that in no case should the instruction be given by the oral method alone, and that the best system is the "combined." That the combined system is detrimental to lip-reading has not much more than a fraction of truth in it, for if the command of language is better the pupils can supply the lacunae in their lip-reading from their better knowledge of English. It is found that they have constantly to guess words and letters from the context. Teach all by and through finger-spelling, reading, writing and signing where necessary to explain the English, and teach those in whose case it is worth it by articulation and lip-reading as well. Signs

*The best system.*

should be used less and less in class work, and English more and more exclusively as the pupil progresses—English in any and every form. A proportion of teachers should be themselves deaf, as in America. They are in perfect understanding and sympathy with their pupils, which is not always the case with hearing teachers. Statistics which we collected in London showed the following results of the education of 403 deaf pupils after they had left school:—

	Manual.	Combined.	Oral.
Quite satisfactory result	65%	51%	20%
Moderate success	29%	41%	35%
Unsatisfactory result	5%	7%	44%

That the combined system should show to slightly less advantage than the exclusively manual method is what we might perhaps expect, for the time given to oral instruction means time taken from teaching language speedily, the manual method being, we believe, the best of all for this. But it may be worth while to lose a little in command of language for the sake of gaining another means of expressing that language. Hence we advocate the combined system, regarding speech as merely a means of expressing English, as writing and finger-spelling are, and a good sentence written or finger-spelled as being preferable to a poorer one which is spoken, no matter how distinct the speech may be. It is no answer to point to a few isolated cases where the oral method is considered to have succeeded, for one success does not counterbalance a failure if by another method you would have had two successes; and, moreover, these oral successes would have been still greater successes—we are taking language in any form as our criterion—had the teacher fully known and judiciously used the manual method as well as the oral.

The exclusive use of the oral method leads, generally speaking, to comparative failure, for the following, among other, reasons:—(1) It is a slow way of teaching English, the learning to speak the elements of sound taking months at least, and seldom being fully mastered for years. The "word method," by the way, starts at once with words without taking their component phonetic elements separately; but it has yet to be proved that any quicker progress is made by this means of teaching speech than by the other. (2) Lip-reading is, to the deaf, sign-reading with the disadvantage of being both microscopic and partially hidden. The deaf hear nothing, they only partly see tiny movements of the vocal organs. Finger-spelling, writing, signing, are incomparably more visible, while 130 words a minute can be attained by finger-spelling, and read at that speed. (3) The signs—as they are to the deaf—made by the vocal organs are entirely arbitrary, and have not even a fraction of the redeeming feature of naturalness which oralists demand in ordinary gestures. (4) Circumstances, such as light, position of the speaker, &c., must be favourable for the lip-reading to approach certainty. (5) Styles of speech vary, and it is a constant experience that even pupils who comparatively easily read their teacher's lips, to whose style of utterance they are accustomed, fail to read other people's lips. (6) There is a great similarity between certain sounds as seen on the lips, e.g. between *t* and *d*, *f* and *v*, *p* and *b*, *s* and *z*, *k* and *g*. Which is meant has usually to be guessed from the context, and this requires a certain amount of knowledge of language, which is the very thing that is needed to be imparted. (7) The deliberate avoidance by the teacher of the pupil's own language—signs—as an aid to teaching him English. If a hearing boy does not understand the meaning of a French word he looks it up in the dictionary and finds its English equivalent. If the deaf boy does not understand a word in English, the simplest, quickest, best way to explain it is, in most cases, to sign it. (8) The distaste of the pupil for the method. This is common. (9) The mechanical nature of the method. There is nothing to rouse his interest nor to appeal to his imagination in it. (10) The temptation to the teacher to use very simple phrases, owing to the difficulty the pupil has in reading others from his lips. Consequently the pupil comparatively seldom learns advanced language.

Other means of educating the deaf in addition to the oral should have a fair trial in modern conditions for the same length of time that the oral method has been in operation. To consider pupils taught manually in oral schools fair criteria of what can be done by the manual method or combined system, when those pupils have confessedly been relegated to the manual class because of "dulness" (as in the case of the C divisions in Denmark and Dresden), is obviously unfair. This division, moreover, assumes that the "pure" oral method is the best for the brightest pupils. The comparing of oral pupils privately taught by a tutor to themselves with manual pupils from an institution crippled and hampered by need of funds, where they had to take their chance in a class of twelve, and the comparison of oral pupils of twelve years' standing with combined system pupils of four years', are also obviously unfair. Reference may be

made on this subject to Heidsiek's remarkable articles on the question of education, which appeared in the *American Annals of the Deaf* from April 1899 to January 1900.

The opinions of the deaf themselves as to the relative merits of the methods of teaching also demand particular attention. The ignoring of their expressed sentiments by those in authority is remarkable. In the case of school children it might fairly be argued that they are too young to know what is good for them, but with the adult deaf who have had to learn the value of their education by bitter experience in the battle of life it is otherwise. In Germany, the home of the "pure" oral method, 800 deaf petitioned the emperor against that method. In 1903 no fewer than 2671 of the adult deaf of Great Britain and Ireland who had passed through the schools signed a petition in favour of the combined system. The figures are remarkable, for children under sixteen were excluded, those who had not been educated in schools for the deaf were excluded, and the education of the deaf has only lately been made compulsory, while many thousands who live scattered about the country in isolation probably never even heard of the petition, and so could not sign it. In America an overwhelming majority favour the combined system, and it is in America that by far the best results of education are to be seen. At the World's Congress of the Deaf at St Louis in 1904 the combined system was upheld, as it was at Liège. From France, Germany, Norway and Sweden, Finland, Italy, Russia, everywhere in fact where they are educated, the deaf crowd upon us with expressions of their emphatic conviction, repeated again and again, that the combined system is what meets their needs best and brings most happiness into their lives. The majority of deaf in every known country which is in favour of this means of education is so great that we venture to say that in no other section of the community could there be shown such an overwhelming preponderance of opinion on one side of any question which affects its well-being. In the case of the rare exceptions, the pupil has almost always been brought up in the strictest ignorance of the manual method, which he has been sedulously taught to regard as clumsy and objectionable.

*The Blind Deaf.*

In the summary tables (p. 283) of the 1901 British census the following numbers are given of those suffering from other afflictions besides deafness:—

1. Blind and deaf and dumb	58
2. Blind and deaf	389
3. Blind, deaf and dumb and lunatic	5
4. Blind, deaf and lunatic	5
5. Deaf and dumb and lunatic	136
6. Deaf and lunatic	51
7. Blind, deaf and dumb and feeble-minded	5
8. Blind, deaf and feeble-minded	8
9. Deaf and dumb and feeble-minded	221
10. Deaf and feeble-minded	100

In addition to these, 2 are said to be blind, dumb and lunatic; 20 dumb and lunatic; 3 blind, dumb and feeble-minded, and 222 dumb and feeble-minded. These are certainly outside our province, which is the deaf. The "dumbness" in these four classes is aphasia, due to some brain defect.

Of those in the list, classes 7, 8, 9 and 10 are (we are strongly of opinion) incorrectly described, being, as we think, composed of those who are simply feeble-minded as well as, in classes 7 and 8, blind. Their so-called "deafness" is merely inability of the brain to notice what the ear does actually hear and to govern the vocal organs to produce articulate sound. Many of classes 9 and 10, however, may not be "feeble-minded" at all, but only rather dull pupils whom their teachers have failed to educate.

It is safe to say that in some instances in classes 3, 4, 5 and 6 the persons were only assumed to be deaf. Again, cases of deaf people who to all appearance could not fairly be called insane but who may have had violent temper or some slight eccentricity being relegated to an asylum have come to our notice. A good teacher might accomplish much with some of these described as lunatic in classes 5 and 6. Finally, classes 3 and 4 may have become lunatic owing to the loneliness and brooding inseparable to a great extent from such terrible afflictions as blindness and deafness combined. Probably the isolation became intolerable, and if only they had had some one who understood them to educate them their reason might have been saved.

We are most concerned with the first two classes, and in considering them have to take individual cases separately, as there is no regular institution for them in Great Britain.



Mr W. H. Illingworth, head master of the Blind School at Old Trafford, Manchester, tells how David Maclean, a blind and deaf boy, was taught, in the 1903 report of the conference of teachers of the deaf. The boy lost both sight and hearing, but not before six years of age, which was an advantage, and could still speak or whisper to some extent when admitted to school. His teacher began with kindergarten and attempts at proper voice-production. He gave the sound of "ah" and made David feel his larynx. Then he tickled the boy under his arms, and when he laughed made him feel his own larynx, so that the boy should notice the similarity of the vibration. Then, acting on the theory that brain-waves are to some extent transmittable, Mr Illingworth procured a hearing boy as companion, and, ordering him to keep his mind fixed on the work and to place one hand on David's shoulder, made him repeat what was articulated. The blind-deaf boy's right hand was placed on Mr Illingworth's larynx and the left on the companion's lips. Thus the pupil felt the sound and the companion's imitation of it, and soon reproduced it himself. From this syllables and words were formed by degrees. The pupil knew the forms of some letters of the alphabet in the Roman type before he lost sight and hearing, and the connexion between them and the Braille characters and manual alphabet was the next step achieved. This, and all the steps, were aided to a great extent by the hearing and seeing boy companion's sympathetic influence and concentration of mind, in Mr Illingworth's opinion. After this stage his progress was comparatively quick and easy; he read from easy books in Braille, and people spelled to him in the ordinary way by forming the letters with their right hand on his left.

From Mr B. H. Payne of Swansea comes the following account of how four blind-deaf pupils were taught:—

"We have received four pupils who were deaf-mute and blind, one of them being also without the sense of smell. One was born deaf, the others having lost hearing in childhood. There was no essential difference between the methods employed in their education and those of 'sighted' deaf children. Free-arm writing of ordinary script was taught on the blackboard, the teacher guiding the pupil's hand, or another pupil guiding it over the teacher's pencilling. The script alphabet was cut on a slate, and the pupil's pencil made to run in the grooves. The one-hand alphabet, used with the left hand, was employed to distinguish the letters so written. The script alphabet was also formed in wire for him. The object was to enable the pupil when he had gained language to write to friends and others who were unacquainted with Braille, but the latter notation was taught to enable the pupil to profit by the literature provided for the blind. Both one- and two-hand alphabets were taught, the teacher forming the letters with one of his own hands upon the pupil's hand. The name of the object presented to the pupil was spelled and written repeatedly until he had memorized it. Qualities were taught by comparison, and actions by performance. The words 'Come with me' were spelled before he was guided to any place, and other sentences were spelled as they would be spoken to a 'hearing' child in appropriate associations. The blind pupil followed with his hands the signs made by junior pupils who were unacquainted with language, and in this way readily learned to sign himself, the art being of advantage in stimulating and in forming the mind, and explaining language to him. One of the pupils was confirmed, and in preparation for the rite over 800 questions were put to him by finger-spelling. His education was continued in Braille. The deaf-born boy developed a fair voice, and could imitate sounds by placing his hand on a speaker's mouth. Two of them had a keen sense of humour, and would slyly move the finger to the muscles of their companion's face to feel the smile with which a bit of pleasantry was responded to. In connexion with the pupil who was confirmed, the vicar who examined him declared that none of his questions had been answered better even by candidates possessed of all their faculties than they were by this blind-deaf boy."

Mr W. M. Stone, principal of the Royal Blind School at West Craigmillar, Edinburgh, gives this very interesting information:

"We have five blind-deaf children at this institution, and all are wonderfully clever and intelligent. In all cases the children possessed hearing for a time and had some knowledge—very slight in some cases—of language. The method of teaching is, first to teach them the names of common objects on their fingers. A well-known object is put in the child's hand and then the word is spelled on the hand,—the child's hand of course. The child learns to associate these signs—he does not know they are letters—with the object, and so he learns a name. Other names are then given and similar names are associated together, and by noticing the difference in the names the child

gradually grasps the idea of an alphabet. For instance, if he learns the words cat, bat and mat, he will quickly distinguish that the words are alike except in their initial letters. When in this way language has been acquired he is taught the Braille system of reading for the blind and his progress is now very rapid. This method may appear very complicated and difficult, but in reality it is not so. There are no institutions in Great Britain specially for the blind-deaf, nor are there any in America. I do not know of any on the continent. Our own blind children here are receiving the same education as our other children, and in some ways are more advanced than seeing and hearing children of their own ages. They not only read, write and do arithmetic, but they do typewriting and much manual work."

Mr Addison mentions two deaf and blind pupils who were taught by the late Mr Paterson of Manchester, and a third in the same school later on. Another was taught in the asylum for the blind in Glasgow, though she only lost hearing and became deaf at ten.

Mr William Wade has written a monograph on the blind-deaf of America, in the preface to which he points out, rightly, that the education of the blind-deaf is not such a stupendous task as people imagine it to be.

"It may not be amiss," he says, "to state the methods of teaching the first steps to a deaf-blind pupil, that the public may see how exceedingly simple the fundamental principles are, and it should be remembered that those principles are exactly the same in the cases of the deaf and of the deaf-blind, the only difference being in the application—the deaf *see*, the deaf-blind *feel*. Some familiar, tangible object—a doll, a cup, or what not—is given to the pupil, and at the same time the name of the object is spelled into its hand by the manual alphabet." (The one-hand alphabet is in vogue in America.) "By patient persistence, the pupil comes to recognize the manual spelling as a name for a familiar object, when the next step is taken—associating familiar acts with the corresponding manual spelling. A continuation of this simple process gradually leads the pupils to the comprehension of language as a means for communication of thoughts." Mr Wade is right. Given a sympathetic, resourceful teacher with strong individuality, common-sense, patience, and the necessary amount of time, anything and everything in the way of teaching them is not only possible but certain to be achieved. Language,—give the deaf and the blind-deaf a working command of that and everything else is easy.

In the New York Institution for the Deaf ten blind-deaf pupils were educated, up to the year 1901. Nearly all of these lost one or both senses after they had been able to acquire some knowledge with their aid. In the Perkins Institution for the Blind, Boston, five were taught. It was here that Laura Bridgman was educated by Dr Samuel G. Howe (*q.v.*); all honour is due to him for being the pioneer in attempting to teach this class of the community, for she was the first blind-deaf person to be taught. Many other schools for the deaf or blind have admitted one or two pupils suffering from both afflictions. In all, seventy cases are mentioned by Mr Wade of those who are quite blind and deaf, and others of people who are partially so. The most interesting, of course, of all these is Helen Keller, if we except Laura Bridgman, in whose case the initial attempt to teach the blind-deaf was made. Helen Keller was taught primarily by finger-spelling into her hand, and signing (which she, of course, felt with her hands) where necessary. Her first teacher was Miss Sullivan. The pupil "acquired language by practice and habit rather than by study of rules and definitions." Finger-spelling and books were the two great means of educating her at all times. After her grasp of language had been brought to a high standard, Miss Fuller gave her her first lessons in speech, and Miss Sullivan continued them, the method being that of making the pupil feel the vocal organs of the teacher. She learnt to speak well, and to tell (with some assistance from finger-spelling) what some people say by feeling their mouth. Her literary style became excellent; her studies included French, German, Latin, Greek, arithmetic, algebra, geometry, history, ancient and modern, and poetry and literature of every description. Of course she had many tutors, but Miss Sullivan was "eyes and ears" at all times, by acting as interpreter, and this patient teacher had the satisfaction of seeing her pupil pass the entrance examination of Harvard University. To all time the success attained in educating Helen Keller will be a monument of what can be accomplished in the most favourable conditions. (A. H. P.)

**DEÁK, FRANCIS (FERENCZ)**, (1803-1876), Hungarian statesman, was born at Söjtör in the county of Zala, on the 17th of October 1803. He came of an ancient and distinguished noble family, and was educated for the law at Nagy-Kanizsá, Pápa, Raab and Pest, and practised first as an advocate and ultimately as a notary. His first case was the defence of a notorious robber and murderer. His reputation in his own county was quickly established, and when in 1833 his elder brother Antal, also a man of extraordinary force of character, was obliged by ill-health to relinquish his seat in the Hungarian parliament, the electors chose Ferencz in his stead. He took an active part in the proceedings of the diet at Pressburg and made the acquaintance of Ödon Beöthy and the other Liberal leaders. No man owed less to external advantages. He was to all appearance a simple country squire. His true greatness was never exhibited in debate. It was in friendly talk, generally with a pipe in his mouth and an anecdote on the tip of his tongue, that he exercised his extraordinary influence over his fellows. Convinced from the first of his disinterestedness and sincerity, and impressed by his penetrating shrewdness and his instinctive faculty of always seizing the main point and sticking to it, his hearers soon felt an absolute confidence in the deputy from Zala county. Perhaps there is not another instance in history in which a man who was neither a soldier, nor a diplomatist, nor a writer, who appealed to no passion but patriotism, and who avoided power with almost oriental indolence instead of seeking it, became, in the course of a long life, the leader of a great party by sheer force of intellect and moral superiority.

During the diet of 1839-1840 Deák succeeded in bringing about an understanding between a reactionary government, sadly in want of money, and a Liberal opposition determined that the nation should have its political privileges respected. "Let us put all jealousy on one side and allow him the pre-eminence," wrote Széchenyi of Deák (April 30th, 1840). Deák would not go to the diet of 1843-1844, though he had received a mandate, because his election was the occasion of bloodshed in the struggle between the Clericals who would have ousted him and the Liberals who brought him in. In 1848, however, he accepted the post of minister of justice offered to him by Louis Batthyány. He never ceased to urge moderation in those stormy days, holding rather with Eötvös and Batthyány than with Kossuth, and he went more than once to Vienna to endeavour to effect a compromise between the Radicals and the court. But when the ill-will of the Vienna government became patent, and the sentiments of the king doubtful, he resigned together with Batthyány, but without ceasing to be a member of the diet. He it was who drew up the resolution of the Lower House in reply to the rescript of the Austrian ministry demanding the repeal of the Hungarian constitution. It was he who urged the Hungarian cabinet not to depart a hair's-breadth from their legitimate position. He was one of the parliamentary deputation which waited in vain upon Prince Windischgrätz in his camp. (See HUNGARY: History.) He then retired to his estate at Kehida. After the war of independence he was tried by court-martial, but acquitted.

During the years of repression he lived in complete retirement. He rejected Schmerling's proposal that he should take part in the project of judicial reform, but on the other hand he held completely aloof from the widespread secret revolutionary movements. After 1854 he spent the greater part of his time at Pest, and his little room at the "Queen of England" inn became the meeting-place for those patriots who in those dark days looked to the wisdom of Deák for guidance. He used every opportunity of stimulating the moral strength of the nation and keeping its hopes alive. He invited the nation to contribute to the support of the orphans of Vörösmarty when that great poet died. He drew up the petition of the academy to the government, in which he defended the maintenance of this asylum of the national language against Austrian intervention. He trusted that, as had so often happened in the course of Hungarian history, the weakness and blindness of the court would help Hungary back to her constitutional rights. Armed resistance he considered dangerous, but he was an immutable defender of the continuity of the

Hungarian constitution on the basis of the reforms of 1848. His principles alienated him from the Kossuth faction, which looked for salvation to a second war with Austria, engineered from abroad; but he was equally opposed to the attitude of resignation taken up by the followers of Széchenyi, who, according to Deák, always regarded the world from a purely provincial point of view.

The war of 1859 convinced the Austrian government, at last, of the necessity of a reconciliation with Hungary; but the ensuing negotiations were conducted not through Deák, but through the Magyar Conservatives. In 1860 Deák rejected the October diploma (see HUNGARY: History), which was simply a cast-back to the Maria Theresa system of 1747; but, at the request of the government, he went to Vienna to set forth the national demands. On this occasion he insisted on the re-establishment of the constitution in its integrity as a *sine qua non*. Meanwhile, it became more and more evident that the Conservative party had no standing in the country. The majority of the deputies returned to the diet of 1861 were in favour of asserting their rights by a resolution of the House, instead of petitioning for them by an address to the crown; hence arose the two parties of the Addressers and the Resolutioners. The Patent of the 20th of February 1861 increased the uneasiness and suspicion of the nation; but Deák, now one of the deputies for Pest, was in favour of an address rather than of a resolution, and his great speech on the subject (May 13th, 1861) converted the majority hostile to an address into a majority for it. The object of the Addressers was to make the responsibility for a rupture rest on the Austrian government. Nevertheless, the court found the address so voted inadmissible; whereupon, on Deák's motion, the Hungarian diet drew up a second address vigorously defending the rights of the nation, and solemnly protesting against the usurpations of the Austrian government. The speech which Deák made on this occasion was his finest effort. Henceforth all Europe identified his name with the cause of Hungary. The Magyar Conservatives hereupon entered into negotiations with Deák, and the Austrian government, more than ever convinced of the necessity of a reconciliation, was ready to take the first step, if Hungary would take the second and third. Deák now proposed that the sovereign himself should break away from counsellors who had sought to oppress Hungary, and should restore the constitution as a personal act. The worthy response to this loyal invitation was the dismissal of the Schmerling administration, the suspension of the February constitution and the summoning of the coronation diet. Of that diet Deák was the indispensable leader. Under his direction the Addressers and the Resolutioners coalesced, and he was entrusted with the difficult and delicate negotiations with the crown, which aimed at effecting a compromise between the Pragmatic Sanction of 1719, which established the indivisibility of the Habsburg monarchy, and the March decrees of 1848. The committee of which he was president had completed its work, when the war of 1866 broke out and all again became uncertain.

After Königgrätz the extreme parties in Hungary hoped to extort still more favourable terms from the emperor; but Deák remained true to himself and to the constitutional principle. On the 18th of July he went to Vienna, to urge the necessity of forming a responsible Magyar ministry without delay. He offered the post of premier to Count Julius Andrassy, but would not himself take any part in the administration. The diet was resummoned on the 17th of November 1866 and, chiefly through the efforts of Deák, the responsible ministry was formed (February 17th, 1867). There was still one fierce parliamentary struggle, in which Deák defended the Composition (Ausgleich) of 1867, both against the Kossuthites and against the Left-centre, which had detached itself from his own party under the leadership of Kálmán Tisza (*q.v.*). He, a simple citizen, from pure patriotism, thus mediated between the crown and the people, as the Hungarian palatines were wont to do in years gone by, and it was the wish of the diet that Deák should exercise the functions of a palatine at the solemn ceremony of the coronation. This honour he refused, as he had refused every other reward and distinction.

"It was beyond the king's power to give him anything but a clasp of the hand." His real recompense was the assurance of the prosperity and the tranquillity of his country in the future, and the reconciliation of the nation and its sovereign. The consciousness of these great services even reconciled him to the loss of much of his popularity; for there can be no doubt that a large part of the Hungarian nation regarded the Composition of 1867 as a sort of surrender and blamed Deák as the author of it. The Composition was the culminating point of Deák's political activity; but as a party-leader he still exercised considerable influence. He died at midnight of the 28th-29th of July 1876, after long and painful sufferings. His funeral was celebrated with royal pomp on the 3rd of February, and representatives from every part of Hungary followed the "Sage" to the grave. A mausoleum was erected by national subscription, and in 1887 a statue, overlooking the Danube, was erected to his memory.

See *Speeches* (Hung.) ed. by Manó Kónyi (Budapest, 1882); Z. Ferenczi, *Life of Deák* (Hung., Budapest, 1894); *Memorials of Ferencz Deák* (Hung., Budapest, 1889-1890); Ferencz Pulszky, *Charakterskizse* (Leipzig, 1876). (R. N. B.)

**DEAL**, a market town, seaport and municipal borough in the St Augustine's parliamentary division of Kent, England, 8 m. N.E. by N. of Dover on the South-Eastern & Chatham railway. Pop. (1901) 10,581. It consists of three divisions—Lower Deal, on the coast; Middle Deal; and, about a mile inland, though formerly on the coast, Upper Deal, which is the oldest part. Though frequented as a seaside resort, the town derives its importance mainly from its vicinity to the Downs, a fine anchorage, between the shore and the Goodwin Sands, about 8 m. long and 6 m. wide, in which large fleets of windbound vessels may lie in safety. The trade consequently consists largely in the supply of provisions and naval stores, which are conveyed to the ships in need of them by "hovellers," as the boatmen are called all along the Kentish coast; the name is probably a corruption of *hobeler*, anciently applied to light-horsemen from the hobby or small horse which they rode. The Deal hovellers and pilots are famous for their skill. Boat-building and a few other industries are carried on. Among buildings the most remarkable are St Leonard's church in Upper Deal, which dates from the Norman period; the Baptist chapel in Lower Deal, founded by Captain Taverner, governor of Deal Castle, in 1663; the military and naval hospital; and the barracks, founded in 1795. The site of the old navy yard is occupied by villas; and the esplanade, nearly four miles long, is provided with a promenade pier. The golf-links is well known. At the south end of the town is Deal Castle, erected by Henry VIII. in 1539, together with the castles of Sandown, Walmer and Sandgate. They were built alike, and consisted of a central keep surrounded by four lunettes. Sandown Castle, which stood about a mile to the east of Deal Castle, was of interest as the prison in which Colonel Hutchinson, the Puritan soldier, was confined, and is said to have died, September 1664. It was removed on becoming endangered by encroachments of the sea. The "captain" of Deal Castle is appointed by the lord warden of the Cinque Ports. The town is governed by a mayor, 6 aldermen and 18 councillors. Area, 1111 acres.

Deal is one of the possible sites of the landing-place of Julius Caesar in Britain. Later in the period of Roman occupation the site was inhabited, but apparently was not a port. In the Domesday Survey, Deal (*Dola, Dale, Dele*) is mentioned among the possessions of the canons of St Martin, Dover, as part of the hundreds of Bewsborough and Cornilo; it seems, however, from early times to have been within the liberty of the Cinque Ports as a member of Sandwich, but was not continuously reckoned as a member until Henry VI., on the occasion of a dispute as to its assessment, finally annexed it to their jurisdiction.

In the time of Henry VIII. Deal was merely a fishing village standing half-a-mile from the sea, but the growth of the English navy and the increase of trade brought men-of-war and merchant ships in increased numbers to the Downs. Deal began to grow in importance, and Lower or New Deal was built along the shore. The prosperity of the town has ever since depended almost

entirely on its shipping trade. In 1699 the inhabitants petitioned for incorporation, since previously the town had been under the jurisdiction of Sandwich and governed by a deputy appointed by the mayor of that town; William III. by his charter incorporated the town under the title of mayor, jurats and commonalty of Deal, and he also granted a market to be held on Tuesday and Saturday, and fairs on the 25th and 26th of March, and on the 30th of September and 1st of October, with a court of Pie Powder. The Cinque Ports were first represented in the parliament of 1265; the two members returned by Sandwich represented Sandwich, Deal and Walmer, until they were disenfranchised by the act of 1885.

**DEAL**. (1) (A common Teutonic word for a part or portion, cf. Ger. *Teil*, and the Eng. variant "dole"); a division or part, obsolete except in such phrases as "a great deal" or "a good deal," where it equals quantity or lot. From the verb "to deal," meaning primarily to divide into parts, come such uses as for the giving out of cards to the players in a game, or for a business transaction. (2) (Also a Teutonic word, meaning a plank or board, cf. Ger. *Diele*, Dutch *deel*), strictly a term in carpentry and joinery for a sawn plank, usually of pine or fir, 9 in. wide and 2 to 4½ in. thick. (See JOINERY.) The word is also used more loosely of the timber from which such deals are cut, thus "white deal" is used of the wood of the Norway spruce, and "red deal" of the Scotch pine.

**DEAN** (Lat. *decanus*, derived from the Gr. *δέκα*, ten), the style of a certain functionary, primarily ecclesiastical. Whether the term was first used among the secular clergy to signify the priest who had a charge of inspection and superintendence over two parishes, or among the regular clergy to signify the monk who in a monastery had authority over ten other monks, appears doubtful. "Decurius" may be found in early writers used to signify the same thing as "decanus," which shows that the word and the idea signified by it were originally borrowed from the old Roman military system.

The earliest mention which occurs of an "archipresbyter" seems to be in the fourth epistle of St Jerome to Rusticus, in which he says that a cathedral church should possess one bishop, one archipresbyter and one archdeacon. Liberatus also (*Breviar.* c. xiv.) speaks of the office of archipresbyter in a manner which, as J. Bingham says, enables one to understand what the nature of his duties and position was. And he thinks that those are right who hold that the archipresbyters were the same as the deans of English cathedral churches. E. Stillingfleet (*Irenic.* part ii. c. 7) says of the archipresbyters that "the memory of them is preserved still in cathedral churches, in the chapters there, where the dean was nothing else but the archipresbyter; and both dean and prebendaries were to be assistant to the bishop in the regulating the church affairs belonging to the city, while the churches were contained therein." Bingham, however, following Liberatus, describes the office of the archipresbyter to have been next to that of the bishop, the head of the presbyteral college, and the functions to have consisted in administering all matters pertaining to the church in the absence of the bishop. But this does not describe accurately the office of dean in an English cathedral church. The dean is indeed second to the bishop in rank and dignity, and he is the head of the presbyteral college or chapter; but his functions in no wise consist in administering any affairs in the absence of the bishop. There may be some matters connected with the ordering of the internal arrangements of cathedral churches, respecting which it may be considered a doubtful point whether the authority of the bishop or that of the dean is supreme. But the consideration of any such question leads at once to the due theoretical distinction between the two. With regard to matters spiritual, properly and strictly so called, the bishop is supreme in the cathedral as far as—and no further than—he is supreme in his diocese generally. With regard to matters material and temporal, as concerning the fabric of the cathedral, the arrangement and conduct of the services, and the management of the property of the chapter, &c., the dean (not excluding the due authority of the other members of the chapter, but speaking with reference to the bishop) is

supreme. And the cases in which a doubt might arise are those in which the material arrangements of the fabric or of the services may be thought to involve doctrinal considerations.

The Roman Catholic writers on the subject say that there are two sorts of deans in the church—the deans of cathedral churches, and the rural deans—as has continued to be the case in the English Church. And the probability would seem to be that the former were the successors and representatives of the monastic decurions, the latter of the inspectors of “ten” parishes in the primitive secular church. It is thought by some that the rural dean is the lineal successor of the *chorepiscopus*, who in the early church was the assistant of the bishop, discharging most, if not all, episcopal functions in the rural districts of the diocese. But upon the whole the probability is otherwise. W. Beveridge, W. Cave, Bingham and Basnage all hold that the *chorepiscopi* were true bishops, though Romanist theologians for the most part have maintained that they were simple priests. But if the *chorepiscopus* has any representative in the church of the present day, it seems more likely that the archdeacon is such rather than the dean.

The ordinary use of the term dean, as regards secular bodies of persons, would lead to the belief that the oldest member of a chapter had, as a matter of right, or at least of usage, become the dean thereof. But Bingham (lib. ii. chap. 18) very conclusively shows that such was at no time the case; as is also further indicated by the maxim to the effect that the dean must be selected from the body of the chapter—“*Unus de gremio tantum potest eligi et promoveri ad decanatus dignitatem.*” The duties of the dean in a Roman Catholic cathedral are to preside over the chapter, to declare the decisions to which the chapter may have in its debates arrived by plurality of voices, to exercise inspection over the choir, over the conduct of the capitular body, and over the discipline and regulations of the church; and to celebrate divine service on occasion of the greater festivals of the church in the absence or inability of the bishop. With the exception of the last clause the same statement may be made as to the duties and functions of the deans of Church of England cathedral churches.

Deans had also a place in the judicial system of the Lombard kings in the 8th, 9th and 10th centuries. But the office indicated by that term, so used, seems to have been a very subordinate one; and the name was in all probability adopted with immediate reference to the etymological meaning of the word,—a person having authority over ten (in this case apparently) families. L. A. Muratori, in his *Italian Antiquities*, speaks of the resemblance between the *sallarii* or *sylovani* and the *decani*, and shows that the former had authority in the rural districts, and the latter in towns, or at least in places where the population was sufficiently close for them to have authority over ten families. Nevertheless, a document cited by Muratori from the archives of the canons of Modena, and dated in the year 813, recites the names of several “deaneries” (*decania*), and thus shows that the authority of the dean extended over a certain circumscription of territory.

In the case of the “dean of the sacred college,” the connexion between the application of the term and the etymology of it is not so evident as in the foregoing instances of its use; nor is it by any means clear how and when the idea of seniority was first attached to the word. This office is held by the oldest cardinal—*i.e.* he who has been longest in the enjoyment of the purple, not he who is oldest in years,—who is usually, but not necessarily or always, the bishop of Ostia and Velletri. Perhaps the use of the word “dean,” as signifying simply the eldest member of any corporation or body of men, may have been first adopted from its application to that high dignitary. The dean of the sacred college is in the ecclesiastical hierarchy second to the pope alone. His privileges and special functions are very many; a compendious account of the principal of them may be found in the work of G. Moroni, vol. xix. p. 168.

There are four sorts of deans of whom the law of England takes notice. (1) The dean and chapter are a council subordinate to the bishop, assistant to him in matters spiritual relating to religion,

and in matters temporal relating to the temporalities of the bishopric. The dean and chapter are a corporation, and the dean himself is a corporation sole. Deans are said to be either of the old or of the new foundation—the latter being those created and regulated after the dissolution of the monasteries by Henry VIII. The deans of the old foundation before the Ecclesiastical Commissioners Act 1841 were elected by the chapter on the king's *congé d'élire*; and the deans of the new foundation (and, since the act, of the old foundation also) are appointed by the king's letters patent. It was at one time held that a layman might be dean; but since 1662 priest's orders are a necessary qualification. Deaneries are sinecures in the old sense, *i.e.* they are without cure of souls. The chapter formerly consisted of canons and prebendaries, the dean being the head and an integral part of the corporation. By the Ecclesiastical Commissioners Act 1841, it is enacted that “all the members of the chapter except the dean, in every collegiate and cathedral church in England, and in the cathedral churches of St David and Llandaff, shall be styled canons.” By the same act the dean is required to be in residence eight months, and the canons three months, in every year. The bishop is visitor of the dean and chapter. (2) A dean of peculiars is the chief of certain peculiar churches or chapels. He “hath no chapter, yet is presentative, and hath cure of souls; he hath a *peculiar*, and is not subject to the visitation of the bishop of the diocese.” The only instances of such deaneries are Battle (Sussex), Bocking (Essex) and Stamford (Rutland). The deans of Jersey and Guernsey have similar status. (3) The third dean “hath no cure of souls, but hath a court and a *peculiar*, in which he holdeth plea and jurisdiction of all such ecclesiastical matters as come within his peculiar. Such is the dean of the arches, who is the judge of the court of the arches, the chief court and consistory of the archbishop of Canterbury, so called of Bow Church, where this court was ever wont to be held.” (See ARCHES, COURT OF.) The parish of Bow and twelve others were within the peculiar jurisdiction of the archbishop in spiritual causes, and exempted out of the bishop of London's jurisdiction. They were in 1845 made part of the diocese of London. (4) Rural deans are clergymen whose duty is described as being “to execute the bishop's processes and to inspect the lives and manners of the clergy and people within their jurisdiction.” (See Phillimore's *Ecclesiastical Law*.)

In the colleges of the English universities one of the fellows usually holds the office of “dean,” and is specially charged with the discipline, as distinguished from the teaching functions of the tutors. In some universities the head of a faculty is called “dean,” and in each of these cases the word is used in a non-ecclesiastical and purely titular sense.

DEAN, FOREST OF, a district in the west of Gloucestershire, England, between the Severn and the Wye. It extends northward in an oval form from the junction of these rivers, for a distance of 20 m., with an extreme breadth of 10 m., and still retains its true forest character. The surface is agreeably undulating, its elevation ranging from 120 to nearly 1000 ft., and its sandy peat soil renders it most suitable for the growth of timber, which is the cause of its having been a royal forest from time immemorial. It is recorded that the commanders of the Armada had orders not to leave in it a tree standing. In the reign of Charles I. the forest contained 105,537 trees, and, straitened for money, the king granted it to Sir John Wyntour for £10,000, and a fee farm rent of £2000. The grant was cancelled by Cromwell; but at the Restoration only 30,000 trees were left, and Wyntour, the Royalist commander, having got another grant, destroyed all but 200 trees fit for navy timber. In 1680 an act was passed to enclose 11,000 acres and plant with oak and beech for supply of the dockyards; and the present forest, though not containing very many gigantic oaks, has six “walks” covered with timber in various stages of growth.

The forest is locally governed by two crown-appointed deputy gavellers to superintend the woods and mines, and four verderers elected by the freeholders, whose office, since the extermination of the deer in 1850, is almost purely honorary. From time immemorial all persons born in the hundred of St Briavel's, who

have worked a year and a day in a coal mine, become "free miners," and may work coal in any part of the forest not previously occupied. The forest laws were administered at the Speech-House, a building of the 17th century in the heart of the forest, where the verderers' court is still held. The district contains coal and iron mines, and quarries of building-stone, which fortunately hardly minimize its natural beauty. Near Coleford and Westhury pit workings of the Roman period have been discovered, and the Romans drew large supplies of iron from this district. The scenery is especially fine in the high ground bordering the Wye (*q.v.*), opposite to Symond's Yat above Monmouth, and Tintern above Chepstow. St Briavel's Castle, above Tintern, was the headquarters of the forest officials from an early date and was frequented by King John. It is a moated castle, of which the north-west front remains, standing in a magnificent position high above the Wye.

See H. G. Nicholls, *Forest of Dean* (London, 1858).

**DEANE, RICHARD** (1610–1653), British general-at-sea, major-general and regicide, was a younger son of Edward Deane of Temple Guiting or Guyting in Gloucestershire, where he was born, his baptism taking place on the 8th of July 1610. His family seems to have been strongly Puritan and was related to many of those Buckinghamshire families who were prominent in the parliamentary party. His uncle or great-uncle was Sir Richard Deane, lord mayor of London, 1628–1629. Of Deane's early life nothing is accurately known, but he seems to have had some sea training, possibly on a ship-of-war. At the outbreak of the Civil War he joined the parliamentary army as a volunteer in the artillery, a branch of the service with which he was constantly and honourably associated. In 1644 he held a command in the artillery under Essex in Cornwall and took part in the surrender after Lostwithiel. Essex (*Letter to Sir Philip Stapleton*, Rushworth Collection) calls him "an honest, judicious and stout man," an estimate of Deane borne out by Clarendon's "bold and excellent officer" (book xiv. cap. 27), and he was one of the few officers concerned in the surrender who were retained at the remodelling of the army. Appointed comptroller of the ordnance, he commanded the artillery at Naseby and during Fairfax's campaign in the west of England in 1645. In 1647 he was promoted colonel and given a regiment. In May of that year Cromwell was made lord-general of the forces in Ireland by the parliament, and Deane, as a supporter of Cromwell who had to be reckoned with, was appointed his lieutenant of artillery. Cromwell refused to be thus put out of the way, and Deane followed his example. When the war broke out afresh in 1648 Deane went with Cromwell to Wales. As brigadier-general his leading of the right wing at Preston contributed greatly to the victory. On the entry of the army into London in 1648, Deane superintended the seizure of treasure at the Guildhall and Weavers' Hall the day after Pride "purged" the House of Commons, and accompanied Cromwell to the consultations as to the "settlement of the Kingdom" with Lenthall and Sir Thomas Widdrington, the keeper of the great seal. He is rightly called by Sir J. K. Laughton (in the *Dict. of Nat. Biog.*) Cromwell's "trusted partisan," a character which he maintained in the active and responsible part taken by him in the events which led up to the trial and execution of the king. He was one of the commissioners for the trial, and a member of the committee which examined the witnesses. He signed the death warrant.

Deane's capacities and activities were now required for the navy. In 1649 the office of lord high admiral was put into commission. The first commissioners were Edward Popham, Robert Blake and Deane, with the title of generals-at-sea. His command at sea was interrupted in 1651, when as major-general he was brought back to the army and took part in the battle of Worcester. Later he was made president of the commission for the settlement of Scotland, with supreme command of the military and naval forces. At the end of 1652 Deane returned to his command as general-at-sea, where Monck had succeeded Popham, who had died in 1651. In 1653 Deane was with Blake in command at the battle off Portland and later took the most prominent and active part in the refitting

of the fleet on the reorganization of the naval service. At the outset of the three days' battle off the North Foreland, the 1st, 2nd and 3rd of June 1653, Deane was killed. His body lay in state at Greenwich and after a public funeral was buried in Henry VII.'s chapel at Westminster Abbey, to be disinterred at the Restoration.

See J. Bathurst Deane, *The Life of Richard Deane* (1870).

**DEANE, SILAS** (1737–1789), American diplomat, was born in Groton, Connecticut, on the 24th of December 1737. He graduated at Yale in 1758 and in 1761 was admitted to the bar, but instead of practising became a merchant at Wethersfield, Conn. He took an active part in the movements in Connecticut preceding the War of Independence, and from 1774 to 1776 was a delegate from Connecticut to the Continental Congress. Early in 1776 he was sent to France by Congress, in a semi-official capacity, as a secret agent to induce the French government to lend its financial aid to the colonies. Subsequently he became, with Benjamin Franklin and Arthur Lee, one of the regularly accredited commissioners to France from Congress. On arriving in Paris, Deane at once opened negotiations with Vergennes and Beaumarchais, securing through the latter the shipment of many vessel loads of arms and munitions of war to America. He also enlisted the services of a number of Continental soldiers of fortune, among whom were Lafayette, Baron Johann De Kalb and Thomas Conway. His carelessness in keeping account of his receipts and expenditures, and the differences between himself and Arthur Lee regarding the contracts with Beaumarchais, eventually led, in November 1777, to his recall to face charges, of which Lee's complaints formed the basis. Before returning to America, however, he signed on the 6th of February 1778 the treaties of amity and commerce and of alliance which he and the other commissioners had successfully negotiated. In America he was defended by John Jay and John Adams, and after stating his case to Congress was allowed to return to Paris (1781) to settle his affairs. Differences with various French officials led to his retirement to Holland, where he remained until after the treaty of peace had been signed, when he settled in England. The publication of some "intercepted" letters in Rivington's *Royal Gazette* in New York (1781), in which Deane declared his belief that the struggle for independence was hopeless and counselled a return to British allegiance, aroused such animosity against him in America that for some years he remained in England. He died on shipboard in Deal harbour, England, on the 23rd of September 1789 after having embarked for America on a Boston packet. No evidence of his dishonesty was ever discovered, and Congress recognized the validity of his claims by voting \$37,000 to his heirs in 1842. He published his defence in *An Address to the Free and Independent Citizens of the United States of North America* (Hartford, Conn., and London, 1784).

*The Correspondence of Silas Deane* was published in the Connecticut Historical Society's *Collections*, vol. ii.; and *The Deane Papers*, in 5 vols., in the New York Historical Society's *Collections* (1887–1890). See also Winsor's *Narrative and Critical History*, vol. vii. chap. i., and Wharton's *Revolutionary Diplomatic Correspondence of the United States* (6 vols., Washington, 1889).

**DEATH**, the permanent cessation of the vital functions in the bodies of animals and plants, the end of life or act of dying. The word is the English representative of the substantive common to Teutonic languages, as "dead" is of the adjective, and "die" of the verb; the ultimate origin is the pre-Teutonic verbal stem *dau-*; cf. Ger *Tod*, Dutch *dood*, Swed. and Dan. *död*.

For the scientific aspects of the processes involved in life and its cessation see BIOLOGY, PHYSIOLOGY, PATHOLOGY, and allied articles; and for the consideration of the prolongation of life see LONGEVITY. Here it is only necessary to deal with the more primitive views of death and with certain legal aspects.

*Ethnology.*—To the savage, death from natural causes is inexplicable. At all times and in all lands, if he reflects upon death at all, he fails to understand it as a natural phenomenon; nor in its presence is he awed or curious. Man in a primitive state has for his dead an almost animal indifference. The researches of archaeologists prove that Quaternary Man cared little what became of his fellow-creature's body. And this lack



of interest is found to-day as a general characteristic of savages. The Goajiros of Venezuela bury their dead, they confess, simply to get rid of them. The Galibis of Guiana, when asked the meaning of their curious funeral ceremony, which consists in dancing on the grave, replied that they did it to stamp down the earth. Fuegians, Bushmen, Veddahs, show the same lack of concern and interest in the memory of the dead. Even the Eskimos, conspicuous as they are for their intelligence and sociability, save themselves the trouble of caring for their sick and old by walling them up and leaving them to die in a lonely hut; the Chukches stone or strangle them to death; some Indian tribes give them over to tigers, and the Battas of Sumatra eat them. This indifference is not dictated by any realization that death means annihilation of the personality. The savage conception of a future state is one that involves no real break in the continuity of life as he leads it. If a man dies without being wounded he is considered to be the victim of the sorcerers and the evil spirits with which they consort. Throughout Africa the death of anyone is ascribed to the magicians of some hostile tribe or to the malicious act of a neighbour. A culprit is easily discovered either by an appeal to a local diviner or in torturing some one into confession. In Australia it is the same. Mr Andrew Lang says that "whenever a native dies, no matter how evident it may be that death has been the result of natural causes, it is at once set down that the defunct was bewitched." The Bechuanas and all Kaffir tribes believe that death, even at an advanced age, if not from hunger or violence, is due to witchcraft, and blood is required to expiate or avenge it. Similar beliefs are found among the Papuans, and among the Indians of both Americas. The history of witchcraft in Europe and its attendant horrors, so vividly painted in Lecky's *Rise of Rationalism*, are but echoes of this universal refusal of savage man to accept death as the natural end of life. Even to-day the ignorant peasantry of many European countries, Russia, Galicia and elsewhere, believe that all disease is the work of demons, and that medicinal herbs owe their curative properties to their being the materialized forms of benevolent spirits.

This animistic tendency is a marked characteristic of primitive Man in every land. The savage explains the processes of inanimate nature by assuming that living beings or spirits, possessed of capacities similar to his own, are within the inanimate object. The growth of a tree, the spark struck from a flint, the devastating floods of a river, mean to him the natural actions of beings within the tree, stone or water. And thus too he explains to himself the phenomena of human life, believing that each man has within him a mannikin or animal which dictates his actions in life. This miniature man is the savage's conception of the soul; sleep and trance being regarded as the temporary, death as the permanent, absence of the soul. Each individual is thus deemed to have a dual existence. This "subliminal" self (in modern terminology) has many forms. The Hurons thought that it possessed head, body, arms and legs, in fact that it was an exact miniature of a man. The Nootkas of British Columbia regard it as a tiny man, living in the crown of the head. So long as it stands erect, its possessor is well, but if it falls from its position the misfortunes of ill-health and madness at once assail him. The ancient Egyptian believed in the soul or "double." The inhabitants of Nias, an island to the west of Sumatra, have the strange belief that to everyone before birth is given the choice of a long and heavy or short and light soul (a parallel belief may be found in early Greek philosophy), and his choice determines the length of life. Sometimes the soul is conceived as a bird. The Bororos of Brazil fancy that in that shape the soul of a sleeper passes out of the body during night-time, returning to him at his awakening. The Bella Coola Indians say the soul is a bird enclosed in an egg and lives in the nape of the neck. If the shell bursts and the soul flies away, the man must die. If however the bird flies away, egg and all, then he faints or loses his reason. A popular superstition in Bohemia assumes that the soul in the shape of a white bird leaves the body by way of the mouth. Among the Battas of Sumatra rice or grain is sprinkled on the head of a man who returns from a dangerous enterprise, and in

the latter case the grains are called *padiruma tondi*, "means to make the soul (*tondi*) stay at home." In Java the new-born babe is placed in a hen-coop, and the mother makes a clucking noise, as if she were a hen, to attract the child's soul. It is regarded by many savage peoples as highly dangerous to arouse a sleeper suddenly, as his soul may not have time to return. Still more dangerous is it to move a sleeper, for the soul on its return might not be able to find the body. Flies and butterflies are forms which the souls are believed by some races to take, and the Esthonians of the island of Oesel think that the gusts of wind which whirl tornado-like through the roads are the souls of old women seeking what they can find.

But more widespread perhaps than any belief, from its simplicity doubtless, is the idea that the body's shadow or reflexion is the soul. The Basutos think that crocodiles can devour the shadow of a man cast on the surface of water. In many parts of the world sorcerers are credited with supernatural powers over a man by an attack on his shadow. The sick man is considered to have lost his shadow or a part of it. Dante refers to the shadowless spectre of Virgil, and the folklore of many European countries affords examples of the prevalence of the superstition that a man must be as careful of his shadow as of his body. In the same way the reflexion-soul is thought to be subject to a malice of enemies or attacks of beasts and has been the cause of superstitions which in one form or another exist to-day. From the Fijian and Andaman islander who exhibits abject terror at seeing himself in a glass or in water, to the English or European peasant who covers up the mirrors or turns them to the wall, upon a death occurring, lest an inmate of the house should see his own face and have his own speedy demise thus prognosticated, the idea holds its ground. It was probably the origin of the story of Narcissus, and there is scarcely a race which is free from the haunting dread. Lastly the soul is pictured as being a man's breath (*anima*), and this again has come down to us in literature, evidenced by the fact that the word "breath" has become a synonym for life itself. The "last breath" has meant more than a mere metaphor. It expresses the savage belief that there departs from the dying in the final expiration a something tangible, capable of separate existence—the soul. Among the Romans custom imposed a sacred duty on the nearest relative, usually the heir, to inhale the "last breath" of the dying. Moreover the classics bear evidence to the sanctity with which sentiment surrounded the last kiss; Cicero, in his speech against Verres, saying "*Matres ab extremo complexu liberum exclusae: quae nihil aliud orabant nisi ut filiorum extremum spiritum ore excipere sibi liceret.*" Virgil, too, refers in the *Aeneid*, iv. 684, to the custom, which survives to-day as a ceremonial practice among many savage and semi-civilized people.

From the inability of the savage in all ages and in all lands to comprehend death as a natural phenomenon, there results a tendency to personify death, and myths are invented to account for its origin. Sometimes it is a "taboo" which has been broken and gives Death power over man. In New Zealand Maui, the divine hero of Polynesia, was not properly baptized. In Australia a woman was told not to go near a tree where a bat lived: she infringed the prohibition, the bat fluttered out, and death resulted. The Ningphoos were dismissed from Paradise and became mortal because one of them bathed in water which had been "tabooed" (Dalton, p. 13). Other versions of the Death-myth in Polynesia relate that Maui stole a march on Night as she slept, and would have passed right through her to destroy her, but a little bird which sings at sunset woke her, she destroyed Maui, and men lost immortality. In India Yama, the god of Death, is assumed, like Maui, to have been the first to "spy out the path to the other world." In the Solomon Islands (*Jour. Anth. Inst.*, February 1881) "Koevari was the author of death, by resuming her cast-off skin." The same story is told in the Banks Islands. The Greek myth (Hesiod, *Works and Days*, 90) alleged that mortals lived "without ill diseases that give death to men" till the cover was lifted from the box of Pandora. This personification of Death has had as a consequence the introduction into the folklore of many lands of stories, often

humorous, of the tricks played on the Enemy of Mankind. Thus Sisyphus fettered Death, keeping him prisoner till rescued by Ares; in Venetian folklore Beppo ties him up in a bag for eighteen months; while in Sicily an innkeeper corks him up in a bottle, and a monk keeps him in his pouch for forty years. The German parallel is Gambling Hansel, who kept Death up a tree for seven years. Such examples might be multiplied unendingly, but enough has been said to show that the attitude of civilized man towards the sphinx-riddle of his end has been in part dictated and is even still influenced by the savage belief that to die is unnatural.

**Law—Registration.**—The registration of burials in England goes back to the time of Thomas Cromwell, who in 1538 instituted the keeping of parish registers. Statutory measures were taken from time to time to ensure the preservation of registers of burials, but it was not until 1836 (the Births and Deaths Registration Act) that the registration of deaths became a national concern. Other acts dealing with death registration were subsequently passed, and the whole law for England consolidated by the Births and Deaths Registration Act 1874. By that act, the registration of every death and the cause of the death is compulsory. When a person dies in a house information of the death and the particulars required to be registered must be given within five days of the death to the registrar to the best of the person's knowledge and belief by one of the following persons:—(1) The nearest relative of the deceased present at the death, or in attendance during the last illness of the deceased. If they fail, then (2) some other relative of the deceased in the same sub-district (registrar's) as the deceased. In default of relatives, (3) some person present at the death, or the occupier of the house in which, to his knowledge, the death took place. If all the above fail, (4) some inmate of the house, or the person causing the body of the deceased to be buried. The person giving the information must sign the register. Similarly, also, information must be given concerning death where the deceased dies not in a house.

Where written notice of the death, accompanied by a medical certificate of the cause of death, is sent to the registrar, information must nevertheless be given and the register signed within fourteen days after the death by the person giving the notice or some other person as required by the act. Failure to give information of death, or to comply with the registrar's requisitions, entails a penalty not exceeding forty shillings, and making false statements or certificates, or forging or falsifying them, is punishable either summarily within six months, or on indictment within three years of the offence. Before burial takes place the clergyman or other person conducting the funeral or religious service must have the registrar's certificate that the death of the deceased person has been duly registered, or else a coroner's order or warrant. Failing the certificate, the clergyman cannot refuse to bury, but he must forthwith give notice in writing to the registrar. Failure to do so within seven days involves a penalty not exceeding ten pounds. Children must not be registered as still-born without a medical certificate or a signed declaration from some one who would have been required, if the child had been born alive, to give information concerning the birth, that the child was still-born and that no medical man was present at the birth, or a coroner's order. The registration of deaths at sea is regulated by the act of 1874 together with the Merchant Shipping Act 1894. See further BIRTH and BURIAL AND BURIAL ACTS. Registers of death are, in law, evidence of the fact of death, and the entry, or a certified copy of it, will be sufficient evidence without a certificate of burial, although it is desirable that it should also be produced.

**Presumption of Death.**—The fact of death may, in English law, be proved not only by direct but by presumptive evidence. When a person disappears, so that no direct proof of his whereabouts or death is obtainable, death may be presumed at the expiration of seven years from the period when the person was last heard of. It is always, however, a matter of fact for the jury, and the onus of proving the death lies on the party who asserts it. In Scotland, by the Presumption of Life (Scotland) Act 1891, the presumption is statutory. In those cases where people disappear

under circumstances which create a strong probability of death, the court may, for the purpose of probate or administration, presume the death before the lapse of seven years. The question of survivorship, where two or more persons are shown to have perished by the same catastrophe, as in cases of shipwreck, has been much discussed. It was at one time thought that there might be a presumption of survivorship in favour of the younger as against the older, of the male as against the female, &c. But it is now clear that there is no such presumption (*In re Alston*, 1892, P. 142). This is also the rule in most states of the American Union. The doctrine of survivorship originated in the Roman Law, which had recourse to certain artificial presumptions, where the particular circumstances connected with deaths were unknown. Some of the systems founded on the civil law, as the French code, have adopted certain rules of survivorship.

**Civil Death** is an expression used, in law, in contradistinction to natural death. Formerly, a man was said to be dead in law (1) when he entered a monastery and became professed in religion; (2) when he abjured the realm; (3) when he was attainted of treason or felony. Since the suppression of the monasteries there has been no legal establishment for professed persons in England, and the first distinction has therefore disappeared, though for long after the original reason had ceased to make it necessary grants of life estates were usually made for the terms of a man's natural life. The act abolishing sanctuaries (1623) did away with civil death by abjuration; and the Forfeiture Act 1870, that on attainder for treason or felony.

For the tax levied on the estate of deceased persons, and sometimes called "death duty," see SUCCESSION DUTY.

For the statistics of the death-rate of the United Kingdom as compared with that of the various European countries see UNITED KINGDOM. See also the articles ANNUITY; CAPITAL PUNISHMENT; CREMATION; INSURANCE; MEDICAL JURISPRUDENCE, &c.

**DEATH-WARNING**, a term used in psychical research for an intimation of the death of another person received by other than the ordinary sensory channels, *i.e.* by (1) a sensory hallucination or (2) a massive sensation, both being of telepathic origin. (See TELEPATHY.) Both among civilized and uncivilized peoples there is a widespread belief that the apparition of a living person is an omen of death; but until the Society of Psychical Research undertook the statistical examination of the question, there were no data for estimating the value of the belief. In 1885 a collection of spontaneous cases and a discussion of the evidence was published under the title *Phantasms of the Living*, and though the standard of evidence was lower than at the present time, a substantial body of testimony, including many striking cases, was there put forward. In 1889 a further inquiry was undertaken, known as the "Censns of Hallucinations," which provided information as to the percentage of individuals in the general population who, at some period of their lives, while they were in a normal state of health, had had "a vivid impression of seeing or being touched by a living being or inanimate object, or of hearing a voice; which impression, so far as they could discover, was not due to any external cause." To the census question about 17,000 answers were received, and after making all deductions it appeared that death coincidences numbered about 30 in 1300 cases of recognized apparitions; or about 1 in 43, whereas if chance alone operated the coincidences would have been in the proportion of 1 to 19,000. As a result of the inquiry the committee held it to be proved that "between deaths and apparitions of the dying person a connexion exists which is not due to chance alone." From an evidential point of view the apparition is the most valuable class of death-warning, inasmuch as recognition is more difficult in the case of an auditory hallucination, even where it takes the form of spoken words; moreover, auditory hallucinations coinciding with deaths may be mere knocks, ringing of bells, &c.; tactile hallucinations are still more difficult of recognition; and the hallucinations of smell which are sometimes found as death-warnings rarely have anything to associate them specially with the dead person. Occasionally the death-warning is in the form of an apparition of some other person; it may also take the form of a temporary feeling of intense depression or other massive sensation.

**BIBLIOGRAPHY.**—Podmore, Gurney and Myers, *Phantasms of the Living* (1885); for the Census Report see *Proceedings of the Society for Psychical Research*, part xxvi.; see also F. Podmore, *Apparitions and Thought Transference*. For a criticism of the results of the Census see E. Parish, *Hallucinations and Illusions* and *Zur Kritik des telepathischen Beweismaterials*, and Mrs Sidgwick's refutation in *Proc. S.P.R.* part xxxiii. 589-601. The *Journal of the S.P.R.* contains the most striking spontaneous cases received from time to time by the society. (N. W. T.)

**DEATH-WATCH**, a popular name applied to insects of two distinct families, which burrow and live in old furniture and produce the mysterious "ticking" vulgarly supposed to foretell the death of some inmate of the house. The best known, because the largest, is a small beetle, *Anobium striatum*, belonging to the family *Ptinidae*. The "ticking," in reality a sexual call, like the chirp of a grasshopper, is produced by the beetle rapidly striking its head against the hard and dry woodwork. In the case of the smaller death-watches, some of the so-called book-lice of the family *Psocidae*, the exact way in which the sound is caused has not been satisfactorily explained. Indeed the ability of such small and soft insects to give rise to audible sounds has been seriously doubted; but it is impossible to ignore the positive evidence on the point. The names *Atropis divinatoria* and *Clothilla pulsatoria*, given to two of the commoner forms, bear witness both to a belief in a causal connexion between these insects and the ticking, and to the superstition regarding the fateful significance of the sound.

**DE BARY, HEINRICH ANTON** (1831-1888), German botanist, was of Belgian extraction, though his family had long been settled in Germany, and was born on the 26th of January 1831, at Frankfort-on-Main. From 1849 to 1853 he studied medicine at Heidelberg, Marburg and Berlin. In 1853 he settled at Frankfort as a surgeon. In 1854 he became privat-docent for botany in Tübingen, and professor of botany at Freiburg in 1855. In 1867 he migrated to Halle, and in 1872 to Strassburg, where he was the first rector of the newly constituted university, and where he died on the 19th of January 1888.

Although one of his largest and most important works was on the *Comparative Anatomy of Ferns and Phanerogams* (1877), and notwithstanding his admirable acquaintance with systematic and field botany generally, de Bary will always be remembered as the founder of modern mycology. This branch of botany he completely revolutionized in 1866 by the publication of his celebrated *Morphologie und Physiologie d. Pilze*, &c., a classic which he rewrote in 1884, and which has had a world-wide influence on biology. His clear appreciation of the real significance of symbiosis and the dual nature of lichens is one of his most striking achievements, and in many ways he showed powers of generalizing in regard to the evolution of organisms, which alone would have made him a distinguished man. It was as an investigator of the then mysterious Fungi, however, that de Bary stands out first and foremost among the biologists of the 19th century. He not only laid bare the complex facts of the life-history of many forms,—e.g. the Ustilagineae, Peronosporae, Uredineae and many Ascomycetes,—treating them from the developmental point of view, in opposition to the then prevailing anatomical method, but he insisted on the necessity of tracing the evolution of each organism from spore to spore, and by his methods of culture and accurate observation brought to light numerous facts previously undreamt of. These his keen perception and insight continually employed as the basis for hypotheses, which in turn he tested with an experimental skill and critical faculty rarely equalled and probably never surpassed. One of his most fruitful discoveries was the true meaning of infection as a morphological and physiological process. He traced this step by step in *Phytophthora*, *Cystopus*, *Puccinia*, and other Fungi, and so placed before the world in a clear light the significance of parasitism. He then showed by numerous examples wherein lay the essential differences between a parasite and a saprophyte; these were by no means clear in 1860-1870, though he himself had recognized them as early as 1853, as is shown by his work, *Die Brandpilze*.

These researches led to the explanation of epidemic diseases,

and de Bary's contributions to this subject were fundamental, as witness his classical work on the potato disease in 1861. They also led to his striking discovery of *heteroecism* (or *metoecism*) in the Uredineae, the truth of which he demonstrated in wheat rust experimentally, and so clearly that his classical example (1863) has always been confirmed by subsequent observers, though much more has been discovered as to details. It is difficult to estimate the relative importance of de Bary's astoundingly accurate work on the sexuality of the Fungi. He not only described the phenomena of sexuality in Peronosporae and Ascomycetes—*Eurotium*, *Erysiphe*, *Peziza*, &c.—but also established the existence of parthenogenesis and apogamy on so firm a basis that it is doubtful if all the combined workers who have succeeded him, and who have brought forward contending hypotheses in opposition to his views, have succeeded in shaking the doctrine he established before modern cytological methods existed. In one case, at least (*Pyronema confluens*), the most skilful investigations, with every modern appliance, have shown that de Bary described the sexual organs and process accurately.

It is impossible here to mention all the discoveries made by de Bary. He did much work on the Chytridiae, Ustilagineae, Exoascae and Phalloideae, as well as on that remarkable group the Myxomycetes, or, as he himself termed them, *Mycetozoa*, almost every step of which was of permanent value, and started lines of investigation which have proved fruitful in the hands of his pupils. Nor must we overlook the important contributions to algology contained in his earlier monograph on the Conjugatae (1858), and investigations on Nostocaceae (1863), *Chara* (1871), *Acetabularia* (1869), &c. De Bary seems to have held aloof from the Bacteria for many years, but it was characteristic of the man that, after working at them in order to include an account of the group in the second edition of his book in 1884, he found opportunity to bring the whole subject of bacteriology under the influence of his genius, the outcome being his brilliant *Lectures on Bacteria* in 1885. De Bary's personal influence was immense. Every one of his numerous pupils was enthusiastic in admiration of his kind nature and genial criticism, his humorous sarcasm, and his profound insight, knowledge and originality.

Memoirs of de Bary's life will be found in *Bot. Centralbl.* (1888), xxxiv. 93, by Wilhelm; *Ber. d. d. bot. Ges.* vol. vi. (1888) p. viii., by Reess, each with a list of his works; *Bot. Zeitung* (1889), vol. xlvii. No. 3, by Graf zu Soems-Laubach. (H. M. W.)

**DEBENTURES and DEBENTURE STOCK.** One of the many advantages incident to incorporation under the English Companies Acts is found in the facilities which such incorporation affords a trading concern for borrowing on debentures or debenture stock. More than five hundred millions of money are now invested in these forms of security. Borrowing was not specifically dealt with by the Companies Acts prior to the act of 1900, but that it was contemplated by the legislature is evident from the provision in § 43 of the act of 1862 for a company keeping a register of mortgages and charges. The policy of the legislature in this, as in other matters connected with trading companies, was apparently to leave the company to determine whether borrowing should or should not form one of its objects.

The first principle to be borne in mind is that a company cannot borrow unless it is expressly or impliedly authorized to do so by its memorandum of association. In the case of a trading company borrowing is impliedly authorized as a necessary incident of carrying on the company's business. Thus a company established for the conveyance of passengers and luggage by omnibuses, a company formed to buy and run vessels between England and Australia, and a company whose objects included discounting approved commercial bills, have all been held to be trading companies with an incidental power of borrowing as such to a reasonable amount. A building society, on the other hand, has no inherent power of borrowing (though a limited statutory power was conferred on such societies by the Building Societies Act 1874); nor has a society formed not for gain but to promote art, science, religion, charity or any other useful object. Public companies formed to carry out some undertaking of public utility, such as docks, water works, or gas works, and

governed by the Companies Clauses Acts, have only limited powers of borrowing.

An implied power of borrowing, even when it attaches, is too inconvenient to be relied on in practice, and an express power is always now inserted in a joint stock company's memorandum of association. This power is in the most general terms. It is left to the articles to define the amount to be borrowed, the nature of the security, and the conditions, if any,—such as the sanction of a general meeting of shareholders,—on which the power is to be exercised. Under the Companies Act 1908, § 87, a company cannot exercise any borrowing power until it has fulfilled the conditions prescribed by the act entitling it to commence business: one of which is that the company must have obtained its "minimum subscription." A person who is proposing to lend money to a company must be careful to acquaint himself with any statutory regulations of this kind, and also to see (1) that the memorandum and articles of association authorize borrowing, and (2) that the borrowing limit is not being exceeded, for if it should turn out that the borrowing was in excess of the company's powers and *ultra vires*, the company cannot be bound, and the borrower's only remedy is against the directors for breach of warranty of authority, or to be surrogated to the rights of any creditors who may have been paid out of the borrowed moneys.

A company proposing to borrow usually issues a prospectus, similar to the ordinary share prospectus, stating the amount of the issue, the dates for payment, the particulars of the property to be comprised in the security, the terms as to redemption, and so on, and inviting the public to subscribe. Underwriting is also resorted to, as in the case of shares, to ensure that the issue is taken up. There is no objection to a company issuing debentures or debenture stock at a discount, as there is to its issuing its shares at a discount. It must borrow on the best terms its credit will enable it to obtain. A prospectus inviting subscriptions for debentures or debenture stock comes within the terms of the Directors' Liability Act 1890 (re-enacted in Companies Act 1908, § 84), and persons who are parties to it have the onus cast upon them, should the prospectus contain any misstatements, of showing that, at the time when they issued the prospectus, they had reasonable grounds to believe, and did in fact believe, that the statements in question were true; otherwise they will be liable to pay compensation to any person injured by the misstatements. A debenture prospectus is also within the terms of the Companies Act 1908. It must be filed with the registrar of joint stock companies (§ 80) and must contain all the particulars specified in § 81 of the act. (See COMPANY.)

The usual mode of borrowing by a company is either on debentures or debenture stock. Etymologically, debenture is merely the Latin word *debentur*,—The first word in a document in common use by the crown in early times admitting indebtedness to its servants or soldiers. This was the germ of a security which has now, with the expansion of joint stock company enterprise, grown into an instrument of considerable complexity.

Debentures may be classified in various ways. From the point of view of the security they are either (1) debentures (simply); (2) mortgage debentures; (3) debenture bonds. In the debenture the security is a floating charge. In the mortgage debenture there is also a floating charge, but the property forming the principal part of the security is conveyed by the company to trustees under a trust deed for the benefit of the debenture-holders. In the debenture bond there is no security proper: only the covenant for payment by the company. For purposes of title and transfer, debentures are either "registered" or "to bearer." For purposes of payment they are either "terminable" or "perpetual" (see Companies Act 1908, § 103).

*The Floating Debenture.*—The form of debenture chiefly in use at the present day is that secured by a floating charge. By it the company covenants to pay to the holder thereof the sum secured by the debenture on a specified day (usually ten or fifteen years after the date of issue), or at such earlier date as the principal moneys become due under the provisions of the security, and in the meantime the company covenants to pay interest on the

principal moneys until payment, or until the security becomes enforceable under the conditions; and the company further charges its undertaking and all its property, including its uncalled capital, with the payment of the amount secured by the debentures. Uncalled capital if included must be expressly mentioned, because the word "property" by itself will not cover uncalled capital which is only property potentially, *i.e.* when called up. This is the body of the instrument; on its back is endorsed a series of conditions, constituting the terms on which the debenture is issued. Thus the debenture-holders are to rank *pari passu* with one another against the security; the debenture is to be transferable free from equities between the company and the original holder; the charge is to be a floating charge, and the debenture-holders' moneys are to become immediately repayable and the charges enforceable in certain events: for instance, if the interest is in arrear for (say) two or three months, or if a winding-up order is made against the company, or a resolution for winding up is passed. Other events indicative of insolvency are sometimes added in which payment is to be accelerated. The conditions also provide for the mode and form of transfer of the debentures, the death or bankruptcy of the holder, the place of payment, &c. The most characteristic feature of the security—the floating charge—grew naturally out of a charge on a company's undertaking as a going concern. Such a charge could only be made practicable by leaving the company free to deal with and dispose of its property in the ordinary course of its business—to sell, mortgage, lease, and exchange it as if no charge existed: and this is how the security works. The debenture-holders give the directors an implied licence to deal with and dispose of the property comprised in the security until the happening of any of the events upon which the debenture-holders' money becomes under the debenture conditions immediately repayable. Pending this the charge is dormant. The licence extends, however, only to dealings in the ordinary course of business. Payment by a company of its just debts is always in the ordinary course of business, but satisfaction by execution levied *in invitum* is not. This floating form of security is found very convenient both to the borrowing company and to the lender. The company is not embarrassed by the charge, while the lender has a security covering the whole assets for the time being, and can intervene at any moment by obtaining a receiver if his security is imperilled, even though none of the events in which the principal moneys are made payable have happened. If any of them has happened, for instance default in payment of interest, or a resolution by the company to wind up, the payment of the principal moneys is accelerated, and a debenture-holder can at once commence an action to obtain payment and to realize his security. At times a proviso is inserted in the conditions endorsed on the debenture, that the company is not to create any mortgage or charge ranking in priority to or *pari passu* with that contained in the debentures. Very nice questions of priority have arisen under such a clause. A floating charge created by a company within three months of its being wound up will now be invalid under § 12 of the Companies Act 1908 unless the company is shown to have been solvent at the time, but there is a saving clause for cash paid under the security and interest at 5%.

*Trust Deeds.*—When the amount borrowed by a company is large, the company commonly executes a trust deed by way of further security. The object of such a trust deed is twofold: (1) it conveys specific property to the trustees of the deed by way of legal mortgage (the charge contained in the debentures is only an equitable security), and it further charges all the remaining assets in favour of the debenture-holders, with appropriate provisions for enabling them, in certain events similar to those expressed in the debenture conditions, to enforce the security, and for that purpose to enter into possession and carry on the business, or to sell it and distribute the proceeds; (2) it organizes the debenture-holders and constitutes in the trustees of the deed a body of experienced business men who can watch over the interests of the debenture-holders and take steps for their protection if necessary. In particular it provides machinery for the calling of meetings of debenture-holders by the trustees,

and empowers a majority of (say) two-thirds or three-fourths in number and value at such meeting to bind the rest to any compromise or arrangement with the company which such majorities may deem beneficial. This is found a very useful power, and may save recourse to a scheme or arrangement first sanctioned under the machinery of the Joint Stock Companies Arrangement Act 1870 (Companies Act 1908, § 120).

**Registration of Mortgages and Charges.**—A company is bound, under the Companies Act 1862, to keep a register of mortgages and charges, but the register is only open for the inspection of persons who have actually become creditors of the company, not of persons who may be thinking of giving it credit, and the legislature recognizing its inadequacy provided in the Companies Act 1900 (§ 4 of act of 1908) for a public register at Somerset House of all mortgages and charges of certain specified classes by a company. If not registered within twenty-one days from their creation such mortgages and charges are made void—so far as they are securities—against the liquidator and any creditor of the company, but the debenture-holders retain the rights of unsecured creditors. An extension of the time for registering may be granted by the court, but it will only be without prejudice to the rights of third persons acquired before actual registration. These provisions for registration as amended are contained in the Companies Act 1908 (§ 93).

**Debentures Registered and to Bearer.**—Debentures are, for purposes of title and transfer, of two kinds—(1) registered debentures, and (2) debentures to bearer. Registered debentures are transferable only in the books of the company. Debentures to bearer are negotiable instruments and pass by delivery. Coupons for interest are attached. Sometimes debentures to bearer are made exchangeable for registered debentures and vice versa.

**Redemption.**—A company generally reserves to itself a right of redeeming the security before the date fixed by the debenture for repayment; and accordingly a power for that purpose is commonly inserted in the conditions. But as debenture-holders, who have got a satisfactory security, do not wish to be paid off, the right of redemption is often qualified so as not to arise till (say) five years after issue, and a premium of 5% is made payable by way of bonus to the redeemed debenture-holder. Sometimes the number of debentures to be redeemed each year is limited. The selection is made by drawings held in the presence of the directors. A sinking fund is a convenient means frequently resorted to for redemption of a debenture debt, and is especially suitable where the security is of a wasting character, leaseholds, mining property or a patent. Such a fund is formed by the company setting apart a certain sum each year out of the profits of the company after payment of interest on the debentures. Redeemed debentures may in certain cases be reissued; see Companies Act 1908 (§ 104).

**Debenture Stock.**—Debenture stock bears the same relation to debentures that stock does to shares. "Debenture stock," as Lord Lindley states (*Companies*, 5th ed., 195), "is merely borrowed capital consolidated into one mass for the sake of convenience. Instead of each lender having a separate bond or mortgage, he has a certificate entitling him to a certain sum, being a portion of one large loan." This sum is not uniform, as in the case of debentures, but variable. One debenture-stockholder, for instance, may hold £20 of the debenture stock, another £20,000. Debenture stock is usually issued in multiples of £10 or sometimes of £1, and is made transferable in sums of any amount not involving a fraction of £1. It is this divisibility of stock, whether debenture or ordinary stock, into quantities of any amount, which constitutes in fact its chief characteristic, and its convenience from a business point of view. It facilitates dealing with the stock, and also enables investors with only a small amount to invest to become stockholders. The property comprised in this security is generally the same as in the case of debentures. Debenture stock created by trading companies differs in various particulars from debenture stock created by public companies governed by the Companies Clauses Act. The debenture stock of trading companies is created by a contract made between the company and trustees for the debenture-

stockholders. This contract is known as a debenture-stockholders' trust deed, and is analogous in its provisions to the trust deed above described as used to secure debentures. By such a deed the company acknowledges its indebtedness to the trustees, as representing the debenture-stockholders, to the amount of the sum advanced, covenants to pay it, and conveys the property by way of security to the trustees with all the requisite powers and provisions for enabling them to enforce the security on default in payment of interest by the company or on the happening of certain specified events evidencing insolvency. The company further, in pursuance of the contract, enters the names of the subsisting stockholders in a register, and issues certificates for the amount of their respective holdings. These certificates have, like debentures, the conditions of the security indorsed on their back. Debenture stock is also issued to bearer. A deed securing debenture stock requires an *ad valorem* stamp.

**Debenture Scrip.**—Debentures and debenture stock are usually made payable in instalments, for example 10% on application, 10% on allotment and the remainder at intervals of a few months. Until these payments are complete the securities are not issued, but to enable the subscriber to deal with his security pending completion the company issues to him an interim scrip certificate acknowledging his title and exchangeable on payment of the remaining instalments for debentures or debenture stock certificates. If a subscriber for debentures made default in payment the company could not compel him specifically to perform his contract, the theory of law being that the company could get the loan elsewhere, but this inconvenience is now removed (see § 105 of the Companies Act 1908).

**Remedies.**—When debenture-holders' security becomes enforceable there are a variety of remedies open to them. These fall into two classes—(1) remedies available without the aid of the court; (2) remedies available only with the aid of the court.

1. If there is a trust deed, the trustees may appoint a receiver of the property comprised in the security, and they may also sell under the powers contained in the deed, or under § 25 of the Conveyancing Act 1881. Sometimes, where there is no trust deed, similar powers—to appoint a receiver and to sell—are inserted in the conditions indorsed on the debentures.

2. The remedies with the aid of the court are—(a) an action by one or more debenture-holders on behalf of all for a receiver and to realize the security; (b) an originating summons for sale or other relief, under Rules of Supreme Court, 1883, O. IV. r. 5A; (c) an action for foreclosure where the security is deficient (all the debenture-holders must be parties to this proceeding); (d) a winding-up petition. Of these modes of proceeding, the first is by far the most common and most convenient. Immediately on the issue of the writ in the action the plaintiff applies for the appointment of a receiver to protect the security, or if the security comprises a going business, a receiver *and manager*. In due course the action comes on for judgment, usually on agreed minutes, when the court directs accounts and inquiries as to who are the holders of the debentures, what is due to them, what property is comprised in the security, and gives leave to any of the parties to apply in chambers for a sale. If the company has gone into liquidation, leave must be obtained to commence or continue the action, but such leave in the case of debenture-holders is *ex debito justitiae*. A debenture-holder action when the company is in winding up is always now transferred to the judge having the control of the winding-up proceedings. The administration of a company's assets in such actions by debenture-holders (debenture-holders' liquidations, as they are called) has of late encroached very much on the ordinary administration of winding up, and it cannot be denied that great hardship is often inflicted by the floating security on the company's unsecured creditors, who find that everything belonging to the company, uncalled capital included, has been pledged to the debenture-holders. The conventional answer is that such creditors might and ought to have inspected the company's register of mortgages and charges. The matter was fully considered by the departmental board of trade committee which reported in July 1906,



but the committee, looking at the business convenience of the floating charge, saw no reason for recommending an alteration in the law.

**Reconstruction.**—When a company reconstructs, as it often does in these days, the rights of debenture-holders have to be provided for. Reconstructions are mainly of two kinds—(1) by arrangement, under the Joint Stock Companies Arrangement Act 1870, amended in 1900 and 1907, incorporated in act of 1908 (§ 120), and (2) by sale and transfer of assets, either under § 192 of the act of 1908, or under a power in the company's memorandum of association. By the procedure provided under (1) a petition for the sanction of the court to a scheme is presented, and the court thereupon directs meetings of creditors, including debenture-holders, to be held. A three-fourths majority in value of debenture-holders present at the meeting in person or by proxy binds the rest. Debenture-holders claiming to vote must produce their debentures at or before the meeting. Under the other mode of reconstruction—sale and transfer of assets—there is usually a novation, and the debenture-holders accept the security of the new company in the shape of debentures of equivalent value or—occasionally—of fully paid preference shares.

A point in this connexion, which involves some hardship to debenture-holders, may here be adverted to. It is a not uncommon practice for a solvent company to pass a resolution to wind up voluntarily for the purpose of reconstructing. The effect of this is to accelerate payment of the security, and the debenture-holders have to accept their principal and interest only, parting with a good security and perhaps a premium which would have accrued to them in a year or two. The company is thus enabled by its own act to redeem the reluctant debenture-holder on terms most advantageous to itself. To obviate this hardship, it is now a usual thing in a debenture-holders' trust deed to provide—the committee of the London Stock Exchange indeed require it—that a premium shall be paid to the debenture-holders in the event of the security becoming enforceable by a voluntary winding up with a view to reconstruction.

**Public Companies.**—Public companies, *i.e.* companies incorporated by special act of parliament for carrying on undertakings of public utility, form a class distinct from trading companies. The borrowing powers of these companies, the form of their debenture or debenture stock, and the rights of the debenture-holders or debenture-stockholders, depend on the conjoint operation of the companies' own special act and the Companies Clauses Acts 1845, 1863 and 1869. The provisions of these acts as to borrowing, being express, exclude any implicit power of borrowing. The first two of the above acts relate to mortgages and bonds, the last to debenture stock. The policy of the legislature in all these acts is the same, namely, to give the greatest facilities for borrowing, and at the same time to take care that undertakings of public utility which have received legislative sanction shall not be broken up or destroyed, as they would be if the mortgagees or debenture-holders were allowed the ordinary rights of mortgagees for realizing their security by seizure and sale. Hence the legislature has given them only "the fruit of the tree," as Lord Cairns expressed it. The debenture-holders or the debenture-stockholders may take the earnings of the company's undertaking by obtaining the appointment of a receiver, but that is all they can do. They cannot sell the undertaking or disorganize it by levying execution, so long as the company is a going concern; but this protecting principle of public policy will not be a bar to a debenture-holder, in his character of creditor, presenting a petition to wind up the company, if it is no longer able to fulfil its statutory objects. Railway companies have further special legislation, which will be found in the Railway Companies Powers Act 1864, the Railways Construction Facilities Act 1864 and the Railway Securities Act 1866.

**Municipal Corporations and County Councils.**—These bodies are authorized to borrow for their proper purposes on debentures and debenture stock with the sanction of the Local Government Board. See the Municipal Corporations Act 1882, the Local

Authorities' Loans Act 1875, and the Local Government (England and Wales) Act 1888.

**United States.**—In the United States there are two meanings of debenture—(1) a bond not secured by mortgage; (2) a certificate that the United States is indebted to a certain person or his assigns in a certain sum on an audited account, or that it will refund a certain sum paid for duties on imported goods, in case they are subsequently exported.

**AUTHORITIES.**—E. Manson, *Debentures and Debenture Stock* (London, 2nd ed., 1908); Simonson, *Debentures and Debenture Stock* (London, 2nd ed., 1902); Palmer, *Company Precedents (Debentures)* (3rd ed., London, 1907). (E. MA.)

**DEBORAH** (Heb. for "bee"), the Israelite heroine in the Bible through whose encouragement the Hebrews defeated the Canaanites under Sisera. The account is preserved in Judges iv.-v., and the ode of victory (chap. v.), known as the "Song of Deborah," is held to be one of the oldest surviving specimens of Hebrew literature. Although the text of this *Te Deum* has suffered (especially in vv. 8-15) its value is without an equal for its historical contents. It is not certain that the poem was actually composed by Deborah (v. 1); ver. 7, which can be rendered "until thou didst arise, O Deborah," is indecisive. The poem consists of a series of rapidly shifting scenes; the words are often obscure, but the general drift of the whole can be easily followed. After the exordium, the writer describes the approach of Yahweh from his seats in Seir and Edom in the south to the help of his people—the language is reminiscent of Ps. lxxviii. 7 sqq., Hab. iii. 3 seq. 12 seq. In the days of Shamgar the son of Anath the land had been insecure, the people were disarmed, and neither shield nor spear was to be seen among their forty thousand (cf. 1 Sam. xiii. 19-22, and for the number Josh. iv. 13). Then follows, apparently, a summons to magnify Yahweh. After an apostrophe to Deborah and Barak, the son of Abinoam, the meeting of the clans is vividly portrayed. Ephraim, with Benjamin behind him (for the wording, cf. Hos. v. 8), Machir (here the tribe of Manasseh) and Zebulun, Issachar and Naphtali, pour down into the valley of the Kishon. Not all the tribes were represented. Reuben was wavering, Gilead (*i.e.* Gad) remained beyond the Jordan, and Dan's interests were apparently with the sea-going Phoenicians (see DAN); their conduct is contrasted with the reckless bravery of Zebulun and Naphtali. Judah is nowhere mentioned; it lay outside the confederation. The Canaanite kings unite at Taanach by Megiddo, an ancient battlefield probably to be identified with Lejjün. The heavens joined the fight against Sisera (cf. the appeal in Josh. x. 12 seq.), a storm rages, and the enemy are swept away in the flood. Meroz, presumably on the line of flight, is bitterly cursed for its inaction: "they came not to the help of Yahweh." In vivid contrast to this is the conduct of one of the Kenites: "blessed of all women is Jael, of all the nomad women is she blessed." The poem recounts how the fleeing king craves water, she gives him milk, and (as he drinks) she fells him (perhaps with a tent-peg); "at her feet he sank down, he fell, he lay, where he sank he lay overcome." The last scene paints the mother of Sisera impatiently awaiting the king. Her attendants confidently picture him dividing the booty—a maiden or two for each man, and richly embroidered cloth for himself. With inimitable strength the poet suddenly drops the curtain—"so perish thine enemies, all of them, Yahweh! But let them that love him be as the sun when it rises in its might."

The historical background of this great event is unknown. The Israelite confederation consists of central Palestine with the (east-Jordanic) Machir, and the northern tribes with the exception of Dan and Asher. This has suggested to some an invasion from the coast, or from the north by way of the coast, since had Dan and Asher fallen into the hands of the enemy, this would probably have been referred to in some way. Sisera is scarcely a Semitic name; a "Hittite" origin has been suggested.<sup>1</sup> Shamgar son of Anath seems equally foreign; the latter is the name of a Syrian goddess and the former recalls Sangara, a Hittite chief of Carchemish in the 9th century. The context suggests that

<sup>1</sup> The term "Hittite" is here used as a loose but convenient designation for closely related groups of N. Syria; see HITTITES.

Shamgar is a foreign oppressor (ver. 6), but he appears to have been converted subsequently into one of the "judges" of Israel (iii. 31), perhaps with the idea of bringing their total up to twelve.

The prose version (iv.) contains new and conflicting details. Deborah, whose home is placed under "Deborah's palm" between Ramah and Bethel, summons Barak from Kadesh-Naphtali to collect Naphtali and Zebulun, 10,000 strong, and to meet Sisera (who is here the general of a certain Jabin, king of Hazor) at Mt. Tabor. But Sisera marches south to Kishon, and after his defeat flees north through Israelite territory, past Hazor to the neighbourhood of Kadesh. His death, moreover, is differently described (iv. 21, v. 25-27), and Jael "who with inhospitable guile smote Sisera sleeping" (Milton) is guilty of an act which has possibly originated from a misunderstanding of the poem. In the prose narrative Jabin has nothing to do with the fight, whereas in Josh. xi. he is at the head of an alliance of north Canaanite kings who were defeated by Joshua at the waters of Merom. It would seem that certain elements which are inconsistent with the representation in Judg. v. belonged originally to the other battle. Kadesh, for example, might be a natural meeting-place for an attack upon Hazor, and the designation "Jabin's general," applied to Sisera, is probably due to the attempt to harmonize the two distinct stories. Moreover, Deborah, who is associated with the tribe of Issachar (v. 15), appears to have been confused with Rebekah's nurse, whose tomb lay near Bethel (Gen. xxxv. 5). Some more northerly place seems to be required, and it has been pointed out that the name corresponds with Daberath (modern Dabürriyeh) at the foot of Tabor, on the border of Zebulun and Issachar. At all events, to represent her as a prophetess, judging the people of Israel (iv. 4 seq.), ill accords with both the older account (v.) and the general situation reflected in the earlier narratives in the book of Judges.

For fuller details see G. A. Cooke, *History and Song of Deborah* (1892), the commentaries on Judges and the histories of Israel. Cheyne, *Critica Biblica*, pp. 446-464, offers many new textual emendations. Paton (*Syria and Palestine*, p. 158 sqq.) suggests that the battle was against the Hittites (Sisera, a successor of Shamgar). See also L. W. Batten, *Journ. Bibl. Lit.* (1905) pp. 31-40 (who regards Judg. v. and Josh. xi. as duplicates); Winckler, *Gesch. Israels*, ii. 125-135; *Keilenschr. u. d. Alte Test.* (9) p. 218; and Ed. Meyer, *Israeliten*, pp. 272 sqq., 487 sqq. (S. A. C.)

**DEBRECZEN**, a town of Hungary, capital of the county of Hajdu, 138 m. E. of Budapest by rail. Pop. (1900) 72,351. It is the principal Protestant centre in Hungary, and bears the name of "Calvinistic Rome." Debreczen is one of the largest towns of Hungary, and is situated in the midst of a sandy but fertile plain. It consists of the inner old town, and several suburbs, which stretch out irregularly into the plain. The walls of the old town have given place to a broad boulevard and several open commons, beautifully laid out. The most prominent of its public buildings is the principal Protestant church, built at the beginning of the 19th century, which ranks as the largest in the country, but has no great architectural pretensions. In its immediate neighbourhood is the Protestant Collegium, for theology and law, which is one of the most frequented institutions of its kind in Hungary, being attended by over two thousand students. This college was founded in 1531, and possesses a rich library and other scientific collections. The town hall, the Franciscan church, the Piarist monastery and college, and the theatre are also worthy of mention. Amongst its educational establishments it includes an agricultural academy. The industries of the town are various, but none is of importance enough to give it the character of a manufacturing centre. Its tobacco-pipes, sausages and soap are widely known. It carries on an active trade in cattle, horses, corn and honey, while four well-attended fairs are held annually. The municipality of Debreczen owns between three hundred and four hundred square miles of the adjoining country, which possesses all the characteristics of the Hungarian *puszta*, and on which roam large herds of cattle.

The town is of considerable antiquity, but owes its development to the refugees who flocked from the villages plundered

by the Turks in the 15th century. In 1552 it adopted the Protestant faith, and it had to suffer in consequence, especially when it was captured in 1686 by the imperial forces. In 1693 it was made a royal free city. In 1848-1849 it formed a refuge for the national government and legislature when Budapest fell into the hands of the Austrians; and it was in the great Calvinist church that, on Kossuth's motion (April 14th, 1849) the resolution was passed declaring the house of Habsburg to have forfeited the crown of St Stephen. On the 3rd of July the town was captured by the Russians.

**DEBT** (Lat. *debitum*, a thing owed), a definite sum due by one person to another. It may be created by contract, by statute or by judgment. Putting aside those created by statute, recoverable by civil process, debts may be divided into three classes, (1) judgment debts, (2) specialty debts, and (3) simple contract debts. As to judgment debts, it is sufficient to say that, when by the judgment of a court of competent jurisdiction an order is made that a sum of money be paid by one of two parties to another, such a debt is not only enforceable by process of court, but it can be sued upon as if it were an ordinary debt. A specialty debt is created by deed or instrument under seal. Until 1869 specialty debts had preference under English law over simple contract debts in the event of the bankruptcy or death of the debtor, but this was abolished by the Administration of Estates Act of that year. The main difference now is that a specialty debt may, in general, be created without consideration, as for example by a bond (a gratuitous promise under seal), and that a right of action arising out of a specialty debt is not barred if exercised any time within twenty years, whereas a right of action arising out of a simple contract debt is barred unless exercised within six years. (See **LIMITATION, STATUTES OF.**) Any other debt than a judgment or specialty debt, whether evidenced by writing or not, is a simple contract debt. There are also certain liabilities or debts which, for the convenience of the remedy, have been made to appear as though they sprang from contract, and are sometimes termed quasi-contracts. Such would be an admission by one who is in account with another that there is a balance due from him. Such an admission implies a promise to pay when requested and creates an actionable liability *ex contractu*. Or, when one person is compelled by law to discharge the legal liabilities of another, he becomes the creditor of the person for the money so paid. Again, where a person has received money under circumstances which disentitle him to retain it, such as receiving payment of an account twice over, it can generally be recovered as a debt.

At English common law debts and other choses in action were not assignable (see **CHOSE**), but by the Judicature Act 1873 any absolute assignment of any debt or other legal chose in action, of which express notice in writing is given to the debtor, trustee or other person from whom the assignor would have been entitled to receive or claim such debt, is effectual in law. Debts do not, as a general rule, carry interest, but such an obligation may arise either by agreement or by mercantile usage or by statute. The discharge of a debt may take place either by payment of the amount due, by accord and satisfaction, *i.e.* acceptance of something else in discharge of the liability, by set-off (*q.v.*), by release or under the law of bankruptcy (*q.v.*). It is the duty of a debtor to pay a debt without waiting for any demand, and, unless there is a place fixed on either by custom or agreement, he must seek out his creditor for the purpose of paying him unless he is "beyond the seas." Payment by a third person to the creditor is no discharge of a debt, as a general rule, unless the debtor subsequently ratifies the payment. When a debtor tenders the amount due to his creditor and the creditor refuses to accept, the debt is not discharged, but if the debtor is subsequently sued for the debt and continues willing and ready to pay, and pays the amount tendered into court, he can recover his costs in the action. A creditor is not bound to give change to the debtor, whose duty it is to make tender in lawful money the whole amount due, or more, without asking for change. (See **PAYMENT.**) A debtor takes the risk if he makes payment through the post, unless the creditor has requested or authorized that mode of

payment. The payment of a debt is sometimes secured by one person, called a surety, who makes himself collaterally liable for the debt of the principal. (See GUARANTEE.) The ordinary method of enforcing a debt is by action. Where the debt does not exceed £100 the simplest procedure for its recovery is that of the county court, but if the debt exceeds £100 the creditor must proceed in the high court, unless the cause of action has arisen within the jurisdiction of certain inferior courts, such as the mayor's court of London, the Liverpool court of passage, &c. When judgment has been obtained it may be enforced either by process (under certain conditions) against the person of the debtor, by an execution against the debtor's property, or, with the assistance of the court, by attaching any debt owed to the debtor by a third person. Where a debtor has committed any act of bankruptcy a creditor or creditors whose aggregate claims are not less than £50 may proceed against him in bankruptcy (*q.v.*). Where the debtor is a company or corporation registered under the companies acts, the creditor may petition to have it wound up. (See COMPANY.)

Imprisonment for debt, the evils of which have been so graphically described by Dickens, was abolished in England by the Debtors Act 1869, except in cases of default of payment of penalties, default by trustees or solicitors and certain other cases. But in cases where a debt or instalment is in arrear and it is proved to the satisfaction of the court that the person making default either has or has had since the date of the order or judgment the means to pay the sum in respect of which he has made default and has refused or neglected to pay, he may be committed to prison at the discretion of the judge for a period of not more than forty-two days. In practice, a period of twenty-one days is usually the maximum period ordered. Such an imprisonment does not operate as a satisfaction or extinguishment of the debt, and no second order of commitment can be made against him for the same debt, although where the court has made an order or judgment for the payment of the debt by instalments a power of committal arises on default of payment of each instalment. In Ireland imprisonment for debt was abolished by the Debtors Act (Ireland) 1872, and in Scotland by the Debtors (Scotland) Act 1880. In France it was abolished in 1867, in Belgium in 1871, in Switzerland and Norway in 1874, and in Italy in 1877. In the United States imprisonment for debt was universal under the common law, but it has been abolished in every state, except in certain cases, as where there is any suspicion of fraud or where the debtor has an intention of removing out of the state to avoid his debts. (See also CONTRACT; BANKRUPTCY.)

**DEBUSSY, CLAUDE ACHILLE** (1862— ), French composer, was born at St Germain-en-Laye on the 22nd of August 1862, and educated at the Paris Conservatoire under Marmontel, Lavignac, Massenet and Guiraud. There between 1874 and 1884 he gained many prizes for solfège, pianoforte playing, accompanying, counterpoint and fugue, and, in the last-named year, the coveted Grand Prix de Rome by means of his cantata *L'Enfant prodigue*. In this composition already were thought to be noticeable the germs of unusual and "new" talent, though in the light of later developments it is not very easy to discern them, for then Debussy had not come under the influence which ultimately turned his mind to the system he afterwards used, not only with peculiar distinction but also with particular individual and complete success. Nevertheless, the mind had clearly been prepared by nature for the reception of this influence when it should arise; for, in order to fulfil that condition of the Prix de Rome which entails the submitting periodically of compositions to the judges, Debussy sent to them his symphonic suite *Printemps*, to which the judges took exception on the ground of its formlessness. Following in the wake of *Printemps* came *La damoiselle élue* for solo, female voice and orchestra—a setting of a French version of Rossetti's "The Blessed Damosel"—which in the eyes of the judges was even more unorthodox than its predecessor, though, be it said, fault was found as much with the libretto as with the music. Both works were denied the customary public performance.

The Rome period over, Debussy returned to Paris, whence

shortly he went to Russia, where he came directly under the influence referred to above. In Russia he absorbed the native music, especially that of Moussorgsky, who, recently dead, had left behind him the reputation of a "musical nihilist," and on his return to Paris Debussy devoted himself to composition, the stream of his muse being even in 1908 as fluent as twenty years before. To him public recognition was slow in coming, but in 1893 the Société Nationale de Musique performed his *Damoiselle élue*, in 1894 the Ysaye Quartet introduced the string quartet, while in the same year the *Prélude à l'après-midi d'un Faune* was heard, and brought Debussy's name into some prominence. As time passed the prominence grew, until the climax of Debussy's creative career was reached by the production at the Opéra Comique on the 30th of April 1902 of his masterpiece *Pelléas et Mélisande*. Herein lay the whole strength of Debussy's system, the perfection of his appeal to the mind and imagination as well as to the emotions and senses. Since its production the world has been enriched by *La Mer*, and by the *Ariettes oubliées*, but the lyric drama remains on its own lofty pedestal, a monument of elusive and subtle beauty, of emphatic originality and of charm. In an Apologia Debussy has declared that in composing *Pelléas* he "wanted to dispense with parasitic musical phrases. Melody is, if I may say so, almost anti-lyric, and powerless to express the constant change of emotion or life. Melody is suitable only for the chanson, which confirms a fixed sentiment. I have never been willing that my music should hinder, through technical exigencies, the change of sentiment and passion felt by my characters. It is effaced as soon as it is necessary that these should have perfect liberty in their gestures or in their cries, in their joy, or in their sorrow."

The list of Debussy's works is a lengthy one. Several of them have been referred to already. Among the others, of which the complete list is too long to print here, are the dances for chromatic harp or pianoforte; *Images*; incidental music to *King Lear*; the *Petite Suite*; *Trois Nocturnes*; innumerable songs, as *Proses Lyriques* (text by Debussy); two series of Verlaine's *Fêtes galantes*; *Cinq Poèmes de Baudelaire*; many pianoforte pieces.

In 1891 Debussy was appointed critic of the *Revue Blanche*. In his first notice he expressed his faith thus: "I shall endeavour to trace in a musical work the many different emotions which have helped to give it birth, also to demonstrate its inner life. This, surely, will be accounted of greater interest than the game which consists in dissecting it as if it were a curious timepiece."

As to the theories, so much debated, of this remarkable musician—probably in the whole range of musical history there has not appeared a more difficult theorist to "place." Unquestionably Debussy has introduced a new system of colour into music, which has begun already to exert widespread influence. Roughly, Debussy's system may be summarized thus:

His scale basis is of six whole tones (enharmonic), as (1) middle C, D, E, G♭, A♭, B♭, which are of excellent sound when superimposed in the form of two augmented unrelated triads.

$\left\{ \begin{array}{l} B\flat \\ G\flat \text{ or enharmonically} \\ D \end{array} \right.$	$\left\{ \begin{array}{l} A\sharp \\ F\sharp \\ D \end{array} \right.$
$\left\{ \begin{array}{l} A\flat \\ E \\ C \end{array} \right.$	$\left\{ \begin{array}{l} G\sharp \\ E \\ C \end{array} \right.$

used frequently incomplete (*i.e.* by the omission of one note) by Debussy.

Now, upon the basis of an augmented triad a tune may be played above it provided that it be based upon the six-tone scale, and a fugue may be written, the re-entry of the subject of which may be made upon any note of the scale, and the harmony will be complete. To associate this scale with the ordinary diatonic scale let a major 9th be taken, *e.g.*: one may conventionally flatten or sharpen the fifth of this (A becoming ♯ or ♭ as desired): if both the flattened and sharpened fifths be taken in the one chord this chord is arrived at:

E  
C  
B♭  
A♯ (A♯ enharmonically altered to B♭)  
F♯  
D

which is composed of the notes of the aforesaid scale (1), and Debussy thereby proves his case to belong to the "primitifs." It will be noticed that chords of the 9th in sequence and in all forms occur in Debussy's music as well as the augmented triad harmonics, where the melodic line is based on the tonal scale. This, in all likelihood, is the outcome of Debussy's instinctive feeling for the association of his so-called discovery with the ordinary scale. The "secret," it may be added, comes not from Annamese music as has been frequently stated, but probably from Russia, where certainly it was used before Debussy's rise.

(R. H. L.)

**DECADE** (from Gr. *δέκα*, ten), a group or series containing ten members, particularly a period of ten years. In the new calendar made at the time of the French Revolution in 1793, a decade of ten days took the place of the week. The word is also used of the divisions containing ten books or parts into which the history of Livy was divided.

**DECAEN, CHARLES MATHIEU ISIDORE, COUNT** (1769-1832), French soldier, was born at Caen on the 13th of April 1769. He was educated for the bar, but soon showed a strong preference for the military career, in which he quickly made his way during the wars of the French Revolution under Kléber, Marceau and Jourdan, in the Rhenish campaigns. In 1799 he became general of division, and contributed to the success of the famous attack by General Richepanse on the Austrian flank and rear at Hohenlinden (December 1800). Becoming known for his Anglophobe tendencies, he was selected by Napoleon early in the year 1802 for the command of the French possessions in the East Indies. The secret instructions issued to him bade him prepare the way, so that in due course (September 1804 was hinted at as the suitable time) everything might be ready for an attack on the British power in India. Napoleon held out to him the hope of acquiring lasting glory in that enterprise. Decaen set sail with Admiral Linois early in March 1803 with a small expeditionary force, touched at the Cape of Good Hope (then in Dutch hands), and noted the condition of the fortifications there. On arriving at Pondicherry he found matters in a very critical condition. Though the outbreak of war in Europe had not yet been heard of, the hostile preparations adopted by the Marquis Wellesley caused Decaen to withdraw promptly to the Isle of France (Mauritius), where, during eight years, he sought to harass British trade and prepare for plans of alliance with the Mahratta princes of India. They all came to naught. Linois was captured by a British squadron, and ultimately, in 1811, Mauritius itself fell to the Union Jack. Returning to France on honourable terms, Decaen received the command of the French troops in Catalonia. The rest of his career calls for no special mention. He died of the cholera in 1832.

See M. L. E. Gautier, *Biographie du général Decaen* (Caen, 1850).

**DECALOGUE** (in patristic Gr. *ἡ δεκάλογος*, sc. *βιβλος* or *νομοθεσία*), another name for the biblical *Ten Commandments*, in Hebrew the *Ten Words* (Deut. iv. 13, x. 4; Ex. xxxiv. 28), written by God on the two tables of stone (Ex. xxiv. 12, xxxii. 16), the so-called *Tables of the Revelation* (E.V. "tables of testimony," Ex. xxxiv. 29), or *Tables of the Covenant* (Deut. iv. 9, 11, 15). These tables were broken by Moses (Ex. xxxii. 19), and two new ones were hewn (xxxiv. 1), and upon them were written the words of the covenant by Moses (xxxiv. 27 sqq.) or, according to another view, by God himself (Deut. iv. 13, ix. 10). They were deposited in the Ark (Ex. xxv. 21; 1 Kings viii. 9). In Deuteronomy the inscription on these tables, which is briefly called the covenant (iv. 13), is expressly identified with the words spoken by Jehovah (Yahweh) out of the midst of the fire at Mt. Sinai or Horeb (according to the Deuteronomic tradition), in the ears of the whole people on the "day of the assembly," and rehearsed

in v. 6-21. In the narrative of Exodus the relation of the "ten words" of xxxiv. to the words spoken from Sinai, xx. 2-17, is not so clearly indicated, and it is generally agreed that the Pentateuch presents divergent and irreconcilable views of the Sinaitic covenant.

As regards the Decalogue, as usually understood, and embodied in the parallel passages in Ex. xx. and Deut. v., certain preliminary points of detail have to be noticed. The variations in the parallel texts are partly verbal, partly stylistic (e.g. "Remember the Sabbath day," Ex.; but "observe," &c., Deut.), and partly consist of amplifications or divergent explanations. Thus the reason assigned for the institution of the Sabbath in Exodus is drawn from the creation, and agrees with Gen. ii. 3. In Deuteronomy the command is based on the duty of humanity to servants and the memory of Egyptian bondage. Again, in the tenth commandment, as given in Exodus, "house" means house and household, including the wife and all the particulars which are enumerated in ver. 17. In Deuteronomy, "Thou shalt not covet thy neighbour's wife," comes first, and "house" following in association with field is to be taken in the literal restricted sense, and another verb ("thou shalt not desire") is used.

The construction of the second commandment in the Hebrew text is disputed, but the most natural sense seems to be, "Thou shalt not make unto thee a graven image; (and) to no visible shape in heaven, &c., shalt thou bow down, &c." The third commandment might be rendered, "Thou shalt not utter the name of the Lord thy God vainly," but it is possible that the meaning is that Yahweh's name is not to be used for purposes of sorcery.

The order of the commandments relating to murder, adultery and stealing varies in the Vatican text of the Septuagint, viz. adultery, stealing, murder, in Ex.; adultery, murder, stealing, in Deut. The latter is supported by several passages in the New Testament (Rom. xiii. 9; Mark x. 19, A.V.; Luke xviii. 20; contrast Matt. xix. 18), and by the "Nash Papyrus."<sup>1</sup> It may be added that the double system of accentuation of the Decalogue in the Hebrew Bible seems to preserve traces of the ancient uncertainty concerning the numeration.

*Divisions of the Decalogue.*—The division current in England and Scotland, and generally among the Reformed (Calvinistic) churches and in the Orthodox Eastern Church, is known as the Philonic division (Philo, *de Decalogo*, §12). It is sometimes called by the name of Origen, who adopts it in his *Homilies on Exodus*. On this scheme the preface, Ex. xx. 2, has been usually taken as part of the first commandment. The Church of Rome and the Lutherans adopt the Augustinian division (Aug., *Quaest. super Exod.*, lxxi.), combining into one the first and second commandments of Philo, and splitting his tenth commandment into two. To gain a clear distinction between the ninth and tenth commandments on this scheme it has usually been felt to be necessary to follow the Deuteronomic text, and make the ninth commandment, "Thou shalt not covet thy neighbour's wife."<sup>2</sup> As few scholars will now claim priority for the text of Deuteronomy, this division may be viewed as exploded. But there is a third scheme (the Talmudic) still current among the Jews, and not unknown to early Christian writers, which is still a rival of the Philonic view, though less satisfactory. Here the preface, Ex. xx. 2, is taken as the first "word," and the second embraces verses 3-6.

See further Nestle, *Expository Times* (1897), p. 427. The decision between Philo and the Talmud must turn on two questions. Can we take the preface as a separate "word"? And can we regard the prohibition of polytheism and the prohibition of idolatry as one commandment? Now, though the Hebrew certainly speaks of ten "words," not of ten "precepts," it is most unlikely that the first word can be different in character from those that follow. But the statement "I am the Lord thy God" is either no precept at all, or only enjoins by implication what is expressly commanded in the

<sup>1</sup> A Hebrew fragment probably of the 2nd century A.D., in the University Library, Cambridge, containing the Decalogue with several variant readings; see S. A. Cook, *Proceed. Soc. Bibl. Archaeology* (1903), pp. 34-56; F. C. Burkitt, *Jewish Quarterly Review* (1903), pp. 392-408; N. Peters, *D. älteste Abschrift d. zeh'n Gebote* (1905).

<sup>2</sup> So, for example, Augustine, *l.c.*, Thomas, *Summa (Prima Secundae, qu. c. art. 4)*, and recently Sonntag and Kurtz. Purely arbitrary is the idea of Lutheran writers (Gerhard, *Loc. xiii. § 46*) that the ninth commandment forbids *concupiscentia actualis*, the tenth *conc. originalis*.

words "Thou shalt have no other gods before me." Thus to take the preface as a distinct word is not reasonable unless there are cogent grounds for uniting the commandments against polytheism and idolatry. But that is far from being the case. The first precept of the Philonic scheme enjoins monolatry, the second expresses God's spiritual and transcendental nature. Accordingly Kuenen does not deny that the prohibition of images contains an element additional to the precept of monolatry, but, following De Goeje, regards the words from "thou shalt not make unto thyself" down to "the waters under the earth" as a later insertion in the original Decalogue. Unless this can be made out, the Philonic scheme is clearly best, and as such it is now accepted by most scholars.

How were the ten words disposed on the two tables? The natural arrangement (which is assumed by Philo and Josephus) would be five and five. And this, as Philo recognized, is a division appropriate to the sense of the precepts; for antiquity did not look on piety towards parents as a mere precept of probity, part of one's duty towards one's neighbour. The authority of parents and rulers is viewed in the Old Testament as a delegated divine authority, and the violation of it is akin to blasphemy (cf. Ex. xxi. 17 and Lev. xx. 9 with Lev. xxiv. 15, 16, and note the formula of treason, 1 Kings xxi. 13).

We have thus five precepts of piety on the first table, and five of probity, in negative form, on the second, an arrangement which is accepted by the best recent writers. But the current view of the Western Church since Augustine has been that the precept to honour parents heads the second table. The only argument of weight in favour of this view is that it makes the amount of writing on the two tables less unequal, while we know that the second table as well as the first was written on both sides (Ex. xxxii. 15). But we shall presently see that there may be another way out of this difficulty.

*Date.*—It is much disputed what the original compass of the Decalogue was. Did the whole text of Ex. xx. 2-17 stand on the tables of stone? The answer to this question must start from the reason annexed to the fourth commandment, which is different in Deuteronomy. But the express words "and he added no more," in Deut. v. 22, show that there is no conscious omission by the Deuteronomic speaker of part of the original Decalogue, which cannot therefore have included the reason annexed in Exodus. On the other hand the reason annexed in Deuteronomy is rather a parenthetic addition than an original element dropped in Exodus. Thus the original fourth commandment was simply "Remember the Sabbath day to keep it holy."<sup>1</sup> When this is granted it must appear not improbable that the elucidations of other commandments may not have stood on the tables, and that Nos. 6-9 have survived in their original form. Thus in the second commandment, "Thou shalt not bow down to any visible form," &c., is a sort of explanatory addition to the precept "Thou shalt not make unto thee a graven image." And so the promise attached to the fifth commandment was probably not on the tables, and the tenth commandment may have simply been, "Thou shalt not covet thy neighbour's house," which includes all that is expressed in the following clauses. Such a view gets over the difficulty arising from the unequal length of the two halves of the Decalogue.

It is quite another question whether there is any idea in the Decalogue which can be as old as Moses. It is urged by many critics that Moses cannot have prohibited the worship of Yahweh by images; for the subsequent history shows us a descendant of Moses as priest in the idolatrous sanctuary of Dan. There were teraphim in David's house, and the worship of Yahweh under the image of a calf was the state religion of the kingdom of Ephraim. Even Moses himself is said to have made a brazen serpent which, down to Hezekiah's time, continued to be worshipped at Jerusalem. It is argued from these facts that image-worship went on unchallenged, and that this would not have been possible had Moses forbidden it. The argument is supported by others of great cogency. Although the literary problems of the chapters which narrate the law-giving on Mt. Sinai are extremely intricate, it is generally agreed that Ex. xx. cannot be ascribed to the

<sup>1</sup> It is generally assumed that the addition in Exodus is from a hand akin to Gen. ii. 2 sqq.; Ex. xxxi. 17 (P.).

oldest source, and if, in accordance with many critics, this chapter is ascribed to the Elohist or Ephraimite school, its incorporation can scarcely be older than the middle of the 8th century, and is probably later. With this, the condemnation of adultery in Gen. xx. 1-17 (contrast xii. 10-20, xxvi. 6-11) is in harmony, and the prohibition of the worship of the heavenly bodies is aimed at a form of idolatry which is frequently alluded to in the times of the later kings. The lofty ethics (e.g. tenth commandment) is in itself no *sound* criterion, whilst the external form of the laws, though characteristic of later codes, need not be taken as evidence of importance. But the general result of a study of the Decalogue as a whole, in connexion with Israelite political history and religion, strongly supports, in fact demands, a post-Mosaic origin, and modern criticism is chiefly divided only as to the approximate date to which it is to be ascribed. The time of Manasseh (cf. especially its contact with Micah vi. 6-8) has found many adherents, but an earlier period, about 750 B.C. (time of Amos and Hosea), is often held to satisfy the main conditions; the former, however, is probably nearer the mark.

*The Decalogue of Exodus xxxiv.*—In the book of Exodus the words written on the tables of stone are nowhere expressly identified with the ten commandments of chap. xx. In xxv. 16, xxxi. 18, xxxii. 15, we simply read of "the testimony" inscribed on the tables, and it seems to be assumed that its contents must be already known to the reader. The expression "ten words" first occurs in xxxiv. 28, in a passage which relates the restoration of the tables after they had been broken. But these "ten words" are called "the words of the covenant," and so can hardly be different from the words mentioned in the preceding verse as those in accordance wherewith the covenant was made with Israel. And again, the words of ver. 27 are necessarily the commandments which immediately precede in vv. 12-26. Accordingly many recent critics have sought to show that Ex. xxxiv. 12-26 contains just ten precepts forming a second decalogue.<sup>2</sup>

These consist not of precepts of social morality, but of several laws of religious observance closely corresponding to the religious and ritual precepts of Ex. xxi.-xxiii. The number ten is not clearly made out, and the individual precepts are somewhat variously assigned. They prohibit (1) the worship of other gods, (2) the making of molten images; they ordain (3) the observance of the feast of unleavened bread, (4) the feast of weeks, (5) the feast of ingathering at the end of the year, and (6) the seventh-day rest; to Yahweh belong (7) the firstlings, and (8) the first-fruits of the land; they forbid also (9) the offering of the blood of sacrifice with leaven, (10) the leaving-over of the fat of a feast until the morning, and (11) the seething of a kid in its mother's milk. This scheme ignores the command to appear thrice in the year before Yahweh which recapitulates Nos. 3-5, and the decade is obtained by omitting No. 6, which some hold to be out of place. Others include "none shall appear before me empty-handed" (xxxiv. 20); and unite Nos. 4-5, 9 and 10. C. F. Kent (*Beginnings of Heb. Hist.* pp. 183 sqq.) obtains a decalogue from scattered precepts in Ex. xx.-xxiii., which corresponds with Nos. 2, 7, 6, 3 and 5 (in one), 9 and 10 (in one), 11 above, and adds (a) the building of an altar of earth (xx. 24), (b) offering from the harvest and wine-press (xxii. 29), (c) firstlings of animals (xxii. 29 sqq.; cf. No. 7, and xxxiv. 19); (d) prohibition against eating torn flesh (xxii. 31).<sup>3</sup> The so-called Yahwist Decalogue in xxxiv. presupposes a rather more primitive stage in society, partly nomadic and partly agricultural; No. 6 is suitable only for agriculturists and cannot have originated among nomads. The whole may be summed up in a sentence:—"Worship Yahweh and Yahweh alone, without images, let the worship be simple and in accord with the old usage; forbear to introduce the practices of your Canaanitish neighbours" (Harper). It would seem to represent more precisely a Judæan standpoint (cf. the simpler customs of the Rechabites, q.v.).

<sup>2</sup> So Hitzig (*Ostern und Pfingsten im zweiten Dekalog*, Heidelberg, 1838), independently of a previous suggestion of Goethe in 1783, who in turn appears to have been anticipated by an early Greek writer (Nestle, *Zeit. für alt-test. Wissenschaft* (1904), pp. 134 sqq.).

<sup>3</sup> See also W. E. Barnes, *Journ. Theol. Stud.* (1905), pp. 557-563.



If such a system of precepts was ever viewed as the basis of the covenant with Israel, it must belong to a far earlier stage of religious development than that of Ex. xx. This is recognized by Wellhausen, who says that our decalogue stands to that of Ex. xxxiv. as Amos stood to his contemporaries, whose whole religion lay in the observance of sacred feasts. To those accustomed to look on the Ten Words written on the tables of stone as the very foundation of the Mosaic law, it is hard to realize that in ancient Israel there were two opinions as to what these "Words" were. The hypothesis that Ex. xxxiv. 10-26 originally stood in a different connexion, and was misplaced at some stage in the redaction of the Hexateuch, does not help us, since it would still have to be admitted that the editor to whom we owed the present form of the chapter identified this little code of religious observances with the Ten Words. Were this the case the editor, to quote Wellhausen, "introduced the most serious internal contradiction found in the Old Testament."<sup>1</sup>

*The Decalogue in Christian Theology.*—Following the New Testament, in which the "commandments" summed up in the law of love are identified with the precepts of the Decalogue (Mark x. 19; Rom. xiii. 9; cf. Mark xii. 28 ff.), the ancient Church emphasized the permanent obligation of the ten commandments as a summary of *natural* in contradistinction to *ceremonial* precepts, though the observance of the Sabbath was to be taken in a spiritual sense (Augustine, *De spiritu et litera*, xiv.; Jerome, *De celebratione Paschae*). The medieval theologians followed in the same line, recognizing all the precepts of the Decalogue as moral precepts *de lege naturae*, though the law of the Sabbath is not of the law of nature, in so far as it prescribes a determinate day of rest (Thomas, *summa*, I<sup>ma</sup> II<sup>da</sup>, qu. c. art. 3; Duns, *Super sententias*, lib. iii. dist. 37). The most important medieval exposition of the Decalogue is that of Nicolaus de Lyra; and the 15th century, in which the Decalogue acquired special importance in the confessional, was prolific in treatises on the subject (Antoninus of Florence, Gerson, &c.).

Important theological controversies on the Decalogue begin with the Reformation. The question between the Lutheran (Augustinian) and Reformed (Philonic) division of the ten commandments was mixed up with controversy as to the legitimacy of sacred images not designed to be worshipped. The Reformed theologians took the stricter view. The identity of the Decalogue with the eternal law of nature was maintained in both churches, but it was an open question whether the Decalogue, as such (that is, as a law given by Moses to the Israelites), is of perpetual obligation. The Socinians, on the other hand, regarded the Decalogue as abrogated by the more perfect law of Christ; and this view, especially in the shape that the Decalogue is a civil and not a moral law (J. D. Michaelis), was the current one in the period of 18th-century rationalism. The distinction of a permanent and a transitory element in the law of the Sabbath is found, not only in Luther and Melancthon, but in Calvin and other theologians of the Reformed church. The main controversy which arose on the basis of this distinction was whether the prescription of one day in seven is of permanent obligation. It was admitted that such obligation must be not natural but positive; but it was argued by the stricter Calvinistic divines that the proportion of one in seven is agreeable to nature, based on the order of creation in six days, and in no way specially connected with anything Jewish. Hence it was regarded as a *universal positive* law of God. But those who maintained the opposite view were not excluded from the number of the orthodox. The laxer conception found a place in the Cocceian school.

LITERATURE.—Geffcken, *Über die verschiedenen Eintheilungen des Dekalogs und den Einfluss derselben auf den Cultus*; W. Robertson Smith, *Old Test. Jew. Church*, pp. 331-345, where his earlier views (1877) in the *Ency. Brit.* are largely modified (cf. also *Eng. Hist. Rev.* (1888) p. 352); Montefiore, *Hibbert Lectures* (1892), Appendix 1; W. R. Harper, *Internat. Crit. Comm. on Amos and Hosea*, pp. 58-64 (on the position of the Decalogue in early pre-prophetic religion of Israel); C. A. Briggs, *Higher Criticism of Hexat.* pp. 189-210; see also the references under EXODUS. (W. R. S.; S. A. C.)

<sup>1</sup> The last three sentences of this paragraph are taken almost bodily from Robertson Smith's later views (*Old Testament in the Jewish Church*<sup>2</sup>, pp. 335 seq.).

DE CAMP, JOSEPH (1858- ), American portrait and figure painter, was born in Cincinnati, Ohio, in 1858. He was a pupil of Frank Duveneck and of the Royal Academy of Munich; became a member of the society of Ten American Painters, and a teacher in the schools of the Pennsylvania Academy of Fine Arts, Philadelphia, and the Boston Museum of Fine Arts; and painted important mural decorations in the Philadelphia city hall.

DECAMPS, ALEXANDRE GABRIEL (1803-1860), French painter, was born in Paris on the 3rd of March 1803. In his youth he travelled in the East, and reproduced Oriental life and scenery with a bold fidelity to nature that made his works the puzzle of conventional critics. His powers, however, soon came to be recognized, and he was ranked along with Delacroix and Vernet as one of the leaders of the French school. At the Paris Exhibition of 1855 he received the grand or council medal. Most of his life was passed in the neighbourhood of Paris. He was passionately fond of animals, especially dogs, and indulged in all kinds of field sports. He died on the 22nd of August 1860 in consequence of being thrown from a vicious horse while hunting at Fontainebleau. The style of Decamps was characteristically and intensely French. It was marked by vivid dramatic conception, by a manipulation bold and rapid, sometimes even to roughness, and especially by original and startling use of decided contrasts of colour and of light and shade. His subjects embraced an unusually wide range. He availed himself of his travels in the East in dealing with scenes from Scripture history, which he was probably the first of European painters to represent with their true and natural local background. Of this class were his "Joseph sold by his Brethren," "Moses taken from the Nile," and his scenes from the life of Samson, nine vigorous sketches in charcoal and white. Perhaps the most impressive of his historical pictures is his "Defeat of the Cimbri," representing with wonderful skill the conflict between a horde of barbarians and a disciplined army. Decamps produced a number of genre pictures, chiefly of scenes from French and Algerine domestic life, the most marked feature of which is humour. The same characteristic attaches to most of his numerous animal paintings. He painted dogs, horses, &c., with great fidelity and sympathy; but his favourite subject was monkeys, which he depicted in various studies and sketches with a grotesque humour that could scarcely be surpassed. Probably the best known of all his works is "The Monkey Connoisseurs," a clever satire of the jury of the French Academy of Painting, which had rejected several of his earlier works on account of their divergence from any known standard. The pictures and sketches of Decamps were first made familiar to the English public through the lithographs of Eugène le Roux.

See Moreau's *Decamps et son œuvre* (Paris, 1869).

DECAPOLIS, a league of ten cities (*δέκα πόλεις*) with their surrounding district, situated with one exception on the eastern side of the upper Jordan and the Sea of Tiberias. Being essentially a confederation of *cities* it is impossible precisely to fix Decapolis as a *region* with definite boundaries. The names of the original ten cities are given by Pliny; these are as follows: Damascus, Philadelphia, Raphana, Scythopolis (= Beth-Shan, now *Beisan*, west of Jordan), Gadara, Hippos, Dion, Pella, Gerasa and Kanatha. Of these Damascus alone retains its importance. Scythopolis (as represented by the village of Beisan) is still inhabited; the ruins of Pella, Gerasa and Kanatha survive, but the other sites are unknown or disputed. Scythopolis, being in command of the communications with the sea and the Greek cities on the coast, was the most important member of the league. The league subsequently received additions and some of the original ten dropped out. In Ptolemy's enumeration Raphana has no place, and nine, such as Kapitolas, Edrei, Bosra, &c., are added. The purpose of the league was no doubt mutual defence against the marauding Bedouin tribes that surrounded them. These were hardly if at all checked by the Semitic kinglings to whom the Romans delegated the government of eastern Palestine.

It was probably soon after Pompey's campaign in 64-63 B.C. that the Decapolis league took shape. The cities comprising it

were united by the main roads on which they lay, their respective spheres of influence touching, if not overlapping, one another. A constant communication was maintained with the Mediterranean ports and with Greece, and there was a vigorous municipal life which found expression in literature, in athletic contests, and in a thriving commerce, thus carrying a truly Hellenic influence into Perea and Galilee. From Josephus we learn that the cities were severally subject to the governor of Syria and taxed for imperial purposes; some of them afterwards came under Herod's jurisdiction, but reserved the substantial rights granted them by Pompey.

The best account is in G. A. Smith's *Historical Geography of the Holy Land*, chap. xxviii. (R. A. S. M.)

**DECASTYLE** (Gr. *déka*, ten, and *στῦλος*, column), the architectural term given to a temple where the front portico has ten columns; as in the temple of Apollo Didymaeus at Miletus, and the portico of University College, London. (See **TEMPLE**.)

**DECATUR, STEPHEN** (1779-1820), American naval commander, was born at Sinnepuxent, Maryland, on the 5th of January 1779, and entered the United States navy as a midshipman in 1798. He was promoted lieutenant a year later, and in that rank saw some service in the short war with France. In 1803 he was in command of the "Enterprise," which formed part of Commodore Preble's squadron in the Mediterranean, and in February 1804 led a daring expedition into the harbour of Tripoli for the purpose of burning the U.S. frigate "Philadelphia" which had fallen into Tripolitan hands. He succeeded in his purpose and made his escape under the fire of the batteries with a loss of only one man wounded. This brilliant exploit earned him his captain's commission and a sword of honour from Congress. Decatur was subsequently engaged in all the attacks on Tripoli between 1804 and 1805. In the War of 1812 his ship the "United States" captured H.M.S. "Macedonian" after a desperate fight, and in 1813 he was appointed commodore to command a squadron in New York harbour, which was soon blockaded by the British. In an attempt to break out in February 1815 Decatur's flagship the "President" was cut off and after a spirited fight forced to surrender to a superior force. Subsequently he commanded in the Mediterranean against the corsairs of Algiers, Tunis and Tripoli with great success. On his return he was made a navy commissioner (November 1815), an office which he held until his death, which took place in a duel with Commodore James Barron at Bladensburg, Md., on the 22nd of March 1820.

See Mackenzie, *Life of Decatur* (Boston, 1846).

**DECATUR**, a city and the county-seat of Macon county, Illinois, U.S.A., in the central part of the state, near the Sangamon river, about 39 m. E. of Springfield. Pop. (1890) 16,841; (1900) 20,754, of whom 1939 were foreign-born; (1910 census) 31,140. Decatur is served by the Cincinnati, Hamilton & Dayton, the Illinois Central, the Wabash (which maintains car shops here), and the Vandalia railways, and is connected with Danville, Saint Louis, Springfield, Peoria, Bloomington and Champaign by the Illinois Traction System (electric). Decatur has three large parks and a public library; and S.E. of Fairview Park, with a campus of 35 acres, is the James Millikin University (co-educational; Cumberland Presbyterian), founded in 1901 by James Millikin, and opened in 1903. The university comprises schools of liberal arts, engineering (mechanical, electrical, and civil), domestic economy, fine and applied arts, commerce and finance, library science, pedagogy, music, and a preparatory school; in 1907-1908 it had 936 students, 440 being in the school of music. Among the city's manufactures are iron, brass castings, agricultural implements, flour, Indian corn products, soda fountains, plumbers' supplies, coffins and caskets, bar and store fixtures, gas and electric light fixtures, street cars, and car trucks. The value of the city's factory products increased from \$5,133,677 in 1900 to \$8,667,302 in 1905, or 68.8%. The city is also an important shipping point for agricultural products (especially grain), and for coal taken from the two mines in the city and from mines in the surrounding country. The first settlement in Decatur was made in 1829, and the plate was incorporated in 1836. On

the 22nd of February 1856 a convention of Illinois editors met at Decatur to determine upon a policy of opposition to the Kansas-Nebraska Bill. They called a state convention, which met at Bloomington, and which is considered to have taken the first step toward founding the Republican party in Illinois.

**DECAZES, ÉLIE, DUC** (1780-1860), French statesman, was born at Saint Martin de Laye in the Gironde. He studied law, became a judge in the tribunal of the Seine in 1806, was attached to the cabinet of Louis Bonaparte in 1807, and was counsel to the court of appeal at Paris in 1811. Immediately upon the fall of the empire he declared himself a Royalist, and remained faithful to the Bourbons through the Hundred Days. He made the personal acquaintance of Louis XVIII. during that period through Baron Louis, and the king rewarded his energy and tact by appointing him prefect of police at Paris on the 7th of July 1815. His marked success in that difficult position won for him the ministry of police, in succession to Fouché, on the 24th of September. In the interval he had been elected deputy for the Seine (August 1815) and both as deputy and as minister he led the moderate Royalists. His formula was "to royalize France and to nationalize the monarchy." The Moderates were in a minority in the chamber of 1815, but Decazes persuaded Louis XVIII. to dissolve the house, and the elections of October 1816 gave them a majority. During the next four years Decazes was called upon to play the leading rôle in the government. At first, as minister of police he had to suppress the insurrections provoked by the ultra-Royalists (the White Terror); then, after the resignation of the duc de Richelieu, he took the actual direction of the ministry, although the nominal president was General J. J. P. A. Dessolle (1767-1828). He held at the same time the portfolio of the interior. The cabinet, in which Baron Louis was minister of finance, and Marshal Gouvion Saint Cyr remained minister of war, was entirely Liberal; and its first act was to suppress the ministry of police, as Decazes held that it was incompatible with the régime of liberty. His reforms met with the strong hostility of the Chamber of Peers, where the ultra-Royalists were in a majority, and to overcome it he got the king to create sixty new Liberal peers. He then passed the laws on the press, suppressing the censorship. By reorganization of the finances, the protection of industry and the carrying out of great public works, France regained its economic prosperity, and the ministry became popular. But the powers of the Grand Alliance had been watching the growth of Liberalism in France with increasing anxiety. Metternich especially ascribed this mainly to the "weakness" of the ministry, and when in 1819 the political elections still further illustrated this trend, notably by the election of the celebrated Abbé Grégoire, it began to be debated whether the time had not come to put in force the terms of the secret treaty of Aix-la-Chapelle. It was this threat of foreign intervention, rather than the clamour of the "Ultras," that forced Louis XVIII. to urge a change in the electoral law that should render such a "scandal" as Grégoire's election impossible for the future. Dessolle and Louis, refusing to embark on this policy, now resigned; and Decazes became head of the new ministry, as president of the council (November 1819). But the exclusion of Grégoire from the chamber and the changes in the franchise embittered the Radicals without conciliating the "Ultras." The news of the revolution in Spain in January 1820 added fuel to their fury; it was the foolish and criminal policy of the royal favourite that had once more unchained the demon of revolution. Decazes was denounced as the new Sejanus, the modern Catiline; and when, on the 13th of February, the duke of Berry was murdered, clamorous tongues loudly accused him of being an accomplice in the crime. Decazes, indeed, foreseeing the storm, at once placed his resignation in the king's hands. Louis at first refused. "They will attack," he exclaimed, "not your system, my dear son, but mine." But in the end he was forced to yield to the importunity of his family (February 17th); and Decazes, raised to the rank of duke, passed into honourable exile as ambassador to Great Britain.

This ended Decazes's meteoric career of greatness. In December 1821 he returned to sit in the House of Peers, when

he continued to maintain his Liberal opinions. After 1830 he adhered to the monarchy of July, but after 1848 he remained in retirement. He had organized in 1826 a society to develop the coal and iron of the Aveyron, and the name of Decazeville was given in 1829 to the principal centre of the industry. He died on the 24th of October 1860.

His son, LOUIS CHARLES ÉLIE DECAZES, duc de Glücksberg (1819-1886), was born at Paris, and entered the diplomatic career. He became minister plenipotentiary at Madrid and at Lisbon, but the revolution of 1848 caused him to withdraw into private life, from which he did not emerge until in 1871 he was elected deputy to the National Assembly by the Gironde. There he sat in the right centre among the Orleanists, and was chosen by the duc de Broglie as minister of foreign affairs in November 1873. He voted with the Orleanists the "Constitutional Laws" of 1875, and approved of MacMahon's parliamentary *coup d'état* on the 16th of May 1877. He was re-elected deputy in October 1877 by the arrondissement of Puget-Théniers, but his election was annulled by the chamber, and he was not re-elected. He died on the 16th of September 1886.

On the Duc Decazes see E. Daudet, *Louis XVIII. et le duc Decazes* (1899), and his "L'ambassade du duc Decazes" in the *Revue des deux mondes* for 1899.

**DECAZEVILLE**, a town of south-central France, in the department of Aveyron, 34 m. N.W. of Rodez by the Orleans railway. Pop. (1906) 9749. It possesses iron mines and is the centre of the coal-fields of the Aveyron, which supply the iron-works established by the Duc Decazes, minister of Louis XVIII. A statue commemorates the founder.

**DECCAN** (Sans. *Dakshina*, "the South"), a name applied, according to Hindu geographers, to the whole of the territories in India situated to the south of the river Nerbudda. In its more modern acceptation, however, it is sometimes understood as comprising only the country lying between that river and the Kistna, the latter having for a long period formed the southern boundary of the Mahommedan empire of Delhi. Assigning it the more extended of these limits, it comprehends the whole of the Indian peninsula, and in this view the mountainous system, consisting of the Eastern and Western Ghats, constitutes the most striking feature of the Deccan. These two mountain ranges unite at their northern extremities with the Vindhya chain of mountains, and thus is formed a vast triangle supporting at a considerable elevation the expanse of table-land which stretches from Cape Comorin to the valley of the Nerbudda. The surface of this table-land slopes from west to east, as indicated by the direction of the drainage of the country,—the great rivers, the Cauvery, Godavari, Kistna and Pennar, though deriving their sources from the base of the Western Ghats, all finding their way into the Bay of Bengal through fissures in the Eastern Ghats.

*History*.—The detailed and authentic history of the Deccan only begins with the 13th century A.D. Of the early history the main facts established are the Aryan invasion (c. 700 B.C.), the growth of the Maurya empire (250 B.C.) and the invasion (A.D. 100) of the Scythic tribes known as the Sakas, Pahlavas and Yavanas, which led to the establishment of the power of the Kshaharata satraps in western India. In addition to this, modern study of monuments and inscriptions has recovered the names, and to a certain extent the records, of a succession of dynasties ruling in the Deccan; of these the most conspicuous are the Cholas, the Andhras or Satavahanas, the Chalukyas, the Rashtrakutas and the Yadavas of Devagiri (Deogiri). (See INDIA: *History*; BOMBAY PRESIDENCY: *History*; INSCRIPTIONS: *Indian*.) In 1294 Ala-ud-Din Khilji, emperor of Delhi, invaded the Deccan, stormed Devagiri, and reduced the Yadava rajas of Maharashtra to the position of tributary princes (see DAULATABAD), then proceeding southward overran Telingana and Carnata (1294-1300). With this event the continuous history of the Deccan begins. In 1307, owing to non-payment of tribute, a fresh series of Mussulman incursions began, under Malik Kafur, issuing in the final ruin of the Yadava power; and in 1338 the reduction of the Deccan was completed

by Mahommed ben Tughlak. The imperial sway was, however, of brief duration. Telingana and Carnata speedily reverted to their former masters; and this defection on the part of the Hindu states was followed by a general revolt of the Mussulman governors, resulting in the establishment in 1347 of the independent Mahommedan dynasty of Bahmani, and the consequent withdrawal of the power of Delhi from the territory south of the Nerbudda. In the struggles which ensued, the Hindu kingdom of Telingana fell bit by bit to the Bahmani dynasty, who advanced their frontier to Golconda in 1373, to Warangal in 1421, and to the Bay of Bengal in 1472. On the dissolution of the Bahmani empire (1482), its dominions were distributed into the five Mahommedan states of Golconda, Bijapur, Ahmednagar, Bidar and Berar. To the south of these the great Hindu state of Carnata or Vijayanagar still survived; but this, too, was destroyed, at the battle of Talikota (1565), by a league of the Mahommedan powers. These latter in their turn soon disappeared. Berar had already been annexed by Ahmednagar in 1572, and Bidar was absorbed by Bijapur in 1609. The victories of the Delhi emperors, Akbar, Shah Jahan and Aurangzeb, crushed the rest. Ahmednagar was incorporated in the Mogul empire in 1598, Bijapur in 1686, and Golconda in 1688. The rule of the Delhi emperors in the Deccan did not, however, long survive. In 1706 the Mahrattas acquired the right of levying tribute in southern India, and their principal chief, the Peshwa of Poona, became a practically independent sovereign. A few years later the emperor's viceroy in Ahmednagar, the nizam-al-mulk, threw off his allegiance and established the seat of an independent government at Hyderabad (1724). The remainder of the imperial possessions in the peninsula were held by chieftains acknowledging the supremacy of one or other of these two potentates. In the sequel, Mysore became the prize of the Mahommedan usurper Hyder Ali. During the contests for power which ensued about the middle of the 18th century between the native chiefs, the French and the English took opposite sides. After a brief course of triumph, the interests of France declined, and a new empire in India was established by the British. Mysore formed one of their earliest conquests in the Deccan. Tanjore and the Carnatic were shortly after annexed to their dominions. In 1818 the forfeited possessions of the Peshwa added to their extent; and these acquisitions, with others which have more recently fallen to the paramount power by cession, conquest or failure of heirs, form a continuous territory stretching from the Nerbudda to Cape Comorin. Its length is upwards of 1000 m., and its extreme breadth exceeds 800. This vast tract comprehends the chief provinces now distributed between the presidencies of Madras and Bombay, together with the native states of Hyderabad and Mysore, and those of Kolhapur, Sawantwari, Travancore, Cochin and the petty possessions of France and Portugal.

See J. D. B. Gribble, *History of the Deccan* (1896); Prof. Bhandarkar, "Early History of the Dekkan" (*Bombay Gazetteer*); Vincent A. Smith, *Early History of India* (2nd ed., Oxford, 1908), chap. xv. "The Kingdoms of the Deccan."

**DECELEA** (Gr. Δεκελία), an Attic deme, on the pass which led over the east end of Mt. Parnes towards Oropus and Chalcis. From its position it has a commanding view over the Athenian plain. Its eponymous hero, Decelus, was said to have indicated to the Tyndaridae, Castor and Pollux, the place where Theseus had hidden their sister Helen at Aphidnae; and hence there was a traditional friendship between the Deceleans and the Spartans (Herodotus ix. 73). This tradition, together with the advice of Alcibiades, led the Spartans to fortify Decelea as a basis for permanent occupation in Attica during the later years of the Peloponnesian War, from 413-404 B.C. Its position enabled them to harass the Athenians constantly, and to form a centre for fugitive slaves and other deserters. The royal palace of Tatoi has been built on the site.

See PELOPONNESIAN WAR; also Judeich in Pauly-Wissowa, *Realencyclopädie*.

**DECEMBER** (Lat. *decem*, ten), the last month of the year. In the Roman calendar, traditionally ascribed to Romulus, the year was divided into ten months, the last of which was called December, or the *tenth* month, and this name, though etymologically

incorrect, was retained for the last or twelfth month of the year as now divided. In the Romulian calendar December had thirty days; Numa reduced the number to twenty-nine; Julius Caesar added two days to this, giving the month its present length. The *Saturnalia* occurred in December, which is therefore styled "acceptus genis" by Ovid (*Fasti*, iii. 58); and this also explains the phrase of Horace "libertate Decembri utere" (*Sat.* ii. 7). Martial applies to the month the epithet *canus* (hoary), and Ovid styles it *gelidus* (frosty) and *fumosus* (smoky). In the reign of Commodus it was temporarily styled *Amazonius*, in honour of the emperor's mistress, whom he had had painted as an Amazon. The Saxons called it *winter-month*, winter month, and *heligh-month*, holy month, from the fact that Christmas fell within it. Thus the modern Germans call it *Christmonat*. The 22nd of December is the date of the winter solstice, when the sun reaches the tropic of Capricorn.

**DECEMVIRI** ("the ten men"), the name applied by the Romans to any official commission of ten. The title was often followed by a statement of the purpose for which the commission was appointed, e.g. *Xviri legibus scribundis, stitibus judicandis, sacris faciundis*.

I. Apart from such qualification, it signified chiefly the temporary commission which superseded all the ordinary magistrates of the Republic from 451 to 449 B.C., for the purpose of drawing up a code of laws. In 462 B.C. a tribune proposed that the appointment of a commission to draw up a code expressing the legal principles of the administration was necessary to secure for the *plebs* a hold over magisterial caprice. Continued agitation to this effect resulted in an agreement in 452 B.C. between patricians and plebeians that decemvirs should be appointed to draw up a code, that during their tenure of office all other magistracies should be in abeyance, that they should not be subject to appeal, but that they should be bound to maintain the laws which guaranteed by religious sanctions the rights of the *plebs*. The first board of decemvirs (apparently consisting wholly of patricians) was appointed to hold office during 451 B.C.; and the chief man among them was Appius Claudius. Livy (iii. 32) says that only patricians were eligible. Mommsen, however, held that plebeians were legally eligible, though none were actually appointed for 451. The decemvirs ruled with singular moderation, and submitted to the *Comitia Centuriata* a code of laws in ten headings, which was passed. So popular were the decemvirs that another board of ten was appointed for the following year, some of whom, if the extant list of names is correct, were certainly plebeians. These added two more to the ten laws of their predecessors, thus completing the Laws of the Twelve Tables (see ROMAN LAW). But their rule then became violent and tyrannical, and they fell before the fury of the *plebs*, though for some reason, not easily understood, they continued to have the support of the patricians. They were forced to abdicate (449 B.C.), and the ordinary magistrates were restored.

II. The judicial board of decemvirs (*stitibus judicandis*) formed a civil court of ancient origin concerned mainly with questions bearing on the status of individuals. They were originally a body of jurors which gave a verdict under the presidency of the praetor (*q.v.*), but eventually became annual minor magistrates of the Republic, elected by the *Comitia Tributa*.

III. The priestly board of decemvirs (*sacris faciundis*) was an outcome of the claim of the *plebs* to a share in the administration of the state religion. Five of the decemvirs were patricians, and five plebeians. They were first appointed in 367 B.C. instead of the patrician *duumviri* who had hitherto performed these duties. The board was increased to fifteen in the last century of the Republic. Its chief function was the care of the Sibylline books, and the celebration of the games of Apollo (Livy x. 8) and the Secular Games (Tac. *Ann.* xi. 11).

IV. Decemvirs were also appointed from time to time to control the distribution of the public land (*agris dandis adsignandis*; see AGRARIAN LAWS).

BIBLIOGRAPHY.—B. G. Niebuhr, *History of Rome* (Eng. trans.), ii. 309 et seq. (Cambridge, 1832); Th. Mommsen, *History of Rome*,

bk. ii. c. 2, vol. i. pp. 361 et seq. (Eng. trans., new ed., 1894); *Römisches Staatsrecht*, ii. 605 et seq., 714 (Leipzig, 1887); A. H. J. Greenidge, *Legal Procedure of Cicero's Time*, p. 40 et seq., 263 (Oxford, 1901); J. Muirhead, *Private Law of Rome*, p. 73 et seq. (London, 1899); Pauly-Wissowa, *Realencyclopädie*, iv. 2256 et seq. (Kübler). (A. M. CL.)

**DECHEN, ERNST HEINRICH KARL VON** (1800–1889), German geologist, was born in Berlin on the 25th of March 1800, and was educated in the university in that city. He subsequently studied mining in Bochum and Essen, and was in 1820 placed in the mining department of the Prussian state, serving on the staff until 1864, and becoming director in 1841 when he was stationed at Bonn. In early years he made journeys to study the mining systems of other countries, and with this object he visited England and Scotland in company with Karl von Oeynhausen (1797–1865). In the course of his work he paid special attention to the coal-formation of Westphalia and northern Europe generally, and he greatly furthered the progress made in mining and metallurgical works in Rhenish Prussia. He made numerous contributions to geological literature; notably the following:—*Geognostische Umrisse der Rheinländer zwischen Basel und Mainz mit besonderer Rücksicht auf das Vorkommen des Steinsalzes* (with von Oeynhausen and La Roche), 2 vols. (Berlin, 1825); *Geognostische Führer in das Siebengebirge am Rhein* (Bonn, 1861); *Die nutzbaren Mineralien und Gebirgsarten im deutschen Reiche* (1873). But his main work was a geological map of Rhenish Prussia and Westphalia in 35 sheets on the scale of 1: 80,000, issued with two volumes of explanatory text (1855–1882). He published also a small geological map of Germany (1869). He died at Bonn on the 15th of February 1889. (H. B. W.)

**DECIDUOUS** (from Lat. *decidere*, to fall down), a botanical and zoological term for "falling in season," as of petals after flowering, leaves in autumn, the teeth or horns of animals, or the wings of insects.

**DECIMAL COINAGE.**<sup>1</sup> Any currency in which the various denominations of coin are arranged in multiples or submultiples of ten (Lat. *decem*), with reference to a standard unit, is a decimal system. Thus if the standard unit be 1 the higher coins will be 10, 100, 1000, &c., the lower .1, .01, .001, &c. In a perfect system there would be no breaks or interpolations, but the actual currencies described as "decimal" do not show this rigid symmetry. In France the standard unit—the franc—has the 10 franc and the 100 franc pieces above it; the 10 centime below it; there are also, however, 50 franc, 20 franc, 5 franc, 2 franc pieces as well as 50 and 20 centime ones. Similar irregularities occur in the German and United States coinages, and indeed in all countries in which a decimal system has been established. Popular convenience has compelled this departure from the strict decimal form.

Subject to these practical modifications the leading countries of the world (Great Britain and India are the chief exceptions) have adopted decimal coinage. The United States led the way (1786 and 1792) with the dollar as the unit, and France soon followed (1799 and 1803), her system being extended to the countries of the Latin Union (1865). The German empire (1873), the Scandinavian States (1875), Austria-Hungary (1870, developed in 1892) and Russia (1839 and 1897) are further adherents to the decimal system. The Latin-American countries and Japan (1871) have also adopted it.

In England proposals for decimalizing the coinage have long been under discussion at intervals. Besides the inconvenience of altering the established currency, the difficulty of choosing between the different schemes propounded has been a considerable obstacle. One plan took the farthing as a base: then 10 farthings = 1 doit (2½d.), 10 doits = 1 florin (2s. 1d.), 10 florins = 1 pound (20s. 10d.). The advantages claimed for this scheme were (1) the preservation of the smaller coins (the penny = 4 farthings); and (2) the avoidance of interference with the smaller retail prices. Its great disadvantage was the destruction of the existing unit of value—the pound—and the consequent disturbance of all accounts. A second proposal would retain the pound as unit and the florin, but would subdivide the latter into

<sup>1</sup> For "decimal" in general see ARITHMETIC.

100 "units" (or farthings reduced 4%) and introduce a new coin = 10 units (2.4d.). By it the unit of account would remain as at present, and the shilling (as 50 units) would continue in use. The alteration of the bronze and several silver coins, and the need of readjusting all values and prices expressed in pence, formed the principal difficulties. A third scheme, which was connected with the assimilation of English to French and American money, proposed the establishment of an 8s. gold coin as unit, with the tenpenny or franc and the penny (reduced by 4%) as subdivisions. The new coin would be equivalent to 10 francs or (by an anticipated reduction of the dollar) 2 dollars. None of these plans has gained any great amount of popular support.

For the general question of monetary scales see MONEY, and for the decimal system in reference to weights and measures see METRIC SYSTEM and WEIGHTS AND MEASURES. (C. F. B.)

**DECIOUS, GAIVS MESSIVS QVINTVS TRAJANVS** (201-251), Roman emperor, the first of the long succession of distinguished men from the Illyrian provinces, was born at Budalia near Sirmium in lower Pannonia in A.D. 201. About 245 the emperor Philip the Arabian entrusted him with an important command on the Danube, and in 249 (or end of 248), having been sent to put down a revolt of the troops in Moesia and Pannonia, he was forced to assume the imperial dignity. He still protested his loyalty to Philip, but the latter advanced against him and was slain near Verona. During his brief reign Decius was engaged in important operations against the Goths, who crossed the Danube and overran the districts of Moesia and Thrace. The details are obscure, and there is considerable doubt as to the part taken in the campaign by Decius and his son (of the same name) respectively. The Goths were surprised by the emperor while besieging Nicopolis on the Danube; at his approach they crossed the Balkans, and attacked Philippopolis. Decius followed them, but a severe defeat near Beroë made it impossible to save Philippopolis, which fell into the hands of the Goths, who treated the conquered with frightful cruelty. Its commander, Priscus, declared himself emperor under Gothic protection. The siege of Philippopolis had so exhausted the numbers and resources of the Goths, that they offered to surrender their booty and prisoners on condition of being allowed to retire unmolested. But Decius, who had succeeded in surrounding them and hoped to cut off their retreat, refused to entertain their proposals. The final engagement, in which the Goths fought with the courage of despair, took place on swampy ground in the Dobrudja near Abritum (Abrittus) or Forum Trebonii and ended in the defeat and death of Decius and his son. Decius was an excellent soldier, a man of amiable disposition, and a capable administrator, worthy of being classed with the best Romans of the ancient type. The chief blot on his reign was the systematic and authorized persecution of the Christians, which had for its object the restoration of the religion and institutions of ancient Rome. Either as a concession to the senate, or perhaps with the idea of improving public morality, Decius endeavoured to revive the separate office and authority of the censor. The choice was left to the senate, who unanimously selected Valerian (afterwards emperor). But Valerian, well aware of the dangers and difficulties attaching to the office at such a time, declined the responsibility. The invasion of the Goths and the death of Decius put an end to the abortive attempt.

See Aurelius Victor, *De Caesaribus*, 29, *Epit.* 29; Jordanes, *De rebus Geticis*, 18; fragments of Dexippus, in C. W. Müller, *Frag. Hist. Graec.* iii. (1849); Gibbon, *Decline and Fall*, chap. 10; H. Schiller, *Geschichte der römischen Kaiserzeit*, i. (pt. 2), 1883.

**DECIZE**, a town of central France, in the department of Nièvre, on an island in the Loire, 24 m. S.E. of Nevers by the Paris-Lyon railway. Pop. (1906) 3813. The most important of its buildings is the church of Saint Aré, which dates in part from the 11th and 12th centuries; there are also ruins of a castle of the counts of Nevers. The town has a statue of Guy Coquille, the lawyer and historian, who was born there in 1523. Decize is situated at the starting-point of the Nivernais canal. The coal mine of La Machine, which belongs to the Schneider Company of Le Creusot, lies four miles to the north. The industries of Decize and its suburbs on both banks of the Loire include the working of gypsum

and lime, and the manufacture of ceramic products and glass. Trade is in horses from the Morvan, cattle, coal, iron, wood and stone.

Under the name of *Decetia* the place is mentioned by Julius Caesar as a stronghold of the Aedui, and in 52 B.C. was the scene of a meeting of the senate held by him to settle the leadership of the tribe and to reply to his demand for aid against Vercingetorix. In later times it belonged to the counts of Nevers, from whom it obtained a charter of franchise in 1226.

**DECKER, SIR MATTHEW**, Bart. (1679-1749), English merchant and writer on trade, was born in Amsterdam in 1679. He came to London in 1702 and established himself there as a merchant. He was remarkably successful in his business life, gaining great wealth and having many honours conferred upon him. He was a director of the East India Company, sat in parliament for four years as member for Bishops Castle, and was high sheriff of Surrey in 1729. He was created a baronet by George I. in 1716. Decker's fame as a writer on trade rests on two tracts. The first, *Serious considerations on the several high duties which the Nation in general, as well as Trade in particular, labours under, with a proposal for preventing the removal of goods, discharging the trader from any search, and raising all the Publick Supplies by one single Tax* (1743; name affixed to 7th edition, 1756), proposed to do away with customs duties and substitute a tax upon houses. He also suggested taking the duty off tea and putting instead a licence duty on households wishing to consume it. The second, an *Essay on the Causes of the Decline of the Foreign Trade, consequently of the value of the lands in Britain, and on the means to restore both* (1744), has been attributed to W. Richardson, but internal evidence is strongly in favour of Decker's authorship. He advocates the licence plan in an extended form; urges the repeal of import duties and the abolition of bounties, and, in general, shows himself such a strong supporter of the doctrine of free trade as to rank as one of the most important forerunners of Adam Smith. Decker died on the 18th of March 1749.

**DECKER, PIERRE DE** (1812-1891), Belgian statesman and author, was educated at a Jesuit school, studied law at Paris, and became a journalist on the staff of the *Revue de Bruxelles*. In 1839 he was elected to the Belgian lower chamber, where he gained a great reputation for oratory. In 1855 he became minister of the interior and prime minister, and attempted, by a combination of the moderate elements of the Catholic and Liberal parties, the impossible task of effecting a settlement of the educational and other questions by which Belgium was distracted. In 1866 he retired from politics and went into business, with disastrous results. He became involved in financial speculations which lost him his good name as well as the greater part of his fortune; and, though he was never proved to have been more than the victim of clever operators, when in 1871 he was appointed by the Catholic cabinet governor of Limburg, the outcry was so great that he resigned the appointment and retired definitively into private life. He died on the 4th of January 1891. Decker, who was a member of the Belgian academy, wrote several historical and other works of value, of which the most notable are *Études historiques et critiques sur les monts-de-piété en Belgique* (Brussels, 1844); *De l'influence du libre arbitre de l'homme sur les faits sociaux* (1848); *L'Esprit de parti et l'esprit national* (1852); *Étude politique sur le vicomte Ch. Vilain XIII* (1879); *Épisodes de l'hist. de l'art en Belgique* (1883); *Biographie de H. Conscience* (1885).

**DECLARATION** (from Lat. *declarare*, to make fully clear, *clarus*), formerly, in an action at English law, the first step in pleading—the precise statement of the matter in respect of which the plaintiff sued. It was divided into counts, in each of which a specific cause of action was alleged, in wide and general terms, and the same acts or omissions might be stated in several counts as different causes of actions. Under the system of pleading established by the Judicature Act 1875, the declaration has been superseded by a statement of claim setting forth the facts on which the plaintiff relies. Declarations are now in use only in the mayor's court of London and certain local courts of record,



and in those of the United States and the British colonies in which the Common Law system of pleading survives. In the United States a declaration is termed a "complaint," which is the first pleading in an action. It is divided into parts,—the *title* of the court and term; the *venue* or county in which the facts are alleged to have occurred; the *commencement*, which contains a statement of the names of the parties and the character in which they appear; the *statement* of the cause of action; and the *conclusion* or claim for relief. (See PLEADING.)

The term is also used in other English legal connexions; e.g. the Declaration of Insolvency which, when filed in the Bankruptcy Court by any person unable to pay his debts, amounts to an act of bankruptcy (see BANKRUPTCY); the Declaration of Title, for which, when a person apprehends an invasion of his title to land, he may, by the Declaration of Title Act 1862, petition the Court of Chancery (see LAND REGISTRATION); or the Declaration of Trust, whereby a person acknowledges that property, the title of which he holds, belongs to another, for whose use he holds it; by the Statute of Frauds, declarations of trust of land must be evidenced in writing and signed by the party declaring the trust. (See TRUSTS.) By the Statutory Declarations Act 1835 (which was an act to make provision for the abolition of unnecessary oaths, and to repeal a previous act of the same session on the same subject), various cases were specified in which a solemn declaration was, or might be, substituted for an affidavit. In nearly all civilized countries an affirmation is now permitted to those who object to take an oath or upon whose conscience an oath is not binding. (See AFFIDAVIT; OATH.)

An exceptional position in law is accorded to a Dying or Death-bed Declaration. As a general rule, hearsay evidence is excluded on a criminal charge, but where the charge is one of homicide it is the practice to admit dying declarations of the deceased with respect to the cause of his death. But before such declarations can be admitted in evidence against a prisoner, it must be proved that the deceased when making the declaration had given up all hope of recovery. Unsworn declarations as to family matters, e.g. as to pedigree, may also be admitted as evidence, as well as declarations made by deceased persons in the course of their duty. (See EVIDENCE.)

**DECLARATION OF PARIS**, a statement of principles of international law adopted at the conclusion (16th of April 1856) of the negotiations for the treaty of Paris at the suggestion of Count Walewski, the French plenipotentiary. The declaration set out that maritime law in time of war had long been the subject of deplorable disputes, that the uncertainty of the rights and duties in respect of it gave rise to differences of opinion between neutrals and belligerents which might occasion serious difficulties and even conflicts, and that it was consequently desirable to agree upon some fixed uniform rules. The plenipotentiaries therefore adopted the four following principles:—

1. Privateering is and remains abolished; 2. The neutral flag covers enemy's goods, with the exception of contraband of war; 3. Neutral goods, with the exception of contraband of war, are not liable to capture under the enemy's flag; 4. Blockades, in order to be binding, must be effective, that is to say, maintained by a force sufficient really to prevent access to the coast of the enemy.

They also undertook to bring the declaration to the knowledge of the states which had not taken part in the congress of Paris and to invite them to accede to it. The text of the declaration concluded as follows:—"Convinced that the maxims which they now proclaim cannot but be received with gratitude by the whole world, the undersigned plenipotentiaries doubt not that the efforts of their governments to obtain the general adoption thereof will be crowned with full success."

The declaration is of course binding only on the powers which adopted it or have acceded to it. The majority which adopted it consisted of Great Britain, Austria, France, Prussia, Russia, Sardinia and Turkey. The United States government declined to sign the declaration on the ground that, not possessing a great navy, they would be obliged in time of war to rely largely upon merchant ships commissioned as war vessels, and that therefore the abolition of privateering would be entirely in favour of European powers, whose large navies rendered them practically

independent of such aid. All other maritime states acceded to the declaration except Spain, Mexico<sup>1</sup> and Venezuela.

Although the United States and Spain were not parties to the declaration, both, during the Spanish-American War, observed its principles. The Spanish government, however, expressly gave notice that it reserved its right to issue letters of marque. At the same time both belligerents organized services of auxiliary cruisers composed of merchant ships under the command of naval officers. In how far this might operate as a veiled revival of the forbidden practice has now ceased to be a matter of much importance, the Hague Conference having adopted a series of rules on the subject which may be said to interpret the first of the four principles of the declaration with such precision as to take its place.

The New Convention on the subject (October 18th, 1907) sets out that, in view of the incorporation in time of war of merchant vessels in combatant fleets, it is desirable to define the conditions under which this can be effected, that, nevertheless, the contracting powers, not having been able to come to an understanding on the question whether the transformation of a merchant ship into a war vessel may take place on the high sea,<sup>2</sup> are agreed that the question of the place of transformation is in no way affected by the rules adopted, which are as follows:—

Art. i. No merchant ship transformed into a war vessel can have the rights and obligations attaching to this condition unless it is placed under the direct authority, the immediate control and the responsibility of the power whose flag it carries.

Art. ii. Merchant ships transformed into war vessels must bear the distinctive external signs of war vessels of their nationality.

Art. iii. The officer commanding must be in the service of the state, and properly commissioned by the competent authorities. His name must appear in the list of officers of the combatant fleet.

Art. iv. The crew must be subject to the rules of military discipline.

Art. v. Every merchant ship transformed into a war vessel is bound to conform, in its operation, to the laws and customs of war.

Art. vi. The belligerent who transforms a merchant ship into a war vessel must, as soon as possible, mention this transformation on the list of vessels belonging to its combatant fleet.

Art. vii. The provisions of the present convention are only applicable as among the contracting powers and provided the belligerents are all parties to the convention.

See T. Gibson Bowles, *Declaration of Paris* (London, 1900); Sir T. Barclay, *Problems of International Practice and Diplomacy* (London, 1907), chap. xv.<sup>3</sup> (T. B. A.)

**DECLARATOR**, in Scots law, a form of action by which some right of property, or of servitude, or of status, or some inferior right or interest, is sought to be judicially declared.

**DECLINATION** (from Lat. *declinare*, to decline), in magnetism the angle between true north and magnetic north, i.e. the variation between the true meridian and the magnetic meridian. In 1596 at London the angle of declination was 11° E. of N., in 1652 magnetic north was true north, in 1815 the magnetic needle pointed 24½° W. of N., in 1891 18° W., in 1896 17° 56' W. and in 1906 17° 45'. The angle is gradually diminishing and the declination will in time again be 0°, when it will slowly increase in an easterly direction, the north magnetic pole oscillating slowly around the North Pole. Regular daily changes of declination also occur. Magnetic storms cause irregular variations sometimes of one or two degrees. (See MAGNETISM, TERRESTRIAL.)

In astronomy the declination is the angular distance, as seen from the earth, of a heavenly body from the celestial equator, thus corresponding with terrestrial latitude.

**DECOLOURIZING**, in practical chemistry and chemical technology, the removal of coloured impurities from a substance. The agent most frequently used is charcoal, preferably prepared from blood, which when shaken with a coloured solution frequently precipitates the coloured substances leaving the solution clear. Thus the red colour of wines may be removed by filtering the wine through charcoal; the removal of the dark-coloured

<sup>1</sup>At the 7th plenary sitting of the second Hague Conference (September 7th, 1907) the chiefs of the Spanish and Mexican delegations, M. de Villa Urratia and M. de la Barra, announced the determination of their respective governments to accede to the Declaration of Paris.

<sup>2</sup>This relates to the incident in the Russo-Japanese War of the transformation of Russian vessels which had passed through the Dardanelles unarmed.

impurities which arise in the manufacture of sugar may be similarly effected. Other "decolourizers" are sulphurous acid, permanganates and manganates, all of which have received application in the sugar industry.

**DECORATED PERIOD**, in architecture, the term given by Richman to the second pointed or Gothic style, 1307-1377. It is characterized by its window tracery, geometrical at first and flowing in the later period, owing to the omission of the circles in the tracery of windows, which led to the juxtaposition of the foliations and their pronounced curves of *contre-flexure*. This flowing or flamboyant tracery was introduced in the first quarter of the century and lasted about fifty years. The arches are generally equilateral, and the mouldings bolder than in the Early English, with less depth in the hollows and with the fillet largely used. The ball flower and a four-leaved flower take the place of the dog-tooth, and the foliage in the capitals is less conventional than in Early English and more flowing, and the diaper patterns in walls are more varied. The principal examples are those of the east end of Lincoln and Carlisle cathedral; the west fronts of York and Lichfield; the crossing of Ely cathedral, including the lantern and three west bays of choir and the Lady Chapel; and Melrose Abbey.

(R. P. S.)

**DE COSTA, BENJAMIN FRANKLIN** (1831-1904), American clergyman and historical writer, was born in Charlestown, Massachusetts, on the 10th of July 1831. He graduated in 1856 at the Biblical Institute at Concord, New Hampshire (now a part of Boston University), became a minister in the Episcopal Church in 1857, and during the next three years was a rector first at North Adams, and then at Newton Lower Falls, Mass. After serving as chaplain in two Massachusetts regiments during the first two years of the Civil War, he became editor (1863) of *The Christian Times* in New York, and subsequently edited *The Episcopalian* and *The Magazine of American History*. He was rector of the church of St John the Evangelist in New York city from 1881 to 1899, when he resigned in consequence of being converted to Roman Catholicism. He was one of the organizers and long the secretary of the Church Temperance Society, and founded and was the first president (1884-1899) of the American branch of the White Cross Society. He became a high authority on early American cartography and the history of the period of exploration. He died in New York city on the 4th of November 1904. In addition to numerous monographs and valuable contributions to Winsor's *Narrative and Critical History of America*, he published *The Pre-Columbian Discovery of America by the Northmen* (1868); *The Northmen in Maine* (1870); *The Moabite Stone* (1871); *The Rector of Roxburgh* (1871), a novel under the *nom de plume* of "William Hickling"; and *Verrazano the Explorer; being a Vindication of his Letter and Voyage* (1880).

**DE COSTER, CHARLES THÉODORE HENRI** (1827-1879), Belgian writer, was born at Munich on the 20th of August 1827. His father, Augustin de Coster, was a native of Liège, who was attached to the household of the papal nuncio at Munich, but soon returned to Belgium. Charles was placed in a Brussels bank, but in 1850 he entered the university of Brussels, where he completed his studies in 1855. He was one of the founders of the *Société des Joyeux*, a small literary club, more than one member of which was to achieve literary distinction. De Coster made his début as a poet in the *Revue trimestrielle*, founded in 1854, and his first efforts in prose were contributed to a periodical entitled *Uylenspiegel* (founded 1856). A correspondence covering the years 1850-1858, his *Lettres à Élisa*, were edited by Ch. Potvin in 1894. He was a keen student of Rabelais and Montaigne, and familiarized himself with 16th-century French. He said that Flemish manners and speech could not be rendered faithfully in modern French, and accordingly wrote his best works in the old tongue. The success of his *Légendes flamandes* (1857) was increased by the illustrations of Félicien Rops and other friends. In 1861 he published his *Contes brabançons*, in modern French. His masterpiece is his *Légende de Thyl Uylenspiegel et de Lamme Goedzak* (1867), a 16th-century romance, in which Belgian patriotism found its fullest expression. In the preparation for this prose epic of the *gueux* he spent some ten

years. Uylenspiegel (Eulenspiegel) has been compared to Don Quixote, and even to Panurge. He is the type of the 16th-century Fleming, and the history of his resurrection from the grave itself was accepted as an allegory of the destiny of the race. The exploits of himself and his friend form the thread of a semi-historical narrative, full of racy humour, in spite of the barbarities that find a place in it. This book also was illustrated by Rops and others. In 1870 De Coster became professor of general history and of French literature at the military school. His works however were not financially profitable; in spite of his government employment he was always in difficulties; and he died in much discouragement on the 7th of May 1879 at Ixelles, Brussels. The expensive form in which *Uylenspiegel* was produced made it open only to a limited class of readers, and when a new and cheap edition in modern French appeared in 1893 it was received practically as a new book in France and Belgium.

**DECOY**, a contrivance for the capture or enticing of duck and other wild fowl within range of a gun, hence any trap or enticement into a place or situation of danger. Decoys are usually made on the following plan: long tunnels leading from the sea, channel or estuary into a pool or pond are covered with an arched net, which gradually narrows in width; the ducks are enticed into this by a tame trained bird, also known as a "decoy" or "decoy-duck." In America the "decoy" is an artificial bird, placed in the water as if it were feeding, which attracts the wild fowl within range of the concealed sportsman. The word "decoy" has, etymologically, a complicated history. It appears in English first in the 17th century in these senses as "coy" and "coy-duck," from the Dutch *kooi*, a word which is ultimately connected with Latin *cavea*, hollow place, "cage."<sup>1</sup> The *de-*, with which the word begins, is either a corruption of "duck-coy," the Dutch article *de*, or a corruption of the Dutch *eende-kooi*, *eende*, duck. The *New English Dictionary* points out that the word "decoy" is found in the particular sense of a sharper or swindler as a slang term slightly earlier than "coy" or "decoy" in the ordinary sense, and, as the name of a game of cards, as early as 1550, apparently with no connexion in meaning. It is suggested that "coy" may have been adapted to this word.

**DECREE** (from the past participle, *decretus*, of Lat. *decernere*), in earlier form *Decreet*, an authoritative decision having the force of law; the judgment of a court of justice. In Roman law, a decree (*decretum*) was the decision of the emperor, as the supreme judicial officer, settling a case which had been referred to him. In ecclesiastical law the term was given to a decision of an ecclesiastical council settling a doubtful point of doctrine or discipline (*cf.* also **DECRETALS**). In English law decree was more particularly the judgment of a court of equity, but since the Judicature Acts the expression "judgment" (*q.v.*) is employed in reference to the decisions of all the divisions of the supreme court. A "decree nisi" is the conditional order for a dissolution of marriage made by the divorce court, and it is made "absolute" after six months (which period may, however, be shortened) in the absence of sufficient cause shown to the contrary. (See **DIVORCE**.) *Decreet arbitral* is a Scottish phrase for the award of an arbitrator.

**DECRETALS** (*Epistolae decretales*), the name (see **DECREE** above), which is given in Canon Law to those letters of the pope which formulate decisions in ecclesiastical law; they are generally given in answer to consultations, but are sometimes due to the initiative of the popes. These furnish, with the canons of the councils, the chief source of the legislation of the church, and form the greater part of the *Corpus Juris*. In this connexion they are dealt with in the article on Canon Law (*q.v.*).

*The False Decretals*. A special interest, however, attaches to the celebrated collection known by this name. This collection, indeed, comprises at least as many canons of councils as decretals, and the decretals contained in it are not all forgeries. It is an amplification and interpolation, by means of spurious decretals, of the canonical collection in use in the Church of Spain in the 8th century, all the documents in which are perfectly authentic.

<sup>1</sup> Distinguish "coy," affectedly shy or modest, from O. Fr. *coi*, Lat. *quietus*, quiet.

With these amplifications, the collection dates from the middle of the 9th century. We shall give a brief account of its contents, its history and its influence on canon law.

The author assumes the name of Isidore, evidently the archbishop of Seville, who was credited with a preponderating part in the compilation of the *Hispana*; he takes in addition the surname of Mercator, perhaps because he has made use of two passages of Marius Mercator. Hence the custom of alluding to the author of the collection under the name of the pseudo-Isidore.

The collection itself is divided into three parts. The first, which is entirely spurious, contains, after the preface and various introductory sections, seventy letters attributed to the popes of the first three centuries, up to the council of Nicaea, *i.e.* up to but not including St Silvester; all these letters are a fabrication of the pseudo-Isidore, except two spurious letters of Clement, which were already known. The second part is the collection of councils, classified according to their regions, as it figures in the *Hispana*; the few spurious pieces which are added, and notably the famous Donation of Constantine, were already in existence. In the third part the author continues the series of decretals which he had interrupted at the council of Nicaea. But as the collection of authentic decretals does not begin till Siricius (385), the pseudo-Isidore first forges thirty letters, which he attributes to the popes from Silvester to Damasus; after this he includes the authentic decretals, with the intermixture of thirty-five apocryphal ones, generally given under the name of those popes who were not represented in the authentic collection, but sometimes also under the names of the others, for example, Damasus, St Leo, Vigilius and St Gregory; with one or two exceptions he does not interpolate genuine decretals. The series stops at St Gregory the Great (d. 604), except for one letter of Gregory II. (715-731). The forged letters are not, for the most part, entirely composed of fresh material; the author draws his inspiration from the notices on each of the popes given in the *Liber Pontificalis*; he inserts whole passages from ecclesiastical writers; and he antedates the evidences of a discipline which actually existed; so it is by no means all invented.

Thus the authentic elements were calculated to serve as a passport for the forgeries, which were, moreover, quite skilfully composed. In fact, the collection thus blended was passed from hand to hand without meeting with any opposition. At most all that was asked was whether those decretals which did not appear in the *Liber canonum* (the collection of Dionysius Exiguus, accepted in France) had the force of law, but Pope Nicholas having answered that all the pontifical letters had the same authority (see *Decr. Gra.* Dist. xix. c. 1), they were henceforward accepted, and passed in turn into the later canonical collections. No doubts found an expression until the 15th century, when Cardinal Nicholas of Cusa (d. 1464) and Juan Torquemada (d. 1468) freely expressed their suspicions. More than one scholar of the 16th century, George Cassander, Erasmus, and the two editors of the *Decretum* of Gratian, Dumoulin (d. 1568) and Le Conte (d. 1577), decisively rejected the False Decretals. This contention was again upheld, in the form of a violent polemic against the papacy, by the Centuriators of Magdeburg (*Ecclesiastica historia*, Basel, 1559-1574); the attempt at refutation by the Jesuit Torres (*Adversus Centur. Magdeburg. libri quinque*, Florence, 1572) provoked a violent rejoinder from the Protestant minister David Blondel (*Pseudo-Isidorus et Turrianus rapulantes*, Geneva, 1620). Since then, the conclusion has been accepted, and all researches have been of an almost exclusively historical character. One by one the details are being precisely determined, and the question may now almost be said to be settled.

In the first place, an exact determination of the date of the collection has been arrived at. On the one hand, it cannot go back further than 847, the date of the False Capitularies, with which the author of the False Decretals was acquainted.<sup>1</sup> On the other hand, in a letter of Lupus, abbot of

Ferrières, written in 858, and in the synodical letter of the council of Quierzy in 857 are to be found quotations which are certainly from these false decretals; and further, an undoubted allusion in the statutes given by Hincmar to his diocese on the 1st of November 852. The composition of the collection must then be dated approximately at 850.

The object which the forger had in view is clearly stated in his preface; the reform of the canon law, or rather its better application. But, again, in what particular respects he wishes it to be reformed can be best deduced from certain preponderant ideas which make themselves felt in the apocryphal documents. He constantly harps upon accusations brought against bishops and the way they were judged; his wish is to prevent them from being unjustly accused, deposed or deprived of their sees; to this end he multiplies the safeguards of procedure, and secures the right of appeal to the pope and the possibility of restoring bishops to their sees. His object, too, was to protect the property, as well as the persons, of the clergy against the encroachments of the temporal power. In the second place, Isidore wishes to increase the strength and cohesion of the churches; he tries to give absolute stability to the diocese and the ecclesiastical province; he reinforces the rights of the bishop and his comprovincials, while he initiates a determined campaign against the *chorepiscopi*; finally, as the keystone of the arch he places the papacy. These aims are most laudable, and in no way subversive; but the author must have had some particular reasons for emphasizing these questions rather than others; and the examination of these reasons may help us to determine the nationality of this collection.

The name of Isidore usurped by the author at first led to the supposition that the False Decretals originated in Spain; this opinion no longer meets with any support; it is enough to point out that there is no Spanish manuscript of the collection, at least until the 13th century. In the 16th century the Protestants, who wished to represent the forgeries in the light of an attempt in favour of the papacy, ascribed the origin of the False Decretals to Rome, but neither the manuscript tradition nor the facts confirm this view, which is nowadays entirely abandoned. Everybody is agreed in placing the origin of the False Decretals within the Frankish empire. Within these limits, three different theories have successively arisen: "At first it was thought that Isidore's domicile could be fixed in the province of Mainz, it is now about fifty years ago that the balance of opinion was turned in favour of the province of Reims; and now, after the lapse of about twenty years, several authors have suggested the province of Tours" (P. Fournier, *Étude sur les Fausses Décretales*). In favour of Mainz, especial stress was laid on the fact that it was the country of Benedictus Levita, the compiler of the False Capitularies, to which the False Decretals are closely related. But Benedict, the deacon of Otgar of Mainz, is as much of a hypothetical personage as Isidorus Mercator; moreover, in the middle of the 9th century the condition of the province of Mainz was not disturbed, nor were the *chorepiscopi* menaced. In favour of Reims, it has been pointed out that it was there that the first judicial use of the False Decretals is recorded, in the trials of Rothad, bishop of Soissons (d. 869), and of Hincmar the younger, bishop of Laon (d. c. 882); and an application of the axiom has been attempted: *Is fecit cui prodest*. But both these trials took place later than 852, at which date the existence of the collection is an established fact; the texts of it were used, but they were in existence before. Between 847 and 852, the province of Reims was disturbed by another affair, that of the clergy ordained by Ebbo at the time of his short restoration to the see of Reims, in 840-841; these clerics, Vulfadus (afterwards archbishop of Bourges), and a few others, had been suspended by Hincmar on his election in 845. But the affair of Ebbo's clergy did not become critical till the council of Soissons in 853; up till then these clergy had, so far

<sup>1</sup> The False Capitularies are for civil legislation what the False Decretals are for ecclesiastical legislation: three books of Capitularies of the Frankish kings, more of which are spurious than authen-

tic. The author gives himself out as a certain Benedict, a deacon of the church of Mainz; hence the name by which he is usually known, Benedictus Levita. The two false collections are closely akin, and are doubtless the fabrication of the same hands.

as we know, produced no documents, and the citations from the False Decretals made in their later writings do not prove that they had forged them. Moreover, Hincmar would not have cited the forged letters of the popes in 852; above all, this theory would not explain the chief preoccupation of the forger, which is to protect bishops against unjust judgments and depositions. We must, then, look for conditions in which the bishops were concerned. It is precisely this which has suggested the province of Tours. Brittany, which was dependent on the province of Tours, had just for a time recovered its independence, thanks to its duke Nominoë. The struggle between the two nationalities, the Celt and the Frank, found a reflexion in the sphere of religion. The Breton bishops were for the most part abbots of monasteries, who had but little consideration for the territorial limits of the *civitates*; and many of the religious usages of the Bretons differed profoundly from those of the Franks. Charlemagne had divided up the Breton dioceses and established in them Frankish bishops. Nominoë hastened to depose the four Frankish bishops, after wringing from them by force confessions of simony; he then established a metropolitan see at Dol. Hence arose incessant complaints on the part of the dispossessed bishops, of the metropolitan of Tours, and his suffragans, notably those of Angers and Le Mans, which were more exposed than the others to the incursions of the Bretons; and this gave rise to numerous papal letters, and all this throughout a period of thirty years. There were requests that the bishops should be judged according to the rules, protests against the interlopers, demands for the restoration of the bishops to their sees. These circumstances fall in perfectly with the questions about which, as we have pointed out, the pseudo-Isidore was mainly concerned: the judgment of bishops, and the stability of the ecclesiastical organizations.

In the province of Tours, attempts have been made to define more clearly the centre of the forgeries, and the most recent authorities fix upon Le Mans. The sole argument, though a very weighty one, is found in the undeniable relation, revealed in an astonishing similarity both in expressions and composition, which exists between these forgeries and some other documents certainly fabricated at Le Mans, under the episcopate of Aldric (832-856), notably the *Actus Pontificum Cenomanis in urbe degenitium*, in which there is no lack of forged documents. These certainly bear the mark of the same hand.

Though we cannot admit that the False Decretals were composed in order to enforce the rights of the papacy, we may at least consider whether the popes did not make use of the False Decretals to support their rights. It is certain that in 864 Rothad of Soissons took with him to Rome, if not the collection, at least important extracts from the pseudo-Isidore; M. Fournier has pointed out in the letters of the pope of that time, "a literary influence, which is shown in the choice of expressions and metaphors," notably in those passages relating to the *restitutio spoliis*; but he concludes by affirming that the ideas and acts of Nicholas were not modified by the new collection: even before 864 he acted in affairs concerning bishops, e.g. in the case of the Breton bishops or the adversaries of Photius, patriarch of Constantinople, exactly as he acted later; all that can be said is that the False Decretals, though not expressly cited by the pope, "led him to accentuate still further the arguments which he drew from the decrees of his predecessors," notably with regard to the *exceptio spoliis*. In the papal letters of the end of the 9th and the whole of the 10th century, only two or three insignificant citations of the pseudo-Isidore have been pointed out; the use of the pseudo-Isidorian forged documents did not become prevalent at Rome till about the middle of the 11th century, in consequence of the circulation of the canonical collections in which they figured; but nobody then thought of casting any doubts on the authenticity of those documents. One thing only is established, and this may be said to have been the real effect of the False Decretals, namely, the powerful impulse which they gave in the Frankish territories to the movement towards centralization round the see of Rome, and the legal

obstacles which they opposed to unjust proceedings against the bishops.

**BIBLIOGRAPHY.**—The best edition is that of P. Hinschius, *Decretales pseudo-Isidorianae et capitula Angilramni* (Leipzig, 1863). In it the authentic texts are printed in two columns, the forgeries across the whole width of the page; an important preface of ccxxviii. pages contains, besides the classification of the MSS., a profound study of the sources and other questions bearing on the collection. After the works cited above, the following dissertations should be noted. Placing the origin of the False Decretals at Rome is: A. Theiner, *De pseudo-Isidoriana canonum collectione* (Breslau, 1827); at Mainz, the brothers Ballerini, *De antiquis collectionibus et collectoribus canonum*, iii. (*S. Leonis opera*, t. iii.; Migne, *Patrologia Lat.* t. 56); Blasius, *De coll. canonum Isidori Mercatoris* (Naples, 1760); Wasserschleben, *Beiträge zur Geschichte der falschen Dekretalen* (Breslau, 1844); in the province of Reims: Weizsäcker, "Die pseudoisidorianische Frage," in the *Histor. Zeitschrift* of Sybel (1860); Hinschius, Preface, p. cviii.; A. Tardif, *Histoire des sources du droit canonique* (Paris, 1887); Schneider, *Die Lehre der Kirchenrechtsquellen* (Regensburg, 1892). An excellent résumé of the question; seems more favourable to Le Mans in the article of the *Kirchenlexicon* of Wetzer and Welte (2nd ed.); F. Lot, *Études sur le règne de Hugues Capet* (Paris, 1903); Lesne, *La Hiérarchie épiscopale en Gaule et Germanie* (Paris, 1905); for the province of Tours and Le Mans: B. Simson, *Die Entstehung der pseudoisidor. Fälschungen in Le Mans* (Leipzig, 1886). It is he who pointed out the connexion with the forgeries of Le Mans; especially Paul Fournier, "La Question des fausses décrétales," in the *Nouvelle Revue historique de droit français et étranger* (1887, 1888); in the *Congrès internat. des savants cathol.* t. ii.; "Étude sur les fausses décrétales," in *Revue d'histoire ecclésiastique de Louvain* (1906, 1907), to which the above article is greatly indebted. (A. Bo.)\*

**DECURIO**, a Roman official title, used in three connexions.

(1) A member of the senatorial order in the Italian towns under the administration of Rome, and later in provincial towns organized on the Italian model (see CURIA 4). The number of *decuriones* varied in different towns, but was usually 100. The qualifications for the office were fixed in each town by a special law for that community (*lex municipalis*). Cicero (*in Verr.* 2. 49, 120) alludes to an age limit (originally thirty years, until lowered by Augustus to twenty-five), to a property qualification (cf. Pliny, *Ep.* i. 19. 2), and to certain conditions of rank. The method of appointment varied in different towns and at different periods. In the early municipal constitution ex-magistrates passed automatically into the senate of their town; but at a later date this order was reversed, and membership of the senate became a qualification for the magistracy. Cicero (*l.c.*) speaks of the senate in the Sicilian towns as appointed by a vote of the township. But in most towns it was the duty of the chief magistrate to draw up a list (*album*) of the senators every five years. The *decuriones* held office for life. They were convened by the magistrate, who presided as in the Roman senate. Their powers were extensive. In all matters the magistrates were obliged to act according to their direction, and in some towns they heard cases of appeal against judicial sentences passed by the magistrate. By the time of the municipal law of Julius Caesar (45 B.C.) special privileges were conferred on the *decuriones*, including the right to appeal to Rome for trial in criminal cases. Under the principate their status underwent a marked decline. The office was no longer coveted, and documents of the 3rd and 4th centuries show that means were devised to compel members of the towns to undertake it. By the time of the jurists it had become hereditary and compulsory. This change was largely due to the heavy financial burdens which the Roman government laid on the municipal senates. (2) The president of a *decuria*, a subdivision of the *curia* (*q.v.*). (3) An officer in the Roman cavalry, commanding a troop of ten men (*decuria*).

**BIBLIOGRAPHY.**—C. G. Bruns, *Fontes juris Romani*, c. 3, No. 18, c. 4, Nos. 27, 29, 30 (*leges municipales*); J. C. Orelli, *Inscr. Latinae*, No. 3721 (*Album of Canusium*); Godefroy, *Paratit. ad cod. Theodosianam*, xii. 1 (vol. iv. pp. 352 et seq., ed. Ritter); J. Marquardt, *Römische Staatsverwaltung*, i. pp. 183 et seq. (Leipzig, 1881); P. Willems, *Droit public romain*, pp. 535 et seq. (Paris, 1884); Pauly-Wissowa, *Realencyclopädie*, IV. ii. pp. 2319 foll. (Stuttgart, 1901); W. Liebenam, *Städteverwaltung im römischen Kaiserreich* (Leipzig, 1900). (A. M. Cl.)

**DÉDÉAGATCH**, a seaport of European Turkey, in the vilayet of Adrianople, 10 m. N.W. of the Maritza estuary, on the Gulf of Enos, an inlet of the Aegean Sea. Pop. (1905) about 3000,

mostly Greeks. Until 1871 Dédéagatch was a mere cluster of fishermen's huts. A new town then began to spring up, settlers being attracted by the prospect of opening up a trade in the products of a vast forest of valonia oaks which grew near. In 1873 it was made the chief town of a *Kaza*, to which it gave its name, and a *Kaimakam* was appointed to it. In 1884 it was raised in administrative rank from a *Kaza* to a *Sanjak*, and the governor became a *Muessarif*. In 1889 the Greek archbishopric of Enos was transferred to Dédéagatch. On the opening, early in 1896, of the Constantinople-Salonica railway, which has a station here, a large proportion of the extensive transit trade which Enos, situated at the mouth of the Maritza, had acquired, was immediately diverted to Dédéagatch, and an era of unprecedented prosperity began; but when the railway connecting Burgas on the Black Sea with the interior was opened, in 1898, Dédéagatch lost all it had won from Enos. Owing to the lack of shelter in its open roadstead, the port has not become the great commercial centre which its position otherwise qualifies it to be. It is, however, one of the chief outlets for the grain trade of the Adrianople, Demotica and Xanthi districts. The valonia trade has also steadily developed, and is supplemented by the export of timber, tobacco and almonds. In 1871, while digging out the foundations of their houses, the settlers found many ancient tombs. Probably these are relics, not of the necropolis of the ancient *Zonè*, but of a monastic community of Dervishes, of the Dédé sect, which was established here in the 15th century, shortly after the Turkish conquest, and gave to the place its name.

**DEDHAM**, a township and the county seat of Norfolk county, Massachusetts, U.S.A., with an area of 23 sq. m. of comparatively level country. Pop. (1890) 7123; (1900) 7457, of whom 2186 were foreign-born; (1910 U.S. census) 9284. The township is traversed by the New York, New Haven & Hartford railway, and by interurban electric lines. It contains three villages, Dedham, East Dedham and Oakdale. Dedham has a public library (1854; incorporated 1871). The Dedham historical society was organized in 1859 and was incorporated in 1862. The Fairbanks house was erected in part as early as 1654. Carpets, handkerchiefs and woollen goods are manufactured, and a pottery here is reputed to make the only true crackleware outside the East. Dedham was "planted" in 1635 and was incorporated in 1636. It was one of the first two inland settlements of the colony, being coeval with Concord. The original plantation, about 20 m. long and 10 m. wide, extended from Roxbury and Dorchester to the present state line of Rhode Island: from this territory several townships were created, including Westwood (pop. in 1905, 1136), in 1897. A free public school, one of the first in America to be supported by direct taxation, was established in Dedham in 1645. In the Woodward tavern, the birthplace of Fisher Ames, a convention met in September 1774 and adjourned to Milton (q.v.), where it passed the Suffolk Resolves.

**DEDICATION** (Lat. *dedicatio*, from *dedicare*, to proclaim, to announce), properly the setting apart of anything by solemn proclamation. It is thus in Latin the term particularly applied to the consecration of altars, temples and other sacred buildings, and also to the inscription prefixed to a book, &c., and addressed to some particular person. This latter practice, which formerly had the purpose of gaining the patronage and support of the person so addressed, is now only a mark of affection or regard. In law, the word is used of the setting apart by a private owner of a road to public use. (See HIGHWAY.)

The Feast of Dedication (ἡμέρα τῆς ἐγκαίνια) was a Jewish festival observed for eight days from the 25th of Kislew (i.e. about December 12) in commemoration of the reconsecration (165 B.C.) of the temple and especially of the altar of burnt offering, after they had been desecrated in the persecution under Antiochus Epiphanes (168 B.C.). The distinguishing features of the festival were the illumination of houses and synagogues, a custom probably taken over from the feast of tabernacles, and the recitation of Psalm xxx. The biblical references are 1 Macc. i. 41-64, iv. 36-39; 2 Macc. vi. 1-11; John x. 22. See also 2 Macc. i. 9, 18; ii. 16; and Josephus,

*Antiq.* xii. v. 4. J. Wellhausen suggests that the feast was originally connected with the winter solstice, and only afterwards with the events narrated in Maccabees.

*Dedication of Churches.*—The custom of solemnly dedicating or consecrating buildings as churches or chapels set apart for Christian worship must be almost as old as Christianity itself. If we find no reference to it in the New Testament or in the very earliest apostolic or post-apostolic writings, it is merely due to the fact that Christian churches had not as yet begun to be built. Throughout the ante-Nicene period, until the reign of Constantine, Christian churches were few in number, and any public dedication of them would have been attended with danger in those days of heathen persecution. This is why we are ignorant as to what liturgical forms and what consecration ritual were employed in those primitive times. But when we come to the earlier part of the 4th century allusions to and descriptions of the consecration of churches become plentiful.

Like so much else in the worship and ritual of the Christian church this service is probably of Jewish origin. The hallowing of the tabernacle and of its furniture and ornaments (Exodus xl.); the dedication of Solomon's temple (1 Kings viii.) and of the second temple by Zerubbabel (Ezra vi.), and its rededication by Judas Maccabaeus (see above), and the dedication of the temple of Herod the Great (Josephus, *Antiq. of the Jews*, bk. xv. c. xi. § 6), and our Lord's recognition of the Feast of Dedication (St John xi. 22, 23)—all these point to the probability of the Christians deriving their custom from a Jewish origin, quite apart from the intrinsic appropriateness of such a custom in itself.

Eusebius (*Hist. Eccles.* lib. x. cap. 3) speaks of the dedication of churches rebuilt after the Diocletian persecution, including the church at Tyre in A.D. 314. The consecrations of the church of the Holy Sepulchre at Jerusalem in A.D. 335, which had been built by Constantine, and of other churches after his time, are described both by Eusebius and by other ecclesiastical historians. From them we gather that every consecration was accompanied by a celebration of the Holy Eucharist and a sermon, and special prayers of a dedicatory character, but there is no trace of the elaborate ritual, to be described presently, of the medieval pontificals dating from the 8th century onwards.

The separate consecration of altars is provided for by canon 14 of the council of Agde in 506, and by canon 26 of the council of Epaone in 517, the latter containing the first known reference to the usage of anointing the altar with chrism. The use of both holy water and of unction is attributed to St Columbanus, who died in 615 (Walafrid Strabo, *Vita S. Galli*, cap. 6).

There was an annual commemoration of the original dedication of the church, a feast with its octave extending over eight days, during which Gregory the Great encouraged the erection of booths and general feasting on the part of the populace, to compensate them for, and in some way to take the place of, abolished heathen festivities (Sozomen, *Hist. Eccles.* lib. ii. cap. 26; Bede, *Hist. Eccles.* lib. i. cap. 30).

At an early date the right to consecrate churches was reserved to bishops, as by canon 37 of the first council of Bracara in 563, and by the 23rd of the Irish collections of canons, once attributed to St Patrick, but hardly to be put earlier than the 8th century (Haddon and Stubbs, *Councils, &c.*, vol. ii. pt. 2, p. 329).

When we come to examine the MS. and printed service-books of the medieval church, we find a lengthy and elaborate service provided for the consecration of churches. It is contained in the pontifical. The earliest pontifical which has come down to us is that of Egbert, archbishop of York (732-766), which, however, only survives in a 10th-century MS. copy. Later pontificals are numerous; we cannot describe all their variations. A good idea, however, of the general character of the service will be obtained from a skeleton of it as performed in this country before the Reformation according to the use of Sarum. The service in question is taken from an early 15th-century pontifical in the Cambridge University Library as printed by W. Makell in *Monumenta ritualia ecclesiae Anglicanae*, 2nd ed., vol. i. pp. 195-239.



There is a preliminary office for laying a foundation-stone. On the day of consecration the bishop is to vest in a tent outside the church, thence to proceed to the door of the church on the outside, a single deacon being inside the church, and there to bless holy water, twelve lighted candles being placed outside, and twelve inside the church. He is then to sprinkle the walls all round outside, and to knock at the door; then to sprinkle the walls all round outside a second time and to knock at the door again; then to sprinkle the walls all round outside a third time, and a third time to knock at the door, by which he will then enter, all laity being excluded. The bishop is then to fix a cross in the centre of the church, after which the litany is said, including a special clause for the consecration of the church and altar. Next the bishop inscribes the alphabet in Greek letters on one of the limbs of St Andrew's cross from the left east corner to the right west corner on the pavement cindered for the purpose, and the alphabet in Latin on the other limb from the right east corner to the left west corner. Then he is to genuflect before the altar or cross. Then he blesses water, mingled with salt, ashes and wine, and sprinkles therewith all the walls of the church inside thrice, beginning at the altar; then he sprinkles the centre of the church longwise and crosswise on the pavement, and then goes round the outside of the church sprinkling it thrice. Next re-entering the church and taking up a central position he sprinkles holy water to the four points of the compass, and toward the roof. Next he anoints with chrism the twelve internal and twelve external wall-crosses, afterwards perambulating the church thrice inside and outside, censing it.

Then there follows the consecration of the altar. First, holy water is blessed and mixed with chrism, and with the mixture the bishop makes a cross in the middle of the altar, then on the right and the left, then on the four horns of the altar. Then the altar is sprinkled seven times or three times with water not mixed with chrism, and the altar-table is washed therewith and censed and wiped with a linen cloth. The centre of the altar is next anointed with the oil of the catechumens in the form of a cross; and the altar-stone is next anointed with chrism; and then the whole altar is rubbed over with oil of the catechumens and with chrism. Incense is next blessed, and the altar censed, five grains of incense being placed crosswise in the centre and at the four corners, and upon the grains five slender candle crosses, which are to be lit. Afterwards the altar is scraped and cleansed; then the altar-cloths and ornaments having been sprinkled with holy water are placed upon the altar, which is then to be censed.

All this is subsidiary to the celebration of mass, with which the whole service is concluded. The transcription and description of the various collects, psalms, anthems, benedictions, &c., which make up the order of dedication have been omitted for the sake of brevity.

The Sarum order of dedication described above is substantially identical with the Roman order, but it would be superfluous to tabulate and describe the lesser variations of language or ritual. There is, however, one very important and significant piece of ritual, not found in the above-described English church order, but always found in the Roman service, and not infrequently found in the earlier and later English uses, in connexion with the presence and use of relics at the consecration of an altar. According to the Roman ritual, after the priest has sprinkled the walls of the church inside thrice all round and then sprinkled the pavement from the altar to the porch, and sideways from wall to wall, and then to the four quarters of the compass, he prepares some cement at the altar. He then goes to the place where the relics are kept, and starts a solemn procession with the relics round the outside of the church. There a sermon is preached, and two decrees of the council of Trent are read, and the founder's deed of gift or endowment. Then the bishop, anointing the door with chrism, enters the church with the relics and deposits them in the cavity or confession in the altar. Having been enclosed they are censed and covered in, and the cover is anointed. Then follows the censing and wiping of the altar as in the Sarum order.

This use of relics is very ancient and can be traced back to the

time of St Ambrose. There was also a custom, now obsolete, of enclosing a portion of the consecrated Eucharist if relics were not obtainable. This was ordered by cap. 2 of the council of Celchyth (Chelsea) in 816. But though ancient the custom of enclosing relics was not universal, and where found in English church orders, as it frequently is found from the pontifical of Egbert onwards, it is called the "Mos Romanus" as distinguished from the "Mos Anglicanus" (*Archaeologia*, liv. 416). It is absent from the description of the early Irish form of consecration preserved in the *Leabhar Breac*, translated and annotated by Rev. T. Olden in the *Transactions of the St Paul's Ecclesiol. Soc.* vol. iv. pt. ii. p. 98.

The curious ritual act, technically known as the *abecedarium*, i.e. the tracing of the alphabet, sometimes in Latin characters, sometimes in Latin and Greek, sometimes, according to Menard, in Latin, Greek and Hebrew, along the limbs of St Andrew's cross on the floor of the church, can be traced back to the 8th century and may be earlier. Its origin and meaning are unknown. Of all explanations we like best the recent one suggested by Rossi and adopted by the bishop of Salisbury. This interprets the St Andrew's cross as the initial Greek letter of Christus, and the whole act as significant of taking possession of the site to be consecrated in the name of Christ, who is the Alpha and Omega, the word of God, combining in himself all letters that lie between them, every element of human speech. The three languages may then have been suggested by the Latin, Greek and Hebrew, in which his title was written on the cross.

The disentangling the Gallican from the Roman elements in the early Western forms of service is a delicate and difficult task, undertaken by Monsignor Louis Duchesne, who shows how the former partook of a funerary and the latter of a baptismal character (*Christian Worship* (London, 1904), cap. xii.).

The dedication service of the Greek Church is likewise long and elaborate. Relics are to be prepared and guarded on the day previous in some neighbouring sacred building. On the morning following, all ornaments and requisites having been got ready, the laity being excluded, the bishop and clergy vested proceed to fix in its place and consecrate the altar, a long prayer of dedication being said, followed by a litany. The altar is then sprinkled with warm water, then with wine, then anointed with chrism in the form of a cross. The altar, the book of the gospels, and all cloths are then censed, every pillar is crossed with chrism, while various collects are said and psalms recited. One lamp is then filled with oil and lit, and placed on the altar, while clergy bring in other lamps and other ornaments of the church. On the next day—if the service cannot be concluded in one day—the bishop and clergy go to the building where the relics have been kept and guarded. A procession is formed and advances thence with the relics, which are borne by a priest in a holy vessel (*discus*) on his head; the church having been entered, the relics are placed by him with much ceremonial in the "confession," the recess prepared in or about the altar for their reception, which is then anointed and sealed up. After this the liturgy is celebrated both on the feast of dedication and on seven days afterwards.

There is no authorized form for the dedication of a church in the reformed Church of England. A form was drawn up and approved by both houses of the convocation of Canterbury under Archbishop Tenison in 1712, and an almost identical form was submitted to convocation in 1715, but its consideration was not completed by the Lower House, and neither form ever received royal sanction. The consequence has been that Anglican bishops have fallen back on their undefined *jus liturgicum*, and have drawn up and promulgated forms for use in their various dioceses, some of them being content to borrow from other dioceses for this purpose. There is a general similarity, with a certain amount of difference in detail, in these various forms. In the diocese of London the bishop, attended by clergy and churchwardens, receives at the west door, outside, a petition for consecration; the procession then moves round the whole church outside, while certain psalms are chanted. On again reaching the west door the bishop knocks thrice for admission, and the door being opened the procession advances to the east end of the church.

He there lays the keys on the table "which is to be hallowed." The *Veni Creator* is then sung kneeling, followed by the litany with special suffrages. The bishop then proceeds to various parts of the church and blesses the font, the chancel, with special references to confirmation and holy matrimony, the lectern, the pulpit, the clergy stalls, the choir seats, the holy table. The deed of consecration is then read and signed, and the celebration of Holy Communion follows with special collects, epistle and gospel.

The Church of Ireland and the episcopal Church of Scotland are likewise without any completely authorized form of dedication, and their archbishops or bishops have at various times issued forms of service on their own authority. (F. E. W.)

**DE DONIS CONDITIONALIBUS**, a chapter of the statute of Westminster the Second (1285) which originated the law of entail. Strictly speaking, a form of entail was known before the Norman feudal law had been domesticated in England. The common form was a grant "to the feoffee and the heirs of his body," by which limitation it was sought to prevent alienation from the lineage of the first purchaser. These grants were also known as *feuda conditionata*, because if the donee had no heirs of his body the estate reverted to the donor. This right of reversion was evaded by the interpretation that such a gift was a conditional fee, which enabled the donee, if he had an heir of the body born alive, to alienate the land, and consequently disinherit the issue and defeat the right of the donor. To remedy this the statute *De Donis Conditionalibus* was passed, which enacted that, in grants to a man and the heirs of his body, the will of the donor according to the form in the deed of gift manifestly expressed, should be from thenceforth observed; so that they to whom the land was given under such condition, should have no power to alienate the land so given, but that it should remain unto the issue of those to whom it was given after their death, or unto the giver or his heirs, if issue fail. Since the passing of the statute an estate given to a man and the heirs of his body has been known as an estate tail, or an estate in fee tail (*feudum talliatum*), the word *tail* being derived from the French *tailleur*, to cut, the inheritance being by the statute cut down and confined to the heirs of the body. The operation of the statute soon produced innumerable evils: "children, it is said, grew disobedient when they knew they could not be set aside; farmers were deprived of their leases; creditors were defrauded of their debts; innumerable latent entails were produced to deprive purchasers of the land they had fairly bought; treasons also were encouraged, as estates tail were not liable to forfeiture longer than for the tenant's life" (Williams, *Real Property*). Accordingly, the power of alienation was reintroduced by the judges in Taltarum's case (*Year Book*, 12 Edward IV., 1472) by means of a fictitious suit or recovery which had originally been devised by the regular clergy for evading the statutes of mortmain. This was abolished by an act passed in 1833. (See FINE.)

**DEDUCTION** (from Lat. *deducere*, to take or lead from or out of, derive), a term used in common parlance for the process of taking away from, or subtracting (as in mathematics), and specially for the argumentative process of arriving at a conclusion from evidence, *i.e.* for any kind of inference.<sup>1</sup> In this sense it includes both arguments from particular facts and those from general laws to particular cases. In logic it is generally used in contradiction to "induction" for a kind of mediate inference, in which a conclusion (often itself called the deduction) is regarded as following necessarily under certain fixed laws from premises. This, the most common, form of deduction is the syllogism (*q.v.*; see also LOGIC), which consists in taking a general principle and deriving from it facts which are necessarily involved in it. This use of deduction is of comparatively modern origin; it was originally used as the equivalent of Aristotle's *ἀπαγωγή* (see *Prior Analytics*, B xxv.). The modern use of deduction is practically identical with the Aristotelian *συλλογισμός*.

<sup>1</sup> Two forms of the verb are used, "deduce" and "deduct"; originally synonymous, they are now distinguished, "deduce" being confined to arguments, "deduct" to quantities.

**DEE, JOHN** (1527-1608), English mathematician and astrologer, was born on the 13th of July 1527, in London, where his father was, according to Wood, a wealthy vintner. In 1542 he was sent to St John's College, Cambridge. After five years spent in mathematical and astronomical studies, he went to Holland, in order to visit several eminent continental mathematicians. Having remained abroad nearly a year, he returned to Cambridge, and was elected a fellow of Trinity College, then first erected by King Henry VIII. In 1548 he took the degree of master of arts; but in the same year he found it necessary to leave England on account of the suspicions entertained of his being a conjurer; these were first excited by a piece of machinery, which, in the *Pax* of Aristophanes, he exhibited to the university, representing the scarabaeus flying up to Jupiter, with a man and a basket of victuals on its back. He went first to the university of Louvain, where he resided about two years, and then to the college of Rheims, where he had extraordinary success in his public lectures on Euclid's *Elements*. On his return to England in 1551 King Edward assigned him a pension of 100 crowns, which he afterwards exchanged for the rectory of Upton-upon-Severn, Worcestershire. Soon after the accession of Mary he was accused of using enchantments against the queen's life; but after a tedious confinement he obtained his liberty in 1555, by an order of council.

When Elizabeth ascended the throne, Dee was asked by Lord Dudley to name a propitious day for the coronation. On this occasion he was introduced to the queen, who took lessons in the mystical interpretation of his writings, and made him great promises, which, however, were never fulfilled. In 1564 he again visited the continent, in order to present his *Monas hieroglyphica* to the emperor Maximilian, to whom he had dedicated it. He returned to England in the same year; but in 1571 he was in Lorraine, whither two physicians were sent by the queen to his relief in a dangerous illness. Returning to his home at Mortlake, in Surrey, he continued his studies, and made a collection of curious books and manuscripts, and a variety of instruments. In 1578 Dee was sent abroad to consult with German physicians and astrologers in regard to the illness of the queen. On his return to England, he was employed in investigating the title of the crown to the countries recently discovered by British subjects, and in furnishing geographical descriptions. Two large rolls containing the desired information, which he presented to the queen, are still preserved in the Cottonian Library. A learned treatise on the reformation of the calendar, written by him about the same time, is also preserved in the Ashmolean Library at Oxford.

From this period the philosophical researches of Dee were concerned entirely with necromancy. In 1581 he became acquainted with Edward Kelly, an apothecary, who had been convicted of forgery and had lost both ears in the pillory at Lancaster. He professed to have discovered the philosopher's stone, and by his assistance Dee performed various incantations, and maintained a frequent imaginary intercourse with spirits. Shortly afterwards Kelly and Dee were introduced by the earl of Leicester to a Polish nobleman, Albert Laski, palatine of Siradz, devoted to the same pursuits, who persuaded them to accompany him to his native country. They embarked for Holland in September 1583, and arrived at Laski's residence in February following. Upon Dee's departure the mob, believing him a wizard, broke into his house, and destroyed a quantity of furniture and books and his chemical apparatus. Dee and Kelly lived for some years in Poland and Bohemia in alternate wealth and poverty, according to the credulity or scepticism of those before whom they exhibited. They professed to raise spirits by incantation; and Kelly dictated the utterances to Dee, who wrote them down and interpreted them.

Dee at length quarrelled with his companion, and returned to England in 1589. He was helped over his financial difficulties by the queen and his friends. In May of 1595 he became warden of Manchester College. In November 1604 he returned to Mortlake, where he died in December 1608, at the age of eighty-one, in the greatest poverty. Aubrey describes him as "of a very fair,

clear sanguine complexion, with a long beard as white as milk—a very handsome man—tall and slender. He wore a gown like an artist's gown with hanging sleeves." Dee's *Speculum* or mirror, a piece of solid pink-tinted glass about the size of an orange, is preserved in the British Museum.

His principal works are—*Propaedeutica aphoristica* (London, 1558); *Monas hieroglyphica* (Antwerp, 1564); *Epistola ad Fredericum Commandinum* (Pesaro, 1570); *Preface Mathematical to the English Euclid* (1570); *Divers Annotations and Inventions added after the tenth book of English Euclid* (1570); *Epistola praefixa Ephemeridibus Joannis Feldi, a. 1557*; *Parallaticae commentationis praxeosque nucleus quidam* (London, 1573). The catalogue of his printed and published works is to be found in his *Compendious Rehearsal*, as well as in his letter to Archbishop Whitgift. A manuscript of Dee's, relating what passed for many years between him and some spirits, was edited by Meric Casaubon and published in 1659. *The Private Diary of Dr John Dee, and the Catalogue of his Library of Manuscripts*, edited by J. O. Halliwell, was published by the Camden Society in 1842. There is a life of Dee in Thomas Smith's *Vitae illustrium virorum* (1707); English translation by W. A. Ayton, the *Life of John Dee* (1909).

**DEE** (Welsh, *Dyfrdwy*; Lat., and in Milton, *Deva*), a river of Wales and England. It rises in Bala Lake, Merionethshire, which is fed by a number of small streams. Leaving the lake near the town of Bala it follows a north-easterly course to Corwen, turns thence E. by S. past Llangollen to a point near Overton, and then bends nearly north to Chester, and thereafter north-west through a great estuary opening into the Irish Sea. In the Llangollen district the Dee crosses Denbighshire, and thereafter forms the boundary of that county with Shropshire, a detached part of Flint, and Cheshire. From Bala nearly down to Overton, a distance of 35 m., during which the river falls about 330 ft., its course lies through a narrow and beautiful valley, enclosed on the south by the steep lower slopes of the Berwyn Mountains and on the north by a succession of lesser ranges. The portion known as the Vale of Llangollen is especially famous. Here an aqueduct carrying the Pontcysyllte branch of the Shropshire Union canal bestrides the valley; it is a remarkable engineering work completed by Thomas Telford in 1805. The Dee has a total length of about 70 m. and a fall of 530 ft. Below Overton it debouches upon its plain track. Below Chester it follows a straight artificial channel to the estuary, and this is the only navigable portion. The estuary, which is 14 m. long, and 5½ m. wide at its mouth, between Hilbre Point on the English and Point of Air on the Welsh side, is not a commercial highway like the neighbouring mouth of the Mersey, for though in appearance a fine natural harbour at high tide, it becomes at low tide a vast expanse of sand, through which the river meanders in a narrow channel. The navigation, however, is capable of improvement, and schemes have been set on foot to this end. The tide rushes in with great speed over the sands, and their danger is illustrated in the well-known ballad "The Sands of Dee" by Charles Kingsley. The Dee drains an area of 813 sq. m.

**DEE**, a river in the south of Aberdeenshire, Scotland, pursuing a generally easterly direction from its source in the extreme west of the county till it reaches the North Sea at the city of Aberdeen. It rises in the Wells of Dee, a spring on Ben Braeriach, one of the Cairngorms, at a height of 4061 ft. above the sea. It descends rapidly from this altitude, and by the time that it receives the Geusachan, on its right bank, about 6 m. from its source, it has fallen 2421 ft. From the mountains flanking its upper reaches it is fed by numerous burns named and unnamed. With its tributaries the river drains an area of 1000 sq. m. Rapid and turbulent during the first half of its course of 90 m., it broadens appreciably below Aboyne and the rate of flow is diminished. The channel towards its mouth was artificially altered in order to provide increased dock accommodation at Aberdeen, but, above, the stream is navigable for only barges and small craft for a few miles. It runs through scenery of transcendent beauty, especially in Braemar. About two miles above Inverey it enters a narrow rocky gorge, 300 yds. long and only a few feet wide at one part, and forms the rapids and cascades of the famous Linn of Dee. One of the finest of Scottish salmon streams, it retains its purity almost to the very end of its run. The principal

places on the Dee, apart from private residences, are Castleton of Braemar, Ballater, Aboyne, Kincardine O'Neil, Banchory, Culter and Cults.

**DEED** (in O. Eng. *deadd*, from the stem of the verb "to do"), that which is done, an act, doing; particularly, in law, a contract in writing, sealed and delivered by the party bound to the party intended to benefit. Contracts or obligations under seal are called in English law *specialties*, and down to 1869 they took precedence in payment over *simple* contracts, whether written or not. Writing, sealing and delivery are all essential to a deed. The signature of the party charged is not material, and the deed is not void for want of a date. Delivery, it is held, may be complete without the actual handing over of the deed; it is sufficient if the act of sealing were accompanied by words or acts signifying that the deed was intended to be presently binding; and delivery to a third person for the use of the party benefited will be sufficient. On the other hand, the deed may be handed over to a third person as an *escrow*,<sup>1</sup> in which case it will not take effect as a deed until certain conditions are performed. Such conditional delivery may be inferred from the circumstances attending the transaction, although the conditions be not expressed in words. A deed indented, or indenture (so called because written in counterparts on the same sheet of parchment, separated by cutting a wavy line between them so as to be identified by fitting the parts together), is between two or more parties who contract mutually. The actual indentation is not now necessary to an indenture. The *deed-poll* (with a polled or smooth-cut edge, not indented) is a deed in which one party binds himself without reference to any corresponding obligations undertaken by another party. See **CONTRACT**.

**DEEMS, CHARLES (ALEXANDER) FORCE** (1820–1893), American clergyman, was born in Baltimore, Maryland, on the 4th of December 1820. He was a precocious child and delivered lectures on temperance and on Sunday schools before he was fourteen years old. He graduated at Dickinson College in 1839, taught and preached in New York city for a few months, in 1840 took charge of the Methodist Episcopal church at Asbury, New Jersey, and removed in the next year to North Carolina, where he was general agent for the American Bible Society. He was professor of logic and rhetoric at the University of North Carolina in 1842–1847, and professor of natural sciences at Randolph-Macon College (then at Boydton, Virginia) in 1847–1848, and after two years of preaching at Newbern, N. C., he held for four years (1850–1854) the presidency of Greensboro (N. C.) Female College. He continued as a Methodist Episcopal clergyman at various pastorates in North Carolina from 1854 to 1865, for the last seven years being a presiding elder and in 1859 to 1863 being the proprietor of St Austin's Institute, Wilson. In 1865 he settled in New York City, where in 1866 he began preaching in the chapel of New York University, and in 1868 he established and became the pastor of the undenominational Church of the Strangers, which in 1870 occupied the former Mercer Street Presbyterian church, purchased and given to Dr Deems by Cornelius Vanderbilt; there he remained until his death in New York city on the 18th of November 1893. He was one of the founders (1881) and president of the American Institute of Christian Philosophy and for ten years was editor of its organ, *Christian Thought*. Dr Deems was an earnest temperance advocate, as early as 1852 worked (unsuccessfully) for a general prohibition law in North Carolina, and in his later years allied himself with the Prohibition party. He was influential in securing from Cornelius Vanderbilt the endowment of Vanderbilt University, in Nashville, Tennessee. He was a man of rare personal and literary charm; he edited *The Southern Methodist Episcopal Pulpit* (1846–1852) and *The Annals of Southern Methodism* (1855–1857); he compiled *Devotional Melodies* (1842), and, with the assistance of Phoebe Cary, one of his parishioners, *Hymns for all Christians* (1869; revised, 1881); and he published many books, among which were: *The Life of Dr Adam Clarke* (1840);

<sup>1</sup> An Anglo-French law term meaning a "scroll" or strip of parchment, cognate with the English "shred." The modern French *écrou* is used for the entry of a name on a prison register.

*The Triumph of Peace and other Poems* (1840); *The Home Altar* (1850); *Jesus* (1872), which ran through many editions and several revisions, the title being changed in 1880 to *The Light of the Nations*; *Sermons* (1885); *The Gospel of Common Sense* (1888); *The Gospel of Spiritual Insight* (1891) and *My Septuagint* (1892). The Charles F. Deems Lectureship in Philosophy was founded in his honour in 1895 at New York University by the American Institute of Christian Philosophy.

His *Autobiography* (New York, 1897) is autobiographical only to 1847, the memoir being completed by his two sons.

**DEER** (O. E. *dēor*, *dīor*, a common Teutonic word, meaning a wild animal, cf. Ger. *Tier*, Du. *dier*, &c., probably from a root *dhus-*, to breathe), originally the name of one of two British species, the red-deer or the fallow-deer, but now extended to all the members of the family *Cervidae*, in the section *Pecora* of the suborder *Artiodactyla* of the order *Ungulata*. (See *PECORA*; *ARTIODACTYLA* and *UNGULATA*.) Briefly, deer may be defined as *Pecora* presenting the following characteristics:—either antlers present in the male, or when these are absent, the upper canines large and sabre-like, and the lateral metacarpal bones represented only by their lower extremities. This definition will include the living and also most of the extinct forms, although in some of the latter the lateral metacarpal bones not only retain their lower ends, but are complete in their entire length.

The leading characters of antlers are described under *PECORA*, but these structures may be defined somewhat more fully in the following passage from the present writer's *Deer of all Lands*:—

"Antlers are supported on a pair of solid bony processes, or pedicles, arising from the frontal bones of the skull, of which they form an inseparable portion; and if in a fully adult deer these pedicles be sawn through, they will generally be found to consist of solid, ivory-like bone, devoid of perceptible channels for the passage of blood-vessels. The pedicles are always covered with skin well supplied with blood-vessels; and in young deer, or those in which the antlers have been comparatively recently shed, the covering of skin extends over their summits, when they appear as longer or shorter projections on the forehead, according to the species. When the first or a new antler is about to be formed, the summits of these pedicles become tender, and bear small velvet-like knobs, which have a high temperature, and are supplied by an extra quantity of blood, which commences to deposit bony matter. This deposition of bony matter progresses very rapidly, and although in young deer and the adults of some species the resulting antler merely forms a simple spike, or a single fork, in full-grown individuals of the majority it assumes a more or less complexly branched structure. All this time the growing antler is invested with a skin clothed with exceedingly fine short hairs, and is most liberally supplied with blood-vessels; this sensitive skin being called the velvet. Towards the completion of its growth a more or less prominent ring of bone, termed the burr or coronet, is deposited at its base just above the junction with the pedicle; this ring tending to constrict the blood-vessels, and thus cut off the supply of blood from the antlers.

"When the antlers are freed from the velvet—a process usually assisted by the animal rubbing them against tree stems or boughs—they have a more or less rugose surface, owing to the grooves formed in them by the nutrient blood-vessels. Although a few living species have the antlers in the form of simple spikes in the adult male, in the great majority of species they are more or less branched; while in some, like the elk and fallow-deer, they expand into broad palmated plates, with tines, or snags, on one or both margins. In the antlers of the red-deer group, which form the type of the whole series, the following names have been applied to their different component parts and branches. The main shaft is termed the beam; the first or lowest tine the brow-tine; the second the bez-tine; the third the trez-tine, or royal; and the branched portion forming the summit the crown, or surroyals. But the antlers of all deer by no means conform to this type; and in certain groups other names have to be adopted for the branches.

"The antlers of young deer are in the form of simple spikes; and this form is retained in the South American brockets, although the simple antlers of these deer appear due to degeneration, and are not primitive types. Indeed, no living deer shows such primitive spike-like antlers in the adult, and it is doubtful whether such a type is displayed by any known extinct form, although many have a simple fork. In the deer of the sambar group, where the antlers never advance beyond a three-tined type, the shedding is frequently, if not invariably, very irregular; but in the majority at least of the species with complex antlers the replacement is annual, the new appendages attaining their full development immediately before the pairing-season. In such species there is a more or less regular annual increase in the complexity of the antlers up to a certain period of life, after which they begin to degenerate."

The *Cervidae* are distributed all over Europe, Asia, Northern Africa and America, but are unknown in Africa south of the Sahara. They are undoubtedly a group of European or Asiatic origin, and obtained an entrance into America at a time when that continent was connected with Asia by way of Bering Strait.

The existing members of the family are classified in the writer's *Deer of all Lands* as follows:—

A. Subfamily *CERVINAE*.—Antlers, with one exception, present only by their lower extremities; liver without a gall-bladder; a face-gland, and a gland-pit in the skull.

I. Reindeer, Genus *Rangifer*.—Lateral metacarpal bones represented only by their lower extremities; antlers present in both sexes, complex. Northern part of both hemispheres.

II. Elk, Genus *Alces*.—Lateral metacarpals as in preceding; antlers (as in the following genera) present only in the male, arising at right angles to the median longitudinal line of the skull, and extending at first in the plane of the forehead, after which, when in their fullest development, they expand into a broad palmation margined with snags. Northern portion of both hemispheres.

III. True Deer, Genus *Cervus*.—Lateral metacarpals represented only by their upper ends. Antlers arising at acute angles to the median line of the skull (as in the following genera), at first projecting from the plane of the forehead, and then continued upwards nearly in that plane, supported on short pedicles, and furnished with a brow-tine, never regularly forked at first division, but generally of large size, and with not less than three tines; the skull without ridges on the frontals forming the bases of the pedicles of the antlers. Upper canine teeth small, or wanting. Europe, Asia and N. America.

1. Red-deer Group, Subgenus *Cervus*.—Antlers rounded, usually with five or more tines, generally including a bez (second), and always a trez (third); coat of adult generally unspotted, with a large light-coloured disk surrounding the tail; young, spotted. Europe, Northern and Central Asia and North America.

2. Sika Deer, Subgenus *Pseudaxis*.—Antlers smaller and simpler, four-tined, with a trez (third), but no bez (second); coat of adult spotted, at least in summer, with a white area bordered by black in the region of the tail, which is also black and white. North-Eastern Asia.

3. Fallow-deer, Subgenus *Dama*.—Antlers without a bez, but with a trez-tine, above which the beam is more or less palmated, and generally furnished with numerous snags; coat of adult spotted in summer, uniform in winter, with black and white markings in the region of the tail similar to those of *Pseudaxis*; young, spotted. Mediterranean region, but more widely spread in Europe during the Pleistocene epoch, and also introduced into many European countries.

4. Sambar Group, Subgenus *Rusa*.—Antlers rounded, three-tined, with the bez- and trez-tines wanting, and the beam simply forked at the summit; coat either uniform or spotted at all seasons. Indo-Malay countries and part of China.

5. Barasingha Group, Subgenus *Rucervus*.—Antlers flattened or rounded, without bez- or trez-tine, the beam dichotomously forking, and one or both branches again forked, so that the number of tines is at least four; brow-tine forming a right angle or a continuous curve with the beam; coat of adult generally more or less uniform, of young spotted. Indo-Malay countries.

IV. Muntjacs, Genus *Cervulus*.—Lateral metacarpals as in *Cervus*; antlers small, with a brow-tine and an unbranched beam, supported on long bony pedicles, continued downwards as convergent ridges on the forehead; upper canines of male large and tusk-like. Indo-Malay countries and China.

V. Tufted Muntjacs, Genus *Elaphodus*.—Nearly related to the last, but the antlers still smaller, with shorter pedicles and divergent frontal ridges; upper canines of male not everted at the tips. Tibet and China.

VI. Water-deer, Genus *Hydrelaphus*.—Lateral metacarpals as in *Rangifer*; antlers wanting; upper canines of males tusk-like and growing from semi-persistent pulps; cheek-teeth tall-crowned (hypodont); tail moderate. China.

VII. Roe-deer, Genus *Capreolus*.—Lateral metacarpals as in *Rangifer*; antlers rather small, without a brow-tine or sub-basal snag, dichotomously forked, with the upper or posterior prong again forking; tail rudimentary; vomer not dividing posterior nasal aperture of skull. Europe and Northern Asia.

VIII. Père David's Deer, Genus *Elaphurus*.—Lateral metacarpals as in *Cervus*; antlers large, without a brow-tine or sub-basal snag, dichotomously forked, with the upper prong of the fork curving forwards and dividing, and the lower prong long, simple, and projected backwards, the beam making a very marked angle with the plane of the face; tail very long; vomer as in *Capreolus*. North-East Asia.

IX. American Deer, Genus *Mazama*.—Lateral metacarpals as in *Rangifer*; antlers very variable in size, forming a marked angle with the plane of the face, without a brow-tine; when consisting of more than a simple prong, dichotomously forked, frequently with a sub-basal snag, and always with the lower prong of the fork projected from the front edge of the beam, in some cases the lower, in others

the upper, and in others both prongs again dividing; tail long; tarsal gland generally present; metatarsal gland very variable, both as regards presence and position; vomer dividing the inner aperture of the nostrils in the skull into two distinct chambers. America.

1. White-tailed Group, Subgenus *Dorcelaphus* or *Odocoileus*.—Antlers large and complex, with a sub-basal snag, and the lower prong more or less developed at the expense of the upper one; metatarsal gland usually present; tail long or moderate, and hairy below; face very long and narrow; the face-gland small, and the gland-pit in the skull of moderate extent; no upper canines; size generally large. North America to Northern South America.

2. Marsh-deer Group, Subgenus *Blastoceros*.—Antlers large and complex, without a sub-basal snag, and the upper prong more developed than the lower one; metatarsal gland absent; tail short; face moderately long; face-gland and gland-pit well developed; upper canines usually present in male. Size large or rather small. South America.

3. Guemals, Subgenus *Xenelaphus*.—Antlers small and simple, forming a single dichotomous fork; metatarsal gland absent; tail short; face moderately long; face-gland and gland-pit well developed; upper canines present in both sexes. Size medium. South America.

4. Brockets, Subgenus *Mazama*.—Antlers in the form of simple unbranched spikes; metatarsal, and in one case also the tarsal gland absent; tail very short; face elongated; face-gland small and gland-pit deep and triangular; hair of face radiating from two whorls; upper canines sometimes present in old males. Size small. Central and South America.

X. Genus *Pudua*.—Skull and metacarpals generally as in *Mazama*; size very small; hair coarse and brittle; antlers in the form of short, simple spikes; cannon-bones very short; tail very short or wanting; no whorls in the hair of the face; face-gland moderately large, and gland-pit deep and oval; tarsal and metatarsal glands wanting; ectocuneiform bone of tarsus united with the naviculoboid. South America.

B. Subfamily MOSCHINAE.—Antlers wanting in both sexes; liver furnished with a gall-bladder; no face-gland or gland-pit.

XI. Musk-deer, Genus *Moschus*.—Hair coarse and brittle; upper canines of male very long; no tarsal or metatarsal glands or tufts; lateral metacarpals represented by their lower extremities; lateral hoofs very large; tail very short; naked portion of muzzle extensive; male with a large abdominal gland. Central Asia.

Of the above, Reindeer and Elk are dealt with in separate articles (*qq.v.*).

The first or typical group of the genus *Cervus* includes the red-deer (*Cervus elaphus*) of Europe and western Asia, of which there are several local races, such as the large *C. elaphus maral* of eastern Europe and Persia, which is often partially spotted above and dark-coloured below, the smaller *C. e. barbarus* of Tunisia and Morocco, and the still smaller *C. e. corsicanus* of Corsica. The Scandinavian red-deer is the typical form of the species. In all red-deer the antlers are rounded, and show a more or less marked tendency to form a cup at the summit. Wapiti, on the other hand, show a marked tendency to the flattening of the antlers, with a great development of the fourth tine, which is larger than all the others, and the whole of the tines above this in the same plane, or nearly so, this plane being the same as the long axis of the animal. Normally no cup is developed at the summit of the antler. The tail, too, is shorter than in the red-deer; while in winter the under parts become very dark, and the upper surface often bleaches almost white. The cry of the stags in the breeding season is also different. The typical representative of the group is the North American wapiti *C. canadensis*, but there are several closely allied races in Central Asia, such as *C. canadensis songaricus* and *C. c. bactrianus*, while in Manchuria the subgroup is represented by *C. c. xanthopygus*, in which the summer coat is reddish instead of grey. The hangul (*C. cashmirianus*) of Kashmir is a distinct dark-coloured species, in which the antlers tend to turn in at the summit; while *C. yarcandensis*, of the Tarim Valley, Turkestan, is a redder animal, with a wholly rufous tail, and antlers usually terminating in a simple fork placed in a transverse plane. Another Asiatic species is the great shou (*C. affinis*) of the Chumbi Valley, in which the antlers curve forwards in a remarkable manner. Lastly *C. albirostris*, of Tibet, is easily recognized by its white muzzle, and smooth, whitish, flattened antlers, which have fewer tines than those of the other members of the group, all placed in one plane.

The second group of the genus *Cervus*, forming the subgenus *Pseudaxis*, is typified by the handsome little Japanese deer, or sika, *C. (P.) sika*, in which the antlers are four-tined, and covered

with red "velvet" when first grown, while the coat is fully spotted in summer, but more or less uniformly brown in winter. The most distinctive feature of the deer of this group is, however, the patch of long erectile white hairs on the buttocks, which, although inconspicuous when the animals are quiescent, is expanded into a large chrysanthemum-like bunch when they start to run or are otherwise excited. The patch then forms a guiding signal for the members of the herd when in flight. On the mainland of Manchuria both the typical sika, and a larger race (*C. sika manchuricus*), occur. A still larger and finer animal is the Pekin sika (*C. hortulorum*), of northern Manchuria, which is as large as a small red-deer; it is represented in the Yang-tse valley by a local race, *C. h. kopschi*. Formosa possesses a species of its own (*C. taiwanus*), which, in correlation with the perpetual verdure of that island, is spotted at all seasons.

For the fallow-deer, *Cervus [Dama] dama*, see FALLOW-DEER.

The rusine or sambar group of *Cervus*, of which the characteristics are given above, comprises a considerable number of long-tailed species with three-tined antlers from the Indo-Malay countries and some parts of China. The largest and handsomest is the sambar of India (*Cervus [Rusa] unicolor*), characterized by its massive and rugged antlers. It is represented by a number of local races, mostly of smaller size, such as the Burmese and Malay *C. u. equinus*, the Formosan *C. u. swinhoei*, and the Philippine *C. u. philippinus* and *C. u. nigricans*, of which the latter is not larger than a roe-buck, while the sambar itself is as large as a red-deer. Whether these local phases of a single variable type are best denominated races or species, must be largely a matter of individual opinion. The rusa, or Javan sambar, *C. (R.) hippelaphus*, is a lighter-coloured and smaller deer than the Indian sambar, with longer, slenderer and less rugged antlers. Typically from Java, this deer is also represented in the Moluccas and Timor, and has thus the most easterly range of the whole tribe. A black coat with white spots distinguishes the Philippine spotted deer, *C. alfredi*, which is about the size of a roe-buck; while other members of this group are the Calamianes deer of the Philippines (*C. culionensis*), the Bavian deer (*C. kuhli*) from a small island near Java, and the well-known Indian hog-deer or para (*C. porcinus*), all these three last being small, more or less uniformly coloured, and closely allied species. On the other hand, the larger and handsomer chital, or spotted deer (*C. axis*), stands apart by its white-spotted fawn-red coat and differently formed antlers.

Nearly allied to the preceding is the barasingha or rucervine group (subgenus *Rucervus*), in which the antlers are of a different and generally more complex character. The typical species is the Indian barasingha or swamp-deer, *Cervus (Rucervus) duvauceli*, a uniformly red animal, widely distributed in the forest districts of India. In Siam it is replaced by *C. (R.) schomburgki*, in which the antlers are of a still more complex type. Finally, we have the thamin, or Eld's deer, *C. (R.) eldi*, ranging from Burma to Siam, and characterized by the continuous curve formed by the beam and the brow-tine of the antlers.

For the small eastern deer, respectively known as muntjacs (*Cervulus*) and tufted muntjacs or tufted deer (*Elaphodus*), see MUNTJAC; while under WATER-DEER will be found a notice of the Chinese representative of the genus *Hydrelaphus* (or *Hydropotes*). The roe-deer, or roe-buck (*Capreolus*), likewise form the subject of a separate article (see ROE-BUCK), as is also the case with Père David's deer, the sole representative of the genus *Elaphurus*.

The American deer include such New World species as are generically distinct from Old World types. All these differ from the members of the genus *Cervus* in having no brow-tine to the antlers, which, in common with those of the roe-deer, belong to what is called the forked type. Including all these deer except one in the genus *Mazama* (of which the typical representatives are the South American brockets), the North American species constitute the subgenus *Dorcelaphus* (also known as *Cariacus* and *Odocoileus*). One of the best known of these is the white-tailed deer *Mazama (Dorcelaphus) americana*, often known as the Virginian deer. It is typically an animal of the size of a fallow-deer,



reddish in summer and greyish in winter, with a long tail, which is coloured like the back above but white below, and is carried elevated when the animal is running, so as to form with the white of the inner sides of the huttocks a conspicuous "hlaze." A white fetlock-gland with a black centre is also distinctive of this species. The antlers are large and curve forwards, giving off an upright snag near the base, and several vertical tines from the upper surface of the horizontal portion. As we proceed southwards from the northern United States, deer of the white-tailed type decrease steadily in size, till in Central America, Peru and Guiana they are represented by animals not larger than a roe-buck. The most convenient plan appears to be to regard all these degenerate forms as local races of the white-tail, although here again there is room for difference of opinion, and many naturalists prefer to call them species. The large ears, brown-and-white face, short, black-tipped tail, and antlers without large basal snag serve to distinguish the mule-deer *M. (D.) hemionus*, of western North America; while the black tail, *M. (D.) columbiana*, ranging from British Columbia to California, is a smaller animal, recognizable by the larger and longer tail, which is black above and white below.

South America is the home of the marsh-deer or guazu, *M. (Blastoceros) dichotoma*, representing a subgenus in which the complex antlers lack a basal snag, while the hair of the back is reversed. This species is about the size of a red-deer, with a foxy red coat with black legs. The pampas-deer, *M. (B.) bezoartica*, of the Argentine pampas is a much smaller animal, of paler colour, with three-tined antlers. The Chilean and Peruvian Andes and Patagonia are the homes of two peculiar deer locally known as guemals (huemals), and constituting the subgenus *Xenelaphus*, or *Hippocamelus*. They are about the size of fallow-deer, and have simply forked antlers. The Chilean species is *M. (B.) bisulca* and the Peruvian *M. (B.) antisiensis*. Brockets, of which there are numerous species, such as *M. rufa* and *M. nemorivaga*, are Central and South American deer of the size of roe-hucks or smaller, with simple spike-like antlers, tufted heads and the hair of the face radiating from two whorls on the forehead so that on the nose the direction is downwards. The smallest of all deer is the Chilean pudu (*Pudu pudu*), a creature not much larger than a hare, with almost rudimentary antlers.

The musk-deer forms the subject of a separate article.

For deer in general, see R. Lydekker, *The Deer of all Lands* (London, 1898, 1908). (R. L. \*)

**DEERFIELD**, a township of Franklin county, Massachusetts, U.S.A., on the Connecticut and Deerfield rivers, about 33 m. N. of Springfield. Pop. (1900) 1969; (1910 U.S. census) 2209. Deerfield is served by the Boston & Maine and the New York, New Haven & Hartford railways. The natural beauty and the historic interest of Deerfield attract many visitors. There are several villages and hamlets in the township, the oldest and most interesting of which is that known as "The Street" or "Old Street." This extends along one wide thoroughfare over a hill and across a plateau or valley that is hemmed in on the E. by a range of highlands known as East Mountain and on the W. by the foothills of Hoosac Mountain. Many of the houses in this village are very old. In Memorial Hall, a building erected in 1797-1798 for the Deerfield academy, the Pocumtuck Valley memorial association (incorporated in 1870) has gathered an interesting collection of colonial and Indian relics. Deerfield was one of the first places in the United States to enter into the modern "arts and crafts movement"; in 1896 many of the old household industries were revived and placed upon a business basis. Most of the work is done by women in the homes. The products, including needlework and embroidery, textiles, rag rugs, netting, wrought iron, furniture, and metal-work in gold and silver embellished with precious and semi-precious stones, are annually exhibited in an old-fashioned house built in 1710, and a large portion of them are sold to tourists. There is an arts and crafts society, but the profits from the sales go entirely to the workers.

The territory which originally constituted the township of Deerfield (known as Pocumtuck until 1764) was a tract of 8000 acres granted in 1654 to the town of Dedham in lieu of 2000 acres

previously taken from that town and granted to Rev. John Eliot to further his mission among the Natick Indians. The rights of the Pocumtuck Indians to the Deerfield tract were purchased at about fourpence per acre, settlement was begun upon it in 1669, and the township was incorporated in 1673. For many years Deerfield was the N.W. frontier settlement of New England. It was slightly fortified at the beginning of King Philip's War, and after an attack by the Indians on the 1st of September 1675 it was garrisoned by a small force under Captain Samuel Appleton. A second attack was made on the 12th of September, and six days later, as Captain Thomas Lothrop and his company were guarding teams that were hauling wheat from Deerfield to the English headquarters at Hadley, they were surprised by Indians in ambush at what has since been known as Bloody Brook (in the village of South Deerfield), and Lothrop and more than sixty of his men were slain. From this time until the end of the war Deerfield was abandoned. In the spring of 1677 a few of the old settlers returned, but on the 19th of September some were killed and the others were captured by a party of Indians from Canada. Resettlement was undertaken again in 1682. On the 15th of September 1694 Deerfield narrowly escaped capture by a force of French and Indians from Canada. In the early morning of the 29th of February 1703-1704, Deerfield was surprised by a force of French and Indians (under Hertel de Rouville), who murdered 49 men, women and children, captured 111, burned the town, and on the way back to Canada murdered 20 of the captured. Among the captives was the Rev. John Williams (1664-1729), the first minister of Deerfield, who (with the other captives) was redeemed in 1706 and continued as pastor here until his death; in 1707 he published an account of his experiences as a prisoner, *The Redeemed Captive Returning to Zion*, which has frequently been reprinted. From the original township of Deerfield the territory of the following townships has been taken: Greenfield (1753 and 1896), Conway (1767, 1791 and 1811), Shelburne (1768) and a part of Whately (1810).

See George Sheldon, *A History of Deerfield* (Deerfield, 1895); the *History and Proceedings of the Pocumtuck Valley Memorial Association* (Deerfield, 1890 et seq.); and Pauline C. Bouvé, "The Deerfield Renaissance," in *The New England Magazine* for October 1905.

**DEER PARK**, an enclosure of rough wooded pastureland for the accommodation of red- or fallow-deer. The distinction between a deer "park" and a deer "forest" is that the former is always enclosed either by a wall or fence, and is relatively small, whereas the forest covers a much larger area, and is not only open but sometimes contains practically no trees at all. Originally, the possession of a deer park in England was a royal prerogative, and no subject could enclose one without a direct grant from the crown—a licence to impark, like a licence to embattle a house, was always necessary. When Domesday Book was compiled, there were already thirty-one deer parks in England, some of which may have existed in Saxon times; about one-fourth of them belonged to the king. After the Conquest they increased rapidly in number, but from about the middle of the 11th century this tendency was reversed. In the middle of the 16th century it was conjectured that one-twentieth of England and Wales was given up to deer and rabbits. Upon Saxton's maps, which were made between 1575 and 1580, over 700 parks are marked, and it is not improbable that the number was understated. Mr Evelyn Philip Shirley enumerated only 334 in his book on *English Deer Parks* published in 1867. To these Mr Joseph Whitaker, in *A Descriptive List of the Deer Parks of England* (1892), has added another fifty, and the total is believed to be now about 400. It is a curious circumstance that despite the rather minute detail of Domesday none of the parks there enumerated can now be identified. There is, however, a plausible case for Eridge Park in Sussex as the Reredfelle of Domesday. The state and consequence of the great barons of the middle ages depended in some measure upon the number of deer parks which they possessed. Most bishops and abbots had one or two, and at one time more than twenty were attached to the archbishopric of Canterbury. When the power of the barons was finally broken and a more settled period began with the accession of the house

of Tudor, the deer park began to fall into decay. By Queen Elizabeth's time a considerable proportion of the ancestral acres of the great houses had passed into the possession of rich merchants and wealthy wool-staplers, and it had become more profitable to breed bullocks than to find pasture for deer, and even where the new men retained, and even in some cases created, deer parks, they reduced their area in order that more land might be available for grazing or for corn. Thus began that decadence of the deer park which has continued down to the present time. More than anything, however, the strife between Charles I. and parliament contributed to reduce both the number and size of English parks containing deer. By the Restoration the majority of the parks in England had for the time being been destroyed, the palings pulled down, the trees felled, and the deer stolen. Of the duke of Newcastle's eight parks seven were ruined, that at Welbeck alone remaining intact. Not a tree was left in Clipston Park, although the timber had been valued at £20,000. One of the results of the Restoration was to empty the parks of the Roundhead squires to replenish those of the Royalists, but this measure helped little, and great numbers of deer had to be brought from Germany to replenish the depleted stocks. A gentleman of the Isle of Ely was indeed given a baronetcy in return for a large present of deer which he made to Charles II. The largest existing deer park in England is that at Savernake (4000 acres), next comes Windsor, which contains about 2600 acres in addition to the 1450 acres of Windsor Forest. Lord Egerton of Tatton's park at Tatton in Cheshire, and Lord Abergavenny's at Eridge, each contain about 2500 acres. Other parks which are much about the same size are those of Blenheim, Richmond, Eastwell, Duncombe, Grimsthorpe, Thoresby and Knowsley. All these parks are famous either for their size, their beauty, or the number and long descent of the deer which inhabit them. The size of English parks devoted to deer varies from that of these historic examples down to a very few acres. A small proportion of the older enclosures contains red- as well as fallow-deer. In some of the larger ones many hundreds of head browse, whereas those of the smallest size may have only a dozen or two. Although many enclosures were disparked in very recent times, the 19th century saw the making of a considerable number of new ones, usually of small dimensions. The tendency, however, is still towards diminution both in number and extent, cattle taking the place of deer.

**DEFAMATION** (from the classical Lat. *diffamare*, to spread abroad an evil report—the English form in *de* is taken from the Late Lat. *defamare*), the saying or writing something of another, calculated to injure his reputation or expose him to public hatred, contempt and ridicule. (See LIBEL AND SLANDER.)

**DEFAULT** (Fr. *défaut*, from *défaillir*, to fail, Lat. *fallere*), in English law, a failure to do some act required by law either as a regular step in procedure or as being a duty imposed. Parties in an action may be in default as to procedure by failure to appear to the writ, or to take some other step, within the prescribed time. In such cases the opposing party gains some advantage by being allowed to sign judgment or otherwise. But as a rule, unless the party is much in default and is under a peremptory order to proceed, the penalty for default is by order to pay the costs occasioned. When there is default in complying with the terms of a judgment the remedy is by executing it by one of the processes admitted by the law. (See EXECUTION.) In the case of judgments in criminal or quasi-criminal cases, where a fine is imposed, it is in most cases legal and usual to order imprisonment if the fine is not paid or if the property of the defendant is insufficient to realize its amount. Default in compliance with a statute renders the defaulter liable to action by the person aggrieved or to indictment if the matter of command is of public concern, subject in either case to the qualification that the statute may limit the remedy for the default to some particular proceeding specifically indicated; and in some instances, e.g. in the case of local authorities, default in the execution of their public duties is dealt with administratively by a department of the government, and only in the last resort, if at all, by recourse to judicial tribunals.

**DEFEASANCE**, or DEFEAZANCE (Fr. *défaire*, to undo), in law, an instrument which defeats the force or operation of some other deed or estate; as distinguished from *condition*, that which in the same deed is called a condition is a defeasance in another deed. A defeasance should recite the deed to be defeated and its date, and it must be made between the same parties as are interested in the deed to which it is collateral. It must be of a thing defeasible, and all the conditions must be strictly carried out before the defeasance can be consummated. Defeasance in a bill of sale is the putting an end to the security by realizing the goods for the benefit of the mortgagee. It is not strictly a defeasance, because the stipulation is in the same deed; it is really a condition in the nature of a defeasance.

**DEFENCE** (Lat. *defendere*, to defend), in general, a keeping off or defending, a justification, protection or guard. Physical defence of self is the right of every man, even to the employment of force, in warding off an attack. A person attacked may use such force as he believes to be necessary for the warding off an attack, even to the extent of killing an assailant. The same right of reciprocal defence extends not only to defence of one's own person, but also to the defence of a husband or wife, parent or child, master or servant. (See ASSAULT; HOMICIDE.) As a legal term in English pleading, "defence" means the denial by the party proceeded against of the validity of a charge, or the steps taken by an accused person or his legal advisers for defending himself. In civil actions, a statement of defence is the second step in proceedings, being the answer of the defendant to the plaintiff's statement of claim. In the statement of defence must be set out every material fact upon which the defendant intends to rely at the trial. Every fact alleged in the statement of claim must be dealt with, and either admitted or denied; further facts may be pleaded in answer to those admitted; the whole pleading of the plaintiff may be objected to as insufficient in law, or a set-off or counter-claim may be advanced. A statement of defence must be delivered within ten days from the delivery of the statement of claim, or appearance if no statement of claim be delivered.

By the Poor Prisoners' Defence Act 1903, where it appears, having regard to the nature of the defence set up by any poor prisoner, as disclosed in the evidence given or statement made by him before the committing justices, that it is desirable in the interests of justice that he should have legal aid in the preparation and conduct of his defence, and that his means are insufficient to enable him to obtain such aid, it may be ordered either (1) on committal for trial by the committing justices, or (2) after reading the depositions by the judge or quarter sessions chairman. The defence includes the services of solicitor and counsel and the expenses of witnesses, the cost being payable in the same manner as the expenses of a prosecution for felony. Briefly, the object of the act is, not to give a prisoner legal assistance to find out if he has got a defence, but in order that a prisoner who has a defence may have every inducement to tell the truth about it at the earliest opportunity. Legal assistance under the act is only given where both (1) the nature of the defence as disclosed is such that in the interests of justice the prisoner should have legal aid to make his defence clear, and (2) where also his means are insufficient for that end (Lord Alverstone, C.J., at Warwick Summer Assizes, *The Times*, July 26, 1904).

**DEFENDANT**, in law, a person against whom proceedings are instituted or directed; one who is called upon to answer in any suit. At one time the term "defendant" had a narrower meaning, that of a person sued in a personal action only, the corresponding term in a real action being "tenant," but the distinction is now practically disregarded, except in a few states of the United States.

**DEFENDER OF THE FAITH** (*Fidei Defensor*), a title belonging to the sovereign of England in the same way as *Christianissimus* belonged to the king of France, and *Catholicus* belongs to the ruler of Spain. It seems to have been suggested in 1516, and although certain charters have been appealed to in proof of an earlier use of the title, it was first conferred by Pope Leo X. on Henry VIII. The Bull granting the title is dated the 11th of October 1521,

and was a reward for the king's treatise, *Assertio, septem sacramentorum*, against Luther. When Henry broke with the papacy, Pope Paul III. deprived him of this designation, but in 1544 the title of "Defender of the Faith" was confirmed to Henry by parliament, and has since been used by all his successors on the English throne.

**DEFERENT** (Lat. *deferens*, bearing down), in ancient astronomy, the mean orbit of a planet, which carried the epicycle in which the planet revolved. It is now known to correspond to the actual orbit of the planet round the sun.

**DEFFAND, MARIE ANNE DE VICHY-CHAMROND, MARQUISE DU** (1697-1780), a celebrated Frenchwoman, was born at the chateau of Chamrond near Charolles (department of Saône-et-Loire) of a noble family in 1697. Educated at a convent in Paris, she showed, along with great intelligence, a sceptical and cynical turn of mind. The abbess, alarmed at the freedom of her views, arranged that Massillon should visit and reason with her, but he accomplished nothing. Her parents married her at twenty-one years of age to her kinsman, Jean Baptiste de la Lande, marquis du Deffand, without consulting her inclination. The union proved an unhappy one, and resulted in a separation as early as 1722. Madame du Deffand, young and beautiful, is said by Horace Walpole to have been for a short time the mistress of the regent, the duke of Orleans (Walpole to Gray, January 25, 1766). She appeared in her earlier days to be incapable of any strong attachment, but her intelligence, her cynicism and her *esprit* made her the centre of attraction of a brilliant circle. In 1721 began her friendship with Voltaire, but their regular correspondence dates only from 1736. She spent much time at Sceaux, at the court of the duchesse du Maine, where she contracted a close friendship with the president Hénault. In Paris she was in a sense the rival of Madame Geoffrin, but the members of her salon were drawn from aristocratic society more than from literary cliques. There were, however, exceptions. Voltaire, Montesquieu, Fontenelle and Madame de Staal-Delaunay were among the habitués. When Hénault introduced D'Alembert, Madame du Deffand was at once captivated by him. With the encyclopaedists she was never in sympathy, and appears to have tolerated them only for his sake. In 1752 she retired from Paris, intending to spend the rest of her days in the country, but she was persuaded by her friends to return. She had taken up her abode in 1747 in apartments in the convent of St Joseph in the rue St Dominique, which had a separate entrance from the street. When she lost her sight in 1754 she engaged Mademoiselle de Lespinasse to help her in entertaining. This lady's wit made some of the guests, D'Alembert among others, prefer her society to that of Madame du Deffand, and she arranged to receive her friends for an hour before the appearance of her patron. When this state of things was discovered Mademoiselle de Lespinasse was dismissed (1764), but the salon was broken up, for she took with her D'Alembert, Turgot and the literary clique generally. From this time Madame du Deffand very rarely received any literary men. The principal friendships of her later years were with the duchesse de Choiseul and with Horace Walpole. Her affection for the latter, which dated from 1765, was the strongest and most durable of all her attachments. Under the stress of this tardy passion she developed qualities of style and eloquence of which her earlier writings had given little promise. In the opinion of Sainte-Beuve the prose of her letters ranks with that of Voltaire as the best of that classical epoch without excepting any even of the great writers. Walpole refused at first to acknowledge the closeness of their intimacy from an exaggerated fear of the ridicule attaching to her age, but he paid several visits to Paris expressly for the purpose of enjoying her society, and maintained a close and most interesting correspondence with her for fifteen years. She died on the 23rd of September 1780, leaving her dog Tonton to the care of Walpole, who was also entrusted with her papers. Of her innumerable witty sayings the best known is her remark on the cardinal de Polignac's account of St Denis's miraculous walk of two miles with his head in his hands,—*Il n'y a que le premier pas qui coûte.*

The *Correspondance inédite* of Madame du Deffand with D'Alembert, Hénault, Montesquieu, and others was published in Paris (2 vols.) in 1809. *Letters of the marquise du Deffand to the Hon. Horace Walpole, afterwards earl of Orford, from the year 1766 to the year 1780* (4 vols.), edited, with a biographical sketch, by Miss Mary Berry, were published in London from the originals at Strawberry Hill in 1810.

The standard edition of her letters is the *Correspondance complète de la marquise du Deffand . . .* by M. de Lescure (1865); the *Correspondance inédite* with M. and Mme de Choiseul and others was edited in 1859 and again in 1866 by the marquis de Ste-Aulaire. Other papers of Madame du Deffand obtained at the breaking up of Walpole's collection are in private hands. Madame du Deffand returned many of Walpole's letters at his request, and subsequently destroyed those which she received from him. Those in his possession appear to have been destroyed after his death by Miss Berry, who printed fragments from them as footnotes to the edition of 1810. The correspondence between Walpole and Madame du Deffand thus remains one-sided, but seven of Walpole's letters to her are printed for the first time in the edition (1903) of his correspondence by Mrs Paget Toynbee, who discovered a quantity of her unedited letters. See Sainte-Beuve, *Causeries du lundi*, vols. i. and xiv.; and the notice by M. de Lescure in his edition of the correspondence.

**DEFIANCE**, a city and the county seat of Defiance county, Ohio, U.S.A., at the confluence of the Auglaize and Tiffin rivers with the Maumee, about 50 m. S.W. of Toledo. Pop. (1890) 7694; (1900) 7579 (960 foreign-born); (1910) 7327. It is served by the Baltimore & Ohio and the Wabash railways, and by the Ohio Electric railway to Lima (42 m.). The city commands a fine view of the rivers and the surrounding country, which is well adapted to agriculture; and has large machine shops and several flour mills, besides manufactories of agricultural implements, waggons, sashes and blinds, and wood-working machinery for the manufacture of artillery wheels. Here, too, is Defiance College, an institution of the Christian Denomination, opened in 1885. Defiance was long the site of an Indian village. In 1794 General Anthony Wayne built a fort here and named it Defiance. In 1822 Defiance was laid out as a town; in 1845 it was made the county seat of the newly erected county; and in 1881 it became a city of the second class.

**DEFILE**, a military expression for a passage, to march through which troops are compelled to "defile," or narrow their front (from the Fr. *défiler*, to march in a line, or by "files"). The word is usually applied to a ravine or gorge in a range of hills, but a causeway over a river, a bridge and even a village may equally be called a defile. The term is also used to express, without any special reference to military operations, a gorge in mountains. The verb "to defile" is used of troops marching on a narrow front, or narrowing their front, under all circumstances, and in this sense is the contrary of "deploy."

"Defile," in the sense of "pollute," is another form of "defoul"; though spelt alike, the two words are pronounced differently, the accent being on the first syllable for the former, and on the second for the latter.

**DEFINITION** (Lat. *definitio*, from *de-finire*, to set limits to, describe), a logical term used popularly for the process of explaining, or giving the meaning of, a word, and also in the concrete for the proposition or statement in which that explanation is expressed. In logic, definition consists in determining the qualities which belong to given concepts or universals; it is not concerned with individuals, which are marked by an infinity of peculiarities, any one or all of which might be predicated of another individual. Individuals can be defined only in so far as they belong to a single kind. According to Aristotle, definition is the statement of the essence of a concept (*ὁρισμὸς μὲν γὰρ τοῦ τί ἐστὶ καὶ οὐσίας*, *Posterior Analytics*, B iii. 90 b 30); that is, it consists of the genus and the differentia. In other words, "man" is defined as "animal plus rationality," or "rational animal,"<sup>1</sup> i.e. the concept is (1) referred to the next higher genus, and (2) distinguished from other modes in which that genus exists, i.e. from other species. It is sometimes argued that, there being no definition of individuals as such, definition is of names (see J. S. Mill, *Logic*, i. viii. 5), not of things; it is generally, however, maintained that definition is of things, regarded as, or

<sup>1</sup> "Rational animal" is thus the predicate of the statement constituting the definition. Sometimes the word "definition" is used to signify merely the predicate.

in so far as they are, of a kind. Definition of words can be nothing more than the explanation of terms such as is given in a dictionary.

The following rules are generally given as governing accurate definition. (1) *The definition must be equivalent or commensurate with that which is defined*; it must be applicable to all the individuals included in the concept and to nothing else. Every man, and nothing else, is a rational animal. "Man is mortal" is not a definition, for mortality is predicable of irrational animals. (2) *The definition must state the essential attributes*; a concept cannot be defined by its accidental attributes; those attributes must be given which are essential and primary. (3) *The definition must be per genus et differentiam* (or *differentias*), as we have already seen. These are the important rules. Three minor rules are: (4) *The definition must not contain the name of the concept to be defined*; if it does, no information is given. Such a proposition as "an archdeacon is one who performs archidiaconal functions" is not a definition. Concepts cannot be defined by their correlatives. Such a definition is known as a *circulus in definiendo*. (5) *Obscure and figurative language must be avoided*, and (6) *Definitions must not be in the negative when they can be in the affirmative*.

**DEFOE, DANIEL** (c. 1659-1731), English author, was born in the parish of St Giles, Cripplegate, London, in the latter part of 1659 or early in 1660, of a nonconformist family. His grandfather, Daniel Foe, lived at Etton, Northamptonshire, apparently in comfortable circumstances, for he is said to have kept a pack of hounds. As to the variation of name, Defoe or Foe, its owner signed either indifferently till late in life, and where his initials occur they are sometimes D. F. and sometimes D. D. F. Three autograph letters of his are extant, all addressed in 1705 to the same person, and signed respectively D. Foe, de Foe and Daniel Defoe. His father, James Foe, was a butcher and a citizen of London.

Daniel was well educated at a famous dissenting academy, Mr Charles Morton's of Stoke Newington, where many of the best-known nonconformists of the time were his schoolfellows. With few exceptions all the known events of Defoe's life are connected with authorship. In the older catalogues of his works two pamphlets, *Speculum Crapegownorum*, a satire on the clergy, and *A Treatise against the Turks*, are attributed to him before the accession of James II., but there seems to be no publication of his which is certainly genuine before *The Character of Dr Annesley* (1697). He had, however, before this, taken up arms in Monmouth's expedition, and is supposed to have owed his lucky escape from the clutches of the king's troops and the law, to his being a Londoner, and therefore a stranger in the west country. On the 26th of January 1688 he was admitted a liveryman of the city of London, having claimed his freedom by birth. Before his western escapade he had taken up the business of hosiery factor. At the entry of William and Mary into London he is said to have served as a volunteer trooper "gallantly mounted and richly accoutred." In these days he lived at Tooting, and was instrumental in forming a dissenting congregation there. His business operations at this period appear to have been extensive and various. He seems to have been a sort of commission merchant, especially in Spanish and Portuguese goods, and at some time to have visited Spain on business. In 1692 he failed for £17,000. His misfortunes made him write both feelingly and forcibly on the bankruptcy laws; and although his creditors accepted a composition, he afterwards honourably paid them in full, a fact attested by independent and not very friendly witnesses. Subsequently, he undertook first the secretaryship and then the management and chief ownership of some tile-works at Tilbury, but here also he was unfortunate, and his imprisonment in 1703 brought the works to a standstill, and he lost £3,000. From this time forward we hear of no settled business in which he engaged.

The course of Defoe's life was determined about the middle of the reign of William III. by his introduction to that monarch and other influential persons. He frequently boasts of his personal intimacy with the "glorious and immortal" king, and

in 1695 he was appointed accountant to the commissioners of the glass duty, an office which he held for four years. During this time he produced his *Essay on Projects* (1698), containing suggestions on banks, road-management, friendly and insurance societies of various kinds, idiot asylums, bankruptcy, academies, military colleges, high schools for women, &c. It displays Defoe's lively and lucid style in full vigour, and abounds with ingenious thoughts and apt illustrations, though it illustrates also the unsystematic character of his mind. In the same year Defoe wrote the first of a long series of pamphlets on the then burning question of occasional conformity. In this, for the first time, he showed the unlucky independence which, in so many other instances, united all parties against him. While he pointed out to the dissenters the scandalous inconsistency of their playing fast and loose with sacred things, yet he denounced the impropriety of requiring tests at all. In support of the government he published, in 1698, *An Argument for a Standing Army*, followed in 1700 by a defence of William's war policy called *The Two Great Questions considered*, and a set of pamphlets on the Partition Treaty. Thus in political matters he had the same fate as in ecclesiastical; for the Whigs were no more prepared than the Tories to support William through thick and thin. He also dealt with the questions of stock-jobbing and of electioneering corruption. But his most remarkable publication at this time was *The True-Born Englishman* (1701), a satire in rough but extremely vigorous verse on the national objection to William as a foreigner, and on the claim of purity of blood for a nation which Defoe chooses to represent as crossed and dashed with all the strains and races in Europe. He also took a prominent part in the proceedings which followed the Kentish petition, and was the author, some say the presenter, of the *Legion Memorial*, which asserted in the strongest terms the supremacy of the electors over the elected, and of which even an irate House of Commons did not dare to take much notice. The theory of the indefeasible supremacy of the freeholders of England, whose delegates merely, according to this theory, the Commons were, was one of Defoe's favourite political tenets, and he returned to it in a powerfully written tract entitled *The Original Power of the Collective Body of the People of England examined and asserted* (1701).

At the same time he was occupied in a controversy on the conformity question with John How (or Howe) on the practice of "occasional conformity." Defoe maintained that the dissenters who attended the services of the English Church on particular occasions to qualify themselves for office were guilty of inconsistency. At the same time he did not argue for the complete abolition of the tests, but desired that they should be so framed as to make it possible for most Protestants conscientiously to subscribe to them. Here again his moderation pleased neither party.

The death of William was a great misfortune to Defoe, and he soon felt the power of his adversaries. After publishing *The Mock Mourners*, intended to satirize and rebuke the outbreak of Jacobite joy at the king's death, he turned his attention once more to ecclesiastical subjects, and, in an evil hour for himself, wrote the anonymous *Shortest Way with the Dissenters* (1702), a statement in the most forcible terms of the extreme "high-flying" position, which some high churchmen were unwary enough to endorse, without any suspicion of the writer's ironical intention. The author was soon discovered; and, as he absconded, an advertisement was issued offering a reward for his apprehension, and giving the only personal description we possess of him, as "a middle-sized spare man about forty years old, of a brown complexion and dark brown-coloured hair, but wears a wig; a hooked nose, a sharp chin, grey eyes, and a large mole near his mouth." In this conjuncture Defoe had really no friends, for the dissenters were as much alarmed at his book as the high-flyers were irritated. He surrendered, and his defence appears to have been injudiciously conducted; at any rate he was fined 200 marks, and condemned to be pilloried three times, to be imprisoned indefinitely, and to find sureties for his good behaviour during seven years. It was in reference to this incident that Pope, whose Catholic rearing made him detest

the abettor of the Revolution and the champion of William of Orange, wrote in the *Dunciad*—

"Earless on high stands unabash'd Defoe"

—though he knew that the sentence to the pillory had long ceased to entail the loss of ears. Defoe's exposure in the pillory (July 29, 30, 31) was, however, rather a triumph than a punishment, for the populace took his side; and his *Hymn to the Pillory*, which he soon after published, is one of the best of his poetical works. Unluckily for him his condemnation had the indirect effect of destroying his business at Tilbury.

He remained in prison until August 1704, and then owed his release to the intercession of Robert Harley, who represented his case to the queen, and obtained for him not only liberty but pecuniary relief and employment, which, of one kind or another, lasted until the termination of Anne's reign. Defoe was uniformly grateful to the minister, and his language respecting him is in curious variance with that generally used. There is no doubt that Harley, who understood the influence wielded by Defoe, made some conditions. Defoe says he received no pension, but his subsequent fidelity was at all events indirectly rewarded; moreover, Harley's moderation in a time of the extremest party-insanity was no little recommendation to Defoe. During his imprisonment he was by no means idle. A spurious edition of his works having been issued, he himself produced a collection of twenty-two treatises, to which some time afterwards he added a second group of eighteen more. He also wrote in prison many short pamphlets, chiefly controversial, published a curious work on the famous storm of the 26th of November 1703, and started in February 1704 perhaps the most remarkable of all his projects, *The Review*. This was a paper which was issued during the greater part of its life three times a week. It was entirely written by Defoe, and extends to eight complete volumes and some few score numbers of a second issue. He did not confine himself to news, but wrote something very like finished essays on questions of policy, trade and domestic concerns; he also introduced a "Scandal Club," in which minor questions of manners and morals were treated in a way which undoubtedly suggested the *Tallers* and *Spectators* which followed. Only one complete copy of the work is known to exist, and that is in the British Museum. It is probable that if bulk, rapidity of production, variety of matter, originality of design, and excellence of style be taken together, hardly any author can show a work of equal magnitude. After his release Defoe went to Bury St Edmunds, though he did not interrupt either his *Review* or his occasional pamphlets. One of these, *Giving Alms no Charity, and Employing the Poor a Grievance to the Nation* (1704), is extraordinarily far-sighted. It denounces both indiscriminate alms-giving and the national work-shops proposed by Sir Humphrey Mackworth.

In 1705 appeared *The Consolidator, or Memoirs of Sundry Transactions from the World in the Moon*, a political satire which is supposed to have given some hints for Swift's *Gulliver's Travels*; and at the end of the year Defoe performed a secret mission, the first of several of the kind, for Harley. In 1706 appeared the *True Relation of the Apparition of one Mrs Veal*, long supposed to have been written for a bookseller to help off an unsaleable translation of Drelincourt, *On Death*, but considerable doubt has been cast upon this by William Lee. Defoe's next work was *Jure divino*, a long poetical argument in (bad) verse; and soon afterwards (1706) he began to be much employed in promoting the union with Scotland. Not only did he write pamphlets as usual on the project, and vigorously recommend it in *The Review*, but in October 1706 he was sent on a political mission to Scotland by Sidney Godolphin, to whom Harley had recommended him. He resided in Edinburgh for nearly sixteen months, and his services to the government were repaid by a regular salary. He seems to have devoted himself to commercial and literary as well as to political matters, and prepared at this time his elaborate *History of the Union*, which appeared in 1709. In this year Henry Sacheverell delivered his famous sermons, and Defoe wrote several tracts about them and attacked the preacher in his *Review*.

In 1710 Harley returned to power, and Defoe was placed in a somewhat awkward position. To Harley himself he was bound by gratitude and by a substantial agreement in principle, but with the rest of the Tory ministry he had no sympathy. He seems, in fact, to have agreed with the foreign policy of the Tories and with the home policy of the Whigs, and naturally incurred the reproach of time-serving and the hearty abuse of both parties. At the end of 1710 he again visited Scotland. In the negotiations concerning the Peace of Utrecht, Defoe strongly supported the ministerial side, to the intense wrath of the Whigs, displayed in an attempted prosecution against some pamphlets of his on the all-important question of the succession. Again the influence of Harley saved him. He continued, however, to take the side of the dissenters in the questions affecting religious liberty, which played such a prominent part towards the close of Anne's reign. He naturally shared Harley's downfall; and, though the loss of his salary might seem a poor reward for his constant support of the Hanoverian claim, it was little more than his ambiguous, not to say trimming, position must have led him to expect.

Defoe declared that Lord Annesley was preparing the army in Ireland to join a Jacobite rebellion, and was indicted for libel; and prior to his trial (1715) he published an apologia entitled *An Appeal to Honour and Justice*, in which he defended his political conduct. Having been convicted of the libel he was liberated later in the year under circumstances that only became clear in 1864, when six letters were discovered in the Record Office from Defoe to a Government official, Charles Delafaye, which, according to William Lee, established the fact that in 1718 at least Defoe was doing not only political work, but that it was of a somewhat equivocal kind—that he was, in fact, sub-editing the Jacobite *Mist's Journal*, under a secret agreement with the government that he should tone down the sentiments and omit objectionable items. He had, in fact, been released on condition of becoming a government agent. He seems to have performed the same not very honourable office in the case of two other journals—*Dormer's Letter* and the *Mercurius Politicus*; and to have written in these and other papers until nearly the end of his life. Before these letters were discovered it was supposed that Defoe's political work had ended in 1715.

Up to that time Defoe had written nothing but occasional literature, and, except the *History of the Union* and *Jure Divino*, nothing of any great length. In 1715 appeared the first volume of *The Family Instructor*, which was very popular during the 18th century. The first volume of his most famous work, the immortal story—partly adventure, partly moralizing—of *The Life and Strange Surprising Adventures of Robinson Crusoe*, was published on the 25th of April 1719. It ran through four editions in as many months, and then in August appeared the second volume. Twelve months afterwards the sequel *Serious Reflections*, now hardly ever reprinted, appeared. Its connexion with the two former parts is little more than nominal, Crusoe being simply made the mouth-piece of Defoe's sentiments on various points of morals and religion. Meanwhile the first two parts were reprinted as a *feuilleton* in *Heathcote's Intelligencer*, perhaps the earliest instance of the appearance of such a work in such a form. The story was founded on Dempier's *Voyage round the World* (1697), and still more on Alexander Selkirk's adventures, as communicated by Selkirk himself at a meeting with Defoe at the house of Mrs Damaris Daniel at Bristol. Selkirk afterwards told Mrs Daniel that he had handed over his papers to Defoe. *Robinson Crusoe* was immediately popular, and a wild story was set afloat of its having been written by Lord Oxford in the Tower. A curious idea, at one time revived by Henry Kingsley, is that the adventures of Robinson are allegorical and relate to Defoe's own life. This idea was certainly entertained to some extent at the time, and derives some colour of justification from words of Defoe's, but there seems to be no serious foundation for it. *Robinson Crusoe* (especially the story part, with the philosophical and religious moralizings largely cut out) is one of the world's classics in fiction. Crusoe's shipwreck and adventures, his finding the footprint in the sand, his man "Friday,"—the whole atmosphere of romance which surrounds the position of



the civilized man fending for himself on a desert island—these have made Defoe's great work an imperishable part of English literature. Contemporaneously appeared *The Dumb Philosopher*, or *Dickory Cronke*, who gains the power of speech at the end of his life and uses it to predict the course of European affairs.

In 1720 came *The Life and Adventures of Mr Duncan Campbell*. This was not entirely a work of imagination, its hero, the fortune-teller, being a real person. There are amusing passages in the story, but it is too desultory to rank with Defoe's best. In the same year appeared two wholly or partially fictitious histories, each of which might have made a reputation for any man. The first was the *Memoirs of a Cavalier*, which Lord Chatham believed to be true history, and which William Lee considers the embodiment at least of authentic private memoirs. The Cavalier was declared at the time to be Andrew Newport, made Lord Newport in 1642. His elder brother was born in 1620 and the Cavalier gives 1608 as the date of his birth, so that the facts do not fit the dates. It is probable that Defoe, with his extensive acquaintance with English history, and his astonishing power of working up details, was fully equal to the task of inventing it. (As a model of historical work of a certain kind it is hardly surpassable, and many separate passages—accounts of battles and skirmishes—have never been equalled except by Carlyle.) *Captain Singleton*, the last work of the year, has been unjustly depreciated by most of the commentators. The record of the journey across Africa, with its surprising anticipations of subsequent discoveries, yields in interest to no work of the kind known to us; and the semi-piratical Quaker who accompanies Singleton in his buccaneering expeditions is a most life-like character. There is also a Quaker who plays a very creditable part in *Roxana* (1724), and Defoe seems to have been well affected to the Friends. In estimating this wonderful productiveness on the part of a man sixty years old, it should be remembered that it was a habit of Defoe's to keep his work in manuscript sometimes for long periods.

In 1721 nothing of importance was produced, but in the next twelvemonth three capital works appeared. These were *The Fortunes and Misfortunes of Moll Flanders*, *The Journal of the Plague Year*, and *The History of Colonel Jack*. *Moll Flanders* and *The Fortunate Mistress* (*Roxana*), which followed in 1724, have subjects of a rather more than questionable character, but both display the remarkable art with which Defoe handles such subjects. It is not true, as is sometimes said, that the difference between the two is that between gross and polished vice. The real difference is much more one of morals than of manners. *Moll* is by no means of the lowest class. Notwithstanding the greater degradation into which she falls, and her originally dependent position, she has been well educated, and has consorted with persons of gentle birth. She displays throughout much greater real refinement of feeling than the more high-flying *Roxana*, and is at any rate flesh and blood, if the flesh be somewhat frail and the blood somewhat hot. Neither of the heroines has any but the rudiments of a moral sense; but *Roxana*, both in her original transgression and in her subsequent conduct, is actuated merely by avarice and selfishness—vices which are peculiarly offensive in connexion with her other failing, and which make her thoroughly repulsive. The art of both stories is great, and that of the episode of the daughter Susannah in *Roxana* is consummate; but the transitions of the later plot are less natural than those in *Moll Flanders*. It is only fair to notice that while the latter, according to Defoe's more usual practice, is allowed to repent and end happily, *Roxana* is brought to complete misery; Defoe's morality, therefore, required more repulsiveness in one case than in the other.

In the *Journal of the Plague Year*, more usually called, from the title of the second edition, *A History of the Plague*, the accuracy and apparent veracity of the details is so great that many persons have taken it for an authentic record, while others have contended for the existence of such a record as its basis. But here too the genius of Mrs Veal's creator must, in the absence of all evidence to the contrary, be allowed sufficient for the task. *The History of Colonel Jack* is an unequal book. There is hardly in *Robinson Crusoe* a scene equal, and there is consequently not

in English literature a scene superior, to that where the youthful pickpocket first exercises his trade, and then for a time loses his ill-gotten gains. But a great part of the book, especially the latter portion, is dull; and in fact it may be generally remarked of Defoe that the conclusions of his tales are not equal to the beginning, perhaps from the restless indefatigability with which he undertook one work almost before finishing another.

To this period belong his stories of famous criminals, of Jack Sheppard (1724), of Jonathan Wild (1725), of the Highland Rogue i.e. Rob Roy (1723). The pamphlet on the first of these Defoe maintained to be a transcript of a paper which he persuaded Sheppard to give to a friend at his execution.

In 1724 appeared also the first volume of *A Tour through the whole Island of Great Britain*, which was completed in the two following years. Much of the information in this was derived from personal experience, for Defoe claims to have made many more tours and visits about England than those of which we have record; but the major part must necessarily have been dexterous compilation. In 1725 appeared *A New Voyage round the World*, apparently entirely due to the author's own fertile imagination and extensive reading. It is full of his peculiar verisimilitude and has all the interest of Anson's or Dampier's voyages, with a charm of style superior even to that of the latter.

In 1726 Defoe published a curious and amusing little pamphlet entitled *Everybody's Business is Nobody's Business, or Private Abuses Public Grievances, exemplified in the Pride, Insolence, and Exorbitant Wages of our Women-Servants, Footmen, &c.* This subject was a favourite one with him, and in the pamphlet he showed the immaturity of his political views by advocating legislative interference in these matters. Towards the end of this same year *The Complete English Tradesman*, which may be supposed to sum up the experience of his business life, appeared, and its second volume followed two years afterwards. This book has been variously judged. It is generally and traditionally praised, but those who have read it will be more disposed to agree with Charles Lamb, who considers it "of a vile and debasing tendency," and thinks it "almost impossible to suppose the author in earnest." The intolerable meanness advocated for the sake of the paltriest gains, the entire ignoring of any pursuit in life except money-getting, and the representation of the whole duty of man as consisting first in the attainment of a competent fortune, and next, when that fortune has been attained, in spending not more than half of it, are certainly repulsive enough. But there are no reasons for thinking the performance ironical or insincere, and it cannot be doubted that Defoe would have been honestly unable even to understand Lamb's indignation. To 1726 also belongs *The Political History of the Devil*. This is a curious book, partly explanatory of Defoe's ideas on morality, and partly belonging to a series of demonological works which he wrote, and of which the chief others are *A System of Magic* (1726), and *An Essay on the History of Apparitions* (1728), issued the year before under another title. In all these works his treatment is on the whole rational and sensible; but in *The History of the Devil* he is somewhat hampered by an insufficiently worked-out theory as to the nature and personal existence of his hero, and the manner in which he handles the subject is an odd and not altogether satisfactory mixture of irony and earnestness. *A Plan of English Commerce*, containing very enlightened views on export trade, appeared in 1728.

During the years from 1715 to 1728 Defoe had issued pamphlets and minor works too numerous to mention. The only one of them perhaps which requires notice is *Religious Courtship* (1722), a curious series of dialogues displaying Defoe's unaffected religiosity, and at the same time the rather meddling intrusiveness with which he applied his religious notions. This was more flagrantly illustrated in one of his latest works, *The Treatise Concerning the Use and Abuse of the Marriage Bed* (1727), which was originally issued with a much more offensive name, and has been called "an excellent book with an improper title." *The Memoirs of Captain Carleton* (1728) were long attributed to Defoe, but the internal evidence is strongly against his authorship. They have been also attributed to Swift, with greater probability

as far as style is concerned. *The Life of Mother Ross*, reprinted in Bohn's edition, has no claim whatever to be considered Defoe's.

There is little to be said of Defoe's private life during this period. He must in some way or other have obtained a considerable income. In 1724 he had built himself a large house at Stoke Newington, which had stables and grounds of considerable size. From the negotiations for the marriage of his daughter Sophia it appears that he had landed property in more than one place, and he had obtained on lease in 1722 a considerable estate from the corporation of Colchester, which was settled on his unmarried daughter at his death. Other property was similarly allotted to his widow and remaining children, though some difficulty seems to have arisen from the misconduct of his son, to whom, for some purpose, the property was assigned during his father's lifetime, and who refused to pay what was due. There is a good deal of mystery about the end of Defoe's life; it used to be said that he died insolvent, and that he had been in jail shortly before his death. As a matter of fact, after great suffering from gout and stone, he died in Ropemaker's Alley, Moorfields, on Monday the 26th of April 1731, and was buried in Bunhill Fields. He left no will, all his property having been previously assigned, and letters of administration were taken out by a creditor. How his affairs fell into this condition, why he did not die in his own house, and why in the previous summer he had been in hiding, as we know he was from a letter still extant, are points not clearly explained. He was, however, attacked by Mist, whom he wounded, in prison in 1724. It is most likely that Mist had found out that Defoe was a government agent and quite probable that he communicated his knowledge to other editors, for Defoe's journalistic employment almost ceased about this time, and he began to write anonymously, or as "Andrew Moreton." It is possible that he had to go into hiding to avoid the danger of being accused as a real Jacobite, when those with whom he had contracted to assume the character were dead and could no longer justify his attitude.

Defoe married, on New Year's Day, 1684, Mary Tuffley, who survived until December 1732. They had seven children. His second son, Bernard or Benjamin Norton, has, like his father, a scandalous niche in the *Dunciad*. In April 1877 public attention was called to the distress of three maiden ladies, directly descended from Defoe, and bearing his name; and a crown pension of £75 a year was bestowed on each of them. His youngest daughter, Sophia, who married Henry Baker, left a considerable correspondence, now in the hands of her descendants. There are several portraits of Defoe, the principal one being engraved by Vander-  
gucht.

In his lifetime, Defoe, as not belonging to either of the great parties at a time of the bitterest party strife, was subjected to obloquy on both sides. The great Whig writers leave him unnoticed. Swift and Gay speak slightly of him,—the former, it is true, at a time when he was only known as a party pamphleteer. Pope, with less excuse, put him in the *Dunciad* towards the end of his life, but he confessed to Spence in private that Defoe had written many things and none bad. At a later period he was unjustly described as "a scurrilous party writer," which he certainly was not; but, on the other hand, Johnson spoke of his writing "so variously and so well," and put *Robinson Crusoe* among the only three books that readers wish longer. From Sir Walter Scott downwards the tendency to judge literary work on its own merits to a great extent restored Defoe to his proper place, or, to speak more correctly, set him there for the first time. Lord Macaulay's description of *Roxana*, *Moll Flanders* and *Colonel Jack* as "utterly nauseous and wretched" must be set aside as a freak of criticism.

Scott justly observed that Defoe's style "is the last which should be attempted by a writer of inferior genius; for though it be possible to disguise mediocrity by fine writing, it appears in all its naked inanity when it assumes the garb of simplicity." The methods by which Defoe attains his result are not difficult to disengage. They are the presentment of all his ideas and scenes in the plainest and most direct language, the frequent employ-

ment of colloquial forms of speech, the constant insertion of little material details and illustrations, often of a more or less digressive form, and, in his historico-fictitious works, as well as in his novels, the most rigid attention to vivacity and consistency of character. Plot he disregards, and he is fond of throwing his dialogues into regular dramatic form, with by-play prescribed and stage directions interspersed. A particular trick of his is also to divide his arguments after the manner of the preachers of his day into heads and subheads, with actual numerical signs affixed to them. These mannerisms undoubtedly help and emphasize the extraordinary faithfulness to nature of his fictions, but it would be a great mistake to suppose that they fully explain their charm. Defoe possessed genius, and his secret is at the last as impalpable as the secret of genius always is.

The character of Defoe, both mental and moral, is very clearly indicated in his works. He, the satirist of the true-born Englishman, was himself a model, with some notable variations and improvements, of the Englishman of his period. He saw a great many things, and what he did see he saw clearly. But there were also a great many things which he did not see, and there was often no logical connexion whatever between his vision and his blindness. The most curious example of this inconsistency, or rather of this indifference to general principle, occurs in his *Essay on Projects*. He there speaks very briefly and slightly of life insurance, probably because it was then regarded as impious by religionists of his complexion. But on either side of this refusal are to be found elaborate projects of friendly societies and widows' funds, which practically cover, in a clumsy and roundabout manner, the whole ground of life insurance. In morals it is evident that he was, according to his lights, a strictly honest and honourable man. But sentiment of any "high-flying" description—to use the cant word of his time—was quite incomprehensible to him, or rather never presented itself as a thing to be comprehended. He tells us with honest and simple pride that when his patron Harley fell out, and Godolphin came in, he for three years held no communication with the former, and seems quite incapable of comprehending the delicacy which would have obliged him to follow Harley's fallen fortunes. His very anomalous position in regard to Mist is also indicative of a rather blunt moral perception. One of the most affecting things in his novels is the heroic constancy and fidelity of the maid Amy to her exemplary mistress Roxana. But Amy, scarcely by her own fault, is drawn into certain breaches of definite moral laws which Defoe did understand, and she is therefore condemned, with hardly a word of pity, to a miserable end. Nothing heroic or romantic was within Defoe's view; he could not understand passionate love, ideal loyalty, aesthetic admiration or anything of the kind; and it is probable that many of the little sordid touches which delight us by their apparent satire were, as designed, not satire at all, but merely a faithful representation of the feelings and ideas of the classes of which he himself was a unit.

His political and economical pamphlets are almost unmatched as clear presentations of the views of their writer. For driving the nail home no one but Swift excels him, and Swift perhaps only in *The Drapier's Letters*. There is often a great deal to be said against the view presented in those pamphlets, but Defoe sees nothing of it. He was perfectly fair but perfectly one-sided, being generally happily ignorant of everything which told against his own view.

The same characteristics are curiously illustrated in his moral works. The morality of these is almost amusing in its downright positive character. With all the Puritan eagerness to push a clear, uncompromising, Scripture-based distinction of right and wrong into the affairs of every-day life, he has a thoroughly English horror of casuistry, and his clumsy canons consequently make wild work with the infinite intricacies of human nature. He is, in fact, an instance of the tendency, which has so often been remarked by other nations in the English, to drag in moral distinctions at every turn, and to confound everything which is novel to the experience, unpleasant to the taste, and incomprehensible to the understanding, under the general epithets of

wrong, wicked and shocking. His works of this class therefore are now the least valuable, though not the least curious, of his books.

The earliest regular life and estimate of Defoe is that of Dr Towers in the *Biographia Britannica*. George Chalmers's *Life*, however (1786), added very considerable information. In 1830 Walter Wilson wrote the standard *Life* (3 vols.); it is coloured by political prejudice, but is a model of painstaking care, and by its abundant citations from works both of Defoe and of others, which are practically inaccessible to the general reader, is invaluable. In 1859 appeared a life of Defoe by William Chadwick, an extraordinary rhapsody in a style which is half Cobbett and half Carlyle, but amusing, and by no means devoid of acuteness. In 1864 the discovery of the six letters stirred up William Lee to a new investigation, and the results of this were published (London, 1869) in three large volumes. The first of these (well illustrated) contains a new life and particulars of the author's discoveries. The second and third contain fugitive writings assigned by Lee to Defoe for the first time. For most of these, however, we have no authority but Lee's own impressions of style, &c.; and consequently, though the best qualified judges will in most cases agree that Defoe may very likely have written them, it cannot positively be stated that he did. There is also a *Life* by Thomas Wright (1894). The *Earlier Life and Chief Earlier Works* of Defoe (1890) was included by Henry Morley in the "Carisbrooke Library." Charles Lamb's criticisms were made in three short pieces, two of which were written for Wilson's book, and the third for *The Reflector*. The volume on Defoe (1879) in the "English Men of Letters" series is by W. Minto.

There is considerable uncertainty about many of Defoe's writings; and even if all contested works be excluded, the number is still enormous. Besides the list in Bohn's *Louises*, which is somewhat of an *omnium gatherum*, three lists drawn with more or less care were compiled in the 19th century. Wilson's contains 210 distinct works, three or four only of which are marked as doubtful; Hazlitt's enumerates 183 "genuine" and 52 "attributed" pieces, with notes on most of them; Lee's extends to 254, of which 64 claim to be new additions. The reprint (3 vols.) edited for the "Pulteney Library" by Hazlitt in 1840-1843 contains a good and full life mainly derived from Wilson, the whole of the novels (including the *Serious Reflections* now hardly ever published with *Robinson Crusoe*), *Jure Divino*, *The Use and Abuse of Marriage*, and many of the more important tracts and smaller works. There is also an edition, often called Scott's, but really edited by Sir G. C. Lewis, in twenty volumes (London, 1840-1841). This contains the *Complete Tradesman*, *Religious Courtship*, *The Consolidator* and other works not comprised in Hazlitt's. Scott had previously in 1809 edited for Ballantyne some of the novels, in twelve volumes. Bohn's "British Classics" includes the novels (except the third part of *Robinson Crusoe*), *The History of the Devil*, *The Storm*, and a few political pamphlets, also the undoubtedly spurious *Mother Ross*. In 1870 Nimmo of Edinburgh published in one volume an admirable selection from Defoe. It contains Chalmers's *Life*, annotated and completed from Wilson and Lee, *Robinson Crusoe*, pts. i. and ii., *Colonel Jack*, *The Cavalier*, *Duncan Campbell*, *The Plague*, *Everybody's Business*, *Mrs Veal*, *The Shortest Way with Dissenters*, *Giving Alms no Charity*, *The True-Born Englishman*, *Hymn to the Pillory*, and very copious extracts from *The Complete English Tradesman*. An edition of Defoe's *Romances and Narratives* in sixteen volumes by G. A. Aitken came out in 1895.

If we turn to separate works, the bibliography of Defoe is practically confined (except as far as original editions are concerned) to *Robinson Crusoe*. *Mrs Veal* has been to some extent popularized by the work which it helped to sell; *Religious Courtship* and *The Family Instructor* had a vogue among the middle class until well into the 19th century, and *The History of the Union* was republished in 1786. But the reprints and editions of *Crusoe* have been innumerable; it has been often translated; and the eulogy pronounced on it by Rousseau gave it special currency in France, where imitations (or rather adaptations) have also been common.

In addition to the principal authorities already mentioned see John Forster, *Historical and Biographical Essays* (1858); G. Saintsbury, "Introduction" to Defoe's *Minor Novels*; and valuable notes by G. A. Aitken in *The Contemporary Review* (February 1890), and *The Athenaeum* (April 30, 1889; August 31, 1890). A facsimile reprint (1883) of *Robinson Crusoe* has an introduction by Mr Austin Dobson. Dr Karl T. Bülbring edited two unpublished works of Defoe, *The Compleat English Gentleman* (London, 1890) and *Of Royall Education* (London, 1905), from British Museum Add. MS. 32,555. Further light was thrown on Defoe's work as a political agent by the discovery (1906) of an unpublished paper of his in the British Museum by G. F. Warner. This was printed in the *English Historical Review*, and afterwards separately.

**DEGAS, HILAIRE GERMAIN EDGARD** (1834- ), French painter, was born in Paris on the 19th of July 1834. Entering in 1855 the *École des Beaux Arts*, he early developed independence of artistic outlook, studying under Lamothe. He first exhibited in the Salon of 1865, contributing a "War in the

middle ages," a work executed in pastel. To this medium he was ever faithful, using it for some of his best work. In 1866 his "Steeplechase" revealed him as a painter of the racecourse and of all the most modern aspects of life and of Parisian society, treated in an extremely original manner. He subsequently exhibited in 1867 "Family Portraits," and in 1868 a portrait of a dancer in the "Ballet of *La Source*." In 1869 and 1870 he restricted himself to portraits; but thenceforward he abandoned the Salons and attached himself to the Impressionists. With Manet and Monet he took the lead of the new school at its first exhibition in 1874, and repeatedly contributed to these exhibitions (in 1876, 1878, 1879 and 1880). In 1868 he had shown his first study of a dancer, and in numerous pastels he proclaimed himself the painter of the ballet, representing its figurantes in every attitude with more constant aim at truth than grace. Several of his works may be seen at the Luxembourg Gallery, to which they were bequeathed, among a collection of impressionist pictures, by M. Caillebotte. In 1880 Degas showed his powers of observation in a set of "Portraits of Criminals," and he attempted modelling in a "Dancer," in wax. He afterwards returned to his studies of the sporting world, exhibiting in December 1884 at the Petit Gallery two views of "Races" which had a great success, proving the increasing vogue of the artist among collectors. He is ranked with Manet as the leader of the "impressionist school." At the eighth Impressionist Exhibition, in 1886, Degas continued his realistic studies of modern life, showing drawings of the nude, of workwomen, and of jockeys. Besides his pastels and his paintings of genre and portraits—among these, several likenesses of Manet—Degas also handled his favourite subjects in etching and in aquatint; and executed several lithographs of "Singers at Cafés-concert," of "Ballet-girls," and indeed of every possible subject of night-life and incidents behind the scenes. His work is to be seen not only at the Luxembourg but in many of the great private collections in Paris, in England and America. In the Centenary Exhibition of 1900 he exhibited "The Interior of a Cotton-Broker's Office at New Orleans" (belonging to the Museum at Pau) and "The Rehearsal."

See also G. Moore, "Degas, the Painter of Modern Life," *Magazine of Art* (1890); J. K. Huysmans, *Certains* (Paris, 1889); G. Geffroy, *La Vie Artistique* (3<sup>e</sup> Série, Paris, 1894).

**DE GEER, LOUIS GERHARD, BARON** (1818-1806), Swedish statesman and writer, was born on the 18th of July 1818 at Finsporg castle. He adopted the legal profession, and in 1855 became president of the Göta Hofret, or lord justice of one of the Swedish supreme courts. From the 7th of April 1858 to the 3rd of June 1870 he was minister of justice. As a member of the Upper House he took part in all the Swedish *Riksdags* from 1851 onwards, though he seldom spoke. From 1867 to 1878 he was the member for Stockholm in the first chamber, and introduced and passed many useful reformatory statutes; but his greatest achievement, as a statesman, was the reform of the Swedish representative system, whereby he substituted a bi-cameral elective parliament, on modern lines, for the existing cumbersome representation by estates, a survival from the later middle ages. This great measure was accepted by the *Riksdag* in December 1865, and received the royal sanction on the 22nd of June 1866. For some time after this De Geer was the most popular man in Sweden. He retired from the ministry in 1870, but took office again, as minister of justice, in 1875. In 1876 he became minister of state, which position he retained till April 1880, when the failure of his repeated efforts to settle the armaments' question again induced him to resign. From 1881 to 1888 he was chancellor of the universities of Upsala and Lund. Besides several novels and aesthetic essays, De Geer has written a few political memoirs of supreme merit both as to style and matter, the most notable of which are: *Minnesteckning öfver A. J. v. Höpken* (Stockholm, 1881); *Minnesteckning öfver Hans Jürta* (Stockholm, 1874); *Minnesteckning öfver B. B. von Platen* (Stockholm, 1886); and his own *Minnen* (Stockholm, 1892), an autobiography, invaluable as a historical document, in which the political experience and the matured judgments of

a lifetime are recorded with singular clearness, sobriety and charm.

See *Sveriges historia* (Stockholm, 1881, &c.), vi.; Carl Gustaf Malmström, *Historiska Studier* (Stockholm, 1897). (R. N. B.)

**DEGGENDORF**, or **DECKENDORF**, a town of Germany, in the kingdom of Bavaria, 25 m. N.W. of Passau, on the left bank of the Danube, which is there crossed by two iron bridges. Pop. (1905) 7154. It is situated at the lower end of the beautiful valley of the Perlbach, and in itself it is a well-built and attractive town. It possesses an old town hall dating from 1566, a hospital, a lunatic asylum, an orphanage, and a large parish church rebuilt in 1756; but the chief interest centres in the church of the Holy Sepulchre, built in 1337, which attracts thousands of pilgrims to its *Porta Caeli* or *Gnadenpforte* (Gate of Mercy) opened annually on Michaelmas eve and closed again on the 4th of October. In 1837, on the celebration of the 500th anniversary of this solemnity, the number of pilgrims was reckoned at nearly 100,000. Such importance as the town possesses is now rather commercial than religious,—it being a depôt for the timber trade of the Bavarian forest, a station for the Danube steamboat company, and the seat of several mills, breweries, potteries and other industrial establishments. On the bank of the Danube outside the town are the remains of the castle of Findelstein; and on the Geiersberg (1243 ft.), in the immediate vicinity, stands another old pilgrimage church. About 6 m. to the north is the village of Metten, with a Benedictine monastery founded by Charlemagne in 801, restored as an abbey in 1840 by Louis I. of Bavaria, and well known as an educational institution. The first mention of Deggendorf occurs in 868, and it appears as a town in 1212. Henry (d. 1290) of the Landshut branch of the ruling family of Bavaria made it the seat of a custom-house; and in 1331 it became the residence of Henry III. of Natternberg (d. 1333), so called from a castle in the neighbourhood. In 1337 a wholesale massacre of the Jews, who were accused of having thrown the sacred host of the church of the Holy Sepulchre into a well, took place in the town; and it is probably from about this date that the pilgrimage above mentioned came into vogue. The town was captured by the Swedish forces in 1633, and in the war of the Austrian Succession it was more than once laid in ashes.

See Grüber and Müller, *Der bayerische Wald* (Regensburg, 1851); Mittermüller, *Die heil. Hostien und die Juden in Deggendorf* (Landshut, 1866); and *Das Kloster Metten* (Straubing, 1857).

**DE HAAS, MAURITZ FREDERICK HENDRICK** (1832–1895), American marine painter, was born on the 12th of December 1832 in Rotterdam, Holland. He studied art in the Rotterdam Academy and at The Hague, under Bosboom and Louis Meyer, and in 1851–1852 in London, following the English water-colourists of the day. In 1857 he received an artist's commission in the Dutch navy, but in 1859, under the patronage of August Belmont, who had recently been minister of the United States at The Hague, he resigned and removed to New York city. He became an associate of the National Academy in 1863 and an academician in 1867, and exhibited annually in the academy, and in 1866 he was one of the founders of the American Society of Painters in Water Colors. He died on the 23rd of November 1895. His "Farragut Passing the Forts at the Battle of New Orleans" and "The Rapids above Niagara," which were exhibited at the Paris Exposition of 1878, were his best known but not his most typical works, for his favourite subjects were storm and wreck, wind and heavy surf, and less often moonlight on the coasts of Holland, of Jersey, of New England, and of Long Island, and on the English Channel.

His brother, **WILLIAM FREDERICK DE HAAS** (1830–1880), who emigrated to New York in 1854, was also a marine painter.

**DEHRA**, a town of British India, headquarters of the Dehra Dun district in the United Provinces. Pop. (1901) 28,095. It lies at an elevation of 2300 ft. Here the Hardwar-Dehra railway terminates. Dehra is the headquarters of the Trigonometrical Survey and of the Forest Department, besides being a cantonment for a Gurkha force. The Forest School, which trains subordinate forest officials for all parts of India, is a fine building. Attached to it is an institution for the scientific study of sylviculture and the exploitation and administration of forests.

The town of Dehra grew up round the temple built in 1699 by the heretical Sikh Guru, Ram Rai, the founder of the Udasi sect of Ascetics. This temple is a remarkable building in Mahomedan style. The central block, in imitation of the emperor Jahangir's tomb, contains the bed on which the Guru, after dying at will and coming back to life several times, ultimately died outright; it is an object of great veneration. At the corners of the central block are smaller monuments commemorating the Guru's wives.

**DEHRA DUN**, a district of British India, in the Meerut division of the United Provinces. Its area is 1209 sq. m. The district is bounded on the N. by the native state of Tehri or Garhwal, on the E. by British Garhwal, on the S. by the Siwálík hills, which separate it from Saharanpur district, and on the W. by the hill states of Sirmur, Jubbál and Taroch. The valley (the Dun) has an area of about 673 sq. m., and forms a parallelogram 45 m. from N.W. to S.E. and 15 m. broad. It is well wooded, undulating and intersected by streams. On the N.E. the horizon is bounded by the Mussoorie or lower range of the Himalayas, and on the S. by the Siwálík hills. The Himalayas in the north of the district attain a height between 7000 and 8000 ft., one peak reaching an elevation of 8565 ft.; the highest point of the Siwálík range is 3041 ft. above sea-level. The principal passes through the Siwálík hills are the Timli pass, leading to the military station of Chakráta, and the Mohand pass leading to the sanatoriums of Mussoorie and Landaur. The Ganges bounds the Dehra valley on the E.; the Jumna bounds it on the W. From a point about midway between the two rivers, and near the town of Dehra, runs a ridge which forms the watershed of the valley. To the west of this ridge the water collects to form the Asan, a tributary of the Jumna; whilst to the east the Suswa receives the drainage and flows into the Ganges. To the east the valley is characterized by swamps and forests, but to the west the natural depressions freely carry off the surface drainage. Along the central ridge, the water-level lies at a great depth from the surface (228 ft.), but it rises gradually as the country declines towards the great rivers. In 1901 the population was 178,195, showing an increase of 6% in the decade. A railway to Dehra from Hardwar, on the Oudh and Rohilkhand line (32 m.), was completed in 1900. The district is served by the Dun canals. Tea gardens cover a considerable area, and the valley contains a colony of European tea planters.

*History.*—Dehra Dun only emerges from the mists of legend into authentic history in the 17th century A.D., when it formed part of the Garhwal kingdom. Towards the end of the century the heretical Sikh Guru, Ram Rai, expelled from the Punjab, sought refuge in the Dun and gathered round him a crowd of devotees. Fateh Sah, raja of Garhwal, endowed the temple which he built, round which grew up the town of Gurudwara or Dehra (*q.v.*). In the 18th century the fertility of the valley attracted the attention of Najib-ud-daula, governor of Saharanpur, who invaded it with an army of Rohillas in 1757 and annexed it to his dominion. His rule, which lasted till 1770, brought great prosperity to the Dun; but on his death it became a prey to the surrounding tribes, its desolation being completed after its conquest by the Gurkhas in 1803. In 1814 it was taken possession of by the British, and in the following year was annexed to Saharanpur. Under British administration the Dun rapidly recovered its prosperity.

**DEIOCES** (*Δηϊόκης*), according to Herodotus (i. 96 ff.) the first king of the Medes. He narrates that, when the Medes had rebelled against the Assyrians and gained their independence about 710 B.C., according to his chronology (cf. Diodor. ii. 32), they lived in villages without any political organization, and therefore the whole country was in a state of anarchy. Then Deioces, son of Phraortes, an illustrious man of upright character, was chosen judge in his village, and the justness of his decisions induced the inhabitants of the other villages to throng to him. At last the Medes resolved to make an end of the intolerable state of their country by erecting a kingdom, and chose Deioces king. He now caused them to build a great capital, Ecbatana, with a royal palace, and introduced the ceremonial of oriental courts;

he surrounded himself with a guard and no longer showed himself to the people, but gave his judgments in writing and controlled the people by officials and spies. He united all the Median tribes, and ruled fifty-three years (c. 690–647 B.C.), though perhaps, as G. Rawlinson supposed, the fifty-three years of his reign are exchanged by mistake with the twenty-two years of his son Phraortes, under whom the Median conquests began.

The narration of Herodotus is only a popular tradition which derives the origin of kingship from its judicial functions, considered as its principal and most beneficent aspect. We know from the Assyrian inscriptions that just at the time which Herodotus assigns to Deioces the Medes were divided into numerous small principalities and subjected to the great Assyrian conquerors. Among these petty chieftains, Sargon in 715 mentions Dāyukku, "lieutenant of Man" (he probably was, therefore, a vassal of the neighbouring king of Man in the mountains of south-eastern Armenia), who joined the Urartians and other enemies of Assyria, but was by Sargon transported to Hamath in Syria "with his clan." His district is called "bit-Dāyaukki," "house of Deioces," also in 713, when Sargon invaded these regions again. So it seems that the dynasty, which more than half a century later succeeded in throwing off the Assyrian yoke and founded the Median empire, was derived from this Dāyukku, and that his name was thus introduced into the Median traditions, which contrary to history considered him as founder of the kingdom. (E. D. M.)

**DEIOTARUS**, a tetrarch of Galatia (Gallo-Graecia) in Asia Minor, and a faithful ally of the Romans. He is first heard of at the beginning of the third Mithradatic war, when he drove out the troops of Mithradates under Eumachus from Phrygia. His most influential friend was Pompey, who, when settling the affairs of Asia (63 or 62 B.C.), rewarded him with the title of king and an increase of territory (Lesser Armenia). On the outbreak of the civil war, Deiotarus naturally sided with his old patron Pompey, and after the battle of Pharsalus escaped with him to Asia. In the meantime Pharnaces, the son of Mithradates, had seized Lesser Armenia, and defeated Deiotarus near Nicopolis. Fortunately for Deiotarus, Caesar at that time (47) arrived in Asia from Egypt, and was met by the tetrarch in the dress of a suppliant. Caesar pardoned him for having sided with Pompey, ordered him to resume his royal attire, and hastened against Pharnaces, whom he defeated at Zela. In consequence of the complaints of certain Galatian princes, Deiotarus was deprived of part of his dominions, but allowed to retain the title of king. On the death of Mithradates of Pergamum, tetrarch of the Trocmi, Deiotarus was a candidate for the vacancy. Other tetrarchs also pressed their claims; and, further, Deiotarus was accused by his grandson Castor of having attempted to assassinate Caesar when the latter was his guest in Galatia. Cicero, who entertained a high opinion of Deiotarus, whose acquaintance he had made when governor of Cilicia, undertook his defence, the case being heard in Caesar's own house at Rome. The matter was allowed to drop for a time, and the assassination of Caesar prevented any final decision being pronounced. In his speech Cicero briefly dismisses the charge of assassination, the main question being the distribution of the provinces, which was the real cause of the quarrels between Deiotarus and his relatives. After Caesar's death, Mark Antony, for a large monetary consideration, publicly announced that, in accordance with instructions left by Caesar, Deiotarus was to resume possession of all the territory of which he had been deprived. When civil war again broke out, Deiotarus was persuaded to support Brutus and Cassius, but after the battle of Philippi went over to the triumvirs. He remained in possession of his kingdom till his death at a very advanced age.

See Cicero, *Philippica*, ii. 37; *Ad fam.* viii. 10, ix. 12, xv. 1, 2, 4; *Ad Att.* xiv. 1; *De divin.* i. 15, ii. 36, 37; *De harusp. resp.* 13, and above all *Pro rege Deiotaro*; Appian, *Bell. Mithrid.* 75, 114; *Bellum Alexandrinum*, 34-41, 65-77; Dio Cassius xli. 63, xlii. 45, xlvii. 24, 48, xlviii. 33.

**DEIR**, or DEIR EZ-ZOR, a town of Asiatic Turkey, on the right bank of the Euphrates, 27½ m. above its junction with the

Khabor, lat. 35° 20' N., long. 40° 12' E. Pop. 8000 and upward, about one-tenth Christians; except in the official classes, there are no Turks. It is the capital and the only considerable town of the Zor sanjak, formed in 1857, which includes Ras el-Ain on the north and Palmyra on the south, with a total area of 32,820 sq. m., chiefly desert, and an estimated population of 100,000, mostly Arab nomads. Deir itself is a thrifty and rising town, having considerable traffic; it is singularly European in appearance, with macadamized streets and a public garden. The name Deir means monastery, but there is no other trace or tradition of the occupation of the site before the 14th century, and until it became the capital of the sanjak it was an insignificant village. It is an important centre for the control of the Bedouin Arabs, and has a garrison of about 1000 troops, including a special corps of mule-riders. It is also a road centre, the roads from the Mediterranean to Bagdad by way of Aleppo and Damascus respectively meeting here. A road also leads northward, by Sinjar, to Mosul, crossing the river on a stone bridge, built in 1897, the only permanent bridge over the Euphrates south of Asia Minor. (J. P. PÆ.)

**DEIRA**, the southern of the two English kingdoms afterwards united as Northumbria. According to Simeon of Durham it extended from the Humber to the Tyne, but the land was waste north of the Tees. York was the capital of its kings. The date of its first settlement is quite unknown, but the first king of whom we have any record is Ella or Ælle, the father of Edwin, who is said to have been reigning about 585. After his death Deira was subject to Æthelfrith, king of Northumbria, until the accession of Edwin, in 616 or 617, who ruled both kingdoms (see EDWIN) till 633. Osric the nephew of Edwin ruled Deira (633-634), but his son Oswine was put to death by Oswio in 651. For a few years subsequently Deira was governed by Æthelwald son of Oswald.

See Bede, *Historia ecclesiastica*, ii. 14, iii. 1, 6, 14 (ed. C. Plummer, Oxford, 1896); Nennius, *Historia Brittonum*, § 64 (ed. Th. Mommsen, Berlin, 1898); Simeon of Durham, *Opera*, i. 339 (ed. T. Arnold, London, 1882-1885). (F. G. M. B.)

**DEISM** (Lat. *deus*, god), strictly the belief in one supreme God. It is however the received name for a current of rationalistic theological thought which, though not confined to one country, or to any well-defined period, was most conspicuous in England in the last years of the 17th and the first half of the 18th century. The deists, differing widely in important matters of belief, were yet agreed in seeking above all to establish the certainty and sufficiency of natural religion in opposition to the positive religions, and in tacitly or expressly denying the unique significance of the supernatural revelation in the Old and New Testaments. They either ignored the Scriptures, endeavoured to prove them in the main by a helpful republication of the *Evangelium aeternum*, or directly impugned their divine character, their infallibility, and the validity of their evidences as a complete manifestation of the will of God. (The term "deism" not only is used to signify the main body of the deists' teaching, or the tendency they represent, but has come into use as a technical term for one specific metaphysical doctrine as to the relation of God to the universe, assumed to have been characteristic of the deists, and to have distinguished them from atheists, pantheists and theists,—the belief, namely, that the first cause of the universe is a personal God, who is, however, not only distinct from the world but apart from it and its concerns.)

The words "deism" and "deist" appear first about the middle of the 16th century in France (cf. Bayle's *Dictionnaire*, s.v. "Viret," note D), though the deistic standpoint had already been foreshadowed to some extent by Averroists, by Italian authors like Boccaccio and Petrarch, in More's *Utopia* (1515), and by French writers like Montaigne, Charron and Bodin. The first specific attack on deism in English was Bishop Stillingfleet's *Letter to a Deist* (1677). By the majority of those historically known as the English deists, from Blount onwards, the name was owned and honoured. They were also occasionally called "rationalists." "Free-thinker" (in Germany, *Freidenker*) was generally taken to be synonymous with "deist," though obviously



capable of a wider signification, and as coincident with *esprit fort* and with *libertin* in the original and theological sense of the word.<sup>1</sup> "Naturalists" was a name frequently used of such as recognized no god but nature, of so-called Spinozists, atheists; but both in England and Germany, in the 18th century, this word was more commonly and aptly in use for those who founded their religion on the *lumen naturae* alone. It was evidently in common use in the latter half of the 16th century as it is used by De Mornay in *De la vérité de la religion chrétienne* (1581) and by Montaigne. The same men were not seldom assaulted under the name of "theists"; the later distinction between "theist" and "deist," which stamped the latter word as excluding the belief in providence or in the immanence of God, was apparently formulated in the end of the 18th century by those rationalists who were aggrieved at being identified with the naturalists. (See also THEISM.)

The chief names amongst the deists are those of Lord Herbert of Cherbury (1583-1648), Charles Blount (1654-1693), Matthew Tindal (1657-1733), William Wollaston (1659-1724), Thomas Woolston (1669-1733), Junius Janus (commonly known as John Toland (1670-1722), the 3rd earl of Shaftesbury (1671-1713), Viscount Bolingbroke (1678-1751), Anthony Collins (1676-1729), Thomas Morgan (?-1743), and Thomas Chubb (1679-1747).<sup>2</sup> Peter Annet (1693-1769), and Henry Dodwell (the younger; d. 1784), who made his contribution to the controversy in 1742, are of less importance. Of the eleven first named, ten appear to have been born within twenty-five years of one another; and it is noteworthy that by far the greater part of the literary activity of the deists, as well as of their voluminous opponents, falls within the same half century.

The impulses that promoted a vein of thought cognate to deism were active both before and after the time of its greatest notoriety. But there are many reasons to show why, in the 17th century, men should have set themselves with a new zeal, in politics, law and theology, to follow the light of nature alone, and to cast aside the fetters of tradition and prescriptive right, of positive codes, and scholastic systems, and why in England especially there should, amongst numerous free-thinkers, have been not a few free writers. The significance of the Copernican system, as the total overthrow of the traditional conception of the universe, dawned on all educated men. In physics, Descartes had prepared the way for the final triumph of the mechanical explanation of the world in Newton's system. In England the new philosophy had broken with time-honoured beliefs more completely than it had done even in France; Hobbes was more startling than Bacon. Locke's philosophy, as well as his theology, served as a school for the deists. Men had become weary of Protestant scholasticism; religious wars had made peaceful thinkers seek to take the edge off dogmatical rancour; and the multiplicity of religious sects, coupled with the complete failure of various attempts at any substantial reconciliation, provoked distrust of the common basis on which all were founded. There was a school of distinctively latitudinarian thought in the Church of England; others not unnaturally thought it better to extend the realm of the *adiaphora* beyond the sphere of Protestant ritual or the details of systematic divinity. Arminianism had revived the rational side of theological method. Semi-Arians and Unitarians, though sufficiently distinguished from the free-thinkers by reverence for the letter of Scripture, might be held to encourage departure from the ancient landmarks. The scholarly labours of P. D. Huet, R. Simon, L. E. Dupin, and Jean Le Clerc (Clericus), of the orientlists John Lightfoot, John Spencer and Humphrey Prideaux, of John Mill, the collator of New Testament readings, and John Fell, furnished new materials for controversy; and the

scope of Spinoza's *Tractatus theologico-politicus* had naturally been much more fully apprehended than ever his *Ethica* could be. The success of the English revolution permitted men to turn from the active side of political and theological controversy to speculation and theory; and curiosity was more powerful than faith. Much new ferment was working. The toleration and the free press of England gave it scope. Deism was one of the results, and is an important link in the chain of thought from the Reformation to our own day.

Long before England was ripe to welcome deistic thought Lord Herbert of Cherbury earned the name "Father of Deism" by laying down the main line of that religious philosophy which in various forms continued ever after to be the backbone of deistic systems. He based his theology on a comprehensive, if insufficient, survey of the nature, foundation, limits and tests of human knowledge. And amongst the divinely implanted, original, indefeasible *notitiae communes* of the human mind, he found as foremost his five articles:—that there is one supreme God, that he is to be worshipped, that worship consists chiefly of virtue and piety, that we must repent of our sins and cease from them, and that there are rewards and punishments here and hereafter. Thus Herbert sought to do for the religion of nature what his friend Grotius was doing for natural law,—making a new application of the standard of Vincent of Lerins, *Quod semper, quod ubique, quod ab omnibus*. It is important to notice that Herbert, as English ambassador at Paris, united in himself the currents of French and English thought, and also that his *De Veritate*, published in Latin and translated into French, did not appear in an English version.

Herbert had hardly attempted a systematic criticism of the Christian revelation either as a whole or in its details. Blount, a man of a very different spirit, did both, and in so doing may be regarded as having inaugurated the second main line of deistic procedure, that of historico-critical examination of the Old and New Testaments. Blount adopted and expanded Hobbes's arguments against the Mosaic authorship of the Pentateuch; and, mainly in the words of Burnet's *Archeologiae philosophicae*, he asserts the total inconsistency of the Mosaic Hexameron with the Copernican theory of the heavens, dwelling with emphasis on the impossibility of admitting the view developed in Genesis, that the earth is the most important part of the universe. He assumes that the narrative was meant *ethically*, not *physically*, in order to eliminate false and polytheistic notions; and he draws attention to that double narrative in Genesis which was elsewhere to be so fruitfully handled. The examination of the miracles of Apollonius of Tyana, professedly founded on papers of Lord Herbert's, is meant to suggest similar considerations with regard to the miracles of Christ. Naturalistic explanations of some of these are proposed, and a mythical theory is distinctly foreshadowed when Blount dwells on the inevitable tendency of men, especially long after the event, to discover miracles attendant on the birth and death of their heroes. Blount assaults the doctrine of a mediator as irreligious. He dwells much more pronouncedly than Herbert on the view, afterwards regarded as a special characteristic of all deists, that much or most error in religion has been invented or knowingly maintained by sagacious men for the easier maintenance of good government, or in the interests of themselves and their class. And when he heaps suspicion, not on Christian dogmas, but on beliefs of which the resemblance to Christian tenets is sufficiently patent, the real aim is so transparent that his method seems to partake rather of the nature of literary eccentricity than of polemical artifice; yet by this disingenuous indirectness he gave his argument that savour of duplicity which ever after clung to the popular conception of deism.

Shaftesbury, dealing with matters for the most part different from those usually handled by the deists, stands almost wholly out of their ranks. But he showed how loosely he held the views he did not go out of his way to attack, and made it plain how little weight the letter of Scripture had for himself; and, writing with much greater power than any of the deists, he was held to have done more than any one of them to forward the cause

<sup>1</sup> The right of the orthodox party to use this name was asserted by the publication in 1715 of a journal called *The Freethinker*, conducted by anti-deistic clergymen. The term *libertin* appears to have been used first as a hostile epithet of the Brethren of the Free Spirit, a 13th-century sect which was accused not only of free-thought but also of licentious living.

<sup>2</sup> See the separate biographies of these writers. The three most significant names after Lord Herbert are those of Toland, Wollaston and Tindal.

for which they wrought. Founding ethics on the native and cultivable capacity in men to appreciate worth in men and actions, and, like the ancient Greek thinkers whom he followed, associating the apprehension of morality with the apprehension of beauty, he makes morality wholly independent of scriptural enactment, and still more, of theological forecasting of future bliss or agony. He yet insisted on religion as the crown of virtue; and, arguing that religion is inseparable from a high and holy enthusiasm for the divine plan of the universe, he sought the root of religion in feeling, not in accurate beliefs or meritorious good works. He set little store on the theology of those who in a system of dry and barren notions "pay handsome compliments to the Deity," "remove providence," "explode devotion," and leave but "little of zeal, affection, or warmth in what they call rational religion." In the protest against the scheme of "judging truth by counting noses," Shaftesbury recognized the danger of the standard which seemed to satisfy many deists; and in almost every respect he has more in common with those who afterwards, in Germany, annihilated the pretensions of complacent rationalism than with the rationalists themselves.

Toland, writing at first professedly without hostility to any of the received elements of the Christian faith, insisted that Christianity was not mysterious, and that the value of religion could not lie in any unintelligible or self-contradictory elements; though we cannot know the real essence of God or of any of his creatures, yet our beliefs about God must be thoroughly consistent with reason. Afterwards, Toland discussed, with considerable real learning and much show of candour, the comparative evidence for the canonical and apocryphal Scriptures, and demanded a careful and complete historical examination of the grounds on which our acceptance of the New Testament canon rests. He contributed little to the solution of the problem, but forced the investigation of the canon alike on theologians and the reading public. Again, he sketched a view of early church history, further worked out by Johann Salomo Semler (1725-1791), and surprisingly like that which was later elaborated by the Tübingen school. He tried to show, both from Scripture and extra-canonical literature, that the primitive church, so far from being an incorporate body of believers with the same creed and customs, really consisted of two schools, each possessing its "own gospel"—a school of Ebionites or Judaizing Christians, and the more liberal school of Paul. These parties, consciously but amicably differing in their whole relation to the Jewish law and the outside world, were subsequently forced into a non-natural uniformity. The cogency of Toland's arguments was weakened by his manifest love of paradox. Wollaston upheld the "intellectual" theory of morality, and all his reasoning is independent of any authority or evidence derived from revelation. His system was simplicity itself, all sin being reduced to the one form of lying. He favoured the idea of a future life as being necessary to set right the mistakes and inequalities of the present.

Collins, who had created much excitement by his *Discourse of Free-thinking*, insisting on the value and necessity of unprejudiced inquiry, published at a later stage of the deistic controversy the famous argument on the evidences of Christianity. Christianity is founded on Judaism; its main prop is the argument from the fulfilment of prophecy. Yet no interpretation or rearrangement of the text of Old Testament prophecies will secure a fair and non-allegorical correspondence between these and their alleged fulfilment in the New Testament. The inference is not expressly drawn, though it becomes perfectly clear from his refutation of William Whiston's curious counter theory that there were in the original Hebrew scriptures prophecies which were literally fulfilled in the New Testament, but had been expunged at an early date by Jewish scribes. Collins indicates the possible extent to which the Jews may have been indebted to Chaldeans and Egyptians for their theological views, especially as great part of the Old Testament would appear to have been remodelled by Ezra; and, after dwelling on the points in which the prophecies attributed to Daniel differ from all other Old Testament predictions, he states the greater number of the arguments still used

to show that the book of Daniel deals with events past and contemporaneous, and is from the pen of a writer of the Maccabean period, a view now generally accepted. Collins resembles Blount in "attacking specific Christian positions rather than seeking for a foundation on which to build the edifice of Natural Religion." Amongst those who replied to him were Richard Bentley, Edward Chandler, bishop of Lichfield, and Thomas Sherlock, afterwards bishop of London, who also attacked Woolston. They refuted him easily on many specific points, but carefully abstained from discussing the real question at issue, namely the propriety of free inquiry.

Woolston, at first to all appearance working earnestly in behalf of an allegorical but believing interpretation of the New Testament miracles, ended by assaulting, with a yet unknown violence of speech, the absurdity of accepting them as actual historical events, and did his best to overthrow the credibility of Christ's principal miracles. The bitterness of his outspoken invective against the clergy, against all priestcraft and priesthood, was a new feature in deistic literature, and injured the author more than it furthered his cause.

Tindal's aim seems to have been a sober statement of the whole case in favour of natural religion, with copious but moderately worded criticism of such beliefs and usages in the Christian and other religions as he conceived to be either non-religious or directly immoral and unwholesome. The work in which he endeavoured to prove that true Christianity is as old as the creation, and is really but the republication of the gospel of nature, soon gained the name of the "Deist's Bible." It was against Tindal that the most important of the orthodox replies were directed, e.g. John Conybeare's *Defence of Revealed Religion*, William Law's *Case of Reason* and, to a large extent, Butler's *Analogy*.

Morgan criticized with great freedom the moral character of the persons and events of Old Testament history, developing the theory of conscious "accommodation" on the part of the leaders of the Jewish church. This accommodation of truth, by altering the form and substance of it to meet the views and secure the favour of ignorant and bigoted contemporaries, Morgan attributes also to the apostles and to Jesus. He likewise expands at great length a theory of the origin of the Catholic Church much like that sketched by Toland, but assumes that Paul and his party, latterly at least, were distinctly hostile to the Judaical party of their fellow-believers in Jesus as the Messiah, while the college of the original twelve apostles and their adherents viewed Paul and his followers with suspicion and disfavour. Persecution from without Morgan regards as the influence which mainly forced the antagonistic parties into the oneness of the catholic and orthodox church. Morgan "seems to have discerned the dawning of a truer and better method" than the others. "He saw dimly that things require to be accounted for as well as affirmed or denied," and he was "one of the pioneers of modern historical science as applied to biblical criticism."

Annet made it his special work to invalidate belief in the resurrection of Christ, and to discredit the work of Paul.

Chubb, the least learnedly educated of the deists, did more than any of them, save Herbert, to round his system into a logical whole. From the New Testament he sought to show that the teaching of Christ substantially coincides with natural religion as he understood it. But his main contention is that Christianity is not a doctrine but a life, not the reception of a system of truths or facts, but a pious effort to live in accordance with God's will here, in the hope of joining him hereafter. Chubb dwells with special emphasis on the fact that Christ preached the gospel to the poor, and argues, as Tindal had done, that the gospel must therefore be accessible to all men without any need for learned study of evidences for miracles, and intelligible to the meanest capacity. He sought to show that even in the New Testament there are essential contradictions, and instances the unconditional forgiveness preached by Christ in the gospels as compared with Paul's doctrine of forgiveness by the mediation of Christ. Externally Chubb is interesting as representing the deism of the people contrasted with that of Tindal the theologian.

Dodwell's ingenious thesis, that Christianity is not founded on argument, was certainly not meant as an aid to faith; and, though its starting-point is different from all other deistical works, it may safely be reckoned amongst their number.

Though himself contemporary with the earlier deists, Bolingbroke's principal works were posthumously published after interest in the controversy had declined. His whole strain, in sharp contrast to that of most of his predecessors, is cynical and satirical, and suggests that most of the matters discussed were of small personal concern to himself. He gives fullest scope to the ungenerous view that a vast proportion of professedly revealed truth was ingeniously palmed off by the more cunning on the more ignorant for the convenience of keeping the latter under. But he writes with keenness and wit, and knows well how to use the materials already often taken advantage of by earlier deists.

Before passing on to a summary of the deistic position, it is necessary to say something of the views of Conyers Middleton (*q.v.*), who, though he never actually severed himself from orthodoxy, yet advanced theories closely analogous to those of the deists. His most important theological work was that devoted to an exposure of patristic miracles. His attack was based largely on arguments which could be turned with equal force against the miracles of the New Testament, and he even went further than previous rationalists in impugning the credibility of statements as to alleged miracles emanating from martyrs and the fathers of the early church. That Middleton was prepared to carry this type of argument into the apostolic period is shown by certain posthumous essays (*Miscellaneous Works*, ii. pp. 255 ff.), in which he charges the New Testament writers with inconsistency and the apostles with suppressing their cherished beliefs on occasions of difficulty.

In the substance of what they received as natural religion, the deists were for the most part agreed; Herbert's articles continued to contain the fundamentals of their theology. Religion, though not identified with morality, had its most important outcome in a faithful following of the eternal laws of morality, regarded as the will of God. With the virtuous life was further to be conjoined a humble disposition to adore the Creator, avoiding all factitious forms of worship as worse than useless. The small value they attributed to all outward and special forms of service, and the want of any sympathetic craving for the communion of saints, saved the deists from attempting to found a free-thinking church. They seem generally to have inclined to a quietistic accommodation to established forms of faith, till better times came. They steadfastly sought to eliminate the miraculous from theological belief, and to expel from the system of religious truth all debatable, difficult or mysterious articles. They aimed at a rational and intelligible faith, professedly in order to make religion, in all its width and depth, the heritage of every man. They regarded with as much suspicion the notion of a "peculiar people" of God, as of a unique revelation, and insisted on the possibility of salvation for the heathen. They rejected the doctrine of the Trinity, and protested against mediatorship, atonement and the imputed righteousness of Christ, always laying more stress on the teaching of Christ than on the teaching of the church about him; but they repeatedly laid claim to the name of Christians or of Christian deists. Against superstition, fanaticism and priestcraft they protested unceasingly. They all recognized the soul of man—not regarded as intellectual alone—as the ultimate court of appeal. But they varied much in their attitude towards the Bible. Some were content to argue their own ideas into Scripture, and those they disliked out of it; to one or two it seemed a satisfaction to discover difficulties in Scripture, to point to historical inaccuracies and moral defects. Probably Chubb's position on this head is most fairly characteristic of deism. He holds that the narrative, especially of the New Testament, is in the main accurate, but, as written after the events narrated, has left room for misunderstandings and mistakes. The apostles were good men, to whom, after Christ, we are most indebted; but they were fairly entitled to their own private opinions, and naturally introduced these into their writings. The epistles, according to Chubb, contain errors of

fact, false interpretations of the Old Testament, and sometimes disfigurement of religious truth.

The general tendency of the deistical writings is sufficiently self-consistent to justify a common name. But deism is not a compact system nor is it the outcome of any one line of philosophical thought. Of matters generally regarded as pertaining to natural religion, that on which they were least agreed was the certainty, philosophical demonstrability and moral significance of the immortality of the soul, so that the deists have sometimes been grouped into "mortal" and "immortal" deists. For some the belief in future rewards and punishments was an essential of religion; some seem to have questioned the doctrine as a whole; and, while others made it a basis of morality, Shaftesbury protested against the ordinary theological form of the belief as immoral. No two thinkers could well be more opposed than Shaftesbury and Hobbes; yet sometimes ideas from both were combined by the same writer. Collins was a pronounced necessitarian; Morgan regarded the denial of free will as tantamount to atheism. And nothing can be more misleading than to assume that the belief in a Creator, existent wholly apart from the work of his hands, was characteristic of the deists as a body. In none of them is any theory on the subject specially prominent, except that in their denial of miracles, of supernatural revelation, and a special redemptive interposition of God in history, they seem to have thought of providence much as the mass of their opponents did. Herbert starts his chief theological work with the design of vindicating God's providence. Shaftesbury vigorously protests against the notion of a wholly transcendent God. Morgan more than once expresses a theory that would now be pronounced one of immanence. Toland, the inventor of the name of pantheism, was notoriously, for a great part of his life, in some sort a pantheist. And while as thinkers they diverged in their opinions, so too they differed radically in character, in reverence for their subject and in religious earnestness and moral worth.

The deists were not powerful writers; none of them was distinguished by wide and accurate scholarship; hardly any was either a deep or comprehensive thinker. But though they generally had the best scholarship of England against them, they were bold, acute, well-informed men; they appreciated more fully than their contemporaries not a few truths now all but universally accepted; and they seemed therefore entitled to leave their mark on subsequent theological thought. Yet while the seed they sowed was taking deep root in France and in Germany, the English deists, the most notable men of their time, were soon forgotten, or at least ceased to be a prominent factor in the intellectual life of the century. The controversies they had provoked collapsed, and deism became a by-word even amongst those who were in no degree anxious to appear as champions of orthodoxy.

The fault was not wholly in the subjectivism of the movement. But the subjectivism that founded its theology on the "common sense" of the individual was accompanied by a fatal pseudo-universalism which, cutting away all that was peculiar, individual and most intense in all religions, left in any one of them but a lifeless form. A theology consisting of a few vague generalities was sufficient to sustain the piety of the best of the deists; but it had not the concreteness or intensity necessary to take a firm hold on those whom it emancipated from the old beliefs. The negative side of deism came to the front, and, communicated with fatal facility, seems ultimately to have constituted the deism that was commonly professed at the clubs of the wits and the tea-tables of polite society. But the intenser religious life before which deism fell was also a revolt against the abstract and argumentative orthodoxy of the time.

That the deists appreciated fully the scope of difficulties in Christian theology and the sacred books is not their most noteworthy feature; but that they made a stand, sometimes cautiously, often with outspoken fearlessness, against the presupposition that the Bible is the religion of Protestants. They themselves gave way to another presupposition equally fatal to true historical research, though in great measure common to them and their opponents. It was assumed by deists in

debating against the orthodox, that the flood of error in the hostile camp was due to the benevolent cunning or deliberate self-seeking of unscrupulous men, supported by the ignorant with the obstinacy of prejudice.

Yet deism deserves to be remembered as a strenuous protest against bibliolatry in every degree and against all traditionalism in theology. It sought to look not a few facts full in the face, from a new point of view and with a thoroughly modern though unhistorical spirit. It was not a religious movement; and though, as a defiance of the accepted theology, its character was mainly theological, the deistical crusade belongs, not to the history of the church, or of dogma, but to the history of general culture. It was an attitude of mind, not a body of doctrine; its nearest parallel is probably to be found in the eclectic strivings of the Renaissance philosophy and the modernizing tendencies of cisalpine humanism. The controversy was assumed to be against prejudice, ignorance, obscurantism; what monks were to Erasmus the clergy as such were to Woolston. Yet English deism was in many ways characteristically English. The deists were, as usually happens with the leaders of English thought, no class of professional men, but represented every rank in the community. They made their appeal in the mother tongue to all men who could read and think, and sought to reduce the controversy to its most direct practical issue. And, with but one or two exceptions, they avoided wildness in their language as much as in the general scheme of theology they proposed. If at times they had recourse to ambiguity of speech and veiled polemic, this might be partly excused when we remember the hanging of Thomas Aikenhead in 1697 for ridiculing the Bible, and Woolston's imprisonment in 1729.

French deism, the direct progeny of the English movement, was equally short-lived. Voltaire during his three years' residence in England (1726-1729) absorbed an enthusiasm for freedom of thought, and provided himself with the arguments necessary to support the deism which he had learned in his youth; he was to the end a deist of the school of Bolingbroke. Rousseau, though not an active assailant of Christianity, could have claimed kindred with the nobler deists. Diderot was for a time heartily in sympathy with deistic thought; and the *Encyclopédie* was in its earlier portion an organ of deism. Even in the Roman Catholic Church a large number of the leading divines were frankly deistic, nor were they for that reason regarded as irreligious. But as Locke's philosophy became in France sensationalism, and as Locke's pregnant question, reiterated by Collins, how we know that the divine power might not confer thought on matter, led the way to dogmatic materialism, so deism soon gave way to forms of thought more directly and completely subversive of the traditional theology. None the less it is unquestionable that in the period preceding the Revolution the bulk of French thinkers were ultimately deists in various degrees, and that deism was a most potent factor not only in speculative but also in social and political development. Many of the leaders of the revolutionary movement were deists, though it is quite false to say that the extreme methods of the movement were the result of widespread rationalism.

In Germany there was a native free-thinking theology nearly contemporary with that of England, whence it was greatly developed and supplemented. Among the earliest names are those of Georg Schade (1712-1795), J. B. Basedow (1723-1790), the educationist, Johann August Eberhard (*q.v.*); and K. F. Bahrdt, who regarded Christ as merely a noble teacher like Moses, Confucius and Luther. The compact rational philosophy of Wolff nourished a theological rationalism which in H. S. Reimarus was wholly undistinguishable from dogmatic deism, and was undoubtedly to a great extent adopted by Lessing; while, in the case of the historico-critical school to which J. S. Semler belonged, the distinction is not always easily drawn—although these rationalists professedly recognized in Scripture a real divine revelation, mingled with local and temporary elements. It deserves to be noted here that the former, the theology of the *Aufklärung*, was, like that of the deists, destined to a short-lived notoriety; whereas the solid, accurate and scholarly researches

of the rationalist critics of Germany, undertaken with no merely polemical spirit, not only form an epoch in the history of theology, but have taken a permanent place in the body of theological science. Ere *rationalismus vulgaris* fell before the combined assault of Schleiermacher's subjective theology and the deeper historical insight of the Hegelians, it had found a refuge successively in the Kantian postulates of the practical reason, and in the vague but earnest faith-philosophy of Jacobi.

Outside France, Germany and England, there were no great schools of thought distinctively deistic, though in most countries there is to be found a rationalistic anti-clerical movement which partakes of the character of deism. It seems probable, for example, that in Portugal the marquis de Pombal was in reality a deist, and both in Italy and in Spain there were signs of the same rationalistic revolt. More certain, and also more striking, is the fact that the leading statesmen in the American War of Independence were emphatically deists; Benjamin Franklin (who attributes his position to the study of Shaftesbury and Collins), Thomas Paine, Washington and Jefferson, although they all had the greatest admiration for the New Testament story, denied that it was based on any supernatural revelation. For various reasons the movement in America did not appear on the surface to any great extent, and after the comparative failure of Elihu Palmer's *Principles of Nature* it expressed itself chiefly in the spread of Unitarianism.

In England, though the deists were forgotten, their spirit was not wholly dead. For men like Hume and Gibbon the standpoint of deism was long left behind; yet Gibbon's famous two chapters might well have been written by a deist. Even now many undoubtedly cling to a theology nearly allied to deism. Rejecting miracles and denying the infallibility of Scripture, protesting against Calvinistic views of sovereign grace and having no interest in evangelical Arminianism, the faith of such inquirers seems fairly to coincide with that of the deists. Even some cultured theologians, the historical representatives of latitudinarianism, seem to accept the great body of what was contended for by the deists. Moreover, the influence of the deistic writers had an incalculable influence in the gradual progress towards tolerance, and in the spread of a broader attitude towards intellectual problems, and this too, though, as we have seen, the original deists devoted themselves mainly to a crusade against the doctrine of revelation.

The original deists displayed a singular incapacity to understand the true conditions of history; yet amongst them there were some who pointed the way to the truer, more generous interpretation of the past. When Shaftesbury wrote that "religion is still a discipline, and progress of the soul towards perfection," he gave birth to the same thought that was afterwards hailed in Lessing's *Erziehung des Menschengeschlechtes* as the dawn of a fuller and a purer light on the history of religion and on the development of the spiritual life of mankind.

**AUTHORITIES.**—See John Leland, *A View of the Principal Deistical Writers* (2 vols., 1754-1756; ed. 1837); G. V. Lechler, *Geschichte des englischen Deismus* (2 vols., 1841); L. Noack, *Die Freidenker in der Religion* (Bern, 1853-1855); John Hunt, *Religious Thought in England* (3 vols., 1870-1872); Leslie Stephen, *History of English Thought in the 18th Century* (2 vols., 1876); A. S. Farrar, *A Critical History of Free Thought* (1862, Bampton Lectures); J. H. Overton and F. Relton, *The English Church from the Accession of George I. to the end of the 18th Century* (1906; especially chap. iv., "The Answer to Deism"); A. W. Benn, *History of English Rationalism in the 19th Century* (1906); i. 111 ff.; J. M. Robertson, *Short History of Free Thought* (1906); G. Ch. B. Pünjer, *Geschichte der christlichen Religionsphilosophie seit der Reformation* (Brunswick, 1880); M. W. Wiseman, *Dynamics of Religion* (London, 1897), pt. ii.; article "Deismus" in Herzog-Hauck, *Realencyklopädie* (vol. iv., 1898).

**DEISTER**, a chain of hills in Germany, in the Prussian province of Hanover, about 15 m. S.W. of the city of Hanover. It runs in a north-westerly direction from Springe in the S. to Rodenberg in the N. It has a total length of 14 m., and rises in the Höfeler to a height of 1250 ft. The chain is well-wooded and abounds in game. There are some coal mines and sandstone quarries.

**DÉJAZET, PAULINE VIRGINIE** (1798-1875), French actress, born in Paris on the 30th of August 1798, made her first appearance on the stage at the age of five. It was not until 1820, when she began her seven years' connexion with the recently founded Gymnase, that she won her triumphs in soubrette and "breeches" parts, which came to be known as "*Déjazets*." From 1828 she played at the Nouveautés for three years, then at the Variétés, and finally became manager, with her son, of the Folies, which was renamed the Théâtre Déjazet. Here, even at the age of sixty-five, she had marvellous success in youthful parts, especially in a number of Sardou's earlier plays, previously unacted. She retired in 1868, and died on the 1st of December 1875, leaving a great name in the annals of the French stage.

See Duval's *Virginie Déjazet* (1876).

**DE KALB**, a city of De Kalb county, Illinois, U.S.A., in the N. part of the state, about 58 m. W. of Chicago. Pop. (1890) 2579; (1900) 5904 (1520 foreign-born); (1910) 8102. De Kalb is served by the Chicago Great Western, the Chicago & North-Western, and the Illinois, Iowa & Minnesota railways, and by interurban electric lines. It is the seat of the Northern Illinois state normal school (opened in 1899). The principal manufactures of De Kalb are woven and barbed wire, waggons and agricultural implements, pianos, shoes, gloves, and creamery packages. The city has important dairy interests also. De Kalb was first settled in 1832, was known as Buena Vista until 1840, was incorporated as a village in 1861, and in 1877 was organized under the general state law as a city.

**DE KEYSER, THOMAS** (1596 or 1597-1667), Dutch painter, was born at Amsterdam, the son of the architect and sculptor Hendrik de Keyser. We have no definite knowledge of his training, and but scant information as to the course of his life, though it is known that he owned a basalt business between 1640 and 1654. Aert Pietersz, Cornelis vanider Voort, Werner van Valckert and Nicolas Elias are accredited by different authorities with having developed his talent; and M. Karl Woermann, who has pronounced in favour of Nicolas Elias is supported by the fact that almost all that master's pictures were formerly attributed to De Keyser, who, in like fashion, exercised some influence upon Rembrandt when he first went to Amsterdam in 1631. De Keyser chiefly excelled as a portrait painter, though he also executed some historical and mythological pictures, such as the "Theseus" and "Ariadne" in the Amsterdam town hall. His portraiture is full of character and mastery in handling, and often, as in the "Old Woman" of the Budapest gallery, is distinguished by a rich golden glow of colour and Rembrandt-esque chiaroscuro. Some of his portraits are life-size, but the artist generally preferred to keep them on a considerably smaller scale, like the famous "Group of Amsterdam Burgomasters" assembled to receive Marie de' Medici in 1638, now at the Hague museum. The sketch for this important painting, together with three other drawings, was sold at the Gallitzin sale in 1783 for the sum of threepence. The German emperor owns an "Equestrian Portrait of a young Dutchman," by De Keyser, a late work which in general disposition and in the soft manner of painting recalled the work of Cuypp. Similar pictures are in the Dresden and Frankfort museums, in the Heyl collection at Worms, and the Liechtenstein Gallery in Vienna. The National Gallery, London, owns a characteristic portrait group of a "Merchant with his Clerk"; the Hague museum, besides the group already referred to, a magnificent "Portrait of a Savant," and the Haarlem museum a fine portrait of "Claes Fabricius." At the Ryks Museum in Amsterdam there are no fewer than twelve works from his brush, and other important examples are to be found in Brussels, Munich, Copenhagen and St Petersburg.

**DEKKER, EDWARD DOUWES** (1820-1887), Dutch writer, commonly known as **MULTATULI**, was born at Amsterdam on the 2nd of March 1820. His father, a ship's captain, intended his son for trade, but this humdrum prospect disgusted him, and in 1838 he went out to Java, and obtained a post in the Inland Revenue. He rose from one position to another, until, in 1851, he found himself assistant-resident at Amboyna, in the Moluccas. In 1857

he was transferred to Lebak, in the Bantam residency of Java. By this time, however, all the secrets of Dutch administration were known to him, and he had begun to protest against the abuses of the colonial system. In consequence he was threatened with dismissal from his office for his openness of speech, and, throwing up his appointment, he returned to Holland in a state of fierce indignation. He determined to expose in detail the scandals he had witnessed, and he began to do so in newspaper articles and pamphlets. Little notice, however, was taken of his protestations until, in 1860, he published, under the pseudonym of "Multatuli," his romance entitled *Max Havelaar*. An attempt was made to ignore this brilliant and irregular book, but in vain; it was read all over Europe. The exposure of the abuse of free labour in the Dutch Indies was complete, although there were not wanting apologists who accused Dekker's terrible picture of being over-coloured. He was now fairly launched on literature, and he lost no time in publishing *Love Letters* (1861), which, in spite of their mild title, proved to be mordant satires of the most rancorous and unsparing kind. The literary merit of Multatuli's work was much contested; he received an unexpected and most valuable ally in Vosmaer. He continued to write much, and to faggot his miscellanies in uniform volumes called *Ideas*, of which seven appeared between 1862 and 1877. Douwes quitted Holland, shaking off her dust from his feet, and went to live at Wiesbaden. He now made several attempts to gain the stage, and one of his pieces, *The School for Princes*, 1875 (published in the fourth volume of *Ideas*), pleased himself so highly that he is said to have styled it the greatest drama ever written. It is a fine poem, written in blank verse, like an English tragedy, and not in Dutch Alexandrines; but it is undramatic, and has not held the boards. Douwes Dekker moved his residence to Nieder Ingelheim, on the Rhine, and there he died on the 19th of February 1887.

Towards the end of his career he was the centre of a crowd of disciples and imitators, who did his reputation no service; he is now, again, in danger of being read too little. To understand his fame, it is necessary to remember the sensational way in which he broke into the dulness of Dutch literature fifty years ago, like a flame out of the Far East. He was ardent, provocative, perhaps a little hysterical, but he made himself heard all over Europe. He brought an exceedingly severe indictment against the egotism and brutality of the administrators of Dutch India, and he framed it in a literary form which was brilliantly original. Not satisfied with this, he attacked, in a fury that was sometimes blind, everything that seemed to him falsely conventional in Dutch religion, government, society and morals. He respected nothing, he left no institution untouched. Now that it is possible to look back upon Multatuli without passion, we see in him, not what Dutch enthusiasm saw,—“the second writer of Europe in the nineteenth century” (Victor Hugo being presumably the first),—but a great man who was a powerful and glowing author, yet hardly an artist, a reckless enthusiast, who was inspired by indignation and a burning sense of justice, who cared little for his means if only he could produce his effect. He is seen to his best and worst in *Max Havelaar*; his *Ideas*, hard, fantastic and sardonic, seldom offer any solid satisfaction to the foreign reader. But Multatuli deserves remembrance, if only on account of the unequalled effect his writing had in rousing Holland from the intellectual and moral lethargy in which she lay half a century ago. (E. G.)

**DEKKER, JEREMIAS DE** (1610-1666), Dutch poet, was born at Dort in 1610. His father was a native of Antwerp, who, having embraced the reformed religion, had been compelled to take refuge in Holland. Entering his father's business at an early age, he found leisure to cultivate his taste for literature and especially for poetry, and to acquire without assistance a competent knowledge of English, French, Latin and Italian. His first poem was a paraphrase of the Lamentations of Jeremiah (*Klaagliedern van Jeremias*), which was followed by translations and imitations of Horace, Juvenal and other Latin poets. The most important of his original poems were a collection of epigrams (*Puntdichten*) and a satire in praise of avarice (*Lof der Geldzucht*). The latter is his best-known work. Written in a vein of light and



yet effective irony, it is usually ranked by critics along with Erasmus's *Praise of Folly*. Dekker died at Amsterdam in November 1666.

A complete collection of his poems, edited by Brouerius van Nideck, was published at Amsterdam in 1726 under the title *Exercices poetiques* (2 vols. 4to.). Selections from his poems are included in Siegenbeck's *Proeven van nederduitsche Dichtkunde* (1823), and from his epigrams in Geijsbeek's *Epigrammatische Anthologie* (1827).

**DEKKER** (or **DECKER**), **THOMAS** (c. 1570-1641), English dramatist, was born in London. His name occurs frequently in Henslowe's *Diary* during the last three years of the 16th century; he is mentioned there as receiving loans and payments for writing plays in conjunction with Ben Jonson, Drayton, Chettle, Haughton, Wilson, Day and others, and he would appear to have been then in the most active employment as a playwright. The titles of the plays on which he was engaged from April 1599 to March 1599/1600 are *Troilus and Cressida*, *Orestes Fures*, *Agamemnon*, *The Gentle Craft*, *The Stepmother's Tragedy*, *Bear a Brain*, *Page of Plymouth*, *Robert the Second*, *The Whole History of Fortunatus*, *Patient Grissel*, *Truth's Supplication to Candlelight*, *The Spanish Moor's Tragedy*, *The Seven Wise Masters*. At that date it is evident that Dekker's services were in great request for the stage. He is first mentioned in the *Diary* under date 8th of January 1597/1598, as having sold a book, i.e. the manuscript of a play; the payments in 1599 are generally made in advance, "in earnest" of work to be done. In the case of three of the above plays, *Orestes Fures*, *Truth's Supplication* and *The Gentle Craft*, Dekker is paid as the sole author. Only *The Gentle Craft* has been preserved; it was published anonymously in 1600 under the title of *The Shoemaker's Holiday*. It would be unsafe to argue from the classical subjects of some of these plays that Dekker was then a young man from the university, who had come up like so many others to make a living by writing for the stage. Classical knowledge was then in the air; playwrights in want of a subject were content with translations, if they did not know the originals. However educated, Dekker was then a young man just out of his teens, if he spoke with any accuracy when he said that he was threescore in 1637. And it was not in scholarly themes that he was destined to find his true vein. The call for the publication of *The Gentle Craft*, which deals with the life of the city, showed him where his strength lay.

To give a general idea of the substance of Dekker's plays, there is no better way than to call him the Dickens of the Elizabethan period. The two men were as unlike as possible in their habits of work, Dekker having apparently all the thriftlessness and impecunious shamelessness of Micawber himself. Henslowe's *Diary* contains two notes of payments made in 1597/1598 and 1598/1599 to release Dekker from prison, and he is supposed to have spent the years between 1613 and 1616 in the King's Bench. Dekker's Bohemianism appears in the slightness and hurry of his work, a strong contrast to the thoroughness and rich completeness of every labour to which Dickens applied himself; perhaps also in the exquisite freshness and sweetness of his songs, and the natural charm of stray touches of expression and description in his plays. But he was like Dickens in the bent of his genius towards the representation of the life around him in London, as well as in the humorous kindness of his way of looking at that life, his vein of sentiment, and his eye for odd characters, though the random pickings of Dekker, hopping here and there in search of a subject, give less complete results than the more systematic labours of Dickens. Dekker's Simon Eyre, the good-hearted, mad shoemaker, and his Orlando Friscobaldo, are touched with a kindly humour in which Dickens would have delighted; his Infelices, Fiamettas, Tormiellas, even his Bellafront, have a certain likeness in type to the heroines of Dickens; and his roaring blades and their gulls are prototypes of Sir Mulberry Hawk and Lord Frederick Verisopht. Only there is this great difference in the spirit of the two writers, that Dekker wrote without the smallest apparent wish to reform the life that he saw, desiring only to exhibit it; and that on the whole, apart from his dramatist's necessity of finding interesting matter, he cast his eye about rather with a liking for the discovery of good under unpromising

appearances than with any determination to detect and expose vice. The observation must also be made that Dekker's personages have much more individual character, more of that mixture of good and evil which we find in real human beings. Hack-writer though Dekker was, and writing often under sore pressure, there is no dramatist whose personages have more of the breath of life in them; drawing with easy, unconstrained hand, he was a master of those touches by which an imaginary figure is brought home to us as a creature with human interests. A very large part of the motive power in his plays consists in the temporary yielding to an evil passion. The kindly philosophy that the best of natures may be for a time perverted by passionate desires is the chief animating principle of his comedy. He delights in showing women listening to temptation, and apparently yielding, but still retaining sufficient control over themselves to be capable of drawing back when on the verge of the precipice. The wives of the citizens were his heroines, pursued by the unlawful addresses of the gay young courtiers; and on the whole Dekker, from inclination apparently as well as policy, though himself, if Ben Jonson's satire had any point, a bit of a dandy in his youth, took the part of morality and the city, and either struck the rakes with remorse or made the objects of their machinations clever enough to outwit them. From Dekker's plays we get a very lively impression of all that was picturesque and theatrically interesting in the city life of the time, the interiors of the shops and the houses, the tastes of the citizens and their wives, the tavern and tobacco-shop manners of the youthful aristocracy and their satellites. The social student cannot afford to overlook Dekker; there is no other dramatist of that age, except Thomas Middleton, from whom we can get such a vivid picture of contemporary manners in London. He drew direct from life; in so far as he idealized, he did so not in obedience to scholarly precepts or dogmatic theories, but in the immediate interests of good-natured farce and tender-hearted sentiment.

In all the serious parts of Dekker's plays there is a charming delicacy of touch, and his smallest scraps of song are bewitching; but his plays, as plays, owe much more to the interest of the characters and the incidents than to any excellence of construction. We see what use could be made of his materials by a stronger intellect in *Westward Ho!* which he wrote in conjunction with John Webster. The play, somehow, though the parts are more firmly knit together, and it has more unity of purpose, is not so interesting as Dekker's unaided work. Middleton formed a more successful combination with Dekker than Webster; there is some evidence that in *The Honest Whore*, or *The Converted Courtesan*, which is generally regarded as the best that bears Dekker's name, he had the assistance of Middleton, although the assistance was so immaterial as not to be worth acknowledging in the title-page. Still that Middleton, a man of little genius but of much practical talent and robust humour, was serviceable to Dekker in determining the form of the play may well be believed. The two wrote another play in concert, *The Roaring Girl*, for which Middleton probably contributed a good deal of the matter, as well as a more symmetrical form than Dekker seems to have been capable of devising. In *The Witch of Edmonton*, except in a few scenes, it is difficult to trace the hand of Dekker with any certainty; his collaborators were John Ford and William Rowley; to Ford probably belongs the intense brooding and murderous wrath of the old hag, which are too direct and hard in their energy for Dekker, while Rowley may be supposed to be responsible for the delineation of country life. *The Virgin Martyr*, one of the best constructed of his plays, was written in conjunction with Massinger, to whom the form is no doubt due. Dekker's plays contain a few songs which show him to have been possessed of very great lyrical skill, but of this he seems to have made sadly little use. His poem of *Canaan's Calamitie*—if indeed it be his, which is hard to believe—is exceedingly poor stuff, and the verse portion of his *Dreame*, though containing some good lines, is, as a whole, not much better.

When Gerard Langbaine wrote his *Account of the English Dramatic Poets* in 1691, he spoke of Dekker as being "more famous for the contention he had with Ben Jonson for the bays,

than for any great reputation he had gained by his own writings." This is an opinion that could not be professed now, when Dekker's work is read. In the contention with Ben Jonson, one of the most celebrated quarrels of authors, the origin of which is matter of dispute, Dekker seems to have had very much the best of it. We can imagine that Jonson's attack was stinging at the time, because it seems to be full of sarcastic personalities, but it is dull enough now when nobody knows what Dekker was like, nor what was the character of his mother. There is nothing in the *Poetaster* that has any point as applied to Dekker's powers as a dramatist, while, on the contrary, *Satiromastix*, or *the Untrussing of the Humorous Poet* is full of pungent ridicule of Jonson's style, and of retorts and insults conceived in the happiest spirit of good-natured mockery. Dekker has been accused of poverty of invention in adopting the character of the *Poetaster*, but it is of the very pith of the jest that Dekker should have set on Jonson's own foul-mouthed Captain Tucca to abuse Horace himself.

**WORKS.**—*The Pleasant Comedie of Old Fortunatus* (1600); *The Shoemaker's Holiday*. Or *The gentle Craft*. With the humorous life of *Simon Eyre, shoemaker, and Lord Mayor of London* (1600); *Satiromastix*. Or *The untrussing of the Humorous Poet* (1602); *The Pleasant Comedie of Patient Grissill* (1603), with Chettle and Haughton; *The Honest Whore*. With *The Humours of the Patient Man, and the Longing Wife* (1604); *North-Ward Hoe* (1607), with John Webster; *West-Ward Hoe* (1607), with John Webster; *The Whore of Babylon* (1607); *The Famous History of Sir Thomas Wyatt*. With the Coronation of *Queen Mary, and the coming in of King Philip* (1607), with John Webster; *The Roaring Girle*. Or *Moll Cut-Purse* (1611), with Thomas Middleton; *The Virgin Martyr* (1622), with Massinger; *If It Be Not Good, the Diuel is in it* (1612); *The Second Part of the Honest Whore*. With the *Humours of the Patient Man, the Impatient Wife; the Honest Whore, perswaded by strong Arguments to turne Curtisan againe; her brave refuting those Arguments. And lastly, the Comicall Passages of an Italian Bridewell, where the Scæne ends* (1630); *A Tragi-Comedy: Called, Match mee in London* (1631); *The Wonder of a Kingdome* (1636); *The Witch of Edmonton. A known true Story. Composd into a Tragi-Comedy* (1658), with William Rowley and John Ford. *The Sun's Darling* (1656) was possibly written by Ford and Dekker, or may be perhaps more correctly regarded as a recast by Ford of a masque by Dekker, perhaps his lost play of *Phæton*. The pageants for the Lord Mayor's shows of 1612 and 1629 were written by Dekker, and both are preserved. His tracts are invaluable for the light which they throw on the London of his time, especially in their descriptions of the circumstances of the theatre. Their titles, many of which are necessarily abbreviated, are: *Canaans Calamitie, Jerusalems Miserie, and Englands Mirror* (1598), in verse; *The Wonderfull Year 1603. Wherein is shewed the picture of London lying sicke of the Plague* (1603); *The Batchelars Banquet* (1603); a brilliant adaptation of *Les Quinze Joyes de mariage; the Seven Deadly Sinnes of London* (1606); *Newes from Hell; Brought by the Divells Carrier* (1606), reprinted in the next year with some interesting additions as *A Knights Conjuring; Jestis to make you Merie* (1607), with George Wilkins; *The Belman of London: Bringing to Light the most notorious villanies that are now practised in the Kingdome* (1608); followed by a second part and enlarged editions under other titles; *The Dead Tearme* (1608); *The Ravens Almanacke, foretelling of a Plague, Famine and Civill Warre* (1609), ridiculing the almanac makers; *The Guls Horne-booke* (1609), the most famous of all his tracts, providing a code of manners for the Elizabethan gallant, in the aisle of St Paul's, at the ordinary, at the playhouse, and other resorts; *Worke for Armourours, or the Peace is Broken* (1609); *Foure Birds of Noahs Ark* (1609); *A Strange Horse-Race* (1613); *Dekker his Dreame* . . . (1620), in verse and prose, illustrated with a woodcut of the dreamer; and *A Rod for Run-awayes* (1625). This long list does not exhaust Dekker's work, much of which is lost.

**AUTHORITIES.**—An edition of the collected dramatic works of Dekker by R. H. Shepherd appeared in 1873; his prose tracts and poems were included in Dr A. B. Grosart's *Huth Library* (1884–1886): both these contain memoirs of him, but by far the most complete account of his life and writings is to be found in the article by A. H. Bullen in the *Dictionary of National Biography*. See also the elaborate discussion of his plays in Mr Fleay's *Biographical Chronicle* (1891), i. 115, &c., and, for his quarrel with Ben Jonson, Prof. J. H. Penniman's *War of the Theatres* (Boston, 1897) and Mr R. A. Small's *Stage Quarrel between Ben Jonson and the so-called Poetasters* (Breslau, 1899). A selection from his plays was edited for the *Mermaid Series* (1887; new series, 1904) by Ernest Rhys. An essay on Dekker by A. C. Swinburne appeared in *The Nineteenth Century* for January 1887. (W. M.; R. B. MCK.)

**DE LA BECHE, SIR HENRY THOMAS** (1796–1855), English geologist, was born in the year 1796. His father, an officer in the army, possessed landed property in Jamaica, but died while his

son was still young. The boy accordingly spent his youth with his mother at Lyme Regis among the interesting and picturesque coast cliffs of the south-west of England, where he imbibed a love for geological pursuits and cultivated a marked artistic faculty. When fourteen years of age, being destined, like his friend Murchison, for the military profession, he entered the college at Great Marlow, where he distinguished himself by the rapidity and skill with which he executed sketches showing the salient features of a district. The peace of 1815, however, changed his career and he devoted himself with ever-increasing assiduity to the pursuit of geology. When only twenty-one years of age he joined the Geological Society of London, continuing throughout life to be one of its most active, useful and honoured members. He was president in 1848–1849. Possessing a fortune sufficient for the gratification of his tastes, he visited many localities of geological interest, not only in Britain, but also on the continent, in France and Switzerland. His journeys seldom failed to bear fruit in suggestive papers accompanied by sketches. Early attachment to the south-west of England led him back to that region, where, with enlarged experience, he began the detailed investigation of the rocks of Cornwall and Devon. Thrown much into contact with the mining community of that part of the country, he conceived the idea that the nation ought to compile a geological map of the United Kingdom, and collect and preserve specimens to illustrate, and aid in further developing, its mineral industries. He showed his skilful management of affairs by inducing the government of the day to recognize his work and give him an appointment in connexion with the Ordnance Survey. This formed the starting point of the present Geological Survey of Great Britain, which was officially recognized in 1835, when De la Beche was appointed director. Year by year increasing stores of valuable specimens were transmitted to London; and the building at Craig's Court, where the young Museum of Economic Geology was placed, became too small. But De la Beche, having seen how fruitful his first idea had become, appealed to the authorities not merely to provide a larger structure, but to widen the whole scope of the scientific establishment of which he was the head, so as to impart to it the character of a great educational institution where practical as well as theoretical instruction should be given in every branch of science necessary for the conduct of mining work. In this endeavour he was again successful. Parliament sanctioned the erection of a museum in Jermyn Street, London, and the organization of a staff of professors with laboratories and other appliances. The establishment, in which were combined the offices of the Geological Survey, the Museum of Practical Geology, The Royal School of Mines and the Mining Record Office, was opened in 1851. Many foreign countries have since formed geological surveys avowedly based upon the organization and experience of that of the United Kingdom. The British colonies, also, have in many instances established similar surveys for the development of their mineral resources, and have had recourse to the parent survey for advice and for officers to conduct the operations.

De la Beche published numerous memoirs on English geology in the *Transactions of the Geological Society of London*, as well as in the *Memoirs of the Geological Survey*, notably the *Report on the Geology of Cornwall, Devon and West Somerset* (1839). He likewise wrote *A Geological Manual* (1831; 3rd ed., 1833); and a work of singular breadth and clearness—*Researches in Theoretical Geology* (1834)—in which he enunciated a philosophical treatment of geological questions much in advance of his time. An early volume, *How to Observe Geology* (1835 and 1836), was rewritten and enlarged by him late in life, and published under the title of *The Geological Observer* (1851; 2nd ed., 1853). It was marked by wide practical experience, multifarious knowledge, philosophical insight and a genius for artistic delineation of geological phenomena. He was elected F.R.S. in 1819. He received the honour of knighthood in 1848, and near the close of his life was awarded the Wollaston medal—the highest honour in the gift of the Geological Society of London. After a life of constant activity he began to suffer from partial paralysis, but, though becoming gradually worse, continued able to transact

his official business until a few days before his death, which took place on the 13th of April 1855.

See Sir A. Geikie's *Memoir of Sir A. C. Ramsay* (1895), which contains a sketch of the history of the Geological Survey, and of the life of De la Beche (with portrait); also *Summary of Progress of the Geological Survey for 1897* (1898).

**DELABORDE, HENRI FRANÇOIS, COUNT** (1764-1833), French soldier, was the son of a baker of Dijon. At the outbreak of the French Revolution he joined the "Volunteers of the Côte-d'Or," and passing rapidly through all the junior grades, was made general of brigade after the combat of Rhein-Zabern (1793). As chief of the staff he was present at the siege of Toulon in the same year, and, promoted general of division, he was for a time governor of Corsica. In 1794 Delaborde served on the Spanish frontier, distinguishing himself at the Bidassoa (July 25) and Misquiriz (October 16). His next command was on the Rhine. At the head of a division he took part in the celebrated campaigns of 1795-97, and in 1796 covered Moreau's right when that general invaded Bavaria. Delaborde was in constant military employment during the Consulate and the early Empire. Made commander of the Legion of Honour in 1804, he received the dignity of count in 1808. In that year he was serving in Portugal under Junot. Against Sir Arthur Wellesley's English army he fought the skillful and brilliant rear-guard action of Rolica. In 1812 he was one of Mortier's divisional leaders in the Russian War, and in the following year was grand cross and governor of the castle of Compiègne. Joining Napoleon in the Hundred Days, he was marked for punishment by the returning Bourbons, sent before a court-martial, and only escaped condemnation through a technical flaw in the wording of the charge. The rest of his life was spent in retirement.

**DELACROIX, FERDINAND VICTOR EUGÈNE** (1798-1863), French historical painter, leader of the Romantic movement, was born at Charenton-St-Maurice, near Paris, on the 26th of April 1798. His father Charles Delacroix (1741-1805) was a partisan of the most violent faction during the time of the Revolution, and was foreign minister under the Directory. The family affairs seem to have been conducted in the wildest manner, and the accidents that befell the child, well authenticated as they are said to be, make it almost a miracle that he survived. He was first nearly burned to death in the cradle by a nurse falling asleep over a novel and the candle dropping on the coverlet; this left permanent marks on his arms and face. He was next dropped into the sea by another *bonne*, who was climbing up a ship's side to see her lover. He was nearly poisoned, and nearly choked, and, to crown all, he tried to hang himself, without any thought of suicide, in imitation of a print exhibiting a man in that position of final ignominy. The prediction of a charlatan founded on his horoscope has been preserved: "Cet enfant deviendra un homme célèbre, mais sa vie sera des plus laborieuses, des plus tourmentées, et toujours livrée à la contradiction."

Delacroix the elder (also known as Delacroix de Contaut) died at Bordeaux when Eugène was seven years of age, and his mother returned to Paris and placed him in the Lycée Napoléon. Afterwards, on his determining to be a painter, he entered the *atelier* of Baron Guérin, who affected to treat him as an amateur. His fellow-pupil was Ary Scheffer, who was alike by temperament and antecedents the opposite of the *bizarre* Delacroix, and the two remained antagonistic to the end of life. Delacroix's acknowledged power and yet want of success with artists and critics—Thiers being his only advocate—perhaps mainly resulted from his bravura and rude dash in the use of the brush, at a time when smooth roundness of surface was general. His first important picture, "Dante and Virgil," was painted in his own studio; and when Guérin went to see it he flew into a passion, and told him his picture was absurd, detestable, exaggerated. "Why ask me to come and see this? you knew what I must say." Yet his work was received at the Salon, and produced an enthusiasm of debate (1822). Some said Géricault had worked on it, but all treated it with respect. Still in private his position, even after the larger tragic picture, the "Massacre of Chios," had

been deposited in the Luxembourg by the government (1824), became that of an Ishmaelite. The war for the freedom of Greece then going on moved him deeply, and his next two pictures—"Marino Faliero Decapitated on the Giant's Staircase of the Ducal Palace" (which has always remained a European success), and "Greece Lamenting on the Ruins of Missolonghi"—with many smaller works, were exhibited for the benefit of the patriots in 1826. This exhibition was much visited by the public, and next year he produced another of his important works, "Sardanapalus," from Byron's drama. After this, he says, "I became the abomination of painting, I was refused water and salt,"—but, he adds with singularly happy naïveté, "J'étais enchanté de moi-même!" The patrimony he inherited, or perhaps it should be said, what remained of it, was 10,000 *livres de rente*, and with economy he lived on this, and continued the expensive process of painting large historical pictures. In 1831 he reappeared in the Salon with six works, and immediately after left for Morocco, where he found much congenial matter. Delacroix never went to Italy; he refused to go on principle, lest the old masters, either in spirit or manner, should impair his originality and self-dependence. His greatest admiration in literature was the poetry of Byron; Shakespeare also attracted him for tragic inspirations; and of course classic subjects had their turn of his easel.

He continued his work indefatigably, having his pictures very seldom favourably received at the Salon. These were sometimes very large, full of incidents, with many figures. "Drawing of Lots in the Boat at Sea," from Byron's *Don Juan*, and the "Taking of Constantinople by the Christians" were of that character, and the former was one of his noblest creations. In 1845 he was employed to decorate the library of the Luxembourg, that of the chamber of deputies in 1847, the ceiling of the gallery of Apollo in the Louvre in 1849 and that of the Salon de la Paix in the hôtel de ville in 1853. He died on the 13th of August 1863, and in August 1864 an exhibition of his works was opened on the Boulevard des Italiens. It contained 174 pictures, many of them of large dimensions, and 303 drawings, showing immense perseverance as well as energy and versatility. As a colourist, and a romantic painter, he now ranks among the greatest of French artists.

See also A. Robaut, *Delacroix* (1885); E. Dargenty, *Delacroix par lui-même* (1885); G. Moreau, *Delacroix et son œuvre* (1893); Dorothy Bussy, *Eugène Delacroix* (1907).

**DE LA GARDIE, MAGNUS GABRIEL, COUNT** (1622-1686), Swedish statesman, the best-known member of an ancient family of French origin (the D'Escouperies of Languedoc) which had been settled in Sweden since the 14th century. After a careful education, completed by the usual grand tour, Magnus learned the art of war under Gustavus Horn, and during the reign of Christina (1644-1654), whose prime favourite he became, though the liaison was innocent enough, he was raised to the highest offices in the state and loaded with distinctions. In 1646 he was sent at the head of an extraordinary mission to France, and on his return married the queen's cousin Marie Euphrosyne of Zweibrücken, who, being but a poor princess, benefited greatly by her wedding with the richest of the Swedish magnates. Immediately afterwards, De la Gardie was made a senator, governor-general of Saxony during the last stages of the Thirty Years' War, and, in 1652, lord high treasurer. In 1653 he fell into disgrace and had to withdraw from court. During the reign of Charles X. (1654-1660) he was employed in the Baltic provinces both as a civilian and a soldier, although in the latter capacity he gave the martial king but little satisfaction. Charles X. nevertheless, in his last will, appointed De la Gardie grand-chancellor and a member of the council of regency which ruled Sweden during the minority of Charles XI. (1660-1672). During this period De la Gardie was the ruling spirit of the government and represented the party of warlike adventure as opposed to the party of peace and economy led by Counts Bonde and Brahe (*qq.v.*). After a severe struggle De la Gardie's party finally prevailed, and its triumph was marked by that general decline of personal and political morality which has given to this regency its unenviable reputation.

It was De la Gardie who first made Sweden the obsequious hireling of the foreign power which had the longest purse. The beginning of this shameful "subsidy policy" was the treaty of Fontainebleau, 1661, by a secret paragraph of which Sweden, in exchange for a considerable sum of money, undertook to support the French candidate on the first vacancy of the Polish throne. It was not, however, till the 14th of April 1672 that Sweden, by the treaty of Stockholm, became a regular "mercenarius Galliae," pledging herself, in return for 400,000 *écus* per annum in peace and 600,000 in war time, to attack with 16,000 men those German princes who might be disposed to assist Holland. The early disasters of the unlucky war of 1675-1679 were rightly attributed to the carelessness, extravagance, procrastination and general incompetence of De la Gardie and his high aristocratic colleagues. In 1675 a special commission was appointed to inquire into their conduct, and on the 27th of May 1682 it decided that the regents and the senate were solely responsible for dilapidations of the realm, the compensation due by them to the crown being assessed at 4,000,000 *daler* or £500,000. De la Gardie was treated with relative leniency, but he "received permission to retire to his estates for the rest of his life" and died there in comparative poverty, a mere shadow of his former magnificent self. The best sides of his character were his brilliant social gifts and his intense devotion to literature and art.

See Martin Veibull, *Sveriges Storhetstid* (Stockholm, 1881); Sv. *Hist.* iv.; Robert Nisbet Bain, *Scandinavia* (Cambridge, 1905).

(R. N. B.)

**DELAGOA BAY** (Port. for the bay "of the lagoon"), an inlet of the Indian Ocean on the east coast of South Africa, between 25° 40' and 26° 20' S., with a length from north to south of over 70 m. and a breadth of about 20 m. The bay is the northern termination of the series of lagoons which line the coast from Saint Lucia Bay. The opening is toward the N.E. The southern part of the bay is formed by a peninsula, called the Inyak peninsula, which on its inner or western side affords safe anchorage. At its N.W. point is Port Melville. North of the peninsula is Inyak Island, and beyond it a smaller island known as Elephant's Island.

In spite of a bar at the entrance and a number of shallows within, Delagoa Bay forms a valuable harbour, accessible to large vessels at all seasons of the year. The surrounding country is low and very unhealthy, but the island of Inyak has a height of 240 ft., and is used as a sanatorium. A river 12 to 18 ft. deep, known as the Manhissa or Komati, enters the bay at its northern end; several smaller streams, the Matolla, the Umbelozis, and the Tembi, from the Lebombo Mountains, meet towards the middle of the bay in the estuary called by the Portuguese the *Espirito Santo*, but generally known as the English river; and the Maputa, which has its headwaters in the Drakensberg, enters in the south, as also does the Umfusi river. These rivers are the haunts of the hippopotamus and the crocodile.

The bay was discovered by the Portuguese navigator Antonio de Campo, one of Vasco da Gama's companions, in 1502, and the Portuguese post of Lourenço Marques was established not long after on the north side of the English river. In 1720 the Dutch East India Company built a fort and "factory" on the spot where Lourenço Marques now stands; but in 1730 the settlement was abandoned. Thereafter the Portuguese had—intermittently—trading stations in the *Espirito Santo*. These stations were protected by small forts, usually incapable, however, of withstanding attacks by the natives. In 1823 Captain (afterwards Vice-Admiral) W. F. W. Owen, of the British navy, finding that the Portuguese exercised no jurisdiction south of the settlement of Lourenço Marques, concluded treaties of cession with native chiefs, hoisted the British flag, and appropriated the country from the English river southwards; but when he visited the bay again in 1824 he found that the Portuguese, disregarding the British treaties, had concluded others with the natives, and had endeavoured (unsuccessfully) to take military possession of the country. Captain Owen rehoisted the British flag, but the sovereignty of either power was left undecided till the claims of the Transvaal Republic rendered a solution of the question

urgent. In the meantime Great Britain had taken no steps to exercise authority on the spot, while the ravages of Zulu hordes confined Portuguese authority to the limits of their fort. In 1835 Boers, under a leader named Orich, had attempted to form a settlement on the bay, which is the natural outlet for the Transvaal; and in 1868 the Transvaal president, Marthinus Pretorius, claimed the country on each side of the Maputa down to the sea. In the following year, however, the Transvaal acknowledged Portugal's sovereignty over the bay. In 1861 Captain Bickford, R.N., had declared Inyak and Elephant islands British territory; an act protested against by the Lisbon authorities. In 1872 the dispute between Great Britain and Portugal was submitted to the arbitration of M. Thiers, the French president; and on the 19th of April 1875 his successor, Marshal MacMahon, declared in favour of the Portuguese. It had been previously agreed by Great Britain and Portugal that the right of pre-emption in case of sale or cession should be given to the unsuccessful claimant to the bay. Portuguese authority over the interior was not established until some time after the MacMahon award; nominally the country south of the Manhissa river was ceded to them by the Matshangana chief Umzila in 1861. In 1889 another dispute arose between Portugal and Great Britain in consequence of the seizure by the Portuguese of the railway running from the bay to the Transvaal. This dispute was referred to arbitration, and in 1900 Portugal was condemned to pay nearly £1,000,000 in compensation to the shareholders in the railway company. (See LOURENÇO MARQUES and GAZALAND.)

For an account of the Delagoa Bay arbitration proceedings see Sir E. Hertslet, *The Map of Africa by Treaty*, iii. 991-998 (London, 1909). Consult also the British blue-book, *Delagoa Bay, Correspondence respecting the Claims of Her Majesty's Government* (London, 1875); L. van Deventer, *La Hollande et la Baie Delagoa* (The Hague, 1883); G. McC. Theal, *The Portuguese in South Africa* (London, 1896), and *History of South Africa since September 1795*, vol. v. (London, 1908). *The Narrative of Voyages to explore the shores of Africa . . . performed . . . under direction of Captain W. F. W. Owen, R.N.* (London, 1833) contains much interesting information concerning the district in the early part of the 19th century.

**DELAMBRE, JEAN BAPTISTE JOSEPH** (1749-1822), French astronomer, was born at Amiens on the 19th of September 1749. His college course, begun at Amiens under the abbé Jacques Deille, was finished in Paris, where he took a scholarship at the college of Plessis. Despite extreme penury, he then continued to study indefatigably ancient and modern languages, history and literature, finally turning his attention to mathematics and astronomy. In 1771 he became tutor to the son of M. d'Assy, receiver-general of finances; and while acting in this capacity, attended the lectures of J. J. Lalande, who, struck with his remarkable acquirements, induced M. d'Assy in 1788 to install an observatory for his benefit at his own residence. Here Delambre observed and computed almost uninterruptedly, and in 1790 obtained for his Tables of Uranus the prize offered by the academy of sciences, of which body he was elected a member two years later. He was admitted to the Institute on its organization in 1795, and became, in 1803, perpetual secretary to its mathematical section. He, moreover, belonged from 1795 to the bureau of longitudes. From 1792 to 1799 he was occupied with the measurement of the arc of the meridian extending from Dunkirk to Barcelona, and published a detailed account of the operations in *Base du système métrique* (3 vols., 1806, 1807, 1810), for which he was awarded in 1810 the decennial prize of the Institute. The first consul nominated him inspector-general of studies; he succeeded Lalande in 1807 as professor of astronomy at the Collège de France, and filled the office of treasurer to the imperial university from 1808 until its suppression in 1815. Delambre died at Paris on the 19th of August 1822. His last years were devoted to researches into the history of science, resulting in the successive publication of: *Histoire de l'astronomie ancienne* (2 vols., 1817); *Histoire de l'astronomie au moyen âge* (1819); *Histoire de l'astronomie moderne* (2 vols., 1821); and *Histoire de l'astronomie au XVIII<sup>e</sup> siècle*, issued in 1827 under the care of C. L. Mathieu. These books show marvellous erudition; but some of the judgments expressed in them are warped by prejudice; they are diffuse in style and overloaded with

computations. He wrote besides: *Tables éclipiques des satellites de Jupiter*, inserted in the third edition of J. J. Lalande's *Astronomie* (1792), and republished in an improved form by the bureau of longitudes in 1817; *Méthodes analytiques pour la détermination d'un arc du méridien* (1799); *Tables du soleil (publiées par le bureau des longitudes)* (1806); *Rapport historique sur les progrès des sciences mathématiques depuis l'an 1789* (1810); *Abrégé d'astronomie* (1813); *Astronomie théorique et pratique* (1814); &c.

See J. B. J. Fourier's "Éloge" in *Mémoires de l'acad. des sciences*, t. iv.; Ch. Dupin, *Revue encyclopédique*, t. xvi. (1822); *Biog. universelle*, t. lxiii. (C. L. Mathieu); Max. Marie, *Hist. des sciences*, x. 31; R. Grant, *Hist. of Physical Astr.* pp. 96, 142, 165; R. Wolf, *Geschichte der Astronomie*, p. 779, &c. (A. M. C.)

**DELAMERE** (OF DE LA MER), **GEORGE BOOTH**, 1st BARON (1622-1684), son of William Booth, a member of an ancient family settled at Dunham Massey in Cheshire, and of Vere, daughter and co-heir of Sir Thomas Egerton, was born in August 1622. He took an active part in the Civil War with his grandfather, Sir George Booth, on the parliamentary side. He was returned for Cheshire to the Long Parliament in 1645 and to Cromwell's parliaments of 1654 and 1656. In 1655 he was appointed military commissioner for Cheshire and treasurer at war. He was one of the excluded members who tried and failed to regain their seats after the fall of Richard Cromwell in 1659. He had for some time been regarded by the royalists as a well-wisher to their cause, and was described to the king in May 1659 as "very considerable in his country, a presbyterian in opinion, yet so moral a man . . . I think your Majesty may safely [rely] on him and his promises which are considerable and hearty."<sup>1</sup> He now became one of the chief leaders of the new "royalists" who at this time united with the cavaliers to effect the restoration. A rising was arranged for the 5th of August in several districts, and Booth took charge of operations in Cheshire, Lancashire and North Wales. He got possession of Chester on the 19th, issued a proclamation declaring that arms had been taken up "in vindication of the freedom of parliament, of the known laws, liberty and property," and marched towards York. The plot, however, was known to Thurloe. It had entirely failed in other parts of the country, and Lambert advancing with his forces defeated Booth's men at Nantwich Bridge. Booth himself escaped disguised as a woman, but was discovered at Newport Pagnell on the 23rd in the act of shaving, and was imprisoned in the Tower. He was, however, soon liberated, took his seat in the parliament of 1659-1660, and was one of the twelve members deputed to carry the message of the Commons to Charles II. at the Hague. In July 1660 he received a grant of £10,000, having refused the larger sum of £20,000 at first offered to him, and on the 20th of April 1661, on the occasion of the coronation, he was created Baron Delamere, with a licence to create six new knights. The same year he was appointed *custos rotulorum* of Cheshire. In later years he showed himself strongly antagonistic to the reactionary policy of the government. He died on the 8th of August 1684, and was buried at Bowdon. He married (1) Lady Catherine Clinton, daughter and co-heir of Theophilus, 4th earl of Lincoln, by whom he had one daughter; and (2) Lady Elizabeth Grey, daughter of Henry, 1st earl of Stamford, by whom, besides five daughters, he had seven sons, the second of whom, Henry, succeeded him in the title and estates and was created earl of Warrington. The earldom became extinct on the death of the latter's son, the 2nd earl, without male issue, in 1758, and the barony of Delamere terminated in the person of the 4th baron in 1770; the title was revived in 1821 in the Cholmondeley family.

**DE LAND**, a town and the county-seat of Volusia county, Florida, U.S.A., 111 m. by rail S. of Jacksonville, 20 m. from the Atlantic coast and 4 m. from the St John's river. Pop. (1890) 1113; (1900) 1449. De Land is served by the Atlantic Coast Line and by steamboats on the St John's river. It has a fine winter climate, with an average temperature of 60° F., has sulphur springs, and is a health and winter resort. There is a

<sup>1</sup> Clarendon, *State Papers*, iii. 472.

starch factory here; and the surrounding country is devoted to fruit-growing. De Land is the seat of the John B. Stetson University (coeducational), an undenominational institution under Baptist control, founded in 1884, as an academy, by Henry A. De Land, a manufacturer of Fairport, New York, and in 1887 incorporated under the name of De Land University, which was changed in 1889 to the present name, in honour of John Batterson Stetson (1830-1906), a Philadelphia manufacturer of hats, who during his life gave nearly \$500,000 to the institution. The university includes a college of liberal arts, a department of law, a school of technology, an academy, a normal school, a model school, a business college and a school of music. De Land was founded in 1876 by H. A. De Land, above mentioned, who built a public school here in 1877 and a high school in 1883.

**DELANE, JOHN THADEUS** (1817-1879), editor of *The Times* (London), was born on the 11th of October 1817 in London. He was the second son of Mr W. F. A. Delane, a barrister, of an old Irish family, who about 1832 was appointed by Mr Walter financial manager of *The Times*. While still a boy he attracted Mr Walter's attention, and it was always intended that he should find work on the paper. He received a good general education at private schools and King's College, London, and also at Magdalen Hall, Oxford; after taking his degree in 1840 he at once began work on the paper, though later he read for the bar, being called in 1847. In 1841 he succeeded Thomas Barnes as editor, a post which he occupied for thirty-six years. He from the first obtained the best introductions into society and the chief political circles, and had a position there such as no journalist had previously enjoyed, using his opportunities with a sure intuition for the way in which events would move. His staff included some of the most brilliant men of the day, who worked together with a common ideal. The result to the paper, which in those days had hardly any real competitor in English journalism, was an excellence of information which gave it great power. (See *NEWSPAPERS*.) Delane was a man of many interests and great judgment; capable of long application and concentrated attention, with power to seize always on the main point at issue, and rapidly master the essential facts in the most complicated affair. His general policy was to keep the paper a national organ of opinion above party, but with a tendency to sympathize with the Liberal movements of the day. He admired Palmerston and respected Lord Aberdeen, and was of considerable use to both; and it was Lord Aberdeen himself who, in 1845, told him of the impending repeal of the Corn Laws, an incident round which many incorrect stories have gathered. The history, however, of the events during the thirteen administrations, between 1841 and 1877, in which *The Times*, and therefore Delane, played an important part cannot here be recapitulated. In 1877 his health gave way, and he retired from the editorship; and on the 22nd of November 1879 he died at Ascot.

A biography by his nephew, Arthur Irwin Dasent, was published in 1908.

**DELANY, MARY GRANVILLE** (1700-1788), an English-woman of literary tastes, was born at Coulston, Wilts, on the 14th of May 1700. She was a niece of the 1st Lord Lansdowne. In 1717 or 1718 she was unhappily married to Alexander Pendarves, a rich old Cornish landowner, who died in 1724. During a visit to Ireland she met Dean Swift and his intimate friend, the Irish divine, Patrick Delany, whose second wife she became in 1743. After his death in 1768 she passed all her summers with her bosom friend the dowager duchess of Portland—Prior's "Peggy"—and when the latter died George III. and Queen Charlotte, whose affection for their "dearest Mrs Delany" seems to have been most genuine, gave her a small house at Windsor and a pension of £300 a year. Fanny Burney (Madame D'Arbly) was introduced to her in 1783, and frequently visited her at her London home and at Windsor, and owed to her friendship her court appointment. At this time Mrs Delany was a charming and sweet old lady, with a reputation for cutting out and making the ingenious "paper mosaiks" now in the British Museum; she had known every one worth knowing in her day,



had corresponded with Swift and Young, and left an interesting picture of the polite but commonplace English society of the 18th century in her six volumes of *Autobiography and Letters*. Burke calls her "a real fine lady"—"the model of an accomplished woman of former times." She died on the 15th of April 1788.

**DE LA REY, JACOBUS HERCULES** (1847— ), Boer soldier, was born in the Lichtenburg district, and in his youth and early manhood saw much service in savage warfare. In 1893 he entered the Volksraad of the South African Republic, and was an active supporter of the policy of General Joubert. At the outbreak of the war with Great Britain in 1899 De La Rey was made a general, and he was engaged in the western campaign against Lord Methuen and Lord Roberts. He won his first great success at Ntiral's Nek on the 11th of July 1900, where he compelled the surrender of a strong English detachment. In the second or guerrilla stage of the war De La Rey became one of the most conspicuously successful of the Boer leaders. He was assistant to General Louis Botha and a member of the government, with charge of operations in the western Transvaal. The principal actions in which he was successful (see also *TRANSVAAL: History*) were Nootgedacht, Vlaksfontein and the defeat and capture of Lord Methuen at Klerksdorp (March 7, 1902). The British general was severely wounded in the action, and De La Rey released him at once, being unable to afford him proper medical assistance. This humanity and courtesy marked De La Rey's conduct throughout the war, and even more than his military skill and daring earned for him the esteem of his enemies. After the conclusion of peace De La Rey, who had borne a prominent part in the negotiations, visited Europe with the other generals, with the intention of raising funds to enable the Boers to resettle their country. In December 1903 he went on a mission to India, and induced the whole of the Boer prisoners of war detained at Ahmednagar to accept the new order of things and to take the oath of allegiance. In February 1907 General De La Rey was returned unopposed as member for Ventersdorp in the legislative assembly of the first Transvaal parliament under self-government.

**DE LA RIVE, AUGUSTE ARTHUR** (1801-1873), Swiss physicist, was born at Geneva on the 9th of October 1801. He was the son of Charles Gaspard de la Rive (1770-1834), who studied medicine at Edinburgh, and after practising for a few years in London, became professor of pharmaceutical chemistry at the academy of Geneva in 1802 and rector in 1823. After a brilliant career as a student, he was appointed at the age of twenty-two to the chair of natural philosophy in the academy of Geneva. For some years after his appointment he devoted himself specially, with François Marcet (1803-1883), to the investigation of the specific heat of gases, and to observations for determining the temperature of the earth's crust. Electrical studies, however, engaged most of his attention, especially in connexion with the theory of the voltaic cell and the electric discharge in rarefied gases. His researches on the last-mentioned subject led him to form a new theory of the aurora borealis. In 1840 he described a process for the electro-gilding of silver and brass, for which in the following year he received a prize of 3000 francs from the French Academy of Sciences. Between 1854 and 1858 he published a *Traité de l'électricité théorique et appliquée*, which was translated into several languages. De la Rive's birth and fortune gave him considerable social and political influence. He was distinguished for his hospitality to literary and scientific men, and for his interest in the welfare and independence of his native country. In 1860, when the annexation of Savoy and Nice had led the Genevese to fear French aggression, de la Rive was sent by his fellow-citizens on a special embassy to England, and succeeded in securing a declaration from the English government, which was communicated privately to that of France, that any attack upon Geneva would be regarded as a *casus belli*. On the occasion of this visit the university of Oxford conferred upon de la Rive the honorary degree of D.C.L. When on his way to pass the winter at Cannes he died suddenly at Marseilles on the 27th of November 1873.

His son, LUCIEN DE LA RIVE, born at Geneva on the 3rd of April 1834, published papers on various mathematical and physical subjects, and with Édouard Sarasin carried out investigations on the propagation of electric waves.

**DELAROCHE, HIPPOLYTE**, commonly known as PAUL (1797-1856), French painter, was born in Paris on the 17th of July 1797. His father was an expert who had made a fortune, to some extent, by negotiating and cataloguing, buying and selling. He was proud of his son's talent, and able to forward his artistic education. The master selected was Gros, then painting life-size histories, and surrounded by many pupils. In no haste to make an appearance in the Salon, his first exhibited picture was a large one, "Josabeth saving Joas" (1822). This picture led to his acquaintance with Géricault and Delacroix, with whom he remained on the most friendly terms, the three forming the central group of a numerous body of historical painters, such as perhaps never before lived in one locality and at one time.

From 1822 the record of his life is to be found in the successive works coming from his hand. He visited Italy in 1838 and 1843, when his father-in-law, Horace Vernet, was director of the French Academy. His studio in Paris was in the rue Mazarine, where he never spent a day without some good result, his hand being sure and his knowledge great. His subjects, definitely expressed and popular in their manner of treatment, illustrating certain views of history dear to partisans, yet romantic in their general interest, were painted with a firm, solid, smooth surface, which gave an appearance of the highest finish. This solidity, found also on the canvas of Vernet, Scheffer, Leopold Robert and Ingres, was the manner of the day. It repudiates the technical charm of texture and variety of handling which the English school inherited as a tradition from the time of Reynolds; but it is more easily understood by the world at large, since a picture so executed depends for its interest rather on the history, scene in nature or object depicted, than on the executive skill, which may or may not be critically appreciated. We may add that his point of view of the historical characters which he treated is not always just. "Cromwell lifting the Coffin-lid and looking at the Body of Charles" is an incident only to be excused by an improbable tradition; but "The King in the Guard-Room," with villainous roundhead soldiers blowing tobacco smoke in his patient face, is a libel on the Puritans; and "Queen Elizabeth dying on the Ground," like a she-dragon no one dares to touch, is sensational; while the "Execution of Lady Jane Grey" is represented as taking place in a dungeon. Nothing can be more incorrect than this last as a reading of English history, yet we forget the inaccuracy in admiration of the treatment which represents Lady Jane, with bandaged sight, feeling for the block, her maids covering their faces, and none with their eyes visible among the many figures. On the other hand, "Strafford led to Execution," when Laud stretches his lawn-covered arms out of the small high window of his cell to give him a blessing as he passes along the corridor, is perfect; and the splendid scene of Richelieu in his gorgeous barge, preceding the boat containing Cinq-Mars and De Thou carried to execution by their guards, is perhaps the most dramatic semi-historical work ever done. "The Princes in the Tower" must also be mentioned as a very complete creation; and the "Young female Martyr floating dead on the Tiber" is so pathetic that criticism feels hard-hearted and ashamed before it. As a realization of a page of authentic history, again, no picture can surpass the "Assassination of the duc de Guise at Blois." The expression of the murdered man stretched out by the side of the bed, the conspirators all massed together towards the door and far from the body, show exact study as well as insight into human nature. This work was exhibited in his meridian time, 1835; and in the same year he exhibited the "Head of an Angel," a study from Horace Vernet's young daughter Louise, his love for whom was the absorbing passion of his life, and from the shock of whose death, in 1845, it is said he never quite recovered. By far his finest productions after her death are of the most serious character, a sequence of small elaborate pictures of incidents in the Passion. Two of these, the Virgin and the other Maries, with the apostles Peter and John, within a nearly dark apartment,

bearing the crowd as it passes haling Christ to Calvary, and St John conducting the Virgin home again after all is over, are beyond all praise as exhibiting the divine story from a simply human point of view. They are pure and elevated, and also dramatic and painful. Delaroche was not troubled by ideals, and had no affectation of them. His sound but hard execution allowed no mystery to intervene between him and his *motif*, which was always intelligible to the million, so that he escaped all the waste of energy that painters who try to be poets on canvas suffer. Thus it is that essentially the same treatment was applied by him to the characters of distant historical times, the founders of the Christian religion, and the real people of his own day, such as "Napoleon at Fontainebleau," or "Napoleon at St Helena," or "Marie Antoinette leaving the Convention" after her sentence.

In 1837 Delaroche received the commission for the great picture, 27 mètres long, in the hemicycle of the lecture theatre of the *École des Beaux Arts*. This represents the great artists of the modern ages assembled in groups on either hand of a central elevation of white marble steps, on the topmost of which are three thrones filled by the architects and sculptors of the Parthenon. To supply the female element in this vast composition he introduced the genii or muses, who symbolize or reign over the arts, leaning against the balustrade of the steps, beautiful and queenly figures with a certain antique perfection of form, but not informed by any wonderful or profound expression. The portrait figures are nearly all unexceptionable and admirable. This great and successful work is on the wall itself, an inner wall however, and is executed in oil. It was finished in 1841, and considerably injured by a fire which occurred in 1855, which injury he immediately set himself to remedy (finished by Robert-Fleury); but he died before he had well begun, on the 4th of November 1856.

Personally Delaroche exercised even a greater influence than by his works. Though short and not powerfully made, he impressed every one as rather tall than otherwise; his physiognomy was accentuated and firm, and his fine forehead gave him the air of a minister of state.

See Rees, *Delaroche* (London, 1880).

(W. B. Sc.)

**DELARUE, GERVAIS** (1751-1835), French historical investigator, formerly regarded as one of the chief authorities on Norman and Anglo-Norman literature, was a native of Caen. He received his education at the university of that town, and was ultimately raised to the rank of professor. His first historical enterprise was interrupted by the French Revolution, which forced him to take refuge in England, where he took the opportunity of examining a vast mass of original documents in the Tower and elsewhere, and received much encouragement, from Sir Walter Scott among others. From England he passed over to Holland, still in prosecution of his favourite task; and there he remained till in 1798 he returned to France. The rest of his life was spent in his native town, where he was chosen principal of his university. While in England he had been elected a member of the Royal Society of Antiquaries; and in his own country he was made a corresponding member of the Institute, and was enrolled in the Legion of Honour. Besides numerous articles in the *Memoirs of the Royal Society of London*, the *Mémoires de l'Institut*, the *Mémoires de la Société d'Agriculture de Caen*, and in other periodical collections, he published separately *Essais historiques sur les Bardes, les Jongleurs, et les Trouvères normands et anglo-normands* (3 vols., 1834), and *Recherches historiques sur la Prairie de Caen* (1837); and after his death appeared *Mémoires historiques sur le palinod de Caen* (1841), *Recherches sur la tapisserie de Bayeux* (1841), and *Nouveaux Essais historiques sur la ville de Caen* (1842). In all his writings he displays a strong partiality for everything Norman, and rates the Norman influence on French and English literature as of the very highest moment.

**DE LA RUE, WARREN** (1815-1889), British astronomer and chemist, son of Thomas De la Rue, the founder of the large firm of stationers of that name in London, was born in Guernsey on the 18th of January 1815. Having completed his education in Paris, he entered his father's business, but devoted his leisure

hours to chemical and electrical researches, and between 1836 and 1848 published several papers on these subjects. Attracted to astronomy by the influence of James Nasmyth, he constructed in 1850 a 13-in. reflecting telescope, mounted first at Canonbury, later at Cranford, Middlesex, and with its aid executed many drawings of the celestial bodies of singular beauty and fidelity. His chief title to fame, however, is his pioneering work in the application of the art of photography to astronomical research. In 1851 his attention was drawn to a daguerreotype of the moon by G. P. Bond, shown at the great exhibition of that year. Excited to emulation and employing the more rapid wet-collodion process, he succeeded before long in obtaining exquisitely defined lunar pictures, which remained unsurpassed until the appearance of the Rutherford photographs in 1865. In 1854 he turned his attention to solar physics, and for the purpose of obtaining a daily photographic representation of the state of the solar surface he devised the photo-heliograph, described in his report to the British Association, "On Celestial Photography in England" (1859), and in his Bakerian Lecture (*Phil. Trans.* vol. clii. pp. 333-416). Regular work with this instrument, inaugurated at Kew by De la Rue in 1858, was carried on there for fourteen years; and was continued at the Royal Observatory, Greenwich, from 1873 to 1882. The results obtained in the years 1862-1866 were discussed in two memoirs, entitled "Researches on Solar Physics," published by De la Rue, in conjunction with Professor Balfour Stewart and Mr B. Loewy, in the *Phil. Trans.* (vol. clix. pp. 1-110, and vol. clx. pp. 389-496). In 1860 De la Rue took the photo-heliograph to Spain for the purpose of photographing the total solar eclipse which occurred on the 18th of July of that year. This expedition formed the subject of the Bakerian Lecture already referred to. The photographs obtained on that occasion proved beyond doubt the solar character of the prominences or red flames, seen around the limb of the moon during a solar eclipse. In 1873 De la Rue gave up active work in astronomy, and presented most of his astronomical instruments to the university observatory, Oxford. Subsequently, in the year 1887, he provided the same observatory with a 13-in. refractor to enable it to take part in the International Photographic Survey of the Heavens. With Dr Hugo Müller as his collaborator he published several papers of a chemical character between the years 1856 and 1862, and investigated, 1868-1883, the discharge of electricity through gases by means of a battery of 14,600 chloride of silver cells. He was twice president of the Chemical Society, and also of the Royal Astronomical Society (1864-1866). In 1862 he received the gold medal of the latter society, and in 1864 a Royal medal from the Royal Society, for his observations on the total eclipse of the sun in 1860, and for his improvements in astronomical photography. He died in London on the 19th of April 1889.

See *Monthly Notices Roy. Astr. Soc.* 1. 155; *Journ. Chem. Soc.* lvii. 441; *Nature*, xl. 26; *The Times* (April 22, 1889); Royal Society, *Catalogue of Scientific Papers*.

**DELATOR**, in Roman history, properly one who gave notice (*deferre*) to the treasury officials of moneys that had become due to the imperial fisc. This special meaning was extended to those who lodged information as to punishable offences, and further, to those who brought a public accusation (whether true or not) against any person (especially with the object of getting money). Although the word *delator* itself, for "common informer," is confined to imperial times, the right of public accusation had long been in existence. When exercised from patriotic and disinterested motives, its effects were beneficial; but the moment the principle of reward was introduced, this was no longer the case. Sometimes the accuser was rewarded with the rights of citizenship, a place in the senate, or a share of the property of the accused. At the end of the republican period, Cicero (*De Officiis*, ii. 14) expresses his opinion that such accusations should be undertaken only in the interests of the state or for other urgent reasons. Under the empire the system degenerated into an abuse, which reached its height during the reign of Tiberius, although the delators continued to exercise their activity till the reign of Theodosius. They were drawn from all classes of society,—

patricians, knights, freedmen, slaves, philosophers, literary men, and, above all, lawyers. The objects of their attacks were the wealthy, all possible rivals of the emperor, and those whose conduct implied a reproach against the imperial mode of life. Special opportunities were afforded by the law of majestas, which (originally directed against attacks on the ruler by word or deed) came to include all kinds of accusations with which it really had nothing to do; indeed, according to Tacitus, a charge of treason was regularly added to all criminal charges. The chief motive for these accusations was no doubt the desire of amassing wealth,<sup>1</sup> since by the law of majestas one-fourth of the goods of the accused, even if he committed suicide in order to avoid confiscation (which was always carried out in the case of those condemned to capital punishment), was assured to the accuser (who was hence called *quadruplicator*). Pliny and Martial mention instances of enormous fortunes amassed by those who carried on this hateful calling. But it was not without its dangers. If the delator lost his case or refused to carry it through, he was liable to the same penalties as the accused; he was exposed to the risk of vengeance at the hands of the proscribed in the event of their return, or of their relatives; while emperors like Tiberius would have no scruples about banishing or putting out of the way those of his creatures for whom he had no further use, and who might have proved dangerous to himself. Under the better emperors a reaction set in, and the severest penalties were inflicted upon the delators. Titus drove into exile or reduced to slavery those who had served Nero, after they had first been flogged in the amphitheatre. The abuse naturally reappeared under a man like Domitian; the delators, with whom Vespasian had not interfered, although he had abolished trials for majestas, were again banished by Trajan, and threatened with capital punishment in an edict of Constantine; but, as has been said, the evil, which was an almost necessary accompaniment of autocracy, lasted till the end of the 4th century.

See Mayor's note on Juvenal iv. 48 for ancient authorities; C. Merivale, *Hist. of the Romans under the Empire*, chap. 44; W. Rein, *Criminalrecht der Römer* (1842); T. Mommsen, *Römisches Strafrecht* (1899); Kleinfeller in Pauly-Wissowa's *Realencyclopädie*.

**DELAUNAY, ELIE** (1828-1891), French painter, was born at Nantes and studied under Flandrin and at the École des Beaux Arts. He worked in the classicist manner of Ingres until, after winning the Prix de Rome, he went to Italy in 1856, and abandoned the ideal of Raphaelian perfection for the sincerity and severity of the quattrocentists. As a pure and firm draughtsman he stands second only to Ingres. After his return from Rome he was entrusted with many important commissions for decorative paintings, such as the frescoes in the church of St. Nicholas at Nantes; the three panels of "Apollo," "Orpheus" and "Amphion" at the Paris opera-house; and twelve paintings for the great hall of the council of state in the Palais Royal. His "Scenes from the Life of St. Geneviève," which he designed for the Pantheon, remained unfinished at his death. The Luxembourg Museum has his famous "Plague in Rome" and a nude figure of "Diana"; and the Nantes Museum, the "Lesson on the Flute." In the last decade of his life he achieved great popularity as a portrait painter.

**DELAUNAY, LOUIS ARSÈNE** (1826-1903), French actor, was born in Paris, the son of a wine-seller. He studied at the Conservatoire, and made his first formal appearance on the stage in 1845, in *Tartuffe* at the Odéon. After three years at this house he made his début at the Comédie Française as Dorante in Corneille's *Le Menteur*, and began a long and brilliant career in young lover parts. He continued to act as *jeune premier* until he was sixty, his grace, marvellous diction and passion enchanting his audiences. It was especially in the plays of Alfred de Musset that his gifts found their happiest expression. In the thirty-seven years during which he was a member of the Comédie Française, Delaunay took or created nearly two hundred parts. He retired in 1887, having been made a chevalier of the Legion of Honour in 1883.

<sup>1</sup> "Delatores, genus hominum publico exitio repertum . . . per præmia eliciebantur" (Tacitus, *Annals*, iv. 30).

**DELAUVIGNE, JEAN FRANÇOIS CASIMIR** (1793-1843), French poet and dramatist, was born on the 4th of April 1793 at Havre. His father sent him at an early age to Paris, there to be educated at the Lycée Napoléon. Constitutionally of an ardent and sympathetic temperament, he enlarged his outlook by extensive miscellaneous reading. On the 20th of March 1811 the empress Marie Louise gave birth to a son, named in his very cradle king of Rome. This event was celebrated by Delavigne in a *Dithyrambe sur la naissance du roi de Rome*, which secured for him a sinecure in the revenue office.

About this time he competed twice for an academy prize, but without success. Delavigne, inspired by the catastrophe of 1815, wrote two impassioned poems, the first entitled *Waterloo*, the second, *Dévastation du musée*, both written in the heat of patriotic enthusiasm, and teeming with popular political allusions. A third, but of inferior merit, *Sur le besoin de s'unir après le départ des étrangers*, was afterwards added. These stirring pieces, termed by him *Messéniennes*, sounded a keynote which found an echo in the hearts of all. Twenty-five thousand copies were sold; Delavigne was famous. He was appointed to an honorary librarianship, with no duties to discharge. In 1819 his play *Les vèpres Siciliennes* was performed at the Odéon, then just rebuilt; it had previously been refused for the Théâtre Français. On the night of the first representation, which was warmly received, Picard, the manager, threw himself into the arms of his elated friend, exclaiming, "You have saved us! You are the founder of the second French Theatre." This success was followed up by the production of the *Comédiens* (1820), a poor play, with little plot, and the *Paria* (1821), with still less, but containing some well-written choruses. The latter piece obtained a longer lease of life than its intrinsic literary merits warranted, on account of the popularity of the political opinions freely expressed in it—so freely expressed, indeed, that the displeasure of the king was incurred, and Delavigne lost his post. But Louis Philippe, duke of Orleans, willing to gain the people's good wishes by complimenting their favourite, wrote to him as follows: "The thunder has descended on your house; I offer you an apartment in mine." Accordingly Delavigne became librarian at the Palais Royal, a position retained during the remainder of his life. It was here that he wrote the *École des vieillards* (1823), his best comedy, which gained his election to the Academy in 1825. To this period also belong *La Princesse Aurélie* (1828), and *Marino Faliero* (1829), a drama in the romantic style.

For his success as a writer Delavigne was in no small measure indebted to the stirring nature of the times in which he lived. The *Messéniennes*, which first introduced him to universal notice, had their origin in the excitement consequent on the occupation of France by the allies in 1815. Another crisis in his life and in the history of his country, the revolution of 1830, stimulated him to the production of a second masterpiece, *La Parisienne*. This song, set to music by Auber, was on the lips of every Frenchman, and rivalled in popularity the *Marseillaise*. A companion piece, *La Varsoivienne*, was written for the Poles, by whom it was sung on the march to battle. Other works of Delavigne followed each other in rapid succession—*Louis XI* (1832), *Les Enfants d'Édouard* (1833), *Don Juan d'Autriche* (1835), *Une Famille au temps du Luther* (1836), *La Popularité* (1838), *La Fille du Cid* (1839), *Le Conseiller rapporteur* (1840), and *Charles VI* (1843), an opera partly written by his brother. In 1843 he quitted Paris to seek in Italy the health his labours had cost him. At Lyons his strength altogether gave way, and he died on the 11th of December.

By many of his own time Delavigne was looked upon as unsurpassed and unsurpassable. Every one bought and read his works. But the applause of the moment was gained at the sacrifice of lasting fame. As a writer he had many excellences. He expressed himself in a terse and vigorous style. The poet of reason rather than of imagination, he recognized his own province, and was rarely tempted to flights of fancy beyond his powers. He wrote always as he would have spoken, from sincere conviction. In private life he was in every way estimable,—upright, amiable, devoid of all jealousy, and generous to a fault.

His *Poésies* and his *Théâtre* were published in 1863. His *Œuvres complètes* (new edition, 1855) contains a biographical notice by his brother, Germain Delavigne, who is best known as a librettist in opera. See also Sainte-Beuve, *Portraits littéraires*, vol. v.; A. Favrot, *Étude sur Casimir Delavigne* (1894); and F. Vuacheux, *Casimir Delavigne* (1893).

**DELAWARE**, a South Atlantic state of the United States of America, one of the thirteen original states, situated between 38° 27' and 39° 50' N. lat. and between 75° 2' and 75° 47' W. long. (For map see MARYLAND.) It is bounded N. and N.W. by Pennsylvania, E. by the Delaware river and Delaware Bay, which separate it from New Jersey, and by the Atlantic Ocean; S. and W. by Maryland. With the exception of Rhode Island it is the smallest state in the Union, its area being 2370 sq. m., of which 405 sq. m. are water surface.

**Physical Features.**—Delaware lies on the Atlantic coastal plain, and is for the most part level and relatively low, its average elevation above the sea being about 50 ft. It is situated in the eastern part of the peninsula formed by Chesapeake Bay and the estuary of the Delaware river. In the extreme N. the country is rolling, with moderately high hills, moderately deep valleys and rapid streams, West of Wilmington there rises a ridge which crosses the state in a north-westerly direction and forms a watershed between Christiana and Brandywine creeks, its highest elevation above sea-level being 280 ft. South of the Christiana there begins another elevation, sandy and marshy, which extends almost the entire length of the state from N.W. to S.E., and forms a second water-parting. The streams that drain the state are small and insignificant. Those of the N. flow into Brandywine and Christiana creeks, whose estuary into Delaware river forms Wilmington harbour; those of the S.W. have a common outlet in the Nanticoke river of Maryland; those of the E. empty into Delaware Bay and the Atlantic Ocean. The principal harbours are those of Wilmington, New Castle and Lewes. The shore of the bay is marshy, that of the Atlantic is sandy. In Kent county there are more than 60,000 acres of tidal marshland, some of which has been reclaimed by means of dykes; Cypress Swamp in the extreme S. has an area of 50,000 acres. The soils of the N. are clays, sometimes mixed with loam; those of the central part are mainly loams; while those of the S. are sands.

Minerals are found only in the N. part of the state. Those of economic value are kaolin, mined chiefly in the vicinity of Hockessin, New Castle county, the static kaolin product being exceeded in 1903 only by that of Pennsylvania among the states of the United States; granite, used for road-making and rough construction work, found near Wilmington; and brick and tile clays; but the value of their total product in 1902 was less than \$500,000. In 1906 the total mineral product was valued at \$814,126, of which \$237,768 represented clay products and \$146,346 stone. In 1902 only 2.2% of the wage-earners were engaged in mining.

The forests, which once afforded excellent timber, including white oak for shipbuilding, have been greatly reduced by constant cutting; in 1900 it was estimated that 700 sq. m. were wooded, but practically none of this stand was of commercial importance. The fisheries, chiefly oyster, sturgeon and shad, yield an annual product valued at about \$250,000.

The proximity of the Delaware and Chesapeake bays help to give Delaware a mild and temperate climate. The mean annual temperature is approximately 55° F., ranging from 52° in the S. to 56° in the N., and the extremes of heat and cold are 103° in the summer and -17° in the winter. The annual rainfall, greater on the coast than inland, ranges from 40 to 45 in.

**Industry and Trade.**—Delaware is pre-eminently an agricultural state. In 1900 85% of its total land surface was enclosed in farms—a slight decline since 1880. Seven-tenths of this was improved land, and the expenditure per farm for fertilizers, greater in 1890 than the average of the Atlantic states, approximated \$55 per farm in 1900. In 1899 Delaware spent more per acre for fertilizers than any of the other states except New Jersey, Rhode Island and Maryland. The average size of farms, as in the other states, has declined, falling from 124.6 acres in 1880 to 110.1 acres in 1900. A large proportion of farms (49.7%)

were operated by the owners, and the prevailing form of tenantry was the share system by which 42.5% of the farms were cultivated, while 8.24% of the farms were operated by negroes; these represented less than 4% of the total value of farm property, the average value of farms operated by negroes being \$17 per acre, that of farms operated by whites, \$23 per acre. The total value of farm products in 1900 was \$9,190,777, an increase of 30% over that of 1890, while the cultivation of cereals suffered on account of the competition of the western states. Indian corn and wheat form the two largest crops, their product in 1900 being respectively 24% and 52% greater than in 1890; but these crops when compared with those of other states are relatively unimportant. In 1906 the acreage of Indian corn was 196,472 acres with a yield of 5,894,160 bushels valued at \$2,475,547, and the acreage of wheat was 121,745 acres with a yield of 1,947,920 bushels valued at \$1,383,023. The value of the fruit crop, for which Delaware has long been noted, also increased during the same decade, but disease and frost caused a marked decline in the production of peaches, a loss balanced by an increased production of apples, pears and other orchard fruits. Large quantities of small fruits, particularly of strawberries, raspberries and blackberries, are produced, the southern portion of Sussex county being particularly favourable for strawberry culture. The vicissitudes of fruit raising have also caused increasing attention to be paid to market gardening, dairying and stock raising, particularly to market gardening, an industry which is favoured by the proximity of large cities. The same influence also explains, partly at least, the decrease (of 13%) in the value of farm property between 1890 and 1900.

The development of manufacturing in Delaware has not been so extensive as its favourable situation relative to the other states, the facilities for water and railway transportation, and the proximity of the coal and iron fields of Pennsylvania, would seem to warrant. In 1905 the wage-earners engaged in manufacturing (under the factory system) numbered 18,475, and the total capital invested in manufacturing was \$50,925,630; the gross value of products was \$41,160,276; the net value (deducting the value of material purchased in partly manufactured form) was \$16,276,470. The principal industry was the manufacture of iron and steel products, which, including steel and rolling mills, car, foundry and machine shops, and shipyards, represented more than 30% of the total capital, and approximately 25% of the total gross product of the manufactures in the state. The tanning, currying and finishing of leather ranks second in importance, with a gross product (\$10,250,842) 9% greater than that of 1900, and constituting about one-fourth of the gross factory product of the state in 1905; and the manufacture of food products ranked third, the value of the products of the fruit canning and preserving industry having more than doubled in the decade 1890-1900, but falling off a little more than 7% in 1900-1905. The manufacture of paper and wood pulp showed an increased product in 1905 19.1% greater than in 1900; and flour and grist mill products were valued in 1905 43.6% higher than in 1900. In the grand total of manufactured products, however, the state showed in 1905 a decrease of 4% from 1900. The great manufacturing centre is Wilmington, where in 1905 almost two-thirds of the capital was invested, and nearly three-fourths of the product was turned out. There is much manufacturing also at New Castle.

Delaware has good facilities for transportation. Its railway mileage in January 1907 was 333.6 m.; the Philadelphia, Baltimore & Washington (Pennsylvania system), the Baltimore & Philadelphia (Baltimore & Ohio system), and the Wilmington & Northern (Philadelphia & Reading system) cross the northern part of the state, while the Delaware railway (leased by the Philadelphia, Baltimore & Washington) runs the length of the state below Wilmington, and another line, the Maryland, Delaware & Virginia (controlled by the Baltimore, Chesapeake & Atlantic railway, which is related to the Pennsylvania system), connects Lewes, Del., with Love Point, Md., on the Chesapeake Bay. There is no state railway commission, and the farmers of southern Delaware have suffered from excessive freight rates.

The Delaware & Chesapeake Canal (13½ m. long, 66 ft. wide and 10 ft. deep) crosses the N. part of the state, connecting Delaware river and Chesapeake Bay, and thus affords transportation by water from Baltimore to Philadelphia. The canal was completed in 1829; in 1907 a commission appointed by the president to report on a route for a waterway between Chesapeake and Delaware bays selected the route of this canal. The states of Maryland and Delaware aided in its construction, and in 1828 the national government also made an appropriation. Wilmington is a customs district in which New Castle and Lewes are included; but its trade is largely coastwise. Rehoboth and Indian River bays are navigable for vessels of less than 6 ft. draft. Opposite Lewes is the Delaware Breakwater (begun in 1818 and completed in 1869, at a cost of more than \$2,000,000), which forms a harbour 16 ft. deep. In 1897-1901 the United States government constructed a harbour of refuge, formed by a second breakwater 2½ m. N. of the existing one; its protected anchorage is 552 acres and the cost was more than \$2,090,000. The harbour is about equidistant from New York, Philadelphia, and the capes of Chesapeake Bay, and is used chiefly by vessels awaiting orders to ports for discharge or landing. The national government also made appropriations for opening an inland waterway from Lewes to Chincoteague Bay, Virginia, for improving Wilmington harbour, and for making navigable several of the larger streams of the state.

**Population.**—The population in 1880 was 146,608; in 1890, 168,493, an increase of 14.9%; in 1900, 184,735, a further increase of 9.6%; in 1910, 202,322. The rate of increase before 1850 was considerably smaller than the rate after that date. Of the population in 1900, 92.5% was native born and 7.5% was foreign-born. The negro population was 30,697, or 16.6% of the total. In Indian River Hundred, Sussex county, there formerly lived a community of people,—many of whom are of the fair Caucasian type,—called "Indians" or "Moors"; they are now quite generally dispersed throughout the state, especially in Kent and Sussex counties. Their origin is unknown, but according to local tradition they are the descendants of some Moorish sailors who were cast ashore many years ago in a shipwreck; their own tradition is that they are descended from the children of an Irish mother and a negro father, these children having intermarried with Indians of the Nanticoke tribe. They have, where practicable, separate churches and schools, the latter receiving state aid. The urban population of Delaware (*i.e.* of Wilmington, the only city having more than 5000 inhabitants) was, in 1900, 41.4% of the state's population. There were thirty-five incorporated cities and towns. The largest of these was the city of Wilmington, with 76,508 inhabitants. The city next in size, New Castle, had a population of 3380, while the largest town, Dover, the capital of the state, had 3329. The total number of communicants of all denominations in 1906 was 71,251,—32,402 Methodists, 24,228 Roman Catholics, 5200 Presbyterians, 3796 Protestant Episcopalians, and 2921 Baptists.

**Government.**—The constitution by which Delaware is governed was adopted in 1897. Like the previous constitutions of 1776, 1792 and 1831, it was promulgated by a constitutional convention without submission to the people for ratification, and amendments may be adopted by a two-thirds vote of each house in two consecutive legislatures. Its character is distinctly democratic. The property qualification of state senators and the restriction of suffrage to those who have paid county or poll taxes are abolished; but suffrage is limited to male adults who can read the state constitution in English, and can write their names, unless physically disqualified, and who have registered. In 1907 an amendment to the constitution was adopted, which struck out from the instrument the clause requiring the payment of a registration fee of one dollar by each elector. Important innovations in the constitution of 1897 are the office of lieutenant-governor, and the veto power of the governor which may extend to parts and clauses of appropriation bills, but a bill may be passed over his veto by a three-fifths vote of each house of the legislature, and a bill becomes a law if not returned to the legislature within ten days after its reception by the governor,

unless the session of the legislature shall have expired in the meantime. The governor's regular term in office is four years, and he is ineligible for a third term. All his appointments to offices where the salary is more than \$500 must be confirmed by the senate; all pardons must be approved by a board of pardons. Representation in the legislature is according to districts, members of the lower house being chosen for two, and members of the upper house for four years. Members of the lower house must be at least twenty-four years of age, members of the senate at least twenty-seven; members of both houses must at the time of their election have been citizens of the state for at least three years. In November 1906 the people of the state voted (17,248 for; 2162 against) in favour of the provision of a system of advisory initiative and advisory referendum; and in March 1907 the general assembly passed an act providing initiative and referendum in the municipal affairs in the city of Wilmington. The organization of the judiciary is similar to that under the old English system. Six judges—a chancellor, a chief justice, and four associate justices—of whom there shall be at least one resident in each of the three counties, and not more than three shall belong to the same political party, are appointed by the governor, with the consent of the senate, for a term of twelve years. A certain number of them hold courts of chancery, general sessions, oyer and terminer, and an orphans' court; the six together constitute the supreme court, but the judge from whose decision appeal is made may not hear the appealed case unless the appeal is made at his own instance. Bribery may be punished by fine, imprisonment and disfranchisement for ten years. Corporations cannot be created by a special act of the legislature, and no corporation may issue stock except for an equivalent value of money, labour or property. In order to attract capital to the state, the legislature has reduced the taxes on corporations, has forbidden the repeal of charters, and has given permission for the organization of corporations with both the power and name of trust companies. Legislative divorces are forbidden by the constitution, and a statute of 1901 subjects wife-beaters to corporal punishment. Although punishment by whipping and by standing in the pillory was prohibited by an act of Congress in 1839, in so far as the Federal government had jurisdiction, both these forms of punishment were retained in Delaware, and standing in the pillory was prescribed by statute as a punishment for a number of offences, including various kinds of larceny and forgery, highway robbery, and even pretending "to exercise the art of witchcraft, fortune-telling or dealing with spirits," at least until 1893. In 1905, by a law approved on the 20th of March, the pillory was abolished. The whipping-post was in 1908 still maintained in Delaware, and whipping continued to be prescribed as a punishment for a variety of offences, although in 1889 a law was passed which prescribed that "hereafter no female convicted of any crime in this state shall be whipped or made to stand in the pillory," and a law passed in 1883 prescribed that "in case of conviction of larceny, when the prisoner is of tender years, or is charged for the first time (being shown to have before had a good character), the court may in its discretion omit from the sentence the infliction of lashes." An old law still on the statute-books when the edition of the revised statutes was issued in 1893, prescribes that "the punishment of whipping shall be inflicted publicly by strokes on the bare back, well laid on."

The unit of local government is the "hundred," which corresponds to the township of Pennsylvania. The employment of children under fourteen years of age in factories is forbidden by statute. Divorces are granted for adultery, desertion for three years, habitual drunkenness, impotence at the time of marriage, fraud, lack of marriageable age (eighteen for males, sixteen for females), and failure of husband to provide for his wife during three consecutive years. The marriages of whites with negroes and of insane persons are null; but the children of the married insane are legitimate.

In 1908 the state debt was \$816,785, and the assets in bonds, railway mortgages and bank stocks exceeded the liabilities by \$717,779. Besides the income from interest and dividends



on investments, the state revenues are derived from taxes on licences, on commissions to public officers, on railway, telegraph and telephone, express, and banking companies, and to a slight extent from taxes on collateral inheritance.

*Education.*—The charitable and penal administration of Delaware is not well developed. There is a state hospital for the insane at Farnhurst. Other dependent citizens are cared for in the institutions of other states at public expense. In 1899 a county workhouse was established in New Castle county, in which persons under sentence must labour eight hours a day, pay being allowed for extra hours, and a diminution of sentence for good behaviour. At Wilmington is the Ferris industrial school for boys, a private reformatory institution to which New Castle county gives \$146 for each boy; and the Delaware industrial school for girls, also at Wilmington, receives financial support from both county and state.

The educational system of the state has been considerably improved within recent years. The maintenance of a system of public schools is rendered compulsory by the state constitution, and a new compulsory school law came into effect in 1907. The first public school law, passed in 1829, was based largely on the principle of "local option," each school district being left free to determine the character of its own school or even to decide, if it wished, against having any school at all. The system thus established proved to be very unsatisfactory, and a new school law in 1875 brought about a greater degree of uniformity and centralization through its provisions for the appointment of a state superintendent of free schools and a state board of education. In 1888, however, the state superintendency was abolished, and county superintendencies were created instead, the legislature thus returning, in a measure, to the old system of local control. Centralization was again secured, in 1898, by the passage of a law reorganizing and increasing the powers of the state board of education. The state school fund, ranging from about \$150,000 to \$160,000 a year, is apportioned among the school districts, according to the number of teachers employed, and is used exclusively for teachers' salaries and the supplying of free text-books. This fund is supplemented by local taxation. No discrimination is allowed on account of race or colour; but separate schools are provided for white and coloured children. Delaware College (non-sectarian) at Newark, founded in 1833 as Newark College and rechartered, after suspension from 1859 to 1870, under the present name, as a state institution, derives most of its financial support from the United States Land Grant of 1862 and the supplementary appropriation of 1890, and is the seat of an agricultural experiment station, established in 1888 under the so-called "Hatch Bill" of 1887. In 1906-1907 Delaware College had 20 instructors and 130 students. The college is a part of the free school system of Delaware, and tuition is free to all students from the state. There is an agricultural college for negroes at Dover; this college receives one-fifth of the appropriation made by the so-called "new Morrill Bill" of 1890.

*History.*—Delaware river and bay were first explored on behalf of the Dutch by Henry Hudson in 1609, and more thoroughly in 1615-1616 by Cornelius Hendrikson, whose reports did much to cause the incorporation of the Dutch West India Company. The first settlement on Delaware soil was made under the auspices of members of this company in 1631 near the site of the present Lewes. The leaders, one of whom was Captain David P. de Vries, wished "to plant a colony for the cultivation of grain and tobacco as well as to carry on the whale fishery in that region." The settlement, however, was soon completely destroyed by the Indians. (See LEWES.) A more successful effort at colonization was made under the auspices of the South Company of Sweden, a corporation organized in 1624 as the "Australian Company," by William Usselinx, who had also been the chief organizer of the Dutch West India Company, and now secured a charter or *manifest* from Gustavus Adolphus. The privileges of the company were extended to Germans in 1633, and about 1640 the Dutch members were bought out. In 1638 Peter Minuit on behalf of this company established a settlement at what is now

Wilmington, naming it, in honour of the infant queen Christina, Christianaham, and naming the entire territory, bought by Minuit from the Minquas Indians and extending indefinitely westward from the Delaware river between Bombay Hook and the mouth of the Schuylkill river, "New Sweden." This territory was subsequently considerably enlarged. In 1642 mature plans for colonization were adopted. A new company, officially known as the West India, American, or New Sweden Company, but like its predecessor popularly known as the South Company, was chartered, and a governor, Johan Printz (c. 1600-1663) was sent out by the crown. He arrived early in 1643 and subsequently established settlements on the island of Tinicum, near the present Chester, Pennsylvania, at the mouth of Salem Creek, New Jersey, and near the mouth of the Schuylkill river. Friction had soon arisen with New Netherland, although, owing to their common dislike of the English, the Swedes and the Dutch had maintained a formal friendship. In 1651, however, Peter Stuyvesant, governor of New Netherland, and more aggressive than his predecessors, built Fort Casimir, near what is now New Castle. In 1654 Printz's successor, Johan Claudius Rising, who had arrived from Sweden with a large number of colonists, expelled the Dutch from Fort Casimir. In retaliation, Stuyvesant, in 1655, with seven vessels and as many hundred men, recaptured the fort and also captured Fort Christina (Wilmington). New Sweden thus passed into the control of the Dutch, and became a dependency of New Netherland. In 1656, however, the Dutch West India Company sold part of what had been New Sweden to the city of Amsterdam, which in the following year established a settlement called "New Amstel" at Fort Casimir (New Castle). This settlement was badly administered and made little progress.

In 1663 the whole of the Delaware country came under the jurisdiction of the city of Amsterdam, but in the following year this territory, with New Netherland, was seized by the English. For a brief interval, in 1673-1674, the Dutch were again in control, but in the latter year, by the treaty of Westminster, the "three counties on the Delaware" again became part of the English possessions in America held by the duke of York, later James II. His formal grant from Charles II. was not received until March 1683. In order that no other settlements should encroach upon his centre of government, New Castle, the northern boundary was determined by drawing an arc of a circle, 12 m. in radius, and with New Castle as the centre. This accounts for the present curved boundary line between Delaware and Pennsylvania. Previously, however, in August 1680, the duke of York had leased this territory for 10,000 years to William Penn, to whom he conveyed it by a deed of feoffment in August 1682; but differences in race and religion, economic rivalry between New Castle and the Pennsylvania towns, and petty political quarrels over representation and office holding, similar to those in the other American colonies, were so intense that Penn in 1691 appointed a special deputy governor for the "lower counties." Although reunited with the "province" of Pennsylvania in 1693, the so-called "territories" or "lower counties" secured a separate legislature in 1704, and a separate executive council in 1710; the governor of Pennsylvania, however, was the chief executive until 1776. A protracted boundary dispute with Maryland, which colony at first claimed the whole of Delaware under Lord Baltimore's charter, was not settled until 1767, when the present line separating Delaware and Maryland was adopted. In the War of Independence Delaware furnished only one regiment to the American army, but that was one of the best in the service. One of its companies carried a number of game-cocks said to have been the brood of a blue hen; hence the soldiers, and later the people of the state, have been popularly known as the "Blue Hen's Chickens."

In 1776 a state government was organized, representative of the Delaware state, the term "State of Delaware" being first adopted in the constitution of 1792. One of the peculiarities of the government was that in addition to the regular executive, legislative and judicial departments there was a privy council without whose approval the governor's power was little more than nominal. In 1786 Delaware was one of the five states

whose delegates attended the Annapolis Convention (see ANNA-POLIS, Maryland), and it was the first (on the 7th of December 1787) to ratify the Federal constitution. From then until 1850 it was controlled by the Federalist or Whig parties. In 1850 the Democrats, who had before then elected a few governors and United States senators, secured control of the entire administration—a control unarrested, except in 1863, until the last decade of the 19th century. Although it was a slave state, the majority of the people of Delaware opposed secession in 1861, and the legislature promptly answered President Lincoln's call to arms; yet, while 14,000 of the 40,000 males between the ages of fourteen and sixty served in the Union army, there were many sympathizers with the Confederacy in the southern part of the state.

In 1866, 1867 and 1869, respectively, the legislature refused to ratify the thirteenth, fourteenth and fifteenth amendments to the Federal constitution. The provision of the state constitution that restricted suffrage to those who had paid county or poll taxes and made the tax lists the basis for the lists of qualified voters, opened the way for the disfranchisement of many negroes by fraudulent means. Consequently the levy court of New Castle county was indicted in the United States circuit court in 1872, and one of its members was convicted. Again in 1880 the circuit court, by virtue of the Federal statute of 1872 on elections, appointed supervisors of elections in Delaware. The negro vote has steadily increased in importance, and in 1900 was approximately one-fifth of the total vote of the state. In 1901 the legislature ratified the three amendments rejected in former years. Another political problem has been that of representation. According to the constitution of 1831 the unit of representation in the legislature was the county; inasmuch as the population of New Castle county has exceeded after 1870 that of both Kent and Sussex, the inequality became a cause of discontent. This is partly eradicated by the new constitution of 1897, which reapportioned representation according to electoral districts, so that New Castle has seven senators and fifteen representatives, while each of the other counties has seven senators and ten representatives.

In 1839 the Republicans for the first time since the Civil War secured a majority in the legislature, and elected Anthony J. Higgins to the United States Senate. In that year a capitalist and promoter, J. Edward Addicks (b. 1841, in Pennsylvania), became a citizen of the state, and after securing for himself the control of the Wilmington gas supply, systematically set about building up a personal "machine" that would secure his election to the national Senate as a Republican. His purpose was thwarted in 1893, when a Democratic majority chose, for a second term, George Gray (b. 1840), who from 1879 to 1885 had been the attorney-general of the state and subsequently was a member of the Spanish-American Peace Commission at Paris in 1898 and became a judge of the United States circuit court, third judicial circuit, in 1899. Mr Addicks was an avowed candidate in 1895, but the opposition of the Regular Republicans, who accused him of corruption and who held the balance of power, prevented an election. In 1897, the legislature being again Democratic, Richard R. Kenney (b. 1856) was chosen to fill the vacancy for the remainder of the unexpired term. Meanwhile the two Republican factions continued to oppose one another, and both sent delegates to the national party convention in 1896, the "regular" delegation being seated. The expiration of Senator Gray's term in 1899 left a vacancy, but although the Republicans again had a clear majority the resolution of the Regulars prevented the Union Republicans, as the supporters of Addicks called themselves, from seating their patron. Both the Regular and Union factions sent delegations to the national party convention in 1900, where the refusal of the Regulars to compromise led to the recognition of the Union delegates. Despite this apparent abandonment of their cause by the national organization, the Regulars continued their opposition, the state being wholly without representation in the Senate from the expiration of Senator Kenney's term in 1901 until 1903, when a compromise was effected whereby two Republicans, one of each faction, were chosen, one condition being that Addicks should not be the

candidate of the Union Republicans. Both factions were recognized by the national convention of 1904, but the legislature of 1905 adjourned without being able to fill a vacancy in the Senate which had again occurred. The deadlock, however, was broken at the special session of the legislature called in 1906, and in June of that year Henry A. Du Pont was elected senator.

## GOVERNORS OF DELAWARE

## I. Swedish.

Peter Minuit	1638-1640
Peter Hollander	1640-1643
Johan Printz	1643-1653
Johan Papegoga (acting)	1653-1654
Johan Claudius Rising	1654-1655

## II. Dutch.

(Same as for New York.)

## III. English.

(Same as New York until 1682.)

(Same as Pennsylvania 1682-1776.)

## PRESIDENTS OF DELAWARE

John McKinley	1776-1778
Caesar Rodney	1778-1781
John Dickinson	1781-1783
Nicholas Van Dyke	1783-1786
Thomas Collins	1786-1789

## GOVERNORS

Joshua Clayton	1789-1796	Federalist
Gunning Bedford	1796-1797	"
Daniel Rogers <sup>1</sup>	1797-1799	"
Richard Bassett	1799-1801	"
James Sykes <sup>2</sup>	1801-1802	"
David Hall	1802-1805	Federalist
Nathaniel Mitchell	1805-1808	"
George Truett	1808-1811	"
Joseph Haslett	1811-1814	"
Daniel Rodney	1814-1817	"
John Clarke	1817-1820	"
Henry Malleston <sup>3</sup>	1820	"
Jacob Stout <sup>4</sup>	1820-1821	"
John Collins	1821-1822	Democratic-Republican
Caleb Rodney <sup>5</sup>	1822	"
Joseph Haslett	1822-1823	Democratic-Republican
Charles Thomas <sup>6</sup>	1823-1824	"
Samuel Paynter	1824-1827	Federalist
Charles Polk	1827-1830	"
David Hazzard	1830-1833	American-Republican
Caleb P. Bennett	1833-1836	Democrat
Charles Polk <sup>7</sup>	1836-1837	"
Cornelius P. Comegys	1837-1841	Whig
William B. Cooper	1841-1845	"
Thomas Stockton	1845-1846	"
Joseph Maul <sup>8</sup>	1846	"
William Temple <sup>9</sup>	1846-1847	"
William Tharp	1847-1851	Democrat
William H. Ross	1851-1855	"
Peter F. Causey	1855-1859	Whig-Know-Nothing
William Burton	1859-1863	Democrat
William Cannon	1863-1865	Republican
Gove Saulsbury <sup>10</sup>	1865-1871	Democrat
James Ponder	1871-1875	"
John P. Cockran	1875-1879	"
John W. Hall	1879-1883	"
Charles C. Stockley	1883-1887	"
Benjamin T. Biggs	1887-1891	"
Robert J. Reynolds	1891-1895	"
Joshua H. Marvil	1895	Republican
William T. Watson <sup>11</sup>	1895-1897	Democrat
Ebe W. Tunnell	1897-1901	"
John Hunn	1901-1905	Republican
Preston Lea	1905-1909	"
Simeon S. Pennewill	1909	"

<sup>1</sup> Speaker of the senate. Filled unexpired term of Gunning Bedford (d. 1797).

<sup>2</sup> Speaker of senate. Filled unexpired term of Richard Bassett, who resigned 1801.

<sup>3</sup> Died before he was inaugurated.

<sup>4</sup> Speaker of the senate.

<sup>5</sup> Speaker of the senate, John Collins dying in 1822.

<sup>6</sup> Speaker of senate, Haslett dying in 1823.

<sup>7</sup> Speaker of senate.

<sup>8</sup> Speaker of senate, Stockton dying in 1846.

<sup>9</sup> Speaker of senate, Maul dying in 1846.

<sup>10</sup> As speaker of the senate filled the unexpired term of Cannon (d. 1865), and then became governor in 1867.

<sup>11</sup> President of senate, Marvil dying in 1895.

**BIBLIOGRAPHY.**—Information about manufactures, mining and agriculture may be found in the reports of the *Twelfth Census of the United States*, especially *Bulletins 69* and *100*. The Agricultural Experiment Station, at Newark, publishes in its *Annual Report* a record of temperature and rainfall. For law and administration see *Constitution of Delaware* (Dover, 1899) and the *Revised Code of 1852*, amended 1893 (Wilmington, 1893). For education see L. B. Powell, *History of Education in Delaware* (Washington, 1893), and a sketch in the *Annual Report* for 1902 of the United States Commissioner of Education. The most elaborate history is that of John Thomas Scharf, *History of the State of Delaware* (2 vols., Philadelphia, 1888); the second volume is entirely biographical. Claes T. Odhner's brief sketch, *Kolonien Nya Sveriges Grundläggning, 1637-1642* (Stockholm, 1876; English translation in the *Pennsylvania Magazine of History and Biography*, vol. iii.), and Carl K. S. Sprinchorn's *Kolonien Nya Sveriges Historia* (1878; English translation in the *Pennsylvania Magazine of History and Biography*, vols. vii. and viii.) are based, in part, on documents in the Swedish Royal Archives and at the universities of Upsala and Lund, which were unknown to Benjamin Ferris (*History of the Original Settlements of the Delaware*, Wilmington, 1846) and Francis Vincent (*History of the State of Delaware*, Philadelphia, 1870), which ends with the English occupation in 1664). In vol. iv. of Justin Winsor's *Narrative and Critical History of America* (Boston, 1884) there is an excellent chapter by Gregory B. Keen on "New Sweden, or the Swedes on the Delaware," to which a bibliographical chapter is appended. The *Papers of the Historical Society of Delaware* (1879 seq.) contain valuable material. In part ii. of the *Report of the Superintendent of the U.S. Coast and Geodetic Survey for 1893* (Washington, 1905) there is "A Historical Account of the Boundary Line between the States of Pennsylvania and Delaware, by W. C. Hodgkins." The colonial records are preserved with those of New York and Pennsylvania; only one volume of the State Records has been published, and *Minutes of the Council of Delaware State, 1776-1792* (Dover, 1886). For political conditions since the Civil War see vol. 141 of the *North American Review*, vol. 32 of the *Forum*, and vol. 73 of the *Outlook*—all published in New York.

**DELAWARE**, a city and the county-seat of Delaware county, Ohio, U.S.A., on the Olentangy (or Whetstone) river, near the centre of the state. Pop. (1890) 8224; (1900) 7940 (572 were foreign-born and 432 negroes); (1910) 9076. Delaware is served by the Pennsylvania, the Cleveland, Cincinnati, Chicago & St. Louis (New York Central system), and the Hocking Valley railways, and by two interurban lines. The city is built on rolling ground about 900 ft. above sea-level. There are many sulphur and iron springs in the vicinity. Delaware is the seat of the Ohio Wesleyan University (co-educational), founded by the Ohio Conference of the Methodist Episcopal Church in 1841, and opened as a college in 1844; it includes a college of liberal arts (1844), an academic department (1841), a school of music (1877), a school of fine arts (1877), a school of oratory (1894), a business school (1895), and a college of medicine (the Cleveland College of Physicians and Surgeons, at Cleveland, Ohio; founded as the Charity Hospital Medical College in 1863, and the medical department of the university of Wooster until 1896, when, under its present name, it became a part of Ohio Wesleyan University). In 1877 the Ohio Wesleyan female college, established at Delaware in 1853, was incorporated in the university. In 1907-1908 the university had 122 instructors, 1178 students and a library of 55,395 volumes. At Delaware, also, are the state industrial school for girls, a Carnegie library, the Edwards Young Men's Christian Association building and a city hospital. The city has railway shops and foundries, and manufactures furniture, carriages, tile, cigars and gas engines. Delaware was laid out in 1808 and was first incorporated in 1815. It was the birthplace of Rutherford B. Hayes, president of the United States from 1877 to 1881.

**DELAWARE INDIANS**, the English name for the Leni Lenape, a tribe of North American Indians of Algonquian stock. When first discovered by the whites the tribe was settled on the banks of the Delaware river. The French called them Loups (wolves) from their chief totemic division. Early in the 17th century the Dutch began trading with them. Subsequently William Penn bought large tracts of land from them, and war followed, the Delawares alleging they had been defrauded; but, with the assistance of the Six Nations, the whites forced them back west of the Alleghenies. In 1789 they were placed on a reservation in Ohio and subsequently in 1818 were moved to Missouri. Various removals followed, until in 1866 they accepted lands in the Indian

territory (Oklahoma) and gave up the tribal relation. They have remained there and now number some 1700.

**DELAWARE RIVER**, a stream of the Atlantic slope of the United States, meeting tide-water at Trenton, New Jersey, 130 m. above its mouth. Its total length, from the head of the longest branch to the capes, is 410 m., and above the head of the bay its length is 360 m. It constitutes in part the boundary between Pennsylvania and New York, the boundary between New Jersey and Pennsylvania, and, for a few miles, the boundary between Delaware and New Jersey. The main, west or Mohawk branch rises in Schoharie county, N.Y., about 1886 ft. above the sea, and flows tortuously through the plateau in a deep trough until it emerges from the Catskills. Other branches rise in Greene and Delaware counties. In the upper portion of its course the varied scenery of its hilly and wooded banks is exquisitely beautiful. After leaving the mountains and plateau, the river flows down broad Appalachian valleys, skirts the Kittatinny range, which it crosses at Delaware Water-Gap, between nearly vertical walls of sandstone, and passes through a quiet and charming country of farm and forest, diversified with plateaus and escarpments, until it crosses the Appalachian plain and enters the hills again at Easton, Pa. From this point it is flanked at intervals by fine hills, and in places by cliffs, of which the finest are the Hockamixon Rocks, 3 m. long and above 200 ft. high. At Trenton there is a fall of 8 ft. Below Trenton the river becomes a broad, sluggish inlet of the sea, with many marshes along its side, widening steadily into its great estuary, Delaware Bay. Its main tributaries in New York are Mongaup and Neversink rivers and Callicoon Creek; from Pennsylvania, Lackawaxen, Lehigh and Schuylkill rivers; and from New Jersey, Rancocas Creek and Musconetcong and Maurice rivers. Commerce was once important on the upper river, but only before the beginning of railway competition (1857). The Delaware division of the Pennsylvania Canal, running parallel with the river from Easton to Bristol, was opened in 1830. A canal from Trenton to New Brunswick unites the waters of the Delaware and Raritan rivers; the Morris and the Delaware and Hudson canals connect the Delaware and Hudson rivers; and the Delaware and Chesapeake canal joins the waters of the Delaware with those of the Chesapeake Bay. The mean tides below Philadelphia are about 6 ft. The magnitude of the commerce of Philadelphia has made the improvements of the river below that port of great importance. Small improvements were attempted by Pennsylvania as early as 1771, but apparently never by New Jersey. The ice floods at Easton are normally 10 to 20 ft., and in 1841 attained a height of 35 ft. These floods constitute a serious difficulty in the improvement of the lower river. In the "project of 1885" the United States government undertook systematically the formation of a 26-ft. channel 600 ft. wide from Philadelphia to deep water in Delaware Bay; \$1,532,688.81 was expended—about \$200,000 of that amount for maintenance—before the 1885 project was superseded by a paragraph of the River and Harbor Act of the 3rd of March 1899, which provided for a 30-ft. channel 600 ft. wide from Philadelphia to the deep water of the bay. In 1899 the project of 1885 had been completed except for three shoal stretches, whose total length, measured on the range lines, was 4½ m. The project of 1899, estimated to cost \$5,810,000, was not completed at the close of the fiscal year (June 30) 1907, when \$4,936,550.63 had been expended by the Federal government on the work; in 1905 the state of Pennsylvania appropriated \$750,000 for improvement of the river in Pennsylvania, south of Philadelphia.

**DELAWARE WATER-GAP**, a borough and summer resort of Monroe county, Pennsylvania, U.S.A., on the Delaware river, about 108 m. N. of Philadelphia and about 88 m. W. by N. of New York. Pop. (1890) 467; (1900) 469. It is served directly by the Delaware, Lackawanna & Western, and by the Belvidere division of the Pennsylvania railways; along the river on the opposite side (in New Jersey) runs the New York, Susquehanna & Western railway, and the borough is connected with Stroudsburg, Pa. (about 3 m. W. by N.), by an electric line. The borough

was named from the neighbouring gorge, which is noted for the picturesqueness of its scenery, especially in winter, when the ice piles up in the river, sometimes to a height of 20 ft. Here the river cuts through the Kittatinny (Blue) Ridge to its base. On the New Jersey side is Mt. Tammany (about 1600 ft.); on the Pennsylvania side, Mt. Minsi (about 1500 ft.); the elevation of the river here is about 300 ft. The gap (about 2 m. long) through the mountain is the result of erosion by the waters of a great river which flowed northwards acting along a line of faulting at right angles to the strike of the tilted rock formations. The scenery and the delightful climate have made the place a popular summer resort. The borough was incorporated in 1889.

See L. W. Brodhead, *The Delaware Water-Gap* (Philadelphia, 2nd ed., 1870).

**DE LA WARR**, or **DELAWARE**, an English barony, the holders of which are descended from Roger de la Warr of Isfield, Sussex, who was summoned to parliament as a baron in 1299 and the following years. He died about 1320; his great-grandson Roger, to whom the French king John surrendered at the battle of Poitiers, died in 1370; and the male line of the family became extinct on the death of Thomas, 5th baron, in 1426.

The 5th baron's half-sister Joan married Thomas West, 1st Lord West (d. 1405), and in 1415 her second son Reginald (1394-1451) succeeded his brother Thomas as 3rd Lord West. After the death of his uncle Thomas, 5th Baron De La Warr, whose estates he inherited, Reginald was summoned to parliament as Baron La Warr, and he is thus the second founder of the family. His grandson was Thomas, 3rd (or 8th) baron (d. 1525), a courtier during the reigns of Henry VII. and Henry VIII.; and the latter's son was Thomas, 4th (or 9th) baron (c. 1472-1554). The younger Thomas was a very prominent person during the reigns of Henry VIII. and Edward VI. After serving with the English army in France in 1513 and being present at the Field of the Cloth of Gold, he rebuilt the house at Halnaker in Sussex, which he had obtained by marriage, and here in 1526 he entertained Henry VIII. "with great cheer." He disliked the ecclesiastical changes introduced by the king, and he was one of the peers who tried Anne Boleyn; later he showed some eagerness to stand well with Thomas Cromwell, but this did not prevent his arrest in 1538. He is said to have denounced "the plucking down of abbeys," and he certainly consorted with many suspected persons. But he was soon released and pardoned, although he was obliged to hand over Halnaker to Henry VIII., receiving instead the estate of Wherwell in Hampshire. He died without children in September 1554, when his baronies of De La Warr and West fell into abeyance. His monument may still be seen in the church at Broadwater, Sussex.

He had settled his estates on his nephew William West (c. 1519-1595), who then tried to bring about his uncle's death by poison; for this reason he was disabled by act of parliament (1549) from succeeding to his honours. However, in 1563 he was restored, and in 1570 was created by patent Baron De La Warr. This was obviously a new creation, but in 1596 his son Thomas (c. 1556-1602) claimed precedence in the baronage as the holder of the ancient barony of De La Warr. His claim was admitted, and accordingly his son and successor, next mentioned, is called the 3rd or the 12th baron.

**THOMAS WEST**, 3rd or 12th Baron De La Warr (1577-1618), British soldier and colonial governor in America, was born on the 9th of July 1577, probably at Wherwell, Hampshire, where he was baptized. He was educated at Queen's College, Oxford, where he did not complete his course, but subsequently (1605) received the degree of M.A. In 1597 he was elected member of parliament for Lympington, and subsequently fought in Holland and in Ireland under the earl of Essex, being knighted for bravery in battle in 1599. He was imprisoned for complicity in Essex's revolt (1600-1601), but was soon released and exonerated. In 1602 he succeeded to his father's title and estates and became a privy councillor. Becoming interested in schemes for the colonization of America, he was chosen a member of the council of the Virginia Company in 1609, and in the same year was appointed governor and captain-general of Virginia for life.

Sailing in March 1610 with three ships, 150 settlers and supplies, he himself bearing the greater part of the expense of the expedition, he arrived at Jamestown on the 10th of June, in time to intercept the colonists who had embarked for England and were abandoning the enterprise. Lord De La Warr's rule was strict but just; he constructed two forts near the mouth of the James river, rebuilt Jamestown, and in general brought order out of chaos. In March 1611 he returned to London, where he published at the request of the company's council, his *Relation* of the condition of affairs in Virginia (reprinted 1859 and 1868). He remained in England until 1618, when the news of the tyrannical rule of the deputy, Samuel Argall, led him to start again for Virginia. He embarked in April, but died en route on the 7th of June 1618, and was buried at sea. The Delaware river and the state of Delaware were named in his honour.

A younger brother, Francis (1586-c. 1634), was prominent in the affairs of Virginia, and in 1627-1628 was president of the council, and acting-governor of the colony.

In 1761 the 3rd or 12th baron's descendant, John, 7th or 16th Baron De La Warr (1693-1766), was created Viscount Cantelupe and 1st Earl De La Warr. He was a prominent figure in the House of Lords, at first as a supporter of Sir Robert Walpole. He also served in the British army and fought at Dettingen, and was made governor of Guernsey in 1752.

George John West, 5th earl (1791-1869), married Elizabeth, sister and heiress of George John Frederick Sackville, 4th duke of Dorset, who was created Baroness Buckhurst in 1864; consequently in 1843 he and his sons took the name of Sackville-West. The earl was twice lord chamberlain to Queen Victoria, and he is celebrated as "Fair Euryalus" in the *Childish Recollections* of his schoolfellow, Lord Byron. His son Charles Richard (1815-1873), 6th earl, served in the first Sikh war and in the Crimea, and being unmarried was succeeded by his brother Reginald (1817-1896) as 7th Earl De La Warr. Having inherited his mother's barony of Buckhurst on her death in 1870, he retained this title along with the barony and earldom of De La Warr, although the patent had contained a proviso that it should be kept separate from these dignities. In 1896 the 7th earl's son, Gilbert George Reginald Sackville-West (b. 1869), became 8th earl De La Warr.

See G. E. C(okayne), *Complete Peerage* (1887-1898).

**DELBRÜCK, HANS** (1848- ), German historian, was born at Bergen on the island of Rügen on the 11th of November 1848, and studied at the universities of Heidelberg and Bonn. As a soldier he fought in the Franco-German War, after which he was for some years tutor to one of the princes of the German imperial family. In 1885 he became professor of modern history in the university of Berlin, and he was a member of the German Reichstag from 1884 to 1890. Delbrück's writings are chiefly concerned with the history of the art of war, his most ambitious work being his *Geschichte der Kriegskunst im Rahmen der politischen Geschichte* (first section, *Das Altertum*, 1900; second, *Römer und Germanen*, 1902; third, *Das Mittelalter*, 1907). Among his other works are: *Die Perserkriege und die Burgunderkriege* (Berlin, 1887); *Historische und politische Aufsätze* (1886); *Erinnerungen, Aufsätze und Reden* (1902); *Die Strategie des Perikles erläutert durch die Strategie Friedrichs des Grossen* (1890); *Die Polenfrage* (1894); and *Das Leben des Feldmarschalls Grafen Neithardt von Gneisenau* (1882 and 1894). Delbrück began in 1883 to edit the *Preussische Jahrbücher*, in which he has written many articles, including one on "General Wolseley über Napoleon, Wellington und Gneisenau," and he has contributed to the *Europäischer Geschichtskalender* of H. Schulthess.

**DELBRÜCK, MARTIN FRIEDRICH RUDOLF VON**, Prussian statesman (1817-1903), was born at Berlin on the 16th of April 1817. On completing his legal studies he entered the service of the state in 1837; and after holding a series of minor posts was transferred in 1848 to the ministry of commerce, which was to be the sphere of his real life's work. Both Germany and Austria had realized the influence of commercial union upon political union. Delbrück in 1851 induced Hanover, Oldenburg and Schaumburg-Lippe to join the Zollverein; and the southern states, which had

agreed to admit Austria to the union, found themselves forced in 1853 to renew the old union, from which Austria was excluded. Delbrück now began, with the support of Bismarck, to apply the principles of free trade to Prussian fiscal policy. In 1862 he concluded an important commercial treaty with France. In 1867 he became the first president of the chancery of the North German Confederation, and represented Bismarck on the federal tariff council (*Zollbundesrath*), a position of political as well as fiscal importance owing to the presence in the council of representatives of the southern states. In 1868 he became a Prussian minister without portfolio. In October 1870, when the union of Germany under Prussian headship became a practical question, Delbrück was chosen to go on a mission to the South German states, and contributed greatly to the agreements concluded at Versailles in November. In 1871 he became president of the newly constituted *Reichskanzleramt*. Delbrück, however, began to feel himself uneasy under Bismarck's leanings towards protection and state control. On the introduction of Bismarck's plan for the acquisition of the railways by the state, Delbrück resigned office, nominally on the ground of ill-health (June 1, 1876). In 1879 he opposed in the *Reichstag* the new protectionist tariff, and on the failure of his efforts retired definitely from public life. In 1896 he received from the emperor the order of the Black Eagle. He died at Berlin on the 1st of February 1903.

**DELCASSÉ, THÉOPHILE** (1852— ), French statesman, was born at Pamiers, in the department of Ariège, on the 1st of March 1852. He wrote articles on foreign affairs for the *République française* and *Paris*, and in 1888 was elected *conseiller général* of his native department, standing as "un disciple fidèle de Gambetta." In the following year he entered the chamber as deputy for Foix. He was appointed under-secretary for the colonies in the second Ribot cabinet (January to April 1893), and retained his post in the Dupuy cabinet till its fall in December 1893. It was largely owing to his efforts that the French colonial office was made a separate department with a minister at its head, and to this office he was appointed in the second Dupuy cabinet (May 1894 to January 1895). He gave a great impetus to French colonial enterprise, especially in West Africa, where he organized the newly acquired colony of Dahomey, and despatched the Liotard mission to the Upper Ubangi. While in opposition he devoted special attention to naval affairs, and in speeches that attracted much notice declared that the function of the French navy was to secure and develop colonial enterprise, deprecated all attempts to rival the British fleet, and advocated the construction of commerce destroyers as France's best reply to England. On the formation of the second Brisson cabinet in June 1898 he succeeded M. Hanotaux at the foreign office, and retained that post under the subsequent premierships of MM. Dupuy, Waldeck-Rousseau, Combes and Rouvier. In 1898 he had to deal with the delicate situation caused by Captain Marchand's occupation of Fashoda, for which, as he admitted in a speech in the chamber on the 23rd of January 1899, he accepted full responsibility, since it arose directly out of the Liotard expedition, which he had himself organized while minister for the colonies; and in March 1899 he concluded an agreement with Great Britain by which the difficulty was finally adjusted, and France consolidated her vast colonial empire in North-West Africa. In the same year he acted as mediator between the United States and Spain, and brought the peace negotiations to a successful conclusion. He introduced greater cordiality into the relations of France with Italy: at the same time he adhered firmly to the alliance with Russia, and in August 1899 made a visit to St Petersburg, which he repeated in April 1901. In June 1900 he made an arrangement with Spain, fixing the long-disputed boundaries of the French and Spanish possessions in West Africa. Finally he concluded with England the important Agreements of 1904 covering colonial and other questions which had long been a matter of dispute, especially concerning Egypt, Newfoundland and Morocco. Suspicion of the growing *entente* between France and England soon arose on the part of Germany, and in 1905 German assertiveness was shown in a crisis which was forced on in the matter of the French activity in Morocco (*q.v.*), in which the handling of

French policy by M. Delcassé personally was a sore point with Germany. The situation became acute in April, and was only relieved by M. Delcassé's resignation of office. He retired into private life, but in 1908 was warmly welcomed on a visit to England, where the closest relations now existed with France.

**DEL CREDERE** (Ital. "of belief" or "trust"). A "del credere agent," in English law, is one who, selling goods for his principal on credit, undertakes for an additional commission to sell only to persons who are absolutely solvent. His position is thus that of a surety who is liable to his principal should the vendee make default. The agreement between him and his principal need not be reduced to or evidenced by writing, for his undertaking is not a guarantee within the Statute of Frauds. See also **BROKER**; **GUARANTEE**.

**DELESCLUZE, LOUIS CHARLES** (1809-1871), French journalist, was born at Dreux on the 2nd of October 1809. Having studied law in Paris, he early developed a strong democratic bent, and played a part in the July revolution of 1830. He became a member of various republican societies, and in 1836 was forced to take refuge in Belgium, where he devoted himself to republican journalism. Returning in 1840 he settled in Valenciennes, and after the revolution of 1848 removed to Paris, where he started a newspaper called *La Révolution démocratique et sociale*. His zeal so far outran his discretion that he was twice imprisoned and fined, his paper was suppressed and he himself fled to England, where he continued his journalistic work. He was arrested in Paris in 1853, and deported to French Guiana. Released under the amnesty of 1859, he returned to France with health shattered but energies unimpaired. His next venture was the publication of the *Réveil*, a radical organ upholding the principles of the *Association internationale des travailleurs*, known as the "*Internationale*." This journal, which brought him three condemnations, fine and imprisonment in one year, shared the fate of his Paris sheet, and its founder again fled to Belgium. In 1871 he was elected to the National Assembly, becoming afterwards a member of the Paris commune. At the siege of Paris he fought with reckless courage, and met his death on the last of the barricades (May 1871). He wrote an account of his imprisonment in Guiana, *De Paris à Cayenne, Journal d'un transporté* (Paris, 1869).

**DELESSE, ACHILLE ERNEST OSCAR JOSEPH** (1817-1881), French geologist and mineralogist, was born at Metz on the 3rd of February 1817. At the age of twenty he entered the École Polytechnique, and subsequently passed through the École des Mines. In 1845 he was appointed to the chair of mineralogy and geology at Besançon; in 1850 to the chair of geology at the Sorbonne in Paris; and in 1864 professor of agriculture at the École des Mines. In 1878 he became inspector-general of mines. In early years as *ingénieur des mines* he investigated and described various new minerals; he proceeded afterwards to the study of rocks, devising new methods for their determination, and giving particular descriptions of melaphyre, arkose, porphyry, syenite, &c. The igneous rocks of the Vosges, and those of the Alps, Corsica, &c., and the subject of metamorphism occupied his attention. He also prepared in 1858 geological and hydrological maps of Paris—with reference to the underground water, similar maps of the departments of the Seine and Seine-et-Marne, and an agronomic map of the Seine-et-Marne (1880), in which he showed the relation which exists between the physical and chemical characters of the soil and the geological structure. His annual *Revue des progrès de géologie*, undertaken with the assistance (1860-1865) of Auguste Laugel and afterwards (1865-1878) of Albert de Lapparent, was carried on from 1860 to 1880. His observations on the lithology of the deposits accumulated beneath the sea were of special interest and importance. His separate publications were: *Recherches sur l'origine des roches* (Paris, 1865); *Étude sur le métamorphisme des roches* (1869); *Lithologie des mers de France et des mers principales du globe* (2 vols. and atlas, 1871). He died at Paris on the 24th of March 1881.

**DELESSERT, JULES PAUL BENJAMIN** (1773-1847), French banker, was born at Lyons on the 14th of February 1773. The son of Étienne Delessert (1735-1816), the founder of the first



fire insurance company and the first discount bank in France. Young Delessert was travelling in England when the Revolution broke out in France, but he hastened back to join the Paris National Guard in 1790, becoming an officer of artillery in 1793. His father bought him out of the army, however, in 1795 in order to entrust him with the management of his bank. Gifted with remarkable energy, he started many commercial enterprises, founding the first cotton factory at Passy in 1801, and a sugar factory in 1802, for which he was created a baron of the empire. He sat in the chamber of deputies for many years, and was a strong advocate for many humane measures, notably the suppression of the "Tours" or revolving box at the foundling hospital, the suppression of the death penalty, and the improvement of the penitentiary system. He was made regent of the Bank of France in 1802, and was also member of, and, indeed, founder of many, learned and philanthropic societies. He founded the first savings bank in France, and maintained a keen interest in it until his death in 1847. He was also an ardent botanist and conchologist; his botanical library embraced 30,000 volumes, of which he published a catalogue—*Musté botanique de M. Delessert* (1845). He also wrote *Des avantages de la caisse d'épargne et de prévoyance* (1835), *Mémoire sur un projet de bibliothèque royale* (1836), *Le Guide de bonheur* (1839), and *Recueil de coquilles décrites par Lamarck* (1841-1842).

**DELFIKO, MELCHIORRE** (1744-1835), Italian economist, was born at Teramo in the Abruzzi on the 1st of August 1744, and was educated at Naples. He devoted himself specially to the study of jurisprudence and political economy, and his numerous publications exercised great practical influence in the correction and extinction of many abuses. Under Joseph Bonaparte Delfico was made a councillor of state, an office which he held until the restoration of Ferdinand IV., when he was appointed president of the commission of archives, from which he retired in 1825. He died at Teramo on the 21st of June 1835. His more important works were: *Saggio filosofico sul matrimonio* (1774); *Memoria sul Tribunale della Grascia e sulle leggi economiche nelle provincie confinanti del regno* (1785), which led to the abolition in Naples of the most vexatious and absurd restrictions on the sale and exportation of agricultural produce; *Riflessioni su la vendita dei feudi* (1790) and *Lettera a Sua Ecc. il sig. Duca di Cantalupo* (1795), which brought about the abolition of feudal rights over landed property and their sale; *Ricerche sul vero carattere della giurisprudenza Romana e dei suoi cultori* (1791); *Pensieri su la storia e su l'incertezza ed inutilità della medesima* (1806), both on the early history of Rome.

See F. Mozzetti, *Degli studii, delle opere e delle virtù di Melchiorre Delfico*; Tiplado's *Biographia degli Italiani illustri* (vol. ii.).

**DELFT**, a town of Holland in the province of South Holland, on the Schie, 5 m. by rail S.E. by S. of the Hague, with which it is also connected by steam-tramway. Pop. (1900) 31,582. It is a quiet, typically Dutch town, with its old brick houses and tree-bordered canals. The Prinsenhof, previously a monastery, was converted into a residence for the counts of Orange in 1575; it was here that William the Silent was assassinated. It is now used as a William of Orange Museum. The New Church, formerly the church of St Ursula (14th century), is the burial place of the princes of Orange. It is remarkable for its fine tower and chime of bells, and contains the splendid allegorical monument of William the Silent, executed by Hendrik de Keyser and his son Pieter about 1621, and the tomb of Hugo Grotius, born in Delft in 1583, whose statue, erected in 1886, stands in the market-place outside the church. The Old Church, founded in the 11th century, but in its present form dating from 1476, contains the monuments of two famous admirals of the 17th century, Martin van Tromp and Piet Hein, as well as the tomb of the naturalist Leeuwenhoek, born at Delft in 1632. In the town hall (1618) are some corporation pictures, portraits of the counts of Orange and Nassau, including several by Michiel van Mierevelt (1567-1641), one of the earliest Dutch portrait painters, and with his son Pieter (1595-1623), a native of Delft. There are also a Roman Catholic church (1882) and a synagogue. Two important educational establishments are the Indian

Institute for the education of civil service students for the colonies, to which is attached an ethnographical museum; and the Royal Polytechnic school, which almost ranks as a university, and teaches, among other sciences, that of diking. A fine collection of mechanical models is connected with the polytechnic school. Among other buildings are the modern "Phoenix" club-house of the students; the hospital, containing some anatomical pictures, including one by the two Mierevelts (1617); a lunatic asylum; the Van Renswoude orphanage, the theatre, a school of design, the powder magazine and the state arsenal, originally a warehouse of the East India Company, and now used as a manufactory of artillery stores.

The name of Delft is most intimately associated with the manufacture of the beautiful faience pottery for which it was once famous. (See CERAMICS.) This industry was imported from Haarlem towards the end of the 16th century, and achieved an unrivalled position in the second half of the following century; but it did not survive the French occupation at the end of the 18th century. It has, however, been revived in modern times under the name of "New Delft." Other branches of industry are carpet-weaving, distilling, oil and oil-cake manufacture, dyeing, cooperage and the manufacture of arms and bullets. There is also an important butter and cheese market.

Delft was founded in 1075 by Godfrey III., duke of Lower Lorraine, after his conquest of Holland, and came subsequently into the hands of the counts of Holland. In 1246 it received a charter from Count William II. (see C. Hegel, *Städte und Gilden*, ii. 251). In 1536 it was almost totally destroyed by fire, and in 1654 largely ruined by the explosion of a powder magazine.

**DELHI, DEHLI** or **DILLI**, the ancient capital of the Mogul empire in India, and a modern city which gives its name to a district and division of British India. The city of Delhi is situated in 28° 38' N., 77° 13' E., very nearly due north of Cape Comorin, and practically in a latitudinal line with the more ancient cities of Cairo and Canton. It lies in the south-east corner of the province of the Punjab, to which it was added in 1858, and abuts on the right bank of the river Jumna. Though Lahore, the more ancient city, remains the official capital of the Punjab, Delhi is historically more famous, and is now more important as a commercial and railway centre.

Though the remains of earlier cities are scattered round Delhi over an area estimated to cover some 45 sq. m., modern Delhi dates only from the middle of the 17th century, when Shah Jahan rebuilt the city on its present site, adding the title Shah-jahanabad from his own name. It extends for nearly 2½ m. along the right bank of the Jumna from the Water bastion to the Wellesley bastion in the south-east corner, nearly one-third of the frontage being occupied by the river wall of the palace. The northern wall, famous in the siege of Delhi in 1857, extends three-quarters of a mile from the Water bastion to the Shah, commonly known as the Mori. bastion; the length of the west wall from this bastion to the Ajmere gate is 1½ m. and of the south wall to the Wellesley bastion again almost exactly the same distance, the whole land circuit being thus 3½ m. The complete circuit of Delhi is 5½ m. In the north wall is situated the famous Kashmir gate, while the Mori or Drain gate, which was built by a Mahratta governor, has now been removed. In the west wall are the Farash Khana and Ajmere gates, while the Kabul and Lahore gates have been removed. In the south wall are the Turkman and Delhi gates. The gates on the river side of the city included the Khairati and Rajghat, the Calcutta and Nigambod—both removed; the Kela gate, and the Badar Rao gate, now closed. The great wall of Delhi, which was constructed by Shah Jahan, was strengthened by the English by the addition of a ditch and glacis, after Delhi was captured by Lord Lake in 1803; and its strength was turned against the British at the time of the Mutiny. The imperial palace (1638-1648), now known as the "Fort," is situated on the east of the city, and abuts directly on the river. It consists at present of bare and ugly British barracks, among which are scattered exquisite gems of oriental architecture. The

two most famous among its buildings are the Diwan-i-Am or Hall of Public Audience, and the Diwan-i-Khas or Hall of Private Audience. The Diwan-i-Am is a splendid building measuring 100 ft. by 60 ft., and was formerly plastered with chunam and overlaid with gold. The most striking effect now lies in its engrailed arches. It was in the recess in the back wall of this hall that the famous Peacock Throne used to stand, "so called from its having the figures of two peacocks standing behind it, their tails being expanded and the whole so inlaid with sapphires, rubies, emeralds, pearls and other precious stones of appropriate colours as to represent life." Tavernier, the French jeweller, who saw Delhi in 1665, describes the throne as of the shape of a bed, 6 ft. by 4 ft., supported by four golden feet, 20 to 25 in. high, from the bars above which rose twelve columns to support the canopy; the bars were decorated with crosses of rubies and emeralds, and also with diamonds and pearls. In all there were 108 large rubies on the throne, and 116 emeralds, but many of the latter had flaws. The twelve columns supporting the canopy were decorated with rows of splendid pearls, and Tavernier considered these to be the most valuable part of the throne. The whole was valued at £6,000,000. This throne was carried off by the Persian invader Nadir Shah in 1739, and has been rumoured to exist still in the Treasure House of the Shah of Persia; but Lord Curzon, who examined the thrones there, says that nothing now exists of it, except perhaps some portions worked up in a modern Persian throne. The Diwan-i-Khas is smaller than the Diwan-i-Am, and consists of a pavilion of white marble, in the interior of which the art of the Moguls reached the perfection of its jewel-like decoration. On a marble platform rises a marble pavilion, the flat-coned roof of which is supported on a double row of marble pillars. The inner face of the arches, with the spandrels and the pilasters which support them, are covered with flowers and foliage of delicate design and dainty execution, crusted in green serpentine, blue *lapis lazuli* and red and purple porphyry. During the lapse of years many of these stones were picked from their setting, and the silver ceiling of flowered patterns was pillaged by the Mahrattas; but the inlaid work was restored as far as possible by Lord Curzon. It is in this hall that the famous inscription "If a paradise be on the face of the earth, it is this, it is this, it is this," still exists. It is given in Persian characters twice in the panels over the narrow arches at the ends of the middle hall, beginning from the east on the north side, and from the west at the south side. At the time of the Delhi Durbar held in January 1903 to celebrate the proclamation of Edward VII. as emperor of India these two halls were used as a dancing-room and supper-room, and their full beauty was brought out by the electric light shining through their marble grille-work.

The native city of Delhi is like most other cities in India, a huddle of mean houses in mean streets, diversified with splendid mosques. The Chandni Chauk ("silver street"), the principal street of Delhi, which was once supposed to be the richest street in the world, has fallen from its high estate, though it is still a broad and imposing avenue with a double row of trees running down the centre. During the course of its history it was four times sacked, by Nadir Shah, Timur, Ahmad Shah and the Mahrattas, and its roadway has many times run with blood. Now it is the abode of the jewellers and ivory-workers of Delhi, but the jewels are seldom valuable and the carving has lost much of its old delicacy. A short distance south of the Chandni Chauk the Jama Masjid, or Great Mosque, rises boldly from a small rocky eminence. It was erected in 1648-1650, two years after the royal palace, by Shah Jahan. Its front court, 450 ft. square, and surrounded by a cloister open on both sides, is paved with granite inlaid with marble, and commands a fine view of the city. The mosque itself, a splendid structure forming an oblong 261 ft. in length, is approached by a magnificent flight of stone steps. Three domes of white marble rise from its roof, with two tall minarets at the front corners. The interior of the mosque is paved throughout, and the walls and roof are lined with white marble. Two other mosques in Delhi itself deserve passing notice, the Kala Masjid or Black Mosque, which was built about 1380 in the reign of

Feroz Shah, and the Moti Masjid or Pearl Mosque, a tiny building added to the palace by Aurangzeb, as the emperor's private place of prayer. It is only 60 ft. square, and the domes alone are seen above the red sandstone walls until the opening of two small fine brass gates.

To the west and north-west of Delhi considerable suburbs cluster beyond the walls. Here are the tombs of the imperial family. That of Humayun, the second of the Mogul dynasty, is a noble building of rose-coloured sandstone inlaid with white marble. It lies about 3 m. from the city, in a terraced garden, the whole surrounded by an embattled wall, with towers and four gateways. In the centre stands a platform about 20 ft. high by 200 ft. square, supported by arches and ascended by four flights of steps. Above, rises the mausoleum, also a square, with a great dome of white marble in the centre. About a mile to the west is another burying-ground, or collection of tombs and small mosques, some of them very beautiful. The most remarkable is perhaps the little chapel in honour of a celebrated Mussulman saint, Nizam-ud-din, near whose shrine the members of the imperial family, up to the time of the Mutiny, lie buried, each in a small enclosure surrounded by lattice-work of white marble.

Still farther away, some 10 m. south of the modern city, amid the ruins of old Delhi, stands the Kutb Minar, which is supposed to be the most perfect tower in the world, and one of the seven architectural wonders of India. The Minar was begun by Kutb-ud-din Aibak about A.D. 1200. The two top storeys were rebuilt by Feroz Shah. It consists of five storeys of red sandstone and white marble. The purplish red of the sandstone at the base is finely modulated, through a pale pink in the second storey, to a dark orange at the summit, which harmonizes with the blue of an Indian sky. Dark bands of Arabic writing round the three lower storeys contrast with the red sandstone. The height of the column is 238 ft. The plinth is a polygon of twenty sides. The basement storey has the same number of faces formed into convex flutes which are alternately angular and semicircular. The next has semicircular flutes, and in the third they are all angular. Then rises a plain storey, and above it soars a partially fluted storey, the shaft of which is adorned with bands of marble and red sandstone. A bold projecting balcony, richly ornamented, runs round each storey. After six centuries the column is almost as fresh as on the day it was finished. It stands in the south-east corner of the outer court of the mosque erected by Kutb-ud-din immediately after his capture of Delhi in 1193. The design of this mosque is Mahomedan, but the wonderfully delicate ornamentation of its western façade and other remaining parts is Hindu. In the inner courtyard of the mosque stands the Iron Pillar, which is probably the most ancient monument in the neighbourhood of Delhi, dating from about A.D. 400. It consists of a solid shaft of wrought iron some 16 in. in diameter and 23 ft. 8 in. in height, with an inscription eulogizing Chandragupta Vikramaditya. It was brought, probably from Muttra, by Anang Pal, a Rajput chief of the Tomaras, who erected it here in 1052.<sup>1</sup>

Among the modern buildings of Delhi may be mentioned the Residency, now occupied by a government high school, and the Protestant church of St James, built at a cost of £10,000 by Colonel Skinner, an officer well known in the history of the East India Company. About half-way down the Chandni Chauk is a high clock-tower. Near it is the town hall, with museum and library. Behind the Chandni Chauk, to the north, lie the Queen's Gardens; beyond them the "city lines" stretch away as far as the well-known rocky ridge, about a mile outside the town. From the summit of this ridge the view of the station and city is very picturesque. The principal local institution until 1877 was the Delhi College, founded in 1792. It was at first exclusively an oriental school, supported by the voluntary contributions of Mahomedan gentlemen, and managed by a committee of the subscribers. In 1829 an English department was added to it; and in 1855 the institution was placed under the control of the Educational Department. In the Mutiny of 1857 the old

<sup>1</sup> See the paper by V. A. Smith in the *Journal of the Royal Asiatic Soc.* (1897), p. 13.

college was plundered of a very valuable oriental library, and the building completely destroyed. A new college was founded in 1858, and was affiliated to the university of Calcutta in 1864. The old college attained to great celebrity as an educational institution, and produced many excellent scholars, but it was abolished in 1877, in order to concentrate the grant available for higher-class education upon the Punjab University at Lahore.

The Ridge, famous as the British base during the siege of Delhi during the Mutiny, in 1857, is a last outcrop of the Aravalli Hills which rises in a steep escarpment some 60 ft. above the city. At its nearest point on the right of the British position, where the Mutiny Memorial now stands, the Ridge is only 1200 yds. from the walls of Delhi; at the Flagstaff Tower in the centre of the position it is a mile and a half away; and at the left near the river nearly two miles and a half. It was behind the Ridge at this point that the main portion of the British camp was pitched. The Mutiny Memorial, which was erected by the army before Delhi, is a rather poor specimen of a Gothic spire in red sandstone, while the memorial tablets are of inferior marble. Next to the Ridge the point of most interest to every English visitor to Delhi is Nicholson's grave, which lies surrounded by an iron railing in the Kashmir gate cemetery. The Kashmir gate itself bears a slab recording the gallant deed of the party under Lieutenants D. C. Home and P. Salkeld, who blew in the gate in broad daylight on the day that Delhi was taken by assault.

The population of Delhi according to the census of 1901 was 208,575, of whom 88,460 were Mahomedans and 114,417 were Hindus. The city is served by five different railways, the East Indian, the Oudh & Rohilkhand, the Rajputana-Malwa & Bombay-Baroda, the Southern Punjab, and the North-Western, and occupies a central position, being 940 m. from Karachi, 950 from Calcutta, and 960 from Bombay. Owing to the advantages it enjoys as a trade centre, Delhi is recovering much of the prominence which it lost at the time of the Mutiny. It has spinning-mills and other mills worked by steam. The principal manufactures are gold and silver filigree work and embroidery, jewelry, muslins, shawls, glazed pottery and wood-carving.

The DISTRICT OF DELHI has an area of 1290 sq. m. It consists of a strip of territory on the right or west bank of the Jumna river, 75 m. in length, and varying from 15 to 233 m. in breadth. Most of the district consists of hard and stony soil, depending upon irrigation, which is supplied by the Western Jumna canal, the Ali Mardan canal and the Agra canal. The principal crops are wheat, barley, sugar-cane and cotton.

When Lord Lake broke the Mahratta power in 1803, and the emperor was taken under the protection of the East India Company, the present districts of Delhi and Hissar were assigned for the maintenance of the royal family, and were administered by a British resident. In 1832 the office of resident was abolished, and the tract was annexed to the North-Western Provinces. After the Mutiny in 1858 it was separated from the North-Western Provinces and annexed to the Punjab. The population in 1901 was 689,039.

The DIVISION OF DELHI stretches from Simla to Rajputana, and is much broken up by native states. It comprises the seven districts of Hissar, Rohtak, Gurgaon, Delhi, Karnal, Umballa and Simla. Its total area is 15,393 sq. m., and in 1901 the population was 4,587,092.

*History.*—According to legends, which may or may not have a substantial basis, Delhi or its immediate neighbourhood has from time immemorial been the site of a capital city. The neighbouring village of Indarpat preserves the name of Indraprashta, the semi-mythical city founded, according to the Sanscrit epic *Mahabharata*, by Yudisthira and his brothers, the five Pandavas. Whatever its dim predecessors may have been, however, the actual history of Delhi dates no further back than the 11th century A.D., when Anangapala (Anang Pal), a chief of the Tomara clan, built the Red Fort, in which the Kutb Minar now stands; in 1052 the same chief removed the famous Iron Pillar from its original position, probably at Muttra, and set it up among a group of temples of which the materials were afterwards used by the Mussulmans for the construction of the great

Kutb Mosque. About the middle of the 12th century the Tomara dynasty was overthrown by Vighraha-*raja* (Visala-deva, Bisal Deo), the Chauhan king of Ajmere, who from inscribed records discovered of late years appears to have been a man of considerable culture (see V. A. Smith, *Early Hist. of India*, ed. 1908, p. 356). His nephew and successor was Prithwi-*raja* (Prithiraj, or Rai Pithora), lord of Sambhar, Delhi and Ajmere, whose fame as lover and warrior still lives in popular story. He was the last Hindu ruler of Delhi. In 1191 came the invasion of Mahommed of Ghor. Defeated on this occasion, Mahommed returned two years later, overthrew the Hindus, and captured and put to death Prithwi-*raja*. Delhi became henceforth the capital of the Mahomedan Indian empire, Kutb-ud-din (the general and slave of Mahommed of Ghor) being left in command. His dynasty is known as that of the slave kings, and it is to them that old Delhi owes its grandest remains, among them Kutb Mosque and the Kutb Minar. The slave dynasty retained the throne till 1290, when it was subverted by Jalal-ud-din Khilji. The most remarkable monarch of this dynasty was Ala-ud-din, during whose reign Delhi was twice exposed to attack from invading hordes of Moguls. On the first occasion Ala-ud-din defeated them under the walls of his capital; on the second, after encamping for two months in the neighbourhood of the city, they retired without a battle. The house of Khilji came to an end in 1321, and was followed by that of Tughlak. Hitherto the Pathan kings had been content with the ancient Hindu capital, altered and adorned to suit their tastes. But one of the first acts of the founder of the new dynasty, Ghias-ud-din Tughlak, was to erect a new capital about 4 m. farther to the east, which he called Tughlakabad. The ruins of his fort remain, and the eye can still trace the streets and lanes of the long deserted city. Ghias-ud-din was succeeded by his son Mahommed b. Tughlak, who reigned from 1325 to 1351, and is described by Elphinstone as "one of the most accomplished princes and most furious tyrants that ever adorned or disgraced human nature." Under this monarch the Delhi of the Tughlak dynasty attained its utmost growth. His successor Feroz Shah Tughlak transferred the capital to a new town which he founded some miles off, on the north of the Kutb, and to which he gave his own name, Ferozabad. In 1398, during the reign of Mahmud Tughlak, occurred the Tatar invasion of Timurlane. The king fled to Gujarat, his army was defeated under the walls of Delhi, and the city surrendered. The town, notwithstanding a promise of protection, was plundered and burned; the citizens were massacred. The invaders at last retired, leaving Delhi without a government, and almost without inhabitants. At length Mahmud Tughlak regained a fragment of his former kingdom, but on his death in 1412 the family became extinct. He was succeeded by the Sayyid dynasty, which held Delhi and a few miles of surrounding territory till 1444, when it gave way to the house of Lodi, during whose rule the capital was removed to Agra. In 1526 Baber, sixth in descent from Timurlane, invaded India, defeated and killed Ibrahim Lodi at the battle of Panipat, entered Delhi, was proclaimed emperor, and finally put an end to the Afghan empire. Baber's capital was at Agra, but his son and successor, Humayun, removed it to Delhi. In 1540 Humayun was defeated and expelled by Sher Shah, who entirely rebuilt the city, enclosing and fortifying it with a new wall. In his time Delhi extended from where Humayun's tomb now is to near the southern gate of the modern city. In 1555 Humayun, with the assistance of Persia, regained the throne; but he died within six months, and was succeeded by his son, the illustrious Akbar.

During Akbar's reign and that of his son Jahangir, the capital was either at Agra or at Lahore, and Delhi once more fell into decay. Between 1638 and 1658, however, Shah Jahan rebuilt it almost in its present form; and his city remains substantially the Delhi of the present time. The imperial palace, the Jama Masjid or Great Mosque, and the restoration of what is now the western Jumna canal, are the work of Shah Jahan. The Mogul empire rapidly expanded during the reigns of Akbar and his successors down to Aurungzeb, when it attained its climax. After the death of the latter monarch, in 1707, came the decline. Insurrections

and civil wars on the part of the Hindu tributary chiefs, Sikhs and Mahrattas, broke out. Aurungzeb's successors became the helpless instruments of conflicting chiefs. His grandson, Jahandar Shah, was, in 1713, deposed and strangled after a reign of one year; and Farrakhsiiyyar, the next in succession, met with the same fate in 1719. He was succeeded by Mahommed Shah, in whose reign the Mahratta forces first made their appearance before the gates of Delhi, in 1736. Three years later the Persian monarch, Nadir Shah, after defeating the Mogul army at Karnal, entered Delhi in triumph. While engaged in levying a heavy contribution, the Persian troops were attacked by the populace, and many of them were killed. Nadir Shah, after vainly attempting to stay the tumult, at last gave orders for a general massacre of the inhabitants. For fifty-eight days Nadir Shah remained in Delhi, and when he left he carried with him a treasure in money amounting, at the lowest computation, to eight or nine millions sterling, besides jewels of inestimable value, and other property to the amount of several millions more.

From this time (1740) the decline of the empire proceeded unchecked and with increased rapidity. In 1771 Shah Alam, the son of Alamgir II., was nominally raised to the throne by the Mahrattas, the real sovereignty resting with the Mahratta chief, Sindhia. An attempt of the puppet emperor to shake himself clear of the Mahrattas, in which he was defeated in 1788, led to a permanent Mahratta garrison being stationed at Delhi. From this date, the king remained a cipher in the hands of Sindhia, who treated him with studied neglect, until the 8th of September 1803, when Lord Lake overthrew the Mahrattas under the walls of Delhi, entered the city, and took the king under the protection of the British. Delhi, once more attacked by a Mahratta army under the Mahratta chief Holkar in 1804, was gallantly defended by Colonel Ochterlony, the British resident, who held out against overwhelming odds for eight days, until relieved by Lord Lake. From this date a new era in the history of Delhi began. A pension of £120,000 per annum was allowed to the king, with exclusive jurisdiction over the palace, and the titular sovereignty as before; but the city, together with the Delhi territory, passed under British administration.

Fifty-three years of quiet prosperity for Delhi were brought to a close by the Mutiny of 1857. Its capture by the mutineers, its siege, and its subsequent recapture by the British have been often told, and nothing beyond a short notice is called for here. The outbreak at Meerut occurred on the night of the 10th of May 1857. Immediately after the murder of their officers, the rebel soldiery set out for Delhi, about 35 m. distant, and on the following morning entered the city, where they were joined by the city mob. Mr Fraser, the commissioner, Mr Hutchinson, the collector, Captain Douglas, the commandant of the palace guards, and the Rev. Mr Jennings, the residency chaplain, were at once murdered, as were also most of the civil and non-official residents whose houses were situated within the city walls. The British troops in cantonments consisted of three regiments of native infantry and a battery of artillery. These cast in their lot with the mutineers, and commenced by killing their officers. The Delhi magazine, then the largest in the north-west of India, was in the charge of Lieutenant Willoughby, with whom were two other officers and six non-commissioned officers. The magazine was attacked by the mutineers, but the little band defended to the last the enormous accumulation of munitions of war stored there, and, when further defence was hopeless, fired the magazine. Five of the nine were killed by the explosion, and Lieutenant Willoughby subsequently died of his injuries; the remaining three succeeded in making their escape. The occupation of Delhi by the rebels was the signal for risings in almost every military station in North-Western India. The revolted soldiery with one accord thronged towards Delhi, and in a short time the city was garrisoned by a rebel army variously estimated at from 50,000 to 70,000 disciplined men. The pensioned king, Bahadur Shah, was proclaimed emperor; his sons were appointed to various military commands. About fifty Europeans and Eurasians, nearly all females, who had been captured in trying to escape from the town on the day of the outbreak, were confined in a stifling chamber

of the palace for fifteen days; they were then brought out and massacred in the court-yard.

The siege which followed forms one of the memorable incidents of the British history of India. On the 8th June, four weeks after the outbreak, Sir H. Barnard, who had succeeded as commander-in-chief on the death of General Anson, routed the mutineers with a handful of Europeans and Sikhs, after a severe action at Badli-ki-Serai, and encamped upon the Ridge that overlooks the city. The force was too weak to capture the city, and he had no siege train or heavy guns. All that could be done was to hold the position till the arrival of reinforcements and of a siege train. During the next three months the little British force on the Ridge were rather the besieged than the besiegers. Almost daily sallies, which often turned into pitched battles, were made by the rebels upon the over-worked handful of Europeans, Sikhs and Gurkhas. A great struggle took place on the centenary of the battle of Plassey (June 23), and another on the 25th of August; but on both occasions the mutineers were repulsed with heavy loss. General Barnard died of cholera in July, and was succeeded by General Archdale Wilson. Meanwhile reinforcements and siege artillery gradually arrived, and early in September it was resolved to make the assault. The first of the heavy batteries opened fire on the 8th of September, and on the 13th a practicable breach was reported.

On the morning of the 14th Sept. the assault was delivered, the points of attack being the Kashmir bastion, the Water bastion, the Kashmir gate, and the Lahore gate. The assault was thoroughly successful, although the column which was to enter the city by the Lahore gate sustained a temporary check. The whole eastern part of the city was retaken, but at a cost of 66 officers and 1104 men killed and wounded, out of the total strength of 9866. Fighting continued more or less during the next six days, and it was not till the 20th of September that the entire city and palace were occupied, and the reconquest of Delhi was complete. During the siege, the British force sustained a loss of 1012 officers and men killed, and 3837 wounded. Among the killed was General John Nicholson, the leader of one of the storming parties, who was shot through the body in the act of leading his men, in the first day's fighting. He lived, however, to learn that the whole city had been recaptured, and died on the 23rd of September. On the flight of the mutineers, the king and several members of the royal family took refuge at Humayun's tomb. On receiving a promise that his life would be spared, the last of the house of Timur surrendered to Major Hodson; he was afterwards banished to Rangoon. Delhi, thus reconquered, remained for some months under military authority. Owing to the murder of several European soldiers who strayed from the lines, the native population was expelled the city. Hindus were soon afterwards readmitted, but for some time Mahommedans were rigorously excluded. Delhi was made over to the civil authorities in January 1858, but it was not till 1861 that the civil courts were regularly reopened. The shattered walls of the Kashmir gateway, and the bastions of the northern face of the city, still bear the marks of the cannonade of September 1857. Since that date Delhi has settled down into a prosperous commercial town, and a great railway centre. The lines which start from it to the north, south, east and west bring into its bazaars the trade of many districts. But the romance of antiquity still lingers around it, and Delhi was selected for the scene of the Imperial Proclamation on the 1st of January 1877, and for the great Durbar held in January 1903 for the proclamation of King Edward VII. as emperor of India.

**AUTHORITIES.**—The best modern account of the city is *Delhi, Past and Present* (1901), by H. C. Fanshawe, a former commissioner of Delhi. Other authoritative works are *Cities of India* (1903) and *The Mutiny Papers* (1893), both by G. W. Forrest, and *Forty-one Years in India* (1897), by Lord Roberts; while some impressionistic sketches will be found in *Enchanted India* (1899), by Prince Bojidar Karageorgevitch. See also the chapter on Delhi in H. G. Keene, *Hist. of Hindustan . . . to the fall of the Mughol Empire* (1885). For the Delhi Durbar of 1903 see Stephen Wheeler, *Hist. of the Delhi Coronation Durbar*, compiled from official papers by order of the viceroy of India (London, 1904), which contains numerous portraits and other illustrations.

**DELIA**, a festival of Apollo held every five years at the great panegyris in Delos (Homeric *Hymn to Apollo*, 147). It included athletic and musical contests, at which the prize was a branch of the sacred palm. This festival was said to have been established by Theseus on his way back from Crete. Its celebration gradually fell into abeyance and was not revived till 426 B.C., when the Athenians purified the island and took so prominent a part in the maintenance of the Delia that it came to be regarded almost as an Athenian festival (Thucydides iii. 104). Ceremonial embassies (*θεωπαια*) from all the Greek cities were present.

See G. Gilbert, *Delos* (1869); J. A. Lebègue, *Recherches sur Délos* (1876); A. Mommsen, *Feste der Stadt Athen* (1898); E. Pfuhl, *De Atheniensium pompis sacris* (1900); G. F. Schömann, *Griechische Altertümer* (4th ed., 1897-1902); P. Stengel, *Die griechischen Kultusaltertümer* (1898); T. Homolle in Daremberg and Saglio's *Dictionnaire des antiquités*.

**DELIAN LEAGUE**, or CONFEDERACY OF DELOS, the name given to a confederation of Greek states under the leadership of Athens, with its headquarters at Delos, founded in 478 B.C. shortly after the final repulse of the expedition of the Persians under Xerxes I. This confederacy, which after many modifications and vicissitudes was finally broken up by the capture of Athens by Sparta in 404, was revived in 378-7 (the "Second Athenian Confederacy") as a protection against Spartan aggression, and lasted, at least formally, until the victory of Philip II. of Macedon at Chaeronea. These two confederations have an interest quite out of proportion to the significance of the detailed events which form their history. (See GREECE: *Ancient History*.) They are the first two examples of which we have detailed knowledge of a serious attempt at united action on the part of a large number of self-governing states at a relatively high level of conscious political development. The first league, moreover, in its later period affords the first example in recorded history of self-conscious imperialism in which the subordinate units enjoyed a specified local autonomy with an organized system, financial, military and judicial. The second league is further interesting as the precursor of the Achaean and Aetolian Leagues.

*History.*—Several causes contributed to the formation of the first Confederacy of Delos. During the 6th century B.C. Sparta had come to be regarded as the chief power, not only in the Peloponnese, but also in Greece as a whole, including the islands of the Aegean. The Persian invasions of Darius and Xerxes, with the consequent importance of maritime strength and the capacity for distant enterprise, as compared with that of purely military superiority in the Greek peninsula, caused a considerable loss of prestige which Sparta was unwilling to recognize. Moreover, it chanced that at the time the Spartan leaders were not men of strong character or general ability. Pausanias, the victor of Plataea, soon showed himself destitute of the high qualities which the situation demanded. Personal cupidity, discourtesy to the allies, and a tendency to adopt the style and manners of oriental princes, combined to alienate from him the sympathies of the Ionian allies, who realized that, had it not been for the Athenians, the battle of Salamis would never have been even fought, and Greece would probably have become a Persian satrapy. The Athenian contingent which was sent to aid Pausanias in the task of driving the Persians finally out of the Thracian towns was under the command of the Athenians, Aristides and Cimon, men of tact and probity. It is not, therefore, surprising that when Pausanias was recalled to Sparta on the charge of treasonable overtures to the Persians, the Ionian allies appealed to the Athenians on the grounds of kinship and urgent necessity, and that when Sparta sent out Dorcis to supersede Pausanias he found Aristides in unquestioned command of the allied fleet. To some extent the Spartans were undoubtedly relieved, in that it no longer fell to them to organize distant expeditions to Asia Minor, and this feeling was strengthened about the same time by the treacherous conduct of their king Leotychides (*q.v.*) in Thessaly. In any case the inelastic quality of the Spartan system was unable to adapt itself to the spirit of the new age. To Aristides was mainly due the organization of the new league and the adjustment of the contributions of the various

allies in ships or in money. His assessment, of the details of which we know nothing, was so fair that it remained popular long after the league of autonomous allies had become an Athenian empire. The general affairs of the league were managed by a synod which met periodically in the temple of Apollo and Artemis at Delos, the ancient centre sanctified by the common worship of the Ionians. In this synod the allies met on an equality under the presidency of Athens. Among its first subjects of deliberation must have been the ratification of Aristides' assessment. Thucydides lays emphasis on the fact that in these meetings Athens as head of the league had no more than presidential authority, and the other members were called *σύνμαχοι* (allies), a word, however, of ambiguous meaning and capable of including both free and subject allies. The only other fact preserved by Thucydides is that Athens appointed a board called the Hellenotamiae (*ραυτας*, steward) to watch over and administer the treasury of the league, which for some twenty years was kept at Delos, and to receive the contributions (*φόρος*) of the allies who paid in money.

The league was, therefore, specifically a free confederation of autonomous Ionian cities founded as a protection against the common danger which threatened the Aegean basin, and led by Athens in virtue of her predominant naval power as exhibited in the war against Xerxes. Its organization, adopted by the common synod, was the product of the new democratic ideal embodied in the Cleisthenic reforms, as interpreted by a just and moderate exponent. It is one of the few examples of free corporate action on the part of the ancient Greek cities, whose centrifugal yearning for independence so often proved fatal to the Hellenic world. It is, therefore, a profound mistake to regard the history of the league during the first twenty years of its existence as that of an Athenian empire. Thucydides expressly describes the predominance of Athens as *ἡγεμονία* (leadership, headship), not as *ἀρχή* (empire), and the attempts made by Athenian orators during the second period of the Peloponnesian War to prove that the attitude of Athens had not altered since the time of Aristides are manifestly unsuccessful.

Of the first ten years of the league's history we know practically nothing, save that it was a period of steady, successful activity against the few remaining Persian strongholds in Thrace and the Aegean (Herod. i. 106-107, see ATHENS, CIMON). In these years the Athenian sailors reached a high pitch of training, and by their successes strengthened that corporate pride which had been born at Salamis. On the other hand, it naturally came to pass that certain of the allies became weary of incessant warfare and looked for a period of commercial prosperity. Athens, as the chosen leader, and supported no doubt by the synod, enforced the contributions of ships and money according to the assessment. Gradually the allies began to weary of personal service and persuaded the synod to accept a money commutation. The Ionians were naturally averse from prolonged warfare, and in the prosperity which must have followed the final rout of the Persians and the freeing of the Aegean from the pirates (a very important feature in the league's policy) a money contribution was only a trifling burden. The result was, however, extremely bad for the allies, whose status in the league necessarily became lower in relation to that of Athens, while at the same time their military and naval resources correspondingly diminished. Athens became more and more powerful, and could afford to disregard the authority of the synod. Another new feature appeared in the employment of coercion against cities which desired to secede. Athens might fairly insist that the protection of the Aegean would become impossible if some of the chief islands were liable to be used as piratical strongholds, and further that it was only right that all should contribute in some way to the security which all enjoyed. The result was that, in the cases of Naxos and Thasos, for instance, the league's resources were employed not against the Persians but against recalcitrant Greek islands, and that the Greek ideal of separate autonomy was outraged. Shortly after the capture of Naxos (*c.* 467 B.C.) Cimon proceeded with a fleet of 300 ships (only 100 from the allies) to the southwestern and southern coasts of Asia Minor. Having driven the



Persians out of Greek towns in Lycia and Caria, he met and routed the Persians on land and sea at the mouth of the Eurymedon in Pamphylia. In 463 after a siege of more than two years the Athenians captured Thasos, with which they had quarrelled over mining rights in the Strymon valley. It is said (Thuc. i. 101) that Thasos had appealed for aid to Sparta, and that the latter was prevented from responding only by earthquake and the Helot revolt. But this is both unproved and improbable. Sparta had so far no quarrel with Athens. Athens thus became mistress of the Aegean, while the synod at Delos had become practically, if not theoretically, powerless. It was at this time that Cimon (*q.v.*), who had striven to maintain a balance between Sparta, the chief military, and Athens, the chief naval power, was successfully attacked by Ephialtes and Pericles. During the ensuing years, apart from a brief return to the Cimonian policy, the resources of the league, or, as it has now become, the Athenian empire, were directed not so much against Persia as against Sparta, Corinth, Aegina and Boeotia. (See ATHENS; SPARTA, &c.) A few points only need be dealt with here. The first years of the land war brought the Athenian empire to its zenith. Apart from Thessaly, it included all Greece outside the Peloponnese. At the same time, however, the Athenian expedition against the Persians in Egypt ended in a disastrous defeat, and for a time the Athenians returned to a philo-Laconian policy, perhaps under the direction of Cimon (see CIMON and PERICLES). Peace was made with Sparta, and, if we are to believe 4th-century orators, a treaty, the Peace of Callias or of Cimon, was concluded between the Great King and Athens in 449 after the death of Cimon before the walls of Citium in Cyprus. The meaning of this so-called Peace of Callias is doubtful. Owing to the silence of Thucydides and other reasons, many scholars regard it as merely a cessation of hostilities (see CIMON and CALLIAS, where authorities are quoted). At all events, it is significant of the success of the main object of the Delian League, the Athenians resigning Cyprus and Egypt, while Persia recognized the freedom of the maritime Greeks of Asia Minor.

During this period the power of Athens over her allies had increased, though we do not know anything of the process by which this was brought about. Chios, Lesbos and Samos alone furnished ships; all the rest had commuted for a money payment. This meant that the synod was quite powerless. Moreover in 454 (probably) the changed relations were crystallized by the transference (proposed by the Samians) of the treasury to Athens (*Corp. Inscr. Attic.* i. 260). Thus in 448 B.C. Athens was not only mistress of a maritime empire, but ruled over Megara, Boeotia, Phocis, Locris, Achaea and Troezen, *i.e.* over so-called allies who were strangers to the old pan-Ionian assembly and to the policy of the league, and was practically equal to Sparta on land. An important event must be referred probably to the year 451,—the law of Pericles, by which citizenship (including the right to vote in the Ecclesia and to sit on paid juries) was restricted to those who could prove themselves the children of an Athenian father and mother (*ἐξ ἀμφοῖν ἄστροῦν*). This measure must have had a detrimental effect on the allies, who thus saw themselves excluded still further from recognition as equal partners in a league (see PERICLES). The natural result of all these causes was that a feeling of antipathy rose against Athens in the minds of those to whom autonomy was the breath of life, and the fundamental tendency of the Greeks to disruption was soon to prove more powerful than the forces at the disposal of Athens. The first to secede were the land powers of Greece proper, whose subordination Athens had endeavoured to guarantee by supporting the democratic parties in the various states. Gradually the exiled oligarchs combined; with the defeat of Tolmides at Coroneia, Boeotia was finally lost to the empire, and the loss of Phocis, Locris and Megara was the immediate sequel. Against these losses the retention of Euboea, Nisaea and Pegae was no compensation; the land empire was irretrievably lost.

The next important event is the revolt of Samos, which had quarrelled with Miletus over the city of Priene. The Samians refused the arbitration of Athens. The island was conquered

with great difficulty by the whole force of the league, and from the fact that the tribute of the Thracian cities and those in Hellenopontine district was increased between 439 and 436 we must probably infer that Athens had to deal with a widespread feeling of discontent about this period. It is, however, equally noticeable on the one hand that the main body of the allies was not affected, and on the other that the Peloponnesian League on the advice of Corinth officially recognized the right of Athens to deal with her rebellious subject allies, and refused to give help to the Samians.

The succeeding events which led to the Peloponnesian War and the final disruption of the league are discussed in other articles. (See ATHENS: *History*, and PELOPONNESIAN WAR.) Two important events alone call for special notice. The first is the raising of the allies' tribute in 425 B.C. by a certain Thudippus, presumably a henchman of Cleon. The fact, though not mentioned by Thucydides, was inferred from Aristophanes (*Wasps*, 660), Andocides (*de Pace*, § 9), Plutarch (*Aristides*, c. 24), and pseudo-Andocides (*Alcibiad.* 11); it was proved by the discovery of the assessment list of 425-4 (Hicks and Hill, *Inscr.* 64). The second event belongs to 411, after the failure of the Sicilian expedition. In that year the tribute of the allies was commuted for a 5% tax on all imports and exports by sea. This tax, which must have tended to equalize the Athenian merchants with those of the allied cities, probably came into force gradually, for beside the new collectors called *πολιταί* we still find Hellenotamiae (*C.I.A.* iv. [i.] p. 34).

*The Tribute.*—Only a few problems can be discussed of the many which are raised by the insufficient and conflicting evidence at our disposal. In the first place there is the question of the tribute. Thucydides is almost certainly wrong in saying that the amount of the original tribute was 460 talents (about £106,000); this figure cannot have been reached for at least twelve, probably twenty years, when new members had been enrolled (Lycia, Caria, Eion, Lampsacus). Similarly he is probably wrong, or at all events includes items of which the tribute lists take no account, when he says that it amounted to 600 talents at the beginning of the Peloponnesian War. The moderation of the assessment is shown not only by the fact that it was paid so long without objection, but also by the individual items. Even in 425 Naxos and Andros paid only 15 talents, while Athens had just raised an *eisphora* (income tax) from her own citizens of 200 talents. Moreover it would seem that a tribute which yielded less than the 5% tax of 411 could not have been unreasonable.

The number of tributaries is given by Aristophanes as 1000, but this is greatly in excess of those named in the tribute lists. Some authorities give 200; others put it as high as 290. The difficulty is increased by the fact that in some cases several towns were grouped together in one payment (*συντελής*). These were grouped into five main geographical divisions (from 443 to 436; afterwards four, Caria being merged in Ionia). Each division was represented by two elective assessment commissioners (*τακταί*), who assisted the Boulē at Athens in the quadrennial division of the tribute. Each city sent in its own assessment before the *τακταί*, who presented it to the Boulē. If there was any difference of opinion the matter was referred to the Ecclesia for settlement. In the Ecclesia a private citizen might propose another assessment, or the case might be referred to the law courts. The records of the tribute are preserved in the so-called quota lists, which give the names of the cities and the proportion, one-sixtieth, of their several tributes, which was paid to Athena. No tribute was paid by members of a cleruchy (*q.v.*), as we find from the fact that the tribute of a city always decreased when a cleruchy was planted in it. This highly organized financial system must have been gradually evolved, and no doubt reached its perfection only after the treasury was transferred to Athens.

*Government and Jurisdiction.*—There is much difference of opinion among scholars regarding the attitude of imperial Athens towards her allies. Grote maintained that on the whole the allies had little ground for complaint; but in so doing he rather seems to leave out of account the Greek's dislike of external

discipline. The very fact that the hegemony had become an empire was enough to make the new system highly offensive to the allies. No very strong argument can be based on the paucity of actual revolts. The indolent Ionians had seen the result of secession at Naxos and rebellion at Thasos; the Athenian fleet was perpetually on guard in the Aegean. On the other hand among the mainland cities revolt was frequent; they were ready to rebel *καὶ παρὰ δῖναμιν*. Therefore, even though Athenian domination may have been highly salutary in its effects, there can be no doubt that the allies did not regard it with affection.

To judge only by the negative evidence of the decree of Aristoteles which records the terms of alliance of the second confederacy (below), we gather that in the later period at least of the first league's history the Athenians had interfered with the local autonomy of the allies in various ways—an inference which is confirmed by the terms of "alliance" which Athens imposed on Erythrae, Chalcis and Miletus. Though it appears that Athens made individual agreements with various states, and therefore that we cannot regard as general rules the terms laid down in those which we possess, it is undeniable that the Athenians planted garrisons under permanent Athenian officers (*φρούραρχοι*) in some cities. Moreover the practice among Athenian settlers of acquiring land in the allied districts must have been vexatious to the allies, the more so as all important cases between Athenians and citizens of allied cities were brought to Athens. Even on the assumption that the Athenian dicasteries were scrupulously fair in their awards, it must have been peculiarly galling to the self-respect of the allies and inconvenient to individuals to be compelled to carry cases to Athens and Athenian juries. Furthermore we gather from the Aristoteles inscription and from the 4th-century orators that Athens imposed democratic constitutions on her allies; indeed Isocrates (*Paneg.*, 106) takes credit for Athens on this ground, and the charter of Erythrae confirms the view (cf. Arist. *Polit.*, viii., vi. 9 1307 b 20; Thuc. viii. 21, 48, 64, 65). Even though we admit that Chios, Lesbos and Samos (up to 440) retained their oligarchic governments and that Selymbria, at a time (409 B.C.) when the empire was *in extremis*, was permitted to choose its own constitution, there can be no doubt that, from whatever motive and with whatever result, Athens did exercise over many of her allies an authority which extended to the most intimate concerns of local administration.

Thus the great attempt on the part of Athens to lead a harmonious league of free Greek states for the good of Hellas degenerated into an empire which proved intolerable to the autonomous states of Greece. Her failure was due partly to the commercial jealousy of Corinth working on the dull antipathy of Sparta, partly to the hatred of compromise and discipline which was fatally characteristic of Greece and especially of Ionian Greece, and partly also to the lack of tact and restraint shown by Athens and her representatives in her relations with the allies.

‡ *The Second League.*—The conditions which led to the second Athenian or Delian Confederacy were fundamentally different, not only in virtue of the fact that the allies had learned from experience the dangers to which such a league was liable, but because the enemy was no longer an oriental power of whose future action there could be no certain anticipation, but Sparta, whose ambitious projects since the fall of Athens had shown that there could be no safety for the smaller states save in combination.

‡ There can be no reasonable doubt that as soon as the Athenians began to recover from the paralysing effect of the victory of Lysander and the internal troubles in which they were involved by the government of the Thirty, their thoughts turned to the possibility of recovering their lost empire. The first step in the direction was the recovery of their sea-power, which was effected by the victory of Conon at Cnidus (August 394 B.C.). Gradually individual cities which had formed part of the Athenian empire returned to their alliance with Athens, until the Spartans had lost Rhodes, Cos, Nisyros, Teos, Chios, Mytilene, Ephesus, Erythrae, Lemnos, Imbros, Scyros, Eretria, Melos, Cythera,

Carpethus and Delos. Sparta had only Sestos and Abydos of all that she had won by the battle of Aegospotami. At the same time no systematic constructive attempt at a renewal of empire can as yet be detected. Athenian relations were with individual states only, and the terms of alliance were various. Moreover, whereas Persia had been for several years aiding Athens against Sparta, the revolt of the Athenian ally Evagoras (*q.v.*) of Cyprus set them at enmity, and with the secession of Ephesus, Cnidus and Samos in 391 and the civil war in Rhodes, the star of Sparta seemed again to be in the ascendant. But the whole position was changed by the successes of Thrasybulus, who brought over the Odrysian king Medocus and Seuthes of the Propontis to the Athenian alliance, set up a democracy in Byzantium and reimposed the old 10% duty on goods from the Black Sea. Many of the island towns subsequently came over, and from inscriptions at Clazomenae (*C.I.A.* ii. 14b) and Thasos (*C.I.A.* iv. 11b) we learn that Thrasybulus evidently was deliberately aiming at a renewal of the empire, though the circumstances leading to his death at Aspendus when seeking to raise money suggest that he had no general backing in Athens.

The peace of Antalcidas or the King's Peace (see ANTALCIDAS; SPARTA) in 386 was a blow to Athens in the interests of Persia and Sparta. Antalcidas compelled the Athenians to give their assent to it only by making himself master of the Hellespont by stratagem with the aid of Dionysius the Elder of Syracuse. By this peace all the Greek cities on the mainland of Asia with the islands of Cyprus and Clazomenae were recognized as Persian, all other cities except Imbros, Lemnos and Scyros as autonomous. Directly, this arrangement prevented an Athenian empire; indirectly, it caused the sacrificed cities and their kinsmen on the islands to look upon Athens as their protector. The gross selfishness of the Spartans, herein exemplified, was emphasized by their capture of the Theban citadel, and, after their expulsion, by the raid upon Attica in time of peace by the Spartan Sphodrias, and his immunity from punishment at Sparta (summer of 378 B.C.). The Athenians at once invited their allies to a conference, and the Second Athenian Confederacy was formed in the archonship of Nausimachus on the basis of the famous decree of Aristoteles. Those who attended the conference were probably Athens, Chios, Mytilene, Methymna, Rhodes, Byzantium, Thebes, the latter of which joined Athens soon after the Sphodrias raid. In the spring of 377 invitations were sent out to the maritime cities. Some time in that year Tenedos, Chios, Chalcis in Euboea, and probably the Euboean cities Eretria, Carystus and Arethusa gave in their adherence, followed by Perinthus, Peparethus, Sciathus and other maritime cities.

At this point Sparta was roused to a sense of the significance of the new confederacy, and the Athenian corn supply was threatened by a Spartan fleet of sixty triremes. The Athenians immediately fitted out a fleet under Chabrias, who gained a decisive victory over the Spartans between Naxos and Paros (battle of Naxos 376 B.C.), both of which were added to the league. Proceeding northwards in 375 Chabrias brought over a large number of the Thraceward towns, including Abdera, Thasos and Samothrace. It is interesting to notice that a garrison was placed in Abdera in direct contravention of the terms of the new confederacy (Meyer, *Gesch. d. Alt.*, v. 394). About the same time the successes of Timotheus in the west resulted in the addition to the league of Corcyra and the cities of Cephallenia, and his moderation induced the Acarnanians and Alcetas, the Molossian king, to follow their example. Once again Sparta sent out a fleet, but Timotheus in spite of financial embarrassment held his ground. By this time, however, the alliance between Thebes and Athens was growing weaker, and Athens, being short of money, concluded a peace with Sparta (probably in July 374), by which the peace of Antalcidas was confirmed and the two states recognized each other as mistress of sea and land respectively. Trouble, however, soon arose over Zacynthus, and the Spartans not only sent help to the Zacynthian oligarchs but even besieged Corcyra (373). Timotheus was sent to relieve the island, but shortness of money compelled him to search for new allies, and he spent the summer of 373 in persuading Jason of Pherae (if he had not

already joined), and certain towns in Thrace, the Chersonese, the Propontis and the Aegean to enrol themselves. This delay in sending help to Corcyra was rightly or wrongly condemned by the Athenians, who dismissed Timotheus in favour of Iphicrates. The expedition which followed produced negative successes, but the absence of any positive success and the pressure of financial difficulty, coupled with the defection of Jason (probably before 371), and the high-handed action of Thebes in destroying Plataea (373), induced Athens to renew the peace with Sparta which Timotheus had broken. With the support of Persia an agreement was made by a congress at Sparta on the basis of the autonomy of the cities, Amphipolis and the Chersonese being granted to Athens. The Thebans at first accepted the terms, but on the day after, realizing that they were thus balked of their pan-Boeotian ambition, withdrew and finally severed themselves from the league.

The peace of 371 may be regarded as the conclusion of the first distinct period in the league's existence. The original purpose of the league—the protection of the allies from the ambitions of Sparta—was achieved. Athens was recognized as mistress of the sea; Sparta as the chief land power. The inherent weakness of the coalition had, however, become apparent. The enthusiasm of the allies (numbering about seventy) waned rapidly before the financial exigencies of successive campaigns, and it is abundantly clear that Thebes had no interest save the extension of her power in Boeotia. Though her secession, therefore, meant very little loss of strength, there were not wanting signs that the league was not destined to remain a power in the land.

The remaining history may be broken up into two periods, the first from 371 to 357, the second from 357 to 338. Throughout these two periods, which saw the decline and final dissolution of the alliance, there is very little specific evidence for its existence. The events seem to belong to the histories of the several cities, and examples of corporate action are few and uncertain. None the less the known facts justify a large number of inferences as to the significance of events which are on the surface merely a part of the individual foreign policy of Athens.

*Period 371–357.*—The first event in this period was the battle of Leuctra (July 371), in which, no doubt to the surprise of Athens, Thebes temporarily asserted itself as the chief land power in Greece. To counterbalance the new power Athens very rashly plunged into Peloponnesian politics with the ulterior object of inducing the states which had formerly recognized the hegemony of Sparta to transfer their allegiance to the Delian League. It seems that all the states adopted this policy with the exception of Sparta (probably) and Elis. The policy of Athens was mistaken for two reasons: (1) Sparta was not entirely humiliated, and (2) alliance with the land powers of Peloponnese was incalculably dangerous, inasmuch as it involved Athens in enterprises which could not awake the enthusiasm of her maritime allies. This new coalition naturally alarmed Sparta, which at once made overtures to Athens on the ground of their common danger from Thebes. The alliance was concluded in 369. About the same time Iphicrates was sent to take possession of Amphipolis according to the treaty of 371. Some success in Macedonia roused the hostility of Thebes, and the subsequent attempts on Amphipolis caused the Chalcidians to declare against the league. It would appear that the old suspicion of the allies was now thoroughly awakened, and we find Athens making great efforts to conciliate Mytilene by honorific decrees (Hicks and Hill, 109). This suspicion, which was due primarily, no doubt, to the agreement with Sparta, would find confirmation in the subsequent exchange of compliments with Dionysius I. of Syracuse, Sparta's ally, who with his sons received the Athenian citizenship. It is not clear that the allies officially approved this new friendship; it is certain that it was actually distasteful to them. The same dislike would be roused by the Athenian alliance with Alexander of Phrae (368–367). The maritime allies naturally had no desire to be involved in the quarrels of Sicily, Thessaly and the Peloponnese.

In 367 Athens and Thebes sent rival ambassadors to Persia, with the result that Athens was actually ordered to abandon her

claim to Amphipolis, and to remove her navy from the high seas. The claim to Amphipolis was subsequently affirmed, but the Greek states declined to obey the order of Persia. In 366 Athens lost Oropus, a blow which she endeavoured to repair by forming an alliance with Arcadia and by an attack on Corinth. At the same time certain of the Peloponnesian states made peace with Thebes, and some hold that Athens joined this peace (Meyer, *Gesch. d. Alt.* v. 449). Timotheus was sent in 366–365 to make a demonstration against Persia. Finding Samos in the hands of Cyprothemis, a servant of the satrap Tigranes, he laid siege to it, captured it after a ten months' siege and established a cleruchy. Though Samos was not apparently one of the allies, this latter action could not but remind the allies of the very dangers which the second confederacy had set out to avoid.

The next important event was the serious attempt on the part of Epaminondas to challenge the Athenian naval supremacy. Though Timotheus held his ground the confederacy was undoubtedly weakened. In 362 Athens joined in the opposition to the Theban expedition which ended in the battle of Mantinea (July). In the next year the Athenian generals failed in the north in their attempt to control the Hellespont. In Thessaly Alexander of Phrae became hostile and after several successes even attacked the Peiraeus. Chares was ordered to make reprisals, but instead sailed to Corcyra, where he made the mistake of siding with the oligarchs. The last event of the period was a success, the recovery of Euboea (357), which was once more added to the league.

During these fourteen years the policy of Athens towards her maritime allies was, as we have seen, shortsighted and inconsistent. Alliances with various land powers, and an inability to understand the true relations which alone could unite the league, combined to alienate the allies, who could discover no reason for the expenditure of their contributions on protecting Sparta or Corinth against Thebes. The *Συνέδριον* of the league is found taking action in several instances, but there is evidence (cf. the expedition of Epaminondas in 363) that there was ground for suspecting disloyalty in many quarters. On the other hand, though the Athenian fleet became stronger and several cities were captured, the league itself did not gain any important voluntary adherents. The generals were compelled to support their forces by plunder or out of their private resources, and, frequently failing, diverted their efforts from the pressing needs of the allies to purely Athenian objects.

*Period 357–338.*—The latent discontent of the allies was soon fanned into hostility by the intrigues of Mausolus, prince of Cardia, who was anxious to extend his kingdom. Chios, Rhodes, Cos, Byzantium, Erythrae and probably other cities were in revolt by the spring of 356, and their attacks on loyal members of the confederacy compelled Athens to take the offensive. Chabrias had already been killed in an attack on Chios in the previous autumn, and the fleet was under the command of Timotheus, Iphicrates and Chares, who sailed against Byzantium. The enemy sailed north from Samos and in a battle off Embata (between Erythrae and Chios) defeated Chares, who, without the consent of his colleagues, had ventured to engage them in a storm. The more cautious generals were accused of corruption in not supporting Chares. Iphicrates was acquitted and Timotheus condemned. Chares sought to replenish his resources by aiding the Phrygian satrap Artabazus against Artaxerxes Ochus, but a threat from the Persian court caused the Athenians to recall him, and peace was made by which Athens recognized the independence of the revolted towns. The league was further weakened by the secession of Corcyra, and by 355 was reduced to Athens, Euboea and a few islands. By this time, moreover, Philip II. of Macedon had begun his career of conquest, and had shattered an embryonic alliance between the league and certain princes of Thrace (Cetriporis), Paeonia (Lyppeius) and Illyria (Grabus). In 355 his advance temporarily ceased, but, as we learn from Isocrates and Xenophon, the financial exhaustion of the league was such that its destruction was only a matter of time. Resuming operations in 354, Philip, in spite of temporary checks at the hands of Chares, and the spasmodic opposition of a

few barbarian chiefs, took from the league all its Thracian and Macedonian cities (Abdera, Maronea, Neapolis, Methone.) In 352-351 Philip actually received help from former members of the confederacy. In 351 Charidemus, Chares and Phocion were sent to oppose him, and we find that the contributions of the Lesbian cities were assigned to them for supplies, but no successes were gained. In 349 Euboea and Olynthus were lost to the league, of which indeed nothing remained but an empty form, in spite of the facts that the expelled Olynthians appealed to it in 348 and that Mytilene rejoined in 347. In 346 the peace of Philocrates was made between the league and Philip on terms which were accepted by the Athenian Boulē. It is very remarkable that, in spite of the powerlessness of the confederacy, the last recorded event in its history is the steady loyalty of Tenedos, which gave money to Athens about 340 (Hicks and Hill, 146). The victory of Philip at Chaeronea in 338 finally destroyed the league.

In spite of the precautions taken by the allies to prevent the domination of Athens at their expense, the policy of the league was almost throughout directed rather in the interests of Athens. Founded with the specific object of thwarting the ambitious designs of Sparta, it was plunged by Athens into enterprises of an entirely different character which exhausted the resources of the allies without benefiting them in any respect. There is no doubt that, with very few exceptions, the cities were held to their allegiance solely by the superior force of the Athenian navy. The few instances of its action show that the *Συνέδριον* was practically only a tool in the hands of Athens.

**AUTHORITIES.**—*The First League.*—The general histories of Greece, especially those of A. Holm (Eng. trans., London, 1894), G. Busolt (2nd ed., Gotha, 1893), J. Beloch (Strassburg, 1893 foll.), and G. Grote (the one-vol. ed. of 1907 has some further notes on later evidence). E. Meyer's *Gesch. des Altertums* (Stuttgart, 1892 foll.) and *Forschungen* (Halle, 1892 foll.) are of the greatest value. For inscriptions, G. F. Hill, *Sources of Greek History*, 478-431 (2nd ed., 1907); E. L. Hicks and G. F. Hill, *Greek Hist. Inscr.* (Oxford, 1901). On the tribute see also U. Köhler in *Abhandlungen d. Berliner Akademie* (1869) and U. Pedrolì, "I Tributi degli alleati d'Atene" in Beloch's *Studi di storia antica*. See also articles ARISTIDES; THEMISTOCLES; PERICLES; CIMON, &c., and GREECE: *History*, with works quoted. For the last years of the league see also PELOPONNESIAN WAR.

*The Second League.*—The chief modern works are G. Busolt, "Der zweite athenische Bund" in *Neue Jahrbücher für klassische Philologie* (supp. vol. vii., 1873-1875, pp. 641-866), and F. H. Marshall, *The Second Athenian Confederacy* (1905), one of the Cambridge Historical Essays (No. xiii.). The latter is based on Busolt's monograph and includes subsequent epigraphic evidence, with a full list of authorities. For inscriptions see Hicks and Hill, *op. cit.*, and the *Inscriptiones Atticae*, vol. ii. pt. 5. The meagre data given by ancient writers are collected by Busolt and Marshall. (J. M. M.)

**DELIBES, CLÉMENT PHILIBERT LÉO** (1836-1891), French composer, was born at Saint Germain du Val on the 21st of February 1836. He studied at the Paris Conservatoire under Adolphe Charles Adam, through whose influence he became accompanist at the Théâtre Lyrique. His first essay in dramatic composition was his *Deux sous de charbon* (1853), and during several years he produced a number of operettas. His cantata *Alger* was heard at the Paris opera in 1865. Having become second chorus master at the Grand Opéra, he wrote the music of a ballet entitled *La Source* for this theatre, in collaboration with Minkous, a Polish composer. *La Source* was produced with great success in 1866. The composer returned to the operetta style with *Malbrouk s'en va-t-en guerre*,—written in collaboration with Georges Bizet, Émile Jonas and Legouix, and given at the Théâtre de l'Athénée in 1867. Two years later came *L'Écossais de Chatou*, a one-act piece, and *La Cour du roi Pétard*, a three-act opera-bouffe. The ballet *Coppélia* was produced at the Grand Opéra on the 25th of May 1870 with enormous success.

Delibes gave up his post as second chorus master at the Grand Opéra in 1872 when he married the daughter of Mademoiselle Denain, formerly an actress at the Comédie Française. In this year he published a collection of graceful melodies including *Myrto*, *Les Filles de Cadix*, *Bonjour, Suzon* and others. His first important dramatic work was *Le Roi l'a dit*, a charming comic opera, produced on the 24th of May 1873 at the Opéra Comique. Three years later, on the 14th of June 1876, *Sylvia*, a ballet in three acts,

one of the composer's most delightful works, was produced at the Grand Opéra. This was followed by *La Mort d'Orphée*, a grand scena produced at the Trocadéro concerts in 1878; by *Jean de Nivelle*, a three-act opera brought out at the Opéra Comique on the 8th of March 1880; and by *Lakmé*, an opera in three acts produced at the same theatre on the 14th of April 1883. *Lakmé* has remained his most popular opera. The composer died in Paris on the 16th of January 1891, leaving *Kassya*, a four-act opera, in an unfinished state. This work was completed by E. Guiraud, and produced at the Opéra Comique on the 21st of March 1893. In 1877 Delibes became a chevalier of the Legion of Honour; in 1881 he became a professor of advanced composition at the Conservatoire; in 1884 he took the place of Victor Massé at the Institut de France.

Leo Delibes was a typically French composer. His music is light, graceful and refined. He excelled in ballet music, and *Sylvia* may well be considered a masterpiece. His operas are constructed on a conventional pattern. The harmonic texture, however, is modern, and the melodic invention abundant, while the orchestral treatment is invariably excellent.

**DELILAH**, in the Bible, the heroine of Samson's last love-story and the cause of his downfall (Judg. xvi.). She was a Philistine of Sorek (mod. Sūrīk), west of Zorah, and when her countrymen offered her an enormous bribe to betray him, she set to work to find out the source of his strength. Thrice Samson scoffingly told her how he might be bound, and thrice he readily broke the bonds with which she had fettered him in his sleep; seven green bow-strings, new ropes, and even the braiding of his hair into the frame of the loom failed to secure him. At length he disclosed the secret of his power. Delilah put him to sleep upon her lap, called in a man to shave off his seven locks, and this time he was easily captured. See SAMSON.

**DELILLE, JACQUES** (1738-1813), French poet, was born on the 22nd of June 1738 at Aigue-Perse in Auvergne. He was an illegitimate child, and was descended by his mother from the chancellor De l'Hôpital. He was educated at the college of Lisieux in Paris and became an elementary teacher. He gradually acquired a reputation as a poet by his epistles, in which things are not called by their ordinary names but are hinted at by elaborate periphrases. Sugar becomes "le miel américain que du suc des roseaux exprima l'Africain." The publication (1769) of his translation of the *Georgics* of Virgil made him famous. Voltaire recommended the poet for the next vacant place in the Academy. He was at once elected a member, but was not admitted until 1774 owing to the opposition of the king, who alleged that he was too young. In his *Jardins, ou l'art d'embellir les paysages* (1782) he made good his pretensions as an original poet. In 1786 he made a journey to Constantinople in the train of the ambassador M. de Choiseul-Gouffier.

Delille had become professor of Latin poetry at the Collège de France, and abbot of Saint-Séverin, when the outbreak of the Revolution reduced him to poverty. He purchased his personal safety by professing his adherence to revolutionary doctrine, but eventually quitted Paris, and retired to St Dié, where he completed his translation of the *Aeneid*. He emigrated first to Basel and then to Glairasse in Switzerland. Here he finished his *Homme des champs*, and his poem on the *Trois règnes de la nature*. His next place of refuge was in Germany, where he composed his *La Pitié*; and finally, he passed some time in London, chiefly employed in translating *Paradise Lost*. In 1802 he was able to return to Paris, where, although nearly blind, he resumed his professorship and his chair at the Academy, but lived in retirement. He fortunately did not outlive the vogue of the descriptive poems which were his special province, and died on the 1st of May 1813.

Delille left behind him little prose. His preface to the translation of the *Georgics* is an able essay, and contains many excellent hints on the art and difficulties of translation. He wrote the article "La Bruyère" in the *Biographie universelle*. The following is the list of his poetical works:—*Les Géorgiques de Virgile, traduites en vers français* (Paris, 1769, 1782, 1785, 1809); *Les Jardins, en quatre chants* (1780; new edition, Paris, 1801);

*L'Homme des champs, ou les Géorgiques françaises* (Strassburg, 1802); *Poésies fugitives* (1802); *Dithyrambe sur l'immortalité de l'âme, suivi du passage du Saint Gothard*, poème traduit de l'Anglais de Madame la duchesse de Devonshire (1802); *La Pitié*, poème en quatre chants (Paris, 1802); *L'Énéide de Virgile, traduite en vers français* (4 vols., 1804); *Le Paradis perdu* (3 vols., 1804); *L'Imagination*, poème en huit chants (2 vols., 1806); *Les trois règnes de la nature* (2 vols., 1808); *La Conversation* (1812). A collection given under the title of *Poésies diverses* (1801) was disavowed by Delille.

His *Œuvres* (16 vols.) were published in 1824. See Sainte-Beuve, *Portraits littéraires*, vol. ii.

**DELIRIUM** (a Latin medical term for madness, from *delirare*, to be mad, literally to wander from the *lira*, or furrow), a temporary form of brain disorder, generally occurring in connexion with some special form of bodily disease. It may vary in intensity from slight and occasional wandering of the mind and incoherence of expression, to fixed delusions and violent maniacal excitement, and again it may be associated with more or less of coma or insensibility. (See **INSANITY**, and **NEUROPATHOLOGY**.) Delirium is apt to occur in most diseases of an acute nature, such as fevers or inflammatory affections, in injuries affecting the brain, in blood diseases, in conditions of exhaustion, and as the result of the action of certain specific poisons, such as opium, Indian hemp, belladonna, chloroform and alcohol.

Delirium tremens is one of a train of symptoms of what is termed in medical nomenclature acute alcoholism, or excessive indulgence in alcohol. It must, however, be observed that this disorder, although arising in this manner, rarely comes on as the result of a single debauch in a person unaccustomed to the abuse of stimulants, but generally occurs in cases where the nervous system has been already subjected for a length of time to the poisonous action of alcohol, so that the complaint might be more properly regarded as acute supervening on chronic alcoholism. It is equally to be borne in mind that many habitual drunkards never suffer from delirium tremens.

It was long supposed, and is indeed still believed by some, that delirium tremens only comes on when the supply of alcohol has been suddenly cut off; but this view is now generally rejected, and there is abundant evidence to show that the attack comes on while the patient is still continuing to drink. Even in those cases where several days have elapsed between the cessation from drinking and the seizure, it will be found that in the interval the premonitory symptoms of delirium tremens have shown themselves, one of which is aversion to drink as well as food—the attack being in most instances preceded by marked derangement of the digestive functions. Occasionally the attack is precipitated in persons predisposed to it by the occurrence of some acute disease, such as pneumonia, by accidents, such as burns, also by severe mental strain, and by the deprivation of food, even where the supply of alcohol is less than would have been likely to produce it otherwise. Where, on the other hand, the quantity of alcohol taken has been very large, the attack is sometimes ushered in by fits of an epileptiform character.

One of the earliest indications of the approaching attack of delirium tremens is sleeplessness, any rest the patient may obtain being troubled by unpleasant or terrifying dreams. During the day there is observed a certain restlessness and irritability of manner, with trembling of the hands and a thick or tremulous articulation. The skin is perspiring, the countenance oppressed-looking and flushed, the pulse rapid and feeble, and there is evidence of considerable bodily prostration. These symptoms increase each day and night for a few days, and then the characteristic delirium is superadded. The patient is in a state of mental confusion, talks incessantly and incoherently, has a distressed and agitated or perplexed appearance, and a vague notion that he is pursued by some one seeking to injure him. His delusions are usually of transient character, but he is constantly troubled with visual hallucinations in the form of disagreeable animals or insects which he imagines he sees all about him. He looks suspiciously around him, turns over his pillows, and ransacks his bedclothes for some fancied object he supposes

to be concealed there. There is constant restlessness, a common form of delusion being that he is not in his own house, but imprisoned in some apartment from which he is anxious to escape to return home. In these circumstances he is ever wishing to get out of bed and out of doors, and, although in general he may be persuaded to return to bed, he is soon desiring to get up again. The trembling of the muscles from which the name of the disease is derived is a prominent but not invariable symptom. It is most marked in the muscles of the hands and arms and in the tongue. The character of the delirium is seldom wild or noisy, but is much more commonly a combination of busy restlessness and indefinite fear. When spoken to, the patient can answer correctly enough, but immediately thereafter relapses into his former condition of incoherence. Occasionally maniacal symptoms develop themselves, the patient becoming dangerously violent, and the case thus assuming a much graver aspect than one of simple delirium tremens.

In most cases the symptoms undergo abatement in from three to six days, the cessation of the attack being marked by the occurrence of sound sleep, from which the patient awakes in his right mind, although in a state of great physical prostration, and in great measure if not entirely oblivious of his condition during his illness.

Although generally the termination of an attack of delirium tremens is in recovery, it occasionally proves fatal by the super-vention of coma and convulsions, or acute mania, or by exhaustion, more especially when any acute bodily disease is associated with the attack. In certain instances delirium tremens is but the beginning of serious and permanent impairment of intellect, as is not infrequently observed in confirmed drunkards who have suffered from frequent attacks of this disease. The theory once widely accepted, that delirium tremens was the result of the too sudden breaking off from indulgence in alcohol, led to its treatment by regular and often large doses of stimulants, a practice fraught with mischievous results, since however much the delirium appeared to be thus calmed for the time, the continuous supply of the poison which was the original source of the disease inflicted serious damage upon the brain, and led in many instances to the subsequent development of insanity. The former system of prescribing large doses of opium, with the view of procuring sleep at all hazards, was no less pernicious. In addition to these methods of treatment, mechanical restraint of the patient was the common practice.

The views of the disease which now prevail, recognizing the delirium as the effect at once of the poisonous action of alcohol upon the brain and of the want of food, encourage reliance to be placed for its cure upon the entire withdrawal, in most instances, of stimulants, and the liberal administration of light nutriment, in addition to quietness and gentle but firm control, without mechanical restraint. In mild attacks this is frequently all that is required. In more severe cases, where there is great restlessness, sedatives have to be resorted to, and many substances have been recommended for the purpose. Opiates administered in small quantity, and preferably by hypodermic injection, are undoubtedly of value; and chloral, either alone or in conjunction with bromide of potassium, often answers even better. Such remedies, however, should be administered with great caution, and only under medical supervision.

Stimulants may be called for where the delirium assumes the low or adynamic form, and the patient tends to sink from exhaustion, or when the attack is complicated with some other disease. Such cases are, however, in the highest degree exceptional, and do not affect the general principle of treatment already referred to, which inculcates the entire withdrawal of stimulants in the treatment of ordinary attacks of delirium tremens.

**DELISLE, JOSEPH NICOLAS** (1688–1768), French astronomer, was born at Paris on the 4th of April 1688. Attracted to astronomy by the solar eclipse of the 12th of May 1706, he obtained permission in 1710 to lodge in the dome of the Luxembourg, procured some instruments, and there observed the total eclipse of the 22nd of May 1724. He proposed in 1715 the “diffraction-theory” of the sun’s corona, visited England and was received



into the Royal Society in 1724, and left Paris for St Petersburg on a summons from the empress Catherine, towards the end of 1725. Having founded an observatory there, he returned to Paris in 1747, was appointed geographical astronomer to the naval department with a salary of 3000 livres, and installed an observatory in the Hôtel Cluny. Charles Messier and J. J. Lalande were among his pupils. He died of apoplexy at Paris on the 12th of September 1768. Delisle is chiefly remembered as the author of a method for observing the transits of Venus and Mercury by instants of contacts. First proposed by him in a letter to J. Cassini in 1743, it was afterwards perfected, and has been extensively employed. As a preliminary to the transit of Mercury in 1743, which he personally observed, he issued a map of the world showing the varied circumstances of its occurrence. Besides many papers communicated to the academy of sciences, of which he became a member in 1714, he published *Mémoires pour servir à l'histoire et au progrès de l'astronomie* (St Petersburg, 1738), in which he gave the first method for determining the heliocentric co-ordinates of sun-spots; *Mémoire sur les nouvelles découvertes au nord de la mer du sud* (Paris, 1752), &c.

See *Mémoires de l'acad. des sciences* (Paris, 1768), *Histoire*, p. 167 (G. de Fouchy); J. B. J. Delambre, *Hist. de l'astronomie au XVIII<sup>e</sup> siècle*, pp. 319, 533; Max. Marie, *Hist. des sciences*, vii. 254; Lalande, *Bibl. astr.* p. 385; and *Le Nécrologe des hommes célèbres de France* (1770). The records of Delisle's observations at St Petersburg are preserved in manuscript at the Pulkowa observatory. A report upon them was presented to the St Petersburg academy of sciences by O. Struve in 1848, and those relating to occultations of the Pleiades were discussed by Carl Linsser in 1864. See also S. Newcomb, *Washington Observations* for 1875, app. ii. pp. 176-189. (A. M. C.)

**DELISLE, LÉOPOLD VICTOR** (1826— ), French bibliophile and historian, was born at Valognes (Manche) on the 24th of October 1826. At the École des Chartes, where his career was remarkably brilliant, his valedictory thesis was an *Essai sur les revenus publics en Normandie au XII<sup>e</sup> siècle* (1849), and it was to the history of his native province that he devoted his early works. Of these the *Études sur la condition de la classe agricole et l'état de l'agriculture en Normandie au moyen âge* (1851), condensing an enormous mass of facts drawn from the local archives, was reprinted in 1905 without change, and remains authoritative. In November 1852 he entered the manuscript department of the Bibliothèque Impériale (Nationale), of which in 1874 he became the official head in succession to Jules Taschereau. He was already known as the compiler of several invaluable inventories of its manuscripts. When the French government decided on printing a general catalogue of the printed books in the Bibliothèque, Delisle became responsible for this great undertaking and took an active part in the work; in the preface to the first volume (1897) he gave a detailed history of the library and its management. Under his administration the library was enriched with numerous gifts, legacies and acquisitions, notably by the purchase of a part of the Ashburnham MSS. Delisle proved that the bulk of the MSS. of French origin which Lord Ashburnham had bought in France, particularly those bought from the bookseller Barrois, had been purloined by Count Libri, inspector-general of libraries under King Louis Philippe, and he procured the repurchase of the MSS. for the library, afterwards preparing a catalogue of them entitled *Catalogue des MSS. des fonds Libri et Barrois* (1888), the preface of which gives the history of the whole transaction. He was elected member of the Académie des Inscriptions et Belles Lettres in 1859, and became a member of the staff of the *Recueil des historiens de la France*, collaborating in vols. xxii. (1865) and xxiii. (1876) and editing vol. xxiv. (1904), which is valuable for the social history of France in the 13th century. The jubilee of his fifty years' association with the Bibliothèque Nationale was celebrated on the 8th of March 1903. After his retirement (February 21, 1905) he brought out in two volumes a catalogue and description of the printed books and MSS. in the Musée Condé at Chantilly, left by the duc d'Aumale to the French Institute. He produced many valuable official reports and catalogues and a great number of memoirs and monographs on points connected with palaeography and the study of history and archaeology (see his *Mélanges de paléographie et de*

*bibliographie* (1880) with atlas; and his articles in the *Album paléographique* (1887). Of his purely historical works special mention must be made of his *Mémoire sur les actes d'Innocent III* (1857), and his *Mémoire sur les opérations financières des Templiers* (1889), a collection of documents of the highest value for economic history. The thirty-second volume of the *Histoire littéraire de la France*, which was partly his work, is of great importance for the study of 13th and 14th century Latin chronicles. Delisle was undoubtedly the most learned man in Europe with regard to the middle ages; and his knowledge of diplomatics, palaeography and printing was profound. His output of work, in catalogues, &c., was enormous, and his services to the Bibliothèque Nationale in this respect cannot be overestimated. His wife, a daughter of Eugène Burnouf, was for many years his collaborator.

The *Bibliographie des travaux de L. Delisle* (1902), by Paul Lacombe, may be consulted for a full list of his numerous works.

**DELITZSCH, FRANZ** (1813-1890), German Lutheran theologian and orientalist, of Jewish descent, was born at Leipzig on the 23rd of February 1813. He studied theology and oriental languages in the university of his native town, and in 1850 was appointed professor ordinarius of theology at Erlangen, where the school of theologians became almost as famous as that of Tübingen. In 1867 he accepted a call to Leipzig, where he died on the 4th of March 1890. Delitzsch was a strict Lutheran. "By the banner of our Lutheran confession let us stand," he said in 1888; "folding ourselves in it, let us die" (T. K. Cheyne, *Founders*, p. 160). Greatly interested in the Jews, he longed ardently for their conversion to Christianity; and with a view to this he edited the periodical *Saat auf Hoffnung* from 1863, revived the "Institutum Judaicum" in 1880, founded a Jewish missionary college for the training of theologians, and translated the *New Testament* into Hebrew. He acquired such a mastery of post-biblical, rabbinic and talmudic literature that he has been called the "Christian Talmudist." Though never an advanced critic, his article on Daniel in the second edition of Herzog's *Realencyklopädie*, his *New Commentary on Genesis* and the fourth edition of his *Isaiah* show that as years went on his sympathy with higher criticism increased—so much so indeed that Prof. Cheyne has included him among its founders.

He wrote a number of very valuable commentaries on *Habakkuk* (1843), *Genesis* (1852, 4th ed. 1872), *Neuer Kommentar über die Genesis* (1887, Eng. trans. 1888, &c.), *Psalms* (4th ed. 1883, Eng. trans. 1886, &c.), *Job* (2nd ed., 1876), *Isaiah* (4th ed. 1889, Eng. trans. 1890, &c.), *Proverbs* (1873), *Epistle to the Hebrews* (1857, Eng. trans. 1865, &c.), *Song of Songs and Ecclesiastes* (4th ed., 1875). Other works are *Geschichte der jüd. Poesie* (1836); *Jesus und Hillel* (1867, 3rd ed. 1879); *Handwerkerleben zur Zeit Jesu* (1868, 3rd ed. 1878, Eng. trans. in the "Unit Library," 1902); *Ein Tag in Kapernaum* (1871, 3rd ed. 1886); *Poesieen aus wormammedanischer Zeit* (1874); *Iris, Farbenstudien und Blumenstücke* (1888, Eng. trans. 1889); *Messianische Weissagungen in geschichtlicher Folge* (1890, 2nd ed. 1898). His Hebrew *New Testament* reached its eleventh edition in 1891, and his popular devotional work *Das Sakrament des wahren Leibes und Blutes Jesu Christi* its seventh edition in 1886.

His son, FRIEDRICH DELITZSCH (b. 1850), became well known as professor of Assyriology in Berlin, and the author of many books of great research and learning, especially on oriental philology. Among other works of importance he wrote *Wo lag das Paradies?* (1881), and *Babel und Bibel* (1902, 1903, Eng. trans. 1903).

**DELITZSCH**, a town of Germany, in the Prussian province of Saxony, on the Lober, an affluent of the Mulde, 12 m. north of Leipzig at the junction of the railways, Bitterfeld-Leipzig and Halle-Cottbus. Pop. (1905) 10,479. Its public buildings comprise an old castle of the 14th century now used as a female penitentiary, a Roman Catholic and three Protestant churches, a normal college (*Schullehrerseminar*) established in 1873 and several other educational institutions. Besides *Kuhschwanz*, a peculiar kind of beer, it manufactures tobacco, cigars, shoes and hosiery; and coal-mining is carried on in the neighbourhood,

It was the birthplace of the naturalist Christian Gottfried Ehrenberg (1795-1876), and the political economist Hermann Schulze-Delitzsch (1808-1883), to the latter of whom a statue has been erected. Originally a settlement of the Sorbian Wends, and in the 12th century part of the possessions of the bishops of Merseburg, Delitzsch ultimately passed to the Saxe-Merseburg family, and, on their extinction in 1738, was incorporated with Electoral Saxony.

**DELIUS, NIKOLAUS** (1813-1888), German philologist and Shakespearean scholar, was born at Bremen on the 19th of September 1813. He was educated at Bonn and Berlin, and took the degree of doctor in philosophy in 1838. After travelling for some time in England, France and Germany, he returned to Bonn in 1846, where in 1855 he was appointed professor of Sanskrit, Provençal and English literature, a post he held until his death, which took place at Bonn on the 18th of November 1888. His greatest literary achievement was his scholarly edition of Shakespeare (1854-1861). He also edited Wace's *St Nicholas* (1850), a volume of Provençal songs (1853), and published a *Shakspeare-Lexikon* (1852). His original works include: *Über das englische Theaterwesen zu Shaksperes Zeit* (1853), *Gedichte* (1853), *Der sardinische Dialekt des dreizehnten Jahrhunderts* (1868), and *Abhandlungen zu Shakspeare* (two series, 1878 and 1888). As a critic of Shakespeare's text he stands in the first rank.

See the biographical notice by J. Schipper in *Englische Studien*, vol. 14.

**DELLA BELLA, STEFANO** (1610-1664), Italian engraver, was born at Florence. He was apprenticed to a goldsmith; but some prints of Callot having fallen into his hands, he began to turn his attention entirely towards engraving, and studied the art under Canta Gallina, who had also been the instructor of Callot. By the liberality of Lorenzo de' Medici he was enabled to spend three years in study at Rome. In 1642 he went to Paris, where Cardinal Richelieu engaged him to go to Arras and make drawings of the siege and taking of that town by the royal army. After residing a considerable time at Paris he returned to Florence, where he obtained a pension from the grand duke, whose son, Cosmo, he instructed in drawing. His productions were very numerous, amounting to over 1400 separate pieces.

**DELLA CASA, GIOVANNI** (1503-1556), Italian poet, was born at Mugello, in Tuscany, in 1503. He studied at Bologna, Florence and Rome, and by his learning attracted the patronage of Alexander Farnese, who, as Pope Paul III., made him nuncio to Florence, where he received the honour of being elected a member of the celebrated academy, and then to Naples, where his oratorical ability brought him considerable success. His reward was the archbishopric of Benevento, and it was believed that it was only his openly licentious poem, *Capitoli del forno*, and the fact that the French court seemed to desire his elevation, which prevented him from being raised to a still higher dignity. He died in 1556. Casa is chiefly remarkable as the leader of a reaction in lyric poetry against the universal imitation of Petrarch, and as the originator of a style, which, if less soft and elegant, was more nervous and majestic than that which it replaced. His prose writings gained great reputation in their own day, and long afterwards, but are disfigured by apparent straining after effect, and by frequent puerility and circumlocution. The principal are—in Italian, the famous *Il Galateo* (1558), a treatise of manners, which has been translated into several languages, and in Latin, *De officiis*, and translations from Thucydides, Plato and Aristotle.

A complete edition of his works was published at Florence in 1707, to which is prefixed a life by Casotti. The best edition is that of Venice, 1752.

**DELLA COLLE, RAFFAELLINO**, Italian painter, was born at Colle, near Borgo San Sepolcro, in Tuscany, about 1490. A pupil of Raphael, whom he is held to have assisted in the Farnesina and the Vatican, Della Colle, after his master's death, was the assistant of his chief scholar, Giulio Romano, at Rome and afterwards at Mantua. In 1536, on the occasion of the entry of Charles V. into Florence, he took service in that city under Vasari. In his later years Della Colle resided at Borgo San

Sepolcro, where he kept a school of design; among his many pupils of note may be mentioned Gherardi and Vecchi. His works, which are to be found at Urbino, at Perugia, at Pesaro and at Gubbio, are fine examples of the Roman school of Raphael. The best are a painting of the Almighty supported by angels, a Resurrection and an Assumption, all preserved in churches at Borgo San Sepolcro.

**DELLA GHERARDESCA, UGOLINO** (c. 1220-1289), count of Donoratico, was the head of the powerful family of Gherardesca, the chief Ghibelline house of Pisa. His alliance with the Visconti, the leaders of the Guelph faction, through the marriage of his sister with Giovanni Visconti, judge of Gallura, aroused the suspicions of his party, and the Ghibellines being then predominant in Pisa, the disorders in the city caused by Ugolino and Visconti in 1271-1274 led to the arrest of the former and the banishment of the latter. Visconti died soon afterwards, and Ugolino, no longer regarded as dangerous, was liberated and banished. But he immediately began to intrigue with the Guelph towns opposed to Pisa, and with the help of Charles I. of Anjou (*q.v.*) attacked his native city and forced it to make peace on humiliating terms, pardoning him and all the other Guelph exiles. He lived quietly in Pisa for some years, although working all the time to extend his influence. War having broken out between Pisa and Genoa in 1284, Count Ugolino was given the command of a division of the Pisan fleet. It was by his flight—usually attributed to treachery—that the fortunes of the day were decided and the Pisans totally defeated at La Meloria (October 1284). But the political ability which he afterwards displayed led to his being appointed *podestà* for a year and *capitano del popolo* for ten years. Florence and Lucca took advantage of the Pisan defeat to attack the republic, but Ugolino succeeded in pacifying them by ceding certain castles. He was however less anxious to make peace with Genoa, for the return of the Pisan prisoners, including most of the leading Ghibellines, would have diminished his power. He was now the most influential man in Pisa, and was preparing to establish his absolute sovereignty, when for some reason not clearly understood he was forced to share his power with his nephew Nino Visconti, son of Giovanni. The duumvirate did not last, and the count and Nino soon quarrelled. Then Ugolino tried to consolidate his position by entering into negotiations with the archbishop, Ruggieri degli Ubaldini, the leader of the Ghibellines. But that party having revived once more, the archbishop obliged both Nino and Ugolino to leave the city, and had himself elected *podestà* and *capitano del popolo*. However, he allowed Ugolino to return soon afterwards, and was even ready to divide the government of the city with him, although he refused to admit his armed followers. The count, determined to be sole master, attempted to get his followers into the city by way of the Arno, and Ruggieri, realizing the danger, aroused the citizens, accusing Ugolino of treachery for having ceded the castles, and after a day's street fighting (July 1, 1288), Gherardesca was captured and immured together with his sons Gaddo and Uguccione, and his grandsons Nino (surnamed *il Brigata*) and Anselmuccio, in the Muda, a tower belonging to the Gualandi family; here they were detained for nine months, and then starved to death.

The historic details of the episode are still involved in some obscurity, and although mentioned by Villani and other writers, it owes its fame entirely to Dante, who placed Ugolino and Ruggieri in the second ring (*Antenora*) of the lowest circle of the *Inferno* (canto xxxii. 124-140 and xxxiii. 1-90). This terrible but magnificent passage, which includes "thirty lines unequalled by any other thirty lines in the whole dominion of poetry" (Landor), has been paraphrased by Chaucer in the "Monk's Tale" and more recently by Shelley. But the reason why Dante placed Ugolino among the traitors is not by any means clear, as the flight from La Meloria was not regarded as treachery by any writer earlier than the 16th century, although G. del Noce, in *Il Conte U. della Gherardesca* (Città di Castello, 1894), states that that was the only motive; Bartoli, in vol. vi. of his *Storia della Letteratura italiana*, suggests Ugolino's alliance with the Ghibellines as the motive. The cession of the castles was not treachery

but an act of necessity, owing to the desperate conditions of Pisa.

**BIBLIOGRAPHY.**—Besides the above-quoted works see P. Tronci, *Annali Pisani* (2 vols., Pisa, 1868-1871); S. de Sismondi, *Histoire des républiques italiennes* (Brussels, 1838); also the various annotated editions of Dante, especially W. W. Vernon's *Readings from the Inferno*, vol. ii. (2nd ed., London, 1905). (L. V.)\*

**DELLA PORTA, GIOVANNI BATTISTA** (c. 1538-1615), Italian natural philosopher, was born of a noble and ancient family at Naples about the year 1538. He travelled extensively not only in Italy but also in France and Spain, and he was still a youth when he published *Magia naturalis, sive de miraculis rerum naturalium lib. IV.* (1558), the first draft of his *Magia naturalis*, in twenty books, published in 1589. He founded in Naples the *Academia Secretorum Naturae*, otherwise known as the *Accademia dei Oziosi*; and in 1610 he became a member of the *Accademia dei Lincei* at Rome. He died at Naples on the 4th of February 1615.

The following is a list of his principal writings:—*De miraculis rerum naturalium*, in four books (1558); *De furtivis litterarum notis*, in five books (1563, and frequently afterwards, entitling him to high rank among the early writers on cryptography); *Phytognomonica* (1583, a bulky treatise on the physiology of plants as then understood); *Magia naturalis* (1589, and often reprinted); *De humana physiognomonica*, in six books (1591); *Villa*, in twelve books (1592, an interesting practical treatise on farming, gardening and arboriculture, based upon his own observations at his country-seat near Naples); *De refractione, optices parte*, in nine books (1593); *Pneumatica*, in three books (1601); *De coelesti physiognomonica*, in six books (1601); *Elementa curvilinea* (1601); *De distillatione*, in nine books (1604); *De munitione*, in three books (1608); and *De aëris transmutationibus*, in four books (1609). He also wrote several Italian comedies *Olimpia* (1589); *La Fantesca* (1592); *La Trappolaria* (1597); *I' Due Fratelli rivali* (1601); *La Sorella* (1607); *La Chiappinaria* (1609); *La Carbonaria* (1628); *La Cintia* (1628)). Among all the above-mentioned works the chief interest attaches to the *Magia naturalis*, in which a strange medley of subjects is discussed, including the reproduction of animals, the transmutation of metals, pyrotechny, domestic economy, statics, hunting, the preparation of perfumes. In book xvii. he describes a number of optical experiments, including a description of the camera obscura (*q.v.*).

**DELLA QUERCIA, OF DELLA FONTE, JACOPO** (1374-1438), Italian sculptor, was born at Siena. He was the son of a goldsmith of repute, Pietro d'Agnolo, to whom he doubtless owed much of his training. There are no records of his early life until the year 1394, when he made an equestrian statue of Gian Tedesco. He is next heard of at Florence in 1402, when he was one of six artists who submitted designs for the great gates of the baptistery, in which competition Ghiberti was the victor. From Florence he seems to have gone to Lucca, where in 1406 he executed one of his finest works, the monument of Ilaria del Caretto, wife of Paolo Guinigi. It is uncertain if he visited Ferrara in 1408; but at the end of that year he was engaged in negotiations which resulted in his acceptance of the commission for the famous Fonte Gaia, at Siena, early in 1409. This work was not seriously begun by him until 1414, and was only finished in 1419. In 1858 the remains of the fountain were removed to the Opera del Duomo, where they are now preserved; a copy of the original by Sarrocchi being erected on the site. After another visit to Lucca in 1422, he returned to Siena, and in March 1425 undertook the contract for the doors of S. Petronio, Bologna. He is known, in following years, to have been to Milan, Verona, Ferrara and Venice; but the rest of his life was chiefly divided between his native city and Bologna. In 1430 he finished the great font of S. Giovanni at Siena, which he had begun in 1417, contributing himself only one of the bas-reliefs, "Zacharias in the Temple," the others being by Ghiberti, Donatello and other sculptors. Among the work known to have been done by Jacopo, may be mentioned also the reliefs of the *predella* of the altar of S. Frediano at Lucca (1422); and the Bentivoglio monu-

ment which was unfinished at the time of his death on the 20th of October 1438. Jacopo della Quercia's work exercised a powerful influence on that of the artists of the later Italian Renaissance. He himself reflects not a little of the Gothic spirit, admirably intermixed with some of the best qualities of neo-classicism. He was an artist whose powers have hardly yet received the recognition they undoubtedly deserve.

See C. Cornelius, *Jacopo della Quercia: eine Kunsthistorische Studie* (1896), and works relating generally to the arts in Siena. (E. F. S.)

**DELLA ROBBIA**, the name of a family of great distinction in the annals of Florentine art. Its members are enumerated in chronological order below.<sup>1</sup>

I. **LUCA DELLA ROBBIA** (1399 or 1400<sup>2</sup>-1482) was the son of a Florentine named Simone di Marco della Robbia. According to Vasari, whose account of Luca's early life is little to be trusted, he was apprenticed to the silversmith Leonardo di Ser Giovanni, who from 1355 to 1371 was working on the grand silver altar frontal for the cathedral at Pistoia (*q.v.*); this, however, appears doubtful from the great age which it would give to Leonardo, and it is more probable that Luca was the pupil of Ghiberti. During the early part of his life Luca executed many important and exceedingly beautiful pieces of sculpture in marble and bronze. In technical skill he was quite the equal of Ghiberti, and, while possessing all Donatello's vigour, dramatic power and originality, he very frequently excelled him in grace of attitude and soft beauty of expression. No sculptured work of the great 15th century ever surpassed the singing gallery which Luca made for the cathedral at Florence between 1431 and 1440, with its ten magnificent panels of singing angels and dancing boys, far exceeding in beauty those which Donatello in 1433 sculptured for the opposite gallery in the same choir. This splendid work is now to be found in the Museo del Duomo. The general effect of the whole can also be seen at the Victoria and Albert Museum, where a complete cast is fixed to the wall. The same museum possesses a study in *gesso duro* for one of the panels, which appears to be the original sketch by Luca's own hand.

In May 1437 Luca received a commission from the signoria of Florence to execute five reliefs for the north side of the campanile, to complete the series begun by Giotto and Andrea Pisano. These panels are so much in the earlier style of Giotto that we must conclude that he had left drawings from which Luca worked. They have representative figures chosen to typify grammar, logic, philosophy, music, and science,—the last represented by Euclid and Ptolemy.<sup>3</sup> In 1438 Luca in association with Donatello received an order for two marble altars for chapels in the cathedral. The reliefs from one of them—St Peter's Deliverance from Prison and his Crucifixion—are now in the Bargello. It is probable that these altars were never finished. A tabernacle for the host, made by Luca in 1442, is now at Peretola, near Florence, in the church of S. Maria. A document in the archives of S. Maria Nuova at Florence shows that he received for this 700 florins 1 lira 16 soldi (about £1400 of modern money). In 1437 Donatello received a commission to cast a bronze door for one of the sacristies of the cathedral; but, as he delayed to execute this

<sup>1</sup> Genealogical tree of Della Robbia sculptors:—

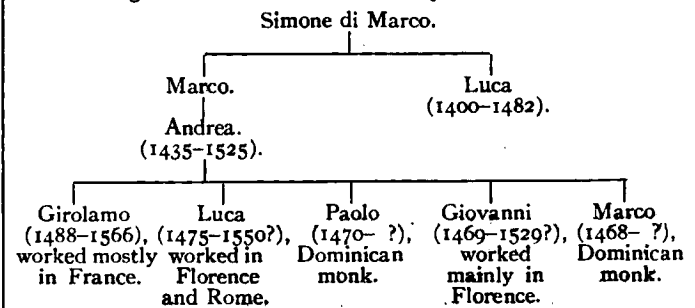

<sup>2</sup> Not 1388, as Vasari says. See a document printed by Gaye, *Carteggio inedito*, i. pp. 182-186.

<sup>3</sup> Vasari is not quite right in his account of these reliefs: he speaks of Euclid and Ptolemy as being in different panels.

order, the work was handed over to Luca on the 28th of February 1446, with Michelozzo and Maso di Bartolomeo as his assistants. Part of this wonderful door was cast in 1448, and the last two panels were finished by Luca in 1467, with bronze which was supplied to him by Verrocchio.<sup>1</sup> The door is divided into ten square panels, with small heads in the style of Ghiberti projecting from the framing. The two top subjects are the Madonna and Child and the Baptist, next come the four Evangelists, and below are the four Latin Doctors, each subject with attendant angels. The whole is modelled with perfect grace and dignified simplicity; the heads throughout are full of life, and the treatment of the



FIG. 1.—Bronze Relief of one of the Latin Doctors, from the sacristy door in the cathedral of Florence, by Luca.

drapery in broad simple folds is worthy of a Greek sculptor of the best period of Hellenic art. These exquisite reliefs are perfect models of plastic art, and are quite free from the over-elaboration and too pictorial style of Ghiberti. Fig. 1 shows one of the panels.

The most important existing work in marble by Luca (executed in 1454-1456) is the tomb of Benozzo Federighi, bishop of Fiesole, originally placed in the church of S. Pancrazio at Florence, but removed to S. Francesco di Paola on the Bellosguardo road outside the city in 1783. In 1898 it was again removed to the church of SS. Trinita in Florence. A very beautiful effigy of the bishop in a restful pose lies on a sarcophagus sculptured with graceful reliefs of angels holding a wreath which contains the inscription. Above are three-quarter length figures of Christ between St John and the Virgin, of conventional type. The whole is surrounded by a rectangular frame formed of painted tiles of exquisite beauty, but out of keeping with the memorial. On each tile is painted, with enamel pigments, a bunch of flowers and fruit in brilliant realistic colours, the loveliness of which is very hard to describe. Though the bunch of flowers on each is painted on one slab, the ground of each tile is formed of separate pieces, fitted together like a kind of mosaic, probably because the pigment of the ground required a different degree of heat in firing from that needed for the enamel painting of the centre. The few other works of this class which exist do not approach the beauty of this early essay in tile painting, on which Luca evidently put forth his utmost skill and patience.

In the latter part of his life Luca was mainly occupied with the production of terra-cotta reliefs covered with enamel, a process which he improved upon, but did not invent, as Vasari asserts. The rationale of this process was to cover the clay relief with an enamel formed of the ordinary ingredients of glass (*marzacotto*), made white and opaque by oxide of tin. (See CERAMICS: *Italian Majolica*.) Though Luca was not the inventor of the process,

<sup>1</sup> See Cavallucci, *S. Maria del Fiore*, pt. ii. p. 137.

yet he extended its application to fine sculptured work in terra-cotta, so that it is not unnaturally known now as Della Robbia ware; it must, however, be remembered that by far the majority of these reliefs which in Italy and elsewhere are ascribed to Luca are really the work of some of the younger members of the family or of the atelier which they founded. Comparatively few exist which can with certainty be ascribed to Luca himself. Among the earliest of these are medallions of the four Evangelists in the vault of Brunelleschi's Pazzi chapel in S. Croce. These fine reliefs are coloured with various metallic oxides in different shades of blue, green, purple, yellow and black. It has often been asserted that the very polychromatic reliefs belong to Andrea or his sons, and that Luca's were all in pure white, or in white and blue; this, however, is not the case; colours were used as freely by Luca as by his successors. A relief in the Victoria and Albert Museum furnishes a striking example of this and is of especial value from its great size, and also because its date is known. This is an enormous medallion containing the arms of René of Anjou and other heraldic devices; it is surrounded by a splendidly modelled wreath of fruit and flowers, especially apples, lemons, oranges and fir cones, all of which are brilliantly coloured. This medallion was set up on the façade of the Pazzi Palace to commemorate René's visit to Florence in 1442. Other reliefs by Luca, also in glazed terra-cotta, are those of the Ascension and Resurrection in the tympani of the doors of the sacristies in the cathedral, executed in 1443 and 1446. Other existing works of Luca in Florence are the tympanum reliefs of the Madonna between two Angels in the Via dell' Agnolo, a work of exquisite beauty, and another formerly over the door of S. Pierino del Mercato Vecchio, but now removed to the Bargello (No. 29). The only existing statues by Luca are two lovely enamelled figures of kneeling angels holding candlesticks, now in the canons' sacristy.<sup>2</sup> A very fine work by Luca, executed between 1449 and 1452, is the tympanum relief of the Madonna and four Monastic Saints over the door of S. Domenico at Urbino.<sup>3</sup> Luca also made the four coloured medallions of the Virtues set in the vault over the tomb of the young cardinal-prince of Portugal in a side chapel of S. Miniato in Florence (see ROSSELLINO). By Luca also are various polychromatic medallions outside Or San Michele.<sup>4</sup> One of his chief decorative works which no longer exists was a small library or study for Piero de' Medici, wholly lined with enamelled plaques and reliefs.<sup>5</sup> The Victoria and Albert Museum possesses twelve circular plaques of majolica ware painted in blue and white with the Occupations of the Months; these have been attributed to Luca, under the idea that they formed part of the decoration of this room, but their real origin is doubtful.

In 1471 Luca was elected president of the Florentine Guild of Sculptors, but he refused this great honour on account of his age and infirmity. It shows, however, the very high estimation in which he was held by his contemporaries. He died on the 20th of February 1482, leaving his property to his nephews Andrea and Simone.<sup>6</sup> His chief pupil was his nephew Andrea, and Agostino di Duccio, who executed many pieces of sculpture at Rimini, and the graceful but mannered marble reliefs of angels on the façade of S. Bernardino at Perugia, may have been one of his assistants.<sup>7</sup> Vasari calls this Agostino Luca's brother, but he was not related to him at all.

II. ANDREA DELLA ROBBIA (1435-1525), the nephew and pupil of Luca, carried on the production of the enamelled reliefs on a much larger scale than his uncle had ever done; he also extended

<sup>2</sup> The Victoria and Albert Museum possesses what seem to be fine replicas of these statues.

<sup>3</sup> The document in which the order for this and the price paid for it are recorded is published by Yriarte, *Gas. d. beaux arts*, xxiv. p. 143.

<sup>4</sup> One of these medallions, that of the Physicians, is now removed to the inside of the church.

<sup>5</sup> It is fully described by Filarete in his *Trattato dell' architettura*, written in 1464, and therefore was finished before that date; see also Vasari, ed. Milanesi (Florence, 1880), ii. p. 174.

<sup>6</sup> His will, dated 19th February 1471, is published by Gaye, *Cart. ined.* i. p. 185.

<sup>7</sup> In the works of Perkins and others on Italian sculpture these Perugian reliefs are wrongly stated to be of enamelled clay.



its application to various architectural uses, such as friezes and to the making of lavabos (lavatories), fountains and large retables. The result of this was that, though the finest reliefs from the workshop of Andrea were but little if at all inferior to those from the hand of Luca, yet some of them, turned out by pupils and assistants, reached only a lower standard of merit. Only one work in marble by Andrea is known, namely, an altar in S. Maria delle Grazie near Arezzo, mentioned by Vasari (ed. Milanese, ii. p. 179), and still well preserved.

One variety of method was introduced by Andrea in his enamelled work; sometimes he omitted the enamel on the face and hands (nude parts) of his figures, especially in those cases where he had treated the heads in a realistic manner; as, for example, in the noble tympanum relief of the meeting of St Dominic and St Francis in the loggia of the Florentine hospital of S. Paolo,—a design suggested by a fresco of Fra Angelico's in the cloister of St Mark's. One of the most remarkable works by Andrea is the series of medallions with reliefs of Infants in white on a blue ground set on the front of the foundling hospital at Florence. These lovely child-figures are modelled with wonderful skill and variety, no two being alike. Andrea produced, for gilds and private persons, a large number of reliefs of the Madonna and Child varied with much invention, and all of extreme beauty of pose and sweetness of expression. These are frequently framed with realistic yet decorative garlands of fruit



FIG. 2.—Enamelled Clay Relief of Virgin and Child, by Andrea.

and flowers painted with coloured enamels, while the main relief is left white. Fig. 2 shows a good example of these smaller works. The hospital of S. Paolo, near S. Maria Novella, has also a number of fine medallions with reliefs of saints, two of Christ Healing the Sick, and two fine portraits, under which are white plaques inscribed—"DALL ANNO 1451 ALL ANNO 1495"<sup>1</sup>; the first of these dates is the year when the hospital was rebuilt owing to a papal brief sent to the archbishop of Florence. Arezzo possesses a number of fine enamelled works by Andrea and his

<sup>1</sup> Professor Marquand has discovered, beneath 1451, the inscription Prete Benino, and, under 1495, De Benini; probably the names of the governors of the hospital at these dates.

sons—a retable in the cathedral with God holding the Crucified Christ, surrounded by angels, and below, kneeling figures of S. Donato and S. Bernardino; also in the chapel of the Campo Santo is a fine relief of the Madonna and Child with four saints at the sides. In S. Maria in Grado is a very noble retable with angels holding a crown over a standing figure of the Madonna; a number of small figures of worshippers take refuge in the folds of the Virgin's mantle, a favourite motive for sculpture dedicated by gilds or other corporate bodies. Perhaps the finest collection of works of this class is at La Verna, not far from Arezzo (see Vasari, ed. Milanese, ii. p. 179). The best of these, three large retables with representations of the Annunciation, the Crucifixion, and the Madonna giving her Girdle to St Thomas, are probably the work of Andrea himself, the others being by his sons. In 1489 Andrea made a beautiful relief of the Virgin and two Angels, now over the archive-room door in the Florentine Opera del Duomo; for this he was paid twenty gold florins (see Cavallucci, *S. Maria del Fiore*). In the same year he modelled the fine tympanum relief over a door of Prato cathedral, with a half-length figure of the Madonna between St Stephen and St Lawrence, surrounded by a frame of angels' heads.

In 1491 he was still working at Prato, where many of his best reliefs still exist. A fine bust of S. Lino exists over the side door of the cathedral at Volterra, which is attributed to Andrea. Other late works of known date are a magnificent bust of the Protonotary Almadiano, made in 1510 for the church of S. Giovanni de' Fiorentini at Viterbo, now preserved in the Palazzo Comunale there, and a medallion of the Virgin in Glory, surrounded by angels, made in 1505 for Pistoia cathedral.<sup>2</sup> The latest work attributed to Andrea, though apparently only a workshop production of 1515, is a relief representing the Adoration of the Magi, made for a little church, St Maria, in Pian di Mugnone, near Florence.<sup>3</sup> Portions of this work are still in the church, but some fragments of it are at Oxford.

III., IV. Five of Andrea's seven sons worked with their father, and after his death carried on the Robbia fabrique; the dates of their birth are shown in the table on p. 838 *ante*. Early in life two of them came under the influence of Savonarola, and took monastic orders at his Dominican convent; these were MARCO, who adopted the name of Fra Luca, and PAOLO, called Fra Ambrogio. One relief by the latter, a Nativity with four life-sized figures of rather poor work, is in the Cappella degli Spagnuoli in the Sienese convent of S. Spirito; a MS. in the convent archives records that it was made in 1504.

V. The chief existing work known to be by the second LUCA<sup>4</sup> is the very rich and beautiful tile pavement in the uppermost story of Raphael's loggie at the Vatican, finely designed and painted in harmonious majolica colours. This was made by Luca at Raphael's request and under his supervision in 1518.<sup>5</sup> It is still in very fine preservation.

VI. GIOVANNI DELLA ROBBIA (1469-1529?) during a great part of his life worked as assistant to his father, Andrea, and in many cases the enamelled sculpture of the two cannot be distinguished. Some of Giovanni's independent works are of great merit, especially the earlier ones; during the latter part of his life his reliefs deteriorated in style, owing mainly to the universal decadence of the time. A very large number of pieces of Robbia ware which are attributed to Andrea, and even to the elder Luca, were really by the hand of Giovanni. One of his finest works is a large retable at Volterra in the church of S. Girolamo, dated 1501; it represents the Last Judgment, and is remarkable for the fine modelling of the figures, especially that of the archangel Michael, and a nude kneeling figure of a youth who has just risen from his tomb. Quite equal in beauty to anything of his father's, from

<sup>2</sup> See Gualandi, *Memorie risguardanti le belle arti* (Bologna, 1845), vi. pp. 33-35, where original documents are printed recording the dates and prices paid for these and other works of Andrea.

<sup>3</sup> See a document printed by Milanese in his Vasari, ii. p. 180.

<sup>4</sup> It appears certain that this Luca was a layman and not the Fra Luca referred to above.

<sup>5</sup> It is illustrated by Gruner, *Fresco Decorations of Italy* (London, 1854), pl. iv.; see also Müntz, *Raphaël, sa vie, &c.* (Paris, 1881), p. 452, note i., and Vasari, ed. Milanese, ii. p. 182.



whom the design of the figures was probably taken, is the washing-fountain in the sacristy of S. Maria Novella at Florence, made in 1497.<sup>1</sup> It is a large arched recess with a view of the seashore, not very decorative in style, painted on majolica tiles at the back. There are also two very beautiful painted majolica panels of fruit-trees let into the lower part. In the tympanum of the arch is a very lovely white relief of the Madonna between two Adoring Angels (see fig. 3). Long coloured garlands of fruit and flowers are held by nude boys reclining on the top of the arch and others



FIG. 3.—Relief of Madonna and Angels in the tympanum of the lavabo (S. Maria Novella, Florence), by Giovanni.

standing on the cornice. All this part is of enamelled clay, but the basin of the fountain is of white marble. Neither Luca nor Andrea was in the habit of signing his work, but Giovanni often did so, usually adding the date, probably because other potters had begun to imitate the Robbia ware.<sup>2</sup>

Giovanni lacked the original talent of Luca and Andrea, and so he not only copied their work but even reproduced in clay the marble sculpture of Pollaiuolo, Da Settignano, Verrocchio and others. A relief by him, evidently taken from Mino da Fiesole, exists in the Palazzo Castracane Staccoli. Among the very numerous other works of Giovanni are a relief in the wall of a suppressed convent in the Via Nazionale at Florence, and two reliefs in the Bargello dated 1521 and 1522. That dated 1521 is a many-coloured relief of the Nativity, and was taken from the church of S. Girolamo in Florence; it is a too pictorial work, marred by the use of many different planes. Its predella has a small relief of the Adoration of the Magi, and is inscribed "Hoc opus fecit Ioanes Andee de Robia, ac a posuit hoc in tempore die ultima Iulii ANO. DNI. M.D. XXI." At Pisa in the Campo Santo is a relief in Giovanni's later and poorer manner dated 1520; it is a Madonna surrounded by angels, with saints below—the whole overcrowded with figures and ornaments. Giovanni's largest and perhaps finest work is the polychromatic frieze on the outside of the Del Ceppo hospital at Pistoia, for which he received various sums of money between 1525 and 1529, as is recorded in documents which still exist among the archives of the hospital.<sup>3</sup> The subjects of this frieze are the Seven Works of Mercy, forming a continuous band of sculpture in high relief, well modelled and designed in a very broad sculptural way, but disfigured by the crudeness of some of its colouring. Six of these reliefs are by Giovanni, namely, Clothing the Naked, Washing the Feet of Pilgrims,

<sup>1</sup> See a document printed by Milanesi in his Vasari, ii. 193.

<sup>2</sup> Examples of these imitations are a retable in S. Lucchese near Poggibonsi dated 1514, another of the Madonna and Saints at Monte San Savino of 1525, and a third in the Capuchin church of Arceria near Sinigaglia; they are all inferior to the best works of the Robbia family, though some of them may have been made by assistants trained in the Robbia workshops.

<sup>3</sup> The hospital itself was begun in 1514.

Visiting the Sick, Visiting Prisoners, Burying the Dead, and Feeding the Hungry. The seventh, Giving drink to the Thirsty, was made by Filippo Paladini of Pistoia in 1585; this last is simply made of painted stucco. The large figures of the virtues placed between the scenes, and the medallions between the pillars, are the work of assistants or imitators.

A large octagonal font of enamelled clay, with pilasters at the angles and panels between them with scenes from the life of the Baptist, in the church of S. Leonardo at Cerreto Guidi, is a work of the school of Giovanni; the reliefs are pictorial in style and coarse in execution. Giovanni's chief pupil was a man named Benedetto Buglioni (1461–1521), and a pupil of his, one Santi Buglioni (b. 1494), entered the Robbia workshops in 1521, and assisted in the later works of Giovanni.

VII. GIROLAMO DELLA ROBBIA (1488–1566), another of Andrea's sons, was an architect and a sculptor in marble and bronze as well as in enamelled clay. During the first part of his life he, like his brothers, worked with his father, but in 1528 he went to France and spent nearly forty years in the service of the French Royal family. Francis I. employed him to build a palace in the Bois de Boulogne called the Château de Madrid. This was a large well-designed building, four storeys high, two of them having open loggie in the Italian fashion. Girolamo decorated it richly with terra-cotta medallions, friezes and other architectural features.<sup>4</sup> For this purpose he set up kilns at Suresnes. Though the palace itself has been destroyed, drawings of it exist.<sup>5</sup>

The best collections of Robbia ware are in the Florentine Bargello, Accademia and Museo del Duomo; the Victoria and Albert Museum (the finest out of Italy); the Louvre, the Cluny and the Berlin Museums; while fine examples are to be found in New York, Boston, St Petersburg and Vienna. Many fine specimens exist in private collections in England, France, Germany and the United States. The greater part of the Robbia work still remains in the churches and other buildings of Italy, especially in Florence, Fiesole, Arezzo, La Verna, Volterra, Barga, Montepulciano, Lucca, Pistoia, Prato and Siena.

LITERATURE.—H. Barbet de Jouy, *Les della Robbia* (Paris, 1855); W. Bode, *Die Künstlerfamilie della Robbia* (Leipzig, 1878); "Luca della Robbia ed i suoi precursori in Firenze," *Arch. stor. dell' arte* (1899); "Über Luca della Robbia," *Sitzungsbericht von der Berliner kunstgeschichtlichen Gesellschaft* (1896); *Florentiner Bildhauer der Renaissance* (Berlin, 1902); G. Carocci, *I Dintorni de Firenze* (Florence, 1881); "Il Monumento di Benozzo Federighi," *Arte e Storia* (1894); "Opere Robbiane poco noti," *Arte e storia* (1898, 1899); Cavallucci et Molinier, *Les della Robbia* (Paris, 1884); Maud Crutwell, *Luca and Andrea della Robbia and their Successors* (London, 1902); A. du Cerceau, *Les plus excellents bastiments de France* (Paris, 1586); G. Milanesi, *Le Vite scritte da Vasari* (Florence, 1878); M. Reymond, *Les della Robbia* (Florence, 1897); *La Sculpture Florentine* (Florence, 1898); I. B. Supino, *Catalogo del R. Museo di Firenze* (Rome 1898); Vasari (see Milanesi's edition). (J. H. M.: W. B. \*)

DELMEDIGO, a Cretan Jewish family, of whom the following are the most important:

ELIJAH DELMEDIGO (1460–1497), philosopher, taught in several Italian centres of learning. He translated some of Averroes' commentaries into Latin at the instigation of Pico di Mirandola. In the sphere of religion, Delmedigo represents the tendency to depart from the scholastic attitude in which religion and philosophy were identified. His most important work was devoted to this end; it was entitled *Behinath ha-Dath* (Investigation of Religion).

JOSEPH SOLOMON DELMEDIGO (1501–1655), pupil of Galileo, wrote many books on science and philosophy, and bore a considerable part in initiating the critical movement in Judaism. He belonged to the sceptical school, and though his positive contributions to literature were not of lasting worth, Graetz includes him among the important formative influences within the synagogue of the 17th century. (I. A.)

<sup>4</sup> The Sèvres Museum possesses some fragments of these decorations.

<sup>5</sup> See Laborde, *Château de Madrid* (Paris, 1853), and *Comptes des bâtiments du roi* (Paris, 1877–1880), in which a full account is given of Girolamo's work in connexion with this palace.

**DELMENHORST**, a town of Germany, grand duchy of Oldenburg, on the Delme, 8 m. by rail W. from Bremen, at the junction of a line to Vechta. Pop. (1905) 20,147. It has a Protestant and a Roman Catholic church, and is the seat of considerable industries; notably wool-combing, weaving, jute-spinning and the manufacture of linoleum. Delmenhorst was founded in 1230, and from 1247 to 1679, when it was destroyed by the French, was protected by a strong castle.

**DELOLME, JEAN LOUIS** (1740-1806), Swiss jurist and constitutional writer, was born at Geneva in 1740. He studied for the bar, and had begun to practise when he was obliged to emigrate on account of a pamphlet entitled *Examen de trois parts de droit*, which gave offence to the authorities of the town. He took refuge in England, where he lived for several years on the meagre and precarious income derived from occasional contributions to various journals. In 1775 he found himself compelled to accept aid from a charitable society to enable him to return home. He died at Sewen, a village in the canton of Schwyz, on the 16th of July 1806.

During his protracted exile in England Delolme made a careful study of the English constitution, the results of which he published in his *Constitution de l'Angleterre* (Amsterdam, 1771), of which an enlarged and improved edition in English appeared in 1772, and was several times reprinted. The work excited much interest as containing many acute observations on the causes of the excellence of the English constitution as compared with that of other countries. It is, however, wanting in breadth of view, being written before the period when constitutional questions were treated in a scientific manner. Along with a translation of Hume's *History of England* it supplied the *philosophes* with most of their ideas about the English constitution. It thus was used somewhat as a political pamphlet. Several editions were published after the author's death. Delolme also wrote in English *Parallel between the English Government and the former Government of Sweden* (1772); *A History of the Flagellants* (1782), based upon a work of Boileau's; *An Essay on the Union of Scotland with England* (1787), and one or two smaller works.

**DELONEY** (or DELONE), **THOMAS**, English ballad-writer and pamphleteer, produced his earliest indisputable work in 1586, and died about 1600. In 1596 Thomas Nashe, in his *Have with you to Saffron Walden*, wrote: "Thomas Deloney, the ballating silk-weaver, hath rime enough for all myracles, and wit to make a Garland of Good Will more than the premisses . . . and this deare yeare, together with the silencing of his looms, scarce that, he being constrained to betake himself to carded ale; whence it proceedeth that since Candlemas, or his jigge, John for the king, not one merrie dittie will come from him, but, the Thunderbolt against Swearers,—Repent, England, Repent—and, the strange Judgements of God." In 1588 the coming of the Armada inspired him for three broadsides, which were reprinted (1860) by J. O. Halliwell-Phillipps. They are entitled "The Queenes visiting of the Campe at Tilsburie with her entertainment there," "A Joyful new Ballad, declaring the happie obtaining of the great Galleazzo . . .," and "A new Ballet of the strange and Most cruell Whippes which the Spaniards had prepared." A collection of *Strange Histories* (1607) consists of historical ballads by Deloney, with some poems from other hands. This collection, known in later and enlarged editions as *The Royal Garland of Love and Delight and The Garland of Delight*, contains the ballad of Fair Rosamond. J. H. Dixon in his preface to *The Garland of Good Will* (Percy Society, 1851) ascribes to Deloney *The Blind Beggar of Bednall Green*, and *The Pleasant and sweet History of Patient Grissel*, in prose, with the whole of the *Garland of Good Will*, including some poems such as "The Spanish Lady's Love" generally supposed to be by other hands. His other works include *The Gentle Craft* (1597) in praise of shoemakers, *The Pleasant Historie of John Winchcombe* (8th ed., 1619), and *Thomas of Reading or the Sixe Worthie Yeomen of the West* (earliest extant edition, 1612). Kempe, the actor, jeers at these histories in his *Nine Daies Wonder*, but they were very popular, being reprinted as penny chap-books.

**DE LONG, GEORGE WASHINGTON** (1844-1881), American explorer, was born in New York city on the 22nd of August 1844. He graduated at the U.S. Naval Academy in 1865, and spent the next fourteen years in naval service in various parts of the world, attaining the rank of lieutenant in 1869, and lieutenant-commander in 1879. In 1873 he took part in the voyage of the "Juniata," sent to search for and relieve the American Arctic expedition under Hall in the "Polaris," commanding a steam launch which was sent out from Upernivik, Greenland, to make a thorough search of Melville Bay. On his return to New York the same year he proposed to James Gordon Bennett, of *The New York Herald*, that the latter should fit out a Polar expedition. It was not until 1879 that the final arrangements were made, the "Pandora," a yacht which had already made two Arctic voyages under Sir Allen Young, being purchased and rechristened the "Jeannette" for this voyage. The story of this expedition (see POLAR REGIONS) is chiefly remarkable on account of the long and helpless drifting of the "Jeannette" with the polar ice-pack in which she was caught (September 5, 1879) and by which she was finally crushed and sunk on the 13th of June 1881. The members of the expedition set out in three boats, one of which was lost in a gale, while another boat-load under De Long died from starvation after reaching the mouth of the Lena river. He was the last survivor of his party. His journal, in which he made regular entries up to the day on which he died (October 30, 1881) was edited by his wife and published in 1883 under the title *Voyage of the "Jeannette"*; and an account of the search which was made for him and his comrades by his heroic companion George W. Melville, who was chief engineer of the expedition and commanded the third of the retreating parties, was published a year later under the title of *In the Lena Delta*. The fate of the "Jeannette" was still more remarkable in its sequel. Three years after she had sunk several articles belonging to her crew were found on an ice-floe near Julienshaab on the southwest coast of Greenland; thus adding fresh evidence to the theory of a continuous ocean current passing across the unknown Polar regions, which was to be finally demonstrated by Nansen's voyage in the "Fram." By direction of the United States government, the remains of De Long and his companions were brought home and interred with honour in his native city.

**DELORME, MARION** (c. 1613-1650), French courtesan, was the daughter of Jean de Lou, sieur de l'Orme, president of the treasurers of France in Champagne, and of Marie Chastelain. She was born at her father's chateau near Champaubert. Initiated into the philosophy of pleasure by the epicurean and atheist Jacques Vallée, sieur Desbarreaux, she soon left him for Cinq Mars, at that time at the height of his popularity, and succeeded, it is said, in marrying him in secret. From this time Marion Delorme's salon became one of the most brilliant centres of elegant Parisian society. After the execution of Cinq Mars she is said to have numbered among her lovers Charles de St Evremond (1610-1703) the wit and littérateur, Buckingham (Villiers), the great Condé, and even Cardinal Richelieu. Under the Fronde her salon became a meeting place for the disaffected, and Mazarin is said to have sent to arrest her when she suddenly died. Her last years have been adorned with considerable legend (cf. Mercourt, *Confessions de Marie Delorme*, Paris, 1856). It seems established that she died in 1650. But she was believed to have lived until 1706 or even 1741, after having had the most fantastic adventures, including marriage with an English lord, and an old age spent in poverty in Paris. Her name has been popularized by various authors, especially by Alfred de Vigny in his novel *Cinq Mars*, by Victor Hugo in the drama *Marion Delorme*, and by G. Bottesini in an opera of the same title.

See P. J. Jacob, *Marion Delorme et Ninon Lenclos* (Paris, 1859); J. Peladan, *Histoire et légende de Marion de Lorme* (Paris, 1882).

**DE L'ORME, PHILIBERT** (c. 1510-1570), French architect, one of the great masters of the Renaissance, was born at Lyons, the son of Jehan de L'Orme, who practised the same art and brought his son up to it. At an early age Philibert was sent to Italy to study (1533-1536) and was employed there by Pope Paul III. Returning to France he was patronized by Cardinal du Bellay

at Lyons, and was sent by him about 1540 to Paris, where he began the Château de St Maur, and enjoyed royal favour; in 1545 he was made architect to Francis I. and given the charge of works in Brittany. In 1548 Henry II. gave him the supervision of Fontainebleau, Saint-Germain and the other royal buildings; but on his death (1559) Philibert fell into disgrace. Under Charles IX., however, he returned to favour, and was employed to construct the Tuileries, in collaboration with Jean Brillant. He died in Paris on the 8th of January 1570. Much of his work has disappeared, but his fame remains. An ardent humanist and student of the antique, he yet vindicated resolutely the French tradition in opposition to Italian tendencies; he was a man of independent mind and a vigorous originality. His masterpiece was the Château d'Anet (1552-1559), built for Diane de Poitiers, the plans of which are preserved in Du Cerceau's *Plus excellens bastimens de France*, though part of the building alone remains; and his designs for the Tuileries (also given by Du Cerceau), begun by Catherine de' Medici in 1565, were magnificent. His work is also seen at Chenonceaux and other famous châteaux; and his tomb of Francis I. at St Denis remains a perfect specimen of his art. He wrote two books on architecture (1561 and 1567).

See Marius Vachon, *Philibert de L'Orme* (1887); Chevalier, *Lettres et devis relatifs à la construction de Chenonceaux* (1864); Pför, *Monographie du château d'Anet* (1867); Herbet, *Travaux de P. de L'Orme à Fontainebleau* (1890).

**DELOS** (mod. *Mikra Dili*, or Little Delos, to distinguish it from Megali Dili, or Great Delos), an island in the Aegean, the smallest but most famous of the Cyclades, and, according to the ancient belief, the spot round which the group arranged itself in a nearly circular form. It is a rugged mass of granite, about 3 m. long and 1 m. to  $\frac{1}{2}$  m. broad, about  $\frac{1}{2}$  m. E. of Megali Dili or Rheneia, and 2 m. W. of Myconus. Towards the centre it rises to its greatest height of 350 ft. in the steep and rocky peak of Mount Cynthus, which, though overtopped by several eminences in the neighbouring islands, is very conspicuous from the surrounding sea. It is now completely destitute of trees, but it abounds with brushwood of lentisk and cistus, and here and there affords a patch of corn-land to the occasional sower from Myconus.

**I. Archaeology.**—Excavations have been made by the French School at Athens upon the island of Delos since 1877, chiefly by Th. Homolle. They have proceeded slowly but systematically, and the method adopted, though scientific and economical, left the site in some apparent confusion, but the débris have more recently been cleared away to a considerable extent. The complete plan of the sacred precinct of Apollo has been recovered, as well as those of a considerable portion of the commercial quarter of Hellenistic and Roman times, of the theatre, of the temples of the foreign gods, of the temples on the top of Mount Cynthus, and of several very interesting private houses. Numerous works of sculpture of all periods have been found, and also a very extensive series of inscriptions, some of them throwing much light upon the subject of temple administration in Greece.

The most convenient place for landing is protected by an ancient

mole; it faces the channel between Delos and Rheneia, and is about opposite the most northerly of the two little islands now called *Πευματιάρι*. From this side the sacred precinct of Apollo is approached by an avenue flanked by porticoes, that upon the seaside bearing the name of Philip V. of Macedon, who dedicated it about 200 B.C. This avenue must have formed the usual approach for sacred embassies and processions; but it is probable that the space to the south was not convenient for marshalling them, since Nicias, on the occasion of his famous embassy, built a bridge from the island of Hecate (the Greater Rhevmatiari) to Delos, in order that the imposing Athenian procession might not miss its full effect. Facing the avenue were the propylaea

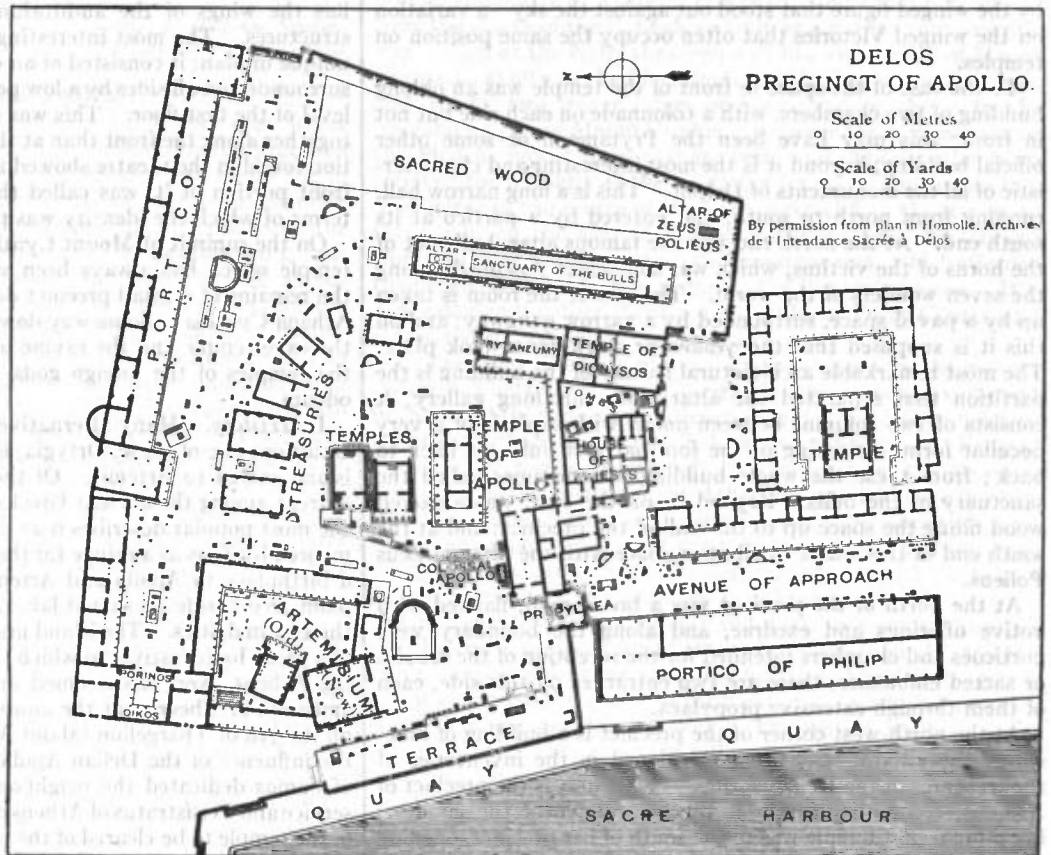

that formed the chief entrance of the precinct of Apollo. They consisted of a gate faced on the outside with a projecting portico of four columns, on the inside with two columns *in antis*. Through this one entered a large open space, filled with votive offerings and containing a large exedra. The sacred road continued its course to the north-east corner of this open space, with the precinct of Artemis on its west side, and, on its east side, a terrace on which stood three temples. The southernmost of these was the temple of Apollo, but only its back was visible from this side. Though there is no evidence to show to whom the other two were dedicated, the fact that they faced west seems to imply that they were either dedicated to heroes or minor deities, or that they were treasuries. Beyond them a road branches to the right, sweeping round in a broad curve to the space in front of the temple of Apollo. The outer side of this curve is bounded by a row of treasuries, similar to those found at Delphi and Olympia, and serving to house the more costly offerings of various islands or cities. The space to the east and south of the temple of Apollo could also be approached directly from the propylaea of entrance, by turning to the right through a passage-like building with a porch at either end. Just to the north of this may be seen the basis of the colossal statue of Apollo dedicated by the Naxians, with its well-known archaic inscription; two large fragments of the statue itself may still be seen a little farther to the north.

The temple of Apollo forms the centre of the whole precinct,

which it dominates by the height of its steps as well as of the terrace already mentioned; its position must have been more commanding in ancient times than it is now that heaps of earth and débris cover so much of the level. The temple was of Doric style, with six columns at the front and back and thirteen at the sides; it was built early in the 4th century B.C.; little if any traces have been found of the earlier building which it superseded. Its sculptural decoration appears to have been but scanty; the metopes were plain. The groups which ornamented, as acroteria, the two gables of the temple have been in part recovered, and may now be seen in the national museum at Athens; at the one end was Boreas carrying off Oreithyia, at the other Eos and Cephalus, the centre in each case being occupied by the winged figure that stood out against the sky—a variation on the winged Victories that often occupy the same position on temples.

To the east of the space in front of the temple was an oblong building of two chambers, with a colonnade on each side but not in front; this may have been the Prytaneum or some other official building; beyond it is the most interesting and characteristic of all the monuments of Delphi. This is a long narrow hall, running from north to south, and entered by a portico at its south end. At the north end was the famous altar, built out of the horns of the victims, which was sometimes reckoned among the seven wonders of the world. The rest of the room is taken up by a paved space, surrounded by a narrow gangway; and on this it is supposed that the *γέρανος* or stork-dance took place. The most remarkable architectural feature of the building is the partition that separated the altar from this long gallery; it consists of two columns between *antae*, with capitals of a very peculiar form, consisting of the fore parts of bulls set back to back; from these the whole building is sometimes called the sanctuary of the bulls. Beyond it, on the east, was a sacred wood filling the space up to the wall of the precinct; and at the south end of this was a small open space with the altar of Zeus Polieus.

At the north of the precinct was a broad road, flanked with votive offerings and exedrae, and along the boundary were porticoes and chambers intended for the reception of the *θεωπία* or sacred embassies; there are two entrances on this side, each of them through extensive propylaea.

At the north-west corner of the precinct is a building of limestone, the *πύργος ὄκος* often mentioned in the inventories of the treasures of the Delian shrine. South of it is the precinct of Artemis, containing within it the old temple of the goddess; her more recent temple was to the south of her precinct, opening not into it but into the open space entered through the southern propylaea of the precinct of Apollo. The older temple is mentioned in some of the inventories as "the temple in which were the seven statues"; and close beside it was found a series of archaic draped female statues, which was the most important of its kind until the discovery of the finer and better preserved set from the Athenian Acropolis.

Within the precinct there were found many statues and other works of art, and a very large number of inscriptions, some of them giving inventories of the votive offerings and accounts of the administration of the temple and its property. The latter are of considerable interest, and give full information as to the sources of the revenue and its financial administration.

Outside the precinct of Apollo, on the south, was an open place; between this and the precinct was a house for the priests, and within it, in a kind of court, a set of small structures that may perhaps be identified as the tombs of the Hyperborean maidens. Just to the east was the temple of Dionysus, which is of peculiar plan, and faces the open place; on the other side of it is a large rectangular court, surrounded by colonnades and chambers which served as offices, the whole forming a sort of commercial exchange; in the middle of it was a temple dedicated to Aphrodite and Hermes.

To the north of the precinct of Apollo, between it and the sacred lake, there are very extensive ruins of the commercial town of Delos; these have been only partially cleared, but have

yielded a good many inscriptions and other antiquities. The most extensive building is a very large court surrounded by chambers, a sort of club or exchange. Beyond this, on the way to the east coast, are the remains of the new and the old palaestra, also partially excavated.

The shore of the channel facing Rheneia is lined with docks and warehouses, and behind them, as well as elsewhere in the island, there have been found several private houses of the 2nd or 3rd century B.C. Each of these consists of a single court surrounded by columns and often paved with mosaic; various chambers open out of the court, including usually one of large proportions, the *ἀνδρῶν* or dining-room for guests.

The theatre, which is set in the lower slope of Mount Cynthus, has the wings of the auditorium supported by massive substructures. The most interesting feature is the *scena*, which is unique in plan; it consisted of an oblong building of two storeys, surrounded on all sides by a low portico or terrace reaching to the level of the first floor. This was supported by pillars, set closer together along the front than at the sides and back. An inscription found in the theatre showed that this portico, or at least the front portion of it, was called the proscenium or logeum, two terms of which the identity was previously disputed.

On the summit of Mount Cynthus, above the primitive cave-temple which has always been visible, there have been found the remains of a small precinct dedicated to Zeus Cynthius and Athena Cynthia. Some way down the slope of the hill, between the cave-temple and the ravine of the Inopus, is a terrace with the temples of the foreign gods, Isis and Serapis, and a small odeum.

II. *History*.—Many alternative names for Delos are given by tradition; one of these, Ortygia, is elsewhere also assigned to an island sacred to Artemis. Of the various traditions that were current among the ancient Greeks regarding the origin of Delos, the most popular describes it as drifting through the Aegean till moored by Zeus as a refuge for the wandering Leto. It supplied a birthplace to Apollo and Artemis, who were born beneath a palm tree beside its sacred lake, and became for ever sacred to these twin deities. The island first appears in history as the seat of a great Ionic festival to which the various Ionic states, including Athens, were accustomed annually to despatch a sacred embassy, or *Theoria*, at the anniversary of the birth of the god on the 7th of Thargelion (about May). In the 6th century B.C. the influence of the Delian Apollo was at its height; Polycrates of Samos dedicated the neighbouring island of Rheneia to his service and Peisistratus of Athens caused all the area within sight of the temple to be cleared of the tombs by which its sanctity was impaired. After the Persian wars, the predominance of Athens led to the transformation of the Delian amphictyony into the Athenian empire. (See DELIAN LEAGUE.) In 426 B.C., in connexion with a reorganization of the festival, which henceforth was celebrated in the third year of every Olympiad, the Athenians instituted a more elaborate lustration, caused every tomb to be removed from the island, and established a law that ever after any one who was about to die or to give birth to a child should be at once conveyed from its shores. And even this was not accounted sufficient, for in 422 they expelled all its secular inhabitants, who were, however, permitted to return in the following year. At the close of the Peloponnesian War the Spartans gave to the people of Delos the management of their own affairs; but the Athenian predominance was soon after restored, and survived an appeal to the amphictyony of Delphi in 345 B.C. During Macedonian times, from 322 to 166 B.C., Delos again became independent; during this period the shrine was enriched by offerings from all quarters, and the temple and its possessions were administered by officials called *ἐπορωτοί*. After 166 B.C. the Romans restored the control of Delian worship to Athens, but granted to the island various commercial privileges which brought it great prosperity. In 87 B.C. Menophanes, the general of Mithradates VI. of Pontus, sacked the island, which had remained faithful to Rome. From this blow it never recovered; the Athenian control was resumed in 42 B.C., but Pausanias (viii. 33. 2) mentions Delos as deserted but for a



few Athenian officials; and several epigrams of the 1st or 2nd century A.D. attest the same fact, though the temple and worship were probably kept up until the official extinction of the ancient religion. A museum has now been built to contain the antiquities found in the excavations; otherwise Delos is now uninhabited, though during the summer months a few shepherds cross over with their flocks from Myconus or Rheneia. As a religious centre it is replaced by Tenos and as a commercial centre by the flourishing port of Syra.

See Lebègue, *Recherches sur Délos* (Paris, 1876). Numerous articles in the *Bulletin de correspondance hellénique* record the various discoveries at Delos as they were made. See also Th. Homolle, *Les Archives de l'intendance sacrée à Délos* (with plan). The best consecutive account is given in the *Guide Joanne, Grèce*, ii. 443-464. For history, see Sir R. C. Jebb, *Journal of Hellenic Studies*, i. (1889), pp. 7-62. For works of art found at Delos see GREEK ART.

**DE LOUTHERBOURG, PHILIP JAMES** (1740-1812), English artist, was born at Strassburg on the 31st of October 1740, where his father, the representative of a Polish family, practised miniature painting; but he spent the greater part of his life in London, where he was naturalized, and exerted a considerable influence on the scenery of the English stage, as well as on the artists of the following generation. De Louthembourg was intended for the Lutheran ministry, and was educated at the university of Strassburg. As the calling, however, was foreign to his nature, he insisted on being a painter, and placed himself under Vanloo in Paris. The result was an immediate and precocious development of his powers, and he became a figure in the fashionable society of that day. In 1767 he was elected into the French Academy below the age required by the law of the institution, and painted landscapes, sea storms, battles, all of which had a celebrity above those of the specialists then working in Paris. His début was made by the exhibition of twelve pictures, including "Storm at Sunset," "Night," "Morning after Rain." He is next found travelling in Switzerland, Germany and Italy, distinguishing himself as much by mechanical inventions as by painting. One of these, showing quite new effects produced in a model theatre, was the wonder of the day. The exhibition of lights behind canvas representing the moon and stars, the illusory appearance of running water produced by clear blue sheets of metal and gauze, with loose threads of silver, and so on, were his devices. In 1771 he came to London, and was employed by Garrick, who offered him £500 a year to apply his inventions to Drury Lane, and to superintend the scene-painting, which he did with complete success, making a new era in the adjuncts of the stage. Garrick's own piece, the *Christmas Tale*, and the pantomime, 1781-1782, introduced the novelties to the public, and the delight not only of the masses, but of Reynolds and the artists, was unbounded. The green trees gradually became russet, the moon rose and lit the edges of passing clouds, and all the world was captivated by effects we now take little notice of. A still greater triumph awaited him on his opening an entertainment called the "Eidophusicon," which showed the rise, progress and result of a storm at sea—that which destroyed the great Indiaman, the "Halsewell,"—and the Fallen Angels raising the Palace of Pandemonium. De Louthembourg has been called the inventor of the panorama, but this honour does not belong to him, although it first appeared about the same time as the eidophusicon. The first panorama was painted and exhibited by Robert Barker.

All this mechanism did not prevent De Louthembourg from painting. "Lord Howe's Victory off Ushant" (1794), and other large naval pictures were commissioned for Greenwich Hospital Gallery, where they still remain. His finest work was the "Destruction of the Armada." He painted also the Great Fire of London, and several historical works, one of these being the "Attack of the Combined Armies on Valenciennes" (1793). He was made R.A., in addition to other distinctions, in 1781, shortly after which date we find an entirely new mental impulse taking possession of him. He joined Balsamo, comte de Cagliostro, and travelled about with this extraordinary person—leaving him, however, before his condemnation to death. We do not hear

that Mesmer had attracted De Louthembourg, nor do we find an exact record of his connexion with Cagliostro. A pamphlet published in 1789, *A List of a few Cures performed by Mr and Mrs De Louthembourg without Medicine*, shows that he had taken up faith-healing, and there is a story that a successful projection of the philosopher's stone was only spoiled by the breaking of the crucible by a relative. He died on the 11th of March 1812. His publications are few—some sets of etchings, and *English Scenery* (1805).

**DELPHI** (the Pytho of Homer and Herodotus; in Boeotian inscriptions Βελφοί, on coins Δελφοί), a place in ancient Greece in the territory of Phocis, famous as the seat of the most important temple and oracle of Apollo. It was situated about 6 m. inland from the shores of the Corinthian Gulf, in a rugged and romantic glen, closed on the N. by the steep wall-like under-cliffs of Mount Parnassus known as the Phaedriades or Shining Rocks, on the E. and W. by two minor ridges or spurs, and on the S. by the irregular heights of Mount Cirphis. Between the two mountains the Pleistus flowed from east to west, and opposite the town received the brooklet of the Castalian fountain, which rose in a deep gorge in the centre of the Parnassian cliff. About 7 m. to the north, on the side of Mount Parnassus, was the famous Corycian cave, a large grotto in the limestone rock, which afforded the people of Delphi a refuge during the Persian invasion. It is now called in the district the Sarant' Aulai or Forty Courts, and is said to be capable of holding 3000 people.

I. *The Site*.—The site of Delphi was occupied by the modern village of Castri until it was bought by the French government in 1891, and the peasant proprietors expropriated and transferred to the new village of Castri, a little farther to the west. Excavations had been made previously in some parts of the precinct; for example, the portico of the Athenians was laid bare in 1860. The systematic clearing of the site began in the spring of 1892, and it was rapidly cleared of earth by means of a light railway. The plan of the precinct is now easily traced, and with the help of Pausanias many of the buildings have been identified.

The ancient wall running east and west, commonly known as the Hellenico, has been found extant in its whole length, and the two boundary walls running up the hill at each end of it, traced. In the eastern of these was the main entrance by which Pausanias went in along the Sacred Way. This paved road is easily recognized as it zigzags up the hill, with treasuries and the bases of various offerings facing it on both sides. It mounts first westwards to an open space, then turns eastwards till it reaches the eastern end of the terrace wall that supports the temple, and then turns again and curves up north and then west towards the temple. Above this, approached by a stair, are the Lesche and the theatre, occupying respectively the north-east and north-west corner of the precinct. On a higher level still, a little to the west, is the stadium. There are several narrow paths and stairs that cut off the zigzags of the Sacred Way.

In describing the monuments discovered by the French excavators, the simplest plan is to follow the route of Pausanias. Outside the entrance is a large paved court of Roman date, flanked by a colonnade. On the north side of the Sacred Way, close to the main entrance, stood the offering dedicated by the Lacedaemonians after the battle of Aegospotami. It was a large quadrangular building of conglomerate, with a back wall faced with stucco, and stood open to the road. On a stepped pedestal facing the open stood the statues of the gods and the admirals, perhaps in rows above one another.

The statues of the Epigoni stood on a semicircular basis on the south side of the way. Opposite them stood another semicircular basis which carried the statues of the Argive kings, whose names are cut on the pedestal in archaic characters, reading from right to left. Farther west was the Sicyonian treasury on the south of the way. It was in the form of a small Doric temple *in antis*, and had its entrance on the east. The present foundations are built of architectural fragments, probably from an earlier building of circular form on the same site. The sculptures from this treasury are in the museum, as are the other sculptures found on the site. These sculptures, which are in



rough limestone, most likely belong to the earlier building, as their surface is in a better state of preservation than could be possible if they had been long exposed to the air. The earlier treasury was probably destroyed either by earthquake or by the percolation of water through the terracing.

The Cnidian treasury stands on the south side of the way farther west. This building was originally surmised by the excavators to be the treasury of Siphnos, but further evidence led them to change their opinion. The treasury was raised on a quadrangular structure, supported on its south side by the Hellenico, and built of tufa. The lower courses are left rough and were most likely hidden. A small Ionic temple of marble with

ancient altar of Athena. Here too was placed the curious column, with many flutes and an Ionic capital, on which stood the colossal sphinx, dedicated by the Naxians, that has been pieced together and placed in the museum.

A little farther on, but below the Sacred Way, is another open space, of circular form, which is perhaps the *ἀλω* or sacred threshing-floor on which the drama of the slaying of the Python by Apollo was periodically performed. Opposite this space, and backed against the beautifully jointed polygonal wall which has for some time been known, and which supports the terrace on which the temple stands, is the colonnade of the Athenians. A dedicatory inscription runs along the face of the top step, and

has been the subject of much dispute. Both the forms of the letters and the style of the architecture show that the colonnade cannot date, as Pausanias says, from the time of the Peloponnesian War; Th. Homolle now assigns it to the end of the 6th century. The polygonal terrace wall at the back, on being cleared, proves to be covered with inscriptions, most of them concerning the manumission of slaves.

After rounding the east end of the terrace wall, the Sacred Way turns northward, leaving the Great Altar, dedicated by the Chians, on the left. After passing the altar, it turns to the left again at right angles, and so enters the space in front

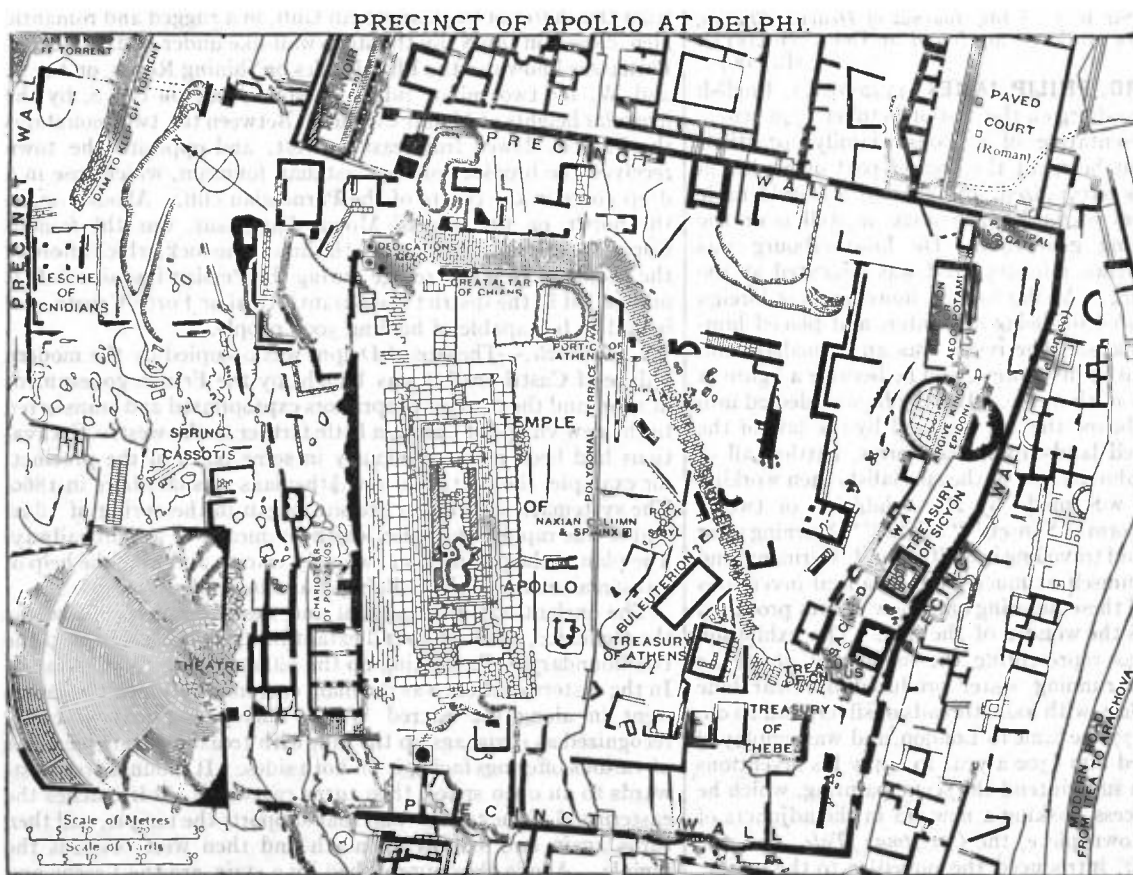

two caryatids between antae stood on this substructure. The sculpture from this treasury, which ornamented its frieze and pediment, is of great interest in the history of the development of the art, and the fragments of architectural mouldings are of great delicacy and beauty. The whole work is perhaps the most perfect example we possess of the transitional style of the early 5th century. Standing back somewhat from the path just as it bends round up the hill is the Theban treasury. Farther north, where the path turns again, is the Athenian treasury. This structure, which was in the form of a small Doric temple *in antis*, appears to have suffered from the building above it having been shaken down by an earthquake. It has now been rebuilt with the original blocks. There can be no doubt about the identity of the building, for the basis on which it stands bears the remains of the dedicatory inscription, stating that it was erected from the spoils of Marathon. Almost all the sculptured metopes are in the museum, and are of the highest interest to the student of archaic art. The famous inscriptions with hymns to Apollo accompanied by musical notation were found on stones belonging to this treasury.

Above the Athenian treasury is an open space, in which is a rock which has been identified as the Sybil's rock. It has steps hewn in it, and has a cleft. The ground round it has been left rough like the space on the Acropolis at Athens identified as the

of the temple. Remains of offerings found in this region include those dedicated by the Cyrenians and by the Corinthians. The site of the temple itself carries the remains of successive structures. Of that built by the Alcmaeonids in the 6th century B.C. considerable remains have been found, some in the foundations of the later temple and some lying where they were thrown by the earthquake. The sculptures found have been assigned to this building, probably to the gables, as they are archaic in character, and show a remarkable resemblance to the sculptures from the pediment of the early temple of Athena at Athens. The existing foundations are these of the temple built in the 4th century. They give no certain information as to the sacred cleft and other matters relating to the oracle. Though there are great hollow spaces in the structure of the foundations, these appear merely to have been intended to save material, and not to have been put to any religious or other use. Up in the north-eastern corner of the precinct, standing at the foot of the cliffs, are the remains of the interesting Cnidian Lesche or Clubhouse. It was a long narrow building accessible only from the south, and the famous paintings were probably disposed around the walls so as to meet in the middle of the north side. Some scanty fragments of the lower part of the frescoed walls have survived; but they are not enough to give any information as to the work of Polygnotus.

At the north-western corner of the precinct is the theatre, one

of the best preserved in Greece. The foundations of the stage are extant, as well as the orchestra, and the walls and seats of the auditorium. There are thirty-three tiers of seats in seven sets, and a paved diazoma. The sculptures from the stage front, now in the museum, have the labours of Heracles as their subject. The date of the theatre is probably early 2nd century B.C.

The stadium lies, as Pausanias says, in the highest part of the city to the north-west. It stands on a narrow plateau of ground supported on the south-east by a terrace wall. The seats have been cleared, and are in a state of extraordinary preservation. A few of those at the east end are hewn in the rock. No trace of the marble seats mentioned by Pausanias has been found, but they have probably been carried off for lime or building, as they could easily be removed. An immense number of inscriptions have been found in the excavations, and many works of art, including a bronze charioteer, which is one of the most admirable statues preserved from ancient times.

II. *History*.—Our information as to the oracle at Delphi and the manner in which it was consulted is somewhat confused; there probably was considerable variation at different periods. The tale of a hole from which intoxicating "mephitic" vapour arose has no early authority, nor is it scientifically probable (see A. P. Oppé in *Journal of Hellenic Studies*, xxiv. 214). The questions had to be given in writing, and the responses were uttered by the Pythian priestess, in early times a maiden, later a woman over fifty attired as a maiden. After chewing the sacred bay and drinking of the spring Cassotis, which was conducted into the temple by artificial channels, she took her seat on the sacred tripod in the inner shrine. Her utterances were reduced to verse and edited by the prophets and the "holy men" (*ἁγιοί*). For the influence and history of the oracle see ORACLE.

Delphi also contained the "Omphalos," a sacred stone bound with fillets, supposed to mark the centre of the earth. It was said Zeus had started two eagles from the opposite extremities and they met there. Other tales said the stone was the one given by Rhea to Cronus as a substitute for Zeus.

For the history of the Delphic Amphictyony see under AMPHICTYONY. The oracle at Delphi was asserted by tradition to have existed before the introduction of the Apolline worship and to have belonged to the goddess Earth (Ge or Gaia). The Homeric Hymn to Apollo evidently combines two different versions, one of the approach of Apollo from the north by land, and the other of the introduction of his votaries from Crete. The earliest stone temple was said to have been built by Trophonius and Agamedes. This was destroyed by fire in 548 B.C., and the contract for rebuilding was undertaken by the exiled Alcmaeonidae from Athens, who generously substituted marble on the eastern front for the poros specified (see CLEISTHENES, *ad init.*). Portions of the pediments of this temple have been found in the excavations; but no sign has been found of the pediments mentioned by Pausanias, representing on the east Apollo and the Muses, and on the west Dionysus and the Thyiades (Bacchantes), and designed by Praxias, the pupil of Calanias. The temple which was seen by Pausanias, and of which the foundations were found by the excavators, was the one of which the building is recorded in inscriptions of the 4th century. A raid on Delphi attempted by the Persians in 480 B.C. was said to have been frustrated by the god himself, by means of a storm or earthquake which hurled rocks down on the invaders; a similar tale is told of the raid of the Gauls in 279 B.C. But the sacrilege thus escaped at the hands of foreign invaders was inflicted by the Phocian defenders of Delphi during the Sacred War, 356–346 B.C., when many of the precious votive offerings were melted down. The Phocians were condemned to replace their value to the amount of 10,000 talents, which they paid in instalments. In 86 B.C. the sanctuary and its treasures were put under contribution by L. Cornelius Sulla for the payment of his soldiers; Nero removed no fewer than 500 bronze statues from the sacred precincts; Constantine the Great enriched his new city by the sacred tripod and its support of intertwined snakes dedicated by the Greek cities after the battle of Plataea. This still exists, with its inscription, in the Hippodrome at Constanti-

nople. Julian afterwards sent Oribasius to restore the temple; but the oracle responded to the emperor's enthusiasm with nothing but a wail over the glory that had departed.

Provisional accounts of the excavations have appeared during the excavations in the *Bulletin de correspondance hellénique*. A summary is given in J. G. Frazer, *Pausanias*, vol. v. The official account is entitled *Fouilles de Delphes*. For history see Hiller von Gärtringen in Pauly-Wissowa, *Realencyclopädie*, s.v. "Delphi." For cult see L. R. Farnell, *Cults of the Greek States*, iv. 179–218. For the works of art discovered see GREEK ART. (E. GR.)

**DELPHINIA**, a festival of Apollo Delphinus held annually on the 6th (or 7th) of the month Munychion (April) at Athens. All that is known of the ceremonies is that a number of girls proceeded to his temple (Delphinium) carrying suppliants' branches and seeking to propitiate Apollo, probably as a god having influence on the sea. It was at this time of year that navigation began again after the storms of winter. According to the story in Plutarch (*Theseus*, 18), Theseus, before setting out to Crete to slay the Minotaur, repaired to the Delphinium and deposited, on his own behalf and that of his companions on whom the lot had fallen, an offering to Apollo, consisting of a branch of consecrated olive, bound about with white wool; after which he prayed to the god and set sail. The sending of the maidens to propitiate the god during the Delphinia commemorates this event in the life of Theseus.

See A. Mommsen, *Festeder Stadt Athen* (1898); L. Preller, *Griechische Mythologie* (4th ed., 1887); P. Stengel, *Die griechische Kultusaltertümer* (1898); Daremberg and Saglio, *Dictionnaire des antiquités*; G. F. Schömann, *Griechische Altertümer* (4th ed., 1897–1902).

**DELPHINUS** ("THE DOLPHIN"), in astronomy, a constellation of the northern hemisphere, mentioned by Eudoxus (4th century B.C.) and Aratus (3rd century B.C.); and catalogued by Ptolemy (10 stars), Tycho Brahe (10 stars), and Hevelius (14 stars). *γ Delphini* is a double star: a yellowish of magnitude 4, and a bluish of magnitude 5.

**DELTA** (from the shape of the Gr. letter Δ, delta, originally used of the mouth of the Nile), a tract of land enclosed by the diverging branches of a river's mouth and the seacoast, and traversed by other branches of the stream. This triangular tract is formed from the fine silt brought down in suspension by a muddy river and deposited when the river reaches the sea. When tidal currents are feeble, the delta frequently advances some distance seawards, forming a local prolongation of the coast.

**DELUC, JEAN ANDRÉ** (1727–1817), Swiss geologist and meteorologist, born at Geneva on the 8th of February 1727, was descended from a family which had emigrated from Lucca and settled at Geneva in the 15th century. His father, François Deluc, was the author of some publications in refutation of Mandeville and other rationalistic writers, which are best known through Rousseau's humorous account of his ennui in reading them; and he gave his son an excellent education, chiefly in mathematics and natural science. On completing it he engaged in commerce, which principally occupied the first forty-six years of his life, without any other interruption than that which was occasioned by some journeys of business into the neighbouring countries, and a few scientific excursions among the Alps. During these, however, he collected by degrees, in conjunction with his brother Guillaume Antoine, a splendid museum of mineralogy and of natural history in general, which was afterwards increased by his nephew J. André Deluc (1763–1847), who was also a writer on geology. He at the same time took a prominent part in politics. In 1768 he was sent to Paris on an embassy to the duc de Choiseul, whose friendship he succeeded in gaining. In 1770 he was nominated one of the Council of Two Hundred. Three years later unexpected reverses in business made it advisable for him to quit his native town, which he only revisited once for a few days. The change was welcome in so far as it set him entirely free for scientific pursuits, and it was with little regret that he removed to England in 1773. He was made a fellow of the Royal Society in the same year, and received the appointment of reader to Queen Charlotte, which he continued

to hold for forty-four years, and which afforded him both leisure and a competent income. In the latter part of his life he obtained leave to make several tours in Switzerland, France, Holland and Germany. In Germany he passed the six years from 1798 to 1804; and after his return he undertook a geological tour through England. When he was at Göttingen, in the beginning of his German tour, he received the compliment of being appointed honorary professor of philosophy and geology in that university; but he never entered upon the active duties of a professorship. He was also a correspondent of the Academy of Sciences at Paris, and a member of several other scientific associations. He died at Windsor on the 7th of November 1817.

His favourite studies were geology and meteorology. The situation of his native country had naturally led him to contemplate the peculiarities of the earth's structure, and the properties of the atmosphere, as particularly displayed in mountainous countries, and as subservient to the measurement of heights. According to Cuvier, he ranked among the first geologists of his age. His principal geological work, *Lettres physiques et morales sur les montagnes et sur l'histoire de la terre et de l'homme*, first published in 1778, and in a more complete form in 1779, was dedicated to Queen Charlotte. It dealt with the appearance of mountains and the antiquity of the human race, explained the six days of the Mosaic creation as so many epochs preceding the actual state of the globe, and attributed the deluge to the filling up of cavities supposed to have been left void in the interior of the earth. He published later an important series of volumes on geological travels in the north of Europe (1810), in England (1811), and in France, Switzerland and Germany (1813). These were translated into English.

Deluc's original experiments relating to meteorology were valuable to the natural philosopher; and he discovered many facts of considerable importance relating to heat and moisture. He noticed the disappearance of heat in the thawing of ice about the same time that J. Black founded on it his ingenious hypothesis of latent heat. He ascertained that water was more dense about 40° F. (4° C.) than at the temperature of freezing, expanding equally on each side of the maximum; and he was the originator of the theory, afterward readvanced by John Dalton, that the quantity of aqueous vapour contained in any space is independent of the presence or density of the air, or of any other elastic fluid.

His *Recherches sur les modifications de l'atmosphère* (2 vols. 4to, Geneva, 1772; 2nd ed., 4 vols. 8vo, Paris, 1784) contains many accurate and ingenious experiments upon moisture, evaporation and the indications of hygrometers and thermometers, applied to the barometer employed in determining heights. In the *Phil. Trans.*, 1773, appeared his account of a new hygrometer, which resembled a mercurial thermometer, with an ivory bulb, which expanded by moisture, and caused the mercury to descend. The first correct rules ever published for measuring heights by the barometer were those he gave in the *Phil. Trans.*, 1771, p. 158. His *Lettres sur l'histoire physique de la terre* (8vo, Paris, 1798), addressed to Professor Blumenbach, contains an essay on the existence of a General Principle of Morality. It also gives an interesting account of some conversations of the author with Voltaire and Rousseau. Deluc was an ardent admirer of Bacon, on whose writings he published two works—*Bacon tel qu'il est* (8vo, Berlin, 1800), showing the bad faith of the French translator, who had omitted many passages favourable to revealed religion, and *Précis de la philosophie de Bacon* (2 vols. 8vo, Paris, 1802), giving an interesting view of the progress of natural science. *Lettres sur le Christianisme* (Berlin and Hanover, 1801, 1803) was a controversial correspondence with Dr Teller of Berlin in regard to the Mosaic cosmogony. His *Traité élémentaire de géologie* (8vo, Paris, 1809, also in English, by de la Fite, the same year) was principally intended as a refutation of the Vulcanian system of Hutton and Playfair, who deduced the changes of the earth's structure from the operation of fire, and attributed a higher antiquity to the present state of the continents than is required in the Neptunian system adopted by Deluc after D. Dolomieu. He sent to the Royal Society, in

1809, a long paper on separating the chemical from the electrical effect of the pile, with a description of the electric column and aerial electroscope, in which he advanced opinions so little in unison with the latest discoveries of the day, that the council deemed it inexpedient to admit them into the *Transactions*. The paper was afterwards published in Nicholson's *Journal* (xxvi.), and the dry column described in it was constructed by various experimental philosophers. This dry pile or electric column has been regarded as his chief discovery.

Many other of his papers on subjects kindred to those already mentioned are to be found in the *Transactions* and in the *Philosophical Magazine*. See *Philosophical Magazine* (November 1817).

**DELUGE, THE** (through the Fr. from Lat. *diluvium*, flood, *diluere*, to wash away), a great flood or submersion of the earth (so far as the earth was known to the narrators), or of heaven and earth, or simply of heaven, by which, according to primitive and semi-primitive races, chaos was restored. It is, of course, not meant that all the current flood stories, as they stand, answer to this description. There are flood stories which, at first sight, may plausibly be held to be only exaggerated accounts of some ancient historical occurrences. The probability of such traditions being handed down is, however, extremely slight. If some flood stories are apparently local, and almost or quite without mythical colouring, it may be because the original myth-makers had a very narrow conception of the earth, and because in the lapse of time the original mythic elements had dwindled or even disappeared. The relics of the traditional story may then have been adapted by scribes and priests to a new theory. Many deluge stories may in this way have degenerated. It is at any rate undeniable that flood stories of the type described above, and even with similar minor details, are fairly common. A conspectus of illustrative flood stories from different parts of the world would throw great light on the problems before us; see the article COSMOGONY, especially for the North American tales, which show clearly enough that the deluge is properly a second creation, and that the serpent is as truly connected with the second chaos as with the first. One of them, too, gives a striking parallel to the Babylonian name Hasis-andra (the Very Wise), whence comes the corrupt form Xisuthrus; the deluge hero of the Hare Indians is called Kunyan, "the intelligent." Polynesia also gives us most welcome assistance, for its flood stories still present clear traces of the primitive imagination that the sky was a great blue sea, on which the sun, moon and stars (or constellations) were voyagers. Greece too supplies some stimulus to thought, nor are Iran and Egypt as unproductive as some have supposed. But the only pauses that we can allow ourselves are in Hindustan, Babylonia and Canaan. The peoples of these three countries, which are religiously so prominent in antiquity, have naturally connected their name equally with thoughts about earth production and earth destruction.

The Indian tradition exists in several forms.<sup>1</sup> The earliest is preserved in the Śatapatha Brahmana. It is there related that Manu, the first man, the son of the sun-god Vivasvat, found, in bathing, a small fish, which asked to be tended, and in reward promised to save him in the coming flood. The fish grew, and at last had to be carried to the sea, where it revealed to Manu the time of the flood, and bade him construct a ship for his deliverance. When the time came, Manu, unaccompanied, went on board; the grateful fish towed the ship through the water to the summit of the northern mountain, where it bade Manu bind the vessel to a tree. Gradually, as the waters fell, Manu descended the mountain; he then sacrificed and prayed. In a year's time his prayer was granted. A woman appeared, who called herself his daughter Idā (goddess of fertility). It is neither stated, nor even hinted, that sin was the cause of the flood.

Another version occurs in the great epic, the Mahābhārata. The lacunae of the earlier story are here supplied. Manu, for instance, embarks with the seven "rishis" or wise men, and takes with him all kinds of seed. The fish announces himself as the God Brahma, and enables Manu to create both gods and

<sup>1</sup> See Muir, *Sanskrit Texts*, i. 182, 206 ff.

men. A third account is given in the *Bhāgavata Purāna*. It contains the details of the announcement of the flood seven days beforehand (cf. Gen. vii. 4) and of the taking of pairs of all kinds of animals (cf. Gen. vi. 19), besides the seeds of plants (as the epic; cf. Gen. vi. 21). This story, however, is a late composition, not earlier than the 12th century A.D. A first glance at these stories is somewhat bewildering. We shall return, however, to this problem later with a good hope of mastering it.

The Israelite (Biblical) and the Babylonian deluge-stories remain to be considered. Neither need be described here in detail; for the former see Gen. vi. 5-ix. 17, and for the latter GILGAMESH. As most students are aware, the Biblical deluge-story is composite, being made up of two narratives, the few lacunae in which are due to the ancient redactor who worked them together.<sup>1</sup> The narrators are conventionally known as J. (= the Yahwist, from the divine name Yahweh) and P. (= the Priestly Writer) respectively. It is important to notice that P., though chronologically later than J., reproduces certain elements which must be archaic. For instance, while J. speaks only of a rain-storm, P. states that "all the fountains of the great ocean were broken up, and the windows of heaven opened" (Gen. vii. 11), *i.e.* the lower and the upper waters met together and produced the deluge. It is also P. who tells the story of the appointment of the rainbow (Gen. ix. 12-17), which is evidently ancient, though only paralleled in a Lithuanian flood-story, and near it we find the divine declaration (Gen. ix. 2-6) that the golden age of universal peace (cf. Gen. i. 29, 30), already sadly tarnished, is over.<sup>2</sup> Surely this too has a touch of the archaic; nor can we err in connecting it with the tradition of man's first home in Paradise, where no enemy could come, because, in the original form of the tradition, Paradise was the abode of God. (See PARADISE.)

The Babylonian tradition exists in two main forms,<sup>3</sup> nor can we affirm that the shorter form, due to Berössus, is superseded by the larger one in the Gilgamesh epic, for it communicates four important points: (1) Xisuthrus, the hero of the deluge, was also the tenth Babylonian king; cf. Noah, in P., the tenth patriarch as well as the survivor from the deluge; (2) the destination of Xisuthrus is said to be "to the gods," a statement which virtually records his divine character. In accordance with this, the final reward of the hero is declared to be "living with the gods." This suggests that Noah (?) may originally have been represented as a supernatural man, a demigod. True, Gen. ix. 20, 21 is not consistent with this, but it is very possible that Noah was substituted by a scribe's error for Enoch,<sup>4</sup> who, like Xisuthrus, "walked with God (learning the heavenly wisdom) and disappeared, for God had taken him" (Gen. v. 22, 24); (3) the birds, when sent out by Xisuthrus the second time, return with mud on their feet. This detail reminds us of points in some archaic North American myths which probably supply the key to its meaning;<sup>5</sup> (4) in the time of Berössus the mountain on which the ark grounded was considered to be in Armenia.

We pass on to the relation of J. and P. to the Babylonian story. (1) The polytheistic colouring of the latter contrasts strongly with the far simpler religious views of J. and P. Note the capricious character of the god Bel who sends the deluge, while at the end of the story the catastrophe is represented as a judgment upon human sins. It is the latter view which is adopted by J. and P. We cannot, however, infer from this that the narratives which doubtless underlie J. and P. were directly taken from some such

story as that in the Gilgamesh epic. The theory of an indirect and unconscious borrowing on the part of the Israelitish compilers will satisfy all the conditions of the case. (2) In the general scheme the three accounts very nearly agree, for J. must originally have contained directions as to the building of the vessel, and a notice that the ark grounded on a certain mountain. P.'s omission of the sacrifice at the close seems to be arbitrary. His theory of religious history forbade a reference to an altar so early, but his document must have contained it. J. expressly mentions it (Gen. viii. 20, 21), though not in such an original way as the cuneiform text. (3) As to the directions for building the ship (epic) or chest (J. and P.). Here the Babylonian story and P. have a strong general resemblance; note, *e.g.*, the mention of bitumen in both. Whether the Hebrew reference to a chest (*tēbah*) is, or is not, more archaic than the Babylonian reference to a ship (*elippu*) is a question which admits of different answers. (4) As to the material cause of the deluge. According to P. (see above) the water came both from above and from below; J. only speaks of continuous rain. The Gilgamesh epic, however, mentions besides thunder, lightning and rain, a hurricane which drove the sea upon the land. We can hardly regard this as more original than P.'s representation. (5) As to the extent of the flood. From the opening of the story in the epic we should naturally infer that only a single S. Babylonian city was affected. The sequel, however, implies that the flood extended all over Babylonia and the region of Nišir. More than this can hardly be claimed. Similarly the earlier story which underlies J. and P. need only have referred to the region of the myth-framers, *i.e.* either Canaan or N. Arabia. (6) As to the duration of the flood the traditions differ. P. reckons it at 365 days, *i.e.* a solar year, which is parallel to the 365 years of the life of Enoch (who, as we have seen, may have been the original hero of the flood). It is probable (see below) that P.'s ultimate authority, far back in the centuries, represented the deluge as a celestial occurrence. The origin of J.'s story is not quite so clear, owing to the lacunae in the narrative. If the text may be followed, this narrator made the flood last forty days and nights, after which two periods of seven days elapse, and then the patriarch leaves the ark. The epic shortens the duration of the flood to seven days, after which the ship remains another seven days (more strictly six full days) on the mountain of the land of Nišir (P., the mountains of Ararat; J., unrecorded). (7) As to the despatch of the birds. J. begins, the epic closes, with the raven. Clearly the epic is more original. Besides, one of the two missions of the dove is evidently superfluous. Dove, swallow, raven, as in the epic, must be more primitive than raven, dove, dove.

That the Hebrew deluge-story in both its forms has been at least indirectly influenced by the Babylonian is obvious. We cannot indeed reconstruct the form either of the Canaanitish (or N. Arabian) story, which was recast partly at least under the influence of a recast Babylonian myth, nor can we conjecture where the sanctuary was, the priests of which, yielding to a popular impulse, adopted and modified the fascinating story. But the fact of the ultimate Babylonian origin of the Israelitish narratives cannot seriously be questioned. The Canaanites or the N. Arabians handed on at least a portion of their myths to the Israelites, and the creation and deluge stories were among these. That the Israelitish priests gradually recast them is an easy and altogether satisfactory conjecture.

It remains to ask, What is the history and significance of the deluge-myth? The question carries us into far-off times. We have no version of the Babylonian myth which goes back to about 2100 B.C., while its text was apparently derived from a still older tablet. But even this is not primitive; behind it there must have been a much shorter and simpler myth. The recast represented by the existing versions of the myth must have been produced partly by the insertion, partly by the omission or modification, of mythic details, and by the application to the story thus produced of a particular mythic theory respecting the celestial world. The shorter myth referred to may—if we take hints from the very primitive myths of N. America—have run somewhat thus,

<sup>1</sup> Cf. Carpenter and Harford-Battersby, *The Hexateuch*, ii. 9, where the documents are printed separately in a tabular form.

<sup>2</sup> Isa. xi. 6-8 prophesies that one day this idyllic state shall be restored.

<sup>3</sup> For a discussion of the Babylonian version of the Deluge Legend, recently discovered among the tablets from Nippur, see NIPPUR.

<sup>4</sup> The genealogy in Gen. v. is hardly in its original form. Enoch is probably misplaced, and Noah inserted in error.

<sup>5</sup> Cf. COSMOGONY, and Cheyne's *Traditions and Beliefs of Ancient Israel* (on deluge-story).

*Israelite and Babylonian.*

*Berössus: four points.*

*Details on relation of Israelite story to Babylonian.*

*History and significance of deluge-myths.*

omitting minor details: "The earth (a small enough earth, doubtless) and its inhabitants proved so imperfect that the beneficent superhuman Being, who had created it, or perhaps another such Being, determined to remake it. He, therefore, summoned the serpent or dragon who controlled the cosmic ocean, and had been subjugated at creation, to overwhelm the earth, after which the creator remade it better,<sup>1</sup> and the survivor and his family became the ancestors of a new human race."

This, however, is only one possible representation. It may have been said that the serpent of his own accord, not having been killed by the creator, maliciously flooded the earth (cf. the Algonquin myth), but was again overcome in battle, or that the serpent, after filling the earth with violence and wrong, was at length slain by the Good Being, and that his blood, streaming out, produced a deluge.<sup>2</sup> In any case it is unnatural to hold that the first flood (that which preceded creation) had a dragon, but not the second. An old cuneiform text, recopied late, however, appears to call the year of the deluge (*i.e.* of what we here call the second flood) "the year of the raging (or red-shining) serpent,"<sup>3</sup> and certainly the N. American myths distinctly connect serpents with the deluges.

Among the probable minor details (omitted above) of the presumed shorter and older myth we may include: (1) the warning of "Very-Wise,"<sup>4</sup> either by friendly animals or by a dream; (2) the construction of a chest to contain "Very-Wise," his wife and his sons, together with animals;<sup>5</sup> (3) the despatch of three birds with a special object (see below); (4) the landing of the survivors on a mountain. As to (1), Berōssus suggests that the notice came to Xisuthrus in a dream; in the Indian myth it is the sacred fish which warns Manu. In the archaic N. American myths, however, it is some animal which gives the notice—an eagle or a coyote (a kind of wolf). As to (2), nothing is more common than the story of a divine child cast into the sea in a box.<sup>6</sup> The ship-motive is also found,<sup>7</sup> but it is not too rash to assume that the box-motive is the earlier, and, in accordance with the parallels, that the hero of the deluge was originally a god or a demigod. The translation of the hero to be with the gods is a transparent modification of the original tradition. As to (3), the original object of sending out the birds was probably not to find out where dry land was, but to use them as helpers in the work of re-creation. Take the story of the Tlatlasik Indians, where the diving-bird (one of three sent out) comes back with a branch of a fir-tree, out of which O'meatl made mountains, earth and heaven;<sup>8</sup> so, too, the Caingangs relate<sup>9</sup> that those who escaped from the flood, as they tarried on a mountain, heard the song of the *saracura* birds, who came carrying earth in baskets, and threw it into the waters, which slowly subsided. As to (4), the mountain would naturally be thought of as a place of refuge even in the old, simple flood-story. But when Babylonian mythology effected an entrance, the mountain would receive a new and much grander significance. It would then come to represent the summit of that great and most holy mountain, which, save by the special favour of the gods, no human eye has seen.

That a didactic element entered the deluge-tradition but slowly, may be surmised, not only from the genuinely old N. American stories, but from the inconsistent statements, to which Jastrow has already referred, in the Babylonian story. We may imagine that between the creation and the deluge some great and wise Being had initiated the early men, not only in the necessary arts of life, but in the "ways" that were pleasing to the heavenly powers. The Babylonians apparently think of neglected sacrifices, the Australians of a desecrated mystery as the cause of the flood. Some such violation of a sacred rule is the origin that naturally occurs to an adapter or expander of primitive myths.

<sup>1</sup> Cf. the myths of the Pawnees and the Quichés of Guatemala.

<sup>2</sup> See the cuneiform text described in *KAT*<sup>3</sup>, pp. 498-499.

<sup>3</sup> Zimmern, *KAT*<sup>3</sup>, p. 554.

<sup>4</sup> *i.e.* Atrahasis (Xisuthrus).

<sup>5</sup> To have omitted the animals would have been an offence against primitive views of kinship.

<sup>6</sup> Usener, *Die Sintflutsagen*, pp. 80-108, 115-127.

<sup>7</sup> *Ib.* p. 254.

<sup>8</sup> Stucken, *Astralmythen*, pp. 233-234.

<sup>9</sup> *Amer. Journ. of Folklore*, xviii. 223 ff.

And now as to the application of the celestial mythic theory to the early deluge-story. In the agricultural stage it was natural that men should take a deeper interest than before in the appearance of the sky, and especially of the sun and moon, and of the constellations, even though an astrological science or quasi-science would very slowly, if at all, grow up. That the Polynesian myths (which show no vestige of science) originally referred to the supposed celestial ocean, seems to be plain. Schirren<sup>10</sup> regarded the New Zealand cosmogonies as myths of sunrise, and the deluge-stories as myths of sunset. We may at any rate plausibly hold, with the article "Deluge" (by Cheyne) in the ninth edition of this work<sup>11</sup> (1877), that the deluge-stories of Polynesia and early Babylonia (we may now probably add India) were accommodated to an imaginative conception of the sun and moon as voyagers on the celestial ocean. "When this story had been told and retold a long time, rationalism suggested that the sea was not in heaven but on earth, and observation of the damage wrought in winter by excessive rains and the inundations of great rivers suggested the introduction of corresponding details into the new earthly deluge-myth." "This accounts for the strongly mythological character of Par-napishti (Ut-napishti) in Babylonia and Maui in New Zealand, who are in fact solar personages. Enoch, too, must be classed in this category, his perfect righteousness and superhuman wisdom now first become intelligible. Moreover, we now comprehend how the goddess Sabitu (the guardian of the entrance to the sea) can say to Gilgamesh (himself a solar personage), 'Shamash the mighty (*i.e.* the sun-god) has crossed the sea; besides (?) Shamash, who can cross it?' For though the sea in the epic is no doubt the earth-circling ocean, it was hardly this in the myth from which the words were taken."<sup>12</sup> And, what is still more important, we can understand better how, in the Gilgamesh epic (lines 115-116), the gods, after cowering like dogs, go up to the "heaven of Ana." They, too, fear the deluge, and only in the highest heaven can they feel themselves secure.

Such an explanation seems indispensable if the wide influence of the Babylonian form of the deluge-myth is to be accounted for. As Gunkel well remarks,<sup>13</sup> neither the tenacity and self-propagating character of this myth, nor the solemn utterance of Yahweh (who corresponds to the Babylonian Marduk) in Gen. viii. 21b (J.) and ix. 8-17 (P.) can be understood, if the deluge-story is nothing more than an exaggerated account of a historical, earthly occurrence. We, therefore, venture to hold that it is an insufficient account to give of the story in the Gilgamesh epic that it is a combination of a local tradition of the destruction of a single city with a myth of the destruction of mankind—a myth exaggerated in its present form, but based on accurate knowledge of the yearly recurring phenomenon of the overflow of the Euphrates.<sup>14</sup> There are no doubt points in the story as it now stands which indicate a composite origin, but it is probable that even the tradition which apparently limits the destruction to a single city, equally with many other local flood-stories, has a basis in what we may fairly call a celestial myth.

We can now return with some confidence to the Indian deluge-story. It is unlikely that so richly gifted a race as the Aryans of India should not have produced their own flood-story out of the same primeval germs which grew up into the earliest Babylonian flood-story,<sup>15</sup> and almost inconceivable that in its second form the Indian story should not have become adapted to what may be called the celestial mythic

**Celestial  
myth  
theory.**

**Indian  
myth  
recon-  
sidered.**

<sup>10</sup> Schirren, *Wandersagen der Neuseeländer* (1856), p. 193.

<sup>11</sup> Referring for Polynesia to Gerland in Waitz-Gerland, *Anthropologie der Naturvölker*, vi. 270-273 (1872). After a long interval, this theory has been taken up by Zimmern, *KAT*<sup>3</sup>, p. 355, and by Jensen, *Das Gilgamesch-Epos* (1906), p. 120; Winckler (*AOF*, 3rd series, i. 96) also speaks of the deluge as a "celestial occurrence." For other forms of this view see Jeremias, *ATAO*, pp. 134-136; Usener, p. 239.

<sup>12</sup> Cheyne, *Ency. Bib.* cols. 1063-1064.

<sup>13</sup> *Genesis*, p. 67.

<sup>14</sup> Jastrow, *Religion of Babylonia and Assyria* (1898), pp. 502, 506.

<sup>15</sup> The view here adopted is that of Lindner and Usener. On the opposite side are Zimmern, Tiele, Jensen, Oldenberg, Nöldeke, Stucken, Lenormant.



theory. The phrase "the northern mountain" for the place where the ship grounded may quite well be the name of an earthly substitute (the epic has "the highest summit of the Himalaya") for the mythic mountain of heaven. Nor is it unimportant that Manu is the son of the sun-god, and that the phrase "the seven rishis" in classical Sanskrit is a designation of the seven stars of the Great Bear. For such problems all that we can hope for is a probable solution. The opposite view<sup>1</sup> that the deluge is a historical occurrence implies a self-propagating power in early tradition which is not justified by critical research, and leaves out of sight many important facts revealed by comparative study.

For a conspectus of deluge-stories see Andree, *Die Flusagen, ethnographisch betrachtet* (1891), by a competent anthropologist; E. Suess, *Face of the Earth*, i. 17 (1904); also Elwood Worcester, *Genesis in the Light of Modern Knowledge* (New York, 1901), Appendix ii., in tabular form, from Schwarz's *Sinifluth und Völkerwanderungen*. Dr Worcester's work is popular, but based on well-chosen authorities. The article "Flood" in Hastings' *D. B.* is comprehensive; it represents the difficult view that flood-stories, &c., are generally highly-coloured traditions of genuine facts. (T. K. C.)

**DELYANNI, THEODOROS** (1826–1905), Greek statesman, was born at Kalavryta, Peloponnesus, in 1826. He studied law at Athens, and in 1843 entered the ministry of the interior, of which department he became permanent secretary in 1859. In 1862, on the deposition of King Otho, he became minister for foreign affairs in the provisional government. In 1867 he was minister at Paris. On his return to Athens he became a member of successive cabinets in various capacities, and rapidly collected a party around him consisting of those who opposed his great rival, Tricoupi. In the so-called "Oecumenical Ministry" of 1877 he voted for war with Turkey, and on its fall he entered the cabinet of Koumoundoros as minister for foreign affairs. He was a representative of Greece at the Berlin Congress in 1878. From this time forward, and particularly after 1882, when Tricoupi again came into power at the head of a strong party, the duel between these two statesmen was the leading feature of Greek politics. (See GREECE: *History*.) Delyanni first formed a cabinet in 1885; but his warlike policy, the aim of which was, by threatening Turkey, to force the powers to make concessions in order to avoid the risk of a European war, ended in failure. For the powers, in order to stop his excessive armaments, eventually blockaded the Peiraeus and other ports, and this brought about his downfall. He returned to power in 1890, with a radical programme, but his failure to deal with the financial crisis produced a conflict between him and the king, and his disrespectful attitude resulted in his summary dismissal in 1892. Delyanni, by his demagogic behaviour, evidently expected the public to side with him; but at the elections he was badly beaten. In 1895, however, he again became prime minister, and was at the head of affairs during the Cretan crisis and the opening of the war with Turkey in 1897. The humiliating defeat which ensued—though Delyanni himself had been led into the disastrous war policy to some extent against his will—caused his fall in April 1897, the king again dismissing him from office when he declined to resign. Delyanni kept his own seat at the election of 1899, but his following dwindled to small dimensions. He quickly recovered his influence, however, and he was again president of the council and minister of the interior when, on the 13th of June 1905, he was murdered in revenge for the rigorous measures taken by him against gambling houses.

The main fault of Delyanni as a statesman was that he was unable to grasp the truth that the prosperity of a state depends on its adapting its ambitions to its means. Yet, in his vast projects, which the powers were never likely to endorse, and without their endorsement were vain, he represented the real wishes and aspirations of his countrymen, and his death was the occasion for an extraordinary demonstration of popular grief. He died in extreme poverty, and a pension was voted to the two nieces who lived with him.

**DEMADES** (c. 380–318 B.C.), Athenian orator and demagogue. He was originally of humble position, and was employed at one time as a common sailor, but he rose partly by his eloquence and

partly by his unscrupulous character to a prominent position at Athens. He espoused the cause of Philip in the war against Olynthus, and was thus brought into bitter and life-long enmity with Demosthenes, whom he at first supported. He fought against the Macedonians in the battle of Chaeroneia, and was taken prisoner. Having made a favourable impression upon Philip, he was released together with his fellow-captives, and was instrumental in bringing about a treaty of peace between Macedonia and Athens. He continued to be a favourite of Alexander, and, prompted by a bribe, saved Demosthenes and the other obnoxious Athenian orators from his vengeance. It was also chiefly owing to him that Alexander, after the destruction of Thebes, treated Athens so leniently. His conduct in supporting the Macedonian cause, yet receiving any bribes that were offered by the opposite party, caused him to be heavily fined more than once; and he was finally deprived of his civil rights. He was reinstated (322) on the approach of Antipater, to whom he was sent as ambassador. Before setting out he persuaded the citizens to pass sentence of death upon Demosthenes and his followers, who had fled from Athens. The result of his embassy was the conclusion of a peace greatly to the disadvantage of the Athenians. In 318 (or earlier), having been detected in an intrigue with Perdiccas, Antipater's opponent, he was put to death by Antipater at Pella, when entrusted with another mission by the Athenians. Demades was avaricious and unscrupulous; but he was a highly gifted and practised orator.

A fragment of a speech (*Περὶ δωδεκαετίας*), bearing his name, in which he defends his conduct, is to be found in C. Müller's *Oratores Attici*, ii. 438, but its genuineness is exceedingly doubtful.

**DEMAGOGUE** (Gr. *δημαγωγός*, from *ἄγω*, to lead, and *δῆμος*, the people), a leader of the popular as opposed to any other party. Being particularly used with an invidious sense of a mob leader or orator, one who for his own political ends panders to the passions and prejudices of the people, the word has come to mean an unprincipled agitator.

**DEMANTOID**, the name given by Nils Gustaf Nordenskiöld to a green garnet, found in the Urals and used as a gem stone. As it possesses high refractive and dispersive power, it presents when properly cut great brilliancy and "fire," and the name has reference to its diamond-like appearance. It is sometimes known as "Uralian emerald," a rather unfortunate name inasmuch as true emerald is found in the Urals, whilst it not infrequently passes in trade as olivine. Demantoid is regarded as a lime-iron garnet, coloured probably by a small proportion of chromium. The colour varies in different specimens from a vivid green to a dull yellowish-green, or even to a brown. The specific gravity of an emerald-green demantoid was found to be 3.849, and that of a greenish-yellow specimen 3.854 (A. H. Church). The hardness is only 6.5, or lower even than that of quartz—a character rather adverse to the use of demantoid as a gem. This mineral was originally discovered as pebbles in the gold-washings at Nizhne Tagilsk in the Ural Mountains, and was afterwards found in the stream called Bohrovka, in the Sysertsksk district on the western slope of the Urals. It occurs not only as pebbles but in the form of granular nodules in a serpentine rock, and occasionally, though very rarely, shows traces of crystal faces. (F. W. R.\*)

**DEMARATUS** (Doric *Δαμάρατος*, Ionic *Δημάρατος*), king of Sparta of the Eurypontid line, successor of his father Ariston. He is known chiefly for his opposition to his colleague Cleomenes I. (q.v.) in his attempts to make Isagoras tyrant in Athens and afterwards to punish Aegina for medizing. He did his utmost to bring Cleomenes into disfavour at home. Thereupon Cleomenes urged Leotychides, a relative and personal enemy of Demaratus, to claim the throne on the ground that the latter was not really the son of Ariston but of Agetus, his mother's first husband. The Delphic oracle, under the influence of Cleomenes' bribes, pronounced in favour of Leotychides, who became king (491 B.C.). Soon afterwards Demaratus fled to Darius, who gave him the cities of Pergamum, Teuthrania and Halisarna, where his descendants were still ruling at the beginning of the 4th century (Xen. *Anabasis*, ii. 1. 3, vii. 8. 17; *Hellenica*, iii. 1. 6); to these

<sup>1</sup> Held by Franz Delitzsch, Dillmann and Lenormant.

Gambreum should perhaps be added (Athenaeus i. 29 f). He accompanied Xerxes on his expedition to Greece, but the stories told of the warning and advice which on several occasions he addressed to the king are scarcely historical.

See Herodotus v. 75, vi. 50-70, vii.; later writers either reproduce or embellish his narrative (Pausanias iii. 4, 3-5, 7, 7-8; Diodorus xi. 6; Polyaeus ii. 20; Seneca, *De beneficiis*, vi. 31, 4-12). The story that he took part in the attack on Argos which was repulsed by Telesilla, the poetess, and the Argive women, can hardly be true (Plutarch, *Mul. virt.* 4; Polyaeus, *Strat.* viii. 33; G. Busolt, *Griechische Geschichte*, ii.<sup>2</sup> 563, note 4). (M. N. T.)

**DEMERARA**, one of the three settlements of British Guiana, taking its name from the river Demerara. See GUIANA.

**DEMESNE** (DEMEINE, DEMAIN, DOMAIN, &c.),<sup>1</sup> that portion of the lands of a manor not granted out in freehold tenancy, but (a) retained by the lord of the manor for his own use and occupation or (b) let out as tenemental land to his retainers or "villani." This demesne land, originally held at the will of the lord, in course of time came to acquire fixity of tenure, and developed into the modern copyhold (see MANOR). It is from demesne as used in sense (a) that the modern restricted use of the word comes, i.e. land immediately surrounding the mansion or dwelling-house, the park or chase. *Demesne of the crown*, or royal demesne, was that part of the crown lands not granted out to feudal tenants, but which remained under the management of stewards appointed by the crown. These crown lands, since the accession of George III., have been appropriated by parliament, the sovereign receiving in return a fixed annual sum (see CIVIL LIST). *Ancient demesne* signified lands or manors vested in the king at the time of the Norman Conquest. There were special privileges surrounding tenancies of these lands, such as freedom from tolls and duties, exemption from danegeld and amercement, from sitting on juries, &c. Hence, the phrase "ancient demesne" came to be applied to the tenure by which the lands were held. Land held in ancient demesne is sometimes also called customary freehold. (See COPYHOLD.)

**DEMETER**, in Greek mythology, daughter of Cronus and Rhea and sister of Zeus, goddess of agriculture and civilized life. Her name has been explained as (1) "grain-mother," from *δηαί*, the Cretan form of *ζεαί*, "barley," or (2) "earth-mother," or rather "mother earth," *δα* being regarded as the Doric form of *λη*. She is rarely mentioned in Homer, nor is she included amongst the Olympian gods.

The central fact of her cult was the story of her daughter Persephone (Proserpine), a favourite subject in classical poetry. According to the Homeric *Hymn to Demeter*, Persephone, while gathering flowers on the Nysian plain (probably here a purely mythical locality), was carried off by Hades (Pluto), the god of the lower world, with the connivance of Zeus (see also PROSERPINE). The incident has been assigned to various other localities—Crete, Eleusis, and Enna in Sicily, the last being most generally adopted. This rape is supposed to point to an original *ιερός λάμος*, an annual holy marriage of a god and goddess of vegetation. Wandering over the earth in search of her daughter, Demeter learns from Helios the truth about her disappearance. In the form of an old woman named Deo (=the "seeker," or simply a diminutive form), she comes to the house of Celeus at Eleusis, where she is hospitably received. Having revealed herself to the Eleusians, she departs, in her wrath having visited the earth with a great dearth. At last Zeus appeases her by allowing her daughter to spend two-thirds of the year with her in the upper world. Demeter then returns to Olympus, but before her final departure from earth, in token of her gratitude, she instructs the rulers of Eleusis in the art of agriculture and in the solemnities and rites whereby she desires in future to be honoured.

<sup>1</sup> The form "demesne" is an Anglo-French spelling of the Old Fr. *demeine* or *demaine*, belonging to a lord, from Med. Lat. *dominicus*, *dominus*, lord; *dominicum* in Med. Lat. meant *proprietas* (see Du Cange). From the later Fr. *domaine*, which approaches more nearly the original Lat., comes the other Eng. form "domain," which is chiefly used in a non-legal sense of any tract of country or district under the rule of any specific sovereign state, &c. "Domain" is, however, the form kept in the legal phrase "Eminent Domain" (q.v.).

Those who were initiated into the mysteries of Eleusis found a deep meaning in the myth, which was held to teach the principle of a future life, founded on the return of Persephone to the upper world, or rather on the process of nature by which seed sown in the ground must first die and rot before it can yield new life (see MYSTERY). At Eleusis, Demeter was venerated as the introducer of all the blessings which agriculture brings in its train—fixed dwelling-places, civil order, marriage and a peaceful life; hence her name *Thesmophoros*, "the bringer of law and order," and the festival *Thesmophoria* (q.v.). J. G. Frazer takes the epithet to mean "bearer of the sacred objects deposited on the altar"; L. R. Farnell (*Cults of the Greek States*, iii. 106) suggests "the bringer of treasure or riches," as appropriate to the goddess of corn and of the lower world; others refer the name to "the law of wedlock" (*θεσμός λέκτροιο*, *Odyssey*, xxiii. 296, where, however, D. B. Monro translates "place, situation"). At Eleusis also, Triptolemus (q.v.), the son of Celeus, who was said to have invented the plough and to have been sent by Demeter round the world to diffuse the knowledge of agriculture, had a temple and threshing-floor.

In the agrarian legends of Iasion and Erysichthon, Demeter also plays an important part. Iasion (or Iasius), a beautiful youth, inspired her with love for him in a thrice-ploughed field in Crete, the fruit of their union being Plutus (wealth). According to Homer (*Odyssey*, v. 128) he was slain by Zeus with a thunderbolt. The story is compared by Frazer (*Golden Bough*, 2nd ed., ii. 217) with the west Prussian custom of the mock birth of a child on the harvest-field, the object being to ensure a plentiful crop for the coming year. It seems to point to the supersession of a primitive local Cretan divinity by Demeter, and the adoption of agriculture by the inhabitants, bringing wealth in its train in the form of the fruits of the earth, both vegetable and mineral. Some scholars, identifying Iasion with Jason (q.v.), regard Thessaly as the original home of the legend, and the union with Demeter as the *ιερός γάμος* of mother earth with a health god. Erysichthon ("tearer up of the earth"), son of Triopas or Myrmidon, having cut down the trees in a grove sacred to the goddess, was punished by her with terrible hunger (Callimachus, *Hymn to Demeter*; Ovid, *Metam.* viii. 738-878). Perhaps Erysichthon may be explained as the personification of the labourer, who by the systematic cultivation and tilling of the soil endeavours to force the crops, instead of allowing them to mature unmolested as in the good old times. Tearing up the soil with the plough is regarded as an invasion of the domain of the earth-mother, punished by the all-devouring hunger for wealth, that increases with increasing produce. According to another view, Erysichthon is the destroyer of trees, who wastes away as the plant itself loses its vigour. It is possible that the story may originally have been connected with tree-worship. Here again, as in the case of Iasion, a conflict between an older and a younger cult seems to be alluded to (for the numerous interpretations see O. Crusius s.v. in Roscher's *Lexikon*).

It is as a corn-goddess that Demeter appears in Homer and Hesiod, and numerous epithets from various sources (see Bruchmann, *Epitheta Deorum*, supplement to Roscher's *Lexikon*, i. 2) attest her character as such. The name *Ἰουλώ* (? at Delos), from *ἴωλος*, "corn-sheaf," has been regarded as identifying the goddess with the sheaf, and as proving that the cult of Demeter originated in the worship of the corn-mother or corn-spirit, the last sheaf having a more or less divine character for the primitive husbandman. According to this view, the prototypes of Demeter and Persephone are the corn-mother and harvest maiden of northern Europe, the corn-fetishes of the field (Frazer, *Golden Bough*, 2nd ed., ii. 217, 222; but see Farnell, *Cults*, iii. 35). The influence of Demeter, however, was not limited to corn, but extended to vegetation generally and all the fruits of the earth, with the curious exception of the bean, the use of which was forbidden at Eleusis, and for the protection of which a special patron was invented. In this wider sense Demeter is akin to Ge, with whom she has several epithets in common, and is sometimes identified with Rhea-Cybele; thus Pindar speaks of Demeter *χαλακρότος* ("brass-rattling"), an epithet obviously more

suitable to the Asiatic than to the Greek earth-goddess. Although the goddess of agriculture is naturally inclined to peace and averse from war, the memory of the time when her land was won and kept by the sword still lingers in the epithets *χρυσότοπος* and *ξίφηφόρος* and in the name Triptolemus, which probably means " thrice fighter " rather than " thrice plougher."

Another important aspect of Demeter was that of a divinity of the under-world; as such she is *χθονία* at Sparta and especially at Hermione in Argolis, where she had a celebrated temple, said to have been founded by Clymenus (one of the names of Hades-Pluto) and his sister Chthonia, the children of Phoroneus, an Argive hero. Here there was said to be a descent into the lower world, and local tradition made it the scene of the rape of Persephone. At the festival Chthonia, a cow (representing, according to Mannhardt, the spirit of vegetation), which voluntarily presented itself, was sacrificed by three old women. Those joining in the procession wore garlands of hyacinth, which seems to attribute a chthonian character to the ceremony, although it may also have been connected with agriculture (see S. Wide, *De Sacris Troezeniorum, Hermionensium, Epidauriorum*, Upsala, 1888). The striking use of the term *δημήτριοι* in the sense of " the dead " may be noted in this connexion.

The remarkable epithets, *Ἐρινός* and *Μέλαινα*, as applied to Demeter, were both localized in Arcadia, the first at Thelpusa (or rather Onkeion close by), the second at Phigalia (see W. Immerwahr, *Die Kulte und Mythen Arkadiens*, i. 1891). According to the Thelpusan story, Demeter, during her wanderings in search of Persephone, changed herself into a mare to avoid the persecution of Poseidon. The god, however, assumed the form of a stallion, and the fruit of the union was a daughter of mystic name and the horse Areion (or Erion). Demeter, at first enraged, afterwards calmed down, and washed herself in the river Ladon by way of purification. Demeter " the angry " (*ἔρινός*) became Demeter " the bather " (*λουσία*). An almost identical story was current in the neighbourhood of Tilphossa, a Boeotian spring. In the Phigalian legend, no mention is made of the horse Areion, but only of the daughter, who is called Despoina (mistress), a title common to all divinities connected with the under-world. Demeter, clad in black (hence *μέλαινα*) in token of mourning for her daughter and wrath with Poseidon, retired into a cave. During that time the earth bore no fruit, and the inhabitants of the world were threatened with starvation. At last Pan, the old god of Arcadia, discovered her hiding-place, and informed Zeus, who sent the Moirae (Fates) to fetch her out. The cave, still called *Mavrosπέλυα* ("black cave"), was ever afterwards regarded as sacred to Demeter, and in it, according to information given to Pausanias, there had been set up an image of the goddess, a female form seated on a rock, but with a horse's head and mane, to which were attached snakes and other wild animals. It was clothed in a black garment reaching to the feet, and held in one hand a dolphin, in the other a dove. The image was destroyed by fire, replaced by the sculptor Onatas from inspiration in a dream, but disappeared again before the time of Pausanias.

Both *μέλαινα* and *ἔρινός*, according to Farnell, are epithets of Demeter as an earth-goddess of the under-world. The first has been explained as referring to the gloom of her abode, or the blackness of the withered corn. The second, according to Max Müller and A. Kuhn, is the etymological equivalent of the Sanskrit *Saranyu*, who, having turned herself into a mare, is pursued by Vivasvat, and becomes the mother of the two Asvins, the Indian Dioscuri, the Indian and Greek myths being regarded as identical. According to Farnell, the meaning of the epithet is to be looked for in the original conception of Erinyes, which was that of an earth-goddess akin to Ge, thus naturally associated with Demeter, rather than that of a wrathful avenging deity.

Various interpretations have been given of the horse-headed form of the Black Demeter: (1) that the horse was one of the forms of the corn-spirit in ancient Greece; (2) that it was an animal " devoted " to the chthonian goddess; (3) that it is totemistic; (4) that the form was adopted from Poseidon Hippios, who is frequently associated with the earth-goddess and is said to have received the name Hippios first at Thelpusa, in

order that Demeter might figure as the moth.

discussion of the whole subject see Farnell, *Cults*, .

The union of Poseidon and Demeter is thus explained .

hardt. As the waves of the sea are fancifully compared to .

so a field of corn, waving in the breeze, may be said to represe.

the wedding of the sea-god and the corn-goddess. In any case

the association of Poseidon, representing the fertilizing element

of moisture, with Demeter, who causes the plants and seeds to

grow, is quite natural, and seems to have been widespread.

Demeter also appears as a goddess of health, of birth and of

marriage; and a certain number of political and ethnic titles

is assigned to her. Of the latter the most noteworthy are:

*Παναχαια* at Aegium in Achaea, pointing to some connexion with

the Achaean league; *Ἀχαια*,<sup>1</sup> " the Achaean goddess," unless it

refers to the " sorrow " of the goddess for the loss of her daughter

(cf. *Ἀχέα* in Boeotia); and, most important of all, *Ἀμφικτυονίς*,

at Anthela near Thermopylae, as patron-goddess of the Amphic-

tyonic league, subsequently so well known in connexion with the

temple at Delphi.

The Eleusinia and Thesmophoria are discussed elsewhere, but

brief mention may here be made of certain agrarian festivals held

in honour of Demeter.

1. *Haloa*, obviously connected with *ἄλωσ* (" threshing-floor "),

begun at Athens and finished at Eleusis, where there was a

threshing-floor of Triptolemus, in the month Poseideon

(December). This date, which is confirmed by historical and

epigraphical evidence, seems inappropriate, and it is suggested

(A. Mommsen, *Feste der Stadt Athen*, p. 365 foll.) that the festival,

originally held in autumn, was subsequently placed later, so as

to synchronize with the winter Dionysia. Dionysus, as the god

of vines, and (in a special procession) Poseidon *φυντάλμιος* (" god

of vegetation ") were associated with Demeter. In addition to

being a harvest festival, marked by the ordinary popular rejoic-

ings, the Haloa had a religious character. The *ἀπαρχαί* (" first

fruits ") were conveyed to Eleusis, where sacrifice was offered

by a priestess, men being prohibited from undertaking the duty.

A *τελετή* (" initiatory ceremony ") of women by a woman also

took place at Eleusis, characterized by obscene jests and the

use of phallic emblems. The sacramental meal on this occasion

consisted of the produce of land and sea, certain things (pome-

granates, honey, eggs) being forbidden for mystical reasons.

Although the offerings at the festival were bloodless, the ceremony

of the presentation of the *ἀπαρχαί* was probably accompanied

by animal sacrifice (Farnell, Foucart); Mommsen, however,

considers the offerings to have been pastry imitations. Certain

games (*πάτριος ἀγών*), of which nothing is known, terminated the

proceedings. In Roman imperial times the ephēbi had to deliver

a speech at the Haloa.

2. *Chloeia* or *Chloia*, the festival of the corn beginning to

sprout, held at Eleusis in the early spring (Anthesterion) in

honour of Demeter Chloë, " the green," the goddess of growing

vegetation. This is to be distinguished from the later sacrifice

of a ram to the same goddess on the 6th of the month Thargelion,

probably intended as an act of propitiation. It has been identified

with the *Procharisteria* (sometimes called *Proschairateria*),

another spring festival, but this is doubtful. The scholiast on

Pindar (*Ol.* ix. 150) mentions an Athenian harvest festival

*Eucharisteria*.

3. *Proërosia*, at which prayers were offered for an abundant

harvest, before the land was ploughed for sowing. It was also

called *Proarcturia*, an indication that it was held before the rising

of Arcturus. According to the traditional account, when Greece

was threatened with famine, the Delphic oracle ordered first-

fruits to be brought to Athens from all parts of the country,

which were to be offered by the Athenians to the goddess Deo on

behalf of all the contributors. The most important part of the

festival was the three sacred ploughings—the Athenian *ὑπὸ*

*πόλων*, the Eleusinian on the Rharian plain, the Scirian (a

compromise between Athens and Eleusis). The festival itself

<sup>1</sup> O. Gruppe (*Griechische Mythologie*, ii. 1177, note 1) considers it

" certain " that *Ἀχαια* = *Ἀχελωια*, although he is unable to explain

the form.

took place, probably some time in September, at Eleusis. In later times the ephēbi also took part in the Proērōsia.

4. *Thalysia*, a thanksgiving festival, held in autumn after the harvest in the island of Cos (see Theocritus vii.).

5. The name of Demeter is also associated with the *Scirophoria* (see ATHENA). It is considered probable that the festival was originally held in honour of Athena, but that the growing importance of the Eleusinia caused it to be attached to Demeter and Kore.

The attributes of Demeter are chiefly connected with her character as goddess of agriculture and vegetation—ears of corn, the poppy, the mystic basket (*calathus*) filled with flowers, corn and fruit of all kinds, the pomegranate being especially common. Of animals, the cow and the pig are her favourites, the latter owing to its productivity and the cathartic properties of its blood. The crane is associated with her as an indicator of the weather. As a chthonian divinity she is accompanied by a snake; the myrtle, asphodel and narcissus (which Persephone was gathering when carried off by Hades) also are sacred to her.

In Greek art, Demeter is made to resemble Hera, only more matronly and of milder expression; her form is broader and fuller. She is sometimes riding in a chariot drawn by horses or dragons, sometimes walking, sometimes seated upon a throne, alone or with her daughter. The Demeter of Cnidus in the British Museum, of the school of Praxiteles, apparently shows her mourning for the loss of her daughter. The article GREEK ART, fig. 67 (pl. iv.), gives a probable representation of Demeter (or her priestess) from the stone of a vault in a Crimean grave.

The Romans identified Demeter with their own Ceres (*q.v.*).

See L. Preller, *Demeter und Persephone* (1837); P. R. Förster, *Der Raub und die Rückkehr der Persephone* (1874), in which considerable space is devoted to the representations of the myth in art; W. Mannhardt, *Mythologische Forschungen* (1884); J. E. Harrison, *Prolegomena to the Study of Greek Religion* (1903); L. Dyer, *The Gods in Greece* (1891); J. G. Frazer, *The Golden Bough* (2nd ed.), ii. 168-222; L. Preller, *Griechische Mythologie* (4th ed., by C. Robert); O. Kern in Pauly-Wissowa's *Realencyclopädie*, iv. pt. 2 (1901); L. Bloch in Roscher's *Lexikon der Mythologie*; O. Gruppe, *Griechische Mythologie und Religionsgeschichte*, ii. (1907); L. R. Farnell, *Cults of the Greek States*, iii. (1907); article "Ceres" by F. Lenormant in Daremberg and Saglio's *Dictionnaire des antiquités*. (J. H. F.)

**DEMETRIA**, a Greek festival in honour of Demeter, held at seed-time, and lasting ten days. Nothing is known of it beyond the fact that the men who took part in it lashed one another with whips of bark (*μόροτρον*), while the women made obscene jests. It is even doubtful whether it was a particular festival at all or only another name for the Eleusinia or Thesmophoria. The Dionysia also were called Demetria in honour of Demetrius Poliorcetes, upon whom divine honours were conferred by the Athenians.

Hesychius, *s.v.* *μόροτρον*; Pollux i. 37; Diod. Sic. v. 4; Plutarch, *Demetrius*, 12; Daremberg and Saglio, *Dictionnaire des antiquités*.

**DEMETRIUS**, king of Bactria, was the son of the Graeco-Bactrian king Euthydemus, for whom he negotiated a peace with Antiochus the Great in 206 (Polyb. xi. 34). Soon afterwards he crossed the Hindu Kush and began the invasion of India (Strabo xi. 516); he conquered the Punjab and the valley of the Indus down to the sea and to Gujerat. The town Sangala, a town of the Kathaeans in the Punjab (Arrian v. 22, 2 ff.), he named after his father Euthydemia (Ptol. vii. 1, 46). That his power extended into Arachosia (Afghanistan) is proved by the name of a town Demetrias near Kandahar (Isidor. Charac. 19, cf. Strabo xi. 516). On his coins he wears an elephant's skin with trunk and teeth on his head; on bronze coins, which have also an Indian legend in Kharoshti letters (see BACTRIA), he calls himself the unvanquished king (*Βασιδέως ἀνικητου Δημητρίου*). One of his coins has already the square form used in India instead of the circular. Eventually he was defeated by the usurper Eucratides (*q.v.*), who meanwhile had risen to great power in Bactria. About his death we know nothing; his young son Euthydemus II. (known only from coins) can have ruled only a short time. (ED. M.)

**DEMETRIUS**, the name of two kings of Macedonia.

1. **DEMETRIUS I.** (337-283 B.C.), surnamed *Poliorcetes* ("Besieger"), son of Antigonus Cyclops and Stratonice. At

the age of twenty-two he was left by his father to defend Syria against Ptolemy the son of Lagus; he was totally defeated near Gaza (312), but soon partially repaired his loss by a victory in the neighbourhood of Myus. After an unsuccessful expedition against Babylon, and several campaigns against Ptolemy on the coasts of Cilicia and Cyprus, Demetrius sailed with a fleet of 250 ships to Athens. He freed the city from the power of Cassander and Ptolemy, expelled the garrison which had been stationed there under Demetrius of Phalerum, and besieged and took Munychia (307). After these victories he was worshipped by the Athenians as a tutelary deity under the title of *Soter* ("Preserver"). In the campaign of 306 against Ptolemy he defeated Menelaus (the brother of Ptolemy) in Cyprus, and completely destroyed the naval power of Egypt. In 305 he endeavoured to punish the Rhodians for having deserted his cause; and his ingenuity in devising new instruments of siege, in his unsuccessful attempt to reduce the capital, gained him the appellation of *Poliorcetes*. He returned a second time to Greece as liberator. But his licentiousness and extravagance made the Athenians regret the government of Cassander. He soon, however, roused the jealousy of the successors of Alexander; and Seleucus, Cassander and Lysimachus united to destroy Antigonus and his son. The hostile armies met at Ipsus in Phrygia (301). Antigonus was killed in the battle, and Demetrius, after sustaining a severe loss, retired to Ephesus. This reverse of fortune raised up many enemies against him; and the Athenians refused even to admit him into their city. But he soon afterwards ravaged the territory of Lysimachus, and effected a reconciliation with Seleucus, to whom he gave his daughter Stratonice in marriage. Athens was at this time oppressed by the tyranny of Lachares; but Demetrius, after a protracted blockade, gained possession of the city (294) and pardoned the inhabitants their former misconduct. In the same year he established himself on the throne of Macedonia by the murder of Alexander, the son of Cassander. But here he was continually threatened by Pyrrhus, who took advantage of his occasional absence to ravage the defenceless part of his kingdom (Plutarch, *Pyrrhus*, 7 ff.); and at length the combined forces of Pyrrhus, Ptolemy and Lysimachus, assisted by the disaffected among his own subjects, obliged him to leave Macedonia after he had sat on the throne for six years (294-288). He passed into Asia, and attacked some of the provinces of Lysimachus with varying success; but famine and pestilence destroyed the greater part of his army, and he solicited Seleucus for support and assistance. But before he reached Syria hostilities broke out; and after he had gained some advantages over his son-in-law, Demetrius was totally forsaken by his troops on the field of battle, and surrendered his person to Seleucus. His son Antigonus offered all his possessions, and even his person, in order to procure his father's liberty; but all proved unavailing, and Demetrius died in the fifty-fourth year of his age, after a confinement of three years (283). His remains were given to Antigonus, honoured with a splendid funeral at Corinth, and thence conveyed to Demetrias. His posterity remained in possession of the Macedonian throne till the time of Perseus, who was conquered by the Romans.

See *Life* by Plutarch; Diod. Sic. xix. xx.; Wilamowitz-Moellendorff, *Antigonos von Karystos*; De Sanctis, *Contributi alla storia Ateniese* in Beloch's *Studi di storia antica* (1893); Fergusson in Lehmann's *Beiträge z. alt. Gesch. (Klio)* vol. v. (1905); also authorities under MACEDONIAN EMPIRE.

2. **DEMETRIUS II.**, son of Antigonus Gonatas, reigned from 239 to 229 B.C. He had already during his father's lifetime distinguished himself by defeating Alexander of Epirus at Derdia and so saving Macedonia (about 260?). On his accession he had to face a coalition which the two great leagues, usually rivals, the Aetolian and Achaean, formed against the Macedonian power. He succeeded in dealing this coalition severe blows, wresting Boeotia from their alliance. The revolution in Epirus, which substituted a republican league for the monarchy, gravely weakened his position. Demetrius had also to defend Macedonia against the wild peoples of the north. A battle with the Dardanians turned out disastrously, and he died shortly afterwards,

leaving Philip, his son by Chryseis, still a child. Former wives of Demetrius were Stratonice, the daughter of the Seleucid king Antiochus I., Pthia the daughter of Alexander of Epirus, and Nicaea, the widow of his cousin Alexander. The chronology of these marriages is a matter of dispute.

See Thirlwall, *History of Greece*, vol. viii. (1847); Ad. Holm, *Griech. Gesch.* vol. iv. (1894); B. Niese, *Gesch. d. griech. u. maked. Staaten*, vol. ii. (1899); J. Beloch, *Griech. Gesch.* vol. iii. (1904). (E. R. B.)

**DEMETRIUS**, the name of three kings of Syria.

**DEMETRIUS I.** (d. 150 B.C.), surnamed *Soter*, was sent to Rome as a hostage during the reign of his father, Seleucus IV. Philopator, but after his father's death in 175 B.C. he escaped from confinement, and established himself on the Syrian throne (162 B.C.) after overthrowing and murdering King Antiochus V. Eupator. He acquired his surname of *Soter*, or *Saviour*, from the Babylonians, whom he delivered from the tyranny of the Median satrap, Timarchus, and is famous in Jewish history for his contests with the Maccabees. Hated for his vices, Demetrius fell in battle against the usurper, Alexander Balas, in 150 B.C.

**DEMETRIUS II.** (d. 125 B.C.), surnamed *Nicator*, son of Demetrius I., fled to Crete after the death of his father, but about 147 B.C. he returned to Syria, and with the help of Ptolemy VII. Philometor, king of Egypt, regained his father's throne. In 140 B.C. he marched against Mithradates, king of Parthia, but was taken prisoner by treachery, and remained in captivity for ten years, regaining his throne about 129 B.C. on the death of his brother, Antiochus VII., who had usurped it. His cruelties and vices, however, caused him to be greatly detested, and during another civil war he was defeated in a battle at Damascus, and killed near Tyre, possibly at the instigation of his wife, a daughter of Ptolemy VII., who was indignant at his subsequent marriage with a daughter of the Parthian king, Mithradates. His successor was his son, Antiochus VIII. Grypus.

**DEMETRIUS III.** (d. 88 B.C.), called *Euergetes* and *Philometor*, was the son of Antiochus VIII. Grypus. By the assistance of Ptolemy X. Lathyrus, king of Egypt, he recovered part of his Syrian dominions from Antiochus X. Eusebes, and held his court at Damascus. In attempting to dethrone his brother, Philip Epiphanes, he was defeated by the Arabs and Parthians, was taken prisoner, and kept in confinement in Parthia by King Mithradates until his death in 88 B.C.

**DEMETRIUS**, a Greek sculptor of the early part of the 4th century B.C., who is said by ancient critics to have been notable for the life-like realism of his statues. His portrait of Pelliculus, a Corinthian general, "with fat paunch and bald head, wearing a cloak which leaves him half exposed, with some of the hairs of his head flowing in the wind, and prominent veins," was admired by Lucian. He was contrasted with Cresilas (*q.v.*), an idealizing sculptor of the generation before. Since however the peculiarities mentioned by Lucian do not appear in Greek portraits before the 3rd century B.C., and since the Greek art of the 4th century consistently idealizes, there would seem to be a difficulty to explain. The date of Demetrius above given is confirmed by inscriptions found on the Athenian Acropolis. (P. G.)

**DEMETRIUS**, a Cynic philosopher, born at Sunium, who lived partly at Corinth and later in Rome during the reigns of Caligula, Nero and Vespasian. He was an intimate friend of Thrasea Paetus and Seneca, and was held in the highest estimation for his consistent disregard of creature comfort in the pursuit of virtue. His contempt for worldly prosperity is shown by his reply to Caligula who, wishing to gain his friendship, sent him a large present. He replied, "If Caligula had intended to bribe me, he should have offered me his crown." Vespasian banished him, but Demetrius laughed at the punishment and mocked the emperor's anger. He reached the logical conclusion of Cynicism in attaching no real importance to scientific data.

**DEMETRIUS DONSKOI**<sup>1</sup> (1350-1389), grand duke of Vladimir and Moscow, son of the grand duke Ivan Ivanovich by his second consort Aleksandra, was placed on the grand-ducal throne of Vladimir by the Tatar khan in 1362, and married the princess Eudoxia of Nizhnyi Novgorod in 1364. It was now that Moscow

<sup>1</sup> Of the Don.

was first fortified by a strong wall, or *kremi* (citadel), and the grand duke began "to bring all the other princes under his will." Michael, prince of Tver, appealed however for help to Olgierd, grand duke of Lithuania, who appeared before Moscow with his army and compelled Demetrius to make restitution to the prince of Tver (1369). The war between Tver and Vladimir continued intermittently for some years, and both the Tatars and the Lithuanians took an active part in it. Demetrius was generally successful in what was really a contention for the supremacy. In 1371 he won over the khan by a personal visit to the Horde, and in 1372 he defeated the Lithuanians at Lyubutsk. Demetrius then formed a league of all the Russian princes against the Tatars and in 1380 encountered them on the plain of Kulikovo, between the rivers Nepryadvaya and Don, where he completely routed them, the grand khan Mamai perishing in his flight from the field. But now Toktamish, the deputy of Tamerlane, suddenly appeared in the Horde and organized a punitive expedition against Demetrius. Moscow was taken by treachery, and the Russian lands were again subdued by the Tatars (1381). Nevertheless, while compelled to submit to the Horde, Demetrius maintained his hegemony over Tver, Novgorod and the other recalcitrant Russian principalities, and even held his own against the Lithuanian grand dukes, so that by his last testament he was able to leave not only his ancestral possessions but his grand-dukedom also to his son Basil. Demetrius was one of the greatest of the north Russian grand dukes. He was not merely a cautious and tactful statesman, but also a valiant and capable captain, in striking contrast to most of the princes of his house.

See Sergyei Solovev, *History of Russia* (Rus.), vols. i-ii. (St Petersburg, 1857), &c.; Nikolai Savelev, *Demetrius Ivanovich Donskoi* (Rus.), (Moscow, 1837). (R. N. B.)

**DEMETRIUS PHALEREUS** (c. 345-283 B.C.), Attic orator, statesman and philosopher, born at Phalerum, was a pupil of Theophrastus and an adherent of the Peripatetic school. He governed the city of Athens as representative of Cassander (*q.v.*) for ten years from 317. It is said that he so won the hearts of the people that 360 statues were erected in his honour; but opinions are divided as to the character of his rule. On the restoration of the old democracy by Demetrius Poliorcetes, he was condemned to death by the fickle Athenians and obliged to leave the city. He escaped to Egypt, where he was protected by Ptolemy Lagus, to whom he is said to have suggested the foundation of the Alexandrian library. Having incurred the displeasure of Lagus's successor Philadelphus, Demetrius was banished to Upper Egypt, where he died (according to some, voluntarily) from the bite of an asp. Demetrius composed a large number of works on poetry, history, politics, rhetoric and accounts of embassies, all of which are lost.

The treatise *Περὶ Ἐπισημίας* (on rhetorical expression), which is often ascribed to him, is probably the work of a later Alexandrian (1st century A.D.) of the same name; it has been edited by L. Radermacher (1901) and W. Rhys Roberts (1902), the last-named providing English translation, introduction, notes, glossary and complete bibliography. Fragments in C. Müller, *Frag. Hist. Graec.* ii. p. 362. See A. Holm, *History of Greece* (Eng. trans.), iv. 60.

**DEMETRIUS, PSEUDO-**(or FALSE), the name by which three Muscovite princes and pretenders, who claimed to be Demetrius, son of Ivan the Terrible, are known in history. The real Demetrius had been murdered, while still a child, in 1591, at Uglich, his widowed mother's appanage.

1. In the reign of Tsar Boris Godunov (1598-1605), the first of these pretenders, whose origin is still obscure, emigrated to Lithuania and persuaded many of the magnates there of his tsarish birth, and consequently of his right to the Muscovite throne. His real name seems to have been Yury or Gregory, and he was the grandson of Bogdan Otrepev, a Galician boyar, and a tool in the hands of Tsar Boris Godunov's enemies. He first appears in history *circa* 1600, when his learning and assurance seem to have greatly impressed the Muscovite patriarch Job. Tsar Boris, however, ordered him to be seized and examined, whereupon he fled to Prince Constantine Ostrogsky at Ostrog, and subsequently entered the service of another Lithuanian, Prince Wisniwiecki, who accepted him for what he pretended



to be and tried to enlist the sympathy of the Polish king, Sigismund III., in his favour. The king refused to support him officially, but his cause was taken up, as a speculation, by the Polish magnate Yury Mnizsek, whose daughter Marina he afterwards wedded and crowned as his tsaritsa. The Jesuits also seem to have believed in the man, who was evidently an unconscious impostor brought up from his youth to believe that he was the real Demetrius; numerous fugitives from Moscow also acknowledged him, and finally he set out, at the head of an army of Polish and Lithuanian volunteers, Cossacks and Muscovite fugitives, to drive out the Godunovs, after being received into the Church of Rome. At the beginning of 1604 he was invited to Cracow, where Sigismund presented him to the papal nuncio Rangoni. His public conversion took place on the 17th of April. In October the false Demetrius crossed the Russian frontier, and shortly afterwards routed a large Muscovite army beneath the walls of Novgorod-Syeveresk. The sudden death of Tsar Boris (April 13, 1605) removed the last barrier to the further progress of the pretender. The principal Russian army, under P. F. Basmanov, at once went over to him (May 7); on the 20th of June he made his triumphal entry into Moscow, and on the 21st of July he was crowned tsar by a new patriarch of his own choosing, the Greek Isidore. He at once proceeded to introduce a whole series of political and economical reforms. From all accounts, he must have been a man of original genius and extraordinary resource. He did his best to relieve the burdens of the peasantry; he formed the project of a grand alliance between the emperor, the pope, Venice, Poland and Muscovy against the Turk; he displayed an amazing toleration in religious matters which made people suspect that he was a crypto-Arian; and far from being, as was expected, the tool of Poland and the pope, he maintained from the first a dignified and independent attitude. But his extravagant opinion of his own authority (he lost no time in styling himself emperor), and his predilection for Western civilization, alarmed the ultra-conservative boyars (the people were always on his side), and a conspiracy was formed against him, headed by Basil Shuisky, whose life he had saved a few months previously. A favourable opportunity for the conspirators presented itself on the 8th of May 1606, when Demetrius was married to Marina Mnizsek. Taking advantage of the hostility of the Muscovites towards the Polish regiments which had escorted Marina to Moscow and there committed some excesses, the boyars urged the citizens to rise against the Poles, while they themselves attacked and slew Demetrius in the Kreml on the night of the 17th of May.

See Sergyei Solovev, *History of Russia* (Rus.), vol. viii. (St Petersburg, 1857, &c.); Nikolai Kostomarov, *Historical Monographs* (Rus.) vols. iv.-vi. (St Petersburg, 1863, &c.); Orest Levitsky, *The First False Demetrius as the Propagandist of Catholicism in Russia* (Rus.) (St Petersburg, 1886); Paul Pierling, *Rome et Demetrius* (Paris, 1878); R. N. Bain, *Poland and Russia*, cap. 10 (Cambridge, 1907).

2. The second pretender, called "the thief of Tushino," first appeared on the scene *circa* 1607 at Starodub. He is supposed to have been either a priest's son or a converted Jew, and was highly educated, relatively to the times he lived in, knowing as he did the Russian and Polish languages and being somewhat of an expert in liturgical matters. He pretended at first to be the Muscovite boyarin Nagi; but confessed, under torture, that he was Demetrius Ivanovich, whereupon he was taken at his word and joined by thousands of Cossacks, Poles and Muscovites. He

speedily captured Karachev, Bryansk and other towns; was reinforced by the Poles; and in the spring of 1608 advanced upon Moscow, routing the army of Tsar Basil Shuisky, at Bolkhov, on his way. Liberal promises of the wholesale confiscation of the estates of the boyars drew the common people to him, and he entrenched himself at the village of Tushino, twelve versts from the capital, which he converted into an armed camp, collecting therein 7000 Polish soldiers, 10,000 Cossacks and 10,000 of the rabble. In the course of the year he captured Marina Mnizsek, who acknowledged him to be her husband (subsequently quieting her conscience by privately marrying this impostor, who in no way resembled her first husband), and brought him the support of the Lithuanian magnates Mnizsek and Sapieha so that his forces soon exceeded 100,000 men. He raised to the rank of patriarch another illustrious captive, Philaret Romanov, and won over the towns of Yaroslavl, Kostroma, Vologda, Kashin and other places to his allegiance. But a series of subsequent disasters, and the arrival of King Sigismund III. at Sinolensk, induced him to fly his camp disguised as a peasant and go to Kostroma, where Marina joined him and he lived once more in regal state. He also made another but unsuccessful attack on Moscow, and, supported by the Don Cossacks, recovered a hold over all south-eastern Russia. He was killed, while half drunk, on the 11th of December 1610, by a Tatar whom he had flogged.

See Sergyei Solovev, *History of Russia* (Rus.), vol. viii. (St Petersburg, 1657, &c.).

3. The third, a still more enigmatical person than his predecessors, supposed to have been a deacon called Siderka, appeared suddenly, "from behind the river Yanza," in the Ingrian town of Ivangorod (Narva), proclaiming himself the tsarevich Demetrius Ivanovich, on the 28th of March 1611. The Cossacks, ravaging the environs of Moscow, acknowledged him as tsar on the 2nd of March 1612, and under threat of vengeance in case of non-compliance, the gentry of Pskov also kissed the cross to "the thief of Pskov," as he was usually nicknamed. On the 18th of May 1612 he fled from Pskov, was seized and delivered up to the authorities at Moscow, and there executed.

See Sergyei Solovev, *History of Russia* (Rus.), vol. viii. (St Petersburg, 1857, &c.). (R. N. B.)

**DEMIDOV**, the name of a famous Russian family, founded by Nikita Demidov (b. *c.* 1665), who was originally a blacksmith serf. He made his fortune by his skill in the manufacture of weapons, and established an iron foundry for the government. Peter the Great, with whom he was a favourite, ennobled him in 1720. His son, Akinfiy Demidov (d. *c.* 1740), increased his inherited wealth by the discovery and working of gold, silver and copper mines. The latter's nephew, Paul Grigoryevich Demidov (1738-1821), was a great traveller who was a benefactor of Russian scientific education; he founded an annual prize for Russian literature, awarded by the Academy of Sciences. Paul's nephew, Nikolay Nikitich Demidov (1774-1828), raised and commanded a regiment to oppose Napoleon's invasion, and carried on the accumulation of the family wealth from mining; he contributed liberally to the erection of four bridges in St Petersburg, and to the propagation of scientific culture in Moscow. Paul's son, Anatoli Demidov (1812-1870), was a well-known traveller and patron of art; he married Princess Mathilde, daughter of Jerome Bonaparte.